



## Pressure transducers HydroFox® DMU 07 FG

Part no. 31806

Pressure transducers HydroFox® DMU 07 for level measurement

### benefits

- flush diaphragm
- without transmission liquid
- mechanically insensitive ceramic sensor
- small temperature error
- high overpressure safety

### Application

For electronic, continuous level measurement of liquids and for pressure measurement of liquids and gases in plant construction.

### Description

Pressure transducers convert physical pressure into an electrical signal proportional to the pressure. HydroFox® DMU 07 uses a capacitance ceramic measuring cell.

### Technical Specifications

#### Measuring accuracy

Deviation from the characteristic curve according to IEC 60770 – limit point calibration (non-linearity, hysteresis, repeatability)  
< ± 0.35 % FSO

#### Measuring range

0/160 mbar

#### Overpressure safety

≤ 400 mbar  
at least 25 x FS

#### Operating temperature range

Medium: -40/+125 °C  
Ambient: -40/+85 °C  
Storage: -40/+100 °C

#### Temperature error band

≤ 0.1 % FSO/10 K In compensated range -20/+80 °C

#### dynamic characteristics

Response time: ≤ 200 ms

#### Process connection

G1½B with flush diaphragm

#### material

Housing: Stainless steel 316 L  
pressure connection: Stainless steel 316 L  
diaphragm: ceramic (Al<sub>2</sub>O<sub>3</sub> 96 %)  
Seal: FKM (Viton)

#### Supply voltage

DC 9 – 32 V

#### Output signal

2-wire, 4–20 mA

#### Load

$R_{max} = [(UB - UB_{min})/0.02 A] \Omega$

**Current input**

< 21 mA

**electrical protection**

short circuit proof and protected against reverse polarity

**Electrical connection**

Connector and junction box as per ISO 4400 (DIN 43650-A)

**Degree of protection**

IP 65 (EN 60529)

**CE conformity**

EMC Directive 2014/30/EU

RoHS Directive 2011/65/EU

Pressure Equipment Directive 2014/68/EU

**Options**

- Pressure connection made of PVDF
- other seal materials
- Field housing (stainless steel 303)
- higher accuracy
- other output signals
- Ex version
  - Ex II 1/2G Ex ia IIC T4 Ga/Gb
  - Ex II 1G Ex ia IIC or IIB T6 oder T4 Ga (metal housing)
  - Ex II 1/2D Ex ia IIIC T 110 °C Da/Db
  - Ex II 10 Ex ia IIIC T 110 °C (metal housing)

**Technical Drawings**

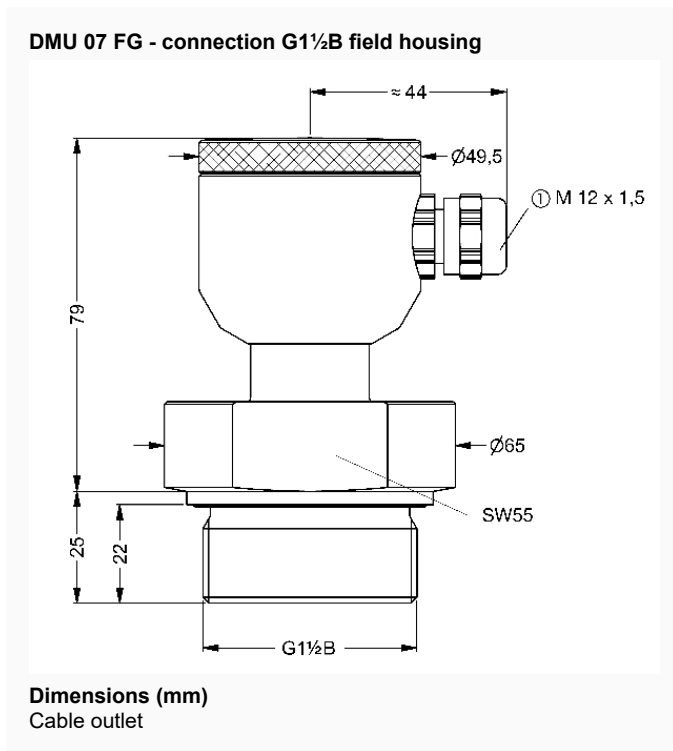

## Versions

Range	Measuring range	Type	Version	Part no.
	0/160 mbar	HydroFox® DMU 07 FG	<input type="radio"/>	31806

- in-stock items
- Non-stock items