



## Pressure transducers HydroFox® DMU 08 T

Part no. 31566T0070

Pressure transducers HydroFox® DMU 08 T Level probe

### benefits

- with integrated temperature measurement
- compact and sturdy stainless steel design
- integrated overvoltage protection
- special calibration for all standard pressure units possible

### Application

For electronic, continuous level measurement, e.g. in wells, drilling holes, water, containers or in waste water systems. Suitable for groundwater, waste water (with optional FEP cable), diesel fuel and fuel oil.

### Description

Pressure transducers HydroFox® DMU 08 convert physical pressure into an electrical signal proportional to the pressure. HydroFox® DMU 08 uses a piezo-resistive silicon measuring cell.

### Technical Specifications

#### Measuring accuracy

Deviation from the characteristic curve according to IEC 60770 – limit point calibration (non-linearity, hysteresis, repeatability)  
> 0/400 mbar <  $\pm 0.35$  % FSO

#### Measuring range

0/6 bar

#### Operating temperature range

Medium: -10/+70 °C  
Ambient: -10/+70 °C  
Storage: -25/+70 °C

#### Temperature error band

> 400 mbar  
 $\leq \pm 0.75$  % FSO In compensated range 0/70 °C

#### dynamic characteristics

Response time:  $\leq 10$  ms

#### Probe

L x  $\varnothing$ : 129 x 26.5 mm

#### material

Housing: Stainless steel 316 L  
diaphragm: Stainless steel 316 L  
seals: FKM (Viton)  
cable: PUR

**pressure transmission liquid**  
Silicone oil

**Supply voltage**  
pressure: DC 12 – 30 V  
temperature: DC 10 – 30 V

**Output signal**  
4–20 mA, 2-wire

**Load**  
 $R_{\max} = [(UB - UB_{\min})/0.02 \text{ A}] \Omega$

**Current input**  
< 25 mA

**Options**

- FEP cable
- other measuring ranges
- screw connector kit
- Junction box
- Anchor clamp
- Extended weight

**electrical protection**  
short circuit proof and protected against reverse polarity

**Electrical connection**  
PUR cable with integrated breather tube for reference to the ambient atmospheric pressure  
Cable length: 5 m  
Degree of protection: IP 68 (EN 60529)

**CE conformity**  
EMC Directive 2014/30/EU  
RoHS Directive 2011/65/EU  
Pressure Equipment Directive 2014/68/EU

**Technical Drawings**

**Junction box with pressure relief port**

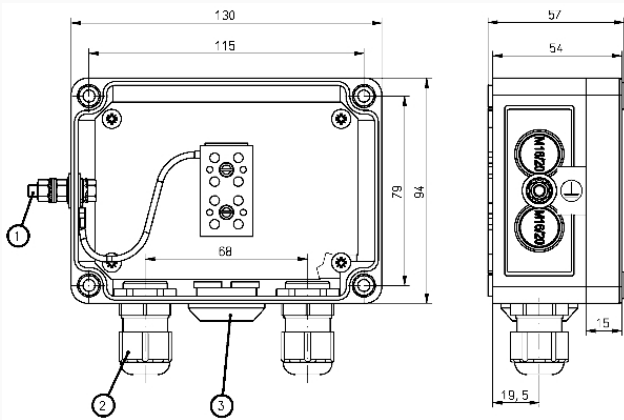

**Dimensions (mm)**

- Earth
- Cable gland PG 11
- Pressure compensation element

## Versions

	Measuring range	Overload		Part no.
HydroFox® DMU 08 T	0/6 bar	at least 6 x FS	●	31566T0070

- in-stock items
- Non-stock items