



differential pressure switch DS 01

Part no. 88106

differential pressure switch

benefits

- robust diaphragm type movement
- suitable for overpressure, vacuum and differential pressure measurements

Application

Suitable for all practically neutral media such as process water, heating water, neutral gases, oils. Suitable for two-point control by means of a continuously adjustable switching point (between 10 and 100% of pressure range).

Description

A robust diaphragm type movement serves as the basis for this unit. It is suitable for overpressure, vacuum and differential pressure measurements. The unit uses the same principle of operation for all three measuring applications. The pressure or the differential pressure applies a force to one side of the diaphragm. This force displaces the diaphragm system and moves the measurement range spring. A switching pin mounted to the diaphragm actuates an electrical switching element. The switching point is set by means of a wheel with a scale.

Technical Specifications

pressure range

0/4 bar

static pressure

max. 16 bar, device is overpressure-proof up to 16 bar and vacuum-proof

Operating temperature range

Medium: max. 80 °C

Ambient: max. 80 °C

Connection

2 x G $\frac{1}{2}$ female

Pressure chamber

Brass

diaphragm

NBR (Perbunan)

Mounting

Bracket for wall-mounting

Electrical connection

Cable gland M16 x 1.5

Switching point

10–100 % of pressure range, fully adjustable

Contact

Microswitch, Normally open contact

Switching hysteresis

approx. 2 %

Contact rating

AC 250 V, 3 A, 500 VA

Technical Drawings

DS 01

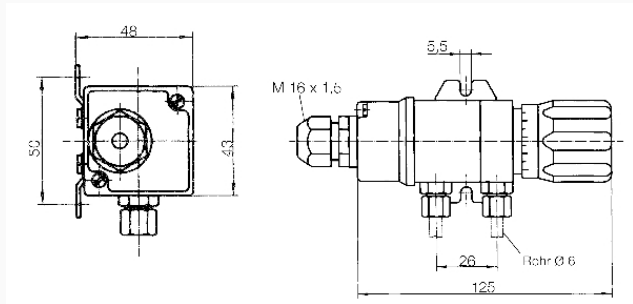

Dimensions (mm)

Versions

	pressure range		Part no.
differential pressure switch DS 01	0/4 bar	●	88106

- in-stock items
- Non-stock items