

Diaphragm seal MD 80

Part no. 31406W

Diaphragm seal MD 80 Flange version

benefits

- flush, welded diaphragm
- for DIN and ASME flange connections
- numerous special materials and coatings (option)
- with bottom instrument connection as cell design (option)

Application

For mounting to Bourdon tube pressure gauges, pressure transducers or pressure switches. For corrosive, highly viscous, polluted, crystallising or hot media. Typical application areas:

Chemical Industry

Petrochemistry

Refineries

Power plant engineering

Technical Specifications

Process connection/tubus

Stainless steel 316 L

flange connection as per ASME B 16.5 (Raised Face)

diaphragm

Stainless steel 316 L

Instrument connection

Welded connection

pressure transmission liquid

Paraffin oil (FM 09), FDA-listed

pressure range

see overview of versions

Nominal pressure

CL 300

Technical Drawings

Type MD 80 - flange connection as per ASME B 16.5 (Raised Face)

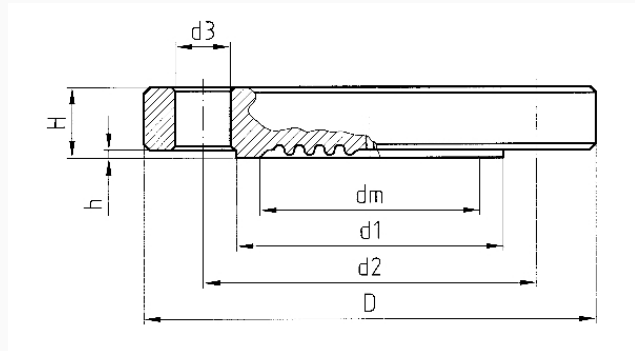

DN	CL	D	d1	d2	d3	H	h	dm
1"	150	108	50,8	79,4	4x15,9	14,3	1,6	28
	300	123,9	50,8	88,9	4x19,1	17,5	1,6	28
1½"	150	127	73,2	98,6	4x15,9	17,5	1,6	36
	300	155,6	73,2	114,3	4x22,4	22,4	1,6	36
2"	150	152,4	92,1	120,7	4x19,1	19,1	1,6	48
	300	165,1	92,1	127	8x19,1	25,4	1,6	48
3"	150	190,5	127	152,4	4x19,1	23,9	1,6	48
	300	209,6	127	168,3	8x22,4	31,8	1,6	48
4"	150	228,6	157,2	190,5	8x19,1	23,9	1,6	48
	300	254	157,2	200,1	8x22,3	31,7	1,6	48

Versions

Process connection	standard	Instrument connection	Nominal pressure	minimum range* (in bar) at nominal size					Part no.	
				63	100	160	DMU	DMU 13 Vario		
4"	flange connection as per ASME B 16.5 (Raised Face)	Welded connection	CL 300	0.6 bar	0.6 bar	0.6 bar	0.6 bar	0.6 bar	●	31406W

● in-stock items

● Non-stock items