



## Resistance thermometers WTh 30 DK

**Part no. 32313**

**Resistance thermometers**

### benefits

- hygienic design as per EHEDG recommendations
- compact design
- high accuracy
- short response time
- various process connections
- transducer can be integrated

### Application

For temperature measurement in tanks and pipelines and applications requiring hygienic process connections, materials and processing. Specially suitable for food, pharmaceutical and biotechnology applications due to the compact design and the high accuracy.

### Description

WTh 30 consists of a sturdy stainless steel housing with diverse process connections and a Pt 100 measuring insert which is directly integrated in a thermowell. The change in resistance depending on the measured temperature is directly available as a signal or can be detected by a transducer and converted into a 4–20 mA output signal. The instrument is connected by means of a compact M12 plug connection.

### Technical Specifications

#### Sensor

1 x  
4-wire  
class A, IEC 751

#### Thermowell

∅ 6 mm  
Stainless steel 316 L

#### Process connection

G½B conical metal seal  
Stainless steel 316 L

#### Installation length

100 mm

#### Electrical connection

connector M12  
Connector housing: Stainless steel

#### Housing

material: Stainless steel  
Diameter: 18 mm

#### Degree of protection

IP 67 (EN 60529)

**Surface roughness**

$R_a$ : < 0.8  $\mu\text{m}$

welding seam: < 1.6  $\mu\text{m}$

**Operating pressure**

max. 16 bar

**Options**

- integrated transducer
- other process connections
- Electropolishing
- replaceable measuring insert
- other installation lengths
- weld-in sockets

**Measuring range**

-50/+200 °C

**response time  $t_{90}$**

5.5 s as per EN 60751, test in flowing water (without transducer)

**Technical Drawings**

connection G1/2B, tapered, metallic seal

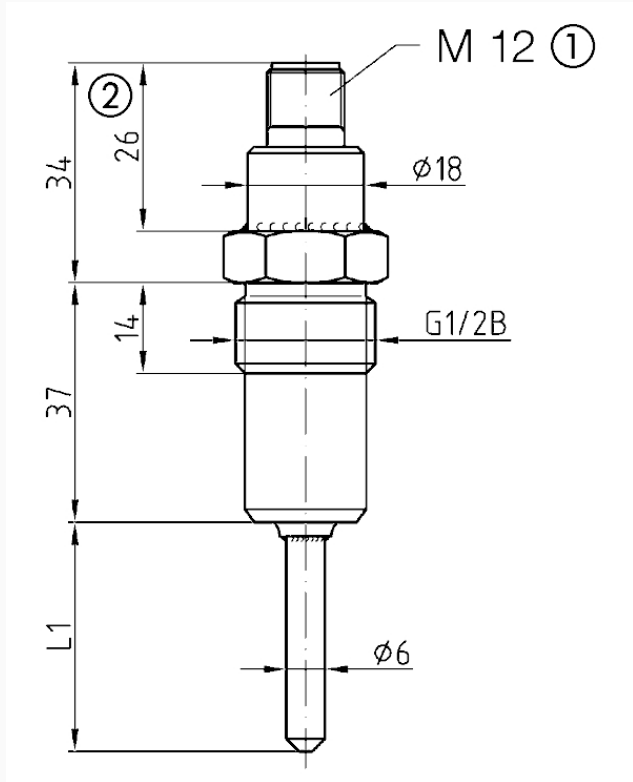

**Dimensions (mm)**

Connector 4-pin

version with integrated transducer (24 mm longer)

## Versions

		Installation length		Part no.
	Resistance thermometers WTh 30 DK	100 mm	●	32313

- in-stock items
- Non-stock items