



Bourdon tube pressure gauge RF100ISR

Part no. 85321111

Bourdon tube pressure gauge with screw bezel housing type D1

benefits

- for machine and plant engineering
- extremely robust plastic housing (PA 6.6 GB30)
- laminated safety glass window
- higher accuracy class optional

Application

For gaseous and liquid media which are not highly viscous, do not crystallise and do not attack copper alloys. For high measuring accuracy. ! For measuring gas or vapour, observe the table "Selection Criteria as per EN 837-2"

Technical Specifications

Type

D1

Nominal size

100

accuracy class (EN 837-1/6)

1.0

ranges (EN 837-1/5)

see ordering table

application area

- ≤ 600 bar: Full scale value
- > 600 bar: ¾ x full scale value
- ≤ 600 bar: 0.9 x full scale value
- > 600 bar: ⅘ x full scale value
- ≤ 600 bar: 1.3 x full scale value
- > 600 bar: Full scale value

Operating temperature range

Medium: max. 60 °C

Ambient: -20/+60 °C

Temperature performance

Indication error when the temperature of the measuring system deviates from the normal temperature of 20 °C:

at rising temperature approx. ± 0.4 %/10 K

falling temperature approx. ± 0.4 %/10 K

of full scale value

Degree of protection

IP 65 (EN 60529)

Connection

Brass, bottom back

Measuring element

Bourdon tube

≤ 600 bar: "C" type tube, Copper alloy

> 600 bar: helical tube, stainless steel 316 Ti/316 L

movement

Brass

Dial

Aluminium, white
Scaling: black

Pointer

Aluminium, black

Housing

plastic (PA 6.6 GB30), with blow-out

Screw type bezel

plastic (PA 6.6 GB30)

window

Laminated safety glass

Options

- Glycerine filling (type D 6)
- higher accuracy class
- throttle screw
- special scales
- other process connections
- micro-adjustable pointer

Technical Drawings

bottom back connection

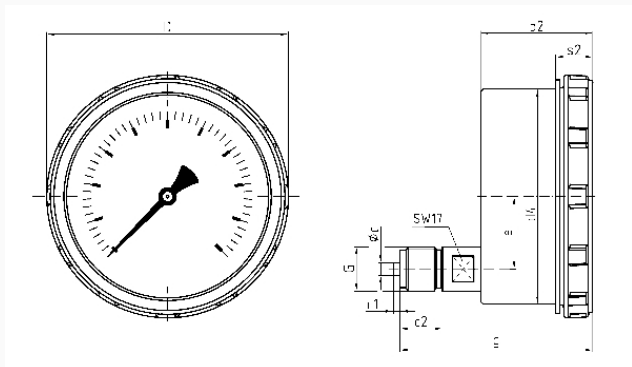

Dimensions (mm)

NG	b2	∅c	c1	c2	d4	D	e	G	g	s2
100	52,5	6	3	20	101	114	34	G½B	91	17,5

Versions

Range	Mounting type	Type	Part number
0/160 bar	direct	RF100ISR D111	85321111

- in-stock items
- Non-stock items