



## Bourdon tube pressure gauge RF100ISR

Part no. 85324141

Bourdon tube pressure gauge with screw bezel housing type D1

### benefits

- for machine and plant engineering
- extremely robust plastic housing (PA 6.6 GB30)
- laminated safety glass window
- higher accuracy class optional

### Application

For gaseous and liquid media which are not highly viscous, do not crystallise and do not attack copper alloys. For high measuring accuracy. ! For measuring gas or vapour, observe the table "Selection Criteria as per EN 837-2"

### Technical Specifications

#### Type

D1

#### Nominal size

100

#### accuracy class (EN 837-1/6)

1.0

#### ranges (EN 837-1/5)

see ordering table

#### application area

- ≤ 600 bar: Full scale value
- > 600 bar: ¾ x full scale value
- ≤ 600 bar: 0.9 x full scale value
- > 600 bar: ⅘ x full scale value
- ≤ 600 bar: 1.3 x full scale value
- > 600 bar: Full scale value

#### Operating temperature range

Medium: max. 60 °C

Ambient: -20/+60 °C

#### Temperature performance

Indication error when the temperature of the measuring system deviates from the normal temperature of 20 °C:

at rising temperature approx. ± 0.4 %/10 K

falling temperature approx. ± 0.4 %/10 K

of full scale value

#### Degree of protection

IP 65 (EN 60529)

#### Connection

Brass, bottom back

#### Measuring element

Bourdon tube

≤ 600 bar: "C" type tube, Copper alloy

> 600 bar: helical tube, stainless steel 316 Ti/316 L

**movement**

Brass

**Dial**

Aluminium, white  
Scaling: black

**Pointer**

Aluminium, black

**Housing**

plastic (PA 6.6 GB30), with blow-out

**Screw type bezel**

plastic (PA 6.6 GB30)

**window**

Laminated safety glass

**Options**

- Glycerine filling (type D 6)
- higher accuracy class
- throttle screw
- special scales
- other process connections
- micro-adjustable pointer

**Technical Drawings**

bottom back connection, with clamp fixing

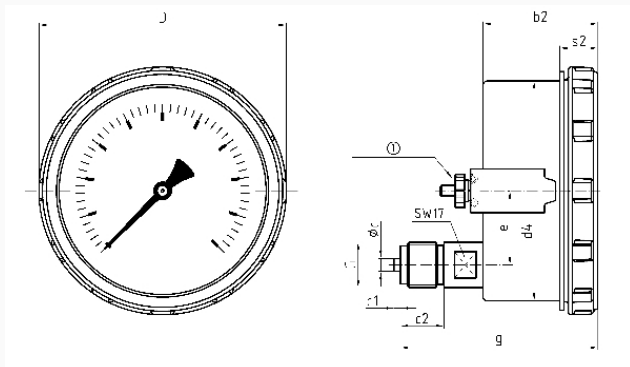

Union nut

**Dimensions (mm)**

NG	b2	Øc	c1	c2	d4	D	e	G	g	s2
100	52,5	6	3	20	101	114	34	G½B	91	17,5

**Versions**

Range	Mounting type	Type	Part number
0/600 bar	clamp fixing	RF100ISR D141	85324141

- in-stock items
- Non-stock items