

Plastic heating circuit manifold ProCalida® MC 1 3-HK FM

Part no. 77223

Plastic heating circuit manifold

benefits

- Dual-chamber system for optimum heat loss limitation
- Large cross section for optimum supply of the control circuits
- Flow meter can be cleaned with system pressure present
- Pre-assembled, tightness-tested and ready to be connected



Application

Manifold system for surface heating systems and cooling systems. For distribution of heating and cooling circuit water as per VDI 2035 or of water/glycol mixtures in sealed systems. Suitable for 2–12 heating/cooling circuits.

Description

Robust, very short heating or cooling circuit manifold made of high-grade polymer materials, with up to 12 heating circuits. Return with stroke valves for actuators. Return valves with dual O ring seal at the valve axis for particularly long running times with optimum sealing. Valve disc with O ring seal for permanently reliable closing of the control circuits.

Flow with flow meters that can be shut off. Control range flow meter 0.5 to 4 l/min with locking as per EN 1264-4. The valves can be shut off and regulated for hydraulic balancing of wall or underfloor heating systems. When the system is shut off, the pre-adjustment is not lost for compliance with EN 1264-4.

Windows can be cleaned and replaced with system pressure present. Main connection with union nut G1. With filling and drain valve, manual vent and thermometer. Quick air vent can be fitted using a lifting tool. Connection by means of angular connection pieces and/or ball valve G1 adapted to the manifold. With dovetail guide at both ends for fast snap-in mounting and horizontal movement of the wall bracket.

The wall bracket is made of robust polymer material and therefore has excellent sound-absorbing properties.

Suitable for standard manifold cabinets. With adjustable distance between the flow and return bars, for easy, collision-free mounting even in the case of large actuator and heating circuit pipes up to 20 mm. The AFRISO manifold systems are 100 % tightness-tested and function-tested.

Technical Specifications

Number of heating/cooling circuits

3

Medium

Heating circuit water and cooling circuit water as per VDI 2035
(Water/glycol mixtures with an admixture of max. 50 %)

Test pressure

max. 6 bar

Main connection

G1 flat-sealing, with union nut
Connection from the right or from the left

Connection heating/cooling circuit

G $\frac{3}{4}$ male thread, eurocone
suitable for standard compression fittings

Operating temperature range

Medium: -20/+90 °C at 3 bar,
-20/+60 °C at 6 bar

Flow coefficient Kvs

Flow valve: 1.56 m³/h
Return valve: 1.3 m³/h
combined: 1 m³/h

Options

- wall bracket with fixed distance
- with dynamic control valves Vario-DP in the return

Flow meter

can be shut off and regulated, with pre-adjustable adjustment ring
Range: 0.5/4 l/min
Mounting position: any
Accuracy: ± 10 %, with reference to the full scale value

wall bracket

, suitable for standard manifold cabinets, Bar distance selectable

Options

- wall bracket with fixed distance
- with dynamic control valves Vario-DP in the return

Technical Drawings

Version with flow meter (FM)

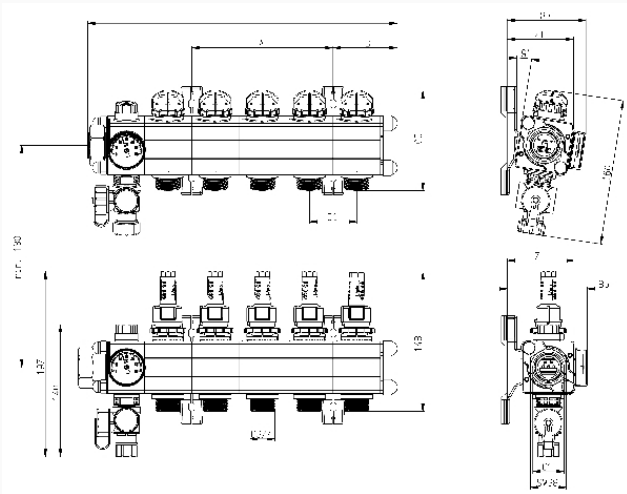

Dimensions (mm)

Dimensions (mm)

Heating circuit	2 HK	3 HK	4 HK	5 HK	6 HK	7 HK	8 HK	9 HK	10 HK	11 HK	12 HK
A (mm)	50	50	100	150	200	200	250	300	300	350	350
B (mm)	43	68	68	68	68	118	118	118	118	118	168
L (mm)	185	235	285	335	385	435	485	535	585	635	685

Versions

Type		number of heating circuits		Part no.
version with flow meter	Plastic heating circuit manifold ProCalida® MC 1 3-HK FM	3	●	77223

- in-stock items
- Non-stock items