

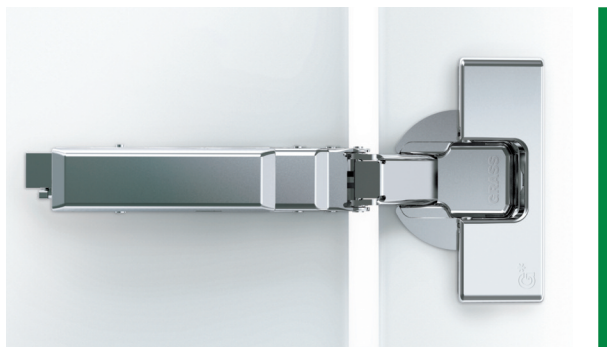

G*GRASS®

TIOMOS HINGE SYSTEM

Integrated Soft-close, stylish design, maximum stability.
The best possible hinge solution for cabinet doors.







Tiomos, an elegant hinge system today that meets the technical and functional requirements of tomorrow.



Our developers set out to create a product innovation – a completely new hinge system. The result is Tiomos. Not only does Tiomos outperform any other hinge in the industry, it offers a timeless design as well as its own individual character.

Tiomos is a completely new hinge concept. The product range covers virtually every application, from standard doors to wide angle doors, from frameless applications to face frame applications. The Tiomos offers two closing actions: the standard Self-close and the popular Soft-close. The Soft-close offers a three tier adjustable mechanism, which is fully

integrated and concealed in the hinge arm. The closing process is extremely smooth from the degree that the Soft-close is activated until the door is completely shut. With the superb engineering and design, size and weight of the door will not be a factor. The cabinet doors pull open with ease and minimal gaps can be achieved with the new design of the hinge.

Tiomos - the ideal solution to the ever increasing requirements of today's manufacturers.

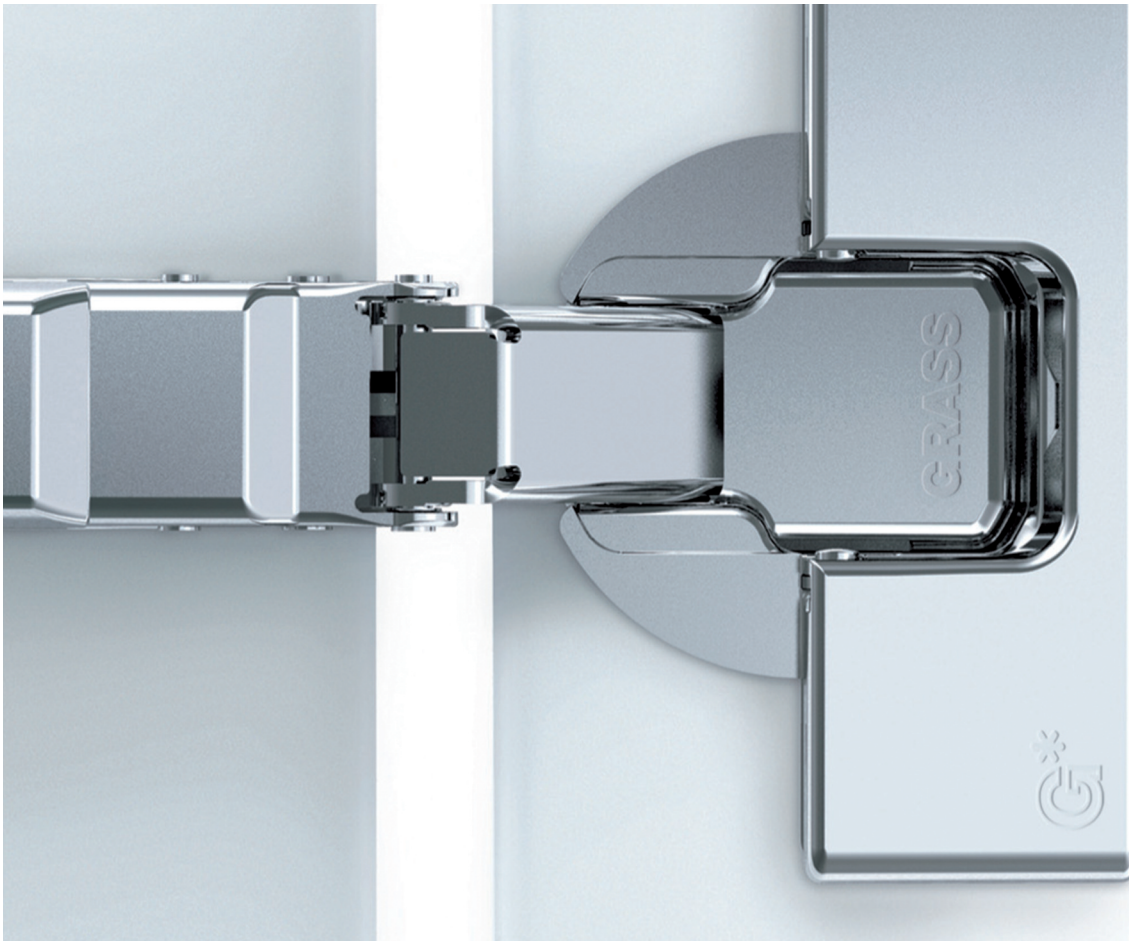

Tiomos - One hinge system to cover all applications.

Tiomos is not a revamp of an existing hinge system but an evolutionary new development.

Tiomos provides perfect movement for essentially every application, from standard doors to wide angle doors, from diagonal corner hinges to pie-cut corner hinges, and from frameless applications to face frame applications. Tiomos is available in a 45mm or 42mm boring pattern for dowelled hinges and 45mm for screw-on hinges. The Tiomos Impresso, the ever popular tool free version, is available in a combined 42/45mm pattern.



TIOMOS HINGE SYSTEM

One hinge system featuring a multitude of innovative aspects.

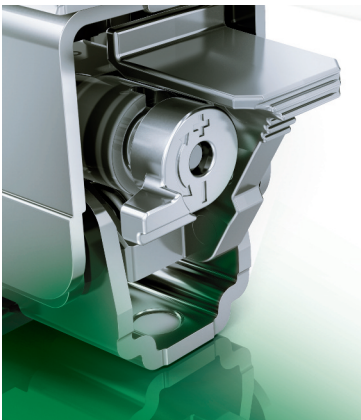

Soft-close technology is concealed within the hinge arm.

Three levels of closing pressure are available with the Tiomos adjustable Soft-close mechanism, which is fully integrated and concealed in the hinge arm. The hinges arrive with the adjustment lever in the horizontal position. A turn to the left or the right will adjust the Soft-close mechanism to your individual requirements.



Perfect alignment with a twist of the hand.

For fine adjustment, the Tiomos hinge system offers three dimensional adjustment. Depth adjustment (+3/-2mm) is based on the worm gear principle and is continuous and self-locking. Depending on the type of base plate chosen, height adjustment (± 2 mm) can be achieved via a worm gear or through elongated holes (± 2.5 mm). Side adjustment (± 2 mm) is on the hinge arm.



The new kinematics inside Tiomos.

The complex inner workings of this high-tech hinge are hidden from view, but they are most impressive when working as one. With the new kinematics in place the doors are extremely easy to open. This mechanism makes alignment with the smallest of gaps and reveals possible opening up new possibilities to cabinet designers.















For stronger damping action, turn the adjustment lever by 90° to the right.













Tiomos hinges leave the factory with the adjustment lever in the horizontal position.

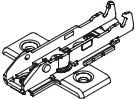

For a gentler closing action, the adjustment lever of the Soft-close damper is turned to the left by 90°.

Opening angle		Description	Full overlay	Overlay	Half overlay	Inset	Page
		Technical Information					8-15
110°		Tiomos 110 • Optimal reveals up to 24 mm door thickness • Convenient depth adjustment via worm gear					16
120°		Tiomos 120 • Optimal reveals up to 24 mm door thickness • Convenient depth adjustment via worm gear					18
160°		Tiomos 160 • Optimal reveals up to 32 mm door thickness • Zero protrusion • For cabinets with inset drawers or pull-out shelves					20
95°		Tiomos 95 • Optimal reveals up to 36 mm door thickness • Convenient depth adjustment via worm gear					22
110°		Tiomos 110/90A • Hinge for blind corner cabinets, overlay • Convenient depth adjustment via worm gear					24
110°		Tiomos 110/90E • Hinge for blind corner cabinets, inset • Convenient depth adjustment via worm gear					26
110°		Tiomos 110/30A • For 30° angled cabinets, overlay • Convenient depth adjustment via worm gear					28
110°		Tiomos 110/30E • For 30° angled cabinets, inset • Convenient depth adjustment via worm gear					30
110°		Tiomos 110/37A • For 37° angled cabinets, overlay • Convenient depth adjustment via worm gear					32
110°		Tiomos 110/37E • For 37° angled cabinets, inset • Convenient depth adjustment via worm gear					34
110°		Tiomos 110/45A • For 45° angled cabinets, overlay • Convenient depth adjustment via worm gear					36
110°		Tiomos 110/45E • For 45° angled cabinets, inset • Convenient depth adjustment via worm gear			Corner Angle 		38

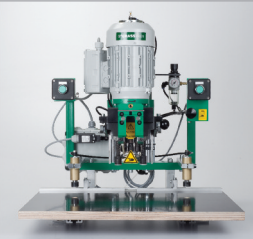
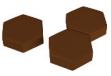
Opening angle		Description	Full overlay	Overlay	Half overlay	Inset	Page
120°		Tiomos 120/-15A • For -15° angled cabinets, overlay • Convenient depth adjustment via worm gear					40
120°		Tiomos 120/-30A • For -30° angled cabinets, overlay • Convenient depth adjustment via worm gear					42
120°		Tiomos 120/-45A • For -45° angled cabinets, overlay • Convenient depth adjustment via worm gear					44
110°		Tiomos PCC • For pie cut corner application • Convenient depth adjustment via worm gear					46
		Tiomos base plates • Wing base plates • Straight base plates • Face frame base plates					48
		Tipmatic • For use with free swing hinges • For handle-free wooden doors					52
		Accessories • Cover caps • Angle reduction clips • Clip protection					54
		Machinery					56
		Assembly Hardware • Shelf supports • Bumper pads					58

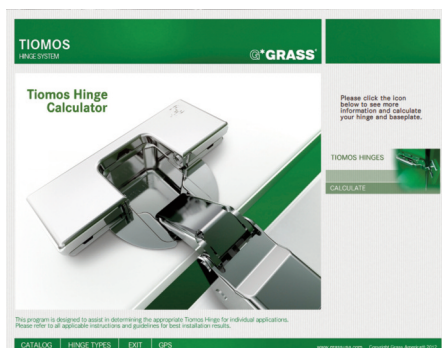

Introducing the Tiomos Hinge Calculator!

The Tiomos GPS takes the guess work out of choosing hinges

- Provides Item numbers
- Adjustment instructions
- Immediate access to Tiomos catalog

See Page 59 for more info

Technical Information

For Tiomos

Features



- Adjustable soft-close mechanism integrated and concealed in the hinge arm
- Continuous, smooth closing action from the degree that the Soft-close is activated until the door is completely closed
- Uniform closing action regardless of the door size, weight, or materials
- Soft-close mechanism can be adjusted easily and without tools, even after doors are installed
- Each Tiomos hinge has 3 settings for closing performance
- Wide selection of hinges and specialty hinges cover all application needs
- Increased applications:
 - * Full overlay from 24 - 13.5mm
 - * Overlay from 19 - 11.5mm
 - * Half Overlay from 12.5 - 5mm
 - * Inset

• Depth adjustment (+3/-2mm)

is smooth and self-locking via worm screw principle

• Integrated damper adjustment

with 3 Soft-close settings.
Adjustment system is concealed in the hinge arm.

• Ergonomic clip

release with audible locking

• Easy height adjustment ($\pm 2\text{mm}$)

via hinge arm on baseplate

• Side adjustment ($\pm 2\text{mm}$)

with overturn stop



3 Soft-close settings

adjust to meet your individual Soft-close requirements.

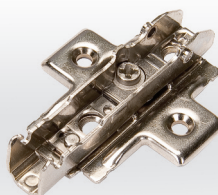

Height adjustment

is based on the worm gear principle that is continuous and self-locking.

Features & Benefits

- One hinge type for all door thicknesses 14 - 24mm
- 3-dimensional adjustment with suitable base plate
 - * Depth adjustment +3/-2mm via self-locking worm screw
 - * Height adjustment +/-2mm on base plate via hinge arm
 - * Side adjustment with overturn stop +/-2 via hinge arm
- Soft-close or Self-close hinges are available
- For face frame or frameless cabinets
- Impresso for tool free application
- 42mm and 45mm boring patterns

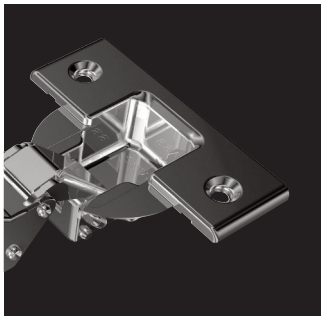

Dowelled and Screw-on cup attachments. Dowelled available in both 42mm and 45mm patterns. Screw-on available in 45mm pattern.

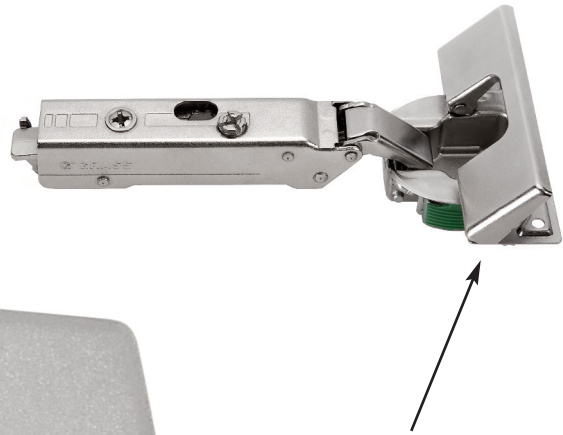

• **Impresso Hinges**
for tool free application

• **New Kinematic**
reduces opening force and minimizes reveals



• **Cup depth**
12.6mm (1/2")

• **Tiomos Styles**
42mm pattern, Dowelled
45mm pattern, Screw-on and Dowelled
Impresso 42/45mm pattern

Technical Information

For Tiomos

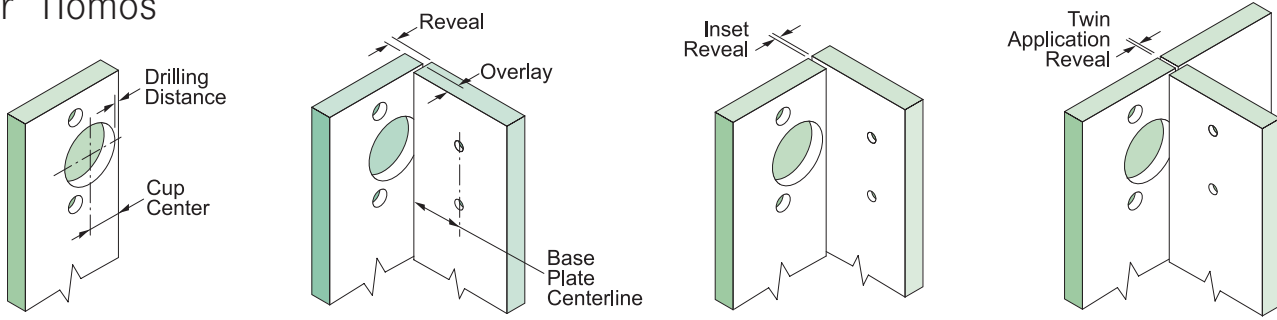

Number of hinges per door

The number of hinges is determined by the door height, door weight, quality of the material and the fixing of the cup and base plate.

The load and height data refer to 24" standard door widths.

The table refers to hinges with and without integrated dampers. Grass strongly recommends a trial mount for all hinges and base plates.

Attach base plates using all available screw holes.

Example:

For doors measuring 56" x 24" and weighing 19 lbs., Grass recommends the installation of 3 hinges.

Note: The distance between the top and bottom hinge must be greater than the width of the door.

The **Tiomos** hinge meets and exceeds the minimum requirements of ANSI/BHMA A156.9 Standard.

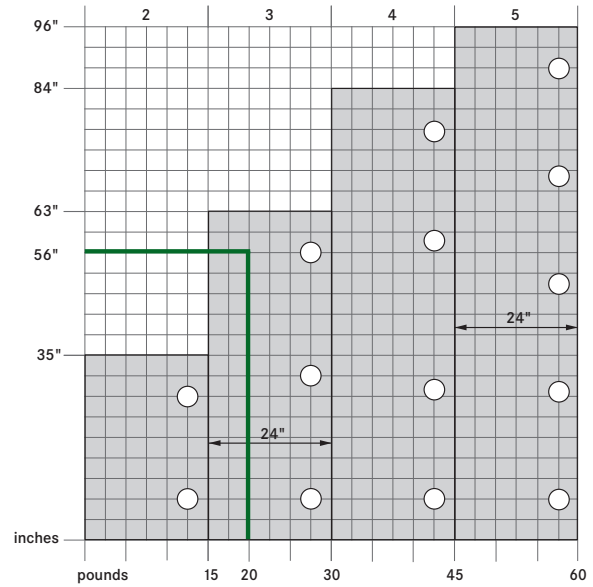

Tool-less Soft-close adjustment

Soft-closing performance can be regulated for any door size and weight with the Tiomos adjustable integrated Soft-close. Depending upon the requirement, the Soft-closing settings can be adjusted easily and without tools. With 2 hinges there are 6 Soft-close settings.

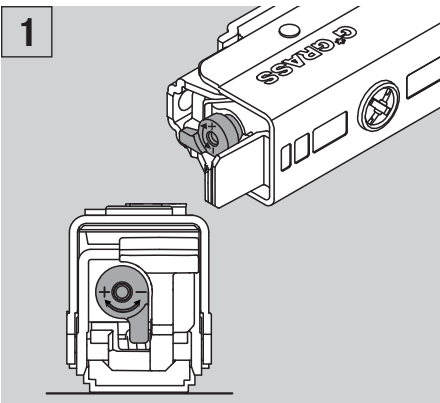

Light setting

Adjustment lever points toward the cabinet wall

Appropriate for:

- Small, light doors

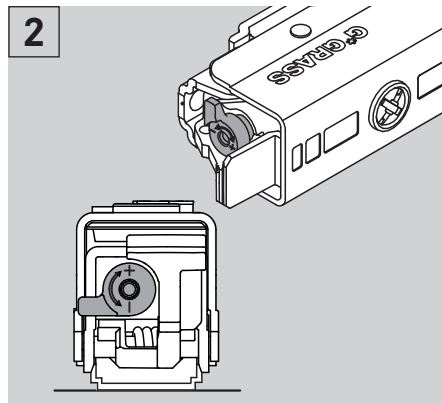

Medium setting (factory setting)

Adjustment lever is parallel to the cabinet wall. This setting covers 80% of door applications.

Appropriate for:

- Standard doors

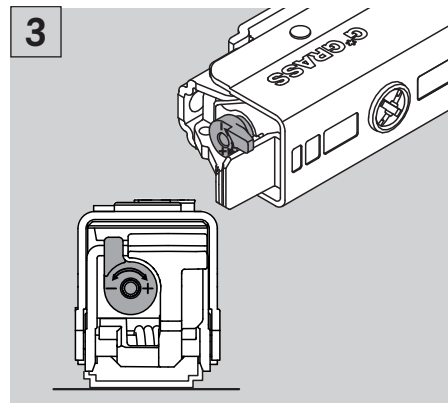

Strong setting

Adjustment lever points toward the cabinet interior

Appropriate for:

- Large, heavy doors

Adjustments

The options for height adjustment depend on the type of base plate. All adjustments can be made independent of one another.

For depth adjustment, select base plates have worm gear adjustment access through the hinge arm.

Use a #2 POZI drive screw driver for hinge adjustment.

Attach base plates using all available screw holes.

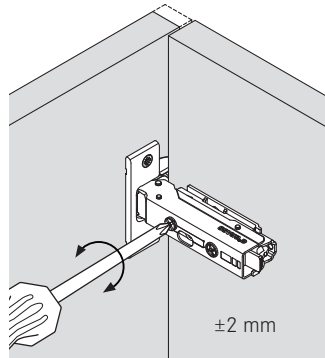

Side adjustment ±2 mm

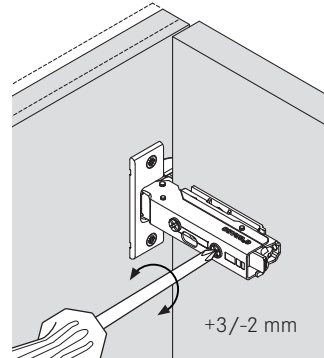

Depth adjustment via worm gear +3/-2 mm

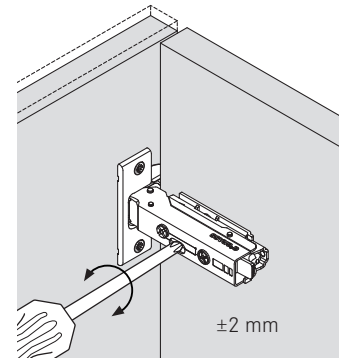

Height adjustment via base plate ±2.0mm via elongated hole ±2.5mm

Reveal

Full Overlay/Overlay Door

Half Overlay Door

Inset Door

The reveal (R) is the distance required between two doors or between the door and side wall of the cabinet to allow sufficient space for opening the door. The required reveal width (R) depends on the thickness of the door. Most cabinet makers prefer a reveal (R) of between 3mm and 6mm.

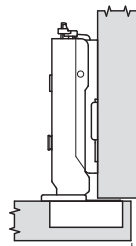

Reveal (R)

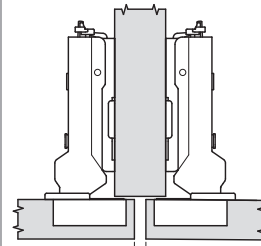

Reveal 2 x (R)

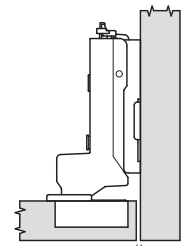

Reveal (R)

Reveal for full overlay, overlay, and half overlay doors

The table shows the reveal necessary between two doors or between door and side wall to allow enough space for opening the door.

Example:

For a door thickness of 19mm and a drilling distance (DD) of 6mm a (R) reveal of 0.9 is needed.

Door Thickness	Drilling Distance (DD)					Reveal (min.) (R)
	3	4	5	6	7	
24.0	2.4	2.1	2.1	2.1	2.0	
22.0	1.6	1.6	1.6	1.5	1.5	
21.0	1.4	1.3	1.3	1.3	1.3	
20.0	1.1	1.1	1.1	1.5	1.1	
19.0	0.9	0.9	0.9	0.9	0.9	
18.0	0.7	0.7	0.7	0.7	0.7	
17.0	0.6	0.6	0.6	0.6	0.6	
16.0	0.6	0.6	0.6	0.6	0.6	

Note:

Reveal dimensions were determined with a door edge radius of 1mm. Hinge dimensions and calculation of reveal with factory setting.

Reveal for inset door:

The table shows the minimum reveal for an inset door, depending on the drilling distance (DD) and the base plate height (BPH).

Example:

A drilling distance (DD) of 6mm results from using a base plate with height 03 and a reveal (R) of 1.0mm.

Minimum Reveal (R)	Drilling Distance (DD)					Base Plate Height (BPH)
	3	4	5	6	7	
0.0						
0.5					3.5	
1.0	0		2	3		
1.5				3.5		
2.0		2	3			
3.0	2	3				
4.0	3					

IMPORTANT To determine the correct application Grass strongly recommends a trial mounting for all hinges and base plates.

Technical Information

For Tiomos

Minimum gap – Drilling distance

The **Minimum gap** is the gap between the closed door and the front of the cabinet.

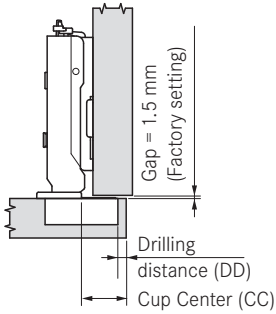

Drilling Distance DD	Cup Center CC
$\frac{1}{8}$ " 3	$\frac{13}{16}$ " 20.5
$\frac{5}{32}$ " 4	$\frac{27}{32}$ " 21.5
$\frac{3}{16}$ " 5	$\frac{7}{8}$ " 22.5
$\frac{1}{4}$ " 6	$\frac{15}{16}$ " 23.5
$\frac{9}{32}$ " 7	$\frac{31}{32}$ " 24.5
$\frac{5}{16}$ " 8	1" 25.5

Example:

For a door thickness (DT) of 17mm and a drilling distance (DD) of 6mm a minimum gap of 1.0mm is needed.

Door Thickness (DT)	Drilling Distance (DD)						
	3	4	5	6	7		
24.0	1.0	1.0	1.0	1.2	2.1		
22.0	1.0	1.0	1.0	1.0	1.5		
21.0	1.0	1.0	1.0	1.0	1.2		
20.0	1.0	1.0	1.0	1.0	1.0		
19.0	1.0	1.0	1.0	1.0	1.0		
18.0	1.0	1.0	1.0	1.0	1.0		
17.0	1.0	1.0	1.0	1.0	1.0		
16.0	1.0	1.0	1.0	1.0	1.0		
							Minimum gap

The **drilling distance (DD)** is the distance between the edge of the door and the cup hole.

The **cup center** is the drilling distance plus $\frac{1}{2}$ of the cup diameter.

Door overlay

The **door overlay** is the part of the cabinet side wall or face frame that is covered by the door on the hinge side.

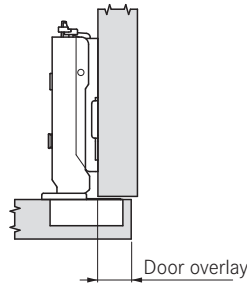

Example:

For a hinge with a cranking of 03, a base plate height (BPH) of 2mm, and a drilling distance (DD) of 4mm, the door overlay is 14mm.

Door overlay	Drilling Distance (DD)						
	3	4	5	6	7		
19.0					0		
18.0				0			
17.0			0		2		
16.5							
16.0		0		2	3		
15.5					3.5		
15.0	0		2	3			
14.5				3.5			
14.0		2	3				
13.5			3.5				
13.0	2	3					
12.5		3.5					
12.0	3						
11.5	3.5						

Door edge protrusion

The **door edge protrusion** is the amount by which the edge of the open door protrudes into the opening and varies depending on the type of hinge and method of fixing. It is stated on the respective catalog page and refers to the stated base plate for the factory setting. It can be changed by changing the height of the base plate and operation the lateral adjustment.

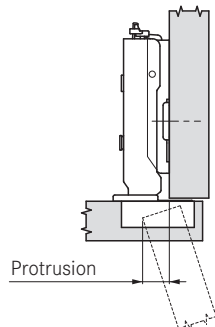

Door positions

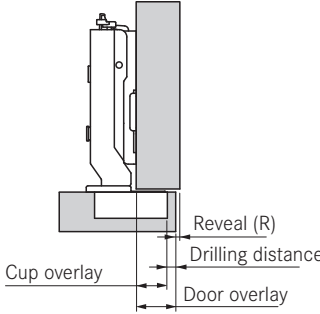
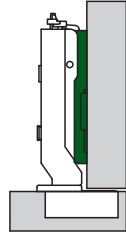
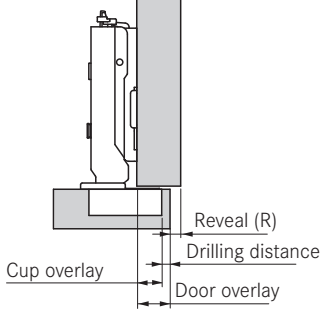
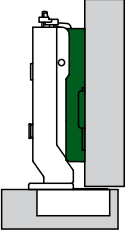
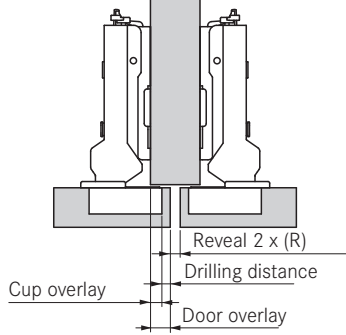
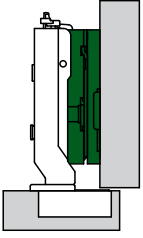
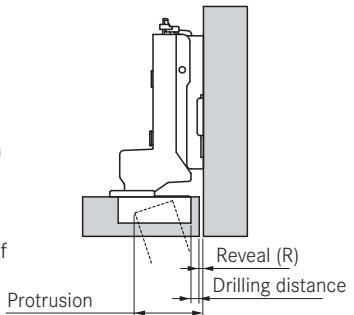
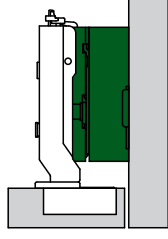
<p>Achieve overlay with hinge cranking</p>	<p>Or Achieve overlay with base plate</p>
<p>Full Overlay (Cranking 00)</p> <p>The cup overlay (factory setting) plus drilling distance determine the door overlay. Dimensions can be found in a table on the respective page of the catalog.</p> 	<p>Full Overlay</p> <p>Using a hinge with a cranking of 00 and a base plate height (BPH) 00</p> 
<p>Overlay (Cranking 03)</p> <p>The cup overlay (factory setting) plus drilling distance determine the door overlay. Dimensions can be found in a table on the respective page of the catalog.</p> 	<p>Overlay</p> <p>Using a hinge with a cranking of 00 and a base plate height (BPH) 03</p> 
<p>Half Overlay (Cranking 9.5)</p> <p>The cup overlay (factory setting) plus drilling distance determine the door overlay. Dimensions can be found in a table on the respective page of the catalog.</p> 	<p>Half Overlay</p> <p>Using a hinge with a cranking of 00 and a base plate height (BPH) 9.5</p> 
<p>Inset (Cranking 19)</p> <p>There is no door overlay. The reveal between the side of the cabinet and the door depends on the base plate height (BPH) and the drilling distance (DD). Dimensions can be found in a table on the respective page of the catalog.</p> 	<p>Inset</p> <p>Using a hinge with a cranking of 03 and a base plate height 19 (BPH).</p> 

Tiomos Impresso

Insertion Guide

Flap lock position

The Tiomos Impresso is a high quality performance hinge with superior strength. For the best results for cup insertion into door please follow the Guide shown below.

Flap lock is partially closed.

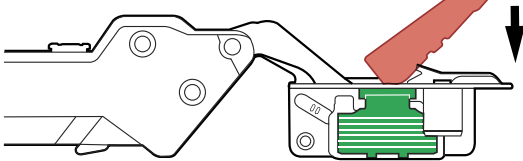

Flap lock is ready for insertion.

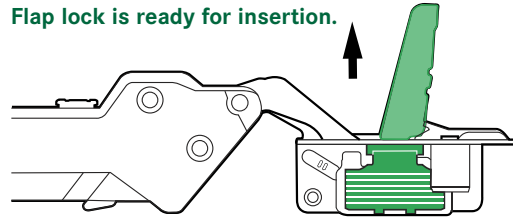

If the hinge cup flap is partially closed due to shipping and handling, lift flap to upright position before inserting into door as illustrated above.

Expanding bracket position

Flap lock is partially closed.

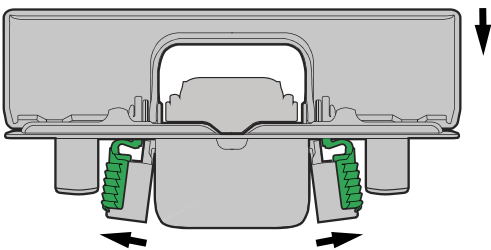

Flap lock is ready for insertion.

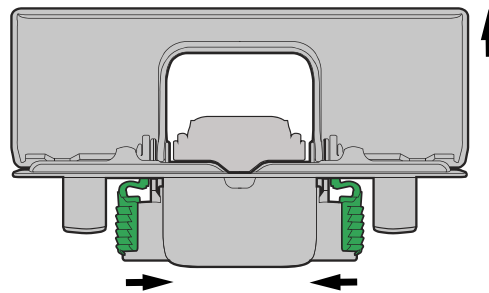

Expanding brackets are positioned incorrectly.

Expanding brackets are positioned correctly.

Please ensure that expanding green brackets are in **loose/neutral position** before inserting into door. Please reference illustration above.

Hinge cup insertion

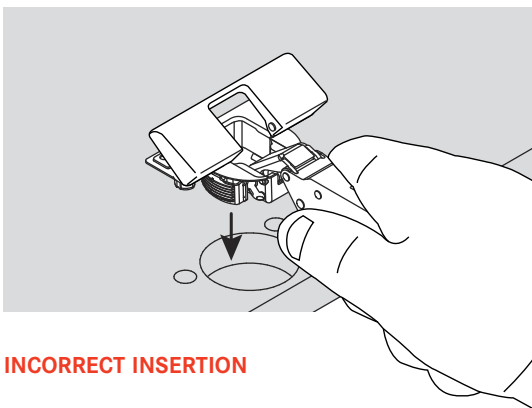

INCORRECT INSERTION

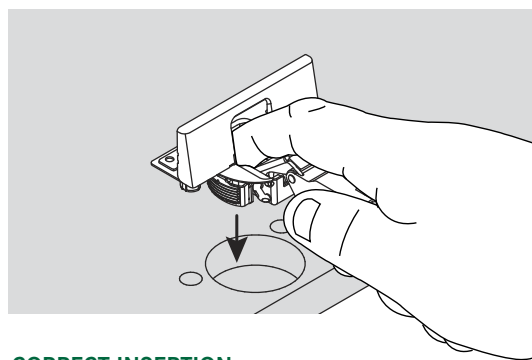

CORRECT INSERTION

For fast and easy insertion use index finger to push cup into door as illustrated above right.

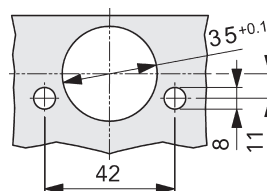

IMPORTANT: Cup bore hole diameter must be within 35mm - 35.1mm range

Testing Information

For Tiomos

TEST CRITERIA FOR HINGES

Functional test

Static load - vertical

Additional load: 44 pounds (20 kg)
Opening angle: max. -10°

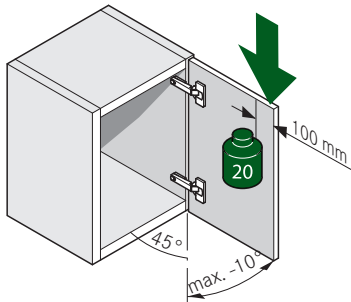

Static load - horizontal

Force: 40 N

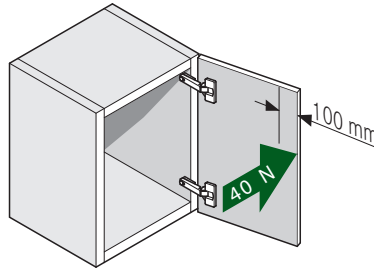

Endurance test

Opening angle: max. -5°
Open and close movements: 100,000

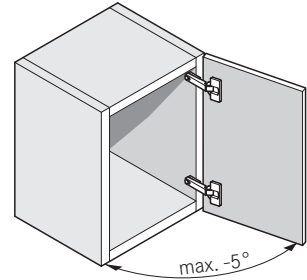

Overload testing

Vertical

Additional load: 66 pounds (30 kg)
Opening angle: max. -10°

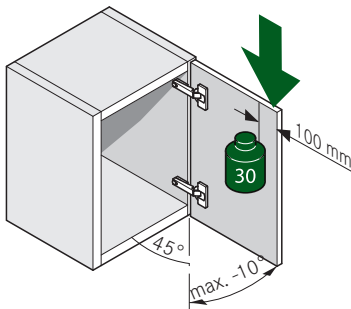

Horizontal

Force: 80 N

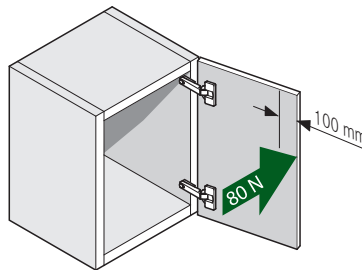

Test door

Weight approx. 11.5 pounds (5.2 kg)

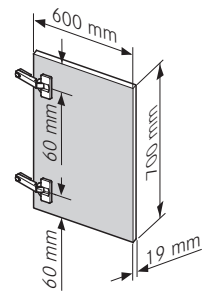

Salt spray and humidity test

Based on DIN ISO 9227 and DIN 6270-2

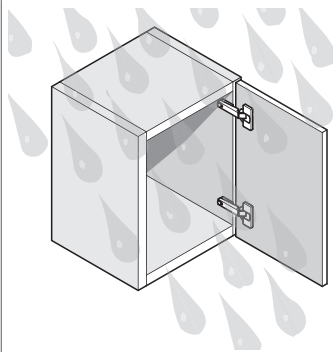

Tiomos 110

110° hinge for standard doors

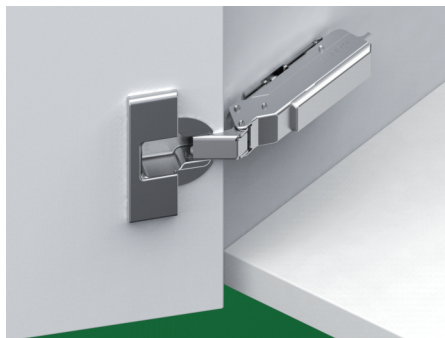

- 3-dimensional adjustment with suitable base plate
- Accommodates overlays up to 24mm (15/16")
- Optimal reveal up to 24 mm door thickness
- Soft-close or Self-close hinges available
- For face frame or frameless cabinets
- Convenient depth adjustment with worm gear

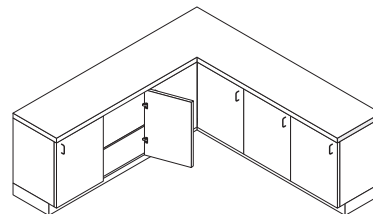

Tiomos 110 Opening Angle 110° **Impresso** **Screw-on** **Dowelled**

Full overlay	Cranking 00	Pattern	Type	Item No.	Pattern	Type	Item No.	Item No.	PU
	Hinge cup: steel, nickel-plated Hinge arm: steel, nickel-plated	42 / 45	Soft-close	F017139414228	45	Soft-close	F028138519228	F028138523228	150
			Self-close	F034139385228		Self-close	F045138457228	F045138461228	150
		42	Soft-close	-	Soft-close	-	F028138341228	150	
			Self-close	-	Self-close	-	F045138279228	150	
Overlay	Cranking 03	Pattern	Type	Item No.	Pattern	Type	Item No.	Item No.	PU
	Hinge cup: steel, nickel-plated Hinge arm: steel, nickel-plated	42 / 45	Soft-close	F017139415228	45	Soft-close	F028138520228	F028138524228	150
			Self-close	F034139386228		Self-close	F045138458228	F045138462228	150
			Free-swing	F035139443228	42	Soft-close	-	F028138342228	150
		Self-close	-	Self-close	-	F045138280228	150		
Half overlay	Cranking 9.5	Pattern	Type	Item No.	Pattern	Type	Item No.	Item No.	PU
	Hinge cup: steel, nickel-plated Hinge arm: zinc, nickel-plated	42 / 45	Soft-close	F017139416228	45	Soft-close	F028138521228	F028138525228	150
			Self-close	F034139387228		Self-close	F045138459228	F045138463228	150
			Free-swing	F035139444228	42	Soft-close	-	F028138343228	150
		Self-close	-	Self-close	-	F045138281228	150		
Inset	Cranking 19	Pattern	Type	Item No.	Pattern	Type	Item No.	Item No.	PU
	Hinge cup: steel, nickel-plated Hinge arm: zinc, nickel-plated	42 / 45	Soft-close	F017139417228	45	Soft-close	F028138522228	F028138526228	150
			Self-close	F034139388228		Self-close	F045138460228	F045138464228	150
		42	Soft-close	-	Soft-close	-	F028138344228	150	
			Self-close	-	Self-close	-	F045138282228	150	

Cover cap	Item No.	PU
Steel, nickel-plated	F072135500247	1000

Opening angle reduction clip to 85°	Item No.	PU
Steel, nickel	F072135751517	50

Hinge cup cover cap	Item No.	PU
Steel, nickel-plated	F072135503228	150

Wood screw, nickel-plated	Item No.	PU
#6 x 5/8" FHP, NI	81001-43	500

PU = packaging unit

Full overlay	Overlay	Half overlay	Inset																																																																																																																																																																																																																																																																																																																																																																				
Drawing shows Tiomos with a base plate height (BPH) 02.	Drawing shows Tiomos with a base plate height (BPH) 02.	Drawing shows Tiomos with a base plate height (BPH) 02.	Drawing shows Tiomos with a base plate height (BPH) 02. X = 38.5+ DT																																																																																																																																																																																																																																																																																																																																																																				
<table border="1"> <thead> <tr> <th rowspan="2">Door overlay</th> <th colspan="5">Drilling Distance (DD)</th> </tr> <tr> <th>3</th> <th>4</th> <th>5</th> <th>6</th> <th>7</th> </tr> </thead> <tbody> <tr><td>22.0</td><td></td><td></td><td></td><td></td><td>0</td></tr> <tr><td>21.0</td><td></td><td></td><td></td><td>0</td><td></td></tr> <tr><td>20.0</td><td></td><td></td><td>0</td><td>2</td><td></td></tr> <tr><td>19.0</td><td></td><td>0</td><td>2</td><td>3</td><td></td></tr> <tr><td>18.5</td><td></td><td></td><td></td><td>3.5</td><td></td></tr> <tr><td>18.0</td><td>0</td><td></td><td>2</td><td>3</td><td></td></tr> <tr><td>17.5</td><td></td><td></td><td>3.5</td><td></td><td></td></tr> <tr><td>17.0</td><td></td><td>2</td><td>3</td><td></td><td></td></tr> <tr><td>16.5</td><td></td><td></td><td>3.5</td><td></td><td></td></tr> <tr><td>16.0</td><td>2</td><td>3</td><td></td><td></td><td></td></tr> <tr><td>15.5</td><td></td><td>3.5</td><td></td><td></td><td></td></tr> <tr><td>15.0</td><td>3</td><td></td><td></td><td></td><td></td></tr> <tr><td>14.5</td><td>3.5</td><td></td><td></td><td></td><td></td></tr> <tr><td></td><td colspan="5">Base Plate Height (BPH)</td></tr> </tbody> </table>	Door overlay	Drilling Distance (DD)					3	4	5	6	7	22.0					0	21.0				0		20.0			0	2		19.0		0	2	3		18.5				3.5		18.0	0		2	3		17.5			3.5			17.0		2	3			16.5			3.5			16.0	2	3				15.5		3.5				15.0	3					14.5	3.5						Base Plate Height (BPH)					<table border="1"> <thead> <tr> <th rowspan="2">Door overlay</th> <th colspan="5">Drilling Distance (DD)</th> </tr> <tr> <th>3</th> <th>4</th> <th>5</th> <th>6</th> <th>7</th> </tr> </thead> <tbody> <tr><td>19.0</td><td></td><td></td><td></td><td></td><td>0</td></tr> <tr><td>18.0</td><td></td><td></td><td></td><td>0</td><td></td></tr> <tr><td>17.0</td><td></td><td></td><td>0</td><td>2</td><td></td></tr> <tr><td>16.5</td><td></td><td></td><td></td><td>2</td><td>3</td></tr> <tr><td>16.0</td><td></td><td>0</td><td></td><td>2</td><td>3</td></tr> <tr><td>15.5</td><td></td><td></td><td></td><td>3.5</td><td></td></tr> <tr><td>15.0</td><td>0</td><td></td><td>2</td><td>3</td><td></td></tr> <tr><td>14.5</td><td></td><td></td><td></td><td>3.5</td><td></td></tr> <tr><td>14.0</td><td></td><td>2</td><td>3</td><td></td><td></td></tr> <tr><td>13.5</td><td></td><td></td><td>3.5</td><td></td><td></td></tr> <tr><td>13.0</td><td>2</td><td>3</td><td></td><td></td><td></td></tr> <tr><td>12.5</td><td></td><td>3.5</td><td></td><td></td><td></td></tr> <tr><td>12.0</td><td>3</td><td></td><td></td><td></td><td></td></tr> <tr><td>11.5</td><td>3.5</td><td></td><td></td><td></td><td></td></tr> <tr><td></td><td colspan="5">Base Plate Height (BPH)</td></tr> </tbody> </table>	Door overlay	Drilling Distance (DD)					3	4	5	6	7	19.0					0	18.0				0		17.0			0	2		16.5				2	3	16.0		0		2	3	15.5				3.5		15.0	0		2	3		14.5				3.5		14.0		2	3			13.5			3.5			13.0	2	3				12.5		3.5				12.0	3					11.5	3.5						Base Plate Height (BPH)					<table border="1"> <thead> <tr> <th rowspan="2">Door overlay</th> <th colspan="5">Drilling Distance (DD)</th> </tr> <tr> <th>3</th> <th>4</th> <th>5</th> <th>6</th> <th>7</th> </tr> </thead> <tbody> <tr><td>12.5</td><td></td><td></td><td></td><td></td><td>0</td></tr> <tr><td>11.5</td><td></td><td></td><td></td><td>0</td><td></td></tr> <tr><td>10.5</td><td></td><td></td><td>0</td><td>2</td><td></td></tr> <tr><td>10.0</td><td></td><td></td><td></td><td>2</td><td>3</td></tr> <tr><td>9.5</td><td></td><td>0</td><td></td><td>2</td><td>3</td></tr> <tr><td>9.0</td><td></td><td></td><td></td><td>3.5</td><td></td></tr> <tr><td>8.5</td><td>0</td><td></td><td>2</td><td>3</td><td></td></tr> <tr><td>8.0</td><td></td><td></td><td></td><td>3.5</td><td></td></tr> <tr><td>7.5</td><td></td><td>2</td><td>3</td><td></td><td></td></tr> <tr><td>7.0</td><td></td><td></td><td>3.5</td><td></td><td></td></tr> <tr><td>6.5</td><td>2</td><td>3</td><td></td><td></td><td></td></tr> <tr><td>6.0</td><td></td><td>3.5</td><td></td><td></td><td></td></tr> <tr><td>5.5</td><td>3</td><td></td><td></td><td></td><td></td></tr> <tr><td>5.0</td><td>3.5</td><td></td><td></td><td></td><td></td></tr> <tr><td></td><td colspan="5">Base Plate Height (BPH)</td></tr> </tbody> </table>	Door overlay	Drilling Distance (DD)					3	4	5	6	7	12.5					0	11.5				0		10.5			0	2		10.0				2	3	9.5		0		2	3	9.0				3.5		8.5	0		2	3		8.0				3.5		7.5		2	3			7.0			3.5			6.5	2	3				6.0		3.5				5.5	3					5.0	3.5						Base Plate Height (BPH)					<table border="1"> <thead> <tr> <th rowspan="2">Reveal min (R)</th> <th colspan="5">Drilling Distance (DD)</th> </tr> <tr> <th>3</th> <th>4</th> <th>5</th> <th>6</th> <th>7</th> </tr> </thead> <tbody> <tr><td>0.0</td><td></td><td>0</td><td></td><td>2</td><td>3</td></tr> <tr><td>0.5</td><td></td><td></td><td></td><td>3.5</td><td></td></tr> <tr><td>1.0</td><td>0</td><td></td><td>2</td><td>3</td><td></td></tr> <tr><td>1.5</td><td></td><td></td><td></td><td>3.5</td><td></td></tr> <tr><td>2.0</td><td></td><td>2</td><td>3</td><td></td><td></td></tr> <tr><td>3.0</td><td>2</td><td>3</td><td></td><td></td><td></td></tr> <tr><td>4.0</td><td>3</td><td></td><td></td><td></td><td></td></tr> <tr><td></td><td colspan="5">Base Plate Height (BPH)</td></tr> </tbody> </table>	Reveal min (R)	Drilling Distance (DD)					3	4	5	6	7	0.0		0		2	3	0.5				3.5		1.0	0		2	3		1.5				3.5		2.0		2	3			3.0	2	3				4.0	3						Base Plate Height (BPH)				
Door overlay		Drilling Distance (DD)																																																																																																																																																																																																																																																																																																																																																																					
	3	4	5	6	7																																																																																																																																																																																																																																																																																																																																																																		
22.0					0																																																																																																																																																																																																																																																																																																																																																																		
21.0				0																																																																																																																																																																																																																																																																																																																																																																			
20.0			0	2																																																																																																																																																																																																																																																																																																																																																																			
19.0		0	2	3																																																																																																																																																																																																																																																																																																																																																																			
18.5				3.5																																																																																																																																																																																																																																																																																																																																																																			
18.0	0		2	3																																																																																																																																																																																																																																																																																																																																																																			
17.5			3.5																																																																																																																																																																																																																																																																																																																																																																				
17.0		2	3																																																																																																																																																																																																																																																																																																																																																																				
16.5			3.5																																																																																																																																																																																																																																																																																																																																																																				
16.0	2	3																																																																																																																																																																																																																																																																																																																																																																					
15.5		3.5																																																																																																																																																																																																																																																																																																																																																																					
15.0	3																																																																																																																																																																																																																																																																																																																																																																						
14.5	3.5																																																																																																																																																																																																																																																																																																																																																																						
	Base Plate Height (BPH)																																																																																																																																																																																																																																																																																																																																																																						
Door overlay	Drilling Distance (DD)																																																																																																																																																																																																																																																																																																																																																																						
	3	4	5	6	7																																																																																																																																																																																																																																																																																																																																																																		
19.0					0																																																																																																																																																																																																																																																																																																																																																																		
18.0				0																																																																																																																																																																																																																																																																																																																																																																			
17.0			0	2																																																																																																																																																																																																																																																																																																																																																																			
16.5				2	3																																																																																																																																																																																																																																																																																																																																																																		
16.0		0		2	3																																																																																																																																																																																																																																																																																																																																																																		
15.5				3.5																																																																																																																																																																																																																																																																																																																																																																			
15.0	0		2	3																																																																																																																																																																																																																																																																																																																																																																			
14.5				3.5																																																																																																																																																																																																																																																																																																																																																																			
14.0		2	3																																																																																																																																																																																																																																																																																																																																																																				
13.5			3.5																																																																																																																																																																																																																																																																																																																																																																				
13.0	2	3																																																																																																																																																																																																																																																																																																																																																																					
12.5		3.5																																																																																																																																																																																																																																																																																																																																																																					
12.0	3																																																																																																																																																																																																																																																																																																																																																																						
11.5	3.5																																																																																																																																																																																																																																																																																																																																																																						
	Base Plate Height (BPH)																																																																																																																																																																																																																																																																																																																																																																						
Door overlay	Drilling Distance (DD)																																																																																																																																																																																																																																																																																																																																																																						
	3	4	5	6	7																																																																																																																																																																																																																																																																																																																																																																		
12.5					0																																																																																																																																																																																																																																																																																																																																																																		
11.5				0																																																																																																																																																																																																																																																																																																																																																																			
10.5			0	2																																																																																																																																																																																																																																																																																																																																																																			
10.0				2	3																																																																																																																																																																																																																																																																																																																																																																		
9.5		0		2	3																																																																																																																																																																																																																																																																																																																																																																		
9.0				3.5																																																																																																																																																																																																																																																																																																																																																																			
8.5	0		2	3																																																																																																																																																																																																																																																																																																																																																																			
8.0				3.5																																																																																																																																																																																																																																																																																																																																																																			
7.5		2	3																																																																																																																																																																																																																																																																																																																																																																				
7.0			3.5																																																																																																																																																																																																																																																																																																																																																																				
6.5	2	3																																																																																																																																																																																																																																																																																																																																																																					
6.0		3.5																																																																																																																																																																																																																																																																																																																																																																					
5.5	3																																																																																																																																																																																																																																																																																																																																																																						
5.0	3.5																																																																																																																																																																																																																																																																																																																																																																						
	Base Plate Height (BPH)																																																																																																																																																																																																																																																																																																																																																																						
Reveal min (R)	Drilling Distance (DD)																																																																																																																																																																																																																																																																																																																																																																						
	3	4	5	6	7																																																																																																																																																																																																																																																																																																																																																																		
0.0		0		2	3																																																																																																																																																																																																																																																																																																																																																																		
0.5				3.5																																																																																																																																																																																																																																																																																																																																																																			
1.0	0		2	3																																																																																																																																																																																																																																																																																																																																																																			
1.5				3.5																																																																																																																																																																																																																																																																																																																																																																			
2.0		2	3																																																																																																																																																																																																																																																																																																																																																																				
3.0	2	3																																																																																																																																																																																																																																																																																																																																																																					
4.0	3																																																																																																																																																																																																																																																																																																																																																																						
	Base Plate Height (BPH)																																																																																																																																																																																																																																																																																																																																																																						

Minimum gaps	Reveal	With 85° angle reduction clip																																																																																																																																																																																																																																																						
<p>The minimum gap is the gap between the closed door and the front of the cabinet.</p> <p>*only achievable with 85° angle reduction clip</p> <table border="1"> <thead> <tr> <th rowspan="2">Door Thickness (DT)</th> <th colspan="5">Drilling Distance (DD)</th> <th rowspan="2">Minimum gap</th> </tr> <tr> <th>3</th> <th>4</th> <th>5</th> <th>6</th> <th>7</th> </tr> </thead> <tbody> <tr><td>24.0</td><td>1.0</td><td>1.0</td><td>1.0</td><td>1.2* 2.1*</td><td></td><td></td></tr> <tr><td>22.0</td><td>1.0</td><td>1.0</td><td>1.0</td><td>1.0</td><td>1.5*</td><td></td></tr> <tr><td>21.0</td><td>1.0</td><td>1.0</td><td>1.0</td><td>1.0</td><td>1.2*</td><td></td></tr> <tr><td>20.0</td><td>1.0</td><td>1.0</td><td>1.0</td><td>1.0</td><td>1.0</td><td></td></tr> <tr><td>19.0</td><td>1.0</td><td>1.0</td><td>1.0</td><td>1.0</td><td>1.0</td><td></td></tr> <tr><td>18.0</td><td>1.0</td><td>1.0</td><td>1.0</td><td>1.0</td><td>1.0</td><td></td></tr> <tr><td>17.0</td><td>1.0</td><td>1.0</td><td>1.0</td><td>1.0</td><td>1.0</td><td></td></tr> <tr><td>16.0</td><td>1.0</td><td>1.0</td><td>1.0</td><td>1.0</td><td>1.0</td><td></td></tr> <tr><td></td><td colspan="5"></td><td>Minimum gap</td></tr> </tbody> </table>	Door Thickness (DT)	Drilling Distance (DD)					Minimum gap	3	4	5	6	7	24.0	1.0	1.0	1.0	1.2* 2.1*			22.0	1.0	1.0	1.0	1.0	1.5*		21.0	1.0	1.0	1.0	1.0	1.2*		20.0	1.0	1.0	1.0	1.0	1.0		19.0	1.0	1.0	1.0	1.0	1.0		18.0	1.0	1.0	1.0	1.0	1.0		17.0	1.0	1.0	1.0	1.0	1.0		16.0	1.0	1.0	1.0	1.0	1.0								Minimum gap	<p>Reveal dimensions were determined with an edge radius (of the door) of 1mm. Hinge dimensions and reveal calculation based on factory setting.</p> <p>IMPORTANT To determine the correct application Grass strongly recommends a trial mounting for all hinges and base plates.</p> <table border="1"> <thead> <tr> <th rowspan="2">Door Thickness (DT)</th> <th colspan="5">Drilling Distance (DD)</th> <th rowspan="2">Reveal (R)</th> </tr> <tr> <th>3</th> <th>4</th> <th>5</th> <th>6</th> <th>7</th> </tr> </thead> <tbody> <tr><td>24.0</td><td>2.4</td><td>2.1</td><td>2.1</td><td>2.1</td><td>2.0</td><td></td></tr> <tr><td>22.0</td><td>1.6</td><td>1.6</td><td>1.6</td><td>1.5</td><td>1.5</td><td></td></tr> <tr><td>21.0</td><td>1.4</td><td>1.3</td><td>1.3</td><td>1.3</td><td>1.3</td><td></td></tr> <tr><td>20.0</td><td>1.1</td><td>1.1</td><td>1.1</td><td>1.1</td><td>1.1</td><td></td></tr> <tr><td>19.0</td><td>0.9</td><td>0.9</td><td>0.9</td><td>0.9</td><td>0.9</td><td></td></tr> <tr><td>18.0</td><td>0.7</td><td>0.7</td><td>0.7</td><td>0.7</td><td>0.7</td><td></td></tr> <tr><td>17.0</td><td>0.6</td><td>0.6</td><td>0.6</td><td>0.6</td><td>0.6</td><td></td></tr> <tr><td>16.0</td><td>0.6</td><td>0.6</td><td>0.6</td><td>0.6</td><td>0.6</td><td></td></tr> <tr><td></td><td colspan="5"></td><td>Reveal (R)</td></tr> </tbody> </table>	Door Thickness (DT)	Drilling Distance (DD)					Reveal (R)	3	4	5	6	7	24.0	2.4	2.1	2.1	2.1	2.0		22.0	1.6	1.6	1.6	1.5	1.5		21.0	1.4	1.3	1.3	1.3	1.3		20.0	1.1	1.1	1.1	1.1	1.1		19.0	0.9	0.9	0.9	0.9	0.9		18.0	0.7	0.7	0.7	0.7	0.7		17.0	0.6	0.6	0.6	0.6	0.6		16.0	0.6	0.6	0.6	0.6	0.6								Reveal (R)	<table border="1"> <thead> <tr> <th rowspan="2">Door Thickness (DT)</th> <th colspan="5">Drilling Distance (DD)</th> <th rowspan="2">Reveal (R)</th> </tr> <tr> <th>3</th> <th>4</th> <th>5</th> <th>6</th> <th>7</th> </tr> </thead> <tbody> <tr><td>36.0</td><td>11.1</td><td>10.3</td><td>9.7</td><td>9.1</td><td>8.5</td><td></td></tr> <tr><td>30.0</td><td>5.4</td><td>4.8</td><td>4.4</td><td>4.3</td><td>4.2</td><td></td></tr> <tr><td>28.0</td><td>3.7</td><td>3.6</td><td>3.5</td><td>3.4</td><td>3.3</td><td></td></tr> <tr><td>26.0</td><td>2.9</td><td>2.8</td><td>2.8</td><td>2.7</td><td>2.6</td><td></td></tr> <tr><td>24.0</td><td>2.2</td><td>2.1</td><td>2.1</td><td>2.1</td><td>2.0</td><td></td></tr> <tr><td>22.0</td><td>1.6</td><td>1.6</td><td>1.6</td><td>1.5</td><td>1.5</td><td></td></tr> <tr><td>21.0</td><td>1.4</td><td>1.3</td><td>1.3</td><td>1.3</td><td>1.3</td><td></td></tr> <tr><td>20.0</td><td>1.1</td><td>1.1</td><td>1.1</td><td>1.1</td><td>1.1</td><td></td></tr> <tr><td>19.0</td><td>0.9</td><td>0.9</td><td>0.9</td><td>0.9</td><td>0.9</td><td></td></tr> <tr><td>18.0</td><td>0.7</td><td>0.7</td><td>0.7</td><td>0.7</td><td>0.7</td><td></td></tr> <tr><td>16.0</td><td>0.6</td><td>0.6</td><td>0.6</td><td>0.6</td><td>0.6</td><td></td></tr> <tr><td></td><td colspan="5"></td><td>Reveal (R)</td></tr> </tbody> </table>	Door Thickness (DT)	Drilling Distance (DD)					Reveal (R)	3	4	5	6	7	36.0	11.1	10.3	9.7	9.1	8.5		30.0	5.4	4.8	4.4	4.3	4.2		28.0	3.7	3.6	3.5	3.4	3.3		26.0	2.9	2.8	2.8	2.7	2.6		24.0	2.2	2.1	2.1	2.1	2.0		22.0	1.6	1.6	1.6	1.5	1.5		21.0	1.4	1.3	1.3	1.3	1.3		20.0	1.1	1.1	1.1	1.1	1.1		19.0	0.9	0.9	0.9	0.9	0.9		18.0	0.7	0.7	0.7	0.7	0.7		16.0	0.6	0.6	0.6	0.6	0.6								Reveal (R)
Door Thickness (DT)		Drilling Distance (DD)						Minimum gap																																																																																																																																																																																																																																																
	3	4	5	6	7																																																																																																																																																																																																																																																			
24.0	1.0	1.0	1.0	1.2* 2.1*																																																																																																																																																																																																																																																				
22.0	1.0	1.0	1.0	1.0	1.5*																																																																																																																																																																																																																																																			
21.0	1.0	1.0	1.0	1.0	1.2*																																																																																																																																																																																																																																																			
20.0	1.0	1.0	1.0	1.0	1.0																																																																																																																																																																																																																																																			
19.0	1.0	1.0	1.0	1.0	1.0																																																																																																																																																																																																																																																			
18.0	1.0	1.0	1.0	1.0	1.0																																																																																																																																																																																																																																																			
17.0	1.0	1.0	1.0	1.0	1.0																																																																																																																																																																																																																																																			
16.0	1.0	1.0	1.0	1.0	1.0																																																																																																																																																																																																																																																			
						Minimum gap																																																																																																																																																																																																																																																		
Door Thickness (DT)	Drilling Distance (DD)					Reveal (R)																																																																																																																																																																																																																																																		
	3	4	5	6	7																																																																																																																																																																																																																																																			
24.0	2.4	2.1	2.1	2.1	2.0																																																																																																																																																																																																																																																			
22.0	1.6	1.6	1.6	1.5	1.5																																																																																																																																																																																																																																																			
21.0	1.4	1.3	1.3	1.3	1.3																																																																																																																																																																																																																																																			
20.0	1.1	1.1	1.1	1.1	1.1																																																																																																																																																																																																																																																			
19.0	0.9	0.9	0.9	0.9	0.9																																																																																																																																																																																																																																																			
18.0	0.7	0.7	0.7	0.7	0.7																																																																																																																																																																																																																																																			
17.0	0.6	0.6	0.6	0.6	0.6																																																																																																																																																																																																																																																			
16.0	0.6	0.6	0.6	0.6	0.6																																																																																																																																																																																																																																																			
						Reveal (R)																																																																																																																																																																																																																																																		
Door Thickness (DT)	Drilling Distance (DD)					Reveal (R)																																																																																																																																																																																																																																																		
	3	4	5	6	7																																																																																																																																																																																																																																																			
36.0	11.1	10.3	9.7	9.1	8.5																																																																																																																																																																																																																																																			
30.0	5.4	4.8	4.4	4.3	4.2																																																																																																																																																																																																																																																			
28.0	3.7	3.6	3.5	3.4	3.3																																																																																																																																																																																																																																																			
26.0	2.9	2.8	2.8	2.7	2.6																																																																																																																																																																																																																																																			
24.0	2.2	2.1	2.1	2.1	2.0																																																																																																																																																																																																																																																			
22.0	1.6	1.6	1.6	1.5	1.5																																																																																																																																																																																																																																																			
21.0	1.4	1.3	1.3	1.3	1.3																																																																																																																																																																																																																																																			
20.0	1.1	1.1	1.1	1.1	1.1																																																																																																																																																																																																																																																			
19.0	0.9	0.9	0.9	0.9	0.9																																																																																																																																																																																																																																																			
18.0	0.7	0.7	0.7	0.7	0.7																																																																																																																																																																																																																																																			
16.0	0.6	0.6	0.6	0.6	0.6																																																																																																																																																																																																																																																			
						Reveal (R)																																																																																																																																																																																																																																																		

Screw-on	Impresso and Dowelled	Cup dimensions
		<p>() Impresso</p>

Tiomos 120

120° hinge for standard doors



- 3-dimensional adjustment with suitable base plate
- Accommodates overlays up to 24mm (15/16")
- Optimal reveal up to 24mm door thickness
- Soft-close or Self-close hinges available
- For face frame or frameless cabinets
- Convenient depth adjustment with worm gear

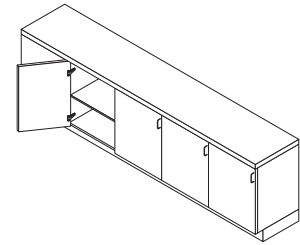

Tiomos 120	Opening Angle 120°	Impresso	Screw-on	Dowelled
------------	--------------------	----------	----------	----------

Full overlay	Cranking 00	Pattern	Type	Item No.	Pattern	Type	Item No.	Item No.	PU
	Hinge cup: steel, nickel-plated Hinge arm: steel, nickel-plated	42 / 45	Soft-close	F017139428228	45	Soft-close	F028138547228	F028138551228	150
			Self-close	F034139399228		Self-close	F045138485228	F045138489228	150
		42	Soft-close	-	Soft-close	-	F028138369228	150	
			Self-close	-	Self-close	-	F045138307228	150	
Overlay	Cranking 03	Pattern	Type	Item No.	Pattern	Type	Item No.	Item No.	PU
	Hinge cup: steel, nickel-plated Hinge arm: steel, nickel-plated	42 / 45	Soft-close	F017139429228	45	Soft-close	F028138548228	F028138552228	150
			Self-close	F034139400228		Self-close	F045138486228	F045138490228	150
		42	Soft-close	-	Soft-close	-	F028138370228	150	
			Self-close	-	Self-close	-	F045138308228	150	
Half overlay	Cranking 9.5	Pattern	Type	Item No.	Pattern	Type	Item No.	Item No.	PU
	Hinge cup: steel, nickel-plated Hinge arm: zinc, nickel-plated	42 / 45	Soft-close	F017139430228	45	Soft-close	F028138549228	F028138553228	150
			Self-close	F034139401228		Self-close	F045138487228	F045138491228	150
		42	Soft-close	-	Soft-close	-	F028138371228	150	
			Self-close	-	Self-close	-	F045138309228	150	

Cover cap	Item No.	PU
Steel, nickel-plated	F072135500247	150

Opening angle reduction clip to 85°	Item No.	PU
Steel, nickel	F072135751517	50

Hinge cup cover cap	Item No.	PU
Steel, nickel-plated	F072135503228	150

Wood screw, nickel-plated	Item No.	PU
#6 x 5/8" FHP, NI	81001-43	500

PU = packaging unit

Full overlay Overlay Half overlay

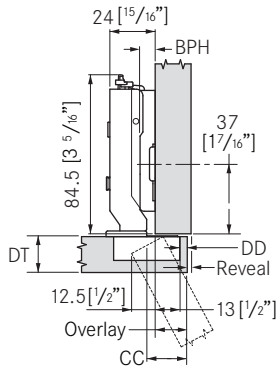

Drawing shows Tiomos with a base plate height (BPH) 02.

Drilling Distance (DD)

	3	4	5	6	7
22.0					0
21.0				0	
20.0			0		
19.0		0		2	3
18.5					3.5
18.0	0		2	3	
17.5				3.5	
17.0		2	3		
16.5				3.5	
16.0	2	3			
15.5		3.5			
15.0	3				
14.5	3.5				
	Base Plate Height (BPH)				

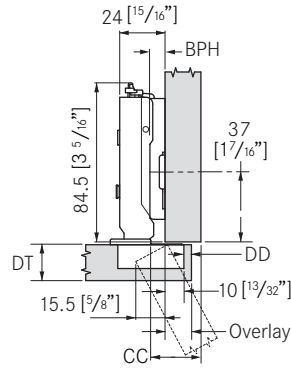

Drawing shows Tiomos with a base plate height (BPH) 02.

Drilling Distance (DD)

	3	4	5	6	7
19.0					0
18.0				0	
17.0			0		2
16.5					
16.0		0		2	3
15.5					3.5
15.0	0		2	3	
14.5				3.5	
14.0		2	3		
13.5			3.5		
13.0	2	3			
12.5		3.5			
12.0	3				
11.5	3.5				
	Base Plate Height (BPH)				

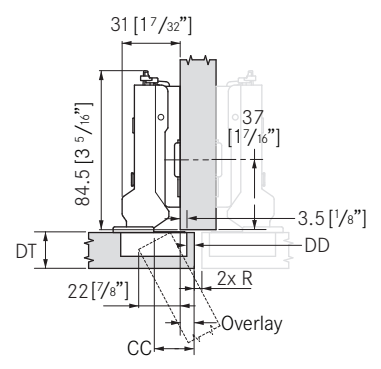

Drawing shows Tiomos with a base plate height (BPH) 02.

Drilling Distance (DD)

	3	4	5	6	7
12.5					0
11.5				0	
10.5			0		
10.0				2	
9.5		0		2	3
9.0					3.5
8.5	0		2	3	
8.0				3.5	
7.5		2	3		
7.0				3.5	
6.5	2	3			
6.0		3.5			
5.5	3				
5.0	3.5				
	Base Plate Height (BPH)				

Minimum gaps

The minimum gap is the gap between the closed door and the front of the cabinet.

Drilling Distance (DD)

	3	4	5	6	7
24.0	1.2	2.1	3.0	3.9	4.7
22.0	1.0	1.1	2.0	2.9	3.8
21.0	1.0	1.0	1.6	2.4	3.3
20.0	1.0	1.0	1.1	2.0	2.9
19.0	1.0	1.0	1.0	1.5	2.4
18.0	1.0	1.0	1.0	1.0	1.9
17.0	1.0	1.0	1.0	1.0	1.5
16.0	1.0	1.0	1.0	1.0	1.0
	Minimum gap				

Reveal

Reveal dimensions were determined with an edge radius (of the door) of 1mm. Hinge dimensions and reveal calculation based on factory setting.

IMPORTANT

To determine the correct application Grass strongly recommends a trial mounting for all hinges and base plates.

Drilling Distance (DD)

	3	4	5	6	7
24.0	6.4	5.4	4.4	3.4	2.4
22.0	3.0	2.0	1.5	1.5	1.5
21.0	1.4	1.3	1.3	1.3	1.3
20.0	1.1	1.1	1.1	1.1	1.1
19.0	0.9	0.9	0.9	0.9	0.9
18.0	0.7	0.7	0.7	0.7	0.7
17.0	1.0	1.0	1.0	1.0	1.5
16.0	1.0	1.0	1.0	1.0	1.0
	Reveal (R)				

With 85° angle reduction clip

Drilling Distance (DD)

	3	4	5	6	7
36.0	11.1	10.3	9.7	9.1	8.5
30.0	5.4	4.8	4.4	4.3	4.2
28.0	3.7	3.6	3.5	3.4	3.3
26.0	2.9	2.8	2.8	2.7	2.6
24.0	2.2	2.1	2.1	2.1	2.0
22.0	1.6	1.6	1.6	1.5	1.5
21.0	1.4	1.3	1.3	1.3	1.3
20.0	1.1	1.1	1.1	1.1	1.1
19.0	0.9	0.9	0.9	0.9	0.9
18.0	0.7	0.7	0.7	0.7	0.7
16.0	0.6	0.6	0.6	0.6	0.6
	Reveal (R)				

Screw-on

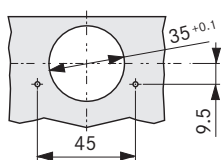

Impresso and Dowelled

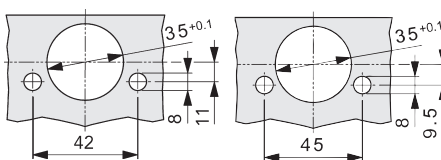

Cup dimensions

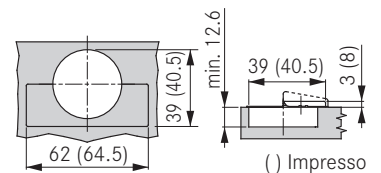

Tiomos 160

160° Wide angle hinge



- 3-dimensional adjustment with suitable base plate
- Accommodates overlays up to 25.4 mm (1")
- Soft-close or Self-close hinges available
- For face frame or frameless cabinets
- Convenient depth adjustment with worm gear
- Zero protrusion when door is opened 90°
- 10mm cup depth
- For door thicknesses up to 32 mm (1 1/4")
- Minimal reveal

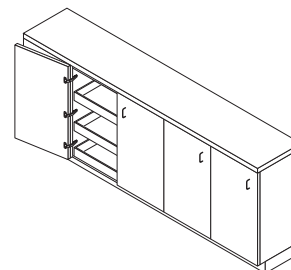

Tiomos 160	Opening Angle 160°	Impresso	Screw-on	Dowelled
------------	--------------------	----------	----------	----------

Full overlay	Cranking 00	Pattern	Type	Item No.	Pattern	Type	Item No.	Item No.	PU
	Hinge cup: steel, nickel-plated Hinge arm: steel, nickel-plated	42 / 45	Soft-close	F017139435217	45	Soft-close	F028138561217	F028138564217	50
			Self-close	F034139406217		Self-close	F045138499217	F045138502217	50
	Hinge cup: steel, nickel-plated Hinge arm: steel, nickel-plated	42 / 45	Soft-close	F017139436217	45	Soft-close	F028138562217	F028138565217	50
			Self-close	F034139407217		Self-close	F045138500217	F045138503217	50
	Hinge cup: steel, nickel-plated Hinge arm: steel, nickel-plated	42 / 45	Soft-close	F017139437217	45	Soft-close	F028138563217	F028138566217	50
			Self-close	F034139408217		Self-close	F045138501217	F045138504217	50
	Hinge cup: steel, nickel-plated Hinge arm: zinc, nickel-plated	42 / 45	Soft-close	F017139437217	45	Soft-close	F028138563217	F028138566217	50
			Self-close	F034139408217		Self-close	F045138501217	F045138504217	50
	Hinge cup: steel, nickel-plated Hinge arm: zinc, nickel-plated	42 / 45	Soft-close	F017139437217	42	Soft-close	-	F028138383217	50
			Self-close	F034139408217		Self-close	-	F045138320217	50

Mitered corner application

Use Full overlay hinge (00 Cranking) with 19 mm base plate.
Use 120° opening angle reduction clip.
Prevents doors from bumping with the cabinet side in inset applications and mitered corner applications.

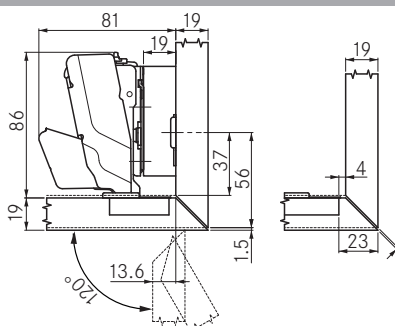

3/8" Lip door application

Use Full overlay hinge (00 Cranking) with 21 mm base plate.
Use 120° opening angle reduction clip.
Prevents doors from bumping with the cabinet side in inset applications and mitered corner applications.

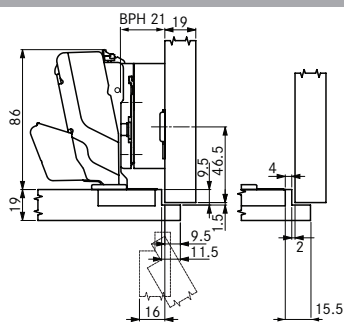

Zero door protrusion at 90°

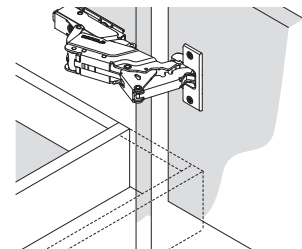

Zero protrusion for application with inset drawers. With 00 cranking and 00 height of base plate the door is flush with the cabinet at 90°.

Hinge cup cover cap

	Steel, nickel-plated	F072135503228	150
--	----------------------	----------------------	-----

Angle reduction clip to 120°

	Plastic, black	F072135753117	50
--	----------------	----------------------	----

PU = packaging unit

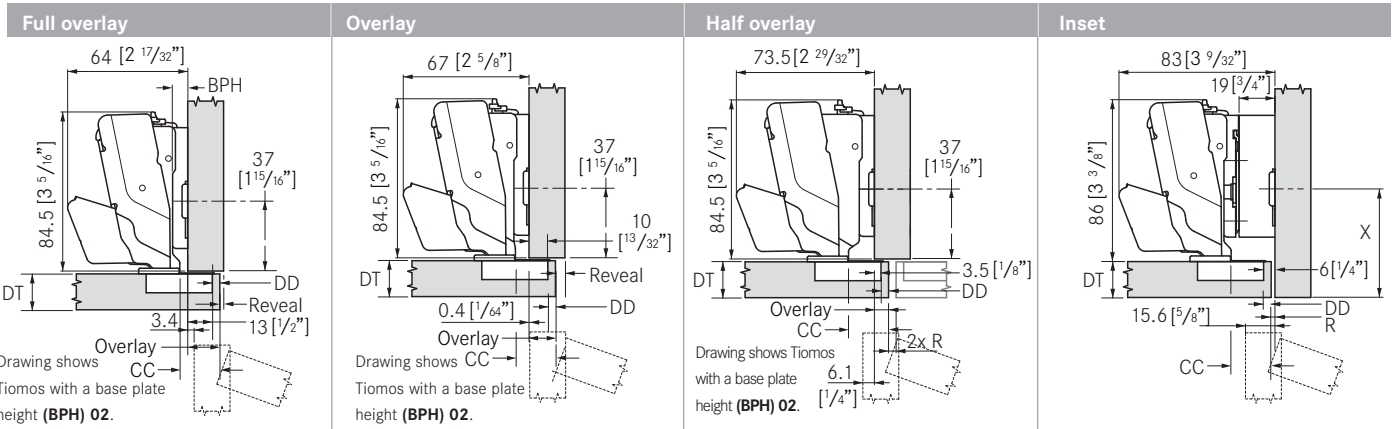

Drilling Distance (DD)

	3	4	5	6	7	8	9	10	
25.0									0
24.0								0	
23.0							0	2	
22.0						0	2	3	
21.0				0		2	3		
20.0		0		2	3				
19.0	0		2	3					
18.5				3.5					
18.0	0		2	3					
17.5				3.5					
17.0		2	3						
16.5			3.5						
16.0	2	3							
15.5		3.5							
15.0		3							
14.5	3.5								

Door overlay

Base Plate Height (BPH)

Drilling Distance (DD)

	3	4	5	6	7	8	9	10	
22.0									0
21.0								0	
20.0							0	2	
19.0						0	2	3	
18.0				0		2	3		
17.0			0		2	3			
16.5						3.5			
16.0		0		2	3				
15.5						3.5			
15.0	0		2	3					
14.5					3.5				
14.0		2	3						
13.5			3.5						
13.0	2	3							
12.5		3.5							
12.0	3								
11.5	3.5								

Door overlay

Base Plate Height (BPH)

Drilling Distance (DD)

	3	4	5	6	7	8	9	10	
15.5									0
14.5								0	
13.5							0	2	
12.5						0	2	3	
11.5				0		2	3		
10.5			0		2	3			
10.0						3.5			
9.5	0		2	3					
9.0						3.5			
8.5	0		2	3					
8.0						3.5			
7.5		2	3						
7.0			3.5						
6.5	2	3							
6.0		3.5							
5.5	3								
5.0	3.5								

Door overlay

Base Plate Height (BPH)

Drilling Distance (DD)

	3	4	5	6	7	
0.0						19
0.5						
1.0					19	
1.5						
2.0					19	
3.0		19				
4.0						

Reveal (R)

Base Plate Height (BPH)

Drawing shows Tiomos with a cranking 03 hinge, Base Plate Height (BPH) 19
X = 38.5 + DT

Minimum gaps

The minimum gap is the gap between the closed door and the front of the cabinet.

*only achievable with 120° angle reduction clip

Drilling Distance (DD)

	3	4	5	6	7	8	9	10
32.0	1.0	1.0						
31.0	1.0	1.0	1.0					
30.0	1.0	1.0	1.0					
29.0	1.0	1.0	1.0	1.0	1.0	1.0	1.0	1.0
28.0	1.0	1.0	1.0	1.0	1.0	1.0	1.0	1.0
26.0	1.0	1.0	1.0	1.0	1.0	1.0	1.0	1.0
25.0	1.0	1.0	1.0	1.0	1.0	1.0	1.0	1.0
24.0	1.0	1.0	1.0	1.0	1.0	1.0	1.0	1.0
22.0	1.0	1.0	1.0	1.0	1.0	1.0	1.0	1.0
21.0	1.0	1.0	1.0	1.0	1.0	1.0	1.0	1.0
20.0	1.0	1.0	1.0	1.0	1.0	1.0	1.0	1.0
18.0	1.0	1.0	1.0	1.0	1.0	1.0	1.0	1.0
16.0	1.0	1.0	1.0	1.0	1.0	1.0	1.0	1.0

Door Thickness (DT)

Minimum gap

Reveal

Reveal dimensions were determined with an edge radius (of the door) of 1mm. Hinge dimensions and reveal calculation based on factory setting.

IMPORTANT
To determine the correct application Grass strongly recommends a trial mounting for all hinges and base plates.

Drilling Distance (DD)

	3	4	5	6	7	8	9	10
32.0	0.2*0.2*							
31.0	0.2*0.2*0.2*							
30.0	0.2	0.2	0.2*0.2*0.2*					
29.0	0.2	0.2	0.2	0.2	0.2	0.2*0.2*		
28.0	0.0	0.0	0.0	0.0	0.0	0.0	0.0	0.0
26.0	0.0	0.0	0.0	0.0	0.0	0.0	0.0	0.0
25.0	0.0	0.0	0.0	0.0	0.0	0.0	0.0	0.0
24.0	0.0	0.0	0.0	0.0	0.0	0.0	0.0	0.0
22.0	0.0	0.0	0.0	0.0	0.0	0.0	0.0	0.0
21.0	0.0	0.0	0.0	0.0	0.0	0.0	0.0	0.0
20.0	0.0	0.0	0.0	0.0	0.0	0.0	0.0	0.0
18.0	0.0	0.0	0.0	0.0	0.0	0.0	0.0	0.0
16.0	0.0	0.0	0.0	0.0	0.0	0.0	0.0	0.0

Door Thickness (DT)

Reveal (R)

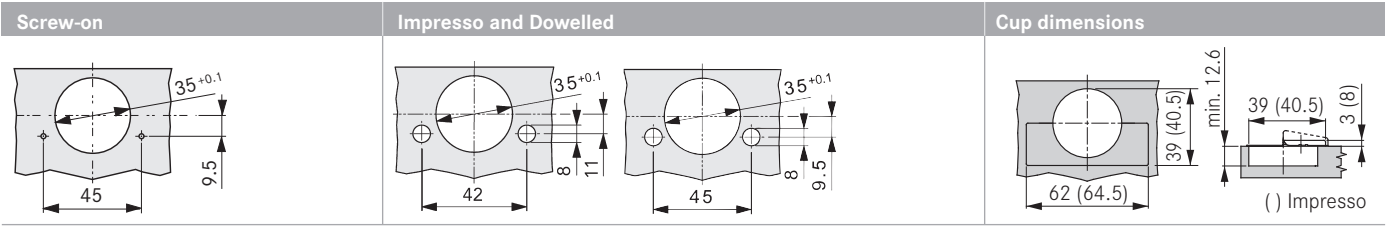

Tiemos 95

95° hinge for thick doors



- 3-dimensional adjustment with suitable base plate
- Accommodates overlays up to 24mm (15/16")
- For door thicknesses up to 36 mm (1 7/16")
- Soft-close or Self-close hinges available
- For face frame or frameless cabinets
- Convenient depth adjustment with worm gear

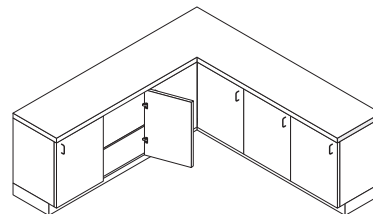

Tiemos 95	Opening Angle 95°	Impresso	Screw-on	Dowelled
-----------	-------------------	----------	----------	----------

Full overlay	Cranking 00	Pattern	Type	Item No.	Pattern	Type	Item No.	Item No.	PU
	Hinge cup: steel, nickel-plated Hinge arm: steel, nickel-plated	42 / 45	Soft-close	F017139438228	45	Soft-close	F028138567228	F028138571228	150
			Self-close	F034139409228		Self-close	F045138505228	F045138509228	150
		42	Soft-close	-	-	F028138389228	150		
			Self-close	-	-	F045138327228	150		
Overlay	Cranking 03	Pattern	Type	Item No.	Pattern	Type	Item No.	Item No.	PU
	Hinge cup: steel, nickel-plated Hinge arm: steel, nickel-plated	42 / 45	Soft-close	F017139439228	45	Soft-close	F028138568228	F028138572228	150
			Self-close	F034139410228		Self-close	F045138506228	F045138510228	150
		42	Soft-close	-	-	F028138390228	150		
			Self-close	-	-	F045138328228	150		
Half overlay	Cranking 9.5	Pattern	Type	Item No.	Pattern	Type	Item No.	Item No.	PU
	Hinge cup: steel, nickel-plated Hinge arm: zinc, nickel-plated	42 / 45	Soft-close	F017139440228	45	Soft-close	F028138569228	F028138573228	150
			Self-close	F034139411228		Self-close	F045138507228	F045138511228	150
		42	Soft-close	-	-	F028138391228	150		
			Self-close	-	-	F045138329228	150		
Inset	Cranking 19	Pattern	Type	Item No.	Pattern	Type	Item No.	Item No.	PU
	Hinge cup: steel, nickel-plated Hinge arm: zinc, nickel-plated	42 / 45	Soft-close	F017139441228	45	Soft-close	F028138570228	F028138574228	150
			Self-close	F034139412228		Self-close	F045138508228	F045138512228	150
		42	Soft-close	-	-	F028138392228	150		
			Self-close	-	-	F045138330228	150		

Cover cap	Item No.	PU
Steel, nickel-plated	F072135500247	1000

Hinge cup cover cap	Item No.	PU
Steel, nickel-plated	F072135503228	150

Wood screw, nickel-plated	Item No.	PU
#6 x 5/8" FHP, NI	81001-43	500

PU = packaging unit

Full overlay	Overlay	Half overlay	Inset																																																																																																																																																																																																																																																																																																																								
<p>Drawing shows Tiomos with a base plate height (BPH) 02.</p>	<p>Drawing shows Tiomos with a base plate height (BPH) 02.</p>	<p>Drawing shows Tiomos with a base plate height (BPH) 02.</p>	<p>Drawing shows Tiomos with a base plate height (BPH) 02. X = 38.5+ DT</p>																																																																																																																																																																																																																																																																																																																								
<p>Drilling Distance (DD)</p> <table border="1"> <thead> <tr> <th></th> <th>3</th> <th>4</th> <th>5</th> <th>6</th> <th>7</th> </tr> </thead> <tbody> <tr><td>22.0</td><td></td><td></td><td></td><td></td><td>0</td></tr> <tr><td>21.0</td><td></td><td></td><td></td><td>0</td><td></td></tr> <tr><td>20.0</td><td></td><td></td><td>0</td><td>2</td><td></td></tr> <tr><td>19.0</td><td></td><td>0</td><td>2</td><td>3</td><td></td></tr> <tr><td>18.5</td><td></td><td></td><td></td><td>3.5</td><td></td></tr> <tr><td>18.0</td><td>0</td><td></td><td>2</td><td>3</td><td></td></tr> <tr><td>17.5</td><td></td><td></td><td>3.5</td><td></td><td></td></tr> <tr><td>17.0</td><td>2</td><td>3</td><td></td><td></td><td></td></tr> <tr><td>16.5</td><td></td><td>3.5</td><td></td><td></td><td></td></tr> <tr><td>16.0</td><td>2</td><td>3</td><td></td><td></td><td></td></tr> <tr><td>15.5</td><td>3.5</td><td></td><td></td><td></td><td></td></tr> <tr><td>15.0</td><td>3</td><td></td><td></td><td></td><td></td></tr> <tr><td>14.5</td><td>3.5</td><td></td><td></td><td></td><td></td></tr> </tbody> </table>		3	4	5	6	7	22.0					0	21.0				0		20.0			0	2		19.0		0	2	3		18.5				3.5		18.0	0		2	3		17.5			3.5			17.0	2	3				16.5		3.5				16.0	2	3				15.5	3.5					15.0	3					14.5	3.5					<p>Drilling Distance (DD)</p> <table border="1"> <thead> <tr> <th></th> <th>3</th> <th>4</th> <th>5</th> <th>6</th> <th>7</th> </tr> </thead> <tbody> <tr><td>19.0</td><td></td><td></td><td></td><td></td><td>0</td></tr> <tr><td>18.0</td><td></td><td></td><td></td><td>0</td><td></td></tr> <tr><td>17.0</td><td></td><td></td><td>0</td><td>2</td><td></td></tr> <tr><td>16.5</td><td></td><td></td><td></td><td>3.5</td><td></td></tr> <tr><td>16.0</td><td></td><td>0</td><td>2</td><td>3</td><td></td></tr> <tr><td>15.5</td><td></td><td></td><td></td><td>3.5</td><td></td></tr> <tr><td>15.0</td><td>0</td><td></td><td>2</td><td>3</td><td></td></tr> <tr><td>14.5</td><td></td><td></td><td>3.5</td><td></td><td></td></tr> <tr><td>14.0</td><td>2</td><td>3</td><td></td><td></td><td></td></tr> <tr><td>13.5</td><td></td><td>3.5</td><td></td><td></td><td></td></tr> <tr><td>13.0</td><td>2</td><td>3</td><td></td><td></td><td></td></tr> <tr><td>12.5</td><td>3.5</td><td></td><td></td><td></td><td></td></tr> <tr><td>12.0</td><td>3</td><td></td><td></td><td></td><td></td></tr> <tr><td>11.5</td><td>3.5</td><td></td><td></td><td></td><td></td></tr> </tbody> </table>		3	4	5	6	7	19.0					0	18.0				0		17.0			0	2		16.5				3.5		16.0		0	2	3		15.5				3.5		15.0	0		2	3		14.5			3.5			14.0	2	3				13.5		3.5				13.0	2	3				12.5	3.5					12.0	3					11.5	3.5					<p>Drilling Distance (DD)</p> <table border="1"> <thead> <tr> <th></th> <th>3</th> <th>4</th> <th>5</th> <th>6</th> <th>7</th> </tr> </thead> <tbody> <tr><td>12.5</td><td></td><td></td><td></td><td></td><td>0</td></tr> <tr><td>11.5</td><td></td><td></td><td></td><td>0</td><td></td></tr> <tr><td>10.5</td><td></td><td></td><td>0</td><td>2</td><td></td></tr> <tr><td>10.0</td><td></td><td>0</td><td>2</td><td>3</td><td></td></tr> <tr><td>9.5</td><td></td><td>0</td><td>2</td><td>3</td><td></td></tr> <tr><td>9.0</td><td></td><td></td><td></td><td>3.5</td><td></td></tr> <tr><td>8.5</td><td>0</td><td></td><td>2</td><td>3</td><td></td></tr> <tr><td>8.0</td><td></td><td></td><td>3.5</td><td></td><td></td></tr> <tr><td>7.5</td><td>2</td><td>3</td><td></td><td></td><td></td></tr> <tr><td>7.0</td><td></td><td>3.5</td><td></td><td></td><td></td></tr> <tr><td>6.5</td><td>2</td><td>3</td><td></td><td></td><td></td></tr> <tr><td>6.0</td><td>3.5</td><td></td><td></td><td></td><td></td></tr> <tr><td>5.5</td><td>3</td><td></td><td></td><td></td><td></td></tr> <tr><td>5.0</td><td>3.5</td><td></td><td></td><td></td><td></td></tr> </tbody> </table>		3	4	5	6	7	12.5					0	11.5				0		10.5			0	2		10.0		0	2	3		9.5		0	2	3		9.0				3.5		8.5	0		2	3		8.0			3.5			7.5	2	3				7.0		3.5				6.5	2	3				6.0	3.5					5.5	3					5.0	3.5					<p>Drilling Distance (DD)</p> <table border="1"> <thead> <tr> <th></th> <th>3</th> <th>4</th> <th>5</th> <th>6</th> <th>7</th> </tr> </thead> <tbody> <tr><td>0.0</td><td></td><td>0</td><td></td><td>2</td><td>3</td></tr> <tr><td>0.5</td><td></td><td></td><td></td><td>3.5</td><td></td></tr> <tr><td>1.0</td><td>0</td><td></td><td>2</td><td>3</td><td></td></tr> <tr><td>1.5</td><td></td><td></td><td></td><td>3.5</td><td></td></tr> <tr><td>2.0</td><td></td><td>2</td><td>3</td><td></td><td></td></tr> <tr><td>3.0</td><td>2</td><td>3</td><td></td><td></td><td></td></tr> <tr><td>4.0</td><td>3</td><td></td><td></td><td></td><td></td></tr> </tbody> </table>		3	4	5	6	7	0.0		0		2	3	0.5				3.5		1.0	0		2	3		1.5				3.5		2.0		2	3			3.0	2	3				4.0	3				
	3	4	5	6	7																																																																																																																																																																																																																																																																																																																						
22.0					0																																																																																																																																																																																																																																																																																																																						
21.0				0																																																																																																																																																																																																																																																																																																																							
20.0			0	2																																																																																																																																																																																																																																																																																																																							
19.0		0	2	3																																																																																																																																																																																																																																																																																																																							
18.5				3.5																																																																																																																																																																																																																																																																																																																							
18.0	0		2	3																																																																																																																																																																																																																																																																																																																							
17.5			3.5																																																																																																																																																																																																																																																																																																																								
17.0	2	3																																																																																																																																																																																																																																																																																																																									
16.5		3.5																																																																																																																																																																																																																																																																																																																									
16.0	2	3																																																																																																																																																																																																																																																																																																																									
15.5	3.5																																																																																																																																																																																																																																																																																																																										
15.0	3																																																																																																																																																																																																																																																																																																																										
14.5	3.5																																																																																																																																																																																																																																																																																																																										
	3	4	5	6	7																																																																																																																																																																																																																																																																																																																						
19.0					0																																																																																																																																																																																																																																																																																																																						
18.0				0																																																																																																																																																																																																																																																																																																																							
17.0			0	2																																																																																																																																																																																																																																																																																																																							
16.5				3.5																																																																																																																																																																																																																																																																																																																							
16.0		0	2	3																																																																																																																																																																																																																																																																																																																							
15.5				3.5																																																																																																																																																																																																																																																																																																																							
15.0	0		2	3																																																																																																																																																																																																																																																																																																																							
14.5			3.5																																																																																																																																																																																																																																																																																																																								
14.0	2	3																																																																																																																																																																																																																																																																																																																									
13.5		3.5																																																																																																																																																																																																																																																																																																																									
13.0	2	3																																																																																																																																																																																																																																																																																																																									
12.5	3.5																																																																																																																																																																																																																																																																																																																										
12.0	3																																																																																																																																																																																																																																																																																																																										
11.5	3.5																																																																																																																																																																																																																																																																																																																										
	3	4	5	6	7																																																																																																																																																																																																																																																																																																																						
12.5					0																																																																																																																																																																																																																																																																																																																						
11.5				0																																																																																																																																																																																																																																																																																																																							
10.5			0	2																																																																																																																																																																																																																																																																																																																							
10.0		0	2	3																																																																																																																																																																																																																																																																																																																							
9.5		0	2	3																																																																																																																																																																																																																																																																																																																							
9.0				3.5																																																																																																																																																																																																																																																																																																																							
8.5	0		2	3																																																																																																																																																																																																																																																																																																																							
8.0			3.5																																																																																																																																																																																																																																																																																																																								
7.5	2	3																																																																																																																																																																																																																																																																																																																									
7.0		3.5																																																																																																																																																																																																																																																																																																																									
6.5	2	3																																																																																																																																																																																																																																																																																																																									
6.0	3.5																																																																																																																																																																																																																																																																																																																										
5.5	3																																																																																																																																																																																																																																																																																																																										
5.0	3.5																																																																																																																																																																																																																																																																																																																										
	3	4	5	6	7																																																																																																																																																																																																																																																																																																																						
0.0		0		2	3																																																																																																																																																																																																																																																																																																																						
0.5				3.5																																																																																																																																																																																																																																																																																																																							
1.0	0		2	3																																																																																																																																																																																																																																																																																																																							
1.5				3.5																																																																																																																																																																																																																																																																																																																							
2.0		2	3																																																																																																																																																																																																																																																																																																																								
3.0	2	3																																																																																																																																																																																																																																																																																																																									
4.0	3																																																																																																																																																																																																																																																																																																																										
<p>Door overlay</p>	<p>Door overlay</p>	<p>Door overlay</p>	<p>Reveal min (R)</p>																																																																																																																																																																																																																																																																																																																								
<p>Base Plate Height (BPH)</p>	<p>Base Plate Height (BPH)</p>	<p>Base Plate Height (BPH)</p>	<p>Base Plate Height (BPH)</p>																																																																																																																																																																																																																																																																																																																								

Minimum gaps	Reveal																																																																																																																								
<p>The minimum gap is the gap between the closed door and the front of the cabinet.</p> <p>Drilling Distance (DD)</p> <table border="1"> <thead> <tr> <th>Door Thickness (DT)</th> <th>3</th> <th>4</th> <th>5</th> <th>6</th> <th>7</th> </tr> </thead> <tbody> <tr><td>36.0</td><td>1.0</td><td>1.0</td><td>1.0</td><td>1.0</td><td>2.4</td></tr> <tr><td>30.0</td><td>1.0</td><td>1.0</td><td>1.0</td><td>1.0</td><td>1.8</td></tr> <tr><td>28.0</td><td>1.0</td><td>1.0</td><td>1.0</td><td>1.0</td><td>1.7</td></tr> <tr><td>26.0</td><td>1.0</td><td>1.0</td><td>1.0</td><td>1.2</td><td>1.5</td></tr> <tr><td>24.0</td><td>1.0</td><td>1.0</td><td>1.0</td><td>1.0</td><td>1.5</td></tr> <tr><td>22.0</td><td>1.0</td><td>1.0</td><td>1.0</td><td>1.0</td><td>1.5</td></tr> <tr><td>20.0</td><td>1.0</td><td>1.0</td><td>1.0</td><td>1.0</td><td>1.0</td></tr> <tr><td>18.0</td><td>1.0</td><td>1.0</td><td>1.0</td><td>1.0</td><td>1.0</td></tr> <tr><td>16.0</td><td>1.0</td><td>1.0</td><td>1.0</td><td>1.0</td><td>1.0</td></tr> </tbody> </table> <p>Minimum gap</p>	Door Thickness (DT)	3	4	5	6	7	36.0	1.0	1.0	1.0	1.0	2.4	30.0	1.0	1.0	1.0	1.0	1.8	28.0	1.0	1.0	1.0	1.0	1.7	26.0	1.0	1.0	1.0	1.2	1.5	24.0	1.0	1.0	1.0	1.0	1.5	22.0	1.0	1.0	1.0	1.0	1.5	20.0	1.0	1.0	1.0	1.0	1.0	18.0	1.0	1.0	1.0	1.0	1.0	16.0	1.0	1.0	1.0	1.0	1.0	<p>Reveal dimensions were determined with an edge radius (of the door) of 1mm. Hinge dimensions and reveal calculation based on factory setting.</p> <p>IMPORTANT To determine the correct application Grass strongly recommends a trial mounting for all hinges and base plates.</p> <p>Drilling Distance (DD)</p> <table border="1"> <thead> <tr> <th>Door Thickness (DT)</th> <th>3</th> <th>4</th> <th>5</th> <th>6</th> <th>7</th> </tr> </thead> <tbody> <tr><td>36.0</td><td>10.5</td><td>10.0</td><td>8.6</td><td>7.6</td><td>6.7</td></tr> <tr><td>30.0</td><td>4.0</td><td>3.0</td><td>2.5</td><td>1.9</td><td>2.4</td></tr> <tr><td>28.0</td><td>2.0</td><td>1.5</td><td>1.5</td><td>1.3</td><td>1.3</td></tr> <tr><td>26.0</td><td>1.0</td><td>1.0</td><td>1.0</td><td>1.0</td><td>1.0</td></tr> <tr><td>24.0</td><td>0.6</td><td>0.6</td><td>0.6</td><td>0.6</td><td>0.6</td></tr> <tr><td>22.0</td><td>0.5</td><td>0.5</td><td>0.5</td><td>0.5</td><td>0.5</td></tr> <tr><td>20.0</td><td>0.3</td><td>0.3</td><td>0.3</td><td>0.3</td><td>0.3</td></tr> <tr><td>18.0</td><td>0.2</td><td>0.2</td><td>0.2</td><td>0.2</td><td>0.2</td></tr> <tr><td>16.0</td><td>0.2</td><td>0.2</td><td>0.2</td><td>0.2</td><td>0.2</td></tr> </tbody> </table> <p>Reveal (R)</p>	Door Thickness (DT)	3	4	5	6	7	36.0	10.5	10.0	8.6	7.6	6.7	30.0	4.0	3.0	2.5	1.9	2.4	28.0	2.0	1.5	1.5	1.3	1.3	26.0	1.0	1.0	1.0	1.0	1.0	24.0	0.6	0.6	0.6	0.6	0.6	22.0	0.5	0.5	0.5	0.5	0.5	20.0	0.3	0.3	0.3	0.3	0.3	18.0	0.2	0.2	0.2	0.2	0.2	16.0	0.2	0.2	0.2	0.2	0.2
Door Thickness (DT)	3	4	5	6	7																																																																																																																				
36.0	1.0	1.0	1.0	1.0	2.4																																																																																																																				
30.0	1.0	1.0	1.0	1.0	1.8																																																																																																																				
28.0	1.0	1.0	1.0	1.0	1.7																																																																																																																				
26.0	1.0	1.0	1.0	1.2	1.5																																																																																																																				
24.0	1.0	1.0	1.0	1.0	1.5																																																																																																																				
22.0	1.0	1.0	1.0	1.0	1.5																																																																																																																				
20.0	1.0	1.0	1.0	1.0	1.0																																																																																																																				
18.0	1.0	1.0	1.0	1.0	1.0																																																																																																																				
16.0	1.0	1.0	1.0	1.0	1.0																																																																																																																				
Door Thickness (DT)	3	4	5	6	7																																																																																																																				
36.0	10.5	10.0	8.6	7.6	6.7																																																																																																																				
30.0	4.0	3.0	2.5	1.9	2.4																																																																																																																				
28.0	2.0	1.5	1.5	1.3	1.3																																																																																																																				
26.0	1.0	1.0	1.0	1.0	1.0																																																																																																																				
24.0	0.6	0.6	0.6	0.6	0.6																																																																																																																				
22.0	0.5	0.5	0.5	0.5	0.5																																																																																																																				
20.0	0.3	0.3	0.3	0.3	0.3																																																																																																																				
18.0	0.2	0.2	0.2	0.2	0.2																																																																																																																				
16.0	0.2	0.2	0.2	0.2	0.2																																																																																																																				

Screw-on	Impresso and Dowelled	Cup dimensions
		<p>() Impresso</p>

Tiomos 110/90A

110° blind corner hinge for overlay doors



- For blind corner construction
- 110° opening angle
- 3-dimensional adjustment with suitable base plate
- Soft-close or Self-close hinges available
- Convenient depth adjustment with worm gear

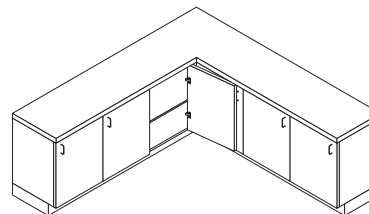

Tiomos 110/90A

Opening Angle 110°

Impresso

Screw-on

Dowelled

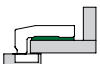
Overlay	Pattern	Type	Item No.	Pattern	Type	Item No.	Item No.	PU
 <p>Hinge cup: steel, nickel-plated Hinge arm: zinc, nickel-plated</p>	42 / 45	Soft-close	F017139426223	45	Soft-close	F028138535223	F028138545223	100
		Self-close	F034139397223		Self-close	F045138473223	F045138483223	100

Cover cap	Item No.	PU
 <p>Steel, nickel-plated</p>	F072135500247	1000

Hinge cup cover cap	Item No.	PU
 <p>Steel, nickel-plated</p>	F072135503228	150

Wood screw, nickel-plated	Item No.	PU
 <p>#6 x 5/8" FHP, NI</p>	81001-43	500

PU = packaging unit

Overlay

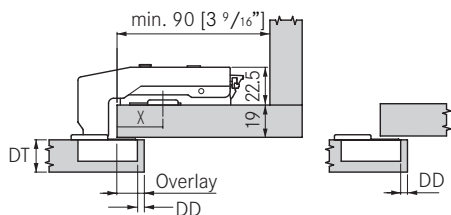

Drawing shows Tiomos with a base plate height (BPH) 00.

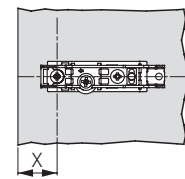
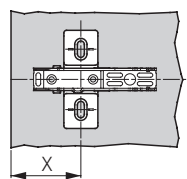

Cup Drilling Distance (DD)

Base Plate Drilling distance (X)	Cup Drilling Distance (DD)				
	3	4	5	6	7
30	18	19	20	21	22
29	17	18	19	20	21
28	16	17	18	19	20
27	15	16	17	18	19
28	14	15	16	17	18

Door Overlay

Cup Drilling Distance (DD)

Base Plate Drilling distance (X)	Cup Drilling Distance (DD)				
	3	4	5	6	7
13	18	19	20	21	22
12	17	18	19	20	21
11	16	17	18	19	20
10	15	16	17	18	19
9	14	15	16	17	18

Door Overlay

Minimum gaps

The minimum gap is the gap between the closed door and the front of the cabinet.

IMPORTANT

To determine the correct application Grass strongly recommends a trial mounting for all hinges and base plates.

Door Thickness (DT)	Drilling Distance (DD)					Minimum gap
	3	4	5	6	7	
24.0	1.0	1.0	1.0	1.2	2.1	
22.0	1.0	1.0	1.0	1.0	1.5	
21.0	1.0	1.0	1.0	1.0	1.2	
20.0	1.0	1.0	1.0	1.0	1.0	
19.0	1.0	1.0	1.0	1.0	1.0	
18.0	1.0	1.0	1.0	1.0	1.0	
17.0	1.0	1.0	1.0	1.0	1.0	
16.0	1.0	1.0	1.0	1.0	1.0	

Screw-on

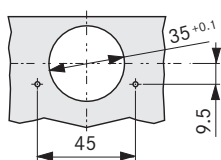

Dowelled

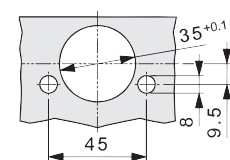

Impresso

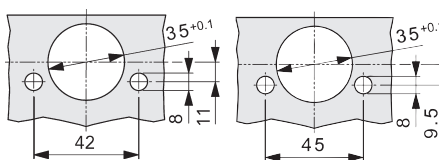

Cup dimensions

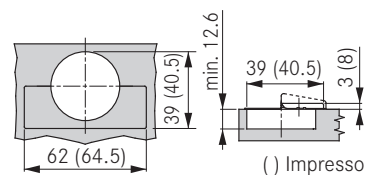

Tiomos 110/90E

110° blind corner hinge for inset doors



- For blind corner construction
- 110° opening angle
- 3-dimensional adjustment with suitable base plate
- Soft-close or Self-close hinges available
- Convenient depth adjustment with worm gear

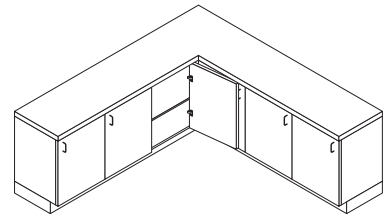

Tiomos 110/90E

Opening Angle 110°

Impresso

Screw-on

Dowelled

Inset	Pattern	Type	Item No.	Pattern	Type	Item No.	Item No.	PU
 <p>Hinge cup: steel, nickel-plated Hinge arm: zinc, nickel-plated</p>	42 / 45	Soft-close	F017139427223	45	Soft-close	F028138536223	F028138546223	100
		Self-close	F034139398223		Self-close	F045138474223	F045138484223	100

Cover cap	Item No.	PU
 <p>Steel, nickel-plated</p>	F072135500247	1000

Hinge cup cover cap	Item No.	PU
 <p>Steel, nickel-plated</p>	F072135503228	150

Wood screw, nickel-plated	Item No.	PU
 <p>#6 x 5/8" FHP, NI</p>	81001-43	500

PU = packaging unit

Inset

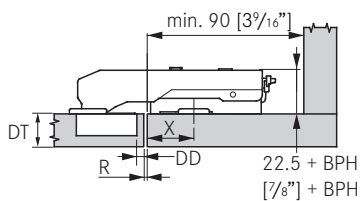

Drawing shows Tiomos with a base plate height (BPH) 03.

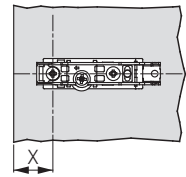
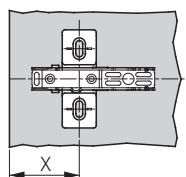

Base Plate Drilling distance (X)	Cup Drilling Distance (DD)				
	4	5	6	7	
28.0	1	0			
27.0	2	1	0		
26.0	3	2	1	0	
	Door reveal				

Base Plate Drilling distance (X)	Cup Drilling Distance (DD)				
	4	5	6	7	
11.0	1	0			
10.0	2	1	0		
9.0	3	2	1	0	
	Door reveal				

Reveal

Reveal dimensions were determined with an edge radius (of the door) of 1mm. Hinge dimensions and reveal calculation based on factory setting.

IMPORTANT

To determine the correct application Grass strongly recommends a trial mounting for all hinges and base plates.

Door Thickness (DT)	Drilling Distance (DD)					Reveal (R)
	3	4	5	6	7	
24.0	2.4	2.1	2.1	2.1	2.0	
22.0	1.6	1.6	1.6	1.5	1.5	
21.0	1.4	1.3	1.3	1.3	1.3	
20.0	1.1	1.1	1.1	1.1	1.1	
19.0	0.9	0.9	0.9	0.9	0.9	
18.0	0.7	0.7	0.7	0.7	0.7	
17.0	0.6	0.6	0.6	0.6	0.6	
16.0	0.6	0.6	0.6	0.6	0.6	
						Reveal (R)

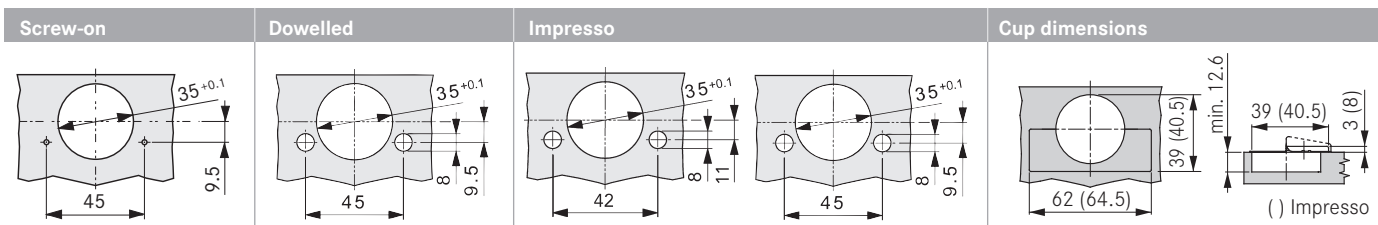

Tiomos 110/30A

+30° angle corner cabinet hinge for overlay doors



- For 30° angle corner cabinets
- 110° opening angle
- 3-dimensional adjustment with suitable base plate
- Soft-close or Self-close hinges available
- Convenient depth adjustment with worm gear

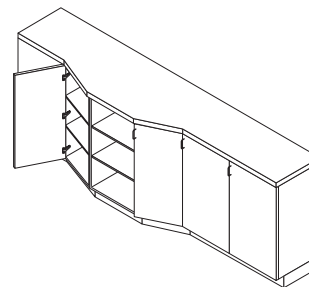

Tiomos 110/30A **Opening Angle 110°** **Impresso** **Screw-on** **Dowelled**

Overlay	Pattern	Type	Item No.	Pattern	Type	Item No.	Item No.	PU
 <p>Hinge cup: steel, nickel-plated Hinge arm: zinc, nickel-plated</p>	42 / 45	Soft-close	F017139420223	45	Soft-close	F028138529223	-	100
		Self-close	F034139391223		Self-close	F045138467223	-	100

Cover cap	Item No.	PU
 <p>Steel, nickel-plated</p>	F072135500247	1000

Hinge cup cover cap	Item No.	PU
 <p>Steel, nickel-plated</p>	F072135503228	150

Wood screw, nickel-plated	Item No.	PU
 <p>#6 x 5/8" FHP, NI</p>	81001-43	500

PU = packaging unit

Overlay

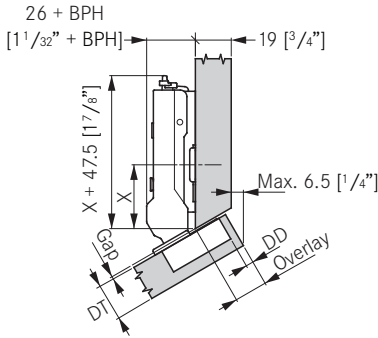

Drawing shows Tiomos with a base plate height (BPH) 0.

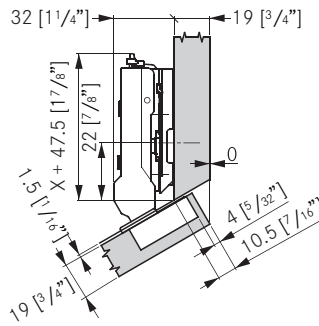

Drawing shows Tiomos with a base plate height (BPH) 6.

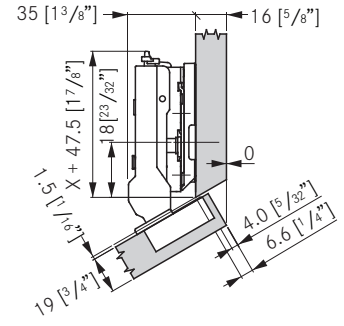

Drawing shows Tiomos with a base plate height (BPH) 9.5.

Door overlay	Drilling Distance (DD)				
	3	4	5	6	7
20.5					0
19.5				0	
18.5			0		2
17.5		0		2	3
16.5	0				3.5
16.0			2	3	
15.5				3.5	
15.0		2	3		
14.5			3.5		
14.0	2	3			
13.5		3.5			
13.0	3				
12.5	3.5			6	
11.5			6		
10.5	6				
	Base Plate Height (BPH)				

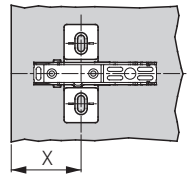

Base plate height

	0	2	3	3.5	6
X	34.0	33.0	32.0	32.0	30.5

Wing base plate position (X)

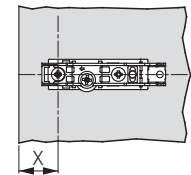

Base plate height

	0	2	3	3.5
X	17.0	16.0	15.0	15.0

Straight base plate position (X)

Minimum gaps

The minimum gap is the gap between the closed door and the front of the cabinet.

Door Thickness (DT)	Drilling Distance (DD)				
	3	4	5	6	7
24.0	1.0	1.0	1.0	1.2	2.1
22.0	1.0	1.0	1.0	1.0	1.5
21.0	1.0	1.0	1.0	1.0	1.2
20.0	1.0	1.0	1.0	1.0	1.0
19.0	1.0	1.0	1.0	1.0	1.0
18.0	1.0	1.0	1.0	1.0	1.0
17.0	1.0	1.0	1.0	1.0	1.0
16.0	1.0	1.0	1.0	1.0	1.0
	Minimum gap				

Reveal

Reveal dimensions were determined with an edge radius (of the door) of 1mm. Hinge dimensions and reveal calculation based on factory setting.

IMPORTANT

To determine the correct application Grass strongly recommends a trial mounting for all hinges and base plates.

Door Thickness (DT)	Drilling Distance (DD)				
	3	4	5	6	7
24.0	2.4	2.1	2.1	2.1	2.0
22.0	1.6	1.6	1.6	1.5	1.5
21.0	1.4	1.3	1.3	1.3	1.3
20.0	1.1	1.1	1.1	1.1	1.1
19.0	0.9	0.9	0.9	0.9	0.9
18.0	0.7	0.7	0.7	0.7	0.7
17.0	.06	.06	.06	.06	.06
16.0	.06	.06	.06	.06	.06
	Reveal (R)				

Screw-on

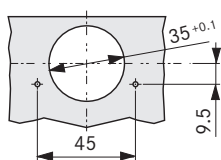

Impresso

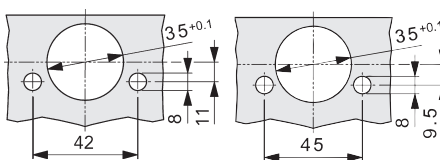

Cup dimensions

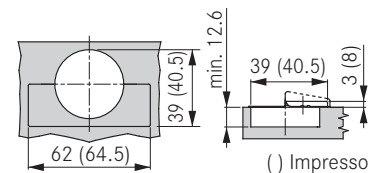

Tiomos 110/30E

+30° angle corner cabinet hinge for inset doors



- For 30° angle corner cabinets
- 110° opening angle
- 3-dimensional adjustment with suitable base plate
- Soft-close or Self-close hinges available
- Convenient depth adjustment with worm gear

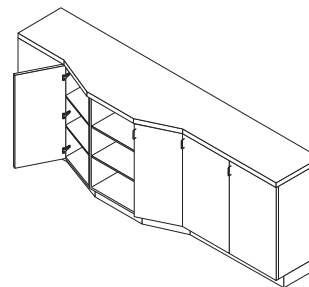

Tiomos 110/30E

Opening Angle 110°

Impresso

Screw-on

Dowelled

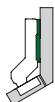
Inset	Pattern	Type	Item No.	Pattern	Type	Item No.	Item No.	PU
 <p>Hinge cup: steel, nickel-plated Hinge arm: zinc, nickel-plated</p>	42 / 45	Soft-close	F017139421223	45	Soft-close	F028138530223	-	100
		Self-close	F034139392223		Self-close	F045138468223	-	100

Cover cap	Item No.	PU
 <p>Steel, nickel-plated</p>	F072135500247	1000

Hinge cup cover cap	Item No.	PU
 <p>Steel, nickel-plated</p>	F072135503228	150

Wood screw, nickel-plated	Item No.	PU
 <p>#6 x 5/8" FHP, NI</p>	81001-43	500

PU = packaging unit

Inset

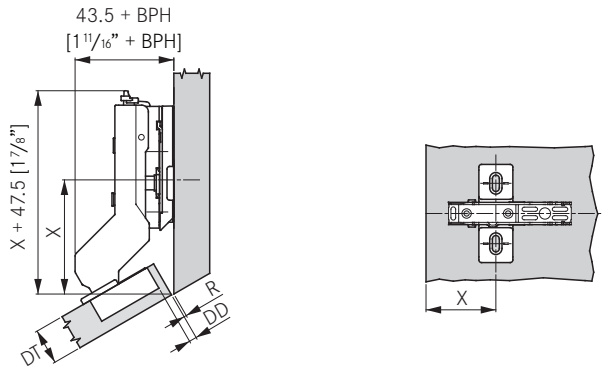

Drawing shows Tiomos with a base plate height (BPH) 9.5.

		Drilling Distance (DD)				
		3	4	5	6	7
Door thickness (DT)	22.0	9.5			12	
	21.0					
	20.0					12
	19.0		9.5			
	18.0					
	17.0			9.5		
	16.0				9.5	
	15.0	6				
		Base Plate Height (BPH)				

		Drilling Distance (DD)				
		3	4	5	6	7
Door thickness (DT)	22.0	63.5			61.5	
	21.0					
	20.0					60.0
	19.0		60.0			
	18.0					
	17.0				58.0	
	16.0					56.5
	15.0	57.5				
		Wing Base Plate position (X)				

Reveal

Reveal dimensions were determined with an edge radius (of the door) of 1mm. Hinge dimensions and reveal calculation based on factory setting.

		Drilling Distance (DD)				
		3	4	5	6	7
Door Thickness (DT)	24.0	2.4	2.1	2.1	2.1	2.0
	22.0	1.6	1.6	1.6	1.5	1.5
	21.0	1.4	1.3	1.3	1.3	1.3
	20.0	1.1	1.1	1.1	1.1	1.1
	19.0	0.9	0.9	0.9	0.9	0.9
	18.0	0.7	0.7	0.7	0.7	0.7
	17.0	0.6	0.6	0.6	0.6	0.6
	16.0	0.6	0.6	0.6	0.6	0.6
15.0	0.6	0.6	0.6	0.6	0.6	
		Reveal (R)				

IMPORTANT
To determine the correct application Grass strongly recommends a trial mounting for all hinges and base plates.

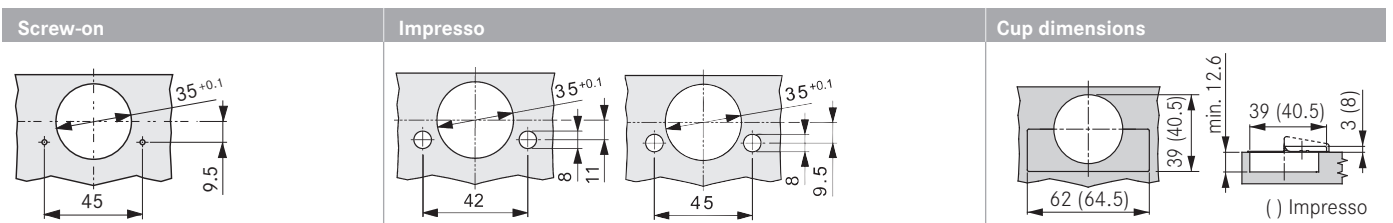

Tiomos 110/37A

+37° angle corner cabinet hinge for overlay doors



- For 37° angle corner cabinets
- 110° opening angle
- 3-dimensional adjustment with suitable base plate
- Soft-close or Self-close hinges available
- Convenient depth adjustment with worm gear

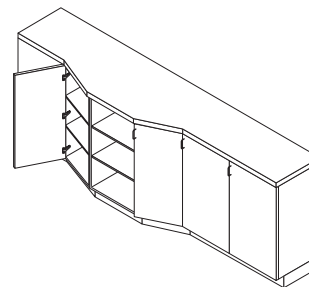

Tiomos 110/37A **Opening Angle 110°** **Impresso** **Screw-on** **Dowelled**

Overlay	Pattern	Type	Item No.	Pattern	Type	Item No.	Item No.	PU
 <p>Hinge cup: steel, nickel-plated Hinge arm: zinc, nickel-plated</p>	42 / 45	Soft-close	F01713942223	45	Soft-close	F028138531223	F028138541223	100
		Self-close	F034139393223		Self-close	F045138469223	F045138479223	100

Cover cap	Item No.	PU
 <p>Steel, nickel-plated</p>	F072135500247	1000

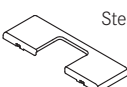
Hinge cup cover cap	Item No.	PU
 <p>Steel, nickel-plated</p>	F072135503228	150

Wood screw, nickel-plated	Item No.	PU
 <p>#6 x 5/8" FHP, NI</p>	81001-43	500

PU = packaging unit

Overlay

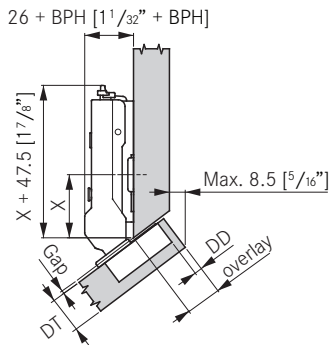

Drawing shows Tiomos with a base plate height (BPH) 0.

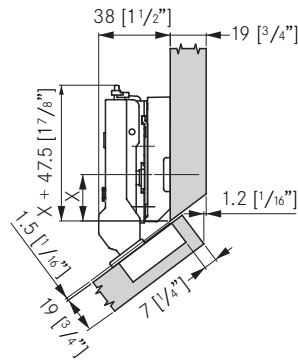

Drawing shows Tiomos with a base plate height (BPH) 12.

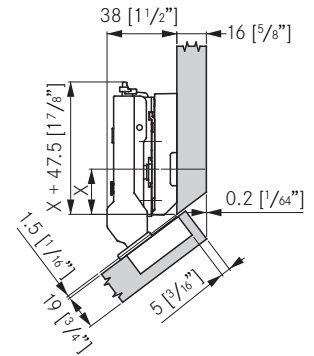

Drawing shows Tiomos with a base plate height (BPH) 12.

Drilling Distance (DD)

	3	4	5	6	7
21.5					0
21.0				0	
20.0			0		
19.0		0			
18.5				2	
18.0	0				3
17.5			2		
17.0				3	
16.5		2			
16.0			3		
15.5	2				
15.0		3			
14.5				6	
14.0	3				
13.0				6	
12.0			6		
11.0		6			
10.0	6				
Door overlay	Base Plate Height (BPH)				

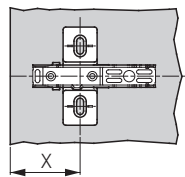

Base plate height

	0	2	3	3.5	6
X	33.5	32.0	31.0	31.0	29.0

Wing base plate position (X)

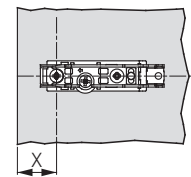

Base plate height

	0	2	3	3.5
X	16.5	15.0	14.0	14.0

Straight base plate position (X)

Minimum gaps

The minimum gap is the gap between the closed door and the front of the cabinet.

Drilling Distance (DD)

	3	4	5	6	7
24.0	1.0	1.0	1.0	1.2	2.1
22.0	1.0	1.0	1.0	1.0	1.5
21.0	1.0	1.0	1.0	1.0	1.2
20.0	1.0	1.0	1.0	1.0	1.0
19.0	1.0	1.0	1.0	1.0	1.0
18.0	1.0	1.0	1.0	1.0	1.0
17.0	1.0	1.0	1.0	1.0	1.0
16.0	1.0	1.0	1.0	1.0	1.0

Door Thickness (DT)

Minimum gap

Reveal

Reveal dimensions were determined with an edge radius (of the door) of 1mm. Hinge dimensions and reveal calculation based on factory setting.

IMPORTANT

To determine the correct application Grass strongly recommends a trial mounting for all hinges and base plates.

Drilling Distance (DD)

	3	4	5	6	7
24.0	2.4	2.1	2.1	2.1	2.0
22.0	1.6	1.6	1.6	1.5	1.5
21.0	1.4	1.3	1.3	1.3	1.3
20.0	1.1	1.1	1.1	1.1	1.1
19.0	0.9	0.9	0.9	0.9	0.9
18.0	0.7	0.7	0.7	0.7	0.7
17.0	.06	.06	.06	.06	.06
16.0	.06	.06	.06	.06	.06

Door Thickness (DT)

Reveal (R)

Screw-on

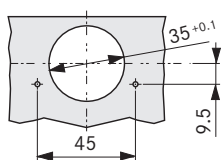

Dowelled

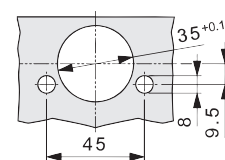

Impresso

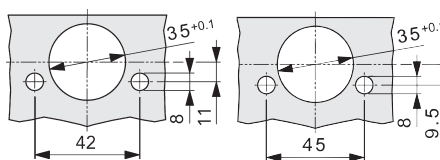

Cup dimensions

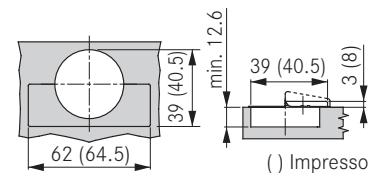

Tiomos 110/37E

+37° angle corner cabinet hinge for inset doors

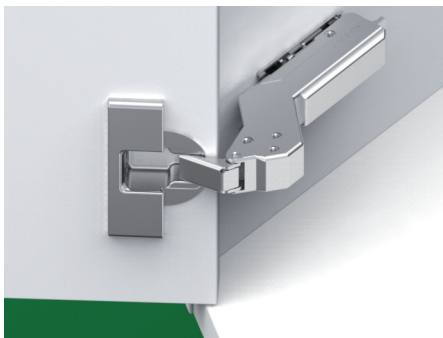

- For 37° angle corner cabinets
- 110° opening angle
- 3-dimensional adjustment with suitable base plate
- Soft-close or Self-close hinges available
- Convenient depth adjustment with worm gear

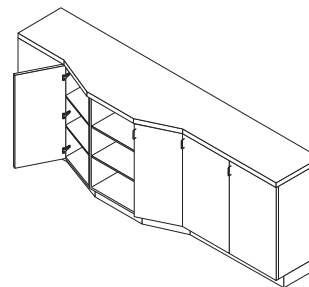

Tiomos 110/37E **Opening Angle 110°** **Impresso** **Screw-on** **Dowelled**

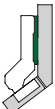
Inset	Pattern	Type	Item No.	Pattern	Type	Item No.	Item No.	PU
 <p>Hinge cup: steel, nickel-plated Hinge arm: zinc, nickel-plated</p>	42 / 45	Soft-close	F017139423223	45	Soft-close	F028138532223	-	100
		Self-close	F034139394223		Self-close	F045138470223	-	100

Cover cap	Item No.	PU
 <p>Steel, nickel-plated</p>	F072135500247	1000

Hinge cup cover cap	Item No.	PU
 <p>Steel, nickel-plated</p>	F072135503228	150

Wood screw, nickel-plated	Item No.	PU
 <p>#6 x 5/8" FHP, NI</p>	81001-43	500

PU = packaging unit

Inset

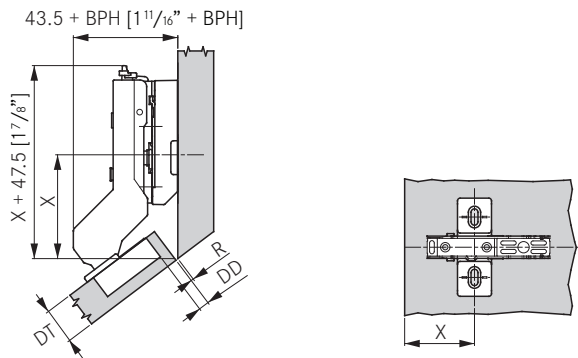

Drawing shows Tiomos with a base plate height (BPH) 12.

		Drilling Distance (DD)				
		3	4	5	6	7
Door thickness (DT)	22.0	12				
	21.0		12			
	20.0			12		
	19.0				12	
	18.0					12
	17.0	9.5				12
	16.0		9.5			
15.0						
		Base Plate Height (BPH)				

		Drilling Distance (DD)				
		3	4	5	6	7
Door thickness (DT)	22.0	59.0				
	21.0		57.5			
	20.0			56.5		
	19.0				55.0	
	18.0					53.0
	17.0	54.5				53.0
	16.0		53.0			
15.0						
		Wing Base Plate position (X)				

Reveal

Reveal dimensions were determined with an edge radius (of the door) of 1mm. Hinge dimensions and reveal calculation based on factory setting.

IMPORTANT

To determine the correct application Grass strongly recommends a trial mounting for all hinges and base plates.

		Drilling Distance (DD)				
		3	4	5	6	7
Door Thickness (DT)	22.0	1.6	1.6	1.6	1.5	1.5
	21.0	1.4	1.3	1.3	1.3	1.3
	20.0	1.1	1.1	1.1	1.1	1.1
	19.0	0.9	0.9	0.9	0.9	0.9
	18.0	0.7	0.7	0.7	0.7	0.7
	17.0	0.6	0.6	0.6	0.6	0.6
	16.0	0.6	0.6	0.6	0.6	0.6
15.0	0.6	0.6	0.6	0.6	0.6	
		Reveal (R)				

Screw-on

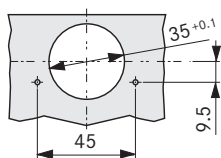

Impresso

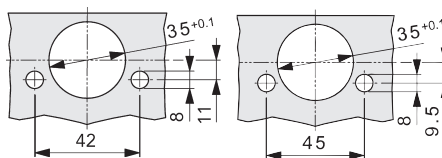

Cup dimensions

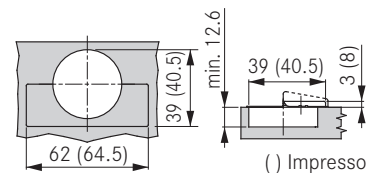

Tiomos 110/45A

+45° angle corner cabinet hinge for overlay doors



- For 45° angle corner cabinets
- 110° opening angle
- 3-dimensional adjustment with suitable base plate
- Soft-close or Self-close hinges available
- Convenient depth adjustment with worm gear

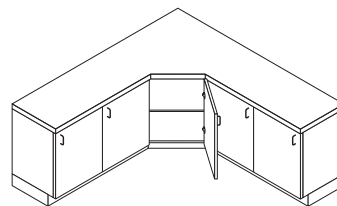

Tiomos 110/45A

Opening Angle 110°

Impresso

Screw-on

Dowelled

Overlay	Pattern	Type	Item No.	Pattern	Type	Item No.	Item No.	PU
 <p>Hinge cup: steel, nickel-plated Hinge arm: zinc, nickel-plated</p>	42 / 45	Soft-close	F017139424 223	45	Soft-close	F028138533 223	F028138543 223	100
		Self-close	F034139395 223		Self-close	F045138471 223	F045138481 223	100

Cover cap	Item No.	PU
 <p>Steel, nickel-plated</p>	F072135500 247	1000

Hinge cup cover cap	Item No.	PU
 <p>Steel, nickel-plated</p>	F072135503 228	150

Wood screw, nickel-plated	Item No.	PU
 <p>#6 x 5/8" FHP, NI</p>	81001-43	500

PU = packaging unit

Overlay

28 + BPH
 $[1\frac{1}{8} + \text{BPH}]$

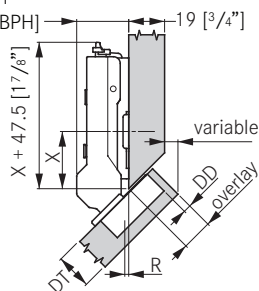

Drawing shows Tiomos with a base plate height (BPH) 0.

Drilling Distance (DD)

	3	4	5	6	7
19.5					0
19.0					
18.5				0	
18.0					
17.5		0			
17.0					
16.5		0		2	
16.0					
15.5	0			2	
15.0					3
14.5			2	3.5	
14.0				3	
13.5		2		3.5	
13.0			3		
12.5		2		3.5	
12.0			3		
11.0	3				6
10.0					6

Door overlay

Base Plate Height (BPH)

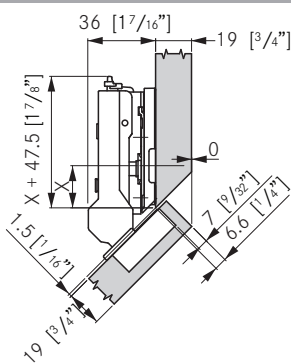

Drawing shows Tiomos with a base plate height (BPH) 9.5.

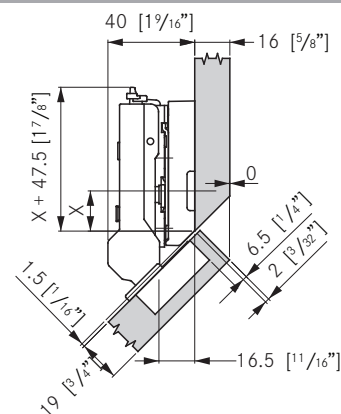

Drawing shows Tiomos with a base plate height (BPH) 12.

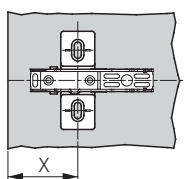

Base plate height

	.5	0	2	3	3.5	6	9.5	12
X	30.5	28.5	27.5	27.0	24.5	21.0	18.5	

Wing base plate position (X)

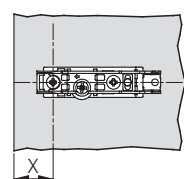

Base plate height

	0	2	3	3.5
X	13.5	11.5	10.5	10.0

Straight base plate position (X)

Minimum gaps

The minimum gap is the gap between the closed door and the front of the cabinet.

Door Thickness (DT)	Drilling Distance (DD)					Minimum gap
	3	4	5	6	7	
24.0	1.0	1.0	1.0	1.2	2.1	
22.0	1.0	1.0	1.0	1.0	1.5	
21.0	1.0	1.0	1.0	1.0	1.2	
20.0	1.0	1.0	1.0	1.0	1.0	
19.0	1.0	1.0	1.0	1.0	1.0	
18.0	1.0	1.0	1.0	1.0	1.0	
17.0	1.0	1.0	1.0	1.0	1.0	
16.0	1.0	1.0	1.0	1.0	1.0	

Reveal

Reveal dimensions were determined with an edge radius (of the door) of 1mm. Hinge dimensions and reveal calculation based on factory setting.

IMPORTANT

To determine the correct application Grass strongly recommends a trial mounting for all hinges and base plates.

Door Thickness (DT)	Drilling Distance (DD)					Reveal (R)
	3	4	5	6	7	
24.0	2.4	2.1	2.1	2.1	2.0	
22.0	1.6	1.6	1.6	1.5	1.5	
21.0	1.4	1.3	1.3	1.3	1.3	
20.0	1.1	1.1	1.1	1.1	1.1	
19.0	0.9	0.9	0.9	0.9	0.9	
18.0	0.7	0.7	0.7	0.7	0.7	
17.0	.06	.06	.06	.06	.06	
16.0	.06	.06	.06	.06	.06	

Screw-on

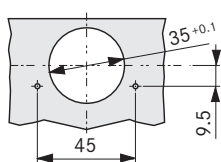

Dowelled

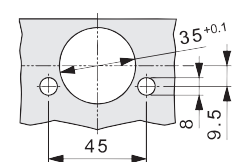

Impresso

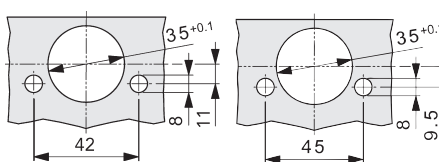

Cup dimensions

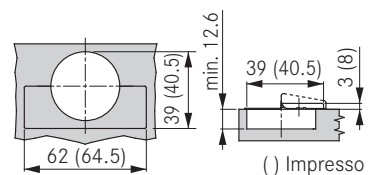

Tiomos 110/45E

+45° angle corner cabinet hinge for inset doors



- For 45° angle corner cabinets
- 110° opening angle
- 3-dimensional adjustment with suitable base plate
- Soft-close or Self-close hinges available
- Convenient depth adjustment with worm gear

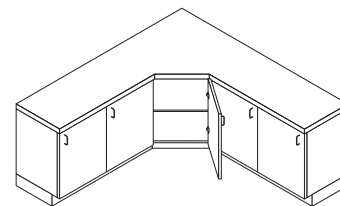

Tiomos 110/45E

Opening Angle 110°

Impresso

Screw-on

Dowelled

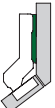
Inset	Pattern	Type	Item No.	Pattern	Type	Item No.	Item No.	PU
 <p>Hinge cup: steel, nickel-plated Hinge arm: zinc, nickel-plated</p>	42 / 45	Soft-close	F017139425223	45	Soft-close	F028138534223	F028138544223	100
		Self-close	F034139396223		Self-close	F045138472223	F045138482223	100

Cover cap	Item No.	PU
 <p>Steel, nickel-plated</p>	F072135500247	1000

Hinge cup cover cap	Item No.	PU
 <p>Steel, nickel-plated</p>	F072135503228	150

Wood screw, nickel-plated	Item No.	PU
 <p>#6 x 5/8" FHP, NI</p>	81001-43	500

PU = packaging unit

Inset

Corner Angle

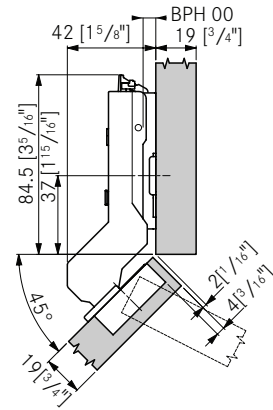
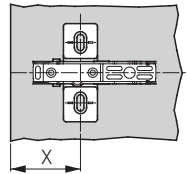
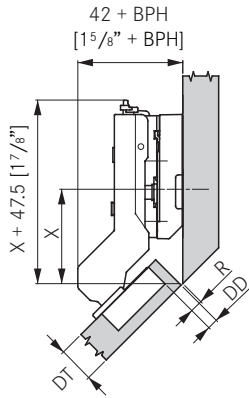

Drawing shows Tiomos with a base plate height (BPH) 12.

		Drilling Distance (DD)				
		3	4	5	6	7
Door thickness (DT)	22.0					
	21.0					
	20.0					
	19.0	12				
	18.0		12			
	17.0			12		
	16.0				12	
15.0					12	
		Base Plate Height (BPH)				

		Drilling Distance (DD)				
		3	4	5	6	7
Door thickness (DT)	22.0					
	21.0					
	20.0					
	19.0	52.0				
	18.0		50.5			
	17.0			49.0		
	16.0				47.5	
15.0					46.0	
		Wing Base Plate position (X)				

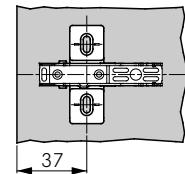

Reveal

Reveal dimensions were determined with an edge radius (of the door) of 1mm. Hinge dimensions and reveal calculation based on factory setting.

IMPORTANT

To determine the correct application Grass strongly recommends a trial mounting for all hinges and base plates.

		Drilling Distance (DD)					
		3	4	5	6	7	
Door Thickness (DT)	24.0	2.4	2.1	2.1	2.1	2.0	
	22.0	1.6	1.6	1.6	1.5	1.5	
	21.0	1.4	1.3	1.3	1.3	1.3	
	20.0	1.1	1.1	1.1	1.1	1.1	
	19.0	0.9	0.9	0.9	0.9	0.9	
	18.0	0.7	0.7	0.7	0.7	0.7	
	17.0	0.6	0.6	0.6	0.6	0.6	
16.0	0.6	0.6	0.6	0.6	0.6		
		Reveal (R)					

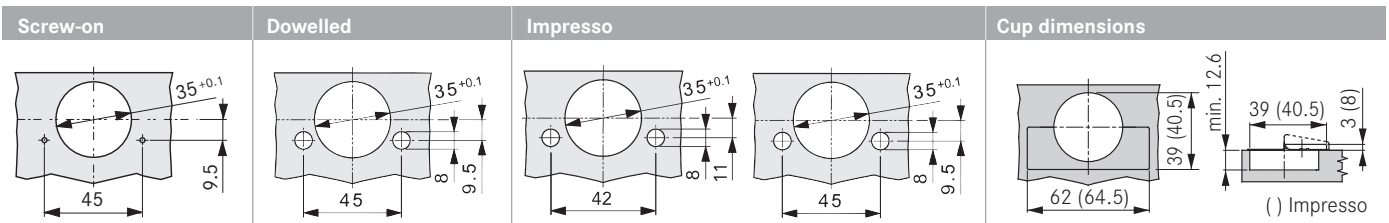

Tiomos 120/-15A

-15° angle corner cabinet hinge for overlay doors

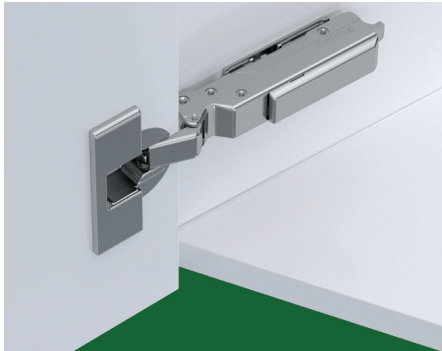

- For -15° angle corner cabinets
- 120° opening angle
- 3-dimensional adjustment with suitable base plate
- Soft-close or Self-close hinges available
- Convenient depth adjustment with worm gear

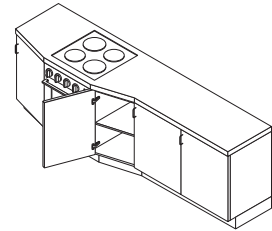

Tiomos 120/-15A Opening Angle 120° Impresso Screw-on Dowelled

Overlay	Pattern	Type	Item No.	Pattern	Type	Item No.	Item No.	PU
 <p>Hinge cup: steel, nickel-plated Hinge arm: zinc, nickel-plated</p>	42 / 45	Soft-close	F017139432223	45	Soft-close	F028138555223	-	100
		Self-close	F034139403223		Self-close	F045138493223	-	100

Cover cap	Item No.	PU
 <p>Steel, nickel-plated</p>	F072135500247	1000

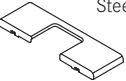
Hinge cup cover cap	Item No.	PU
 <p>Steel, nickel-plated</p>	F072135503228	150

Wood screw, nickel-plated	Item No.	PU
 <p>#6 x 5/8" FHP, NI</p>	81001-43	500

PU = packaging unit

Overlay

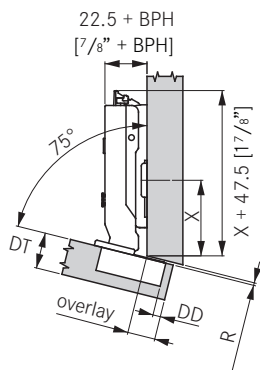

Drawing shows Tiomos with a base plate height (BPH) 0.

Door overlay	Drilling Distance (DD)				
	3	4	5	6	7
18.0					0
17.0				0	
16.0			0		
15.0		0			
14.5				2	3
14.0	0				3.5
13.5			2	3	
13.0				3.5	
12.5		2	3		
12.0			3.5		
11.5		3			6
11.0		3.5			
10.5	3				6
10.0	3.5				
9.5			6		
8.5		6			
	Base Plate Height (BPH)				

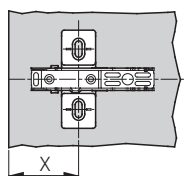

Base plate height

	0	2	3	3.5	6
X	40	40.5	40.5	41	41.5

Wing base plate position (X)

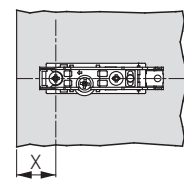

Base plate height

	0	2	3	3.5
X	23	23.5	23.5	24

Straight base plate position (X)

Reveal

Reveal dimensions were determined with an edge radius (of the door) of 1mm. Hinge dimensions and reveal calculation based on factory setting.

IMPORTANT

To determine the correct application Grass strongly recommends a trial mounting for all hinges and base plates.

Door Thickness (DT)	Drilling Distance (DD)					Reveal (R)
	3	4	5	6	7	
24.0	6.4	5.4	4.4	3.4	2.4	
22.0	3.0	2.0	1.5	1.5	1.5	
21.0	1.4	1.3	1.3	1.3	1.3	
20.0	1.1	1.1	1.1	1.1	1.1	
19.0	0.9	0.9	0.9	0.9	0.9	
18.0	0.7	0.7	0.7	0.7	0.7	
17.0	1.0	1.0	1.0	1.0	1.5	
16.0	1.0	1.0	1.0	1.0	1.0	

Screw-on	Impresso	Cup dimensions
		<p>() Impresso</p>

Tiomos 120/-30A

-30° angle corner cabinet hinge for overlay doors



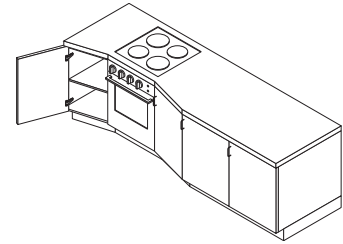

- For -30° angle corner cabinets
- 120° opening angle
- 3-dimensional adjustment with suitable base plate
- Soft-close or Self-close hinges available
- Convenient depth adjustment with worm gear

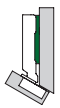

Tiomos 120/-30A Opening Angle 120° Impresso Screw-on Dowelled

Overlay	Pattern	Type	Item No.	Pattern	Type	Item No.	Item No.	PU
 <p>Hinge cup: steel, nickel-plated Hinge arm: zinc, nickel-plated</p>	42 / 45	Soft-close	F017139433223	45	Soft-close	F028138556223	-	100
		Self-close	F034139404223		Self-close	F045138494223	-	100

Cover cap	Item No.	PU
 <p>Steel, nickel-plated</p>	F072135500247	1000

Hinge cup cover cap	Item No.	PU
 <p>Steel, nickel-plated</p>	F072135503228	150

Wood screw, nickel-plated	Item No.	PU
 <p>#6 x 5/8" FHP, NI</p>	81001-43	500

PU = packaging unit

Overlay

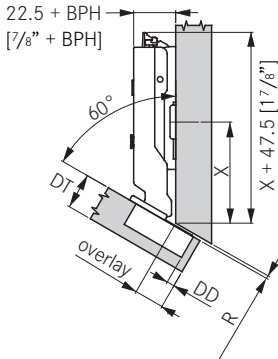

Drawing shows Tiomos with a base plate height (BPH) 02.

Door overlay	Drilling Distance (DD)				
	3	4	5	6	7
19.0					0
18.0			0		
17.0			0		
16.5				2	
16.0		0			
15.5				2	
15.0	0				3
14.5			2		3.5
14.0				3	
13.5		2		3.5	
13.0			3		
12.5	2		3.5		
12.0		3			6
11.5		3.5			
11.0	3				6
10.5		3.5			
10.0			6		
9.0		6			
8.0	6				
	Base Plate Height (BPH)				

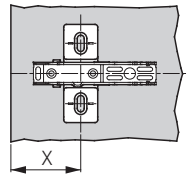

Base plate height

	0	2	3	3.5	6
X	53.5	55	55.5	55.5	57

Wing base plate position (X)

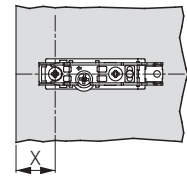

Base plate height

	0	2	3	3.5	
X	36.5	38	38.5	38.5	

Straight base plate position (X)

Reveal

Reveal dimensions were determined with an edge radius (of the door) of 1mm. Hinge dimensions and reveal calculation based on factory setting.

IMPORTANT

To determine the correct application Grass strongly recommends a trial mounting for all hinges and base plates.

Door Thickness (DT)	Drilling Distance (DD)					Reveal (R)
	3	4	5	6	7	
24.0	6.4	5.4	4.4	3.4	2.4	
22.0	3.0	2.0	1.5	1.5	1.5	
21.0	1.4	1.3	1.3	1.3	1.3	
20.0	1.1	1.1	1.1	1.1	1.1	
19.0	0.9	0.9	0.9	0.9	0.9	
18.0	0.7	0.7	0.7	0.7	0.7	
17.0	1.0	1.0	1.0	1.0	1.5	
16.0	1.0	1.0	1.0	1.0	1.0	

Screw-on	Impresso	Cup dimensions
		<p>() Impresso</p>

Tiomos 120/-45A

-45° angle corner cabinet hinge for overlay doors



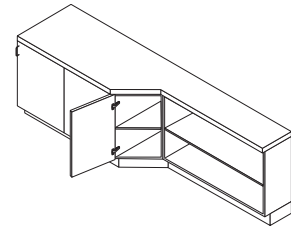

- For -45° angle corner cabinets
- 120° opening angle
- 3-dimensional adjustment with suitable base plate
- Soft-close or Self-close hinges available
- Convenient depth adjustment with worm gear

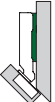

Tiomos 120/-45A Opening Angle 120° Impresso Screw-on Dowelled

Overlay	Pattern	Type	Item No.	Pattern	Type	Item No.	Item No.	PU
 <p>Hinge cup: steel, nickel-plated Hinge arm: zinc, nickel-plated</p>	42 / 45	Soft-close	F017139434223	45	Soft-close	F028138557223	-	100
		Self-close	F034139405223		Self-close	F045138495223	-	100

Cover cap	Item No.	PU
 <p>Steel, nickel-plated</p>	F072135500247	1000

Hinge cup cover cap	Item No.	PU
 <p>Steel, nickel-plated</p>	F072135503228	150

Wood screw, nickel-plated	Item No.	PU
 <p>#6 x 5/8" FHP, NI</p>	81001-43	500

PU = packaging unit

Overlay

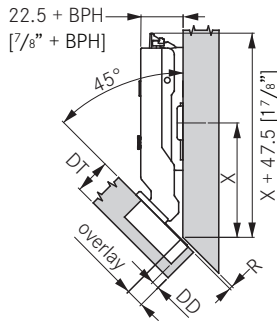

Drawing shows Tiomos with a base plate height (BPH) 02.

Door overlay	Drilling Distance (DD)				
	3	4	5	6	7
12.0					0
11.5				0	
10.5			0		
9.5		0		2	
8.5	0			2	
8.0				3	
7.5			2	3.5	
7.0				3	
6.5		2		3.5	
6.0			3		
5.5	2		3.5		
5.0		3			
4.5		3.5			
4.0	3				6
3.5	3.5				
3.0				6	
2.0			6		
1.0		6			
0.0	6				
	Base Plate Height (BPH)				

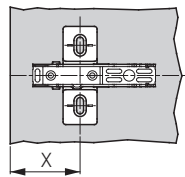

Base plate height

	0	2	3	3.5	6
X	60.5	62.5	63.5	64	66.5

Wing base plate position (X)

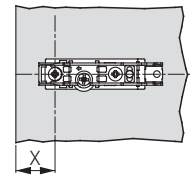

Base plate height

	0	2	3	3.5	
X	43.5	45.5	46.5	47	

Straight base plate position (X)

Reveal

Reveal dimensions were determined with an edge radius (of the door) of 1mm. Hinge dimensions and reveal calculation based on factory setting.

IMPORTANT

To determine the correct application Grass strongly recommends a trial mounting for all hinges and base plates.

Door Thickness (DT)	Drilling Distance (DD)					Reveal (R)
	3	4	5	6	7	
24.0	6.4	5.4	4.4	3.4	2.4	
22.0	3.0	2.0	1.5	1.5	1.5	
21.0	1.4	1.3	1.3	1.3	1.3	
20.0	1.1	1.1	1.1	1.1	1.1	
19.0	0.9	0.9	0.9	0.9	0.9	
18.0	0.7	0.7	0.7	0.7	0.7	
17.0	1.0	1.0	1.0	1.0	1.5	
16.0	1.0	1.0	1.0	1.0	1.0	

Screw-on

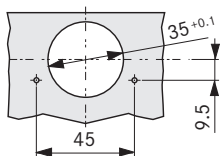

Impresso

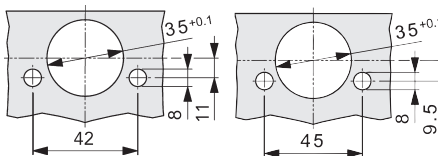

Cup dimensions

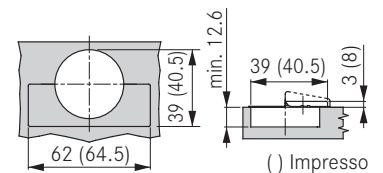

Tiomos PCC

Pie-cut corner cabinet hinge

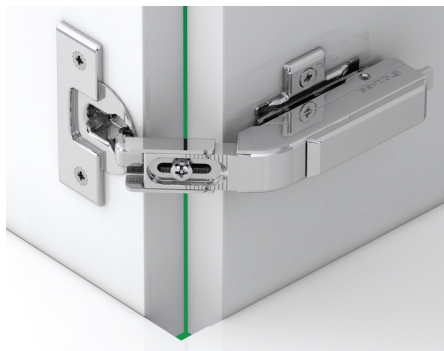

- 3-dimensional adjustment with suitable base plate
- Designed for connecting two folding doors in corner cabinet
- For door thicknesses 16 to 24 mm
- Self-close hinges available
- Used in conjunction with Tiomos 160 hinges
- 35 mm full cup drill hole

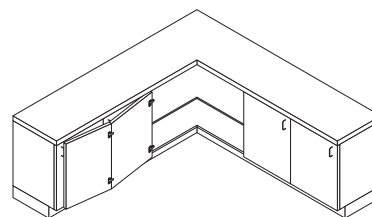

Tiomos PCC **Screw-on** **Dowelled**

Overlay	Pattern	Type	Item No.	Item No.	PU
 <p>Hinge cup: steel, nickel-plated Hinge arm: zinc, nickel-plated</p>	42	Self-close	-	F045138336228	150
	45	Self-close	F045138517228	F045138518228	150

Cover cap	Item No.	PU
 <p>Steel, nickel-plated</p>	F072135500247	1000

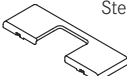
Hinge cup cover cap	Item No.	PU
 <p>Steel, nickel-plated</p>	F072135503228	150

Wood screw, nickel-plated	Item No.	PU
 <p>#6 x 5/8" FHP, NI</p>	81001-43	500

PU = packaging unit

Hinge Application

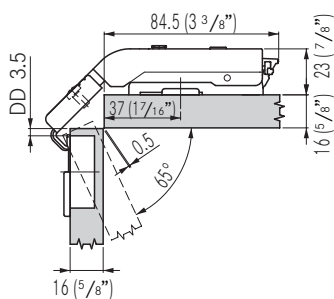

16mm door thickness with base plate height 0

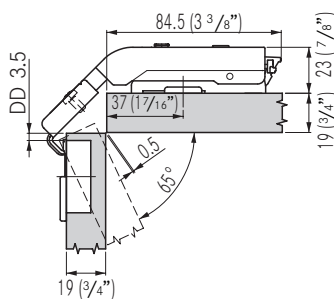

19mm door thickness with base plate height 0

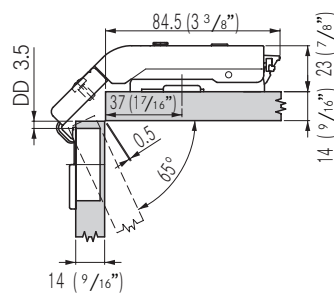

14mm door thickness with base plate height 0

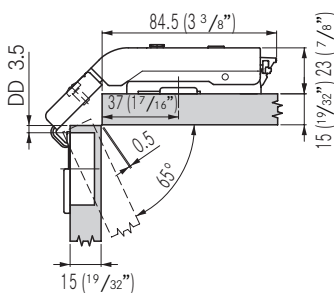

15mm door thickness with base plate height 0

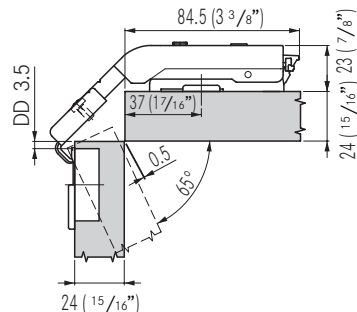

24mm door thickness with base plate height 0

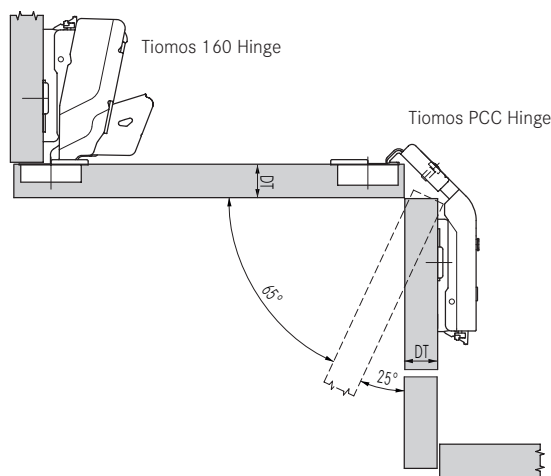
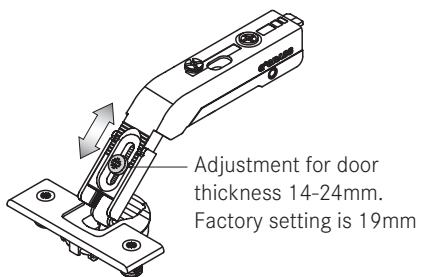

DD = Drilling Distance
DT = Door Thickness

Screw-on	Dowelled	Cup dimensions
		<p>() Impresso</p>

Tiomos base plates

For Tiomos hinges

Tiomos wing base plates

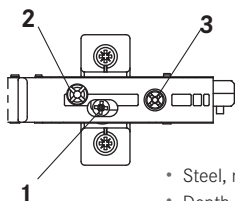

- Steel, nickel plated
- Depth adjustment via worm gear
- Height adjustment via worm gear or elongated hole
- Side adjustment via hinge
- Use a #2 Pozi drive screwdriver for hinge adjustment
- Attach base plates using all available screw holes

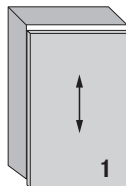

Height adjustment via base plate
Via worm gear ± 2 mm
Via elongated holes ± 2.5 mm

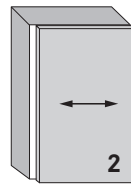

Side Adjustment
 ± 2 mm

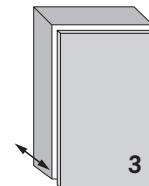

Depth adjustment
 $+3/-2$ mm

All adjustment options can be made independently of one another.

Wing base plate, 4 point fixing

37/32

For wood screws

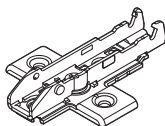

- Height adjustment via worm gear

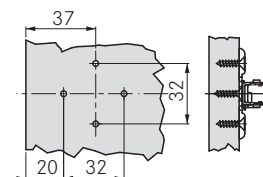

Height	Item No.	PU
0	F058139746 228	150
2	F058139747 228	150
3	F058139748 228	150
3.5	F058139749 228	150

Wing base plate, 4 point fixing

37/32

For Euro screws

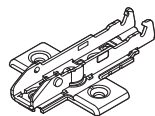

- Height adjustment via worm gear

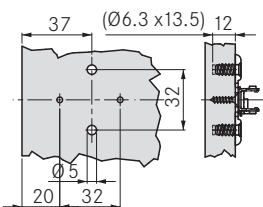

Height	Item No.	PU
0	F058139756 228	150
2	F058139757 228	150
3	F058139758 228	150
3.5	F058139759 228	150

Wing base plate, 4 point fixing

37/32

With pre-mounted Euro screws (13.5 mm)

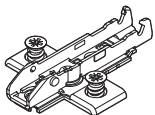

- Height adjustment via worm gear

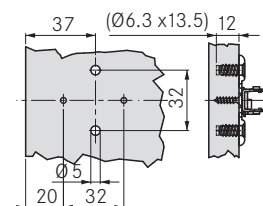

Height	Item No.	PU
0	F058139761 228	150
2	F058139762 228	150
3	F058139763 228	150
3.5	F058139764 228	150

Wing base plate, 4 point fixing

37/32

With pre-mounted Euro screws (10 mm)

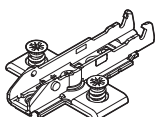

- Height adjustment via worm gear
- For twin application

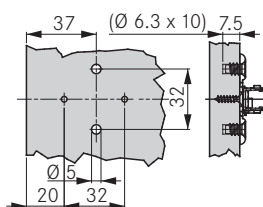

Height	Item No.	PU
0	F058139863 228	150
2	F058139864 228	150
3	F058139865 228	150
3.5	F058139866 228	150

PU = packaging unit

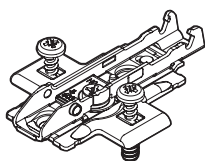
Wing steel base plate, 4 point fixing
37/32
Expanding dowels (5mm)

- Height adjustment via worm gear

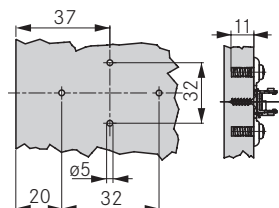

Height	Item No.	PU
0	F058139766 228	150
2	F058139767 228	150
3	F058139768 228	150

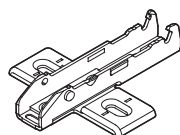
Wing steel base plate, 3 point fixing
37/32
For wood screws

- Height adjustment via elongated screw holes

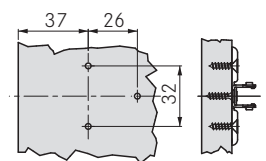

Height	Item No.	PU
0	F058139721 228	150
2	F058139722 228	150
3	F058139723 228	150
3.5	F058139724 228	150

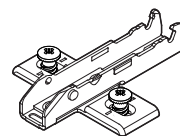
Wing steel base plate, 3 point fixing
37/32
With pre-mounted euro screws (13.5 mm)

- Height adjustment via elongated screw holes

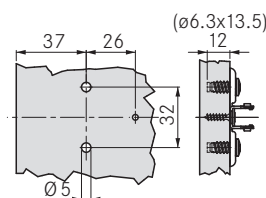

Height	Item No.	PU
0	F058139736 228	150
2	F058139737 228	150
3	F058139738 228	150
3.5	F058139739 228	150

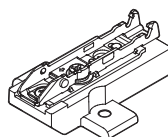
Wing base plate, 2 point fixing
37/32
For wood screws

- Zinc die-cast/Steel, nickel plated
- Height adjustment via worm gear

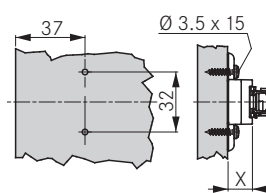

Height(x)	Item No.	PU
6	F058139892 217	50
9.5	F058139888 217	50
12	F058139893 217	50
19	F058139894 217	50
21	F058139895 217	50

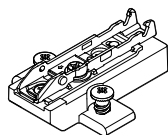
Wing base plate, 2 point fixing
37/32
With pre-mounted euro screws (13.5 mm)

- Zinc die-cast/Steel, nickel plated
- Height adjustment via worm gear

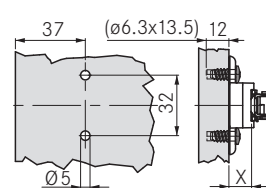

Height(x)	Item No.	PU
6	F058139873 217	50
9.5	F058139882 217	50
12	F058139874 217	50
19	F058139875 217	50
21	F058139896 217	50

PU = packaging unit

Tiomos base plates

For Tiomos hinges

Tiomos straight base plates

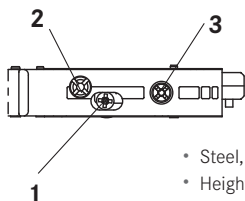

- Steel, nickel plated
- Height and depth adjustment via worm gear
- Side adjustment via hinge
- Use a #2 Pozzi drive screwdriver for hinge adjustment
- Attach base plates using all available screw holes

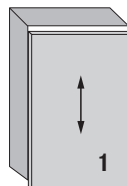

Height adjustment via base plate
Via worm gear ± 2 mm

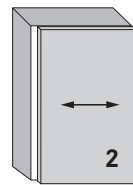

Side Adjustment
 ± 2 mm

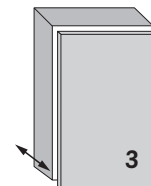

Depth adjustment
 $+3/-2$ mm

All adjustment options can be made independently of one another.

Straight base plate, 2 point fixing

20/32

For wood screws

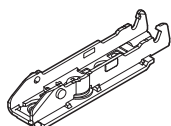

- Height adjustment via worm gear

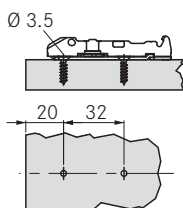

Height	Item No.	PU
0	F059139701 228	150
2	F059139702 228	150
3	F059139703 228	150

Straight base plate, 2 point fixing

20/32

With pre-mounted Euro screws

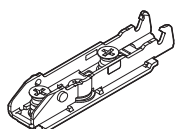

- Height adjustment via worm gear

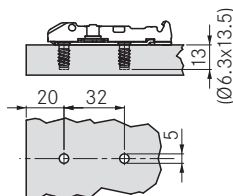

Height	Item No.	PU
0	F059139711 228	150
2	F059139712 228	150
3	F059139713 228	150

+5° Wedge for screw fixing

37/32

For wood screws

- Zinc, nickel plated
- For placing under wing mounting plates
- Can be stacked (max. 3)

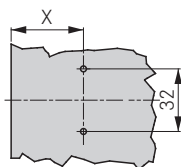
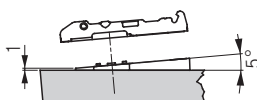

Height	Item No.	PU
3	F072135757 217	50

-5° Wedge for screw fixing

37/32

For wood screws

- Zinc, nickel plated
- For placing under wing mounting plates
- Cannot be stacked

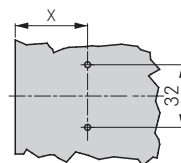
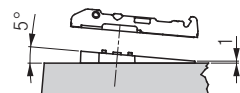

Height	Item No.	PU
3	F072135758 217	50

PU = packaging unit

Tiomos face frame adapter plates

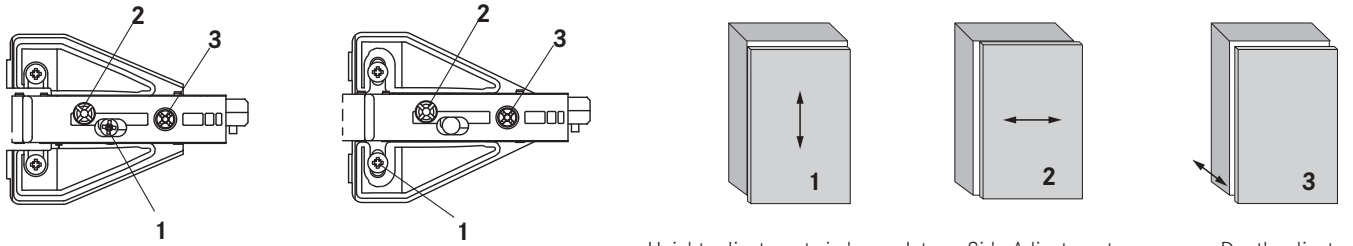

- Steel, nickel plated
- Depth adjustment via worm gear
- Height adjustment via worm gear or elongated hole
- Side adjustment via hinge
- Use a #2 Pozzi drive screwdriver for hinge adjustment
- Attach base plates using all available screw holes

Height adjustment via base plate
Via worm gear ± 2 mm
Via elongated holes ± 2.5 mm

Side Adjustment
 ± 2 mm

Depth adjustment
 $+3/-2$ mm

All adjustment options can be made independently of one another.

FFA base plate, 2 point fixing

9.5/32

For wood screws

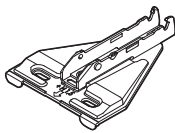

- Height adjustment via elongated screw holes

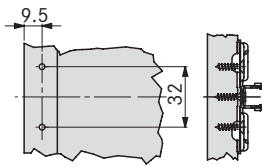

Height	Item No.	PU
1.5	F058139821228	150
3.5	F058139822228	150
4.5	F058139823228	150
5	F058139824228	150

FFA base plate, 2 point fixing

9.5/32

For wood screws

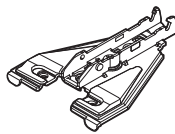

- Height adjustment via worm gear

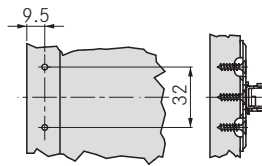

Height	Item No.	PU
1.5	F058139825228	150
3.5	F058139826228	150
4.5	F058139827228	150
5	F058139828228	150

FFAL base plate with flange, 4 point fixing

9.5/32

For wood screws

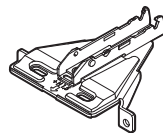

- Height adjustment via elongated screw holes

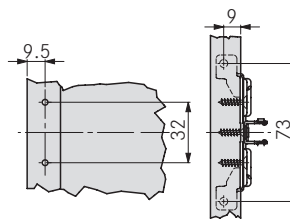

Height	Item No.	PU
3.5	F058139829228	150
5	F058139830228	150

Inset FFA base plate, 3 point fixing

10/32

For wood screws

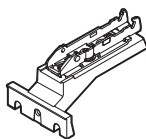

- Steel, diecast, nickel plated
- Height adjustment via worm gear
- Note: Requires a 9.5 crank hinge (half-overlay)

		Drilling Distance (DD)			
		3	4	5	6
Door Thickness (DT)	28.0	4.0			
	26.0	4.0	3.0		
	24.0	4.0	3.0	2.0	
	22.0	4.0	3.0	2.0	
	20.0	4.0	3.0	2.0	1.0
	19.0	4.0	3.0	2.0	1.0
	18.0	4.0	3.0	2.0	1.0
16.0	4.0	3.0	2.0	1.0	
		Reveal (R)			

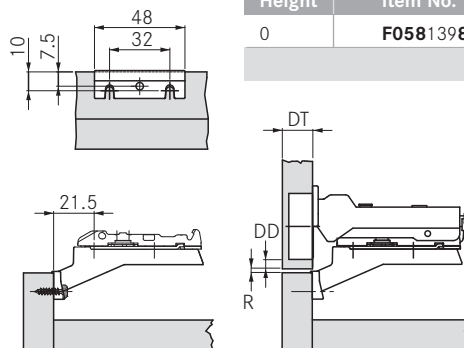

Height	Item No.	PU
0	F058139831228	150

PU = packaging unit

Tipmatic

For handle-free wooden doors



- Gently tapping the front causes the doors to open to a convenient angle
- Any free-swing hinges can be used
- Large magnet catch range – closes doors reliably
- Gap adjustment from 2.5 to 5.5 mm with integrated, self-locking and toolless depth adjustment feature
- Mount on the front side of the cabinet or with an adapter plate

Tipmatic pin For drilling



- Incl. Tipmatic mechanism (hole edge cover 1 mm)
- Stick on strike plate
- Screw on strike plate
- Hole drilled from the front
- Plastic RAL 7036, platinum grey

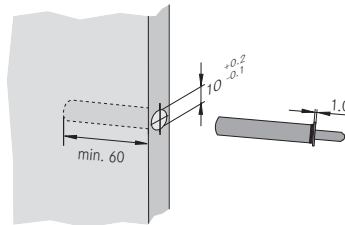

Item No.	PU
68873-06	25

Line Boring Adapter plate For Euro screws



- Suitable for line boring 28 and 37 mm
- Attach with Euro screws (6.3 x 13.5)
- Plastic RAL 7035, light grey

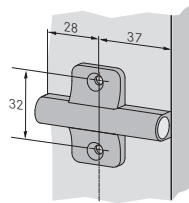

Item No.	PU
63310-40	25

Standard adapter plate For wood screws



- Quick upgrade installation
- Attach with wood screws (3.5 x 13)
- Plastic RAL 7035, light grey

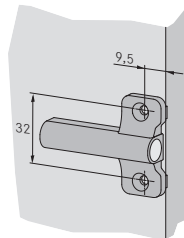

Item No.	PU
63311-40	25

Linear adapter plate For wood screws



- Design solution – also suitable for insets
- Attach with wood screws (3.5 x 13)
- Plastic RAL 7035, light grey

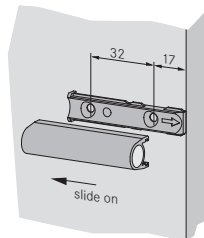

Item No.	PU
63309-40	25

PU = packaging unit

Mounting for full and half overlay wooden doors

Mounting on front side

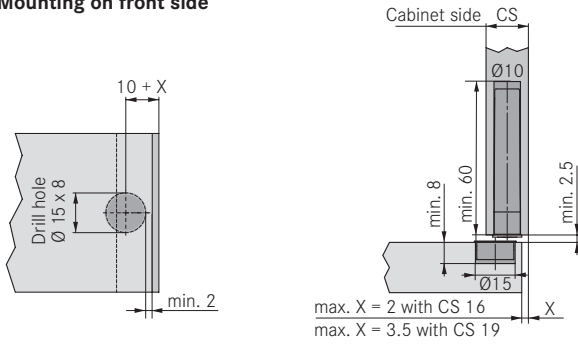

Mounting with adapter plates

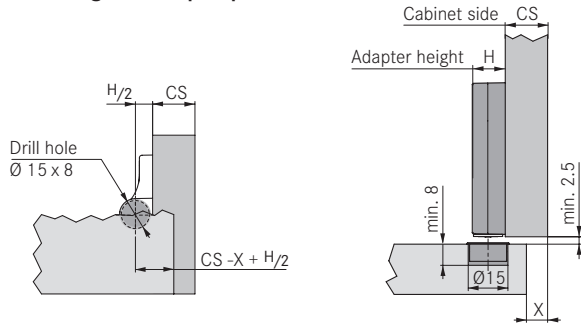

Mounting for inset wooden doors

Mounting with linear adapter plate

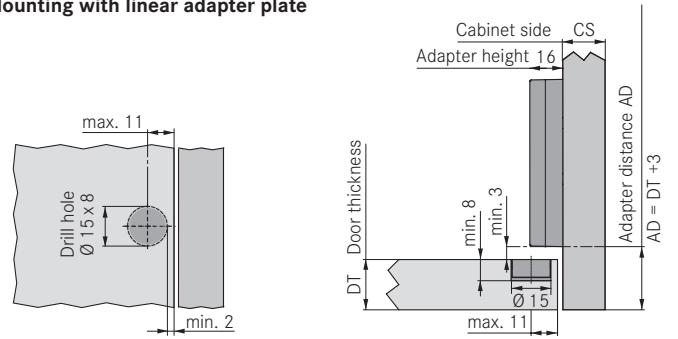

Tiomos Accessories

Angle reduction clips

Opening angle reduction clip to 85°



Steel, nickel

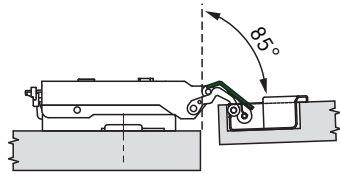

Works for all Tiomos 110° and 120° standard hinges. Reduces the opening angle to 85° to prevent doors from bumping fronts or walls in corner installations.

Item No.	PU
F072135751517	50

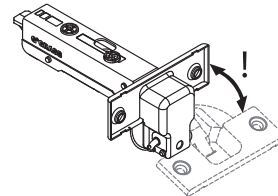
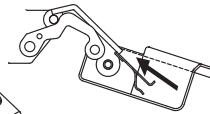
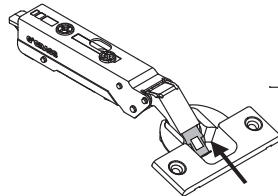
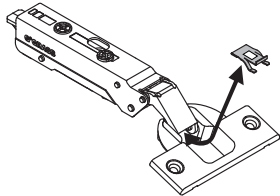

Opening angle reduction clip to 120°

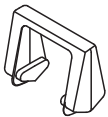

Black plastic

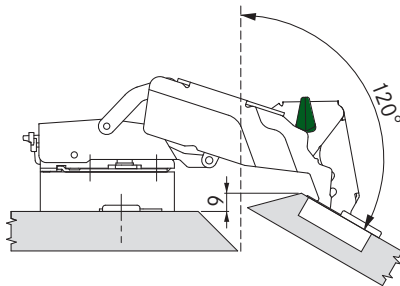

Works for all Tiomos 160° standard hinges. Reduces the opening angle to 120° to prevent doors from bumping the cabinet side in inset and mitered corner applications.

Item No.	PU
F072135753117	50

Hinge clip protector

Steel, nickel

Prevents accidental release of the hinge from the base plate. For use in lockers, wardrobes, office furniture or similar applications.

Item No.	PU
F072135807540	500

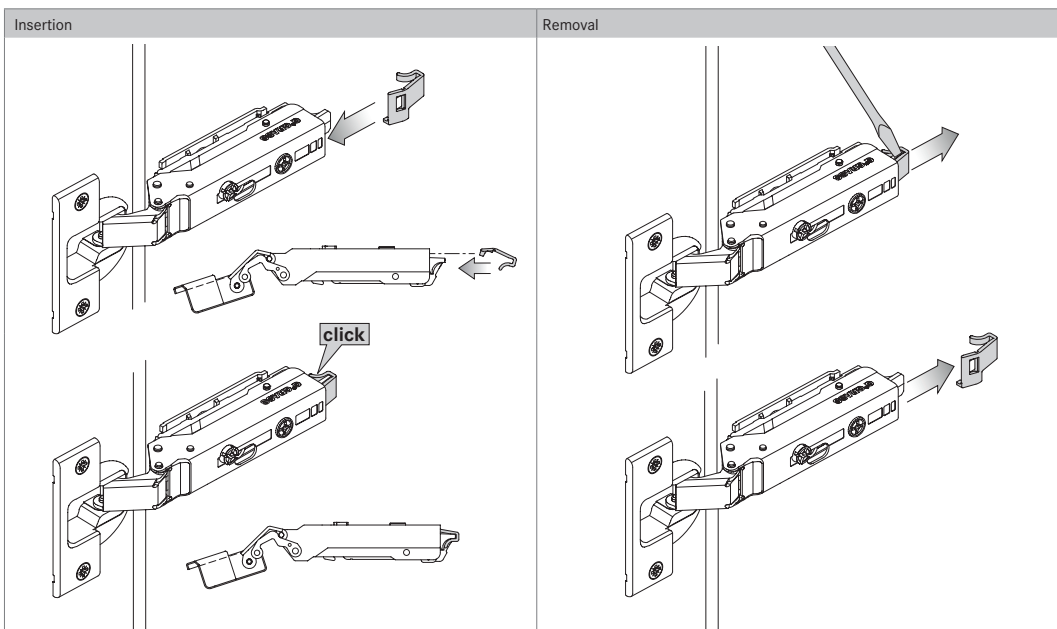

PU = packaging unit

Cover caps

Hinge arm cover cap

For all crankings

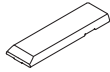

Steel, nickel plated, without imprint*

Item No.	PU
F072135500247	1000

Hinge arm cover cap, long

For 00 and 03 Cranking only

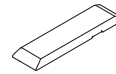

Steel, nickel plated, without imprint*

Item No.	PU
F072135504247	1000

* Imprinting available upon special request

Hinge cup cover cap

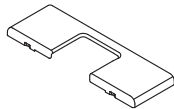

Steel, nickel plated

Item No.	PU
F072135503228	150

Screws

Euro screw, nickel-plated

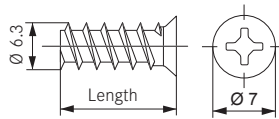

Description	Item No.	PU
13mm Euro Screw (1/2")	81015-43	500
18mm Euro Screw (11/16")	83000-43	500
7.5mm Euro Screw (5/16")	83001-43	500

Wood screw, nickel-plated

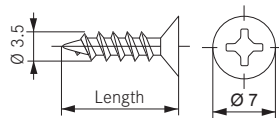

Description	Item No.	PU
#6 x 1/2" FHP, NI	81014-43	500
#6 x 7/16" FHP, NI	81016-43	500
#6 x 5/8" FHP, NI	81001-43	500
#6 x 3/4" FHP, NI	81003-43	500
#6 x 1" FHP, NI	81004-43	500

Pozidrive screwdriver

#2 Pozidrive screwdriver for hinges



Description	Item No.	PU
Pozidrive screwdriver	98000-01	1
Pozidrive screwdriver	98000-08	50

PU = packaging unit

GRASS PRO1

Drilling and insertion machine for 45mm boring pattern



- Bore depth automatically adjusts to material thickness
- Functional design
- Easy, fast and efficient operation
- Easy maintenance
- 45 mm boring pattern

Motor configuration	Item No.	PU
220v single phase pneumatic	94559-01	1
220v three phase pneumatic	94560-01	1

Adjustable hold-down devices

Adjustable hold-down devices are suitable for a wide range of material thicknesses. Holds door firmly in place for drilling and insertion and features manual release.

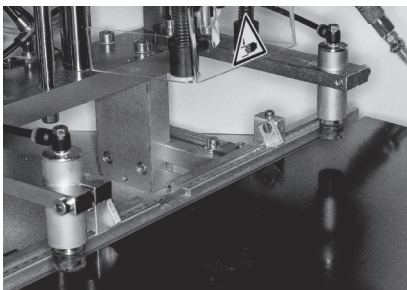

Pneumatic controls

Two-hand start button controls for safe drilling and insertion functions.

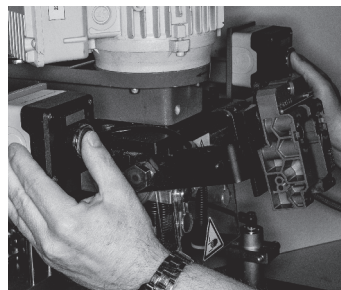

Quick change chucks

Easy drill bit removal and insertion using quick change chucks.

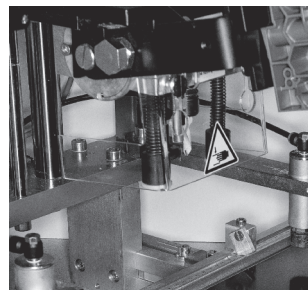

PU = packaging unit

Carbide drill bits for GRASSPRO1



Diameter	Direction	Item no.	PU
35 mm	RH	00077-01	1
8 mm	LH	00160-01	1



Bit set for hinge drilling	Item no.	PU
1 x 35 mm/RH, 2 x 8 mm/LH	00213-01	1

Additional stops for GRASSPRO1

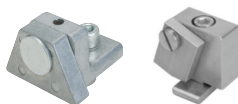

Description	Item no.	PU
Additional fence stop	949.200.21.0000	1
Universal fence stop	949.200.21.0100	1

Insertion dies for GRASSPRO1

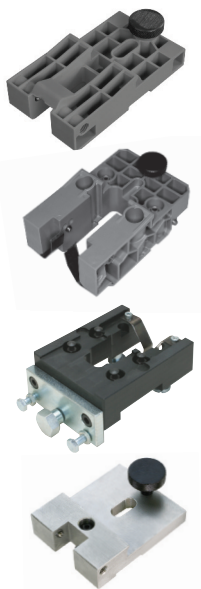

Description	Item no.	PU
Tiomos 110°/120°	F146101310201	1
Universal Die for Tiomos 110°/120°/160°	F146101308201	1
Nexis 110°/125°	04216-01	1
Nexis 170°	04218-01	1
TEC Die for all cup styles	92617	1

Extension fence 400mm to 1650mm



Description	Item no.	PU
Extension fence 400mm to 1650 mm	88612-01	1

PU = packaging unit

Assembly Hardware

Shelf Supports

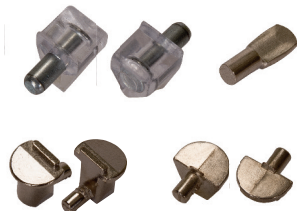

Description	Item No.	PU
Plastic, clear, with steel pin	499.582.50.0050	5000
Metal spoon, nickel plated	499.582.50.2050	2000
Shelf support 7006/9.5, nickel	517.206.64.1015	2500
Shelf support 7035, nickel	517.206.61.0015	2500
H-802 plastic, square, clear	00036-43	500

Bumper Pads

AIRSOFT Bumper Pads, plastic, round



Description	Item No.	PU
AirsSoft Bumper pad, 2.5mm, clear	63480-99	480
AirsSoft Bumper pad, 2.5mm, clear	63482-30	5000
AirsSoft Bumper pad, 5mm, clear	63481-43	500
AirsSoft Bumper pad, 5mm, clear	63483-30	5000

Self-adhesive Bumper Pads



Description	Item No.	PU
Self-adhesive bumper pad, clear, 7mm	630.000.03.0750	1088
Self-adhesive bumper pad, clear, 10mm	630.000.03.1050	1050
Self-adhesive bumper pad, clear, 12mm	630.000.02.1250	5000

Bumper Pads



Description	Item No.	PU
Bumper pad, round, clear, 3mm	31002-43	500
Bumper pad, round, clear, 1.5mm	31004-43	500

Bumper Pads

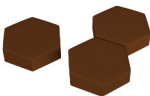

Description	Item No.	PU
Bumper pad, hexagonal, butterscotch, 3mm	00464-43	500

Cover Caps



Description	Item No.	PU
35mm cover cap, white	22227-42	100
35mm cover cap, almond	22228-42	100
35mm cover cap, brown	22229-42	100

Door Stop



Description	Item No.	PU
H-950 door stop, clear	00068-43	500

PU = packaging unit

GRASS GPS Calculator



For Tiomos

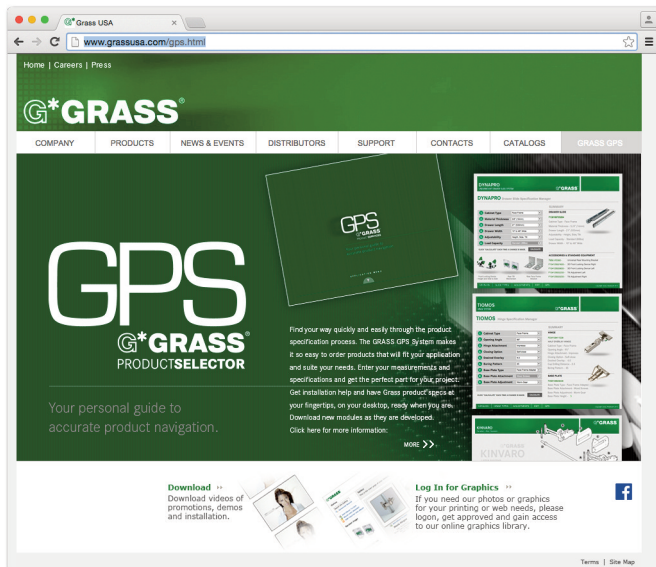

Introducing the Tiomos Hinge Calculator!

The Tiomos GPS takes the guess work out of choosing hinges

Determine which Tiomos hinge works best for your application. Choose the hinge type and enter the door specifications. The Tiomos Calculator will help you determine the best selection of hinge and base plate that should be used for your cabinet type and overlay selection. The calculator also provides the product number for ordering.

Intuitive Interface

Fill in answers for nine simple questions and the GPS will simply calculate and provide appropriate information for your application.

The Tiomos Calculator provides you with hinge and base plate options, part descriptions, item numbers and adjustment instructions.

Download the Calculator

- Download the GRASS GPS at www.grassusa.com/gps
- Unzip the file
- Select Hinge Finder
- Select Calculate
- Enter info and Calculate!

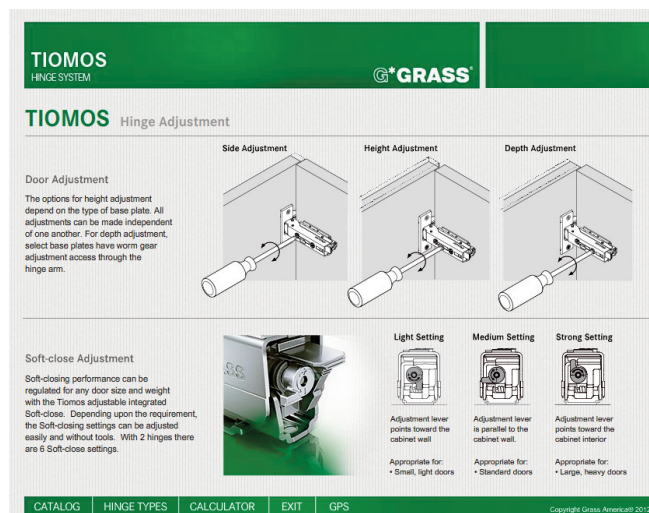



GRASS America Inc.
1202 NC Highway 66 South
Kernersville, NC 27284

Phone: 1-800-334-3512
Fax: 1-800-525-8406

Website: www.grassusa.com
E-mail: info@grassusa.com

GRASS Canada Inc.
10 Newgale Gate, Unit 7
Toronto, ON M1X 1C5

Phone 1-800-461-4975
Fax 1-416-335-5907

Internet: www.grasscanada.com
E-Mail: info@grasscanada.com



www.grassusa.com