



an **S** **B** **P** brand



**KANSAS CITY  
MILLWORK CATALOG**

## ABOUT AMERHART

For more than 80 years, Amerhart has worked to build a business designed around the needs of building materials dealers. In that time, Amerhart has grown geographically. We have become a Specialty Building Products (SBP) brand and added distribution brands like **Alexandria Moulding and USL Direct**. This has expanded our product and service offerings, and aligns with our philosophy to meet a standard of trust and responsiveness that is unmatched in the industry. Today the SBP brand family serves over 15,000 customer locations in the United States and Canada with more than 50 categories of unique specialty building products.



Amerhart is a "values" based organization, governed by a culture of respect, honoring people first, and operating according to a true moral compass aimed at doing what is right. Amerhart diligently extends that circle to each of our employees, our customers, our suppliers and everyone that we encounter in the business.

## COMMITMENT TO MILLWORK

Amerhart can proudly say that we are happy to expand into the millwork segment as we continue to stay relevant and deliver legendary customer service. The combination of U.S. Lumber, Alexandria Moulding and USL Direct makes Amerhart part of one of the largest distributors of Moulding and Millwork in North America with a total millwork inventory that exceeds any competitor. With 4 Alexandria Moulding manufacturing locations we have the assurance of continued supply and the opportunity to deliver made to order product solutions. With USL Direct, we can also offer direct and reload options for high volume buyers of commodities such as manufacturers, door shops, and consolidated dealers. Amerhart is positioned to effectively address every need in our market for moulding products.

## OUR PEOPLE

Our buyers, sellers and Millwork Managers are dedicated, career, millwork professionals. Buyers are working to consolidate our purchases and coordinate them with the largest manufacturers in the world to bring to market the highest quality products at the most competitive pricing. Millwork Salespeople and Millwork Managers work locally in each market to keep a clear focus on the individual product and service needs of customers in each region. With over 5000 different items in stock, our branch inventories are finely tuned with the right mix of profiles, substrates and finishes to meet the unique architectural and traditional applications for the area. These dedicated millwork professionals are the best and most local resource for technical and market information.



Amerhart is working tirelessly to be an essential part of your business.



**CEILING**

CROWN/BED 05

COVE 06

**DOOR & WINDOW**

CASING 07

BRICK MOULD & STOP 09

JAMBS & STOOL 10

**FLOOR**

BASE 12

QUARTER ROUND, BASE CAP & BASE SHOE 14

**GENERAL PURPOSE**

FULL ROUND, HAND RAIL, LATTICE, MANTEL & SCREEN 15

**PATTERN STOCK & BOARDS**

SHIPLAP & NICKEL GAP 17

**S4S**

S4S BOARDS/ S4S STOCKS & SQUARE 18

**WALL**

CHAIR RAIL & PANEL MOULD 19

CORNER 20

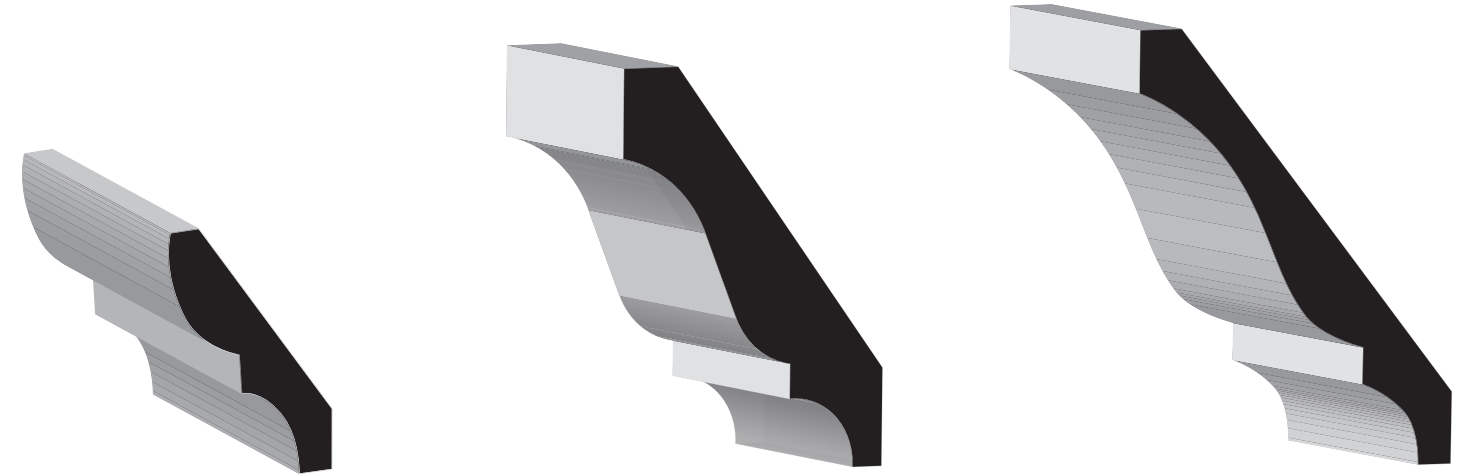

SKU	Crown/Bed	
74	9/16" X 1-3/4"	Clear
		Wall: 1-7/16" & Ceiling: 1"

SKU	Crown/Bed	
L51	9/16" X 3-1/4"	Finger Joint, Primed, Clear
		Wall: 2-5/8" & Ceiling: 1-7/8"

SKU	Crown/Bed	
L48	9/16" X 4-1/4"	Finger Joint, Primed, Clear
		Wall: 3-5/16" & Ceiling: 2-5/8"

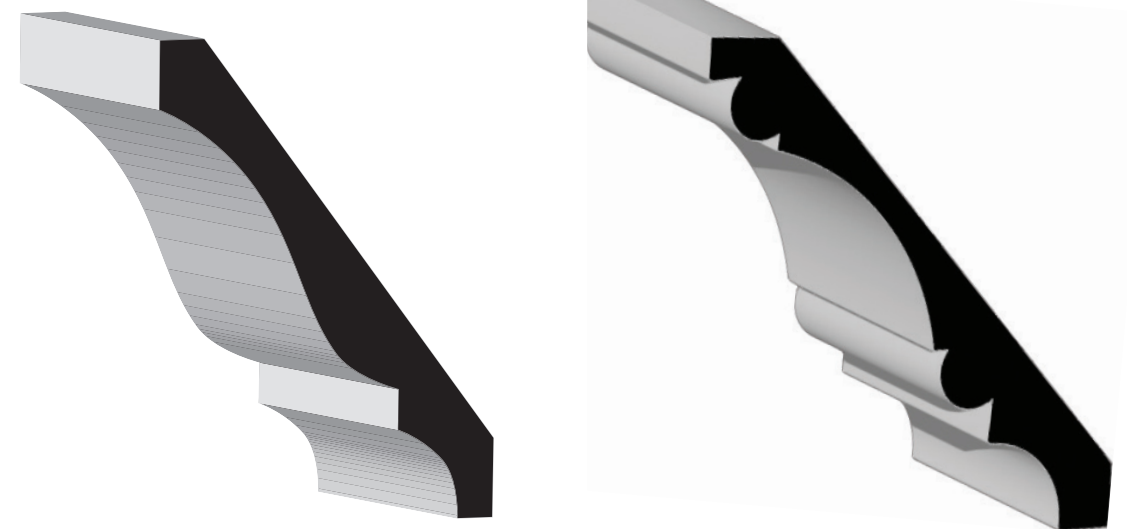

SKU	Crown/Bed	
L45	9/16" X 5-1/4"	Primed
		Wall: 4-1/16" & Ceiling: 3-3/8"

SKU	Crown/Bed	
825	11/16" X 5-1/4"	Primed
		Wall: 3-3/8" & Ceiling: 2-5/8"

CEILING - COVE

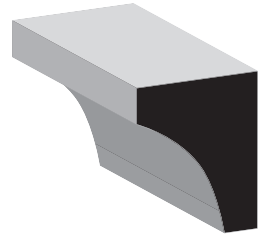

SKU	Cove	
93	3/4" X 3/4"	Clear



SKU	Cove	
81	9/16" X 3-1/4"	Primed
	 Wall: 2-5/8" & Ceiling 1-7/8"	



SKU	Cove	
519	9/16" X 4-1/4"	Primed, PMDF
	 Wall: 3-5/16" & Ceiling 2-5/8"	

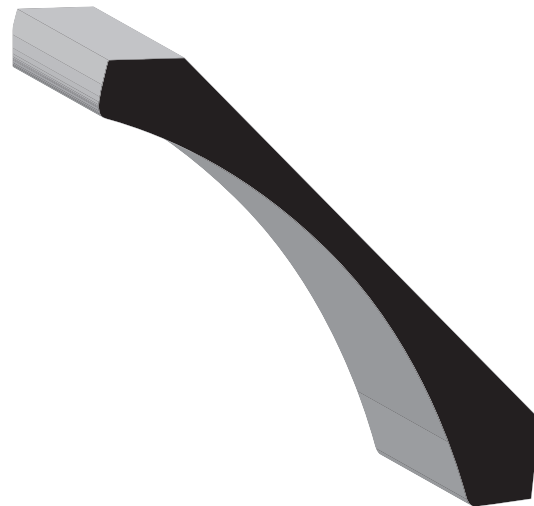

SKU	Cove	
653	11/16" X 5-1/4"	Primed
	 Wall: 4-1/16" & Ceiling: 3-15/16"	

DOOR & WINDOW - CASING



SKU	Casing	
347	11/16" X 2-1/4"	Finger Joint, Primed
	11/16" X 2-1/4" - 7'	Primed

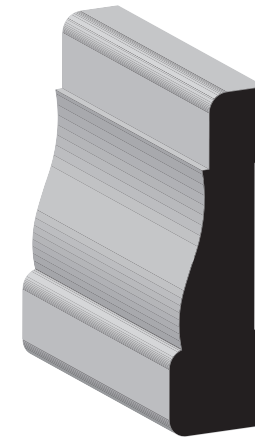

SKU	Casing	
356	11/16" X 2-1/4"	Finger Joint, Primed, Clear
	11/16" X 2-1/4" - 85"	Finger Joint
	11/16" X 2-1/4" - 7'	Clear

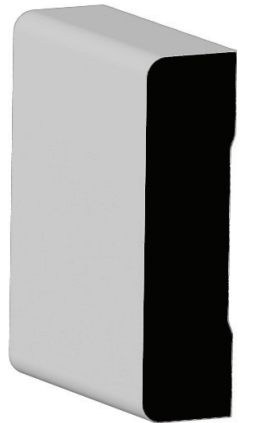

SKU	Casing	
453	11/16" X 2-1/4"	Primed
	11/16" X 2-1/4" - 86"	Primed
	5/8" X 2-1/4"	PMDF

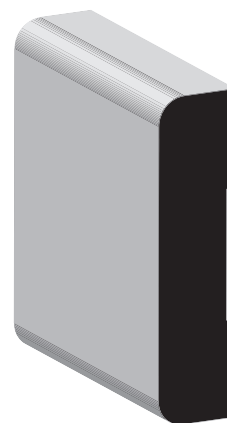

SKU	Casing	
473	9/16" X 2-1/4"	Finger Joint, Primed
	9/16" X 2-1/4" - 85"	Finger Joint, Primed



SKU	Casing	
351	11/16" X 2-1/2"	Clear

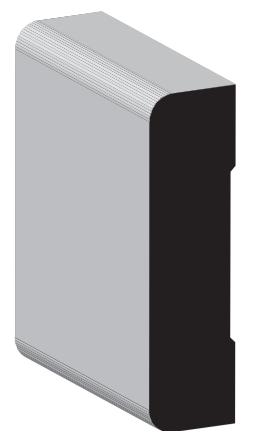

SKU	Casing	
452	11/16" X 2-1/2"	Primed

DOOR & WINDOW - CASING

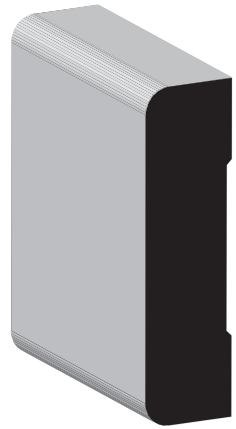

SKU	Casing	
472	9/16" X 2-1/2"	Primed



SKU	Casing	
433	9/16" X 3-1/4"	Primed



SKU	Casing	
413	11/16" X 3-1/4"	Finger Joint
	11/16" X 3-1/4" - 88"	Finger Joint

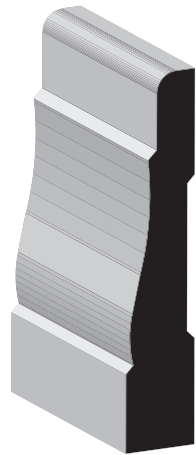

SKU	Casing	
L444	11/16" X 3-1/4"	Finger Joint, Primed, Clear
	11/16" X 3-1/4" - 86"	Primed
	11/16" X 3-1/4" - 87"	Clear



SKU	Casing	
L745	3/4" X 3-1/4"	Primed



SKU	Casing	
432	9/16" X 3-1/2"	Primed

DOOR & WINDOW - BACK BAND, BRICK MOULD & STOP

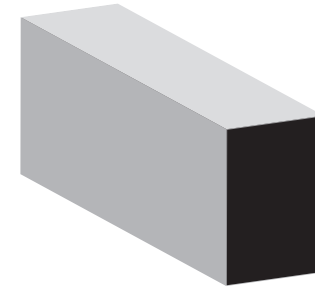

SKU	Parting Stop	
254	1/2" X 3/4"	Clear

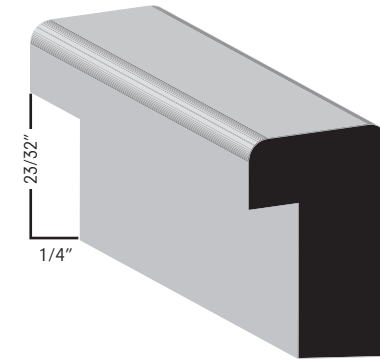

SKU	Back Band	
280	11/16" X 1-1/16"	Clear, Primed

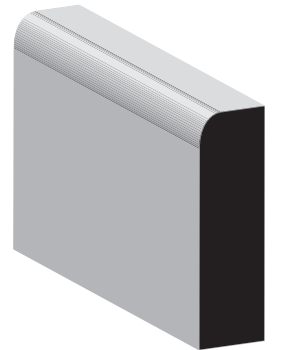

SKU	Stop	
887	3/8" X 1-1/4"	Primed

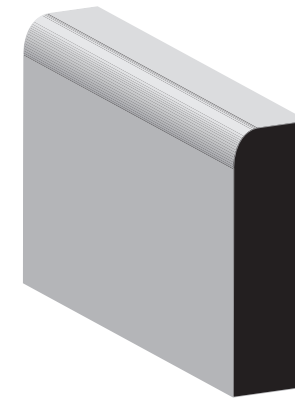

SKU	Stop	
876	7/16" X 1-3/8" - 7'	Primed
	7/16" X 1-3/8" - 102"	Primed
	7/16" X 1-3/8"	Clear

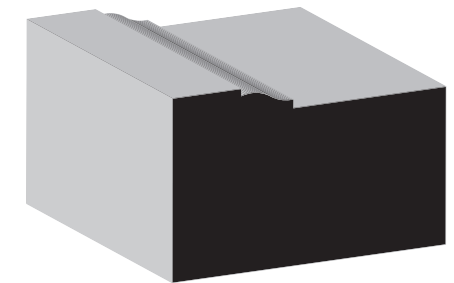

SKU	Brick Mould	
180	1-1/4" X 2"	Primed

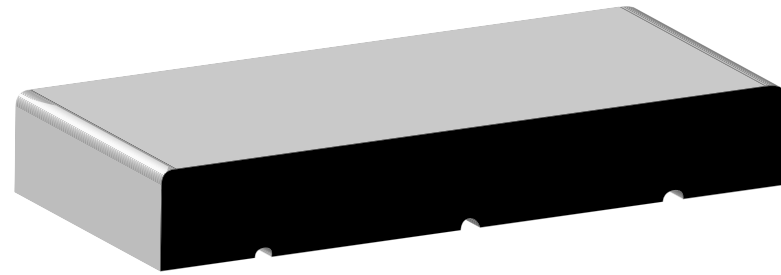

SKU	Jambs	
FLAT	4-5/8" Lineal	Finger Joint, Primed
FLAT	5-1/4" Lineal	Primed
FLAT	6-5/8" Lineal	Primed
FLAT	11/16" X 4-5/8" - 81-11/16"	Primed, Veneer
FLAT	11/16" X 4-7/8" - 81-11/16"	Primed
FLAT	11/16" X 4-5/8" - 97-11/16"	Primed
FLAT	11/16" X 4-7/8" - 97-11/16"	Primed
FLAT	11/16" X 6-5/8" - 81-11/16"	Primed
FLAT	11/16" X 6-5/8" - 97-11/16"	Primed

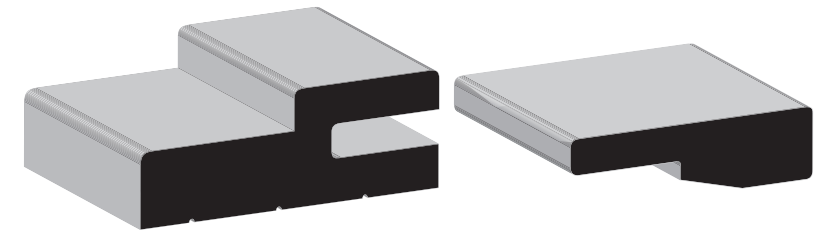

SKU	Jambs	
SPLIT	1-1/16" X 5-1/4" - 81-11/16"	Finger Joint, Primed, Clear
SPLIT	1-1/16" X 5-1/4" - 97-11/16"	Primed
SPLIT	1-1/16" X 5" - 81-11/16"	Finger Joint, Primed
SPLIT	1-1/16" X 6-9/16" - 81-11/16"	Primed
SPLIT	1-1/16" X 6-9/16" - 97-11/16"	Primed



SKU	Stool	
1021	11/16" X 5-1/4"	Primed
	11/16" X 7-1/4"	Primed



SKU	Base	
634	7/16" X 3"	Finger Joint, Primed, Clear



SKU	Base	
433B	7/16" X 3-1/4"	Primed



SKU	Base	
620	9/16" X 4-1/4"	Finger Joint, Primed, Clear



SKU	Base	
430M	1/2" X 4-1/4"	P MDF
430J	7/16" X 4-1/4"	Primed
430	9/16" X 4-1/4"	Primed

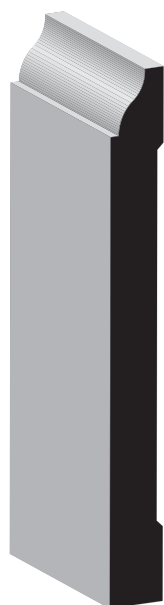

SKU	Base	
618	9/16" X 5-1/4"	Primed



SKU	Base	
647	9/16" X 5-1/4"	Finger Joint



SKU	Base	
658	9/16" X 5-1/4"	Finger Joint, Primed, Clear



SKU	Base	
430LS	7/16" X 5-1/4"	Primed
430L	9/16" X 5-1/4"	Primed



SKU	Base	
WP163	9/16" X 5-1/4"	Primed



SKU	Base	
434M	1/2" X 7-1/4"	P MDF



SKU	Base	
813	11/16" X 7-1/4"	Finger Joint

FLOOR - QUARTER ROUND, BASE SHOE & BASE CAP

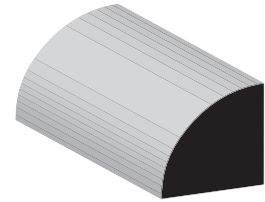

SKU	Qtr Round	
105	3/4" X 3/4"	Clear



SKU	Base Shoe	
857	7/16" X 3/4"	Primed

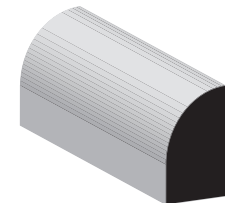

SKU	Base Shoe	
126	1/2" X 3/4"	Primed, Clear



SKU	Base Cap	
1100	11/16" X 1"	Primed, Clear

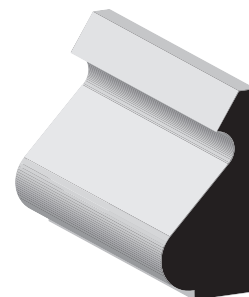

SKU	Base Cap	
163	11/16" X 1-3/8"	Primed, Clear

GENERAL PURPOSE - FULL ROUND, HAND RAIL, LATTICE, MANTEL & SCREEN

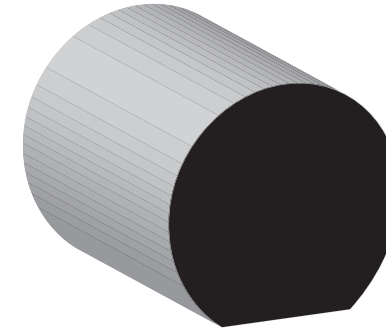

SKU	Handrail	
231	1-1/2" X 1-11/16"	Finger Joint, Clear

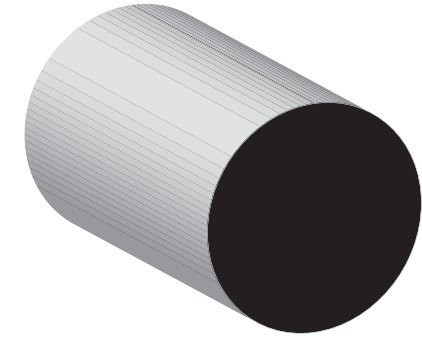

SKU	Closet Rod	
233	1-1/4" X 1-1/4"	LVL, Clear

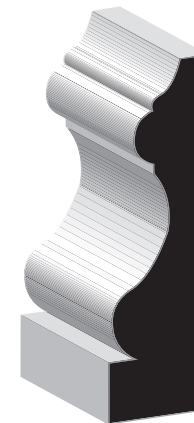

SKU	Mantel Mould	
234	1-1/32" X 2-3/4"	Finger Joint



SKU	Mantel Mould	
358	1-3/8" X 3-5/8"	Finger Joint



GENERAL PURPOSE - FULL ROUND, HAND RAIL, LATTICE, MANTEL & SCREEN

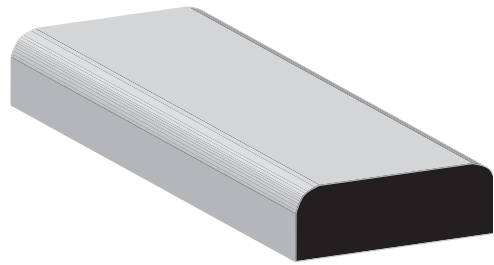

SKU	Screen Mould	
142	1/4" X 3/4"	Clear

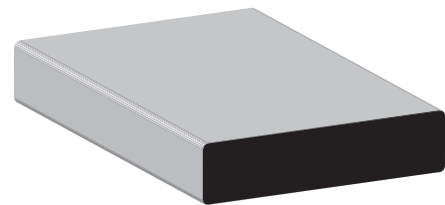

SKU	Lattice	
268	1/4" X 1-1/8"	Clear

PATTERNS STOCK & BOARDS - SHIPLAP & NICKEL GAP



SKU	Shiplap Nickel Gap	
1x6	5/8" X 5-1/2"	Primed



SKU	Shiplap Nickel Gap	
1x8	5/8" X 7-1/4"	Primed

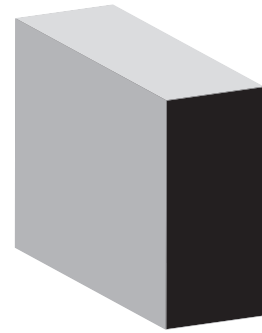

SKU	S4S	
249	11/16" X 1-5/8"	Clear

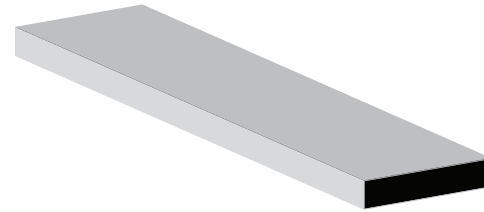

MDF S4S Boards		
11/16" Thick	1 X 2 1 X 4 1 X 6 1 X 8 1 X 12	RAW MDF

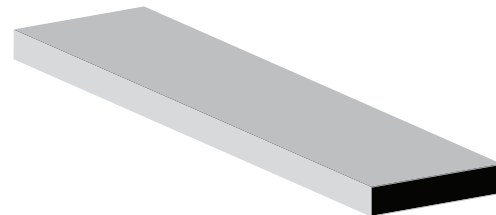

S4S Boards		
23/32" S4S	1 X 2 1 X 4 1 X 6 1 X 8 1 X 12	Finger Joint, Primed

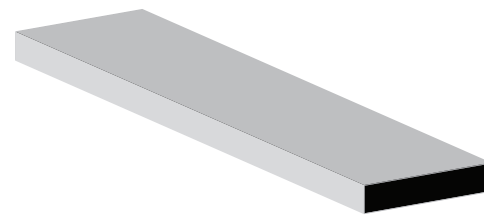

Hardwood S4S Boards		
3/4"	1 X 4 1 X 6 1 X 8 1 X 12	Maple, Poplar, Red Oak

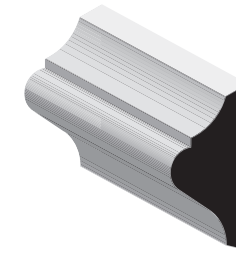

SKU	Decca	
183	9/16" X 1-1/8"	Primed, Clear

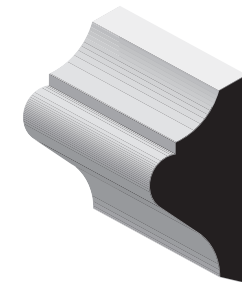

SKU	Decca	
182	11/16" X 1-5/8"	Primed, Clear

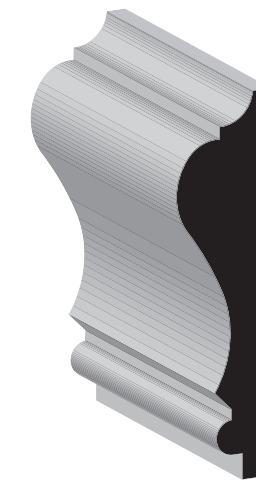

SKU	Chair Rail	
390	11/16" X 2-5/8"	Primed, Clear





## KANSAS CITY DISTRIBUTION CENTER

1800 E 94th Street  
Kansas City, MO 64131

Sales: (913) 387-4537  
[www.amerhart.com](http://www.amerhart.com)

**\*IMAGES REPRESENT STANDARD PROFILES. ACTUAL PROFILES MAY VARY SLIGHTLY.\***

