



Laurel Mountain

Standard Sectional Installation Instructions

Tools and materials you might need for proper installation:

- 6D Galvanized Screws
- Long Level
- Caulking Gun
- Bathroom Caulk - (see page 3, step 8)
- 100% Silicone Caulk
- Tape Measure
- 1/8" Drill Bit
- Philips Screw Driver

Thank you for purchasing Laurel Mountain Bathware. For best results, please read and follow all directions carefully.

PRE-INSTALLATION PLANNING

READ INSTRUCTIONS COMPLETELY BEFORE BEGINNING INSTALLATION.

1. Do NOT store units out of doors. Keep out of sunlight and exposure to weather.
2. Do not remove the Medallion Identification number, doing so may affect the warranty. This number may be found above the drain, left or right corner of the unit.
3. Review Figures 7 and 8 to make sure alcove is of proper size. If a fire rated alcove is required, approved finish material must be installed prior to unit installation. Access to drain and supply connections should be provided so that these connections may be made after the unit has been installed. Framing alcove must reflect dimensions on diagrams to permit unit installation. Note in diagrams the required opening in the floor to provide clearance for the drain fitting and connection.
4. These units are trimmed to be self-leveling at the factory. If the sub-floor at the installation site is not perfectly level, it will be MANDATORY to provide shims under the back edge of the unit to level the unit. See Figure 1 if shimming is required.

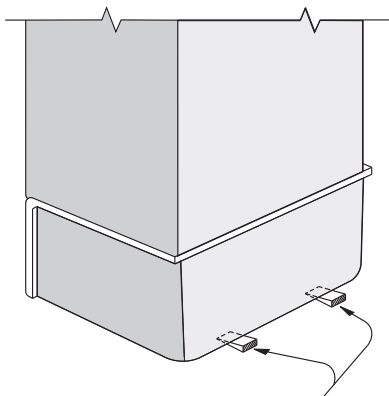

Figure 1 Wood Support Shims (If Necessary To Level Unit)

INSTALLATION PROCEDURE

1. Remove wall section(s) from the base unit. Carefully move all parts into the installation area. Apply a bead of 100% Silicone Caulk to all joints. Re-install the wall sections. Align all parts by making sure the wall sections using the factory provided alignment pins and slots. Units have one or more alignment pins with corresponding slots that help to assure the parts line up correctly. Once the 100% Silicone Caulk is applied and the parts re-assembled, wipe away any excess caulk that squeezes out. The unit will be installed into the framing alcove as a one piece unit. The unit must be installed completely level.

Alternate Connection: If installing piece-by-piece into the alcove, make sure the pins and slots are aligned correctly. When the 100% silicone Caulking is cures the parts are solidly held similar to a one piece unit when secured to the framing. See Photo 1.

The valve wall should be the last wall to be installed.

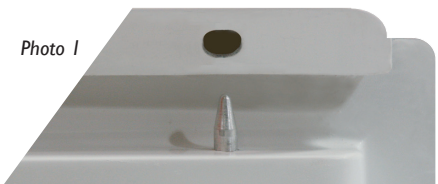

2. The drain and/or overflow assembly should be installed on the unit according to the manufacturers instructions. Apply a bead of 100% Silicone Caulk around the drain hole opening in the unit before installing the fitting.
3. Locate supply lines for control valves and shower head. Measure and mark locations of fittings on the finished side of the unit. Re-check locations and drill 1/4" pilot holes. Cut holes to final size using the appropriate size hole saw.
4. Carefully carry the unit to the installation location and trial fit into the framing alcove. Check for level along the front of the side walls and on top of the apron/dam. If unit is not level, shims will need to be located on the sub-floor to support the back edge of the unit. Remove the unit and secure the shims as required to make the unit level when installed. Remove and adjust shims if required to assure level and proper support. Secure shims so they will not move.



Laurel Mountain

Standard Sectional Installation Instructions

Note: If using shims it is MANDATORY these shims are in place and in proper contact to assure structural integrity of the bathing unit.

- Plumb and level the unit in two directions: Place a level on top of the apron and along the finished flat area of the top of all walls. Once the unit is leveled, if any gap appears between the apron and sub-floor, fill this gap with solid material. When satisfied with the fit, pre-drill 1/4" holes through all mounting flanges 8" O.C. vertical and at each stud horizontally. Attach the unit to the framing with 6D galvanized screws.
- Make connections to supply and drain lines. Strap all lines to the framing. Install finished trim. Caulk along all fittings as necessary.
- Check for leaks before installing wall-board and closing off access to the plumbing.
- Finish wall board as detailed in Figure 2.

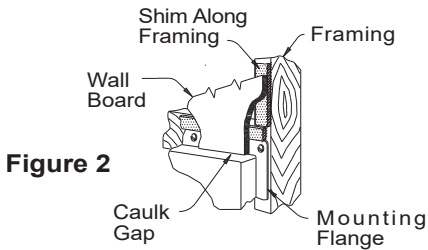

Sectional bathing units are shipped from the factory with screws or nuts and bolts connecting the parts together.

If installing the unit fastened together as one piece, follow instructions on Page 1 of this manual.

The alignment pins should allow you to more easily install the unit in the framing alcove. Read and understand the instructions on this page since the alignment pins must be inserted in a specific direction.

- Install drain and/or overflow assembly on the unit following drain manufactures instructions. If required, place shims under the back edge and secure. Place the base unit in the alcove location. Level the base. Check for level and plumb in two directions. When level, secure to framing using galvanized screws.

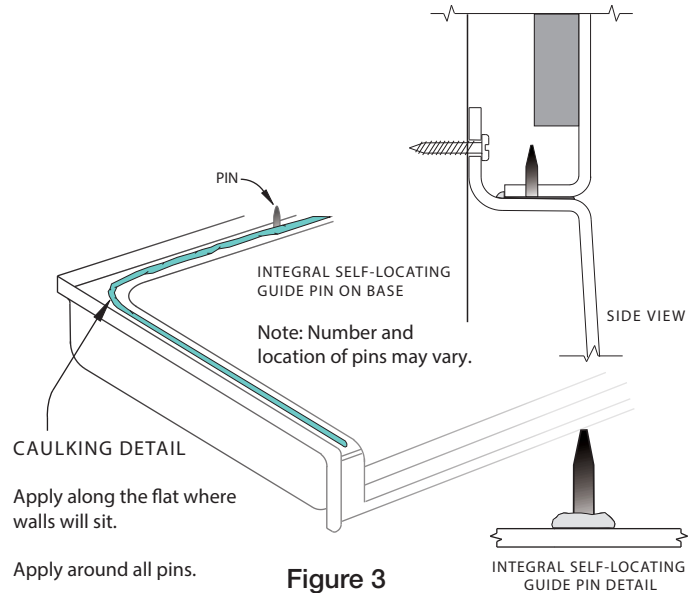

Figure 3

- Place a continuous bead of 100% silicone calulk along the top flat surface of the base where the wall sections will sit. Make sure caulk surrounds all guide pins.

For three and four piece units, apply silicone up the vertical seams where the parts will meet.

- Place the walls on top of the base, aligning the slots with the pins. For three piece units, install the valve wall last. Repeat the same for the opposite wall. Make sure the parts are seated in the silicone, and that all seams are even and in alignment. Press all seams together to assure a tight fit. Wipe away any excess caulk before it cures. See Figure 5.
- For four piece units, install the back wall first. Install the left and right walls (valve wall last). Press the seams together to assure a tight fit. Make sure all seams are in alignment. Wipe away any excess caulk before it cures.
- Re-check to make sure all seams are even and in alignment with the base section. Fasten the walls to the framing using 6D galvanized screws through the mounting flanges. Fasten every 8" O.C. along the vertical flanges and into each framing stud along the top horizontally.
- Make connections to supply and drain lines. Strap all lines to the framing. Install finished trim. Caulk if necessary.
- Check for leaks before installing wall board and closing off plumbing access. NOTE: Laurel Mountain is not responsible for leaking connections.



Laurel Mountain

Standard Sectional Installation Instructions

- 8. Apply bathroom caulk to all seams. Wet your finger and run along the caulk to produce a consistent, smooth bead in the seam.
- 9. Finish wall board as detailed in Figure 6.

CAUTION

If you use a RUBBER FLOOR MAT in the tub or shower unit it must be removed after each usage. If left in the unit, it may cause blisters or damage to the surface finish.

DO NOT USE ABRASIVE CLEANERS

The most important caution is to avoid the use of harsh abrasive cleaners or gritty scouring powders. To clean the unit, simply use a household liquid detergent with a soft sponge or cloth with warm water.

More persistent stains, tar or paint can be removed with naphtha or mineral spirits. Remove dried plaster by scraping with a soft sharpened wooden stick. Avoid wire brushes, metal scrapers or tools. Restore dull areas by rubbing with automotive type body cleaning compound.

©2021, Laurel Mountain

Laurel Mountain
26 Nesbitt Road, Suite 257
New Castle, Pa 16105
Customer Service 800-930-0050 infor@lmbath.com

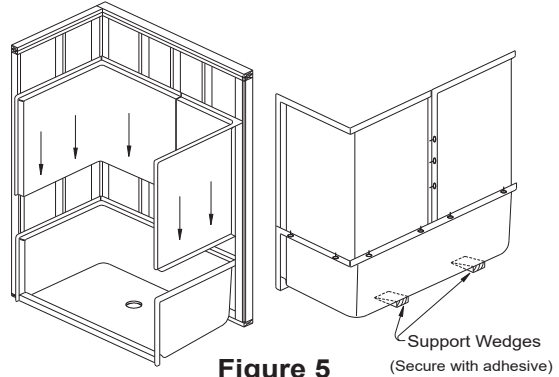

Figure 5

NOTE: Use wedges only if required

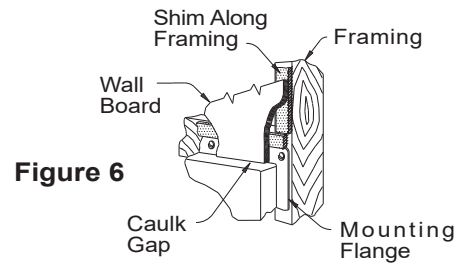

Figure 6

LIMITED WARRANTY

Laurel Mountain warrants to the original purchaser to be free from defects in material and workmanship for the following periods. The bathing unit shell carries a limited lifetime warranty. The grab bars, drain and curtain rod have a limited 10 year warranty. All other parts have a limited 5 year warranty. Proof of purchase is required. This warranty is issued to the original purchaser and shall be effective from the date of purchase as shown on purchasers receipt.

Laurel Mountain will repair or replace (at their choice) any unit which proves to be defective in material or workmanship under normal use and service, having been properly installed. This warranty is the only express warranty made by Laurel Mountain and is limited to the duration of this warranty. Any labor charges and/or damage incurred in installation, repair or replacement as well as incidental and consequential damages connected therewith are excluded and will not be paid by Laurel Mountain. Some states do not allow the exclusion or limitation of incidental or consequential damage, so the above limitation or exclusion may not apply to you. This warranty is void for any damages to the unit due to abuse, misuse, neglect, accident, improper installation, any use violating instructions furnished by us, or repair not authorized in writing by Laurel Mountain.

To validate your warranty, record your order date, PO # and Serial # and store in a safe place

The order date & (8-digit) PO # can be found on your Lowes receipt. The serial # is located on your unit (see example to the right). ➔

Order Date: _____

PO #: _____

Serial #: _____



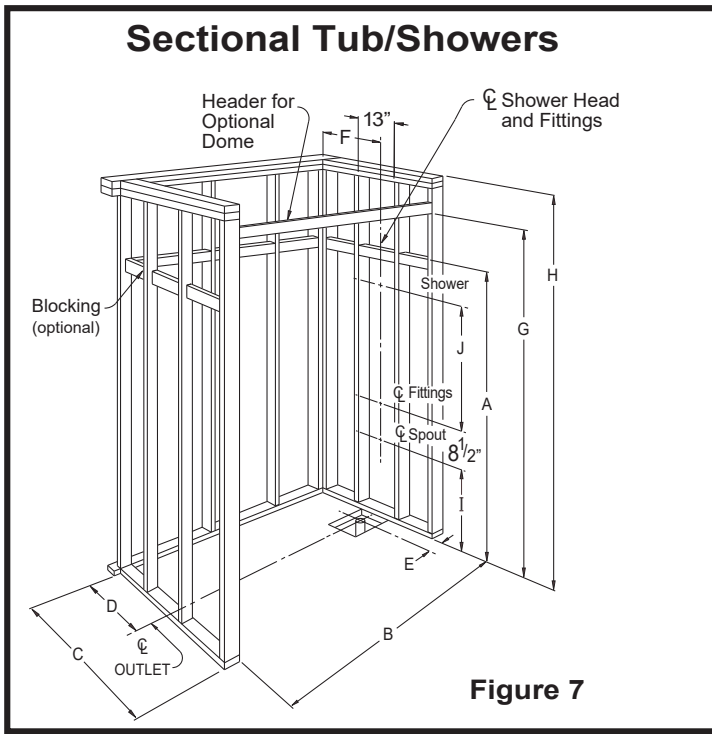

Figure 7

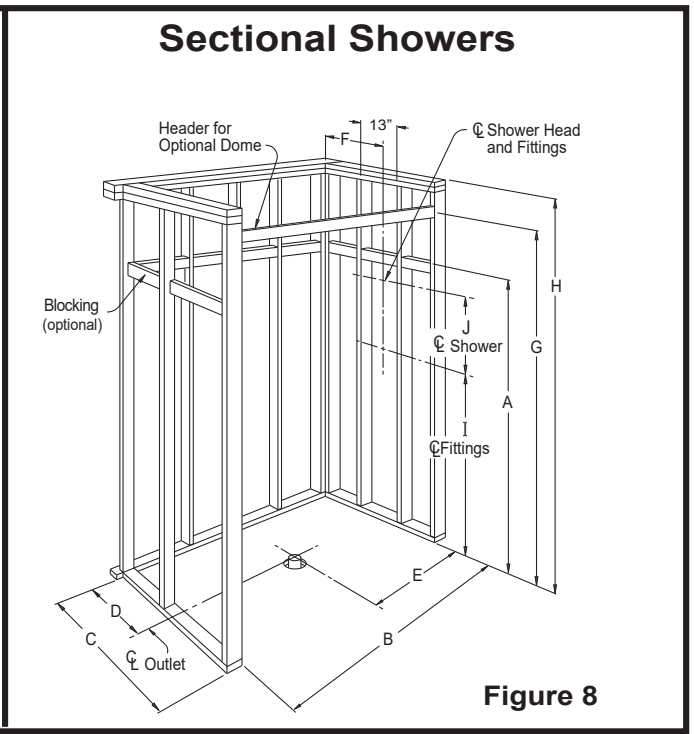

Figure 8

FRAMING DIMENSIONS

Model No.	Fig 7	Fig 8	Fig 9	A	B	C	D	E	F	G	H	I	J
LM 3260 SH IS 4P		X		77 1/2"	60 1/4"	32"	16"	8 7/16"	16"	N/A	N/A	42"	33"
LM 3648 SH IS 3P		X		80"	48 1/4"	37"	19"	24 1/8"	19"	N/A	N/A	42"	34 3/4"

LIMITED TIME ONLY!

FREE!



\$25.00

Laurel Mountain

1-800-930-0050

sales@lmbath.com

How to Receive

- 1. Share your positive experience by leaving a review on lowes.com.**
- 2. Call or Email Laurel Mountain.**
- 3. Give the model number of the unit you reviewed. Once your lowes.com review is verified, we will mail you the \$25.00 gift card for Lowes!**

IT'S THAT EASY :)