



Techno**MAAX**

www.maax.com



1-877-GET-MAAX (1-877-438-6229)

MAAX[®]
Enjoy the experience

TABLE OF CONTENTS

■ COLLECTION

Systems Modification
Souvenir Bathtub

■ PROFESSIONAL

2017 Price List Update

■ RETAIL

2017 Price List Update
Shower Kit Discontinuation

■ AKER

Redesign of Bathtub Support
Outlook Plus Gen+ Series accessories

Collection

1 - New Suction Cover for Collection Systems

Please note that as of November 10th, the suction cover design for the below Collection systems has changed.

Impacted Collection systems when single suction is installed:

004 and 008 (Hydromax whirlpool system)

054 (Hydrofeel whirlpool system)

056 (Combined Hydrofeel and Aerofeel)

094 (Combined Hydromax and Aerofeel)



Please contact the Customer Care department for any additional information.

2 - Storage Solution - Souvenir Freestanding Bathtub

Please note that the Storage solution (sold separately) is highly recommended when a Souvenir freestanding bathtub with apron (**100084**) is purchased with a system. When systems are installed, the pump/blower is exposed and there is no cover provided to conceal the mechanical systems, which makes it loud. The storage solution would act as a cover and thus reduce the noise.

Available storage solutions can be found in the accessories section:

- 10007311** Mahogany storage cabinet
- 10007312** Chestnut storage cabinet
- 10007313** Natural (non-treated) storage cabinet

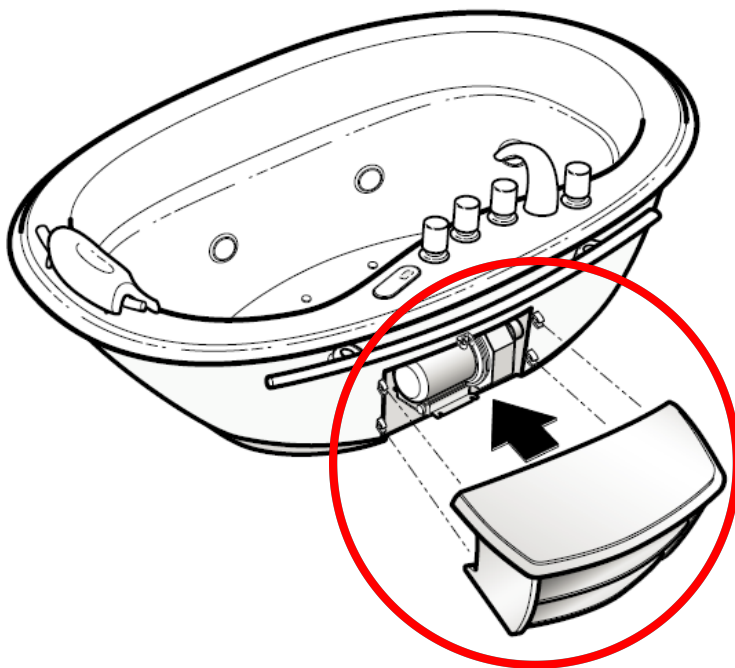

The Storage Solution covering the mechanical part of the bathtub system.

Please contact the Customer Care department for any additional information.

Professional

3 - 2017 Price List Update

Please note that some modifications were made to the MAAX Professional National USA price list. These changes include the update of a few technical drawings as well as minor corrections on some product information. The updated PDF version of the price list is available to download on the [Pros Corner](#).

The most crucial changes were made to the new Radia doors product pages (p.418-424), where the technical information regarding minimum and maximum widths, the access, the adjustment and so forth, as well as the technical drawings, have been modified to ensure accuracy. Please note these changes are not reflected in the printed version, and we therefore recommend you print out the Radia doors pages in order to guarantee you have the most up-to-date technical information.

Effective change date: Immediately (October 10, 2017)

Impacted Models:

Model #	Product name	Improvement
137440	Radia Neo-Angle 36 x 36	Updated technical information and technical drawings
137440	Radia Neo-Angle 38 x 38	
137442	Radia Neo-Angle 40 x 40	
137443	Radia Neo-Round 32 x 32	
137444	Radia Neo-Round 36 x 36	
137445	Radia Neo-Round 40 x 40	
137446	Radia Round 36 x 36	
137447	Radia Square 32 x 32	
137448	Radia Square 36 x 36	

Please contact the Customer Care department for any additional information.

Retail

4 - 2017 Price List Update

Please note that some modifications were made to the MAAX Retail USA price list. These changes concern the new Radia doors product pages (p.393-400), where the technical information regarding minimum and maximum widths, the access, the adjustment and so forth, as well as the technical drawings, have been modified to ensure accuracy.

Please note these changes are not reflected in the printed version, and we therefore recommend you print out the Radia doors pages in order to guarantee you have the most up-to-date technical information. The updated PDF version of the price list is available for download on the [Pros Corner](#).

Effective change date: Immediately (October 10, 2017)

Impacted Models:

Model #	Product name	Improvement
137440	Radia Neo-Angle 36 x 36	Updated technical information and technical drawings
137440	Radia Neo-Angle 38 x 38	
137442	Radia Neo-Angle 40 x 40	
137443	Radia Neo-Round 32 x 32	
137444	Radia Neo-Round 36 x 36	
137445	Radia Neo-Round 40 x 40	
137446	Radia Round 36 x 36	
137447	Radia Square 32 x 32	
137448	Radia Square 36 x 36	

Please contact the Customer Care department for any additional information.

5 - Shower Kit Discontinuation

Following the market trends, we are discontinuing a number of shower kits nearing the end of their life-cycle, and replacing them with new and exciting products which are already available. Please note the following kits are discontinued as of March 1, 2018. Below you will find a detailed list of discontinued products as well as their replacements.

Discontinued Models:

Discontinued Product		Replacement Product 1		Replacement Product 2	
Model #	Product Name	Model #	Product Name	Product #	Product Name
102889	TIGRIS KIT ANGLE 343 REG WHITE	137300	Hana NA 38 door		
		106380	NA 38 acrylic base		
102886	MAGNOLIA KIT ANGLE CLEAR	139315	Davana NA 38 door		
		106380	NA 38 acrylic base		
102892	WALLS 2-PC 38" CORNER SHOWER	106108	3-Piece Acrylic wall set		
102899	WALLS 2-PC 38" CORNER SHOWER				
300009	NERO SHOWER KIT	300001	Cyrene Round 34	138441	Orbit NA 38 door
				106380	NA 38 acrylic base
300011	MAGNOLIA ROUND III SHOWER KIT	300001	Cyrene Round 34	138441	Orbit NA 38 door
				106380	NA 38 acrylic base
106346	NERO SHOWER KIT INCLUDING WALLS	300001	Cyrene Round 34	138441	Orbit NA 38 door
				106380	NA 38 acrylic base
				106108	3-Piece Acrylic wall set
105759	OLYMPIA PENTANGLE SHOWER KIT	137301	Hana NA 40 door	139315	Davana NA 38 door
		106381	NA 40 acrylic base	106380	NA 38 acrylic base
101568	ECONO SHOWER KIT 32"	105605	Mediterranean III 32		
141168	ECONO SHOWER KIT 32"	105544	Begonia NA 36 Pebble		

Please contact the Customer Care department for any additional information.

AKER

6 - Redesign of Base Support

Please note that for the below AKER Drop-in Bathtub models, we will transition to a new base support, which will include 4 pre-levelled feet, instead of the current Fiberglass base. This transition will take place starting February 2018. During this transition, it is possible that some units will continue having the current fiberglass base support.

Below is a visual example of this new change. Both support provide the same function benefits and do not alter the installation instructions.

Please note that technical drawings will be update to reflect the new base structure with the 4 pre-levelled feet.

Impacted Models:

Model #	Product Name
141120	CT2-6060
141118	CT-6060
141097	CTF2-6060
141096	CTF-6060
141112	OV-4260
141114	OV-4272
141095	OVF-4260
141099	SB-3260
141101	SB-3660
141105	SB-3672
141103	SB-4260
141088	SBF-3260
141089	SBF-3660
141092	SBF-3672
141108	SBHG-4272
141110	SBOO-4272

Current support base:

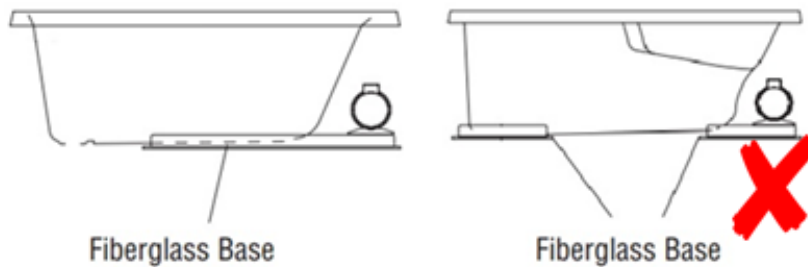

New support base (starting February 2018)

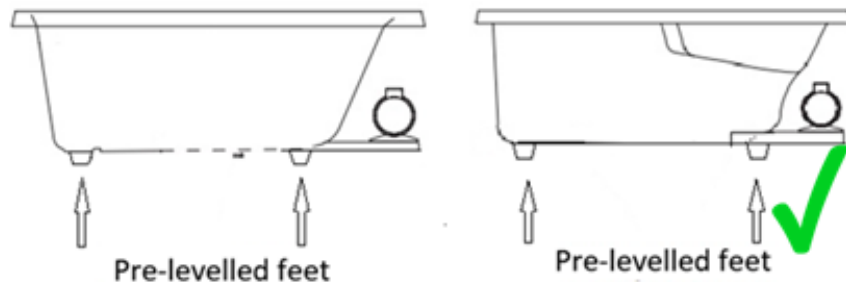



Please contact the Customer Care department for any additional information.

AKER

7 - Outlook Plus Gen+ Series accessories

Please take note of the following modifications to the Outlook Plus Gen+ Series accessories. The changes listed below are effective immediately - December 22, 2017.

OPT 20051 - Rectangular 26 in. Seat - Error in the price list description:

OPT 20051-XXX	Rectangular Phenolic seat ^{1,4,5} Available colors: White (002) and Teak (185)		N/A	Add \$ 563
OPT 20051-XXX	Rectangular 26 in. Fold-up seat with Stainless Steel frame (factory installed) ^{1,4,5} Available finishes: Naugahyde (381) and Phenolic (382)		N/A	Add \$ 563

141369 - OPS-6036-RS (BASE MODEL WITH MASSACHUSETTS GRAB BAR AND SEAT) - the model is no longer offered with L-Shaped fold up seat. The L-shaped seat will be replaced with the Rectangular fold-up Naugahyde White seat (factory installed).

BASE MODEL WITH MASSACHUSETTS GRAB BAR AND SEAT

No	Model	Dimensions	Pkg	Approx. weight	Std Color(s)	Non-std Color(s)
141369-000-xxx	Base model with MASS grab bar & seat package ¹⁰ 141369-R-000-XXX 141369-L-000-XXX Specify: Standard colors: White (002), Bone (004), Biscuit (007) Non-standard colors: Refer to color chart in this book. Package includes : • Base model • 1 x Horizontal Straight 48" textured Stainless Steel grab bar (factory installed) • L-shaped fold-up Phenolic White seat (factory installed)	60 X 36 X 76 5/8 in. Ext. Dimensions: 62 1/2 X 39 1/4 X 78 3/8 in.	119 ft ³	225 lb	\$ 2,190	\$ 2,290

BASE MODEL WITH MASSACHUSETTS GRAB BAR AND SEAT



No	Model	Dimensions	Pkg	Approx. weight	Std Color(s)	Non-std Color(s)
141369-000-xxx	Base model with MASS grab bar & seat package ¹⁰ 141369-R-000-XXX 141369-L-000-XXX Specify: Standard colors: White (002), Bone (004), Biscuit (007) Non-standard colors: Refer to color chart in this book. Package includes : • Base model • 1 x Horizontal Straight 48" textured Stainless Steel grab bar (factory installed) • Rectangular fold-up Naugahyde White seat (factory installed)	60 X 36 X 76 5/8 in. Ext. Dimensions: 62 1/2 X 39 1/4 X 78 3/8 in.	119 ft ³	225 lb	\$ 2,190	\$ 2,290

Please contact the Customer Care department for any additional information.

OPT 20219 - Pivot Grab Bar - is only available in White (001) and Brushed Nickel (105)

OPT 20219-XXX	Pivot grab bar (back wall) ^{6,8} OPT 20219-R-XXX Right-hand pivot grab bar on back wall OPT 20219-L-XXX Left-hand pivot grab bar on back wall Available colors: White (002), Chrome (084) and Brushed Nickel (105)		N/A	Add \$ 1,119
OPT 20219-XXX	Pivot grab bar (back wall) ^{6,8} OPT 20219-R-XXX Right-hand pivot grab bar on back wall OPT 20219-L-XXX Left-hand pivot grab bar on back wall Available colors: White (002) and Brushed Nickel (105)		N/A	Add \$ 1,119

10029999-002 - 36" modern straight grab bar with flange - the grab bar will no longer be offered in white. Please use the Chrome (084) or Brushed Nickel (105) model as replacement.

10029999-XXX	36" modern straight grab bar with flange (front installation) Specify color: White (002), Chrome (084), Brushed Nickel (105)		N/A	\$ 204
10029999-XXX	36" modern straight grab bar with flange (front installation) Specify color: Chrome (084) and Brushed Nickel (105)		N/A	\$ 204

Please contact the Customer Care department for any additional information.

Download Digital Price Lists



Download the Price List

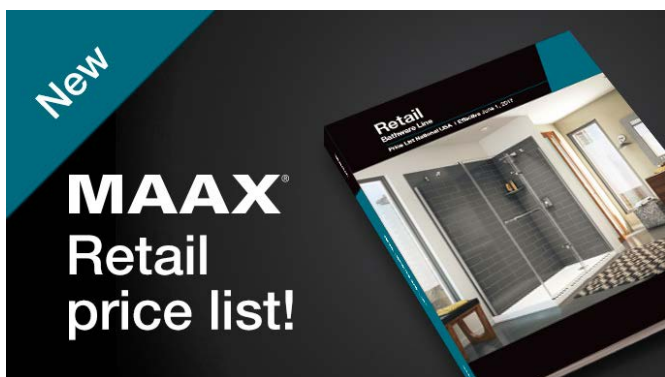

Download the Price List

Technical drawings may be subject to change without notice; you should therefore always confirm the technical information you have with the latest drawings on www.maax.com.

Please contact the Customer Care department for any additional information.

www.maax.com



1-877-GET-MAAX (1-877-438-6229)

MAAX[®]
Enjoy the experience