



OWNER'S MANUAL & INSTALLATION GUIDE

Estate

INSTALLER: This booklet must be given to the product owner.

Read all instructions before proceeding. All specifications are $\pm 3/8''$ and are subject to change without notice. Dimensions listed in inches.

Model # _____

Purchase Date _____

Serial # _____

Distributor _____



AQUATIC

The bath people

TABLE OF CONTENTS

PRODUCT WARRANTY REGISTRATION INFORMATION	3
INSTRUCTIONS PERTAINING TO A RISK OF FIRE, ELECTRIC SHOCK, OR INJURY TO PERSONS	4 – 5
WHIRLPOOL USER INFORMATION	6
FCC INFORMATION	6
AQUATIC LIMITED WARRANTY	7
INSTALLATION INSTRUCTIONS	
Pre-Installation Procedures	8
Structural Preparation	9-10
Factory Installed Tile Flange	10
Framing and Pre-Installation — Integrally Skirted Models	10
Framing Diagrams	11
Deck Cutouts	12
Installation Procedures for Integrally Skirted Models	13
Removable Skirt Panels for Integrally Skirted Models	13
Plumbing	14
Final System Test & Clean-Up	14
Electrical Installation	15-17
Optional Inline Maintenance Heater Operating Instructions	18
Installation of Electronic On/Off Timer Control	18
OPERATION	
Bathside Control Systems	19
Optional Chromatherapy LED Light	19
Jet Operations	20
To Replace LED Light	21
TUB CARE	
Maintenance	22
Repair	23
WATER QUALITY ISSUES	
Chemical and Water Quality	24 – 25
TROUBLESHOOTING GUIDE	26
REPLACEMENT PARTS LIST	27
REPLACEMENT PARTS MAP	28-29

AQUATIC Product Warranty Registration Information

Thank you for choosing an Aquatic bath. You have chosen one of the finest bath products in the industry! Aquatic supports your purchase with strong commitments to quality and customer satisfaction.

IMPORTANT!

To activate Product Warranty, please register with Aquatic. Your product warranty must be registered and confirmed with Aquatic through the Serial Number on your unit. To register, please contact Aquatic.

(800) 945-2726 • www.aquaticbath.com/register

Please read and follow all of the instructions contained in this Owner's Manual before installing, operating or maintaining your whirlpool. In addition, you should continually refer to these instructions during the life of your whirlpool bath. Failure to comply with these instructions may invalidate your warranty. If you have any questions concerning installation, operation, maintenance or any other aspect of your Bath, please contact:

AQUATIC CUSTOMER SERVICE CENTER: (800) 945-2726

(The Troubleshooting Guide on page 26 may be helpful in answering some of your questions.)

NOTE: The installation and service of your whirlpool should be performed **ONLY** by a qualified electrician and plumber.

IMPORTANT!

This product **MUST BE WATER-TESTED** and inspected prior to installation or warranty will be voided. See page 8 for instructions.

PLEASE CHECK ENTIRE UNIT FOR ANY DAMAGE.

If it appears damaged, contact your Aquatic Distributor immediately. Aquatic warranty does not cover damage that occurs in transit.

MODEL & SERIAL NUMBER LOCATION

The tub model and serial numbers are located above the pump area on the backside of the bathtub. An access panel should be placed by the installer at this location.



AQUATIC

The bath people



INSTRUCTIONS PERTAINING TO A RISK OF FIRE, ELECTRIC SHOCK, OR INJURY TO PERSONS

WARNING: When using this unit, basic precautions should always be followed, including the following:

READ AND FOLLOW ALL INSTRUCTIONS:

- **WARNING:** Risk of lethal electric shock. To reduce risk of electric shock, connect only to circuits protected by a Ground-Fault Circuit-Interrupter (GFCI) or Residual Current Device (RCD).
- **DANGER:** To reduce the risk of injury, do not permit children to use this unit unless they are closely supervised at all times.
- Use this unit only for its intended use as described in this manual. Do not use attachments not recommended by the manufacturer.
- Never drop or insert any object into any opening.
- Do not operate this unit without the guard over the suction fitting.
- The unit must be connected only to a supply circuit that is protected by a ground-fault circuit-interrupter (GFCI). Such a GFCI should be provided by the installer and should be tested on a routine basis. To test the GFCI, push the test button. The GFCI should interrupt power. Push the reset button. Power should be restored. If the GFCI fails to operate in this manner, there is a ground current flowing, indicating the possibility of an electric shock. Do not use this unit. Disconnect the unit and have the problem corrected by a qualified service representative before using.
- To reduce the risk of injury, enter and exit the bathtub slowly.
- This product is intended for indoor use only. Installing this unit outdoors could cause personal injury and will void your warranty.

SAVE THESE INSTRUCTIONS.

CALIFORNIA PROP. 65



WARNING: This product can expose you to chemicals including styrene and styrene compounds, which are known to the State of California to cause cancer and birth defects or other reproductive harm. For more information go to www.p65warnings.ca.gov

! WARNING



Electrical Shock Hazard

Plug into a grounded 3-prong outlet.

Do not remove ground prong.

Do not use an adapter.

Do not use an extension cord.

Failure to follow these instructions can result in death, fire, or electrical shock.

Your safety and the safety of others are very important.

We have provided many important safety messages in this manual and on your appliance. Always read and obey all safety messages.



This is the safety alert symbol. This symbol alerts you to potential hazards that can kill or hurt you and others.

All safety messages will follow the safety alert symbol and either the word "DANGER" or "WARNING." These words mean:

! DANGER

You can be killed or seriously injured if you don't immediately follow instructions.

! WARNING

All safety messages will tell you what the potential hazard is, tell you how to reduce the chance of injury, and tell you what can happen if the instructions are not followed.

INSTRUCTIONS PERTAINING TO A RISK OF FIRE, ELECTRIC SHOCK, OR INJURY TO PERSONS

WARNING: WHEN USING THIS UNIT, THESE BASIC PRECAUTIONS SHOULD BE FOLLOWED.

This manual contains information and instructions for proper operation and maintenance of your whirlpool bath. Failure to follow these instructions could result in personal injury, electrical shock or fire.

READ AND FOLLOW ALL INSTRUCTIONS

DANGER! TO REDUCE THE RISK OF INJURY:

1. Do not permit children to use this unit unless they are closely supervised by an adult at all times. Supervision is also required when used by an elderly or handicapped individual.
2. Use this unit only for its intended use as described in this manual. Do not use attachments not recommended by the manufacturer.
3. If you will not be operating the whirlpool system during your bath, you may fill the bathtub to any comfortable level. However, if you will operate the system, you must fill the bathtub as described in the section entitled **FINAL SYSTEM TEST & CLEANUP**, pg. 8. This will assure proper operation of the system..
4. The water in a bath should never exceed 40°C (104°F). Water temperatures between 38°C (100°F) and 40°C (104°F) are considered safe for a healthy adult. Use time should be limited to approximately 30 minutes, followed by a shower to cool down. Longer exposures may result in hyperthermia. The symptoms of this condition are nausea, dizziness and fainting, which can be fatal. Lower water temperatures are recommended for extended use (exceeding 10-15 minutes) and for young children.
5. Since excessive water temperatures have a high potential for causing fetal damage during the early months of pregnancy, pregnant or possibly pregnant women should limit bath water temperatures to 38°C (100°F).
6. The use of drugs or alcoholic beverages before or during bath use may lead to unconsciousness with the possibility of drowning. Never use the bath while under the influence of alcohol, anticoagulants, stimulants, antihistamines, vasoconstrictors, vasodilators, hypnotics, narcotics or tranquilizers.
7. Persons with a medical history of heart disease, low or high blood pressure, circulatory system problems, or diabetes should consult a physician before using whirlpool/bath.
8. Persons using medication should consult a physician before using whirlpool/bath since medication may induce drowsiness while other medication may affect heart rate, blood pressure and circulation.

DANGER: To reduce the risk of injury, enter and exit the bath slowly.

WARNING: Never operate electrically connected devices in or near the bath. Never drop or insert any object into any opening within the bath.

This unit must be connected to a supply circuit that is protected by a Ground Fault Circuit Interrupter (GFCI). Such a device should be installed by a licensed electrician and should be tested on a regular basis (at least monthly). To test the GFCI push the TEST button. The GFCI should interrupt the power. Push the RESET button and the power should be restored. If the GFCI fails to operate in this manner there is the possibility of an electric shock, DO NOT USE. Disconnect the unit and have the problem corrected by a qualified service technician. To avoid the possibility of personal injury and discoloration of the acrylic surface, the inlet water temperature should not exceed 60°C (140°F). The bath should be drained after each use. Each bather should start their bath with fresh water.

CAUTION: DO NOT USE HARSH ABRASIVES OR SOLVENTS FOR CLEANING THIS UNIT.

**INSTALLER/OWNER BEARS ALL RESPONSIBILITY TO COMPLY WITH ALL STATE AND LOCAL CODES
WHEN INSTALLING THIS PRODUCT.**

SAVE THESE INSTRUCTIONS

WHIRLPOOL USER INFORMATION

PLEASE NOTE:

The whirlpool action may cause even small amounts of bubble bath or shampoo to foam excessively. Exercise moderation in experimenting with different soap products.

No servicing of this product should be done by the user. There are no user serviceable parts. All controls are located in the control recesses on the lip of the tub. These are the only controls that should be used by the consumer. Do not change or alter any of these controls under any circumstances.

Motors are self-lubricating – No lubrication required.

FCC CONSUMER INFORMATION

Electrical installation information listed on pages 15 – 16.

This equipment generates and uses radio frequency energy and if not installed and used properly, that is, in strict accordance with the manufacturers instruction, may cause interference to radio and television reception. It has been type tested and found to comply with the limits for a class B computing device in accordance with the specifications in subpart J of part 15 of the FCC rules, which are designed to provide reasonable protection against such interference in a residential installation. However, there is no guarantee that interference will not occur in a particular installation. If this equipment does cause interference, which can be determined by turning the equipment on and off, the user is encouraged to try to correct the interference by one or more of the following measures:

- Reorient the receiving antenna
- Relocate the receiver with respect to the bath tub.
- Move the receiver away from the bath.
- Plug the receiver into a different outlet so that the receiver and bath are on different branch circuits.
- If necessary, the user should consult the dealer or an experienced radio/television technician for additional suggestions.
- The user may find the following booklet prepared by the FCC helpful: "How To Identify and Resolve Radio-TV Interference Problems." It is available from the U.S. Government Printing Office, Washington, DC 20402, Stock No., 004-000-00345-4.



Aquatic Limited Lifetime Warranty

FOR ESTATE SERIES

Limited Warranty For Original Consumer For Household Usage

WHAT PRODUCTS ARE COVERED

Structures and surface finishes on Whirlpools ("Whirlpools"), Air Baths ("air baths") and Soaking Tubs ("Tubs"), and their support equipment, components, attachments, controls and plumbing equipment. Different warranty periods apply to specific components.

Warranty Periods for Specific Components

LIFETIME WARRANTY FOR WHIRLPOOL/AIR BATH/TUB SHELL, PUMP AND BLOWER

Aquatic extends to the original consumer purchaser of the acrylic, fiberglass reinforced shell, a non-transferable lifetime warranty that the shell will retain its structural integrity and configuration and be free of water loss due to a defect in the tub shell. The warranty covers the tub shell and the factory installed pump and blower against defects in material or workmanship. This warranty does not apply to all other components (attachments to the acrylic, fiberglass reinforced shell, such as plumbing, fittings and other apparatus) because these pieces are covered below under a 2 Year Warranty.

LIFETIME SURFACE WARRANTY FOR FACE OF WHIRLPOOL/AIR BATH/TUB

The interior surface is warranted against fading, blistering, cracking and delamination due to defects in the surface materials for life. This surface warranty extends to defects due to surface material mixing or molding. This surface warranty does not apply to fading, cracking, delamination or blistering due to excessive wear, sun fading or scouring due to cleaning.

2 YEAR EQUIPMENT WARRANTY FOR SUPPORT EQUIPMENT, COMPONENTS, CONTROLS & PLUMBING EQUIPMENT

All support equipment; components, controls and plumbing equipment are warranted for 2 years from date of purchase, but not more than 3 years from date of manufacture, against defects in workmanship and materials. Pillows are not included in this two-year period. However, these accessories are warranted to be free from defects in materials and workmanship at the time of delivery to the original purchaser. Limited labor is covered for 2 years from purchase, but never more than 3 years from date of manufacture, for limited labor on the support equipment, controls, and plumbing.

EXCLUSIVE REMEDY

Aquatic will, **at its option**, repair or replace (without removal or installation) the affected components of any defective Unit or System; repair or replace (without removal or installation) the entire defective Unit or System; or refund the then-current list price of the Whirlpool, Air Bath, or Tub. In all cases, a reasonable time period must be allowed for warranty repairs to be completed.

WHAT YOU MUST DO

In order to make a claim under these warranties:

1. You must be the original consumer purchaser of the Whirlpool, Air Bath, or Tub.
2. You must promptly notify us within the warranty period of any defect and provide us with any substantiation that we may reasonably request. Contact Warranty Services: **800.945.2726 • aquaticbath.com**.
3. The Whirlpools, Air Baths, and Tubs must have been installed and maintained in accordance with good industry practice and the specific Aquatic directions contained in the Owner's Manual and Installation Guide.

EXCLUSIONS

These warranties do not extend to or do not cover defects caused by:

1. Shipping damage by carriers or installation errors.
2. Accident, acts of God, abuse or misuse.
3. Unreasonable use (including any use for non-bathing purposes or failure to provide reasonable and necessary maintenance as specified in Aquatic Owner's Manual and Installation Guide supplied with the Whirlpool, Air Bath or Tub).
4. Any alteration, customization, or modification of the Whirlpool/Air Bath/Tub or its components.

LIMITATIONS

1. **Aquatic whirlpools and tubs sold for industrial, commercial and hotel use** are warranted for two years, but not more than 3 years from date of manufacture, with a 2 year limited warranty that the shell will retain its structural integrity and configuration and be free of water loss due to a defect in the tub. The interior surface/face of the whirlpool/air bath/tub is warranted against fading, blistering, cracking and delamination due to defects in the surface materials for 2 years as well. All support equipment, components, controls and plumbing equipment and limited labor on the support equipment, controls, or plumbing are warranted for 1 year from date of purchase, but not more than 2 years from date of manufacture. Pump seals, "O" rings, light bulbs, fuses and pillows are not included in this two-year period. However, these accessories are warranted to be free from defects in materials and workmanship at the time of delivery to the original purchaser.
2. **In all cases, Aquatic reserves the right to fully satisfy its obligations under the Limited Warranties by refunding the then-current list price of the defective Whirlpool, Air Bath, or Tub (or, if the Whirlpool, Air Bath, or Tub has been discontinued, of the most nearly comparable current product).**
3. **THESE WARRANTIES ARE NON-TRANSFERABLE TO ANY OTHER PURCHASER OR PARTY OTHER THAN THE ORIGINAL CONSUMER. NO OTHER AGENT OR PARTY CAN GIVE ANY OTHER WARRANTY OR PROMISE. THIS IS THE SOLE WARRANTY FOR YOUR Aquatic PRODUCT.**
4. Aquatic will not cover any installation or reinstallation costs related to this warranty, except under the limited labor allowance under the 2 Year Equipment Warranty above.

GENERAL

This warranty gives you specific legal rights; you may also have other rights, which vary from state to state. THE DURATION OF ANY IMPLIED WARRANTIES, INCLUDING THE IMPLIED WARRANTIES OF MERCHANTABILITY AND FITNESS FOR A PARTICULAR PURPOSE, ARE LIMITED TO THE DURATION OF THE EXPRESS WARRANTIES HEREIN. Aquatic EXPRESSLY EXCLUDES INCIDENTAL AND CONSEQUENTIAL DAMAGES, TO INCLUDE LOSS OF TIME, INCONVENIENCE, OR LOSS OF USE OF RESIDENCE, FOR ANY BREACH OF THE EXPRESS OR IMPLIED WARRANTY, INCLUDING THE IMPLIED WARRANTIES OF MERCHANTABILITY OR FITNESS FOR A PARTICULAR PURPOSE.

SOME STATES DO NOT ALLOW ANY LIMITATION ON HOW LONG AN IMPLIED WARRANTY LASTS, OR THE EXCLUSION OR LIMITATION OF INCIDENTAL OR CONSEQUENTIAL DAMAGES; SO THE ABOVE EXCLUSION MAY NOT APPLY TO YOU.

INSTALLATION INSTRUCTIONS

READ ALL INSTRUCTIONS CAREFULLY BEFORE INSTALLATION

PRE-INSTALLATION PROCEDURES

PLEASE NOTE: THE MANUFACTURER ACCEPTS A $\pm 3/8$ " VARIANCE. THERE ARE VARIATIONS ON EACH TUB AND SPECIFICATIONS ARE SUBJECT TO CHANGE AS WE IMPROVE UPON OUR PRODUCT AS REQUIRED.

THE DIMENSIONS NEEDED FOR SITE PREPARATION AND STRUCTURE BUILDINGS SHOULD BE MEASURED FROM THE TUB; AQUATIC ASSUMES NO RESPONSIBILITY FOR PREPARATORY WORK.

Note: A good knowledge of construction techniques, plumbing and electrical installation according to codes are required for proper installation. We recommend that a qualified licensed contractor perform the installation of all Aquatic products. Our warranty does not cover improper installation related problems.

1. Immediately upon receiving your Aquatic whirlpool bath inspect it thoroughly for freight damage. If necessary, contact your dealer/distributor immediately (your dealer/distributor must contact Aquatic within 24 hours of receiving unit to file a claim.) Should inspection indicate any damage, do not install the bath. Damage or defect to the finish claimed after the bath is installed is not covered under the warranty.
2. All baths are filled with water and operated in our manufacturing facility prior to shipment. Inspectors ensure watertight operation, however rough handling may cause leaks which may be detected prior to installation.

TO INSPECT:

1. Place the tub in an area where it may be drained after testing.
2. Fill the tub to the overflow and allow to stand for a few minutes. Carefully inspect all fittings and connections for leaks.
3. Plug in pump cord and run pump for 10 minutes.
4. Inspect the tub completely. Any defect must be reported to Aquatic prior to installation in order to have it covered by warranty. Should inspection indicate any damage or leaks, do not install the bath.

Damage or leaks claimed after the bath is installed are not covered under the warranty.

5. Check to ensure that your installation will conform to all applicable codes and secure necessary permits. All electrical and plumbing connections should be made by qualified electricians and plumbers.

WARNING: FAILURE TO FOLLOW THESE INSTRUCTIONS DURING INSTALLATION WILL RESULT IN TERMINATION OF THE WARRANTY:

- Do not lift the tub by any portion of the plumbing or pump.
- Do not stand in the tub during construction.

DO NOT MAKE ANY ALTERATIONS, ADDITIONS, OR DELETIONS TO THE WHIRLPOOL SYSTEM, PUMP OR BATH.

WARNING: Whirlpool pump and piping are factory assembled. Relocation of pump or other modifications could adversely affect the performance and safe operation of this whirlpool. Aquatic shall not be liable under its warranty or otherwise for personal injury or damage caused by any such unauthorized modification.

QUIETNESS OF OPERATION: Aquatic has engineered their whirlpool baths from base to lip to ensure quality, value, functional design, and maximum bathing comfort. However, installation is accountable for as much as 50% of a tub's operating quietness. Please ensure the following:

- The floor structure is adequate to support the installation.
- For quieter operation and heat retention conservation, the walls surrounding the whirlpool may be insulated.
- Insulate the tub surround. Do not allow any insulation to come within 3 feet of the pump. The area around the pump must be clean and free of any foreign matter.
- Leave 1/8" to 3/16" gap between tub lip and surround.
- Spread a bed of cement mortar on the floor or subfloor under the whirlpool to reduce vibration and noise.

INSTALLATION INSTRUCTIONS

STRUCTURAL PREPARATION

NOTE: The bath should remain in its shipping carton until time of installation.

1. Literature dimensions are for reference only. Installation dimensions should be taken directly from the tub.
2. Building materials and wiring should be routed away from the pump body or other heat-producing components. An access panel of 16" w x 16" h minimum must be provided at the pump end of the whirlpool allowing sufficient clearance to make final connections and for servicing the pump and control units. Access may be through the wall or platform apron at the end of the unit. In the case of sunken installations, access should be made through the ceiling below.

IT IS THE INSTALLER'S RESPONSIBILITY TO PROVIDE SUFFICIENT SERVICE ACCESS. MAKE ABSOLUTELY CERTAIN THAT ACCESS PANELS AND/OR SERVICE OPENINGS ARE PROPERLY PLACED AND THAT ALL POSSIBLE AREAS WHERE SERVICE MAY BE REQUIRED ARE ACCESSIBLE.

3. Install the drain fitting to the bath. Clearance may be needed for the drain by cutting away the subfloor (where possible) or by blocking below the tub as may be required.

WARNING: FACTORY SKIRTS DO NOT ALLOW FOR BLOCKING UP OF THE TUB BASE. All blocking must be solid and provide uniform support to the tub base.

PLEASE NOTE: Estate versions with the black ABS support bases need to be set in a bed of mortar. This will help in leveling the tub on uneven floors and will help in reducing vibrations and noise.

4. Tub must rest entirely on all leveling feet or ABS Support Base. **DO NOT SUPPORT THE WEIGHT OF THE TUB BY THE RIM.** Lift unit and place into framework. Secure the unit by fastening the bottom feet to the sub floor with any construction adhesive caulk. For quieter operation and heat conservation, the walls surrounding the unit may be insulated.
5. Frame out under the tub rim as shown in one of the illustrations below. **NOTE:** Due to the variety of installations possible, framing procedures other than those described may be required. Plumb in selected location using a level. Level front to back and across both sides. A ledge under the rim, or an apron without a ledge, may be constructed as required (see Figures 1A, 1B and 1C). Where installation will be against a wall, stud wall framing should allow for wall sheathing material to run full length to the floor (see Figure 1D). Install tub firmly against sheathing as indicated, with blocking below rim to prevent deflection or movement of tub. To prevent a rocking movement of tub after installation, it is important to have rim in contact, but not supported by blocking material.

NOTE: Watertight installation of the drain and overflow is the installer's responsibility. Drain and/or overflow leakage is not included in the warranty of this product.

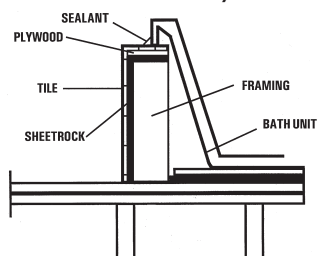

1A Ledge Installation - 1

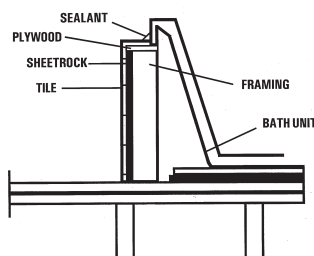

1B Ledge Installation - 2

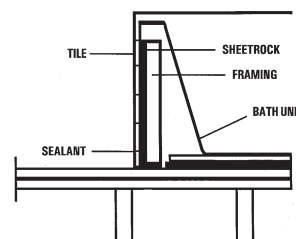

1C Apron Installation

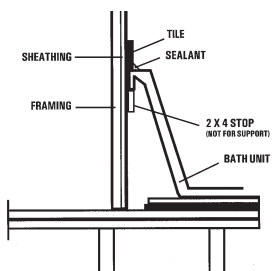

1D Wall Installation

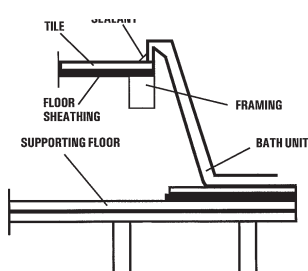

1E Sunken Installation

WARNING: ALL ELECTRICAL CONNECTIONS SHOULD BE MADE BY A LOCALLY LICENSED ELECTRICIAN.

INSTALLATION INSTRUCTIONS

STRUCTURAL PREPARATION (CONTINUED)

6. When placing the tub on a platform or cut out, the opening should be 1" smaller than the specified rim dimensions. Extreme care must be taken in this type of installation to ensure the tub will come to rest entirely on the leveling feet or ABS Support Base.
7. IF YOU HAVE PURCHASED A WHIRLPOOL WITH AN INSTALLED TILE FLANGE, PROCEED TO INSTRUCTION LISTED BELOW.

FACTORY INSTALLED TILE FLANGE

SEE FIGURE 2

- A. Install the unit per the instructions provided in this manual.
CAUTION: THE TILE FLANGE DOES NOT SUPPORT THE TUB! A ledger board must be provided under the bath rim as indicated in the installation instructions. Take care to ensure tub is not hanging from the ledger boards, as this will void your warranty.
- B. Use nails or screws to secure the flange into the studs around the bath.
- C. Install water resistant drywall against the tile flange and flush to the top of the whirlpool deck. Install the tile or other finishing materials. Apply a second bead of silicone between the first course of tile and the bath deck.

NOTE: Before tub is used, the whirlpool system should be cleaned in accordance with the procedures on Page 22 of this manual.

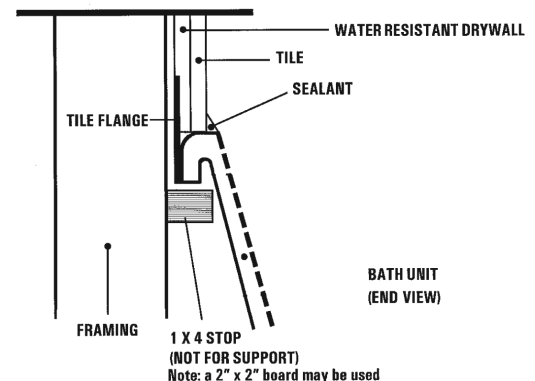

FRAMING AND PRE-INSTALLATION — INTEGRALLY SKIRTED MODELS

SANTA CRUZ and SANTA CLARA:

1. Protect interior of tub throughout installation procedures.
2. Before moving unit into alcove see and follow enclosed Electrical Installation Procedures (electrical hookups will be difficult to perform if unit is installed first.)

IMPORTANT! BEFORE INSTALLATION BEGINS, MAKE SURE THAT:

1. Framed-in alcove is of proper size, square and plumb.
2. Walls and floors meet fire safety requirements of local building code and/or FHA/HUD Minimum Property Standards. Before installation of the panel, fill the unit, test the whirlpool system for proper operation and check for leaks, then drain.
3. A mortar base is prepared (this is mandatory for proper installation).

INSTALLATION INSTRUCTIONS

FRAMING DIAGRAMS

1. Protect interior of tub throughout installation process.
2. Framing and supports will vary according to the model and type of installation selected.
3. Please refer back to the unit's Technical Data sheet for specific dimensions located at www.aquaticbath.com.

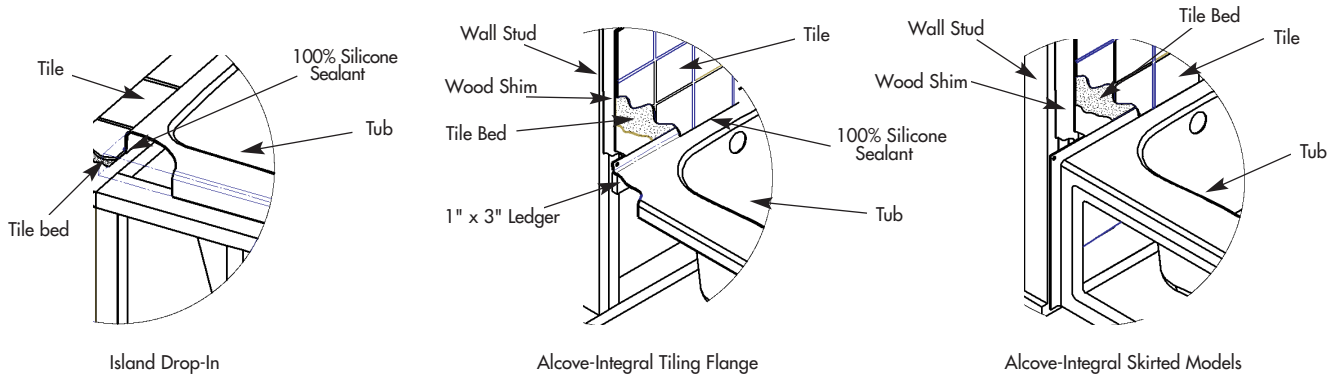

RECTANGULAR MODELS CORNER MODELS OVAL MODELS

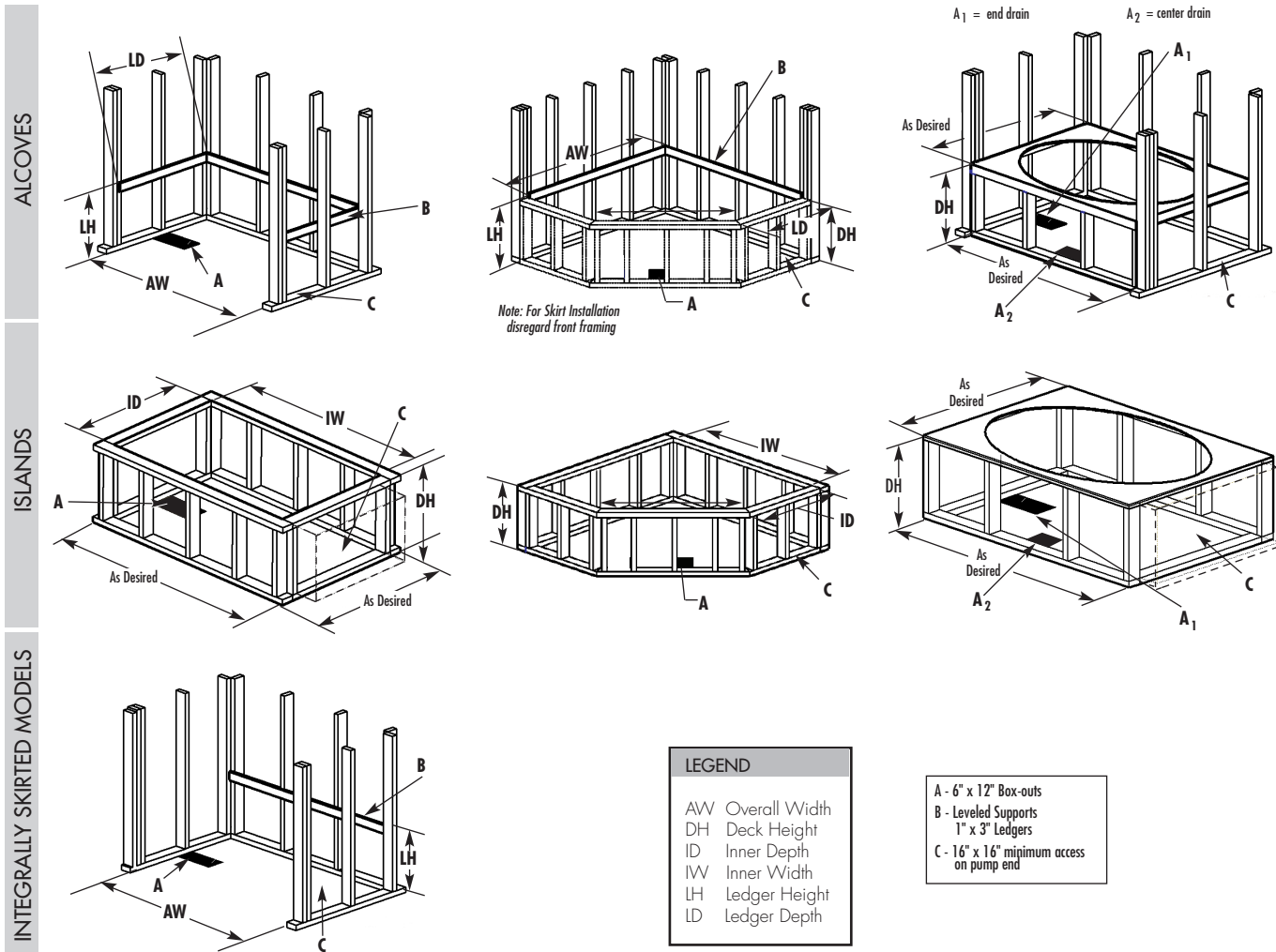

INSTALLATION INSTRUCTIONS

DECK CUTOUTS

A paper template will be enclosed with all rounded-edged models. Use the directions on the paper template for cutout dimensions. **If the paper template has been lost or needs replacement, please contact Customer Service at: 800.945.2726.**

USING THE CUTOUT TEMPLATE

Draw a center line horizontally and vertically on a 1" thick plywood deck. Place the template in the upper left hand quadrant, noted as Quadrant 1 on the diagram below. Trace template to outline Quadrant 1. Flip the paper cutout horizontally, making sure to match the dotted center line on the template with the center line on the plywood. Trace again to outline Quadrant 2. Repeat until the remaining quadrants of the cutout have been traced.

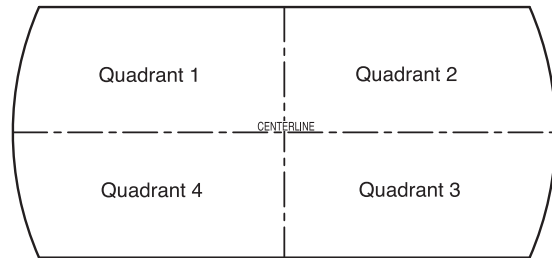
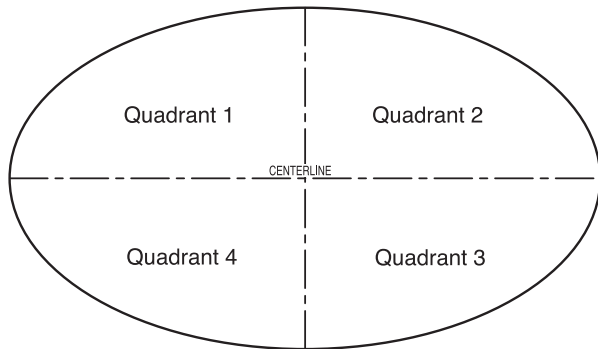

CORNER MODELS

On a 1" thick plywood deck, place the template in the upper section noted as Section 1 in the diagram. Trace Section 1 to establish the centerline and front edge of the cutout. Flip the template along the centerline and trace to complete the other half of the unit noted as Section 2 in the diagram below.

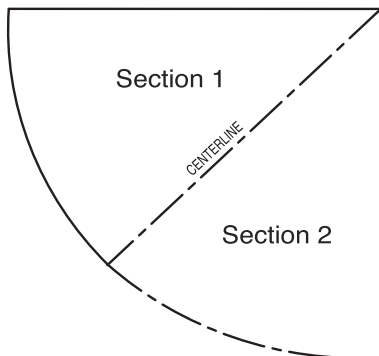

RECTANGLE MODELS

Using a 1" thick plywood deck, the cutout should be 2" smaller than the overall tub dimensions (length & width), for 1" overhangs on all sides. For example, a 72" x 42" unit should have a deck cutout of 70" x 40". Additional dimensions can be found in the technical data sheets at www.aquaticbath.com.

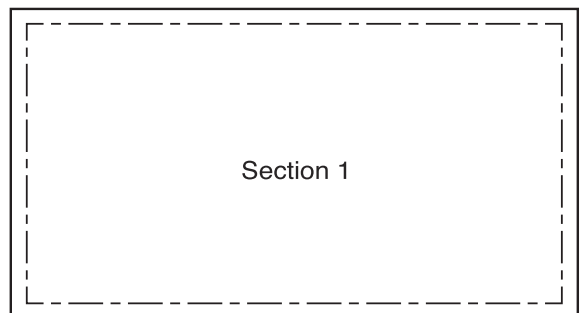

INSTALLATION INSTRUCTIONS

INSTALLATION PROCEDURES FOR INTEGRALLY SKIRTED MODELS

1. To avoid obstructions during installation, make sure water lines, spout pipes and valve plumbing do not project into alcove.
2. **Ledger Strip:** Fasten a 1" x 3" (25mm x 75 mm) ledger strip along rear for alcove and along both sides in corner installations at Dimension LH. (See Figure 5A)
3. Place three or four mounds of plaster away from drain hole in a line or square, approximately twice as high as the cavity under the tub bottom.
4. Place tub into alcove with front skirt firmly on floor and depress plaster mounds. Make certain that back ledge of tub rests firmly on ledger strip. (See Figure 5A)
5. See and follow **Sealing & Finishing** Figure 5B.

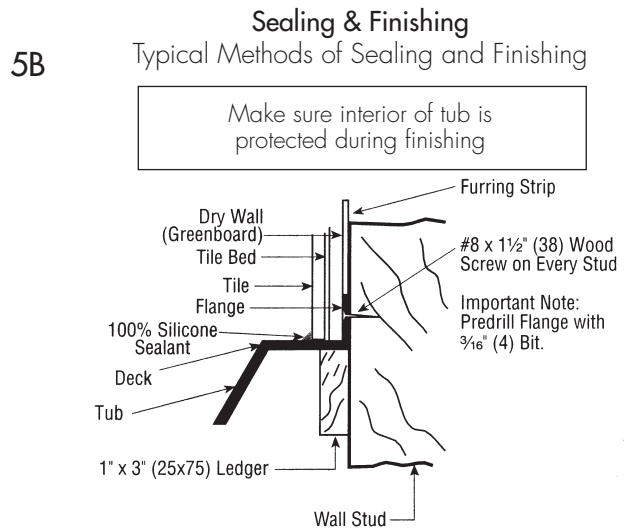
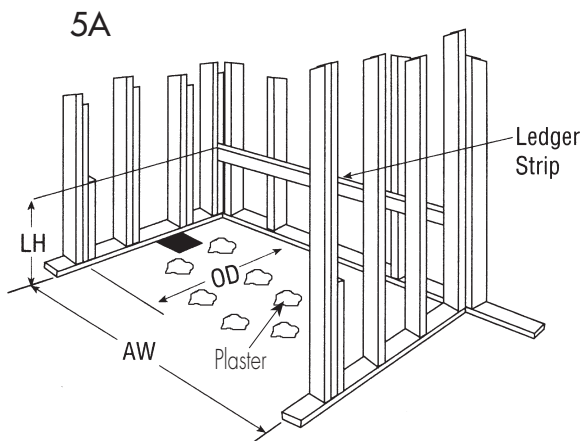

REMOVABLE SKIRT PANELS FOR INTEGRALLY SKIRTED MODELS

These models are offered with removable panels. It provides a flush-to-wall installation (sheet rock overlaps skirt while still providing access). The skirt features a decorative removable panel enabling easy access to motor, pump and electrical hookups. Clips enable simple and quick removal of skirt access panel.

Important: Before installation of the panel, fill the unit, test the whirlpool system for proper operation and check for leaks, then drain.

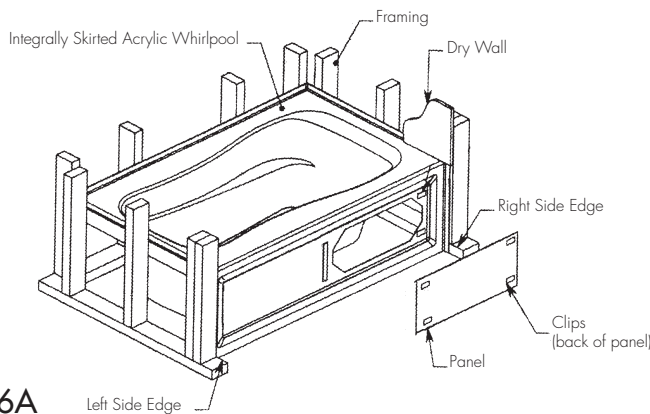

6A Left Side Edge

INSTALLATION INSTRUCTIONS

PLUMBING

1. After securing tub in place, normal waste and overflow, water spout and valves are installed per normal plumbing procedures, in accordance with all state and local standards.
2. Install standard 1-1/2" trap to drain and overflow. Before proceeding make final operational check by filling tub with water to overflow and operate pump for 10 minutes. Check for leaks carefully both while pump is running and has been turned off. Allow water to stand in tub for at least 30 minutes before draining. **Aquatic WILL NOT BE RESPONSIBLE FOR WATER DAMAGE OF ANY KIND IN CONNECTION WITH ONE OF OUR WHIRLPOOL BATHS.**

NOTE: For rough-in measurements, please refer to unit's technical data sheet.

FINAL SYSTEM TEST & CLEAN-UP

System Test

To test system, follow these steps in order listed:

1. Fill clean tub with water to a point no less than 2" (50) above the highest jet.
2. To test the Ground-Fault Circuit-Interrupter (GFCI), push the test button. The GFCI should interrupt power. Push the reset button. Power should be resorted. If the GFCI fails to operate in this manner, there is a ground current flowing, indicating the possibility of an electric shock. Do not use this unit. Disconnect the unit and have the problem corrected by a licensed electrician before using.
3. Push on/off button on the whirlpool.
4. Allow system to run a full 10 minutes.
5. Through access door or removable skirt, check for leaks in whirlpool plumbing system. Make sure half-unions at both ends of pump are hand-tight. If leakage is occurring at any other points, notify distributor.
6. If any electrical malfunctions occur, immediately unplug the unit and consult a licensed electrician. Malfunctions of the pump/motor, whirlpool controls or the circulating system should be reported to the distributor who supplied the whirlpool tub.

Clean-up

1. Remove all construction residue and foreign materials. Wipe unit clean with a damp rag, otherwise staining may occur.
2. Plaster may be removed by scraping with the edge of a piece of wood or rigid plastic. **DO NOT** use metal scraper. For spots left by plaster or grout: rub lightly with a liquid detergent (Spic-N-Span® or similar) on a damp cloth or sponge.
3. **DO NOT** use abrasive cleaners, scouring powders, steel wool, wire brushes or anything else that may harm or dull the surface.
4. Paint, tar or stubborn stains may be removed with paint thinner, turpentine or rubbing alcohol. To avoid discoloration, cleaners containing petroleum distillate must not remain on surfaces. **NEVER** use lacquer thinner or chlorinated solvents.
5. Dulled areas can be restored to a high gloss with white or cream-colored automotive rubbing compound, followed by application of carnauba wax or white or cream automotive paste wax and buffing.
6. Major gouges require professional repair. Contact Aquatic to arrange factory-authorized repair services.

INSTALLATION INSTRUCTIONS

ELECTRICAL INSTALLATION

WARNING: ALL ELECTRICAL CONNECTIONS SHOULD BE MADE BY A LICENSED, LOCALLY CERTIFIED ELECTRICIAN, IN ACCORDANCE WITH THE REQUIREMENTS OF THE STATE AND LOCAL ELECTRICAL CODES AND PROCEDURES.

WARNING: WHEN USING ELECTRICAL PRODUCTS, BASIC PRECAUTIONS SHOULD ALWAYS BE FOLLOWED, INCLUDING THE FOLLOWING:

Optional Chromatherapy

DANGER: RISK OF ELECTRIC SHOCK! This unit requires one dedicated circuit, two dedicated circuits for optional chromatherapy, each protected by a Ground Fault Circuit Interrupter (GFCI). A GFCI is not supplied, however we do specify its use. All known code authorities require a GFCI. Rough in wiring to pump on a dedicated 120V, 15 amp, GFCI protected circuit. If tub has the optional chromatherapy, rough in wiring to chromatherapy box on a dedicated 120V, 15 amp, GFCI protected circuit.

PLEASE SEE FIGURE 3 ON PAGE 16

BONDING WIRE: Connect a #8 bare copper bonding wire from the pump motor to the heater (option) and/or to the cold water plumbing or other suitable ground. Grounding is required.

For built-in and custom units, install to permit access for servicing.

Optional Chromatherapy and Heater

If the unit has optional chromatherapy and optional heater, then the unit requires three dedicated circuits, each protected by a Ground Fault Circuit Interrupter (GFCI). A GFCI is not supplied, however we do specify its use. All known code authorities require a GFCI. Rough in wiring to pump on a dedicated 120V, 15 amp, GFCI protected circuit. If tub has the optional chromatherapy, rough in wiring to chromatherapy box on a dedicated 120V, 15 amp, GFCI protected circuit.

BONDING WIRE: Connect a #8 bare copper bonding wire from the pump motor to the heater (option) and/or to the cold water plumbing or other suitable ground. Grounding is required.

For built-in and custom units, install to permit access for servicing.

INSTALLATION INSTRUCTIONS

ELECTRICAL INSTALLATION, CONT.

Estate Component Breakdown

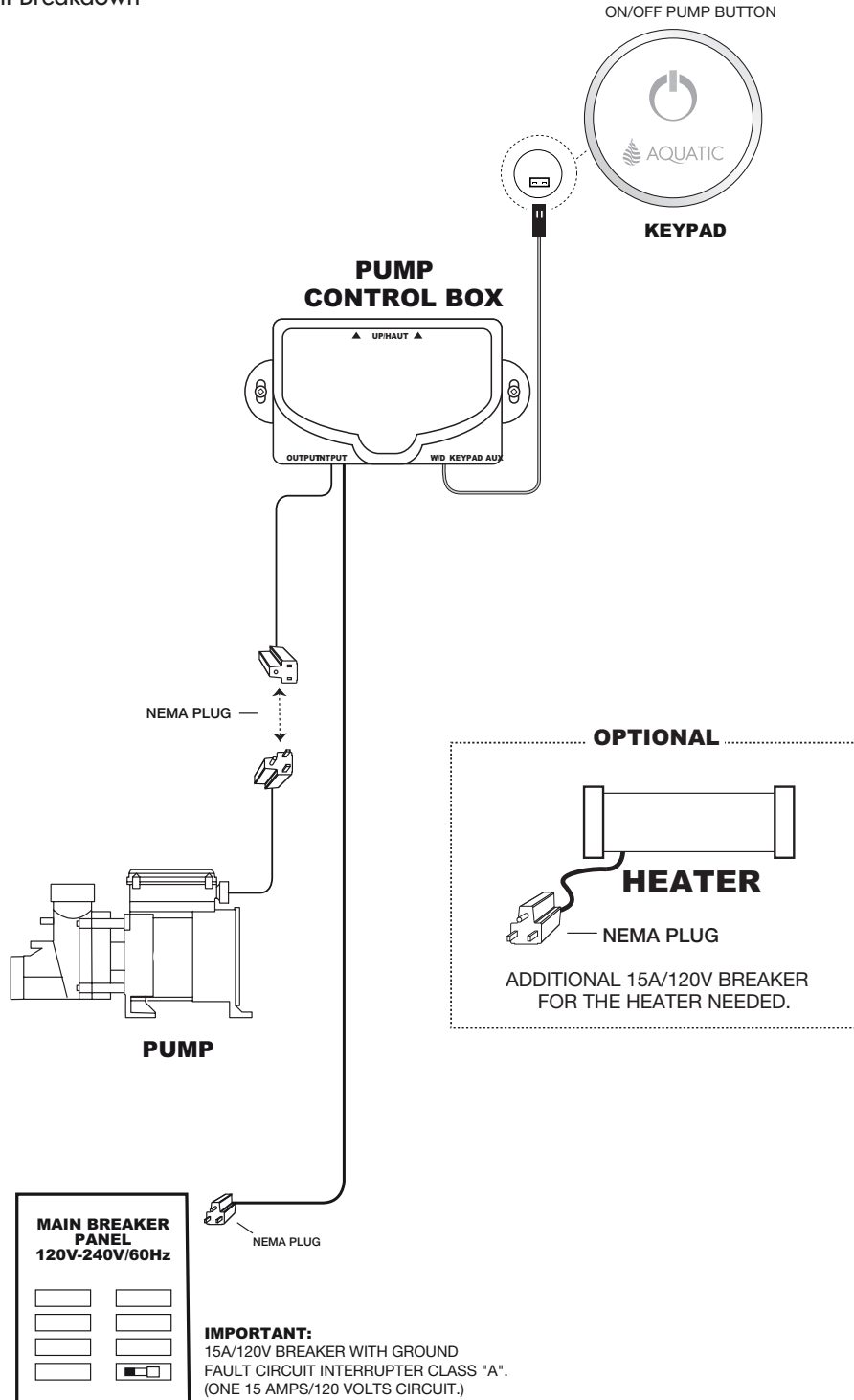
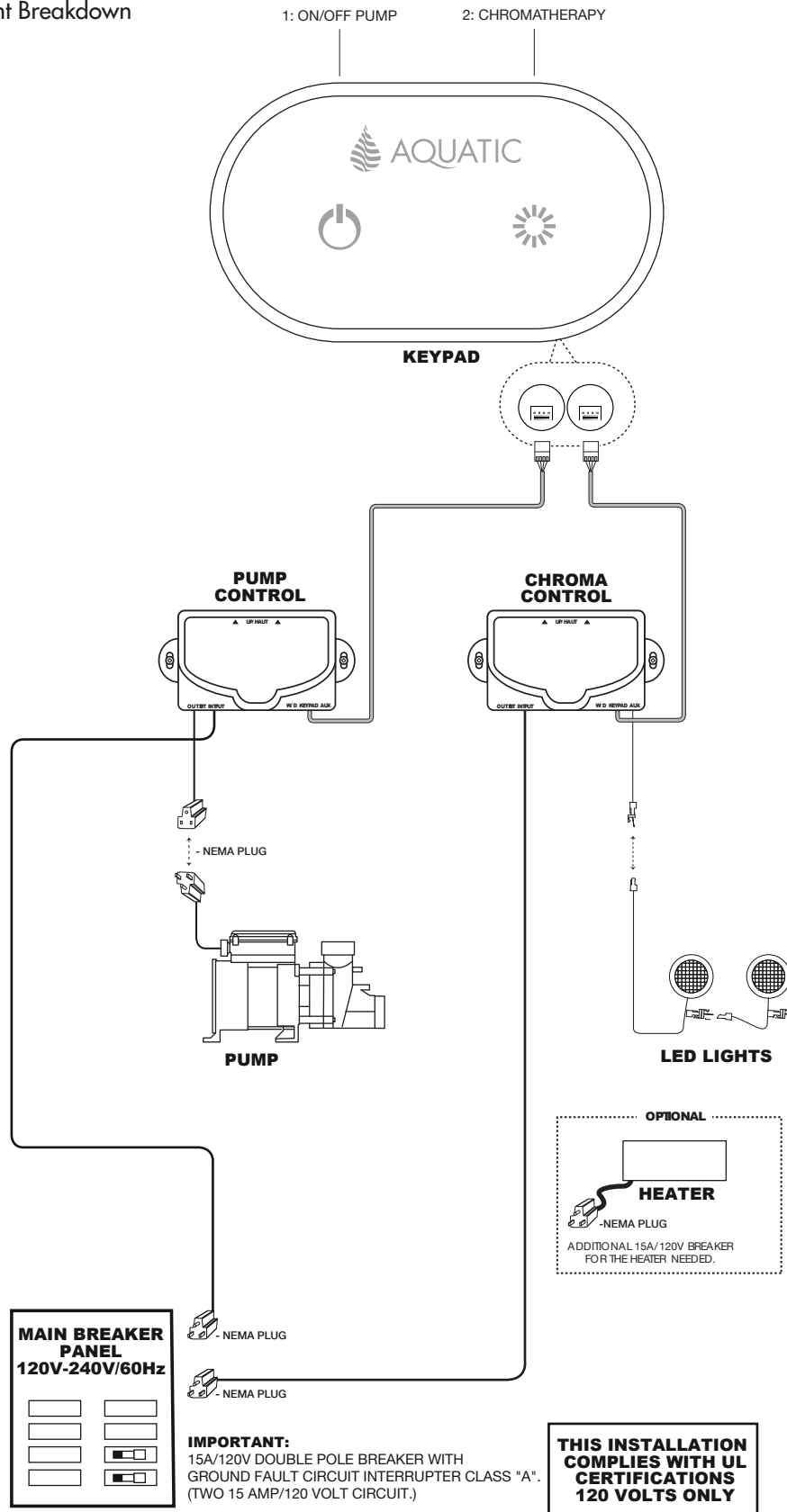

Figure 3

ELECTRICAL INSTALLATION, CONT.

Estate Component Breakdown



INSTALLATION INSTRUCTIONS

OPTIONAL INLINE MAINTENANCE HEATER OPERATING INSTRUCTIONS

Operation of the inline maintenance heater is completely automatic. The heater will help maintain the temperature of the water in the whirlpool. The heater includes the following components:

THERMOSTAT: The "Smart Thermostat" requires no adjustment and will automatically maintain the water temperature at 102° F - 104° F. If the whirlpool is too warm, simply adjust by adding cold water.

INDICATOR LIGHT: The light on the heater turns on when the heater is operating.

PRESSURE/VACUUM SWITCH: The heater is equipped with a preset pressure or vacuum switch. The pump must be running with water flowing to the whirlpool to allow the heater to turn on.

CAUTION: Before use of the pump and heater, test the GFCI for proper operation. The pump and heater should turn off when the GFCI "Test" button is pushed.

Warning - Prolonged Immersions in Hot Water May Induce Hyperthermia.

Hyperthermia occurs when the internal temperature of the body reaches a level several degrees above the normal body temperature of 98.6° F. The symptoms of hyperthermia include an increase in the internal temperature of the body, dizziness, lethargy, drowsiness, and fainting. The effects of hyperthermia include (1) failure to perceive heat, (2) failure to recognize the need to exit the whirlpool, (3) unawareness of impending hazard, (4) fetal damage in pregnant women, (5) physical inability to exit the whirlpool, (6) unconsciousness resulting in the danger of drowning.

WARNING - The use of alcohol, drugs, or medication can greatly increase the risk of fatal hyperthermia.

INSTALLATION OF ELECTRONIC ON/OFF TIMER CONTROL

1. Plug the On/Off Timer Control into a dedicated 120-volt, minimum 15-amp outlet.
2. Plug the pump into the On/Off Timer Control.
3. Wait 10 – 20 seconds (for self-calibration) before you depress the On/Off Button.



1- Speed Timer Box



Electronic On/Off Button

OPERATION OF WHIRLPOOLS

NOTE: DO NOT START PUMP UNTIL ALL JETS ARE SUBMERGED. WATER LEVEL SHOULD BE 2" ABOVE HIGHEST JET.

BATHSIDE CONTROL SYSTEMS

On/Off Controls:

The **On/Off Electronic Button with Timer** is the On/Off Button for the pump/jet action for the Estate Series.

- **One-Speed Pump**
 1. Make sure water level is approximately 2 inches above the highest jet.
 2. Push the On/Off Button once to turn the pump on. The whirlpool has a built-in timer and will automatically turn off in approximately 20 minutes. To restart the pump, simply push the On/Off Button.
 3. When the motor is running, push the On/Off Button to turn the pump off.



Electronic On/Off Button

OPTIONAL CHROMATHERAPY LED LIGHT

KeyPad Functions	
1: On/Off Pump	
1st Press:	The pump starts
2nd Press:	The pump stops
2: Chromatherapy	
1st Press:	Turn on the light in white
2nd Press:	Rainbow cycle – Low speed
3rd Press:	Rainbow cycle – High speed
4th Press:	Turquoise
5th Press:	Blue
6th Press:	Magenta
7th Press:	Red
8th Press:	Orange
9th Press:	Yellow
10th Press:	Green
11th Press	Turn off the light <i>(Press and hold 2 seconds at any time to turn off the light.)</i>

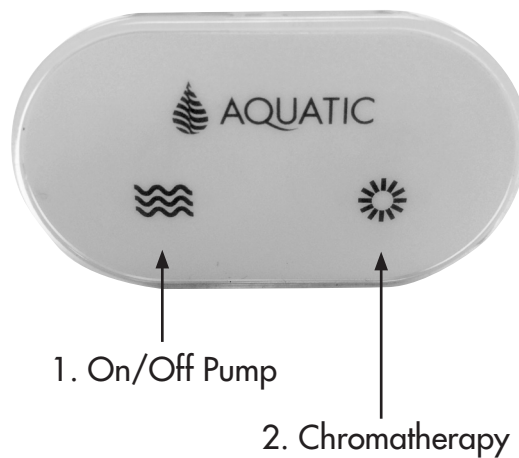

OPERATION OF WHIRLPOOLS

JET OPERATIONS

Estate Series Whirlpool Jets

The Estate Series combines **High-flow directional jets** and **Dual-port high-flow spinning jets** to provide an invigorating hydrotherapy experience.

High-flow Directional Jets

Designed to facilitate targeted, deep tissue massage therapy. Each jet is fully adjustable for direction of water flow and intensity of pressure.

Dual-port High-flow Spinning Jets

Aquatic dual-port high-flow spinning jets feature two side-by-side oval ports through which water moves simultaneously in opposite directions to create a constant circular motion. This unique design effectively creates a consistent, even massage for the user's neck, back, and shoulder areas.

- **To adjust pressure:**
 1. Grasp the outer ring of the jet.
 2. Turn the outer ring clockwise to increase flow, counter-clockwise to reduce flow.
- **To remove jet (see Figure 7):**
 1. Grasp the outer ring of the jet.
 2. Turn the jet counter-clockwise, until the jet clicks, then pull.
- **To replace jet (see Figure 7):**
 1. Insert the jet into jet housing.
 2. Turn the jet clockwise, past point of resistance, until the jet clicks.

Note: Rotational swirl jet added for targeted lower back massage.

Figure 7



INSTALLATION INSTRUCTIONS

TO REPLACE LED LIGHT

1. Disconnect the power to your bathtub.
2. Drain the bathtub.
3. Open the lens of the fixture using ONLY the proper tool provided for that purpose. Do not attempt to remove the lens without the provided tool.
4. Replace your LED light (replacement LED lights can be obtained from Aquatic).

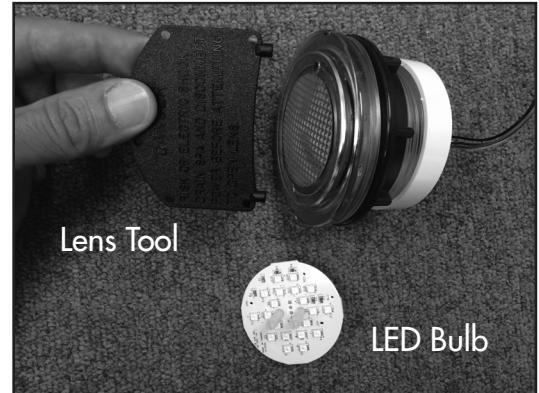

NOTE: Do not twist LED light into socket. Use gentle pressure and push LED light into place.

TUB CARE

MAINTENANCE

Before tub is used, the whirlpool system should be cleaned and disinfected. Remove all debris and clean tub before putting whirlpool into service. **DO NOT USE ABRASIVE CLEANERS ON THE ACRYLIC FINISH.** Use a non-abrasive detergent and rinse well after cleaning.

- Fill the tub with HOT water to a level 2" above the highest jet.
- Add 4 – 6 tablespoons of low-sudsing automatic dishwashing detergent and no more than 24 – 48 ounces of household bleach to the water.
- Operate whirlpool for 10 minutes. Drain.
- Refill with cold water and operate whirlpool for 5 minutes. Drain.

Whirlpool System Cleaning

To remove accumulations of bath residue from the whirlpool system, we recommend that you purge it at least twice a month, or more depending on usage. To do this, follow this simple procedure. Fill the bath with hot water (not exceeding 140° F). Add to the hot water, 4 – 6 tablespoons of low foaming detergent such as liquid Cascade or Calgonite and 24 – 48 oz. of liquid household bleach, such as Clorox [Do not use splashless bleach. Use lesser amounts shown for 5-foot bathtubs, greater amounts in parentheses for larger bathtubs]. Run the bath for 5 to 10 minutes. Drain the bath completely and refill with cold water only. Run the whirlpool for 5 to 10 minutes, then drain the bath completely. Depending on the usage and/or the content of the local water supply, more frequent purging may be necessary.

NOTE: DO NOT USE OIL OR OIL BASED BATH ADDITIVES.

If you want to use any kind of bath additive, use only a small amount of low-foaming powder or crystal substance; the whirlpool action intensifies the foaming properties of soaps. The use of certain bubble baths and bath additives may increase the level of accumulations of bath residue in the whirlpool system. If excess accumulations persist, you should discontinue use of these products.

If you have followed the monthly purging instructions and still have an excess accumulation of bath residue and desire an alternative cleaning mechanism, we recommend **SUPER SYSTEMS CLEAN PLUS** manufactured by Stearns Packaging Corporation to rectify this condition. This may be obtained by calling Aquatic, at (800) 945-2726. It is recommended that you follow the instructions provided by the manufacturer with the product. Repeated use may be necessary. **SUPER SYSTEMS CLEAN PLUS** does not replace the necessity to purge your whirlpool system at least twice a month with a low foaming detergent and bleach.

Surface Cleaning

Use common household, non-abrasive cleaners for most cleaning jobs. Rinse well and dry with a clean cloth. Never use abrasive cleaners. Do not allow your Lucite® acrylic surface to come into contact with products such as acetone (nail polish remover), nail polish, dry cleaning solution, lacquer thinners, gasoline, pine oil, etc. Remove dust with a soft, dry cloth. Clean grease, oil, paint, and ink stains with isopropyl (rubbing) alcohol.

TUB CARE

Jet Cleaning

All Estate Series jets are removable, and can simply be put into the dishwasher for easy cleaning. See **JET OPERATION** for removal, page 20. (**NOTE:** Use top rack of dishwasher and remove before the drying cycle starts.)

Surface Scratch Removal

Minor scratches may be removed by polishing your tub with a non-abrasive car polish, followed by buffing. Deeper scratches can be removed by:

- Sanding with wet 400 grit sandpaper.
- Sanding with wet 600 grit sandpaper.
- Sanding with wet micro-grit sandpaper.
- Buff out using car polish.

REPAIR

The installation and service of your whirlpool bath should be performed only by a qualified service technician. Remember when contacting your dealer always have your serial number, proof of purchase and model number available. This will ensure a quick response on warranty items.

The model and serial numbers are located above the pump on the backside of the whirlpool.

NOTE: ALL WARRANTY REPAIRS MUST BE AUTHORIZED BY AQUATIC BEFORE WORK IS STARTED. FOR SERVICE, ALWAYS CONTACT YOUR DEALER.

CAUTION: Care should be taken to prevent inappropriate chemicals coming in contact with the Lucite® acrylic surface. Please read and observe all instructions and/or warnings on containers containing substances you contemplate applying to your whirlpool. Any failure to comply may void your warranty.

WATER QUALITY

CHEMICAL & WATER QUALITY

Owners of fill and drain whirlpool bathtubs need to know basic information concerning water quality, how it affects the performance and enjoyment of the operation of their tubs, and steps that can be taken by the owner to correct related problems. Important issues are the microbiological and chemical quality of the water.

1. Microbiological Quality

Microbes are present in water supplied by individual wells or water systems and even in the air around us. These microbes are usually in amounts below what is noticeable. Microbes from the water or air or from a bather's body may settle on wetted surfaces such as a whirlpool bathtub's surface or piping system where they can grow in numbers where we can notice them. With regards to whirlpool bathtubs, brown/black fungi/mold or pigmented (colored) bacteria can be noted.

Fungi/Mold - Fungi and mold are always present. Usually the levels are such that we don't notice them. When moisture and temperature are sufficient, the organisms will grow to levels that we may smell and/or see. The best examples of such growth is the very common black growth on the bottom of shower curtains. The best solution to keep these surfaces free from the growth is frequent cleaning.

Pigmented Bacteria - Water utilities from all over the United States have experienced calls from consumers inquiring and complaining about pinkish substance on bathroom fixtures that is very persistent, appearing in the shower, sink and along the water line of toilet bowls. With whirlpool bathtubs, the formation of this colored substance may be particularly pronounced in white tubs. The residue is less likely a problem associated with water quality than with naturally occurring airborne bacteria. The bacteria may produce a pinkish film, and sometimes a dark gray film, on surfaces that are regularly moist, including toilet bowls, shower heads, sink drains, and tiles. The problem is more common in humid areas of the country. In any particular case, the determination of the exact species of bacteria causing the problem would require lengthy and costly laboratory testing; however, most experts believe the bacteria responsible is *Serratia marcescens*. These bacteria thrive on moisture, dust and phosphates, and are widely distributed in soil, food and also in animals. The American Water Works Association (AWWA) suggests that short of buying pink fixtures, the best solution to keep these surfaces free from the bacterial film is continual cleaning. The AWWA recommends a chlorine containing compound as the best cleaner and avoiding abrasives to avoid scratching fixtures, which will make them even more susceptible to bacteria.

2. Chemical Quality

The water supplied by individual wells or water systems always contains chemicals, usually in amounts below those which the consumer would notice. Examples of such chemicals, which are of potential concern for the owners of fill and drain whirlpool bathtubs, are calcium and magnesium salts, copper, iron, manganese and sulfates. When these chemicals are present in sufficient amounts, they may cause problems in whirlpool bathtubs. You should contact your water supply or treatment company and follow their suggestions for treatment.

Calcium and Magnesium Salts - Collectively, the various compounds of calcium and/or magnesium are referred to as salts. Calcium and magnesium salts are often found in ground water supplies and cause "hardness" in water. Hard and soft water are relative terms. Hard water retards the cleaning action of soaps and detergents, causing expense in the form of extra work and cleaning agents. When hard water is heated, it will deposit a hard scale. With regard to whirlpool bathtubs, high calcium and/or magnesium levels may result in the formation of white stains and scale formation on the inside of the tubs, especially noticeable with colored tubs. If this occurs, you need to contact the water supplier to determine the calcium and/or magnesium content and/or corrosion potential of the water and follow their suggestions for treatment. If you are on an individual well, you need to contact a water treatment company to test your water and suggest solutions if a problem is present.

WATER QUALITY

Iron - Iron is found in many natural waters especially from wells. Iron in water can also result from the corrosion of piping in the water supply system, such as cast iron mains or galvanized steel service lines, or galvanized piping in the home water system. High iron levels may result in the formation of brown stains in the vicinity of the faucet outlets of various fixtures in the home. With whirlpool bathtubs, the staining may be particularly pronounced because the aeration action can oxidize iron to a form that settles out on the inside of the tubs, especially noticeable with white tubs. If high iron in the water is present, you can also notice rust colored deposits inside your toilet tank or dishwasher. If this occurs, you need to contact the water supplier to determine the iron content and/or corrosion potential of the water and follow their suggestions for treatment. If you are on an individual well you need to contact the water treatment company to test your water and suggest solutions if a problem is present.

Manganese - Manganese is found in many natural waters especially from wells. High manganese levels may result in the formation of small black particles that can stain laundry, especially noticeable with whites such as sheets or towels. With whirlpool bathtubs, the formation of small black particles may be particularly pronounced because the aeration action in the tub can oxidize manganese to an insoluble form that is especially noticeable with white tubs. If high manganese in the water is present, you may also notice black stains on white laundry. If this occurs, you need to contact the water supplier to determine the manganese content of the water and following their suggestions for treatment. If you are on an individual well, you need to contact a water treatment company to test your water and suggest solutions if a problem is present.

3. Treatment

If you have contacted your water supplier and followed its instructions and you are still having problems, you need to increase the frequency of applications of low-foaming detergent/bleach starting from monthly purging down to using it every other day as required to eliminate your particular problem. The use of certain bath oils, bubble baths and bath additives may increase the level of accumulations of bath residue in the whirlpool system. More frequent cleaning may be necessary if these products are used in the whirlpool tub. If excess accumulations persist, you should discontinue the use of these products. If you have followed the monthly purging instructions and still have an excess accumulation of bath residue and desire an alternative cleaning mechanism, we recommend SUPER SYSTEMS CLEAN PLUS (Aquatic Part #ST1010) manufactured by Stearns Packaging Corporation to rectify this condition. This may be obtained by contacting Aquatic at (800) 945-2726. It is recommended that you follow the instructions provided by the manufacturer with the product. Repeated use may be necessary. SUPER SYSTEMS CLEAN PLUS does not replace the necessity to purge your whirlpool system at least once a month with a low foaming detergent and bleach.

TROUBLESHOOTING GUIDE

WARNING: Always turn off power at the main electrical service panel when servicing your whirlpool.

SYMPTOMS	POSSIBLE PROBLEMS	SUGGESTED SOLUTIONS
Motor does not start	<ol style="list-style-type: none"> 1) GFCI or circuit breaker in OFF position. 2) Fuses blown or thermal overload open. 3) Locked motor shaft. 4) Motor windings burned out. 5) Defective starting switch inside single-phase motor. 6) Disconnected or defective wiring. 7) Low voltage. 	<ol style="list-style-type: none"> 1) Reset GFCI (if optional heater is installed, be sure there are two GFCI circuits.) 2) Contact your electrician. 3) Contact Aquatic 4) Contact Aquatic 5) Contact Aquatic 6) Check and reconnect if needed. 7) Contact your electrician.
Motor does not reach full speed	<ol style="list-style-type: none"> 1) Low voltage. 2) Wiring too small. 	<ol style="list-style-type: none"> 1) Contact your electrician. 2) Contact your electrician.
Motor overheats (protector trips)	<ol style="list-style-type: none"> 1) Low voltage. 2) Inadequate ventilation. 3) Wiring too small. 	<ol style="list-style-type: none"> 1) Contact your electrician. 2) Refer to installer/dealer. 3) Contact your electrician.
Chromatherapy light doesn't function	<ol style="list-style-type: none"> 1) Not plugged in. 2) Bulb burned out. 	<ol style="list-style-type: none"> 1) Plug in. 2) Replace bulb.
Pump delivers no water	<ol style="list-style-type: none"> 1) Jets are closed. 2) Leakage of air into suction system. 3) Impeller clogged. 	<ol style="list-style-type: none"> 1) Open jets. 2) Check suction screen for clogs. 3) Clean and unplug.
Low pump capacity	<ol style="list-style-type: none"> 1) Suction or discharge line partly plugged. 2) Pump running at reduced speed. 3) Impeller clogged. 	<ol style="list-style-type: none"> 1) Clean and unplug. 2) See "Motor does not reach full speed." 3) Clean and unplug.
Noisy pump and motor	<ol style="list-style-type: none"> 1) Worn motor bearings. 2) Pumps touching a stationary object. 3) Suction line partly plugged. 4) Pump not supported properly. 5) Low voltage 	<ol style="list-style-type: none"> 1) Contact Aquatic 2) Refer to installer/dealer. 3) Clean and unplug. 4) Contact Aquatic (If you have a remote pump, refer to installer/dealer.) 5) Contact electrician.
Leakage of water at shaft	<ol style="list-style-type: none"> 1) Shaft seal requires replacement. 	<ol style="list-style-type: none"> 1) Contact Aquatic
Leaking unions	<ol style="list-style-type: none"> 1) O-ring missing or damaged. 2) Plumbing in a bind. 3) Loose unions. 	<ol style="list-style-type: none"> 1) Contact Aquatic 2) Contact Aquatic 3) Tighten unions.
Vibration noise	<ol style="list-style-type: none"> 1) Tub or tub plumbing is in contact with tile/wall. 2) Pump is in contact with framing. 	<ol style="list-style-type: none"> 1) Refer to installer/dealer. 2) Refer to installer/dealer.

REPLACEMENT PARTS LIST

ILLUSTRATION NO.	PART #	DESCRIPTION
1A.	8186ASSYxx	FULL SIZE DIRECTIONAL JET
1B.	8186VJTB	VJET BODY
	8186BDY	90 DEGREE JET BODY
	8186WFTG	WALL FITTING
2A.	8184ROTxx	STRESSEAZ JET INTERNAL
2B.	8184JTB	STRESSEAZ JET BODY
2C.	8180NUT	JET NUT
3A. (OPTION)	8095HEATER	1.5 KW MAINTENANCE HEATER
3B.	–	2PC. HEATER SPLIT NUT
3C.	–	GASKET / O-RING
3D.	–	1.5" X 1" TAILPIECE
4A.	8150UNION	1.5" PUMP UNION
4B.	8108MOTOR	1 HP / 120V PUMP
5A.	8501CONTROL	CONTROL BOX;TMS;W/P ON/OFF
5B.	8171KEYPAD	KEYPAD;TMS; ESTATE+HOTSOAK
6A.	1126xx	SUCTION COVER
6B.	–	SUCTION WALL FITTING
6C.	–	SUCTION ELBOW
	1119SLIP	SUCTION SAFETY VALVE
7A. (OPTION)	901806GRAB	BOLT ON GRAB BAR (WH)
	901807GRAB	BOLT ON GRAB BAR (BI)
	901800GRAB	BOLT ON GRAB BAR (CH)
	901801GRAB	BOLT ON GRAB BAR (PB)
	901802GRAB	BOLT ON GRAB BAR (BN)
	901805GRAB	BOLT ON GRAB BAR (ORB)
8A.	9017WHGRAB	GRAB BAR (WH)
	9017BIGRAB	GRAB BAR (BI)
	901710GRAB	GRAB BAR (CH)
	901720GRAB	GRAB BAR (PB)
	901760GRAB	GRAB BAR (BN)
	901780GRAB	GRAB BAR (ORB)
	4174ACROD	GRAB BAR (CLEAR)
	4011GROMET	GROMMET (WH)
	4013GROMET	GROMMET (BI)
	4001GROMET	GROMMET (CLEAR)
9A. (OPTION)		GEBERIT CABLE DRIVE WASTE & OVERFLOW
10. (OPTION)	8500PAD	KEYPAD KIT;TMS TIMER/LIGHT
11.	8441FTG+5982MANIFOLD	1" CHECK VALVE ASSEMBLY
12A. (OPTION)	8500CONTROL	CONTROL BOX;CHROMATHERAPY 120V
12B. (OPTION)	8020LIGHTS	CHROMATHERAPY;20LEDS BULB;RND CLR
12C. (OPTION)	8LIGHTTOOL	LENS REMOVAL TOOL
12D. (OPTION)	8020LIGHTS	20LEDS CHROMATHERAPY BULB
13A.	8180ROTxx	ROTATIONAL SWIRL JET
13B.	8180JTB	ROTATIONAL SWIRL JET BODY
13C.	8180NUT	JET NUT

To indicate color, replace XX with "WH" for White, "BI" for Biscuit, "BO" for Bone

REPLACEMENT PARTS MAP

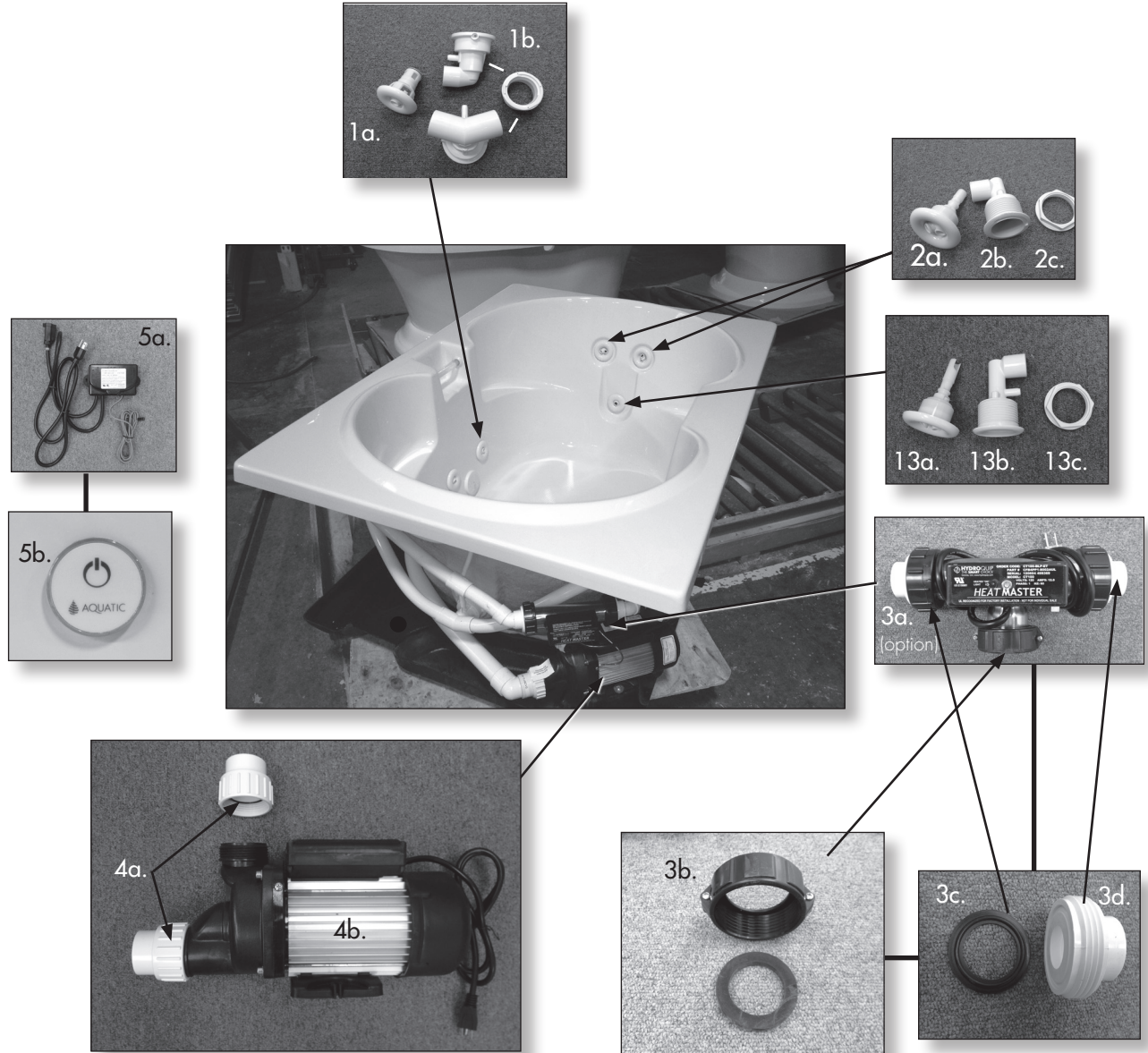

REPLACEMENT PARTS MAP

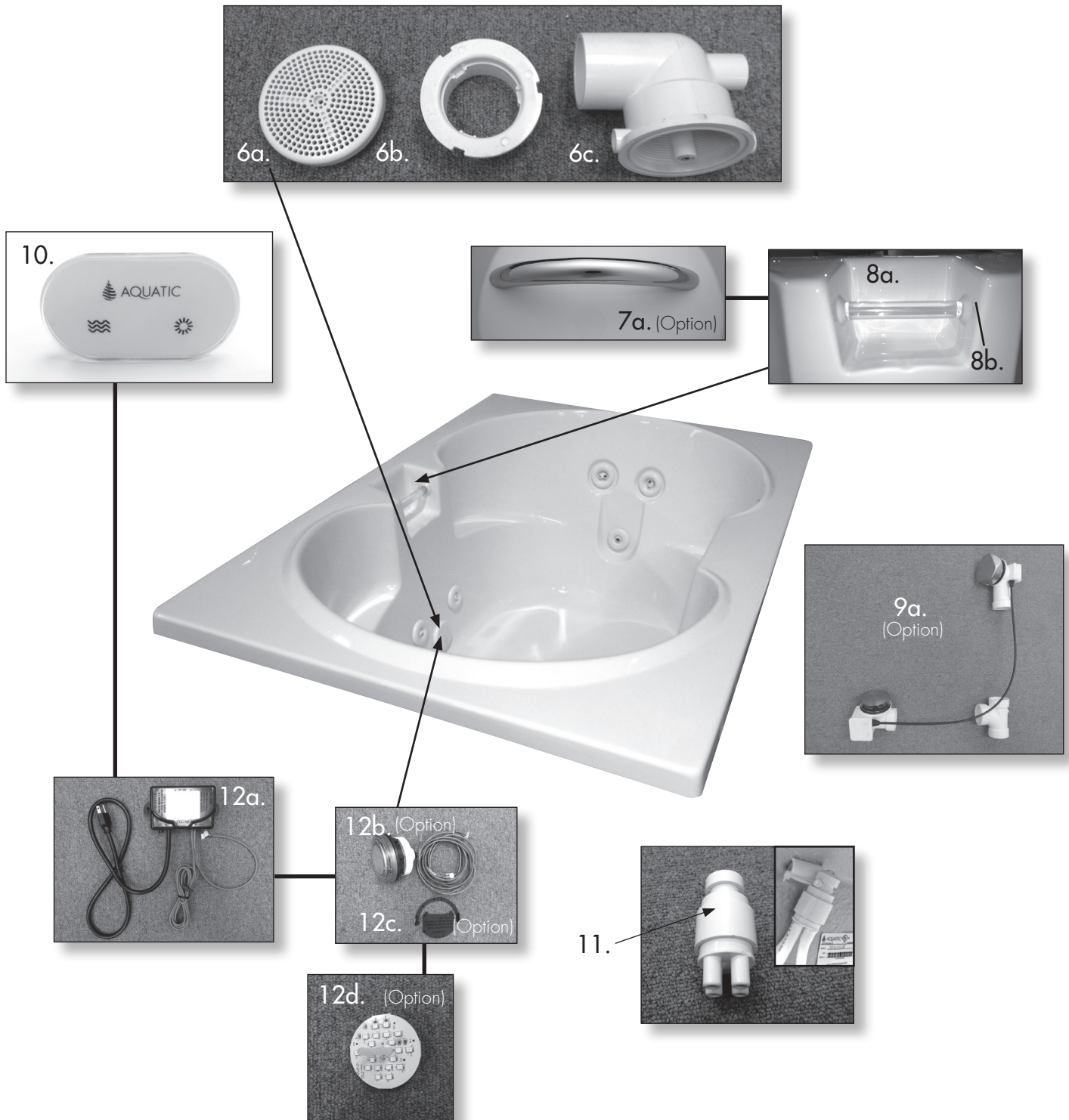



AQUATIC

The bath people

Customer Service: 800.945.2726 • aquaticbath.com