

Tools you might need for proper installation:

- 6 D Galvanized Nails or Screws
- Large Level
- Hammer or Screw Gun
- Carpenter's Square
- Adhesive
- Small Wrench
- Tape Measure

Thank you for purchasing a Walk-In Tub. For best results, please read and follow all directions carefully.

## PRE-INSTALLATION PLANNING

### 1. Care and Testing

- a. Do not store the Walk-In tub outside and be sure to keep out of sunlight and exposure to weather.
- b. Never lift the tub by the piping. Lift only by the tub main deck. Inspect the tub for damage or storage/ Verify that the tub specifications are correct. If damage or shortage has occurred notify the distributor or freight carrier immediately.
- c. All Walk-In tubs are factory tested for leaks and general operation. Because of handling and shipping, it is recommended that you also perform a similar test prior to installation: Plug drain with duct tape and fill with water. Have the electrician make a temporary, safe, grounded G.F.C.I. protected connection. Press the off/on button and check for leaks at all pipe connections.
- d. If any leaks or controls fail to operate properly, do not proceed with installation. Immediately call 800.443.7269 and ask for the Warranty Department.

### 2. Determine Your Tub Size

- a. If you are replacing a 60" tub with a new Walk-In tub, a color coordinated tub extension kit is available to fill the area and create a decorative ledge. See Figure 1.
- b. If you plan to finish the area with tile, install green board or its equivalent and tile the area. Plan the framing to match the size of the tiles. See Figure 7 in this manual for more details.

### 3. Whirlpool Installation Planning

If your Walk-In tub is a whirlpool, the suction line will exceed the overall depth of the unit which means the back flange will not fit against the stud wall. Build out a frame ledge away from the studs approximately 3/8". See Figure 1B

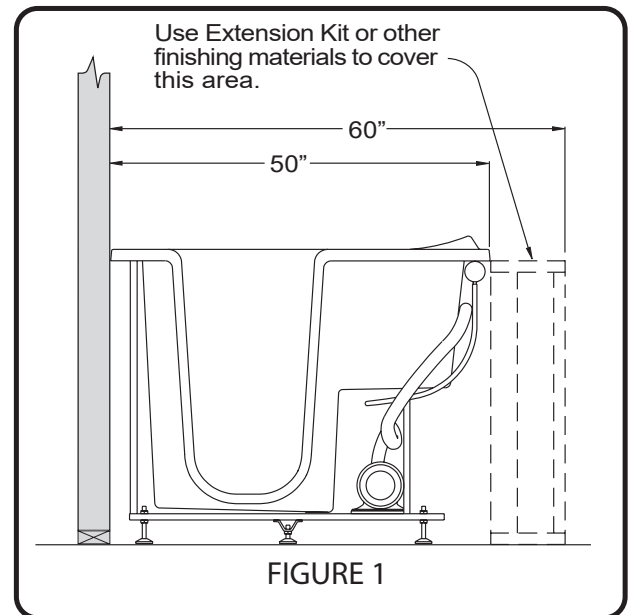

**NOTE:** Before installation, adjust tub levelers for proper height. Space from floor to bottom edge of tub rim must be 36- 3/4" to provide clearance for front cover panel installation. Take care to test fit all the cover panels for fit prior to moving the tub into the installation location. Adjust levelers if necessary. See Figure 3 for more details.

### 4. New Installations

For new installations, placement in the room is dictated only by the location of the tub door. Plan carefully so the entry into the tub is convenient and comfortable for the bather to enter and exit. If you are installing a handheld shower and/or grab bar, plan and install water supplies and reinforcement for grab bar mounting before you install the walk in tub.

5. A tub filler is not included with the BathBay Walk In tub so you may want to consider purchasing a high flow rate faucet so your tub will fill faster. Also consider using a faucet mixer with thermal protection. This will prevent



accidental scalding. These type of water fittings are available at the dealer where you purchased your Walk-In tub.

## 6. Electrical Precautions

**ELECTRICAL CONNECTIONS - ALL WIRING MUST BE DONE BY A QUALIFIED ELECTRICIAN.** If your Walk In tub is equipped with an Air System or a Whirlpool System, electrical power supplies must be provided. Each component requires a separate, dedicated circuit.

**CIRCUIT REQUIREMENTS:** 120V, 60 Hz, 15 A, protected with a GFCI (Ground Fault Circuit Interrupter) Class A connected at the main electrical service panel for each electrical component. The dedicated circuits should terminate with grounded receptacles installed in water resistant electrical enclosures. The Walk In tub components will be plugged into these receptacles. Locate the receptacles a minimum of 6 inches above the sub floor and located so they will be hidden from view when the installation is complete.

Access to the electrical components should be provided either by the removable access panel or by constructing a removable access through the wall board. Figure 1C

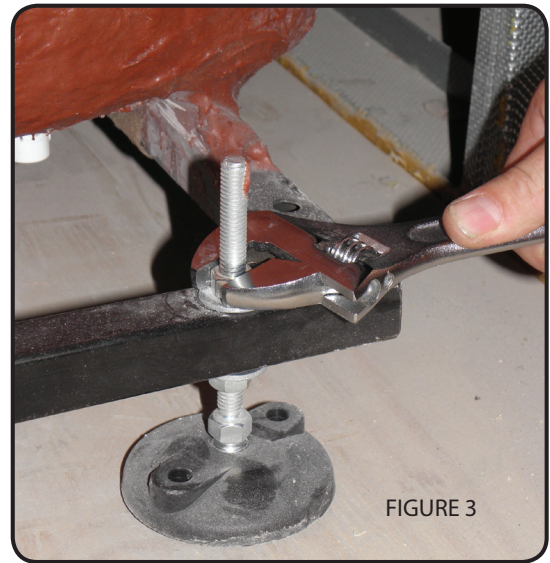

## INSTALLATION PROCEDURE

1. Begin by preparing your plumbing. You may be able to reuse the existing water supply lines. Extend the lines if required to meet the higher than typical walk in tub. Study the product diagrams and relocate drain line as required for connection to the overflow kit provided with your unit.

2. Install the faucet on the tub deck opposite the seat. Carefully measure and mark hole locations on the finished side of the tub. Double check hole locations and drill 1/4" pilot holes. Cut holes to final size using the appropriate size hole saw. Install faucet according to the manufacturers instructions.

3. Install the drain and overflow assembly on the tub following the directions enclosed in the overflow assembly carton. The assembly is a high quality, cable activated product that once installed will provide easy operation of the tub drain. Extend height of tub to maximum for drain install and reinstall back to 36-3/4".

4. Prepare the room walls in the install location so the tub may be placed along the framing. Refer to the applicable Product Diagram for the tub length, width and height. The wall board should be cut and removed at a height above the floor so the tub will fit against the studs. If you are using the available tub extension kit, or will extend the enclosure in some manner to account for the total 60 inch area, install the required stud framing at this time. Refer to Step 15, Figure 7 of this manual for more information. Before moving unit into place, the adjustable legs should be raised to 36 3/4" to allow the drain assemble to be fitted and the drain seal for the Tip/Toe closure. Once this is complete you may adjust the legs, lowering the product to its original height.

5. Install the metal hanger on the long side stud wall. Measure up from the floor 33 3/4". This will be the bottom of the metal hanger. Attach hanger through the slots to the studs with lag screws with flat washers. Blocking between the studs may be required. The tub rim will fit between the angled tabs of the hanger and framing studs. Some adjustment may be necessary. See Figure 2

6. Clean the area where the tub will be installed. This step is important so that all loose particles are removed and not be pulled into the blower and plug the air bubblers. The Walk In tub is mounted to a stainless steel welded support frame.

7. This frame has 6 leveling legs that may be adjusted independently to account for minor out of level floor conditions. The side cover panel that fits along the door side is provided with the tub. The tub levelers must be adjusted at the proper height to accommodate the panel. Adjust levelers so the opening for the cover panel is 36 3/4". Note that finished floor level must be at or below the finished bottom edge of the panel so it may be removed later should maintenance of the tub be required. See foot adjustment Figure 3

8. Carefully lift the walk in tub into position. Lower so the tub rim sets on the metal hanger. Confirm the tub fits as

you expect into the installation area. Make adjustments if necessary. Connect the water supplies to the faucet and overflow drain assembly to the waste pipe. Take care when installing the drain assembly to prevent damage to the air tubing or piping underneath the product.

9. Check the entire tub for level. Tub should be level from front to back and side to side. Adjust levelers as needed by simply turning the levelers as required. See Figure 3B.

10. The next step is to fill the tub for testing. Close and latch the tub door and turn on the water. As it fills, keep an eye on all fittings to check for leaks. When the tub is 3/4 full, shut off the water and recheck level. If the

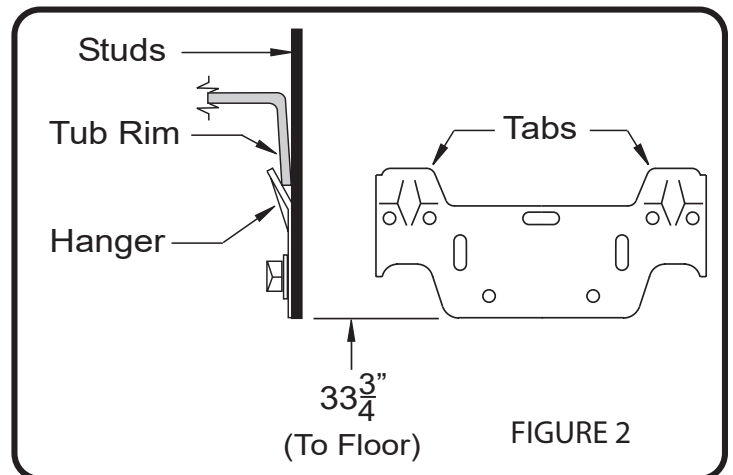
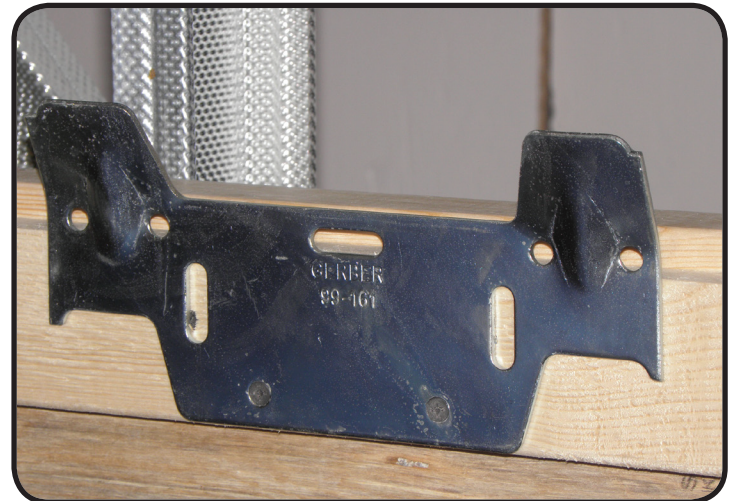

tub is not level, adjust the leveling feet as required.

Note that the front center leveling foot is for the door. If you notice any leaking from the door, adjust this leveler as needed.

11. Apply a bead of 100% silicone caulking to each point where the tub contacts the framing studs. Screw the room side levelers to the floor to prevent the tub from shifting.

12. If you are using the Tub Extension Kit, you probably will need to trim it before trial fitting. Carefully measure and cut the extension kit. There are a number of different configurations possible depending on the specific installation.

Carefully consider how you want to finish the area and install your support frame accordingly. Wood framing must be constructed at the end of the tub to support the Tub Extension Kit. An example of a typical installation is shown in Figure 7.

The Extension Kit may be permanently attached by using 100% silicone sealant or construction panel adhesive. Apply adhesive to trimmed edge of the end cap. Use care to avoid excessive use of adhesive so it will not be visible after all finish materials have been installed.

13. Finish the walls above the tub with water resistant materials such as ceramic tile or plastic wall surround panels.

#### CAUTION

If you use a RUBBER FLOOR MAT in this tub or shower unit it must be removed after each usage. If left in the unit, it may cause blisters or damage to the surface finish. Use of a rubber floor mat will void warranty.



FIGURE 3B

### DOOR OPENING ADJUSTMENT, FOOT ADJUSTMENT & STABILIZER RODS

The Walk-In tub's door opening width, adjustable feet and stabilizer bars come from the factory already adjusted for proper width, height and stability. However, due to variances in floor slope, slight modifications may be required for proper installation. The following instructions are to be used for these adjustments.

1. The minimum tub height to ensure proper drain installation is 37.5" from the top of the tub flange to the floor in which the tub is being installed on.

Using a tape measure, check the height of the tub at each foot (6 feet total). If the height is not a minimum of 37.5" then the foot will need to be adjusted to achieve the proper height Figure 9

2. Adjusting the feet. Begin by checking the levelness of the tub by placing a level on the top of the tub and

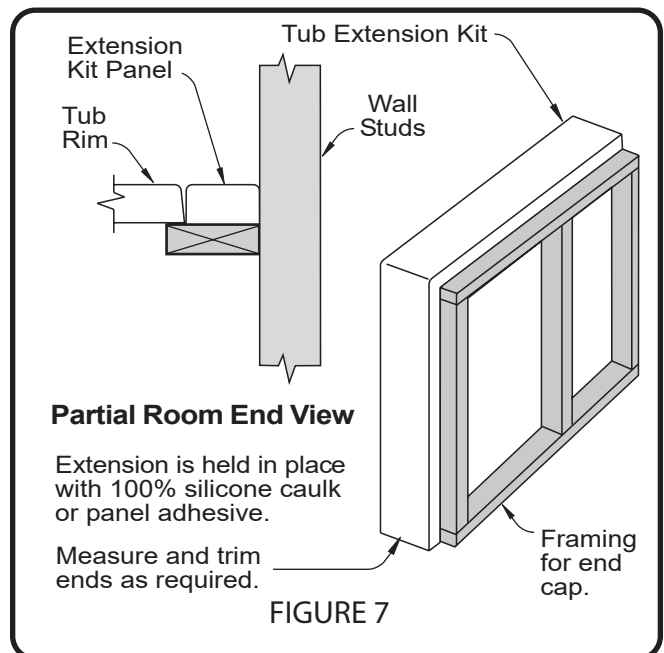

Partial Room End View

Extension is held in place with 100% silicone caulk or panel adhesive.

Measure and trim ends as required.

FIGURE 7

checking the level side to side and front to back. With the levelness determined, to adjust the feet start at a corner foot and loosen the top .375" nut approximately .5" by turning the nut counter clockwise. Adjust the bottom .375" nut up or down to achieve proper height. Repeat for the other five feet. Once all the feet have been adjusted to the proper height, check the levelness

again. Now that the levelness of the tub has been verified, tighten the top .375" nuts down against the frame. Figure 10

3. With the tub adjusted to the proper height, the door opening needs to be checked for the proper width. Figure 11

4. To adjust the door opening first begin by loosening the stabilizing rods .375" nuts. Figures 12 & 13 Loosen all 8 nuts approximately .5". Do not take the rods off. Just make sure the rods are not binding the tub's metal frame.

5. The door width opening is adjusted by raising or lowering the right (front) frame adjusting screw. Figure 14

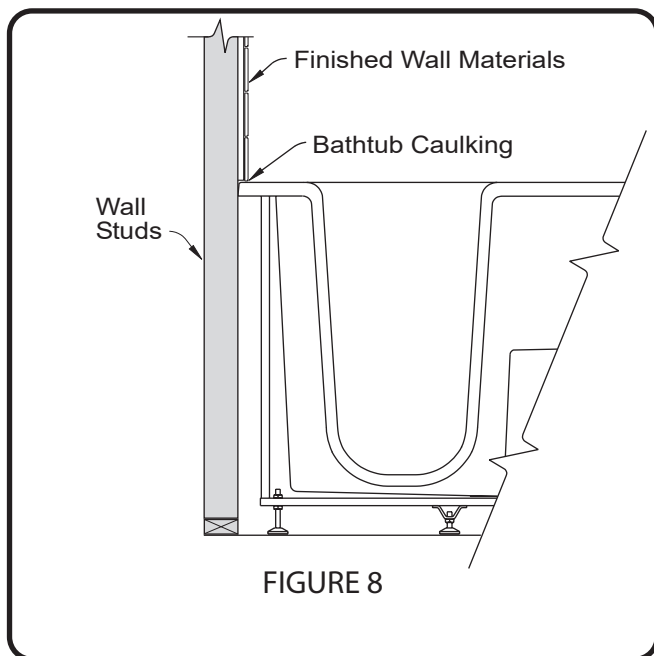

The right (back) frame adjusting screw should not require any adjustment.

NOTE: Example mentioned is a right-handed unit. For left-handed units, the frame adjusting screws will be on the left side of tub.

To ensure a water tight tub door, only small adjustments should be made to the adjustment screw.

6. To **EXPAND** the door opening, first loosen the UPPER adjustment screw nut approximately .25" by turning it counter-clockwise. Next tighten the LOWER nut by turning it counter-clockwise. FIGURE 15 This will cause the frame to expand the door opening. Make

small adjustments to the screws. Re-measure after each adjustment. Once the opening is at 17.25" tighten the LOWER nut back up.

7. To **DECREASE** the door opening, first loosen the LOWER adjustment screw nut approximately .25" by turning it clockwise. Next tighten the UPPER nut by turning it clockwise. FIGURE 16 This will cause the frame to decrease the door opening. Make small adjustments to the crews. Re-measure after each adjustment. Once the opening is at 17.25" tighten the LOWER nut back up.

8. Once the door opening has been properly set to

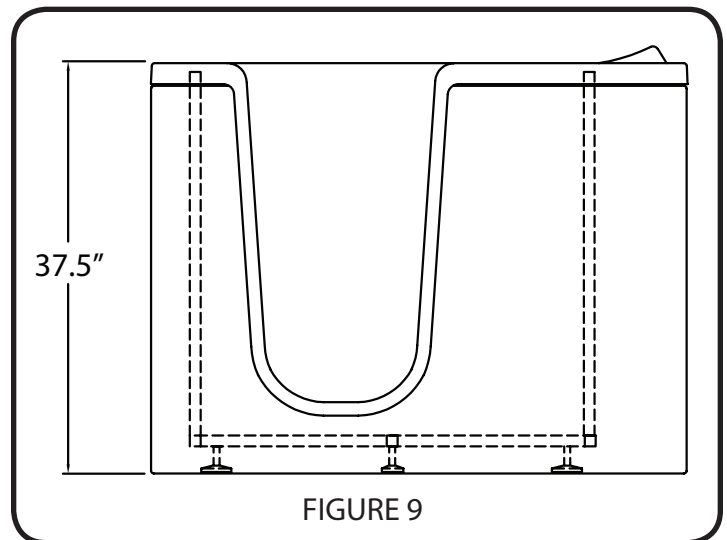

17.25", the stabilizing bar's .375" nuts (8 total) can be tightened. FIGURES 17 & 18

First, hand tighten the lower nuts against the frame, centering the rods. Then, tighten the upper nuts to secure using a wrench. Do not over tighten the nuts as this may cause misalignment of the tub's frame and door opening.

Once the stabilizing bar nuts have been tightened, check the door opening width to ensure that the proper width (20.24") has been maintained.

## CARE AND CLEANING

Clean your new Walk In tub with a household liquid detergent using a soft sponge cloth and warm water. More persistent stains, tar, or paint can be removed with naphtha or mineral spirits. Remove excess plaster by scraping with a sharpened softwood stick. Avoid wire brushes, metal scrapers or tools. Restore dull areas by rubbing with automotive type body cleaning compound.

DO NOT USE CAUSTIC OR ABRASIVE CLEANERS AS THEY

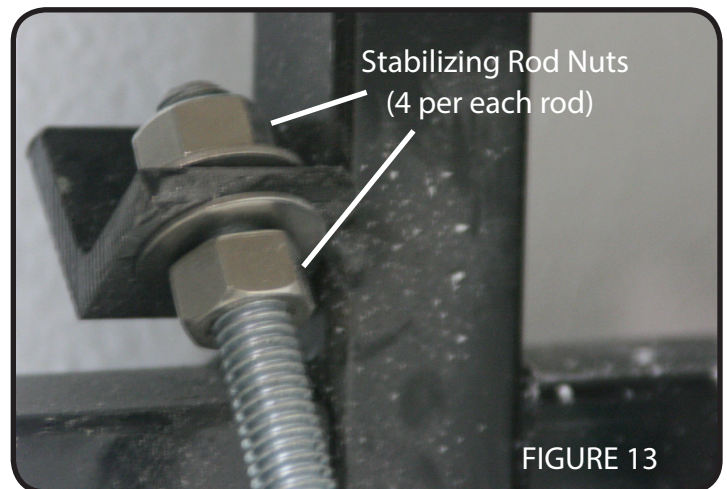
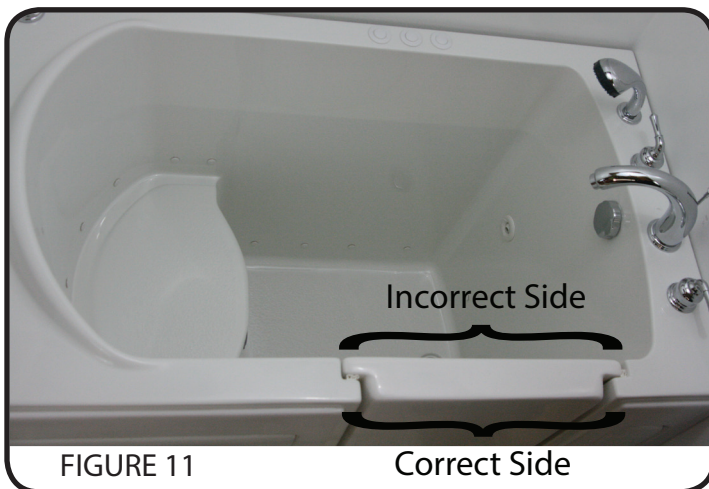
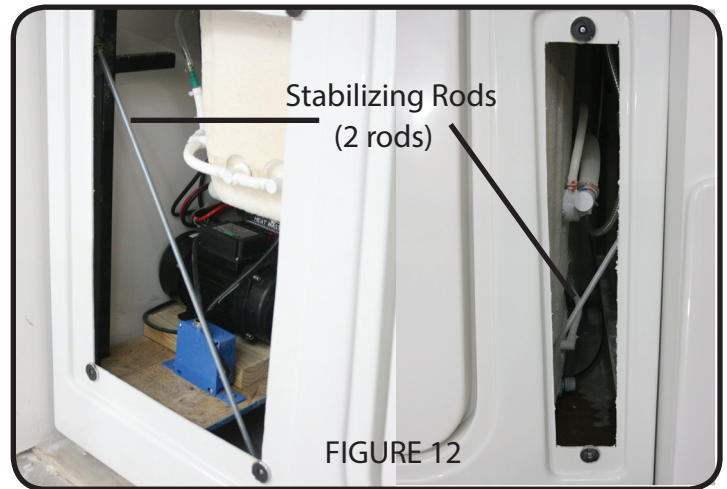
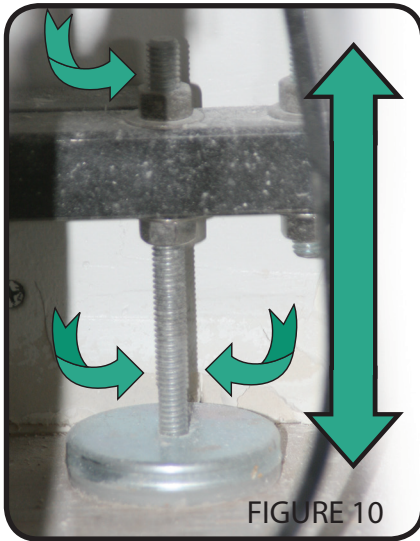

WILL DAMAGE THE FINISH OF YOUR WALK IN TUB.  
LIMITED WARRANTY

The Walk-In Tubs are under warranty for a period of:  
Three (3) Years for AcrylX™, Ten (10) Years Solid Surface,  
One (1) year, pump, parts, and accessories.

If the product has material defects, manufacturing defects or other labor defects, during the warranty period, it will be repaired or exchanged at the discretion of the warranty department of the manufacturer. The exchange of a unit is limited to supplying a replacement unit of comparable size and style and does not include any costs of removal or installation.

This warranty will be voided if the unit is moved from the place of initial installation, or is not installed in accordance with the instructions supplied by the manufacturer of the unit. Further, this warranty does not apply if the unit has

been subjected to accident, abuse, misuse, alterations, alteration of modifications by the buyer, or anyone representing the buyer. It does not cover damage caused by chemical corrosion, natural corrosion, flood, fire or any other act by force of nature.

The buyer of this product is fully responsible for the proper installation of this unit. The manufacturer will not be held responsible for any damages resulting from improper installation. Consult a plumbing professional if you feel you cannot install the Walk In tub.

This warranty does not apply to any equipment or accessories not installed by the manufacturer, and the manufacturer will not be held responsible for any results of such acts.

The owner agrees by use of this unit that the obligations

of the manufacturer shall not exceed to contingent or indirect damage or injury to the structure of its contents, that the obligations of the manufacturer are limited to those set forth herein, and that no other obligations, expressed or implied, are assumed by the manufacturing company.

All warranty will be implemented at the discretion of the Warranty Department upon the summation and evaluation of the circumstances involving the product installation.

For questions or a copy of the complete product warranty, contact: the Warranty Department at 800.443.7269.

## OPERATING INSTRUCTIONS

These operating instructions apply to tubs equipped with: Air Jets, Water Jets or both. Dual systems have separate controls for the Air and Water Jets.

NEVER begin filling the tub with the door open. For safety, the bather should be seated inside the tub, with the door latched shut before filling the tub with water.

When seated inside the tub, move the door to the closed position. Grasp the door closer handle and move the lever until the tear-drop shaped latches slide to a stop in the closed position.

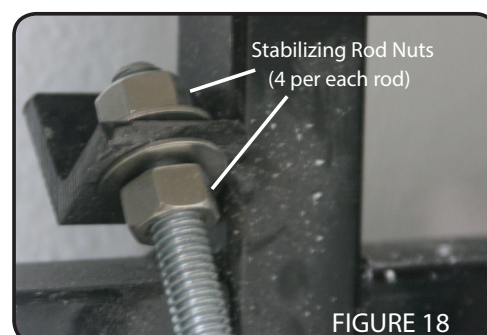
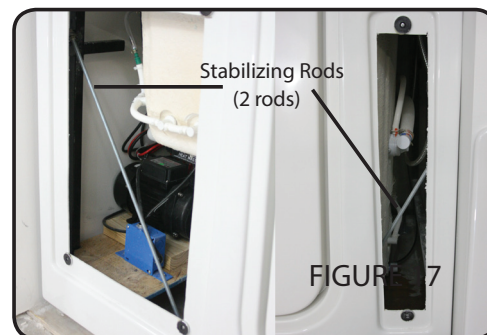
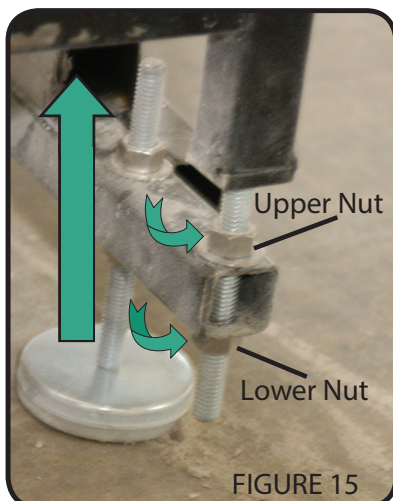
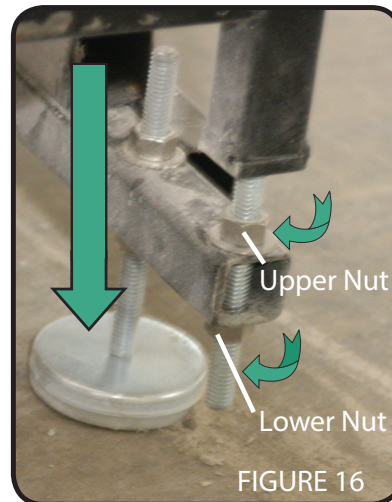
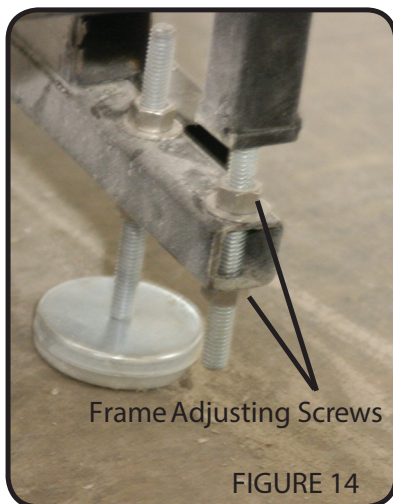



# Walk-In Tub Installation and Operating Instructions

AcryIX™ & Solid Surface Bathware

Confirm the door is latched shut before filling the tub. Always fill the tub to 2" above the highest air bubbler, or highest water jet.

## ON/OFF CONTROL OPTIONS

On/Off is controlled by an On/Off push button

**Push Button Operation** Press the On/Off push button to activate the system. The system will operate for 20 minutes and then automatically shut off. If additional time is desired, press the button again. If you wish to stop before 20 minutes has passed, press the button to stop.

**IMPORTANT: Automatic Drying Cycle**  
After the tub is drained, an AUTOMATIC drying cycle begins. The injector motor will turn on and operate for approximately 30 seconds.

**DO NOT INTERRUPT THIS CYCLE.** The system operates with the bathtub drained to eject any water that may have seeped into the air jet bubblers. The drying cycle eliminates any water, and will automatically operate and shut off without action required of the user.

If the On/Off control is pushed during the Automatic Drying Cycle, the system stops and resets. It will again begin the drying cycle 20 minutes later. **DO NOT INTERRUPT THIS CYCLE.** The Automatic Drying Cycle operates on tubs with the On/Off push button or the Electronic Control.

Tubs with Water Jets only do not have the Automatic Drying Feature.

## IMPORTANT SAFETY INSTRUCTIONS

Always drain tub before opening the tub door.

**NEVER** enter or exit the tub by climbing over the side. Enter the tub while it is empty, through the door. Climbing on the tub may result in slips and risk of injury.

Maximum soaking temperature should not exceed 104 degrees (F) 40 degrees (C). Consult a physician for specific temperature and length of use specifications, depending on health considerations.

Children, elderly or infirm bathers must remain under close supervision.

Do not use while under the influence of alcohol or drugs.

Use precaution while entering or exiting the bath to prevent accidental slips or falls.

Periodically test the Ground Fault Circuit Interrupter to insure it is working properly.

Customer Service | Technical Services | Warranty Services

American Bath Group  
Address: 435 Industrial Road  
Savannah, TN 38372  
Phone: (800) 443-7269



AMERICAN ★ BATH GROUP

Hamilton is a Praxis brand  
and a proud member of the  
American Bath Group

Rev. 07.11.23