

ALCOVE OWNER'S MANUAL BATHTUB WITH SYSTEM

INSTALLATION • OPERATION MAINTENANCE
BATHTUB REPAIR • WHIRLPOOL
BALNE-AIR • VIBRO-AIR



ICC-ES CERTIFICATION

Our products and their components have received ICC-ES certification, which attests to their quality and reliability.



CERTIFICATION ECORESPONSABLE

Our products have been certified ecoresponsible, recognizing Alcove's initiatives towards limiting its environmental footprint.



CONSUMER CHOICE

Alcove is the proud recipient of the 2017 consumer choice award.



98.2300.246.00

Do not discard. Save these instructions for further use

Table of contents

INTRODUCTION

Important safety instructions	3
Operating instructions	3

INSTALLATION

Bathtub installation: Before you begin	2
Required tools	2
Materials required	2
Important information to safeguard	3
Site preparation	3
Protective foam packaging	3
Recessed installation	3
Podium installation	4
Undermount bathtub installation	5
Installation of bathtubs with contour skirt	5
Faucet installation	6
Freestanding bathtubs with non-removable skirt	6
Installation of faucet components on the bathtub	7
Finishing walls, decks and podiums	7
System hook-up (electrical installation)	7

OPERATING INSTRUCTIONS

Electronic controls	12
Whirlpool: Adjustable jets	13
Whirlpool: Air induction	13
Backjets: Diverter valve (option)	13

MAINTENANCE

Routine cleaning	14
Balne-Air and Vibro-Air systems	14
Whirlpool maintenance	14
Acrylic repairs	14

TROUBLESHOOTING

Problems and solutions	13
------------------------	----

WARRANTY

	14
--	----

Thank you for selecting a Alcove product. Your trust plays a great part in this company's success.

Your new Alcove bathtub is a top of the line product that will give you years of pleasure and relaxation if it is installed and maintained correctly.

We encourage you to read and understand all of the safety, installation and maintenance instructions included in this owner's manual. It is strongly recommended that the installation of your bathtub be carried out by qualified and accredited professionals in accordance with governmental building codes and by-laws.

To download the online version of the user guide, visit www.alcove.ca

The documentation is available in *products*, by selecting your specific product.

- In order to protect the bathtub during installation a piece of cardboard should be cut out of the box and placed in the bottom of the bathtub. Make sure to use a piece without staples.
- Do not sit on the edge of the tub.
- If there is a protective plastic sheet covering the surface of your bathtub, it should not be removed until the installation is complete. When necessary during the installation process the plastic can be peeled back to install the drain, overflow and surface mounted plumbing fixtures. The plastic should also be peeled back in areas where it could become snagged during the installation process.
- If your bathtub is equipped with a Whirlpool, Balne-Air or Vibro-Air system you must test it before final installation. These systems are tested at the factory but can be loosened by transportation and installation.
- Remember that the Whirlpool, Balne-Air and Vibro-Air systems must be hooked-up before the final installation.

REQUIRED TOOLS

- Level
- Hole-saw (for surface mount faucet installation)
- Jigsaw for podium installation
- Safety glasses
- Tape measure
- Caulking gun
- Spanner

MATERIALS REQUIRED

- Bathroom grade (mildew resistant) silicone caulking
- Construction adhesive
- Adjustment shims (except for bathtubs equipped with adjustable feet)
- 25 mm X 50 mm wood strips for attachment to the walls
- 50 mm X 75 mm wood planks for building podium or apron
- 5/8" Exterior grade plywood for covering podium or apron
- No. 8 x 1 1/4" wood screws
- Bathtub drain and overflow kit (available from your Alcove dealer)
- Mortar (strongly recommended)







Installation

BATHTUB INSTALLATION: BEFORE YOU BEGIN

Before you begin the installation of your new Alcove bathtub it is strongly suggested that you do the following:

- Inspect your bathtub visually to make sure that it has not been damaged during transportation. If you suspect that there may be damage do not install the bathtub.
- Ensure that the bathtub is the unit that you ordered and that its dimensions and drain-side correspond to your plans.
- The bathtub should be placed in the bathroom. Make sure the floor is leveled and solid enough to support the weight of the bathtub when it is full (1000 lbs average). The feet of the bathtub must be in contact with the floor. It cannot be suspended by the perimeter alone.

IMPORTANT SAFETY INSTRUCTIONS

-  **WARNING: When using this unit and any electrical product, basic precautions should always be followed, including the following:**
-  **DANGER: Risk of electric shock.** This unit must be connected only to a circuit that is protected by a class-A ground fault circuit interrupter (GFCI). Grounding is required, this unit should be installed by a qualified service representative and grounded. Install to permit access for servicing.
-  **WARNING: Risk of electric shock.** A licensed electrician should make all electrical connections.
-  **WARNING: Risk of electric shock.** Disconnect power before servicing.
-  **WARNING: Risk of injury or property damage.** Please read and understand all instructions thoroughly before beginning installation, including the following requirements.
 - Follow all local plumbing and electrical codes.
 - Provide unrestricted access to the pump. Access must be provided for servicing the pump and controls. The access must be located immediately next to the pump.
-  **WARNING:** Unauthorized modification may cause unsafe operation and poor performance of the Whirlpool, Balne-Air and Vibro-Air systems.
 Alcove shall not be liable under its warranty or otherwise for personal injury or damage caused by any such unauthorized modification.
-  **WARNING:** Risk of child drowning. To reduce the risk of accidental drowning, do not permit children to use the bathtub unless they are closely supervised.

OPERATING INSTRUCTIONS

The following precautions should always be taken:

- The suction cover must be in place at all times to minimize the potential for hair and body entrapment.
- Keep body and hair a minimum of 15cm (6") away from the suction fitting at all times when the whirlpool system is operating. Hair longer than shoulder length should be secured close to the head.
- Never operate electrical appliances (telephone, television, radio, hairdryer etc.) inside or within 1.5m (5 ft) of the bathtub.
- Never leave small children unattended in the bathtub.
- Do not operate the whirlpool system unless the bathtub is filled with water to at least 5cm (2") above the highest jet.
- When cleaning your bathtub, do not use abrasive substances that will damage the bathtubs' surface.
- A maximum water temperature of 104° F (40° C) is recommended. Bathing temperatures above 104° F (40° C) for prolonged periods can be injurious to health. Pregnant or possibly pregnant women should consult a physician before using a Whirlpool system.
- The Whirlpool system must be cleaned at least monthly.
- It is important to mix the essential oils with water before they are poured into the bathtub, as their improper use could cause skin irritations and damage to the surface of the bathtub. Please read the instructions carefully before use. Rinse the bath very well after each use. Essential oil is very abrasive and their utilisation is at risk of the user.

IMPORTANT INFORMATION TO SAFEGUARD

Note : Always keep your original bill of sale

Date of purchase: _____ Name of retailer: _____

Description of bathtub: _____

Serial number indicated on the Alcove Logo: _____

SITE PREPARATION

- The site should be cleared of debris and vacuumed. This will ensure that the bathtub is leveled properly and that no dirt can be sucked into the bathtub's systems.
- Check if the floor is leveled and solid. The level should be in a range that can be compensated for by the use of adjustment feet. An average sized bathtub can weigh as much as 450 kg (1000 lbs) when full, the floor must be able to support this weight.
- An opening of 15cm x 30cm (6" x 12") needs to be cut into the floor for the bathtub drain and overflow (see fig. 1). Make sure that there are no obstructions in this space.

Fig. 1

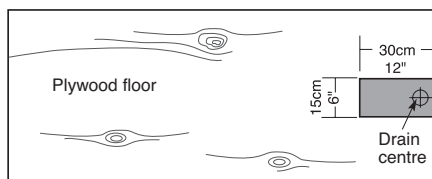

- The plumbing rough-in for both the drain and the supply lines should be completed by a competent and accredited plumber before the bathtub is moved into its final position.
- For bathtubs equipped with a Whirlpool, Balne-Air, Vibro-Air, Lighting system or inline water heater, all electrical connections should be completed by a competent and accredited electrician. Each system must be hooked-up to a dedicated 15 amp ground fault circuit interrupter (GFCI) breaker, or where allowed by law to a regular breaker with a ground fault circuit interrupter(GFCI) outlet.

PROTECTIVE FOAM PACKAGING

The adjustable legs on our bathtubs are now provided with foam packaging around each leg to ensure the quality of the products during transportation. **These foam protectors have to be removed before installation.**



With protective foam packaging



Without protective foam packaging

RECESSED INSTALLATION

When the plans call for installation of the bathtub in a recess (i.e. encased between 2 or 3 walls) we suggest that the following installation procedure be followed:

- **Step 1:** The bathtub overflow and drain should be installed by a competent certified plumber according to the overflow manufacturers instructions, and conforming to local building codes.
- **Step 2:** The bathtub must be positioned and leveled by placing the adjustment shims under each foot. Some bathtubs are equipped with adjustable metal feet and can be leveled by turning the feet until the desired height is achieved. Level the longer part of the bathtub first by placing a long level along the edge that is against the wall (see Fig. 2). Next, level the sides by placing shims under the front feet. Make sure that the slopes of the bathtub decks that have a tiling flange lean towards the inside of the bathtub. **After adjusting, make sure that the bathtub is perfectly level before continuing with installation.**

Fig. 2

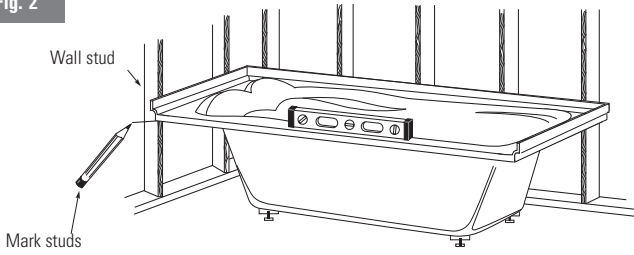

- **Step 3:** Using a pencil, mark the wall studs directly under the lip of the deck (see fig. 3). If you intend to set the bathtub in a mortar bed, the position of the feet should be marked too.

Fig. 3

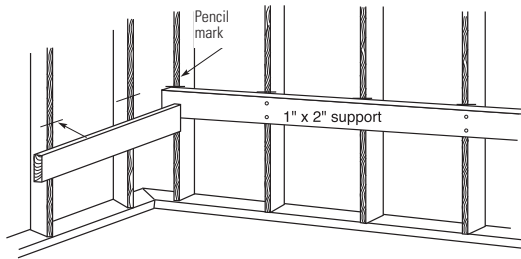

- **Step 4:** Remove the bathtub so that you have access to the walls.
- **Step 5:** Cut supports for the bathtub deck from 1" x 2" stock. The supports should be long enough to support the entire length of the bathtub. These supports are fastened to the wall studs with the top of the support at the level of the marks from step 2 (see fig. 4).
- **Step 6:** Silicone should now be applied under the legs to attach to the floor and reduce the risk of squeaks. (Indicated in step 2) (see Figure 4). Note: A bed of mortar strongly recommended to decrease the flexion of the bottom of the bath. **NOTICE: When using mortar to support a bathtub equipped with a Balne-Air or Vibro-Air systems, the mortar should be under the feet only.**

Fig. 4

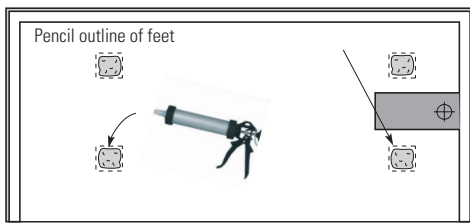

- **Step 7:** Apply a generous bead of construction adhesive along the top of the 1" X 2" support strips (see fig. 5). This will prevent the bathtub from shifting and also compensate for the unevenness of the fiberglass reinforcement under the deck..

Fig. 5

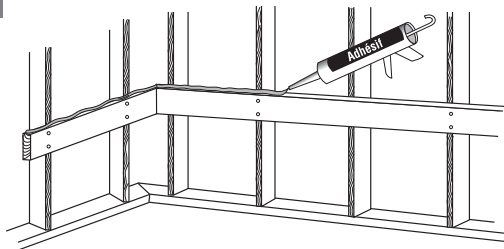

- **Step 8:** Set the bathtub into position. Check that the bottom of the deck comes into contact with the support strips. **If you opted to use a mortar bed,** check that the mortar has spread and that the feet are supported. Add more mortar if necessary. **If you did not use a mortar bed,** the shims should be replaced under the feet, and glued in place with construction adhesive. **Note: Do NOT fix feet to floor using nails or screws.**
- **Step 9:** If your bathtub is not equipped with an integral skirt the front wall should now be built. It is made from 2" x 3" s spaced 41cm (16") on center (see fig. 6). **Remember to leave enough space between the top of the wall and the bottom of the bathtub deck to allow for installation of the plywood and the ceramic tile or other covering material.**
- **Step 10:** When installation is complete (including plumbing installation), seal the bathtub onto the podium using silicone.

Fig. 6

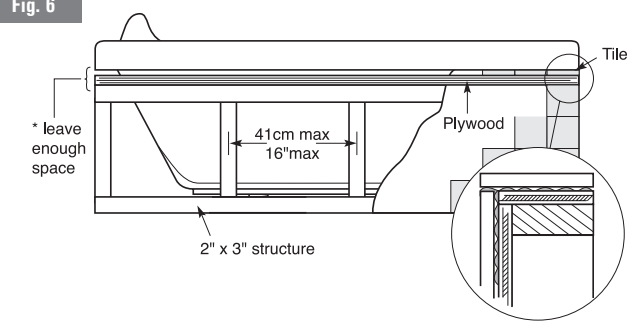

PODIUM INSTALLATION

When the plans call for podium installation we recommend the following installation procedure:

NOTICE: The bathtub must be supported by its feet only. The feet must be in contact with the floor at all times. The rim should only touch the podium and should not be supported.

- **Step 1:** Calculate the height of your podium structure. Remember that the finish material must fit between the lip of the bathtub and the podium structure, so its thickness must be subtracted from the total height when building your structure (see fig. 7)

Fig. 7

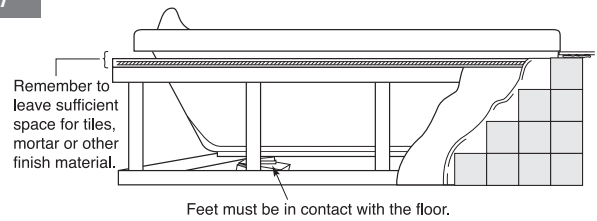

- **Step 2:** Frame the podium using 2" x 3" s spaced no more than 41cm (16") on center. Remember to provide adequate support under the rim of the tub and ensure that the framework is level. This framing must conform to your local building codes (see fig. 8).

Fig. 8

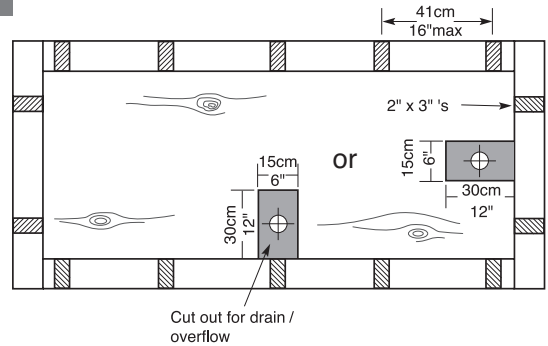

- **Step 3:** Cut out an opening 15cm x 30cm (6" x 12") in the floor to accommodate the bathtub drain and overflow piping.
- **Step 4:** Sheath the top of the podium using 5/8" thick exterior grade plywood. The plywood should be attached to the framework using screws.
- **Step 5:** Lift the bathtub onto the podium and align it in the desired position. The outline can now be traced using a level and pencil as shown in fig. 9.

Fig. 9

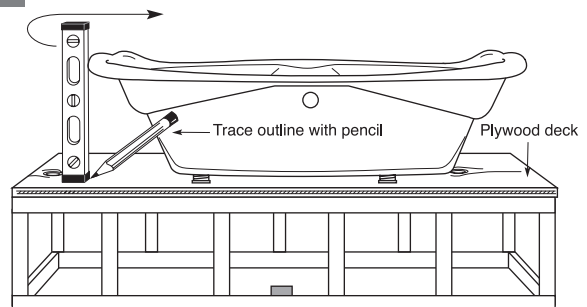

TRACING THE OUTLINE OF THE BATH

- **Step 6:** Remove the bathtub from the podium, and sketch a cut line 2.5cm (1") inside the outline of the bathtub (see fig. 10). You can use a 1" scrap of wood to simplify this procedure.

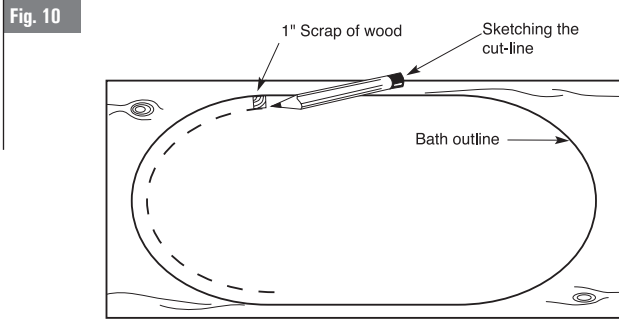

- **Step 7:** Drill a pilot hole on the cut line. Cut out the waste following the cut line using a jigsaw (see fig. 11).

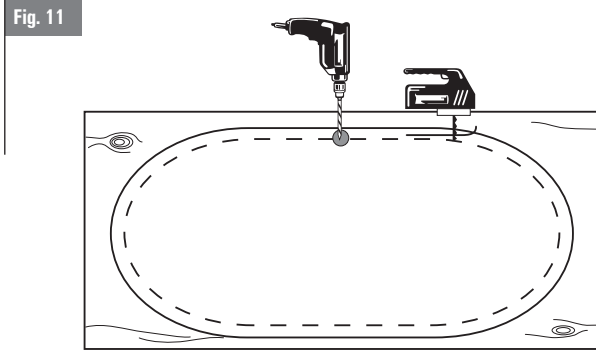

- **Step 8:** The bathtub overflow and drain should now be installed by a competent certified plumber according to the overflow manufacturers instructions, and conforming to local building codes.
- **Step 9:** Clear away and vacuum any remaining debris from inside the podium
- **Step 10:** Lift the bathtub and set it into the podium. Make sure that it fits properly and that there is sufficient space for the bathtub overflow plumbing. Make any necessary modifications before proceeding with the next step. If you plan to use a mortar bed mark the position of the bathtub's feet on the floor and remove the bathtub from the podium.
- **Step 11:** Mortar bed (strongly recommended). Freshly mixed mortar should now be placed on the floor where the bathtub's feet will land (marked out in step 10) (see fig. 12). **NOTICE: When using mortar to support a bathtub equipped with a Balne-Air or Vibro-Air systems, the mortar should be under the feet only. Under no circumstances should the mortar come into contact with the piping and fittings underneath the bathtub.**

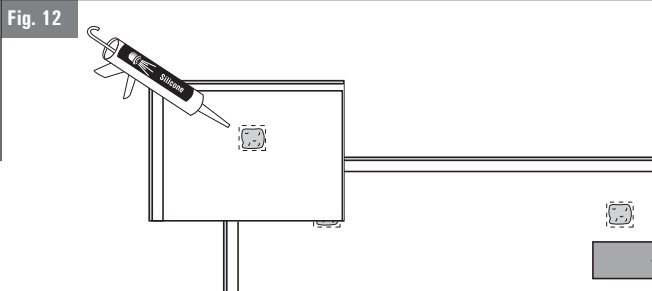

- **Step 12:** (Mortar option only) Lift the bathtub and set it into the podium. Level the bathtub lengthwise first, then across its width. Check, underneath the bathtub, that the mortar has spread and that there is adequate mortar for support under the feet. Add some if necessary.
- **Step 13:** (Non-mortar option only) Level the bathtub lengthwise first, then across its width by adding adjustment shims under the feet. Glue the shims to the feet and the floor using construction adhesive. **NOTE: Do NOT use nails or screws to affix the feet to the floor.**

UNDERMOUNT BATHTUB INSTALLATION

- **Step 1:** Build a podium strong enough to support the weight of the material chosen to be put on top of it. Make sure the bathtub does not support the podium deck; there has to be a gap of about 1/16" between the bottom of the podium deck and the top of the bathtub deck.
- **Step 2:** Install the bathtub based on the instructions given in this guide.

- **Step 3:** Install the podium deck based on the instructions supplied by the manufacturer and apply a bead of silicone between the podium deck and the bathtub deck. Immediately remove any excess sealant with a clean cloth. The deck of the bathtub is designed with a slight slope, to ensure that water flows down to the inside of the bathtub. As a result, the size of the gap will vary according to how much of the bathtub deck you want to be covered by the podium deck.

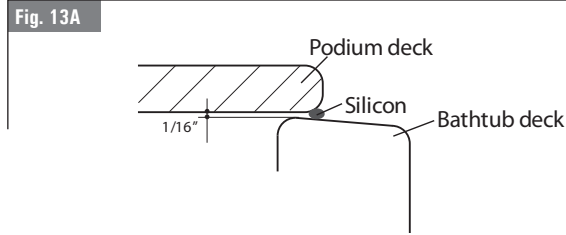

Example A: The podium deck is close to the outside edge. The gap between the podium deck and the bathtub deck is narrow; install the podium deck over the bathtub and apply a small bead of silicone caulk. (Figure 13A)

Example B: The podium deck is completely covering the bathtub deck. Install the po-

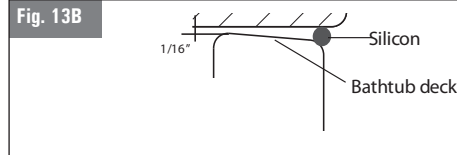

diom deck over the bathtub. In this case the gap is larger and will require a larger silicone bead, but it will not be visible since it will be entirely covered by the podium deck. (Figure 13B)

INSTALLATION OF BATHTUBS WITH CONTOUR SKIRT

For a bathtub with a contour skirt, we suggest that you follow the instructions below.

It is recommended that the installation be done by two people.

The bathtub has been leveled in factory. If an adjustment is necessary, you can use the adjustable feet by loosening the locknut on each foot, but they must be relocked in position before the final installation.

- **Step 1:** Temporarily position the entire bathtub in the desired location. If the drain is not preinstalled, mark its location on the floor so that you can reposition the bathtub correctly in the following steps (Figure 14A). Using a washable marker, draw two lines from the edge of

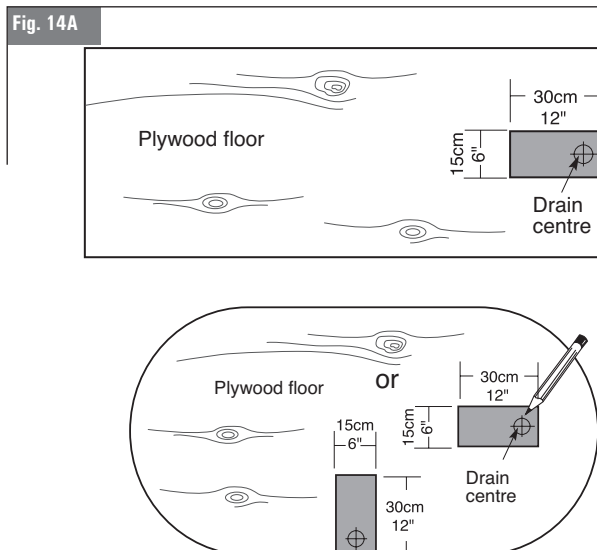

the bathtub to the skirt (Figure 14B) to establish a reference point for Step 7.

Fig. 14B

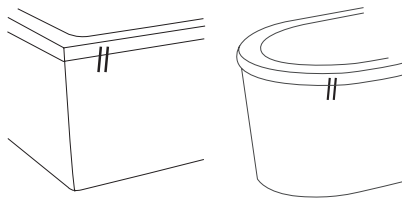

- An opening of 15cm x 30cm (6" x 12") needs to be cut into the floor for the bathtub drain and overflow (see fig. 14A). Make sure that there are no obstructions in this space.
- **Step 2:** Remove only the bathtub, being careful to not move the skirt. Next, draw the interior outline of the skirt on the floor with a lead pencil to designate skirt location. (Figure 15)

Fig. 15

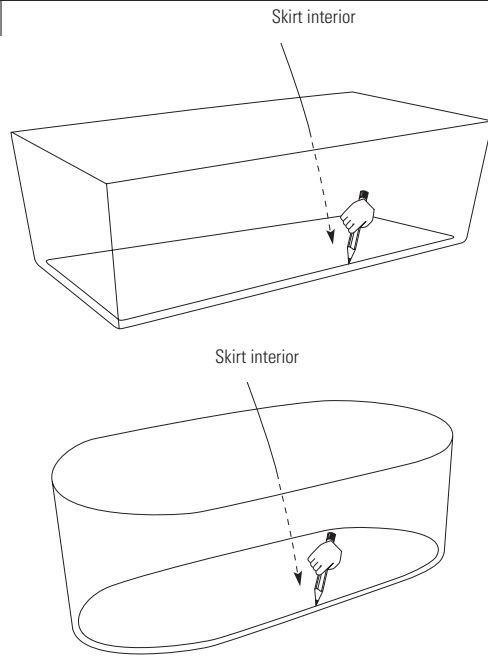

- **Step 3:** Remove the skirt and reposition only the bathtub according to the previously drawn lines.
- **Step 4:** Trace outline of the feet.
- **Step 5:** Remove the bathtub again.
- **Step 6:** Apply a thin line of silicone under the skirt and put it into place.
- **Step 7:** Position the bathtub, being careful to fully integrate the bathtub feet into the skirt inside the bathtub edge. Make sure that the two reference lines drawn in Figure 15B are well aligned.
- **Step 8:** Leave the bathtub in this position for at least 24 hours.

Fig. 16

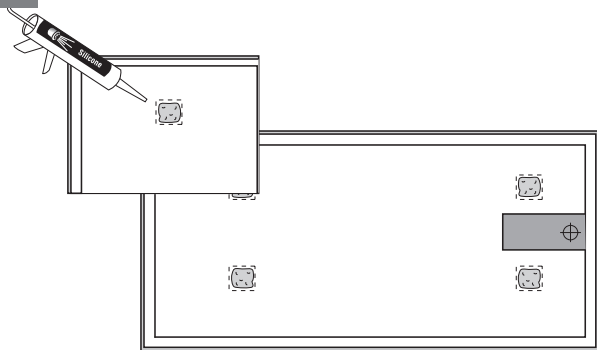

Notes: A) For bathtubs with a contour skirt, the wooden blocks are factory installed and adjusted. Accordingly, affix to the floor in the desired location, checking the drain position, and then proceed with Step 6.

B) We recommend the two following methods for future service access:

- 1) Cut an access panel in the floor under the bathtub if circumstances allow.
- 2) Remove the bathtub from the skirt if required for maintenance.

C) The structure of this style of bathtub is not designed to sit on the edge, the acrylic skirt and the tub itself may crack.

D) A tape with foam can be installed between the skirt and the tub to avoid squeaking noise.

FAUCET INSTALLATION

- **Step 1:** (Bathtub mounted faucets) Faucets can be mounted either onto the podium, or they can be attached directly to the bathtub. When attachment to the bathtub is called for, great care must be taken when drilling through the acrylic.
 - Align the faucet knob handles and ensure they are leveled before drilling the holes.
 - Always use a sharp hole-saw with a pilot bit that extends at least 1/4" below it.
 - The hole saw must always be larger than the fitting, forcing an object through a hole that is too small will damage the acrylic.
 - Drill slowly and steadily letting the tool do the work. This will help to reduce heat build-up and binding at the acrylic surface.
 - When installing the fixtures never over-tighten them as this can cause damage to the acrylic surface.
- **Step 2:** Now that the plumbing installation is complete, your new bathtub needs to be leak tested. We recommend a 20 minute soak test, the bathtub should be filled above the level of the overflow and left to stand for 20 minutes. If no leaking is detected at the bathtub or the plumbing hook-ups during or after 20 minutes you may continue with the installation.

FREESTANDING BATHTUBS WITH NON-REMOVABLE SKIRT

1. Clear and clean the space around where the bathtub will be positioned so as to avoid damage to the bathtub during installation.
2. Check the level and the strength of the floor where the bathtub will be positioned. The floor must be sufficiently level so as to achieve a horizontal level by means of adjusting shims. A bathtub filled halfway with water can weigh up to 454 kg (1000 lb) and the floor must be strong enough to support this weight.
3. The basic installation of plumbing (pipes and drain/water supply) must be performed by a qualified plumber prior to installation of the bathtub.
4. **If the valves require installation on the outer edge of the bathtub, proceed with the installation between steps 12 and 13 of this guide (bathtub faucet installation).**
5. Temporarily set the bathtub in its intended location, ensuring that the drain hole is aligned to the floor drain and then draw the contour of the bathtub on the ground. If the floor drain is not installed yet, trace its location through the hole of the bathtub, then move the bathtub to a safe place, so as to install floor drain according to guidelines. Re-position the bathtub and ensure that the trace lines are followed.
6. Check the level and adjust if necessary by screwing or unscrewing the legs beneath the bathtub (maximum adjustment of 1" (25 mm) and ensuring that the bathtub is always resting on all four legs while minimizing the space between the skirt and the floor (the skirt can rest on the floor but shall in no way support the weight of the bathtub).
7. Lock the bathtub legs into position by tightening the adjoining nut once an accurate acceptable level is confirmed.
8. Lay the bathtub on its side having previously laid cardboard packaging on the ground to protect the surface of the bathtub. Be sure to use a piece of cardboard without staples to avoid damaging the surface the bathtub.
9. Temporarily install the drain assembly of the bathtub by referring to the drain installation guide and starting with setting of the overflow valve.
10. Place the bathtub back into position on the previously traced outline while ensuring that the drain end fits into the floor drain and it is held in place for the next step.
11. Unscrew the rings of the overflow valve and then lift bathtub and lay it on its side making sure not to move the drain, specifically the floor drain.
12. Tighten the seal ring of the floor drain to the end of the drain.
13. Apply a bead of silicone to the entire circumference of the skirt and the bathtub legs. We also recommend applying a circle of silicone to seal the drain and overflow

14. Place four (4) pieces of wood ¾" thick inside the footprint on which to temporarily rest the bathtub.
15. Raise the bathtub and then put it back down again, ensuring alignment over the vertical drain, without moving the drain and making sure the bathtub rests on the wooden blocks.
16. Remove the wooden blocks one by one to correctly place the bathtub in its resting place aligned to the drain.
17. Screw the rings of the overflow and drain by tightening properly.
18. If necessary, add silicone to the location of the pieces of wood, clean surplus and erase the trace marks on the ground.
19. Let stand at least 24 hours before use.

INSTALLATION OF FAUCET COMPONENTS ON THE BATHTUB

1. Before drilling into the bathtub, verify that the valve body is not too large to move between the bathtub and the skirt. Validate that the body will not touch and rest against the inside of the skirt.
2. Check to ensure there is no impeding of the overflow valve after installation.
3. Validate the level of the bell traps on the bathtub drain flow slope.
4. Mark the location of the bell traps on the bathtub.
5. Drill with a sharp bit at least 3/8" (10mm) depth and a diameter slightly greater than the valve body.
6. Drill slowly so as not to melt the acrylic.
7. Install valves following the installation guide.
8. Do not over tighten the taps on the bathtub in order to avoid damaging the acrylic.
9. Connect flexible hoses to the water supply with sufficient slack. Ensure that they do not end up pinched beneath the skirt or legs of the bathtub.
10. Perform a water test before the final stages of installation of the bathtub.

FINISHING WALLS, DECKS AND PODIUM

Now that you have installed and tested your bathtub and its systems, the following pointers will help you achieve a professional looking and watertight finish:

- Fig. 17A and 17B show how the finishing materials should be installed relative to the tiling flange.
- The tiling flange does not replace caulking. Always caulk your bathtub using good quality, bathroom grade (mildew resistant) silicone caulk.

Fig. 17A

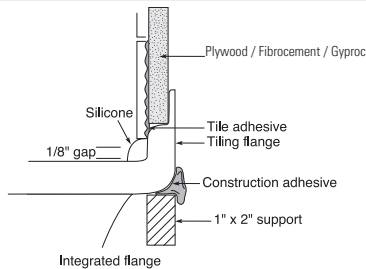
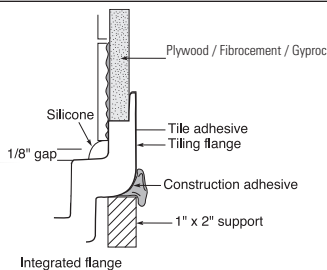

Fig. 17B



- Fig. 18 shows how the finishing materials should be installed relative to the bathtub lip on a podium or deck installation.
- All 90° angles including those between the walls, the podium and the deck should be sealed with silicone caulk (see fig. 19).

Fig. 18

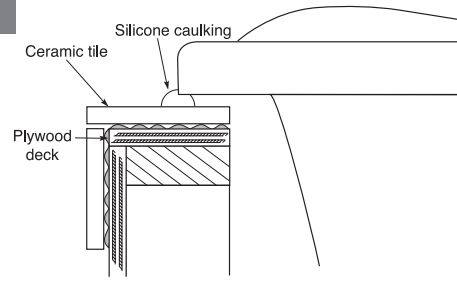
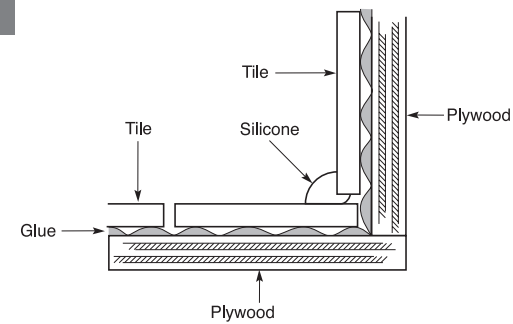

Fig. 19



SYSTEM HOOK-UP (electrical installation)

All electrical connections should be done by a competent licensed electrician and in accordance with the local building codes in your area. An access panel is mandatory. Most building codes require that there is an access panel of at least 30 cm x 50 cm (12" x 22") in order to service the plumbing, motor, control unit and keypad. In case of a breakdown, the access panel must allow the technician to access the defective components. Alcove shall not be liable for any additional costs caused by the absence of an access panel.

All components exceeding 6 AMP (pump, blower, water-heater) must be connected to an independent 15 AMP ground fault circuit interrupter (GFCI) breaker. Where allowed by law, they can be hooked up to GFCI outlets connected to a regular breaker.

The bathtub systems and controls are designed to operate on 110/120 Volt AC 60 Hz (North America).

- **Step 1:** Turn off the power to the bathtub circuit at the electrical panel.
- **Step 2:** Hook up the wiring from the control module and/or pump and/or inline heater and/or light to the circuit panel using the appropriate cable gauge. If the distance from the electrical panel to the bathtub is further than 30 m (100 ft), refer to your local building code to make sure that a sufficient gauge cable is used.
- **Step 3:** Electronic touch pad or switch: The hole for the electronic touch pad or switch is drilled at the factory. The pad or switch has a self-sealing gasket that will hold it in place. Depending on your model, it will plug directly into the motor or control module. (See the figure that represents your configuration)
- **Step 4:** Now that the electrical installation is complete, the power can be turned on at the electrical panel. The bathtub should be filled above the level of the jets, and the systems should be tested.

Fig. 20 Whirlpool

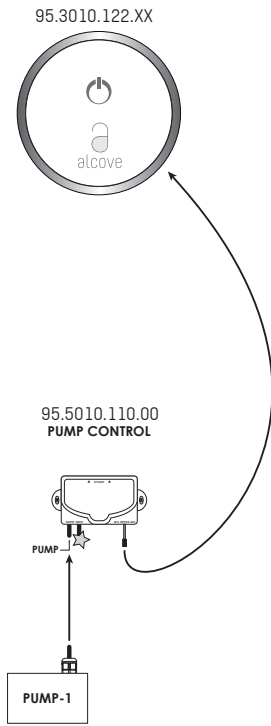
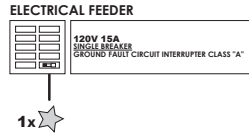

Fig. 21 Chromotherapy light

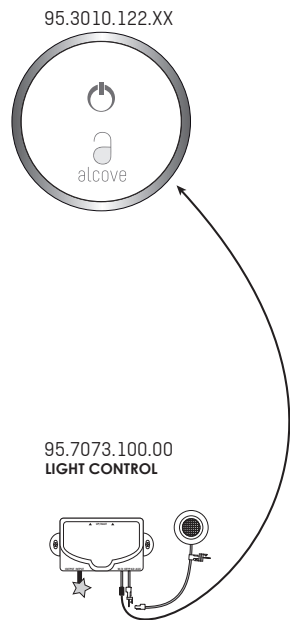
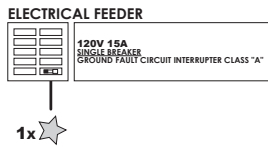

Fig. 22 Whirlpool and Chromotherapy light

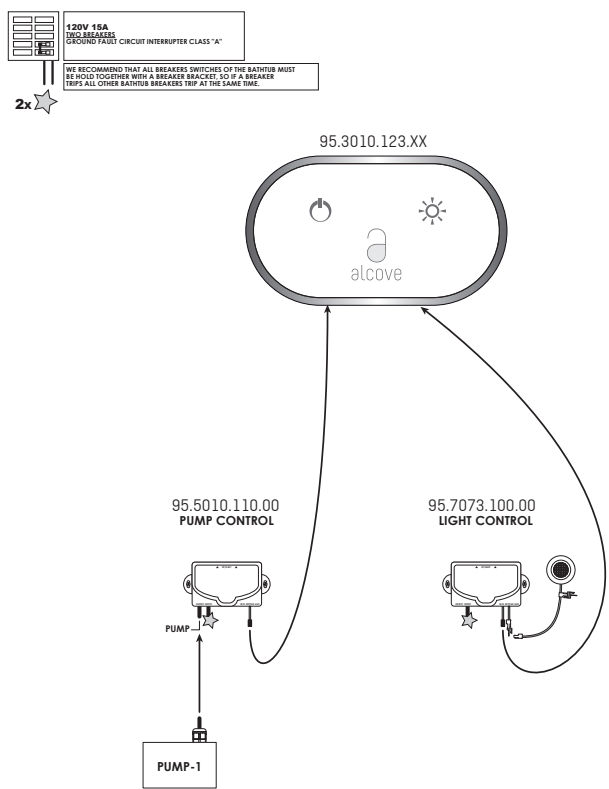

Fig. 23 Balne-Air or Vibro-Air

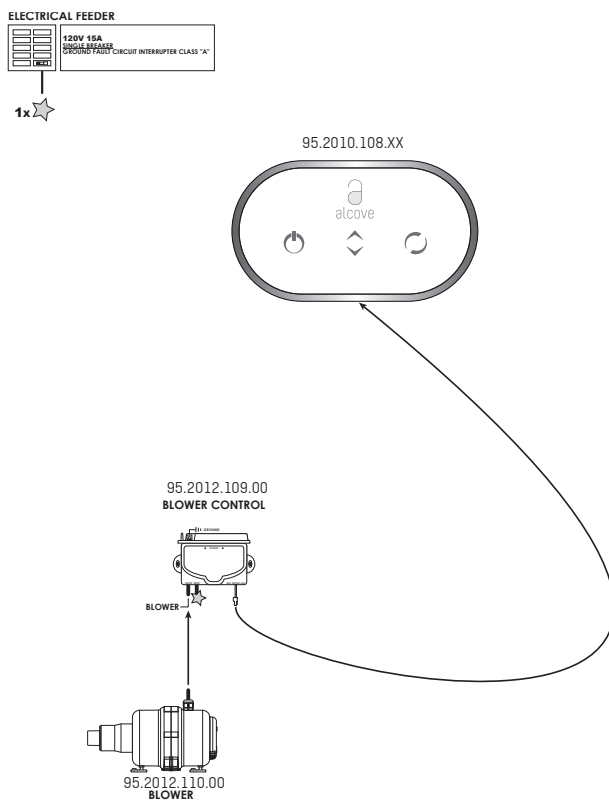

Fig. 24 Balne-Air or Vibro-Air and Chromotherapy light

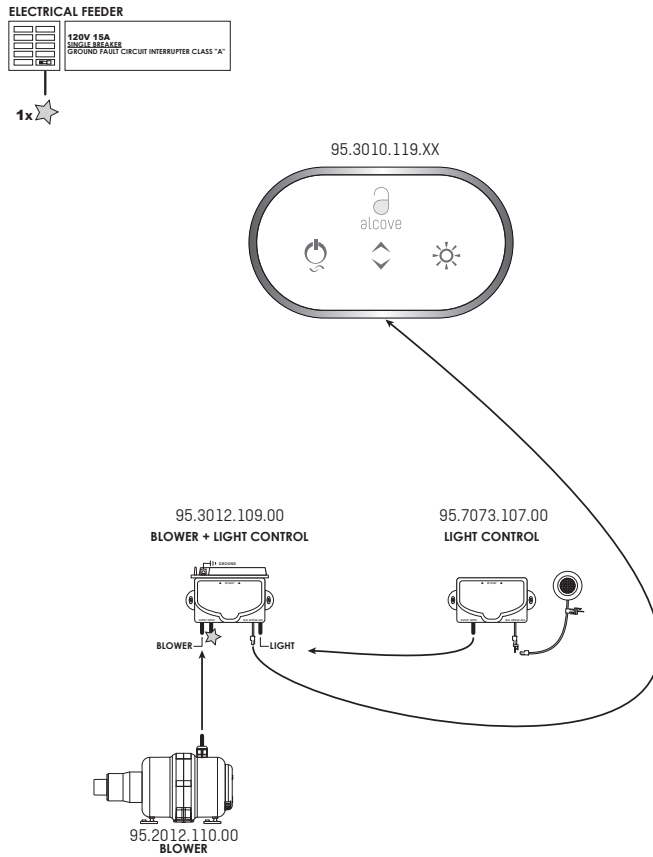

Fig. 25 Combined Whirlpool and Balne-Air or Vibro-Air

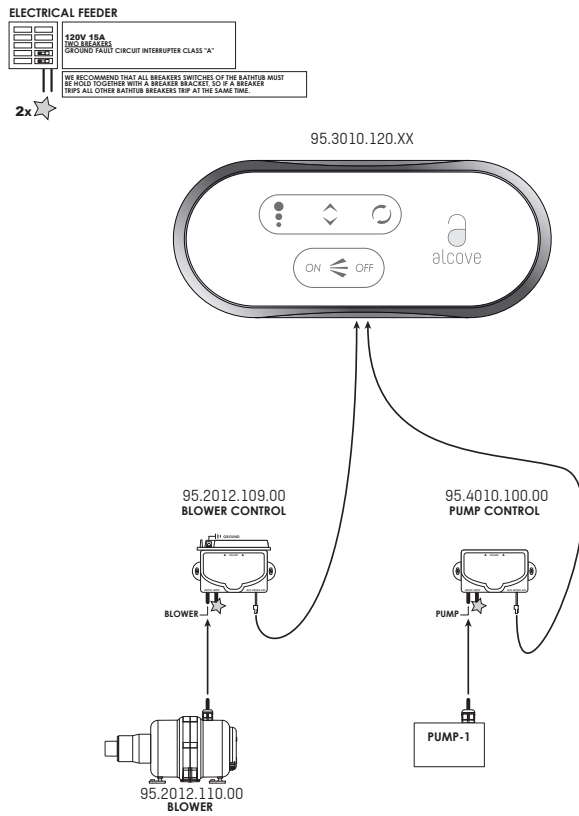

Fig. 26 Combined Whirlpool and Balne-Air or Vibro-Air and Chromotherapy Light

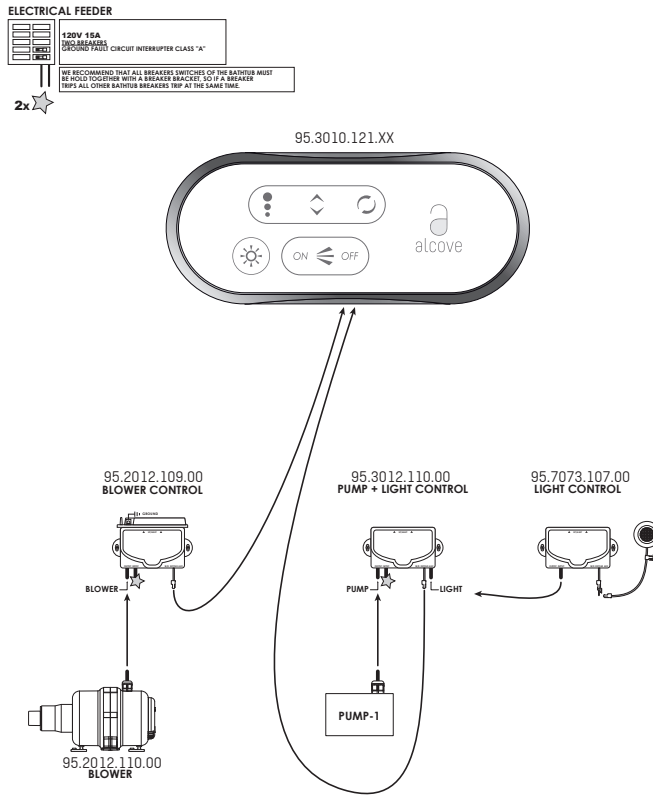
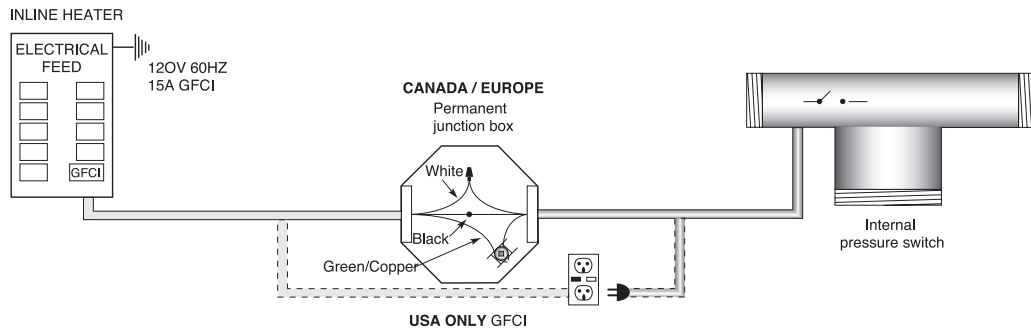

Fig. 27 Inline heater



Operating instruction

WHIRLPOOL



BUTTON	PRESS	FUNCTIONS
1	1 st	The pump starts
	2 nd	The pump stops

Automatic shutdown after 20 minutes.

CHROMOTHERAPY LIGHTS



BUTTON	PRESS	FUNCTIONS
1	1 st	Light starts in white
	2 nd	Slow rainbow mode
	3 rd	Stop on shown color
	4 th	Aqua
	5 th	Blue
	6 th	Magenta
	7 th	Red
	8 th	Orange
	9 th	Yellow
	10 th	Green
	11 th or hold 1 sec.	Off

Automatic shutdown after 20 minutes .

WHIRLPOOL AND CHROMOTHERAPY LIGHTS



BUTTON	PRESS	FUNCTIONS
1	1 st	The pump starts
	2 nd	The pump stops
2	1 st	Light starts in white
	2 nd	Slow rainbow mode
	3 rd	Stop on shown color
	4 th	Aqua
	5 th	Blue
	6 th	Magenta
	7 th	Red
	8 th	Orange
	9 th	Yellow
	10 th	Green
	11 th or hold 1 sec.	Off

Automatic shutdown after 20 minutes.

BALNE-AIR OR VIBRO-AIR SYSTEMS



BUTTON	PRESS	FUNCTIONS
1	1 st	The blower starts
	2 nd	The blower stops
2	1 st	Press and hold to increase the blower speed. Release pressure at the desired speed.
	2 nd	Press and hold to decrease the blower speed. Release pressure at the desired speed.
3	1 st	Starts the wave cycle- Speed will vary gradually from maximum to minimum.
	2 nd	Blower returns to startup speed.

Automatic shutdown after 20 minutes.
An automatic drying cycle will start 20 minutes after the blower is turned off.

BALNE-AIR OR VIBRO-AIR SYSTEMS AND CHROMOTHERAPY LIGHTS



BUTTON	PRESS	FUNCTIONS
1	1 st	The blower starts
	2 nd	Starts the wave cycle -S speed will vary gradually from maximum to minimum.
2	1 st	Press and hold to increase the blower speed. Release pressure at the desired speed.
	2 nd	Press and hold to decrease the blower speed. Release pressure of the desired speed.
3	1 st	Light starts in white
	2 nd	Slow rainbow mode
	3 rd	Stop on shown color
	4 th	Aqua
	5 th	Blue
	6 th	Magenta
	7 th	Red
	8 th	Orange
	9 th	Yellow
	10 th	Green
	11 th or hold 1 sec.	Off

Automatic shutdown after 20 minutes.
An automatic drying cycle will start 20 minutes after the blower is turned off.

COMBINED WHIRLPOOL/BALNE-AIR SYSTEMS OR WHIRLPOOL/VIBRO-AIR SYSTEMS



BUTTON	PRESS	FUNCTIONS
1	1 st	The blower starts
	2 nd	The blower stops
2	1 st	Press and hold to increase the blower speed. Release pressure at the desired speed.
	2 nd	Press and hold to decrease the blower speed. Release pressure of the desired speed.
3	1 st	Starts the wave cycle- Speed will vary gradually from maximum to minimum.
4	2 nd	Blower returns to startup speed.
5	1 st	The pump starts
6	2 nd	The pump stops

Automatic shutdown after 20 minutes.
An automatic drying cycle will start 20 minutes after the blower is turned off.

COMBINED WHIRLPOOL/BALNE-AIR SYSTEMS OR WHIRLPOOL/VIBRO-AIR SYSTEMS AND CHROMOTHERAPY LIGHTS



BUTTON	PRESS	FUNCTIONS
1	1 st	The blower starts
	2 nd	The blower stops
2	1 st	Press and hold to increase the blower speed. Release pressure at the desired speed.
	2 nd	Press and hold to decrease the blower speed. Release pressure of the desired speed.
3	1 st	Starts the wave cycle- Speed will vary gradually from maximum to minimum.
	2 nd	Blower returns to startup speed.
4	1 st	Light starts in white
	2 nd	Slow rainbow mode
	3 rd	Stop on shown color
	4 th	Aqua
	5 th	Blue
	6 th	Magenta
	7 th	Red
	8 th	Orange
	9 th	Yellow
	10 th	Green
	11 th or hold 1 sec.	Off
5	1 st	The pump starts
6	2 nd	The pump stops

Automatic shutdown after 20 minutes.
An automatic drying cycle will start 20 minutes after the blower is turned off.

WHIRLPOOL: ADJUSTABLE JETS

Alcove whirlpool jets have two adjustable features, direction and flow. Direction is adjusted by simply moving the nozzle to point in the desired direction. Flow is adjusted by rotating the nozzle (see fig. 28).

Turning the nozzle clockwise reduces flow and turning it counter-clockwise increases it.

WHIRLPOOL: AIR INDUCTION

Alcove's whirlpool system increases the massaging effect by drawing air into the jets (VENTURI EFFECT). The air controls are directly installed on the whirlpool system piping.

BACKJETS: DIVERTER VALVE (option)

Some Alcove bathtubs that have backjets option are equipped with an optional diverter valve. This valve (see fig. 29) redirects flow from the main jets to the back-jets allowing you to balance the massage to the point where you enjoy it the most.

Fig. 28

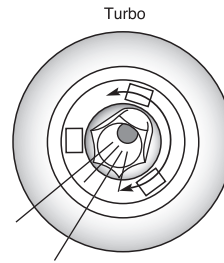
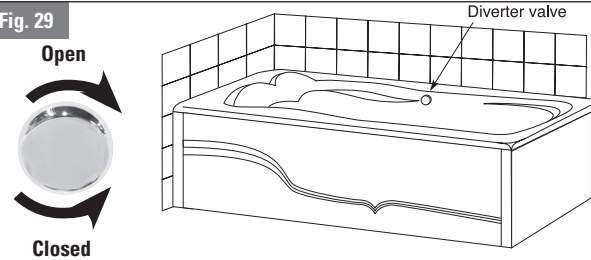

Fig. 29



Troubleshooting

PROBLEM	SOLUTION
Water remains around the bathtub rim or drain.	Check that the installation is level and that the bathtub is sitting firmly on its feet. (Drain slope is built into the bathtub.) Shim with adjustment wedges if necessary.
Bathtub or shower bottom moves during use.	The bathtub is not sitting firmly on its feet. Shim with adjustment wedges or use the alternate mortar bed installation technique.
Bathtub moves relative to the walls during use.	The bathtub is not firmly supported under the rim. Check that 1"X2" supports contact the underside of the rim. Modify if necessary.
Protective plastic film will not come off.	Use isopropyl alcohol.
Electronic control fails to operate.	<ul style="list-style-type: none"> • Check the electrical power supply. Reset circuit or replace fuse if necessary. • Check Ground Fault Circuit Interrupter (GFCI). Reset if tripped. • If the system has been in operation for a long time it is possible that the thermal protection switch has shut off the motor. Turn off the system and wait 30 minutes for it to cool, then try again. • Check the connections between the electronic control pad and the control module or pump.
Motor will not stop/ only some functions on the electronic control pad are working.	<ul style="list-style-type: none"> • Shut off power to the bathtub at the breaker. Make certain that no water has infiltrated the control pad. Try drying the pad with a hair dryer. • Check for excessive humidity under your bathtub and around the control pad and control module. Allow it to dry out and provide for adequate ventilation if necessary.
Excessive noise from blower or pump.	<ul style="list-style-type: none"> • Most of the noise from your Whirlpool, Balne-Air or Vibro-Air system actually comes from the movement of the water. • Check that the blower is firmly secured. • Check that the pump is firmly in contact with the floor. Use adjustment shims and construction adhesive to secure if necessary. • Make certain that there are no obstructions close to the intake of the blower, and that it has an adequate supply of fresh air. • The bathtub can be insulated using bats of fiberglass around the tub. Make certain that you leave a 2 sq feet space around the pump or blower.
Blower runs but no air comes out through the jets.	Check that the main air hose from the blower to the manifold is properly connected. Reconnect and tighten clamps if necessary.
Air outlets in jet heads are blocked.	<ul style="list-style-type: none"> • If the air outlets of a jet head are obstructed with soap or other residues, fill the tub with water and brush them gently with a toothbrush. Turn the system ON then OFF several times. • Remove caps (Balne-Air & Vibro-Air) and ball bearing and clean with cotton swabs. Use a rubber head hammer for reinstallation. • If the problem persists tap the jet heads with a spoon while the blower is running (Balne-Air system only).
The air heater seems not to be functioning. Note: The air heater is not designed to heat your bathwater, only to heat the incoming air to body temperature.	<ul style="list-style-type: none"> • To verify operation of the air heater, fill the bathtub to working level. Turn on the blower and let it run for approximately 5 minutes. Carefully feel the flexible connection hose where it connects to the blower. The hose should feel warm to the touch. If not, contact your local distributor. • If your bathtub is installed against exterior walls, make certain that they are properly insulated to minimize heat loss. The air entering the blower should be at least 20°C. • Check that the blower is not drawing cold air from the basement or the space between the floors via the hole for the drain plumbing. Block the hole using either foam or fiberglass insulation. • People with sensitive skin might experience a "cold air effect" caused by the sensation of the air bubbles running along the wet skin and giving the bather a shivering sensation. Simply move the body slightly away from the closest jet.
the incoming air to body temperature. The air coming from the jets seem cold Temperature difference	<ul style="list-style-type: none"> • There will be a temperature difference between the air coming from the jets and the water temperature. The air temperature will be a little over the room temperature (22 to 25 degrees Celsius – 71 to 77 degrees Fahrenheit), depending on the number of jets in the bathtub. The water on the other hand, will be warmer (about 34 to 40 degrees Celsius – 93 to 104 degrees Fahrenheit). • The air is not cold: it is just not as warm as the bathtub water. If weren't for the heating element that's in the blower, the temperature difference would be a lot greater.

Maintenance

ROUTINE CLEANING

To protect the acrylic finish from Alcove, it must be cleaned with a mild dish soap such as Dawn or Sunlight or a specifically designed acrylic detergent. NEVER USE ABRASIVE POWDER (VIM, AJAX, COMET, etc.), PETROLEUM DISTILLATE OR OTHER STRONG SOLVENTS TO CLEAN THE BATH.

BALNE-AIR AND VIBRO-AIR SYSTEMS

If your Alcove bathtub is fitted with either a Balne-Air or Vibro-Air therapeutic system most of the routine maintenance is eliminated by the fact that the electronic control module has a built-in automatic drying cycle. This cycle, that initiates 20 minutes after the blower has stopped, removes all remaining stagnant water from the air jets, return valves and piping thus keeping them dry.

If you did not use your system while taking a bath, we recommend to press the on/off button to activate the purge.

WHIRLPOOL MAINTENANCE

Alcove recommends that the following cleaning procedure be undertaken at least once per month.

1. Fill the bathtub with hot water 2 inches above the level of the jets.
2. Add 2-Cups of vinegar or 1/4 cup of liquid dishwasher soap.
3. Run the whirlpool for approximately 5 minutes.
4. Let the bathtub soak for a 1/2 hour.
5. Run the whirlpool for another 5 minutes.
6. Drain the bathtub.
7. Rinse with cold water.

Acrylic repairs

STAIN

If you have a particularly resistant stain, you can use isopropyl alcohol to try and remove it (isopropyl alcohol is toxic, so always follow the safety instructions that come with it and wear rubber gloves).

MINOR SCRATCH REPAIR

Small superficial scratches can usually be removed by using an automotive polishing compound such as NuFinish or Meguiar's mirror glaze.

MAJOR DAMAGE REPAIR

Major damage, including chips and cracks in your bathtub, can often be repaired by a qualified technician. Your Alcove dealer can put you in contact with such a qualified professional.

Warranty

WARRANTY

Each Alcove product has been subjected to rigorous quality controls and we guarantee that it conforms to the highest quality standards. In order to ensure a trouble-free installation, we strongly recommend that you read the installation manual and our warranty terms joined with the product carefully before beginning any work. Our warranty covers parts and labor for repairs only and does not cover additional costs related to defective product replacement.

BATHTUBS

ACRYLIC SHELL: Alcove guarantees that acrylic units are free of any defects in materials and workmanship under normal use and service for a period of twenty (20) years starting from the initial date of purchase by the owner/user, contractor, or builder from an authorized dealer.

WISTERIA ACRYLIC SHELL: Alcove guarantees that acrylic units are free of any defects in materials and workmanship under normal use and service for a period of four (4) years starting from the initial date of purchase by the owner/user, contractor, or builder from an authorized dealer.

SYSTEMS: Limited 5-year warranty (parts) against manufacturing defects; jets, pipes, fittings, electronic control pads, pumps, inline heaters, blowers, black box, remote controls, wiring, etc. and leaks related to manufacturing defects. Limited 5-year warranty against manufacturing defects related to colored jet trims inside the bathtub.

OPTIONS

GENERAL: Chromotherapy, neck pillows, handles and other options. Limited 5-year warranty against manufacturing defects for all parts.

DRAIN: Limited lifetime warranty for Chrome finish.

WISTERIA DRAIN: Limited 4-year warranty on finish (parts). Limited 4-year warranty on finish (parts).

PARTS: Limited 1-year warranty against manufacturing defects.

IMPORTANT !

- When a showroom product is sold, the warranty period begins on the date of purchase from Alcove by the retailer.
- For commercial use, all products have a 1-year warranty against manufacturing defects.
- The Alcove warranty is solely for the personal household use of the original owner/user and starts on the date of purchase from Alcove by the retailer. The warranty will take effect when the original owner/user presents the original bill of sale. The warranty is not transferable to subsequent owners. All products replaced or repaired by a qualified and certified technician during the warranty period will still be covered for the remainder of the original warranty.
- This warranty shall not apply in the case of non-compliant or incorrect operating procedures, breakage or damage caused by normal wear and tear, fault, negligence, abuse, misuse, misapplication, improper maintenance, alteration or modification of the product, as well as chemical or natural corrosion, fire, flood, or any other fortuitous event. This warranty shall not apply to stains or malfunctions caused by natural disaster, ferrous water, hard water, or salty water.
- Like any product of lasting quality, Alcove products and accessories require a certain amount of upkeep to preserve their finish. Clean your new Alcove product with a mild soap, rinse thoroughly with warm water, and dry with a clean, soft cloth. Never use cleaning products containing abrasive agents, ammonia, bleach, acid, wax, alcohol, or solvents. Failure to comply with these maintenance instructions may invalidate the Alcove warranty.
- No return on products sold in liquidation.
- No warranty on products sold in liquidation.
- No return on products sold with a system or option.
- All systems and options automatically come in the same colour as the bathtub unless otherwise specified on the purchase order.
- No return on products sold more than 3 months ago.