



PRICE GUIDE

EFFECTIVE MARCH 21, 2024
CONTINENTAL USA

- Bath Walls
- Shower Pans
- Kitchen Sinks
- Bathtubs
- Vanity Tops and Bowls
- Utilities

You can place your order by email or fax.
Please mention the item number exactly as it appears in this catalog.

Customer Service

Speak with Swan Customer Service at:

(800) 325-7008 or email us at **help@swanstone.com**.

Purchase Orders

Purchase Orders can be faxed to **(800) 342-7926**
or emailed to **swanezpo@swanstone.com**.

Visit our website!

You'll find more information on our colors, technical information, data sheets,
specifications and more at **Swanstone.com**

Is the product you want not included in this catalog?

We accept Special Order requests. Special Order products are available
and we can color match almost any color on request. Contact Swan
Customer Service for more information.

TABLE OF CONTENTS

Purchase Order Acceptance Policy	2
Product Index	3-6
BATH SOLUTIONS	
Swanstone	
Bath Wall Kits, Panels and Wainscoting	8-15
Bath Accessories	16-19
Shower Pans	20-21
Accessible Shower Pans and Accessories	22
Vanity Tops and Accessories	23-25
Vanity Bowls and Accessories	26-27
Veritek®	
Bath Wall Kits	28-30
Bathtub	30
Shower Pans	31-32
Accessible Shower Pans and Accessories	33-34
Accessible Bath Accessories	35
Veritek® Pro	
Tub Showers	36-38
Showers	39
Shower Pans	39
Bathtubs	40
KITCHEN AND UTILITY SOLUTIONS	
Granite Kitchen Sinks	45-46
Swanstone Kitchen Sinks	47-49
Laundry Tubs	50
Utility Sinks	51
Mop Service Sinks	52
Accessories	53
REFERENCE	
Care and Cleaning Guide	55
Color Availability	56-57
Specifications and Technical Data Sheets	58-60
Warranty	61



PURCHASE ORDER

ACCEPTANCE POLICY

Purchase orders should be submitted via:

Email swanezpo@swanstone.com or Fax **(800) 342-7926**

To ensure accurate and timely processing and shipping of orders, all purchase orders require the following information:

- Submitted on customer letterhead (or Swan Purchase Order Form)
- Current net prices
- Current Swan part numbers
- Shipping information, method and freight terms
- Payment terms
- Contact phone number and email address

Please note we will only accept current Swan part numbers submitted on Purchase Orders. We will no longer process incorrect, outdated or unique customer product identifiers used on Purchase Orders.

Purchase orders submitted with missing or incorrect data will not be processed until corrected. Order corrections must be in writing (email or fax is acceptable). Purchase orders will only be accepted from customers responsible for invoice payment. There is a \$35 minimum charge on all purchase orders.

**** Purchase order lead times will automatically default to the longest product lead time on purchase order. ****

All purchase order changes or cancellations must be completed within 48 hours of purchase order acceptance. After 48 hours no changes will be allowed.

Custom Vanity Tops or Special Orders must be submitted on a separate Purchase Order. Custom Vanity Tops or Special Order items cannot be returned.

Orders received before 2 p.m. CST will be entered the same day and an order acknowledgment email will be issued. Orders received after 2 p.m. CST will be processed the following business day.

PRODUCT INDEX

Price/Color Codes: Solid (S), Aggregate (AG), White (W), Bone/Bisque (B), Granite (G), Other (O)

MODEL	PG	\$/COLOR		\$/COLOR	
AS-1075	16	200	S	269	AG
BA-3060	30	858	W	898	B
BF-1260	21	601	S	837	AG
BF-2300L/R	35	1368	W		
BF-2448	35	496	O		
BF-5024	35	161	O		
BF-5072	35	368	O		
BF-6000	35	666	W		
BF-CT	35	93	O		
BF-FT	35	165	O		
BS-1515	48	180	S	233	AG
BT-3060L/R	30	611	W	640	B
CF10000	52	76	O		
CHIB2225	24	535	S	720	AG
CHIB2231	24	624	S	839	AG
CHIB2237	24	725	S	977	AG
CHIB2243	24	827	S	1116	AG
CHIB2249	24	916	S	1234	AG
CHIB2255	24	1038	S	1401	AG
CHIB2261	24	1186	S	1597	AG
CH2B2261	24	1340	S	1805	AG
CH2B2273	24	1461	S	1972	AG
CHVTSS	25	102	S	136	AG
CM-2072	18	85	S	109	AG
CM-2096	18	99	S	127	AG
CNRSHELF	19	217	O		
CS-1616	17	548	S	740	AG
CHIB2225	24	367	S	428	AG
CVIB2231	24	429	S	500	AG
CVIB2237	24	494	S	573	AG
CVIB2243	24	577	S	672	AG
CVIB2249	24	648	S	760	AG
DC-MD	22, 34	21	S	46	O
DCK-1000	22, 34	124	W		
DD-CC	22, 34	17	O		
DD-RG	22, 34	20	O		
DIT	51	231	AG		
DIT-S	51	211	AG		
DSP-2	17	285	S	342	AG
DWP-3696BA-1	15	933	S	1082	AG
DWP-3696BB-1	15	933	S	1082	AG
DWP-3696GO-1	15	933	S	1082	AG
DWP-3696PB-1	15	933	S	1082	AG
DWP-3696TN-1	15	933	S	1082	AG
DWP-9636WB-1	15	933	S	1082	AG

MODEL	PG	\$/COLOR		\$/COLOR	
ES-2	16	118	S	152	AG
EVIB2225	25	367	S	428	AG
EVIB2231	25	429	S	500	AG
EVIB2237	25	494	S	573	AG
EVIB2243	25	577	S	672	AG
EVIB2249	25	648	S	760	AG
EVIB2255	25	755	S	880	AG
EVIB2261	25	837	S	977	AG
EVTSS	25	95	S	127	AG
FB10000	52	17	W		
FB-1260	33	556	W	556	B
FBF-3060LM/RM	33	1141	W	1256	B
FBF-3462	33	Quote	W		
FR-3260L/R	31	568	W	624	B
FTF-3838	33	Quote	W		
FTS-3738	34	526	W	581	B
GB-1432	35	406	O		
GN-58	28	1110	W	1162	B
KSDB-2518	48	189	S	246	AG
KSDB-3322	47	348	S	455	AG
KSLB-3322	47	432	S	568	AG
KSLS-3322	47	388	S	507	AG
KSRB-18	48	205	S	272	AG
KSSB-2522	47	313	S	413	AG
KSSB-3322	47	412	S	540	AG
KSTB-4422	48	500	S	656	AG
LP-MF-6PK	50	306	O		
MF-2F	50	487	O		
MF-2W	52	487	O		
MF-6PK	50	797	O		
MF-F	50	247	O		
MF-W	50	220	O		
MS-1224-2	53	317	O		
MS-2403	53	121	O		
MS-2405	53	71	O		
MS-2408	53	61	O		
MS-2410	52	31	O		
MS-2411	52	31	O		
MS-2412	53	363	O		
MS-2424	52	631	O		
MS-2436	52	688	O		
MS-2437	53	119	O		
MSMK-7230-1	11	588	S	685	AG
MSMK-7232-1	11	620	S	722	AG
MSMK-7234-1	11	652	S	760	AG



PRODUCT INDEX

Price/Color Codes: Solid (S), Aggregate (AG), White (W), Bone/Bisque (B), Granite (G), Other (O)

MODEL	PG	\$/COLOR		\$/COLOR	
MSMK-7236-1	11	685	S	799	AG
MSMK-7262-1	11	1153	S	1336	AG
MSMK-8430-1	11	761	S	892	AG
MSMK-8432-1	11	801	S	940	AG
MSMK-8434-1	11	844	S	988	AG
MSMK-8436-1	11	887	S	1040	AG
MSMK-8462-1	11	1514	S	1753	AG
MSMK-9630-1	11	801	S	940	AG
MSMK-9632-1	11	844	S	988	AG
MSMK-9634-1	11	887	S	1040	AG
MSMK-9636-1	11	933	S	1095	AG
MSMK-9662-1	11	1593	S	1845	AG
MSMK72-3062	10	2186	S	2573	AG
MSMK72-3262	10	2302	S	2708	AG
MSMK72-3462	10	2422	S	2852	AG
MSMK72-3662	10	2549	S	3001	AG
MSMK84-3062	10	2371	S	2892	AG
MSMK84-3262	10	2495	S	3045	AG
MSMK84-3462	10	2627	S	3204	AG
MSMK84-3662	10	2764	S	3372	AG
MSMK96-3062	10	2495	S	3045	AG
MSMK96-3262	10	2627	S	3204	AG
MSMK96-3462	10	2764	S	3372	AG
MSMK96-3662	10	2911	S	3550	AG
PVC-MD	22, 34	37	O		
QUAD-3322	45	1014	G		
QUDB-3322	45	977	G		
QUED-3322	45	977	G		
QULS-3322	45	1014	G		
QUSB-2522	45	822	G		
QUSB-3322	46	1014	G		
QZAD-3322	45	928	G		
QZBS-1816	46	639	G		
QZDB-3322	45	891	G		
QZED-3322	45	891	G		
QZLS-3322	45	928	G		
QZSB-2522	45	740	G		
QZSB-3322	46	884	G		
RECSHELF	19	217	O		
R-3232	31	331	W	360	B
R-3248	31	473	W	519	B
R-3260	31	573	W	629	B
R-3442	31	438	W	482	B
R-3448	31	486	W	534	B
R-3454	31	538	W	589	B

MODEL	PG	\$/COLOR		\$/COLOR	
R-3460	31	581	W	639	B
R-3636	31	369	W	408	B
R-3660	31	637	W	701	B
R-36DTF	32	480	W	526	B
R-36NEO	32	396	W	437	B
R-38NEO	32	446	W	492	B
R-4236	31	433	W	475	B
R-4242	31	502	W	554	B
R-4260	31	743	W	816	B
RS-2215	16	331	S	429	AG
SA-3232	30	969	W	1014	B
SA-3448	30	1163	W	1217	B
SA-3636	30	1084	W	1138	B
SB-1248	17	273	S	321	AG
SBF-3060L	21	1234	S	1727	AG
SBF-3060R	21	1234	S	1727	AG
SBF-3462	21	Quote	S	Quote	AG
SI-1003	18	37	O		
SK-363672	8	1899	S	2264	AG
SK-363696	8	2264	S	2717	AG
SK-364872	8	2398	S	2812	AG
SK-364896	8	2605	S	3177	AG
SK-366072	8	2495	S	2937	AG
SK-366296	8	2911	S	3550	AG
SK-484896	8	3128	S	3814	AG
SQMK72-3636	9	1899	S	2264	AG
SQMK72-3662	9	2549	S	3001	AG
SQMK96-3636	9	2264	S	2717	AG
SQMK96-3662	9	2911	S	3550	AG
SR-3260L/R	19	951	S	1331	AG
SS-29	18	162	S	162	AG
SS-3232	20	508	S	712	AG
SS-3248	20	681	S	955	AG
SS-3260	20	886	S	1239	AG
SS-3442	20	675	S	909	AG
SS-3448	20	724	S	1008	AG
SS-3454	20	833	S	1164	AG
SS-3460	20	896	S	1256	AG
SS-3636	20	596	S	832	AG
SS-3660	20	975	S	1364	AG
SS-3672-1	14	685	S	799	AG
SS-3672-2	14	1274	S	1499	AG
SS-3696-1	14	933	S	1082	AG
SS-3696-2	14	1685	S	1980	AG
SS-36DTF	20	725	S	1016	AG



PRODUCT INDEX

Price/Color Codes: Solid (S), Aggregate (AG), White (W), Bone/Bisque (B), Granite (G), Other (O)

MODEL	PG	\$/COLOR		\$/COLOR	
SS-36NEO	20	611	S	856	AG
SS-38NEO	20	692	S	966	AG
SS-4236	20	668	S	933	AG
SS-4242	20	756	S	1136	AG
SS-4260	20	1136	S	1590	AG
SS-4896-1	14	1234	S	1432	AG
SS-4896-2	14	2224	S	2618	AG
SS-60-3	13	1386	S	1646	AG
SS-60-5	13	1771	S	2392	AG
SS-6060-1	14	967	S	1122	AG
SS-6072-1	14	1153	S	1336	AG
SS-6296-1	14	1593	S	1845	AG
SS-72	18	77	S	77	AG
SS-72-3	13	1533	S	1808	AG
SS-7211	16	200	S	269	AG
SSIT-60-3	13	1855	S	2217	AG
SSSQ-3696-1	14	933	S	1082	AG
SSSQ-6296-1	14	1593	S	1845	AG
SSST-3696-1	14	933	S	1082	AG
SSST-6296-1	14	1593	S	1845	AG
SSUS	51	200	W	352	B
SSUS-S	51	168	W		
SSWTK-1	18	499	S	560	AG
STF-3838	21	Quote	W	Quote	AG
STMK72-3636	9	1899	S	2264	AG
STMK72-3662	9	2549	S	3001	AG
STMK96-3636	9	2264	S	2717	AG
STMK96-3662	9	2911	S	3550	AG
STS-3738	21	788	S	1100	AG
TF-57	28	781	W	837	B
TI-3	28	1310	W	1406	B
TI-5	29	1440	W	1550	B
TI-7260	28	2047	W	2199	B
TK-0372	18	112	S	148	AG
TK-105	17	676	S	878	AG
TK-105-TP	17	260	S	324	AG
TK-6072	17	560	S	730	AG
TSMK-7230-1	11	588	S	685	AG
TSMK-7232-1	11	620	S	722	AG
TSMK-7234-1	11	652	S	760	AG
TSMK-7236-1	11	685	S	799	AG
TSMK-7262-1	11	1153	S	1336	AG
TSMK-8430-1	11	761	S	892	AG
TSMK-8432-1	11	801	S	940	AG
TSMK-8434-1	11	844	S	988	AG

MODEL	PG	\$/COLOR		\$/COLOR	
TSMK-8436-1	11	887	S	1040	AG
TSMK-8462-1	11	1514	S	1753	AG
TSMK-9630-1	11	801	S	940	AG
TSMK-9632-1	11	844	S	988	AG
TSMK-9634-1	11	887	S	1040	AG
TSMK-9636-1	11	933	S	1095	AG
TSMK-9662-1	11	1593	S	1845	AG
TSMK72-3062	10	2186	S	2573	AG
TSMK72-3262	10	2302	S	2708	AG
TSMK72-3462	10	2422	S	2852	AG
TSMK72-3662	10	2549	S	3001	AG
TSMK84-3062	10	2371	S	2892	AG
TSMK84-3262	10	2495	S	3045	AG
TSMK84-3462	10	2627	S	3204	AG
TSMK84-3662	10	2764	S	3372	AG
TSMK96-3062	10	2495	S	3045	AG
TSMK96-3262	10	2627	S	3204	AG
TSMK96-3462	10	2764	S	3372	AG
TSMK96-3662	10	2911	S	3550	AG
UC-1913	27	344	S	366	AG
UL-1613	27	310	S	331	AG
UL-1913	27	344	S	366	AG
ULAD-1913	27	344	S	366	AG
US-1210	49	183	S	228	AG
US-1711	49	194	S	244	AG
US-2021	49	468	S	578	AG
US-2215	49	537	S	664	AG
US-3015	49	596	S	739	AG
USRB-18	49	312	S	416	AG
VP3232CPANNS	39	302	W		
VP3232CS	39	960	W		
VP3232CSA	39	1157	W		
VP3636CPANNS	39	317	W		
VP3636CS	39	1012	W		
VP3636CSA	39	1209	W		
VP4242CPANNS	39	416	W		
VP4834CPANNS	39	369	W		
VP4834CS	39	1088	W		
VP4834CSA	39	1279	W		
VP6030CPANNSL/R	39	466	W		
VP6030CSAL/R	39	1422	W		
VP6030CSL/R	39	1241	W		
VP6030CTL/R	40	417	W		
VP6030CTMINL/R	40	622	W		
VP6030CTML/R	40	465	W		



PRODUCT INDEX

Price/Color Codes: Solid (S), Aggregate (AG), White (W), Bone/Bisque (B), Granite (G), Other (O)

MODEL	PG	\$/COLOR	\$/COLOR		
VP6030CTMML/R	40	622	W		
VP6030CTS2AL/R	36	1271	W		
VP6030CTS2L/R	36	1050	W		
VP6030CTSAL/R	36	1271	W		
VP6030CTSL/R	36	1050	W		
VP6030CTSM2AL/R	36	1319	W		
VP6030CTSM2L/R	36	1098	W		
VP6030CTSMAL/R	36	1319	W		
VP6030CTSMIN2L/R	38	1255	W		
VP6030CTSMINAL/R	38	1476	W		
VP6030CTSMINL/R	38	1255	W		
VP6030CTSML/R	36	1098	W		
VP6030CTSMM2AL/R	38	1476	W		
VP6030CTSMM2L/R	38	1255	W		
VP6030CTSMMAL/R	38	1474	W		
VP6030CTSMML/R	38	1255	W		
VP6030CTSMN2AL/R	38	1476	W		
VP6032CTMINL/R	40	764	W		
VP6032CTMML/R	40	764	W		
VP6032CTSMIN2L/R	38	1412	W		
VP6032CTSMINAL/R	38	1640	W		
VP6032CTSMINL/R	40	1412	W		
VP6032CTSMM2AL/R	38	1640	W		
VP6032CTSMM2L/R	38	1412	W		
VP6032CTSMMAL/R	38	1640	W		
VP6032CTSMML/R	38	1412	W		
VP6032CTSMN2AL/R	38	1640	W		
VP6034CPANNS	39	466	W		
VP6034CS	39	1258	W		
VP6034CSA	39	1440	W		
VP6036CTL/R	40	947	W		
VP6036CTML/R	40	990	W		
VP6036CTS2AL/R	36	1877	W		
VP6036CTS2L/R	36	1622	W		
VP6036CTSAL/R	36	1877	W		
VP6036CTSL/R	36	1622	W		
VP6036CTSM2AL/R	36	1920	W		
VP6036CTSM2L/R	36	1665	W		
VP6036CTSMAL/R	36	1920	W		
VP6036CTSML/R	36	1665	W		
VP6042CTL/R	40	990	W		
VP6042CTML/R	40	1037	W		
VP6042CTS2AL/R	37	1959	W		
VP6042CTS2L/R	37	1703	W		
VP6042CTSAL/R	37	1959	W		

MODEL	PG	\$/COLOR	\$/COLOR	\$/COLOR	\$/COLOR
VP6042CTSL/R	36	1703	W		
VP6042CTSM2AL/R	37	2006	W		
VP6042CTSM2L/R	37	1750	W		
VP6042CTSMAL/R	37	2006	W		
VP6042CTSML/R	37	1750	W		
VPF6030CTS2L/R	37	2959	W		
VPF6030CTSMN2L/R	37	3164	W		
VPF6032CTSMN2L/R	37	3306	W		
VT-18-3SS	25	68	S	85	AG
VT19-SS	25	88	S	116	AG
VT1B1719	23	294	S	397	AG
VT1B1925	23	300	S	406	AG
VT1B1931	23	351	S	472	AG
VT1B1937	23	408	S	548	AG
VT1B2225	23	300	S	406	AG
VT1B2231	23	351	S	472	AG
VT1B2237	23	408	S	548	AG
VT1B2243	23	464	S	628	AG
VT1B2249	23	515	S	696	AG
VC1B2255	23	584	S	788	AG
VC1B2261	23	666	S	896	AG
VT-21-3SS	25	69	S	88	AG
VT22-SS	25	88	S	116	AG
VT22SA	26	99	S	132	AG
VT2B2261	23	753	S	1016	AG
VT37FA	26	169	S	228	AG
VT55FA	26	253	S	340	AG
VT61FA	26	279	S	376	AG
VTS-50ADA	26	1382	S	1865	AG
VTS-74ADA	26	1382	S	1865	AG
WB-2218	26	352	S	410	AG
WS-1	52	80	W		





BATH SOLUTIONS

SWANSTONE

BATH WALL KITS

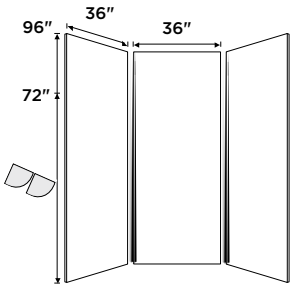

SK-363672
SK-363696

SK-363672 AND SK-363696

Model	Part	Dimensions (in)	Weight (lbs)	Carton Size (in)	C/F	Solid \$	Aggregate \$
SK-363672	SK363672.XXX	36 D x 36 W x 72 H	126	75 x 44 x 3	5.7	1899	2264
SK-363696	SK363696.XXX	36 D x 36 W x 96 H	200	102 x 43 x 4	10.2	2264	2717

Fits bases: 36" D x 36" W or smaller.

Includes: Two side panels, one back panel, two corner molding strips, two corner soap shelves.

Standard Colors: White (010), Bone (037), Bisque (018).

Aggregate Colors: See color listing for details.

Packaging: Rectangular carton.

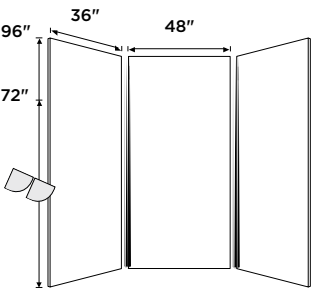

SK-364872
SK-364896

SK-364872 AND SK-364896

Model	Part	Dimensions (in)	Weight (lbs)	Carton Size (in)	C/F	Solid \$	Aggregate \$
SK-364872	SK364872.XXX	36 D x 48 W x 72 H	173	78 x 54 x 4	9.8	2398	2812
SK-364896	SK364896.XXX	36 D x 48 W x 96 H	212	102 x 54 x 4	12.8	2605	3177

SK-364896 REPLACES MK96-3648

Fits bases: 36" D x 48" W or smaller.

Includes: Two side panels, one back panel, two corner molding strips, two corner soap shelves.

Standard Colors: White (010), Bone (037), Bisque (018).

Aggregate Colors: See color listing for details.

Packaging: Rectangular carton.

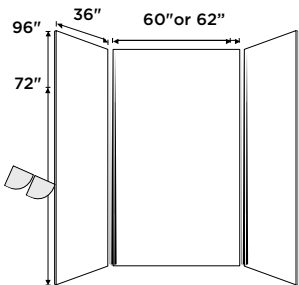

SK-366072
SK-366296

SK-366072 AND SK-366296

Model	Part	Dimensions (in)	Weight (lbs)	Carton Size (in)	C/F	Solid \$	Aggregate \$
SK-366072	SK336072.XXX	36 D x 60 W x 72 H	195	78 x 66 x 4	11.9	2495	2937
SK-366296	SK366296.XXX	36 D x 62 W x 96 H	288	103 x 68 x 4	16.2	2911	3550

SK-366296 REPLACES MK96-3662

Fits bases: 36" D x 62" W or smaller.

Includes: Two side panels, one back panel, two corner molding strips, two corner soap shelves.

Standard Colors: White (010), Bone (037), Bisque (018).

Aggregate Colors: See color listing for details.

Packaging: Rectangular carton.

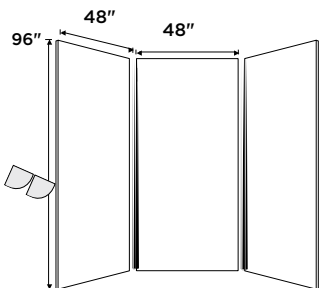

SK-484896

SK-484896

Model	Part	Dimensions (in)	Weight (lbs)	Carton Size (in)	C/F	Solid \$	Aggregate \$
SK-484896	SK484896.XXX	48 D x 48 W x 96 H	244	102 x 54 x 4	12.8	3128	3814

SK-484896 REPLACES MK96-4848

Fits bases: 48" D x 48" W or smaller.

Includes: Two side panels, one back panel, two corner molding strips, two corner soap shelves.

Standard Colors: White (010), Bone (037), Bisque (018).

Aggregate Colors: See color listing for details.

Packaging: Rectangular carton.

SWANSTONE

CLASSIC SUBWAY AND SQUARE TILE BATH WALL KITS

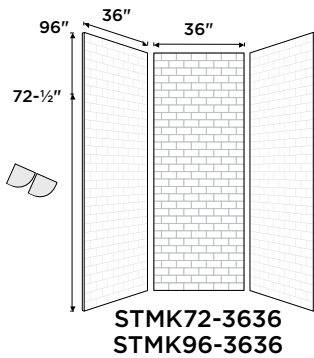

STMK72-3636 AND STMK96-3636

Model	Part	Dimensions (in)	Weight (lbs)	Carton Size (in)	C/F	Solid \$	Aggregate \$
STMK72-3636	STMK723636.XXX	36 D x 36 W x 72-½ H	154	79 x 44 x 4	8.0	1899	2264
STMK96-3636	STMK963636.XXX	36 D x 36 W x 96 H	211	102 x 43 x 4	10.2	2264	2717

Fits bases: 36" D x 36" W or smaller.

Includes: Two side panels, one back panel, two corner soap shelves.

Standard Colors: White (010), Bone (037), Bisque (018).

Aggregate Colors: See color listing for details.

Packaging: Rectangular carton.

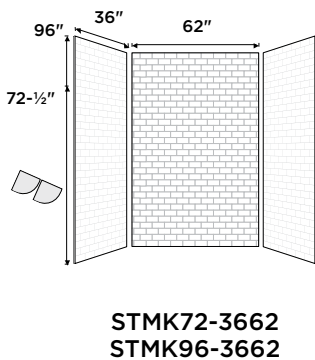

STMK72-3662 AND STMK96-3662

Model	Part	Dimensions (in)	Weight (lbs)	Carton Size (in)	C/F	Solid \$	Aggregate \$
STMK72-3662	STMK723662.XXX	36 D x 62 W x 72-½ H	223	79 x 69 x 4	12.6	2549	3001
STMK96-3662	STMK963662.XXX	36 D x 62 W x 96 H	288	102 x 68 x 4	16.1	2911	3550

Fits bases: 36" D x 62" W or smaller.

Includes: Two side panels, one back panel, two corner soap shelves.

Standard Colors: White (010), Bone (037), Bisque (018).

Aggregate Colors: See color listing for details.

Packaging: Rectangular carton.

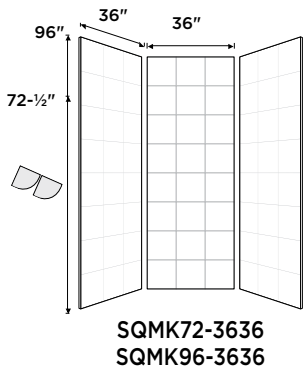

SQMK72-3636 AND SQMK96-3636

Model	Part	Dimensions (in)	Weight (lbs)	Carton Size (in)	C/F	Solid \$	Aggregate \$
SQMK72-3636	SQMK723636.XXX	36 D x 36 W x 72-½ H	152	79 x 44 x 4	8.0	1899	2264
SQMK96-3636	SQMK963636.XXX	36 D x 36 W x 96 H	202	102 x 43 x 4	10.2	2264	2717

Fits bases: 36" D x 36" W or smaller.

Includes: Two side panels, one back panel, corner soap shelves.

Standard Colors: White (010), Bone (037), Bisque (018).

Aggregate Colors: See color listing for details.

Packaging: Rectangular carton.

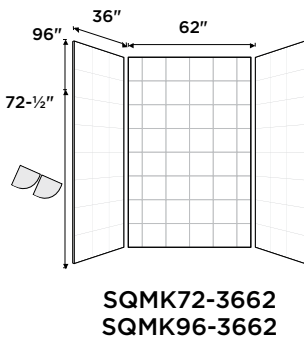

SQMK72-3662 AND SQMK96-3662

Model	Part	Dimensions (in)	Weight (lbs)	Carton Size (in)	C/F	Solid \$	Aggregate \$
SQMK72-3662	SQMK723662.XXX	36 D x 62 W x 72-½ H	217	79 x 69 x 4	12.6	2549	3001
SQMK96-3662	SQMK963662.XXX	36 D x 62 W x 96 H	287	102 x 68 x 4	16.1	2911	3550

Fits bases: 36" D x 62" W or smaller.

Includes: Two side panels, one back panel, two corner soap shelves.

Standard Colors: White (010), Bone (037), Bisque (018).

Aggregate Colors: See color listing for details.

Packaging: Rectangular carton.



SWANSTONE

MODERN AND TRADITIONAL SUBWAY TILE BATH WALL KITS

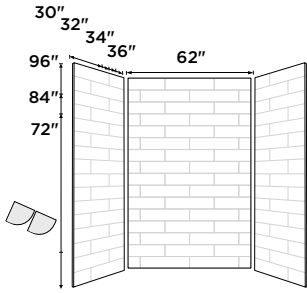

SWANSTONE MODERN SUBWAY TILE BATH WALL KITS

Model	Part	Dimensions (in)	Weight (lbs)	Carton Size (in)	C/F	Solid \$	Aggregate \$
MSMK96-3062	MSMK963062.XXX	30 D x 62 W x 96 H	285	102 x 68 x 4	16.1	2495	3045
MSMK96-3262	MSMK963262.XXX	32 D x 62 W x 96 H	294	102 x 68 x 4	16.1	2627	3204
MSMK96-3462	MSMK963462.XXX	34 D x 62 W x 96 H	303	102 x 68 x 4	16.1	2764	3372
MSMK96-3662	MSMK963662.XXX	36 D x 62 W x 96 H	313	102 x 68 x 4	16.1	2911	3550
MSMK84-3062	MSMK843062.XXX	30 D x 62 W x 84 H	249	90 x 68 x 4	14.2	2371	2892
MSMK84-3262	MSMK843262.XXX	32 D x 62 W x 84 H	258	90 x 68 x 4	14.2	2495	3045
MSMK84-3462	MSMK843462.XXX	34 D x 62 W x 84 H	266	90 x 68 x 4	14.2	2627	3204
MSMK84-3662	MSMK843662.XXX	36 D x 62 W x 84 H	274	90 x 68 x 4	14.2	2764	3372
MSMK72-3062	MSMK723062.XXX	30 D x 62 W x 72 H	214	78 x 68 x 4	12.3	2186	2573
MSMK72-3262	MSMK723262.XXX	32 D x 62 W x 72 H	221	78 x 68 x 4	12.3	2302	2708
MSMK72-3462	MSMK723462.XXX	34 D x 62 W x 72 H	228	78 x 68 x 4	12.3	2422	2852
MSMK72-3662	MSMK723662.XXX	36 D x 62 W x 72 H	235	78 x 68 x 4	12.3	2549	3001

Fits bases: 36" D x 62" W or smaller.

Includes: Two side panels, one back panel, two corner soap shelves.

Standard Colors: White (010), Bone (037), Bisque (018).

Aggregate Colors: See color listing for details.

Packaging: Rectangular carton.

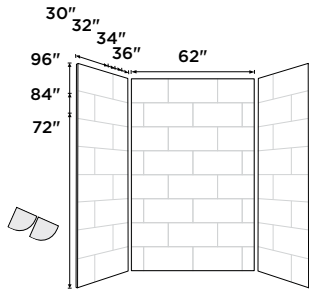

SWANSTONE TRADITIONAL SUBWAY TILE BATH WALL KITS

Model	Part	Dimensions (in)	Weight (lbs)	Carton Size (in)	C/F	Solid \$	Aggregate \$
TSMK96-3062	TSMK963062.XXX	30 D x 62 W x 96 H	285	102 x 68 x 4	16.1	2495	3045
TSMK96-3262	TSMK963262.XXX	32 D x 62 W x 96 H	294	102 x 68 x 4	16.1	2627	3204
TSMK96-3462	TSMK963462.XXX	34 D x 62 W x 96 H	303	102 x 68 x 4	16.1	2764	3372
TSMK96-3662	TSMK963662.XXX	36 D x 62 W x 96 H	313	102 x 68 x 4	16.1	2911	3550
TSMK84-3062	TSMK843062.XXX	30 D x 62 W x 84 H	249	90 x 68 x 4	14.2	2371	2892
TSMK84-3262	TSMK843262.XXX	32 D x 62 W x 84 H	258	90 x 68 x 4	14.2	2495	3045
TSMK84-3462	TSMK843462.XXX	34 D x 62 W x 84 H	266	90 x 68 x 4	14.2	2627	3204
TSMK84-3662	TSMK843662.XXX	36 D x 62 W x 84 H	274	90 x 68 x 4	14.2	2764	3372
TSMK72-3062	TSMK723062.XXX	30 D x 62 W x 72 H	214	78 x 68 x 4	12.3	2186	2573
TSMK72-3262	TSMK723262.XXX	32 D x 62 W x 72 H	221	78 x 68 x 4	12.3	2302	2708
TSMK72-3462	TSMK723462.XXX	34 D x 62 W x 72 H	228	78 x 68 x 4	12.3	2422	2852
TSMK72-3662	TSMK723662.XXX	36 D x 62 W x 72 H	235	78 x 68 x 4	12.3	2549	3001

Fits bases: 36" D x 62" W or smaller.

Includes: Two side panels, one back panel, two corner soap shelves.

Standard Colors: White (010), Bone (037), Bisque (018).

Aggregate Colors: See color listing for details.

Packaging: Rectangular carton.

Color Code Reference Guide (Alphabetical order)

Replace XXX in part number with 3-digit color code.

Note: Some colors available by quote only.

Granite Colors are only available for Granite Kitchen Sinks.

* Kitchen/Utility Sinks only. Flock is only available for specific products.

GRANITE

Opal White (210)
Espresso (170)
Granito (076)
Metallico (173)
Nero (077)

SOLID

White (010)
Bisque (018)
Bone (037)
Flock (033)*

AGGREGATE

Bermuda Sand (040)
Black Galaxy (015)*
Carrara (221)
Concrete Ash Gray (203)
Concrete Birch (226)
Concrete Charcoal Gray (209)
Concrete Clay (212)
Concrete Limestone (218)
Concrete Sandstone (215)
Ice (130)
Tahiti White (011)

SWANSTONE

MODERN AND TRADITIONAL SUBWAY TILE BATH WALL PANELS

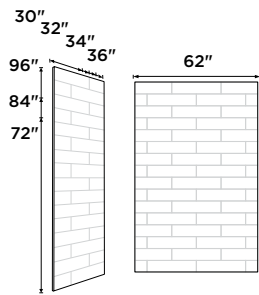

SWANSTONE MODERN SUBWAY TILE BATH WALL SINGLE PANEL

Model	Part	Dimensions (in)	Weight (lbs)	Carton Size (in)	C/F	Solid \$	Aggregate \$
MSMK-9630-1	MSMK9630.xxx	30 W x 96 H	70	102 x 43 x 4	10.2	801	940
MSMK-9632-1	MSMK9632.xxx	32 W x 96 H	75	102 x 43 x 4	10.2	844	988
MSMK-9634-1	MSMK9634.xxx	34 W x 96 H	80	102 x 43 x 4	10.2	887	1040
MSMK-9636-1	MSMK9636.xxx	36 W x 96 H	85	102 x 43 x 4	10.2	933	1095
MSMK-8430-1	MSMK8430.xxx	30 W x 84 H	62	90 x 43 x 4	9	761	892
MSMK-8432-1	MSMK8432.xxx	32 W x 84 H	66	90 x 43 x 4	9	801	940
MSMK-8434-1	MSMK8434.xxx	34 W x 84 H	70	90 x 43 x 4	9	844	988
MSMK-8436-1	MSMK8436.xxx	36 W x 84 H	74	90 x 43 x 4	9	887	1040
MSMK-7230-1	MSMK7230.xxx	30 W x 72 H	53	78 x 43 x 4	7.8	588	685
MSMK-7232-1	MSMK7232.xxx	32 W x 72 H	56	78 x 43 x 4	7.8	620	722
MSMK-7234-1	MSMK7234.xxx	34 W x 72 H	60	78 x 43 x 4	7.8	652	760
MSMK-7236-1	MSMK7236.xxx	36 W x 72 H	63	78 x 43 x 4	7.8	685	799
MSMK-9662-1	MSMK9662.xxx	62 W x 96 H	145	102 x 68 x 4	16.1	1593	1845
MSMK-8462-1	MSMK8462.xxx	62 W x 84 H	127	90 x 68 x 4	14.2	1514	1753
MSMK-7262-1	MSMK7262.xxx	62 W x 72 H	109	78 x 68 x 4	12.3	1153	1336

Includes: One Wall Panel.

Standard Colors: White (010), Bone (037), Bisque (018).

Aggregate Colors: See color listing for details.

Packaging: Individual carton

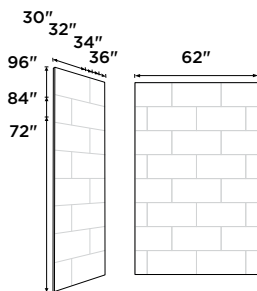

SWANSTONE TRADITIONAL SUBWAY TILE BATH WALL SINGLE PANEL

Model	Part	Dimensions (in)	Weight (lbs)	Carton Size (in)	C/F	Solid \$	Aggregate \$
TSMK-9630-1	TSMK9630.xxx	30 W x 96 H	70	102 x 43 x 4	10.2	801	940
TSMK-9632-1	TSMK9632.xxx	32 W x 96 H	75	102 x 43 x 4	10.2	844	988
TSMK-9634-1	TSMK9634.xxx	34 W x 96 H	80	102 x 43 x 4	10.2	887	1040
TSMK-9636-1	TSMK9636.xxx	36 W x 96 H	85	102 x 43 x 4	10.2	933	1095
TSMK-8430-1	TSMK8430.xxx	30 W x 84 H	62	90 x 43 x 4	9	761	892
TSMK-8432-1	TSMK8432.xxx	32 W x 84 H	66	90 x 43 x 4	9	801	940
TSMK-8434-1	TSMK8434.xxx	34 W x 84 H	70	90 x 43 x 4	9	844	988
TSMK-8436-1	TSMK8436.xxx	36 W x 84 H	74	90 x 43 x 4	9	887	1040
TSMK-7230-1	TSMK7230.xxx	30 W x 72 H	53	78 x 43 x 4	7.8	588	685
TSMK-7232-1	TSMK7232.xxx	32 W x 72 H	56	78 x 43 x 4	7.8	620	722
TSMK-7234-1	TSMK7234.xxx	34 W x 72 H	60	78 x 43 x 4	7.8	652	760
TSMK-7236-1	TSMK7236.xxx	36 W x 72 H	63	78 x 43 x 4	7.8	685	799
TSMK-9662-1	TSMK9662.xxx	62 W x 96 H	145	102 x 68 x 4	16.1	1593	1845
TSMK-8462-1	TSMK8462.xxx	62 W x 84 H	127	90 x 68 x 4	14.2	1514	1753
TSMK-7262-1	TSMK7262.xxx	62 W x 72 H	109	78 x 68 x 4	12.3	1153	1336

Includes: One Wall Panel.

Standard Colors: White (010), Bone (037), Bisque (018).

Aggregate Colors: See color listing for details.

Packaging: Individual carton

Color Code Reference Guide (Alphabetical order)

Replace XXX in part number with 3-digit color code.

Note: Some colors available by quote only.

Granite Colors are only available for Granite Kitchen Sinks.

* Kitchen/Utility Sinks only. Flock is only available for specific products.

GRANITE

Opal White (210)
Espresso (170)
Granito (076)
Metallico (173)
Nero (077)

SOLID

White (010)
Bisque (018)
Bone (037)
Flock (033)*

AGGREGATE

Bermuda Sand (040)
Black Galaxy (015)*
Carrara (221)
Concrete Ash Gray (203)
Concrete Birch (226)
Concrete Charcoal Gray (209)
Concrete Clay (212)
Concrete Limestone (218)
Concrete Sandstone (215)
Ice (130)
Tahiti White (011)





SWANSTONE

TUB WALL KITS

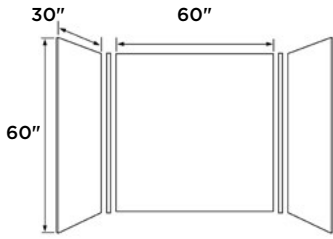

SS-60-3

SS-60-3

Model	Part	Dimensions (in)	Weight (lbs)	Carton Size (in)	C/F	Solid \$	Aggregate \$
SS-60-3	SS00603.XXX	30 D x 60 W x 60 H	166	66 x 66 x 4	10.1	1386	1646

Fits bases: 36" D x 60" W or smaller.

Includes: One flat back panel, two flat side panels and two corner moldings. SS-29 installation kit sold separately.

Standard Colors: White (010), Bone (037), Bisque (018).

Aggregate Colors: See color listing for details.

Packaging: Rectangular carton.

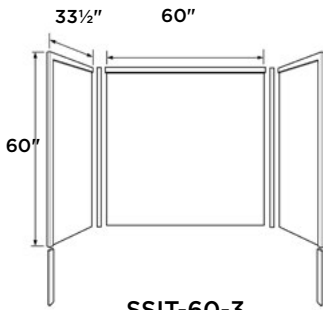

SSIT-60-3

SSIT-60-3

Model	Part	Dimensions (in)	Weight (lbs)	Carton Size (in)	C/F	Solid \$	Aggregate \$
SSIT-60-3	SI00603.XXX	33-1/2 D x 60 W x 60 H	150	67 x 67 x 5	13.0	1855	2217

Fits bases: 33-1/2" D x 60" W bathtub or smaller

Includes: One flat back panel, two flat side panels and two corner moldings. SS-29 installation kit sold separately.

Standard Colors: White (010), Bone (037), Bisque (018).

Aggregate Colors: See color listing for details.

Packaging: Rectangular carton.

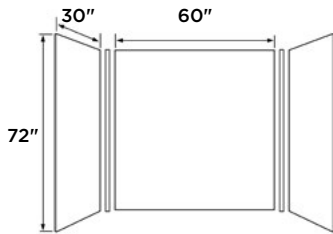

SS-72-3

SS-72-3

Model	Part	Dimensions (in)	Weight (lbs)	Carton Size (in)	C/F	Solid \$	Aggregate \$
SS-72-3	SS00723.XXX	30 D x 60 W x 72 H	185	78 x 66 x 4	11.9	1533	1808

Fits bases: 30" D x 60" W bathtub or smaller.

Includes: One flat back panel, two flat side panels and two corner moldings. SS-29 installation kit sold separately.

Standard Colors: White (010), Bone (037), Bisque (018).

Aggregate Colors: See color listing for details.

Packaging: Rectangular carton.

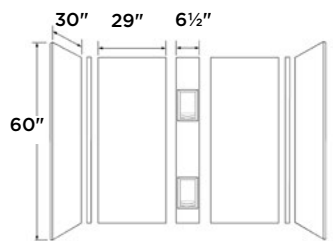

SS-60-5

SS-60-5

Model	Part	Dimensions (in)	Weight (lbs)	Carton Size (in)	C/F	Solid \$	Aggregate \$
SS-60-5	SS00605.XXX	30 D x 60 W x 60 H	106	32 x 63 x 6	7.0	1771	2392

Fits bases: 36" D x 62" W or smaller.

Includes: One back panel with two molded-in soap shelves, four flat wall panels and two corner moldings.

Standard Colors: White (010), Bone (037), Bisque (018).

Aggregate Colors: See color listing for details.

Packaging: Rectangular carton.

Color Code Reference Guide (Alphabetical order)

Replace XXX in part number with 3-digit color code.

Note: Some colors available by quote only.

Granite Colors are only available for Granite Kitchen Sinks.

* Kitchen/Utility Sinks only. Flock is only available for specific products.

GRANITE

Opal White (210)
Espresso (170)
Granito (076)
Metallico (173)
Nero (077)

SOLID

White (010)
Bisque (018)
Bone (037)
Flock (033)*

AGGREGATE

Bermuda Sand (040)
Black Galaxy (015)*
Carrara (221)
Concrete Ash Gray (203)
Concrete Birch (226)
Concrete Charcoal Gray (209)
Concrete Clay (212)
Concrete Limestone (218)
Concrete Sandstone (215)
Ice (130)
Tahiti White (011)



SWANSTONE

BATH WALL PANELS

SINGLE PANEL BATH WALL



Single Panel

Model	Part	Dimensions (in)	Weight (lbs)	Carton Size (in)	C/F	Solid \$	Aggregate \$
SS-6060-1	SS0606001.XXX	60 W x 60 H	96	66 x 66 x 4	10.1	967	1122

SINGLE PANEL SHOWER WALL

Model	Part	Dimensions (in)	Weight (lbs)	Carton Size (in)	C/F	Solid \$	Aggregate \$
SS-3672-1	SS0367201.XXX	36 W x 72 H	46	75 x 39 x 3	5.1	685	799
SS-6072-1	SS0607201.XXX	60 W x 72 H	116	78 x 66 x 4	11.9	1153	1336
SS-3696-1	SS0369601.XXX	36 W x 96 H	103	102 x 43 x 4	10.2	933	1082
SS-4896-1	SS0489601.XXX	48 W x 96 H	121	102 x 54 x 4	12.8	1234	1432
SS-6296-1	SS0629601.XXX	62 W x 96 H	154	102 x 68 x 4	16.1	1593	1845

DOUBLE PANEL SHOWER WALLS

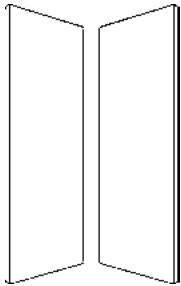

Double Panel

Model	Part	Dimensions (in)	Weight (lbs)	Carton Size (in)	C/F	Solid \$	Aggregate \$
SS-3672-2	SS0367202.XXX	36 W x 72 H	83	75 x 39 x 3	5.1	1274	1499
SS-3696-2	SS0369602.XXX	36 W x 96 H	149	102 x 43 x 4	10.2	1685	1980
SS-4896-2	SS0489602.XXX	48 W x 96 H	170	102 x 54 x 4	12.8	2224	2618

Includes: One or two flat wall panel(s) only. It may be necessary to combine cartons to accommodate desired installation area. No installation materials provided. Order one SS-72 installation kit per panel, except for 48" and 60" panels, which require two kits per panel.

Standard Colors: White (010), Bone (037), Bisque (018).

Aggregate Colors: See color listing for details.

Packaging: Flat, rectangular carton.

SWANSTONE CLASSIC SUBWAY TILE BATH WALL SINGLE PANEL

Model	Part	Dimensions (in)	Weight (lbs)	Carton Size (in)	C/F	Solid \$	Aggregate \$
SSST-3696-1	SSST369601.XXX	36 W x 96 H	96	102 x 43 x 4	10.2	933	1082
SSST-6296-1	SSST629601.XXX	62 W x 96 H	181	102 x 68 x 4	16.1	1593	1845

Includes: One wall panel.

Standard Colors: White (010), Bone (037), Bisque (018).

Aggregate Colors: See color listing for details.

Packaging: Individual carton.

SWANSTONE SQUARE TILE BATH WALL SINGLE PANEL

Model	Part	Dimensions (in)	Weight (lbs)	Carton Size (in)	C/F	Solid \$	Aggregate \$
SSSQ-3696-1	SSSQ369601.XXX	36 W x 96 H	99	102 x 43 x 4	10.2	933	1082
SSSQ-6296-1	SSSQ629601.XXX	62 W x 96 H	154	102 x 68 x 4	16.1	1593	1845

Includes: One wall panel.

Standard Colors: White (010), Bone (037), Bisque (018).

Aggregate Colors: See color listing for details.

Packaging: Individual carton.

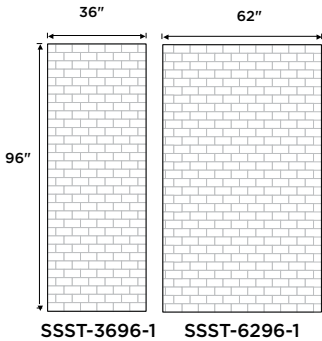

SSST-3696-1 SSST-6296-1

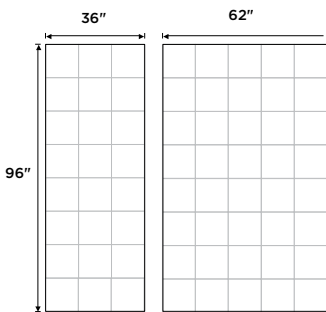

SSSQ-3696-1 SSSQ-6296-1

SWANSTONE

BATH WALL PANELS

SWANSTONE DECORATIVE SINGLE PANELS

Model	Part	Pattern	Dimensions (in)	Weight (lbs)	Carton Size (in)	C/F	Solid \$	Aggregate \$
DWP-3696BA-1	DP03696BA01.XXX	Barcelona	36 W x 96 H	96	102 x 43 x 4	10.2	933	1082
DWP-3696BB-1	DP03696BB01.XXX	Beadboard	36 W x 96 H	96	102 x 43 x 4	10.2	933	1082
DWP-3696GO-1	DP03696GO01.XXX	Geometric	36 W x 96 H	96	102 x 43 x 4	10.2	933	1082
DWP-3696PB-1	DP03696PB01.XXX	Pebble	36 W x 96 H	96	102 x 43 x 4	10.2	933	1082
DWP-3696TN-1	DP03696TN01.XXX	Tangier	36 W x 96 H	96	102 x 43 x 4	10.2	933	1082
DWP-9636WB-1	DP09636WB01.XXX	Wainscot Beadboard	96 W x 36 H	96	102 x 43 x 4	10.2	933	1082

Includes: One flat panel. No installation materials provided.

Standard Colors: White (O10), Bone (O37), Bisque (O18).

Aggregate Colors: See color listing for details.

Packaging: Rectangular carton. See illustrations on page 14 for design details.

WAINSCOT BEADBOARD PANELS

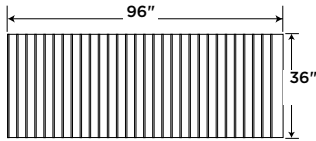

DECORATIVE WALL PANEL
OPTIONS (DETAIL SHOWN)

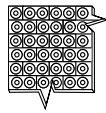

Barcelona
(BA)

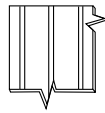

Beadboard (BB)
Wainscot
Beadboard (WB)

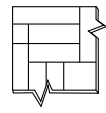

Geometric
(GO)

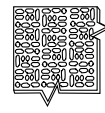

Pebble
(PB)

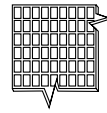

Tangier
(TN)



SWANSTONE

BATH ACCESSORIES

STANDARD CORNER SOAP SHELVES ES-2

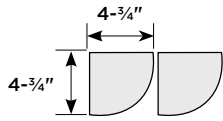

Model	Part	Dimensions (in)	Weight (lbs)	FedEx	Carton Size (in)	C/F	Solid \$	Aggregate \$
ES-2	ES20000.XXX	4- ³ / ₄ D x 4- ³ / ₄ W	4	✓	6 x 6 x 4	0.1	118	152

Includes: Two soap shelves. Installs in corner only.
Standard Colors: White (010), Bone (037), Bisque (018).
Aggregate Colors: See color listing for details.
Packaging: Individual carton.

CORNER SOAP SHELF SS-7211

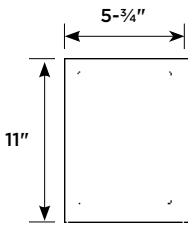

Model	Part	Dimensions (in)	Weight (lbs)	FedEx	Carton Size (in)	C/F	Solid \$	Aggregate \$
SS-7211	SS07211.XXX	5- ³ / ₄ W x 11 H	5	✓	14 x 11 x 8	0.7	200	269

Includes: Two soap shelves. Installs in corner only.
Standard Colors: White (010), Bone (037), Bisque (018).
Aggregate Colors: See color listing for details.
Packaging: Individual carton.

RECESSED ACCESSORY SHELF AS-1075

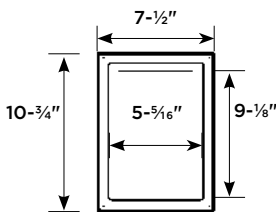

Model	Part	Dimensions (in)	Weight (lbs)	FedEx	Carton Size (in)	C/F	Solid \$	Aggregate \$
AS-1075	AS01075.XXX	4- ¹ / ₂ D x 7- ¹ / ₂ W x 10- ³ / ₄ H	5	✓	14 x 10 x 7	0.6	200	269

Includes: One recessed shelf. Installs vertically or horizontally between studs.
Standard Colors: White (010), Bone (037), Bisque (018).
Aggregate Colors: See color listing for details.
Packaging: Individual carton.

RECESSED SHAMPOO SHELF RS-2215

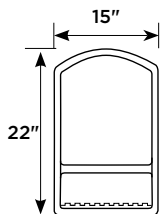

Model	Part	Dimensions (in)	Weight (lbs)	FedEx	Carton Size (in)	C/F	Solid \$	Aggregate \$
RS-2215	RS02215.XXX	4- ⁵ / ₁₆ D x 15 W x 22 H	13	✓	27 x 20 x 7	2.2	331	429

Includes: One recessed shelf. Installs vertically or horizontally between studs.
Standard Colors: White (010), Bone (037), Bisque (018).
Aggregate Colors: See color listing for details.
Packaging: Individual carton.

SWANSTONE

BATH ACCESSORIES

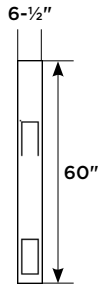

TUB WALL SOAP SHELF PANEL DSP-2

Model	Part	Dimensions (in)	Weight (lbs)	FedEx	Carton Size (in)	C/F	Solid \$	Aggregate \$
DSP-2	SS60000SD.XXX	6-1/2 W x 60 H	10	✓	62 x 8 x 5	1.4	285	342

Includes: One 6-1/2" W x 60" H panel with two molded-in soap shelves (fits 60" H tub panel only).
Standard Colors: White (010), Bone (037), Bisque (018).
Aggregate Colors: See color listing for details.
Packaging: Individual carton.

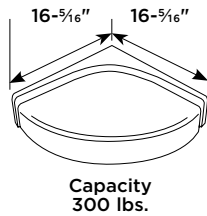

CORNER SHOWER SEAT CS-1616

Model	Part	Dimensions (in)	Weight (lbs)	FedEx	Carton Size (in)	C/F	Solid \$	Aggregate \$
CS-1616	CS01616.XXX	16-5/16 D x 16-5/16 W x 4 H	19	✓	22 x 22 x 5	1.4	548	740

Includes: One shower seat, one stainless steel mounting bracket and six lag bolts and washers.
Standard Colors: White (010), Bone (037), Bisque (018).
Aggregate Colors: See color listing for details.
Packaging: Individual carton.

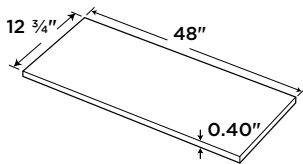

SHOWER BENCH SEAT TOP SB-1248

Model	Part	Dimensions (in)	Weight (lbs)	FedEx	Carton Size (in)	C/F	Solid \$	Aggregate \$
SB-1248	SB01248.XXX	12-3/4 D x 48 W	18	✓	52 x 14 x 2	0.8	273	321

Includes: One 12-3/4 D x 48" W Swanstone shower bench seat.
Standard Colors: White (010), Bone (037), Bisque (018).
Aggregate Colors: See color listing for details.
Packaging: Individual carton.

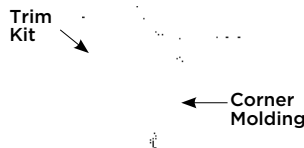

SWANSTONE WALL PANEL TRIM KITS TK-6072, TK-105, TK-105-TP

Model	Part	Weight (lbs)	FedEx	Carton Size (in)	C/F	Solid \$	Aggregate \$
TK-6072	TK06072.XXX	6	✓	75 x 9 x 3	1.2	560	730
TK-105	TK00105.XXX	35	—	108 x 6 x 6	2.3	676	878
TK-105-TP	TK00105TP.XXX	16	--	108 x 6 x 6	2.3	260	324

Note: TK-6072 accommodates Swanstone 60" W or 72" H bathtub and shower wall panel systems.
Includes: Four 3-7/8" x 74" trim strips and two 1-1/4" x 1/2" x 72" corner moldings and one tube of color coordinated silicone.
Note: TK-105 accommodates Swanstone 96" H shower wall panel system.
Includes: Two 3-7/8" x 105" trim strips, two 3-7/8" x 74" trim strips, and two 1-1/4" x 1/2" x 96" corner moldings and one tube of color coordinated silicone.
Note: TK-105-TP: Single trim piece.
Includes: One 3-7/8" x 105" trim piece. Can be cut to use with 72" walls.
Standard Colors: White (010), Bone (037), Bisque (018).
Aggregate Colors: See color listing for details.
Packaging: Individual cartons.



SWANSTONE

BATH ACCESSORIES

SWANSTONE WALL PANEL CORNER MOLDINGS CM-2072, CM-2096

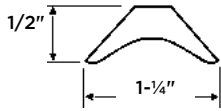

Model	Part	Dimensions (in)	Weight (lbs)	FedEx	Carton Size (in)	C/F	Solid \$	Aggregate \$
CM-2072	CM00072.XXX	½ D x 1-¼ W x 72 H	5	✓	74 x 3 x 3	0.4	85	109
CM-2096	CM00096.XXX	½ D x 1-¼ W x 96 H	7	✓	98 x 3 x 3	0.5	99	127

Includes: Set of two (2)

Standard Colors: White (010), Bone (037), Bisque (018).

Aggregate Colors: See color listing for details

Packaging: Individual cartons.

BATTEN STRIP TK-0372

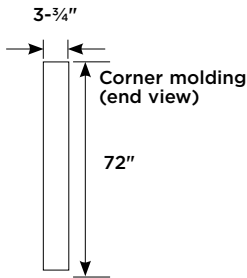

Model	Part	Dimensions (in)	Weight (lbs)	FedEx	Carton Size (in)	C/F	Solid \$	Aggregate \$
TK-0372	TK00372.XXX	¼ D x 3-¾ W x 72 H	6	✓	73 x 5 x 1	0.2	112	148

Includes: One 3-3/4" W x 72" H flat batten strip.

Standard Colors: White (010), Bone (037), Bisque (018).

Aggregate Colors: See color listing for details.

Packaging: Individual carton.

SWANSTONE WINDOW TRIM KIT SSWTK-1

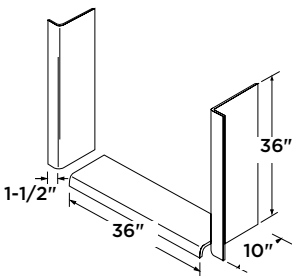

Model	Part	Dimensions (in)	Weight (lbs)	FedEx	Carton Size (in)	C/F	Solid \$	Aggregate \$
SSWTK-1	TK03610.XXX	10" D x 36" W	21	✓	37 x 12 x 4	1.0	499	560

Note: Window sill applications up to 36" W and 10" D. For larger windows, multiple kits may be required.

Includes: One horizontal Swanstone sill panel and two vertical Swanstone jamb panels.

Standard Colors: White (010), Bone (037), Bisque (018).

Aggregate Colors: See color listing for details.

Packaging: Individual carton.

INSTALLATION KITS SS-29 and SS-72

Model	Part	Weight (lbs)	FedEx	Carton Size (in)	C/F	Solid \$	Aggregate \$
SS-29*	SS29000.XXX	5	✓	14 x 13 x 4	0.4	162	162
SS-72**	SS72000.XXX	2	✓	10 x 5 x 3	0.1	77	77

Standard Colors: White (010), Bone (037), Bisque (018).

Aggregate Colors: See color listing for details.

***Includes:** Four tubes of clear silicone and one tube of color-coordinated silicone to mount wall panels. One kit per tub wall panel system.

****Includes:** One tube of clear silicone and one tube of color-coordinated silicone to attach a single panel to any properly prepared surface. For multiple panel application, more than one kit will be required. One kit per panel.

FINISHING SILICONE CAULK SI-1003

Model	Part	Dimensions (in)	FedEx	Color-Coordinated \$
SI-1003	SI01003.XXX	10.3 oz. Silicone Adhesive	✓	37

SWANSTONE

BATH ACCESSORIES

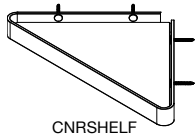

SWAN CORNER SHELVES CNRSHELF.001, CNRSHELF.002

Model	Part	Color	Dimensions (in)	Weight (lbs)	FedEx	Carton Size (in)	C/F	List \$
CNRSHELF	CNRSHELF.001	White Metal And Glass	1- $\frac{1}{8}$ H x 9- $\frac{5}{8}$ W x 9- $\frac{5}{8}$ D	2	✓	1.6 x 7.3 x 16.2	0.11	217
CNRSHELF	CNRSHELF.002	Black Metal And Glass	1- $\frac{1}{8}$ H x 9- $\frac{5}{8}$ W x 9- $\frac{5}{8}$ D	2	✓	1.6 x 7.3 x 16.2	0.11	217

Includes: One shelf and mounting hardware.

Packaging: Individual cartons.

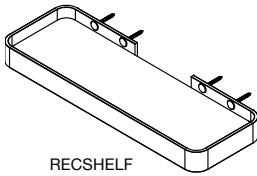

SWAN RECTANGULAR SHELVES RECSHELF.001, RECSHELF.002

Model	Part	Color	Dimensions (in)	Weight (lbs)	FedEx	Carton Size (in)	C/F	List \$
RECSHELF	RECSHELF.001	White Metal And Glass	1- $\frac{1}{8}$ H x 13- $\frac{5}{8}$ W x 4- $\frac{5}{8}$ D	2	✓	1.6 x 5.2 x 14.6	0.11	217
RECSHELF	RECSHELF.002	Black Metal And Glass	1- $\frac{1}{8}$ H x 13- $\frac{5}{8}$ W x 4- $\frac{5}{8}$ D	2	✓	1.6 x 5.2 x 14.6	0.11	217

Includes: One shelf and mounting hardware.

Packaging: Individual cartons.



SWANSTONE

SHOWER PANS

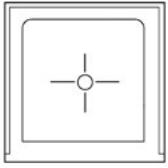

SINGLE TRESHOLD SHOWER PANS

Model	Part	Dimensions (in)	Weight (lbs)	Carton Size (in)	C/F	Solid \$	Aggregate \$
SS-3232	SF03232MD.XXX	32 D x 32 W	30	38 x 37 x 10	8.1	508	712
SS-3248	SF03248MD.XXX	32 D x 48 W	44	54 x 38 x 10	11.9	681	955
SS-3260	SF03260MD.XXX	32 D x 60 W	50	66 x 38 x 10	14.5	886	1239
SS-3660	SF03660MD.XXX	36 D x 60 W	71	66 x 42 x 10	19.0	975	1364
SS-3442	SF03442MD.XXX	34 D x 42 W	40	48 x 40 x 10	11.1	675	909
SS-3448	SF03448MD.XXX	34 D x 48 W	39	55 x 40 x 10	12.7	724	1008
SS-3454	SF03454MD.XXX	34 D x 54 W	53	60 x 40 x 10	13.9	833	1164
SS-3460	SF03460MD.XXX	34 D x 60 W	58	66 x 40 x 10	5.3	896	1256
SS-3636	SF03636MD.XXX	36 D x 36 W	35	42 x 41 x 10	10.0	596	832
SS-4236	SF04236MD.XXX	42 D x 36 W	41	48 x 42 x 10	11.7	668	933
SS-4242	SF04242MD.XXX	42 D x 42 W	51	48 x 48 x 10	13.3	756	1136
SS-4260	SF04260MD.XXX	42 D x 60 W	79	66 x 48 x 10	22.0	1136	1590

Includes: One code-compliant, compression-molded Swanstone pan with molded-in Fit-Flo™ drain. Integral drain, 2" gasket and drain cover. Bases are designed to accommodate 2" cast iron, 2" no-hub and 2" PVC pipe. Drain covers match the shower pan color for white, bisque and bone. All other colors include a stainless steel drain cover

Standard Colors: White (010), Bone (037), Bisque (018).

Aggregate Colors: See color listing for details

Packaging: Individual cartons.

Note: See Swan's Specification Guide for rough-in dimensions reference chart for Swanstone Shower Pans.

RETROFIT SHOWER PANS SR-3260 L/R



Right-side drain



Left-side drain

Model	Part	Dimensions (in)	Weight (lbs)	Carton Size (in)	C/F	Solid \$	Aggregate \$
SR-3260L	SR03260LM.XXX	32 D x 60 W (left drain)	55	67 x 38 x 10	14.7	951	1331
SR-3260R	SR03260RM.XXX	32 D x 60 W (right drain)	55	67 x 38 x 10	14.7	951	1331

Includes: One code-compliant, compression-molded Swanstone pan with molded-in Fit-Flo™ drain. Integral drain, 2" gasket and drain cover. Bases are designed to accommodate 2" cast iron, 2" no-hub and 2" PVC pipe. Drain covers match the shower pan color for white, bisque and bone. All other colors include a stainless steel drain cover.

Standard Colors: White (010), Bone (037), Bisque (018).

Aggregate Colors: See color listing for details

Packaging: Individual cartons.

Note: See Swan's Specification Guide for rough-in dimensions reference chart for Swanstone Shower Pans..

DOUBLE THRESHOLD SHOWER PANS SS-36DTF

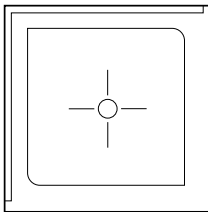

Model	Part	Dimensions (in)	Weight (lbs)	Carton Size (in)	C/F	Solid \$	Aggregate \$
SS-36DTF	SD03636MD.XXX	36 W x 36 H	42	42 x 41 x 10	10.0	725	1016

Includes: Integral drain, 2" gasket and drain cover. Bases are designed to accommodate 2" cast iron, 2" no-hub and 2" PVC pipe. Drain covers match the shower pan color for white, bisque and bone. All other colors include a stainless steel drain cover.

Standard Colors: White (010), Bone (037), Bisque (018).

Aggregate Colors: See color listing for details)

Packaging: Individual cartons.

Note: See Swan's Specification Guide for rough-in dimensions reference chart for Swanstone Shower Pans..

NEO ANGLE SHOWER PANS SS-36NEO AND SS-38NEO

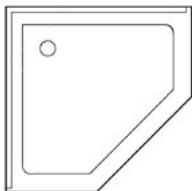

Model	Part	Dimensions (in)	Weight (lbs)	Carton Size (in)	C/F	Solid \$	Aggregate \$
SS-36NEO	SN00036MD.XXX	36 D x 36 W	35	42 x 41 x 10	10.0	611	856
SS-38NEO	SN00038MD.XXX	38 D x 38 W	42	43 x 44 x 10	10.9	692	966

Includes: One code-compliant, compression-molded Swanstone pan with molded-in Fit-Flo™ drain. Integral drain, 2" gasket and drain cover. Bases are designed to accommodate 2" cast iron, 2" no-hub and 2" PVC pipe. Drain covers match the shower pan color for white, bisque and bone. All other colors include a stainless steel drain cover.

Standard Colors: White (010), Bone (037), Bisque (018).

Aggregate Colors: See color listing for details

Packaging: Individual cartons.

Note: See Swan's Specification Guide for rough-in dimensions reference chart for Swanstone Shower Pans.

SWANSTONE

ACCESSIBLE SHOWER PANS AND ACCESSORIES

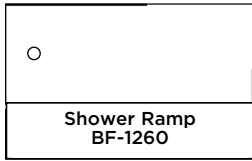

Barrier-Free Shower Pans Available in Right- or Left-Side Drain

SWANSTONE ACCESSIBLE SHOWER PAN FOR RENOVATION SBF-3060L/R

Model	Part	Dimensions (in)	Weight (lbs)	Carton Size (in)	C/F	Solid \$	Aggregate \$
SBF-3060L	SB03060LM.XXX	30 D x 60 W (left side drain)	51	66 x 35 x 10	13.4	1234	1727
SBF-3060R	SB03060RM.XXX	30 D x 60 W (right side drain)	51	66 x 35 x 10	13.4	1234	1727
BF-1260	BF01260.XXX	12 D x 60 W ramp	24	67 x 14 x 2	1.1	601	837

Includes: One compression-molded Swanstone pan with molded-in Fit-Flo™ drain.

Note Shower pan can be used with SK-366072 or SK-366296 to create Barrier-Free Shower System.

Standard Colors: White (010), Bone (037), Bisque (018).

Aggregate Colors: See color listing for details

Packaging: Individual cartons.

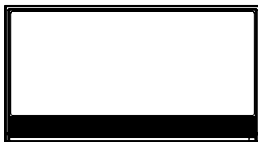

Roll-In Trench Base

SWANSTONE PERFORMIX ROLL-IN TRENCH BASE SBF-3462

Model	Part	Dimensions (in)	Weight (lbs)	Carton Size (in)	C/F	Solid \$	Aggregate \$
SBF-3462	SB03462.XXX	34 D x 63 W	67	69 x 39 x 10	15.18	Quote Only	Quote Only

Includes: One code-approved compression-molded Swanstone trench base.

Note This product meets the dimensional requirements to allow for installation in ADA applications. For up-to-date regulations, visit ADA.gov.

Standard Colors: White (010), Bone (037), Bisque (018).

Aggregate Colors: See color listing for details

Packaging: Individual cartons.

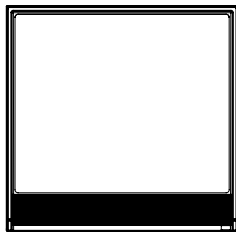

Transfer Trench Base

SWANSTONE PERFORMIX TRANSFER TRENCH BASE STF-3838

Model	Part	Dimensions (in)	Weight (lbs)	Carton Size (in)	C/F	Solid \$	Aggregate \$
STF-3838	ST03838.XXX	38 D x 38 W	50	45 x 43 x 10	12	Quote Only	Quote Only

Includes: One code approved compression-molded Swanstone trench base.

Note This product meets the dimensional requirements to allow for installation in ADA applications. For up-to-date regulations, visit ADA.gov.

Standard Colors: White (010), Bone (037), Bisque (018).

Aggregate Colors: See color listing for details

Packaging: Individual cartons.

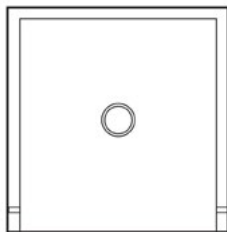

Transfer Base

SWANSTONE TRANSFER SHOWER PAN STS-3738

Model	Part	Dimensions (in)	Weight (lbs)	Carton Size (in)	C/F	Solid \$	Aggregate \$
STS-3738	SF03738MD.XXX	37 D x 38 W	44	44 x 43 x 10	10.9	788	1100

Includes: One code approved compression-molded Swanstone base.

Note Shower pan can be used with SK-364872 (page 8) or SK-364896 (page 8) to create Transfer Shower Enclosure.

Standard Colors: White (010), Bone (037), Bisque (018).

Aggregate Colors: See color listing for details

Packaging: Individual cartons.



SWANSTONE

ACCESSIBLE SHOWER PANS AND ACCESSORIES

SHOWER PAN ACCESSORIES - DRAIN COVERS

Model	Part	Weight (lbs)	FedEx	Carton Size (in)	Color	Price \$
DC-MD*	DC20000ID.010	1	✓	5 x 5 x 3	Plastic - White	21
DC-MD**	DC00000MD.086	1	✓	5 x 5 x 3	Stainless	46
DC-MD	DC00000MD.187	1	✓	5 x 5 x 3	Brushed Nickel	46
DC-MD	DC00000MD.088	1	✓	5 x 5 x 3	Polished Brass	46
DC-MD	DC00000MD.089	1	✓	5 x 5 x 3	Antiqued Bronze	46
DC-MD*	DC20000ID.XXX	1	✓	5 x 5 x 3	Plastic - Bisque, Bone	21

*Includes: Drain covers are included with all Swanstone and Veritek pans in White (010), Bisque (018) and Bone (037).

**Includes: Stainless steel drain covers are included with all Swanstone, except White (010), Bisque (018) and Bone (037).

SHOWER PAN DRAIN KIT TO CONNECT TO STANDARD BATHTUB 1-½" DRAIN PIPING

Model	Part	Weight (lbs)	FedEx	Carton Size (in)	Color	Price \$
DCK-1000	DCK1000.010	3	✓	14 x 14 x 4	White	124

SHOWER PAN DRAIN RUBBER GASKET ADAPTER FOR USE WITH 2" COPPER PIPE

Model	Part	Weight (lbs)	FedEx	Carton Size (in)	Color	Price \$
DD-CC	DD20000CP.000	1	✓	5 x 5 x 3	N/19	17

PVC PIPE WELD CONNECTOR - USE WITH 2" PVC

Model	Part	Weight (lbs)	FedEx	Carton Size (in)	Color	Price \$
PVC-MD	PV00000MD.000	3	✓	5 x 5 x 3	N/A	35

2" STANDARD RUBBER GASKET

Model	Part	Weight (lbs)	FedEx	Carton Size (in)	Color	Price \$
DD-RG	DD50000CP.000	1	✓	5 x 5 x 3	N/A	20

SWANSTONE

VANITY TOPS

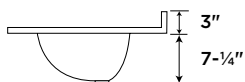
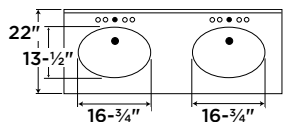
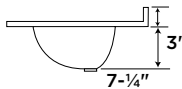
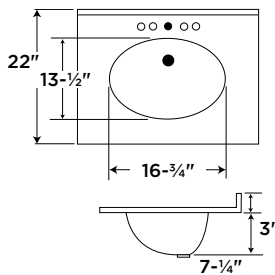
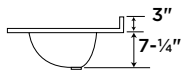
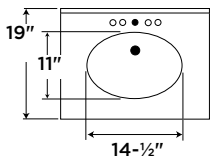
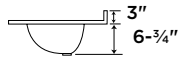
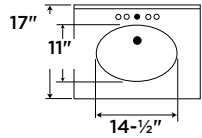

ELLIPSE VANITY TOPS - 17" SINGLE BOWL

Model	Part	Dimensions (in)	Weight (lbs)	FedEx	Carton Size (in)	C/F	Solid \$	Aggregate \$
VT1B1719	VT01719.XXX	17 D x 19 W	17	✓	23 x 21 x 13	3.6	294	397

ELLIPSE VANITY TOPS - 19" SINGLE BOWL

Model	Part	Dimensions (in)	Weight (lbs)	FedEx	Carton Size (in)	C/F	Solid \$	Aggregate \$
VT1B1925	VT01925.XXX	19 D x 25 W	22	✓	30 x 23 x 13	5.2	300	406
VT1B1931	VT01931.XXX	19 D x 31 W	25	✓	35 x 22 x 13	5.8	351	472
VT1B1937	VT01937.XXX	19 D x 37 W	32	✓	41 x 23 x 14	7.6	408	548

Includes: One compression-molded vanity top with overflow integral bowl and backsplash.

Standard Colors: White (010), Bone (037), Bisque (018).

Aggregate Colors: See color listing for details

Packaging: Individual cartons.

Note: This product meets the dimensional requirements to allow for installation in ADA applications when installed to ADA guidelines. For up-to-date regulations, visit ADA.gov.

ELLIPSE VANITY TOPS - 22" SINGLE BOWL

Model	Part	Dimensions (in)	Weight (lbs)	FedEx	Carton Size (in)	C/F	Solid \$	Aggregate \$
VT1B2225	VT02225.XXX	22 D x 25 W	25	✓	29 x 26 x 13	5.7	300	406
VT1B2231	VT02231.XXX	22 D x 31 W	29	✓	35 x 26 x 13	6.8	351	472
VT1B2237	VT02237.XXX	22 D x 37 W	33	✓	41 x 26 x 13	8.0	408	548
VT1B2243	VT02243.XXX	22 D x 43 W	33	✓	47 x 26 x 13	9.2	464	628
VT1B2249	VT02249.XXX	22 D x 49 W	39	**	53 x 25 x 14	10.7	515	696
VC1B2255	VC02255.XXX	22 D x 55 W	56	—	65 x 26 x 13	12.7	584	788
VC1B2261	VC02261.XXX	22 D x 61 W	51	—	65 x 26 x 13	12.7	666	896

Includes: One compression-molded vanity top with overflow integral bowl and backsplash.

Standard Colors: White (010), Bone (037), Bisque (018).

Aggregate Colors: See color listing for details

Packaging: Individual cartons.

Note: This product meets the dimensional requirements to allow for installation in ADA applications when installed to ADA guidelines. For up-to-date regulations, visit ADA.gov.

** If shipped via FedEx Ground, an oversize freight charge will apply.

ELLIPSE VANITY TOPS - 22" DOUBLE BOWL

Model	Part	Dimensions (in)	Weight (lbs)	FedEx	Carton Size (in)	C/F	Solid \$	Aggregate \$
VT2B2261	VT022612B.XXX	22 D x 61 W	49	—	65 x 27 x 14	14.2	753	1016

Includes: One compression-molded vanity top with overflow integral bowl and backsplash.

Standard Colors: White (010), Bone (037), Bisque (018).

Aggregate Colors: See color listing for details

Packaging: Individual cartons.

Note: This product meets the dimensional requirements to allow for installation in ADA applications when installed to ADA guidelines. For up-to-date regulations, visit ADA.gov.



SWANSTONE

VANITY TOPS AND ACCESSORIES

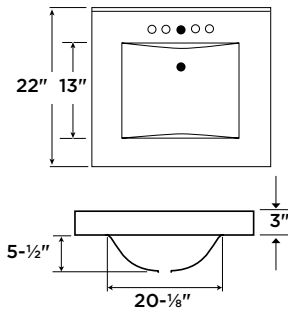

CONTOUR VANITY TOPS - 17" SINGLE BOWL

Model	Part	Dimensions (in)	Weight (lbs)	FedEx	Carton Size (in)	C/F	Solid \$	Aggregate \$
CVIB2225	CV02225.XXX	22 D x 25 W	24	✓	29 x 26 x 13	5.7	367	428
CVIB2231	CV02231.XXX	22 D x 31 W	32	✓	35 x 26 x 13	6.8	429	500
CVIB2237	CV02237.XXX	22 D x 37 W	42	✓	41 x 26 x 13	8.0	494	573
CVIB2243	CV02243.XXX	22 D x 43 W	44	**	47 x 26 x 13	9.2	577	672
CVIB2249	CV02249.XXX	22 D x 49 W	46	**	53 x 26 x 13	10.4	648	760

Includes: One compression-molded vanity top with overflow integral bowl and backsplash.

Standard Colors: White (010), Bone (037), Bisque (018).

Aggregate Colors: See color listing for details

Packaging: Regular carton.

Note: This product meets the dimensional requirements to allow for installation in ADA applications when installed to ADA guidelines. For up-to-date regulations, visit ADA.gov.

**If shipped via FedEx, an oversize freight charge will apply.

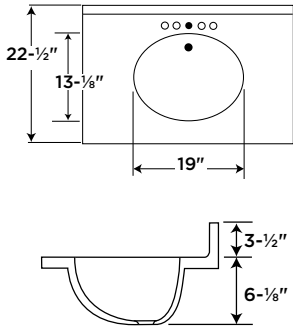

CHESAPEAKE VANITY TOPS - SINGLE BOWL

Model	Part	Dimensions (in)	Weight (lbs)	FedEx	Carton Size (in)	C/F	Solid \$	Aggregate \$
CHIB2225	CH02225.XXX	22-½ D x 25 W	29	✓	29 x 26 x 13	5.7	535	720
CHIB2231	CH02231.XXX	22-½ D x 31 W	34	✓	35 x 26 x 13	6.8	624	839
CHIB2237	CH02237.XXX	22-½ D x 37 W	35	✓	41 x 26 x 13	8.0	725	977
CHIB2243	CH02243.XXX	22-½ D x 43 W	40	✓	47 x 26 x 13	9.2	827	1116
CHIB2249	CH02249.XXX	22-½ D x 49 W	44	**	53 x 26 x 13	10.4	916	1234
CHIB2255	CH02255.XXX	22-½ D x 55 W	52	**	65 x 26 x 13	12.7	1038	1401
CHIB2261	CH02261.XXX	22-½ D x 61 W	59	**	65 x 26 x 13	12.7	1186	1597

CHESAPEAKE VANITY TOPS - DOUBLE BOWL

Model	Part	Dimensions (in)	Weight (lbs)	FedEx	Carton Size (in)	C/F	Solid \$	Aggregate \$
CH2B2261	CH022612B.XXX	22-½ D x 61 W	61	**	65 x 26 x 13	12.7	1340	1805
CH2B2273	CH022732B.XXX	22-½ D x 73 W	65	**	77 x 27 x 13	15.6	1461	1972

Includes: One compression-molded vanity top with overflow integral bowl and backsplash.

Standard Colors: White (010), Bone (037), Bisque (018).

Aggregate Colors: See color listing for details

Packaging: Regular carton.

Note: This product meets the dimensional requirements to allow for installation in ADA applications when installed to ADA guidelines. For up-to-date regulations, visit ADA.gov.

**If shipped via FedEx, an oversize freight charge will apply.

SWANSTONE

VANITY TOPS AND ACCESSORIES

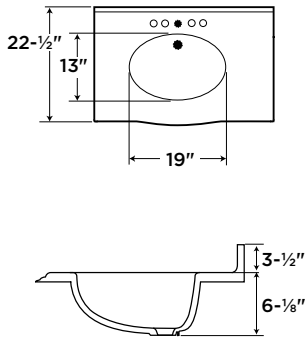

EUROPA VANITY TOPS

Model	Part	Dimensions (in)	Weight (lbs)	FedEx	Carton Size (in)	C/F	Solid \$	Aggregate \$
EVIB2225	EV02225.XXX	22-½ D x 25 W	24	✓	29 x 26 x 13	5.7	367	428
EVIB2231	EV02231.XXX	22-½ D x 31 W	33	✓	35 x 26 x 13	6.8	429	500
EVIB2237	EV02237.XXX	22-½ D x 37 W	39	✓	41 x 26 x 13	8.0	494	573
EVIB2243	EV02243.XXX	22-½ D x 43 W	33	✓	47 x 26 x 13	9.2	577	672
EVIB2249	EV02249.XXX	22-½ D x 49 W	46	**	53 x 26 x 13	10.4	648	760
EVIB2255	EV02255.XXX	22-½ D x 55 W	54	--	65 x 26 x 13	12.7	755	880
EVIB2261	EV02261.XXX	22-½ D x 61 W	57	--	65 x 26 x 13	12.7	837	977

Includes: One compression-molded vanity top with overflow integral bowl and backsplash.

Standard Colors: White (010), Bone (037), Bisque (018).

Aggregate Colors: See color listing for details

Packaging: Regular carton.

Note: This product meets the dimensional requirements to allow for installation in ADA applications when installed to ADA guidelines. For up-to-date regulations, visit ADA.gov.

**If shipped via FedEx, an oversize freight charge will apply.

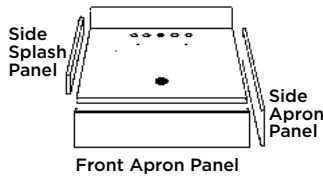

SIDE SPLASH PANEL FOR ELLIPSE AND CONTOUR VANITY TOPS

Model	Part	Dimensions (in)	Weight (lbs)	FedEx	Carton Size (in)	C/F	Solid \$	Aggregate \$
VT18-3SS	VT01803SS.XXX	18 W x 3 H x ¾ D	2	✓	22 x 4 x 2	0.1	68	85
VT19-SS	VT00019SS.XXX	18 W x 3 H x ¾ D	2	✓	22 x 4 x 2	0.1	88	116
VT21-3SS*	VT02103SS.XXX	21 W x 3 H x ¾ D	2	✓	22 x 4 x 2	0.1	69	88
VT22-SS*	VT00022SS.XXX	21 W x 3 H x ¾ D	2	✓	22 x 4 x 2	0.1	88	116

***Note:** Only models VT21-3SS and VT22-SS are available as QuickShip items. Side splashes are universal; no right or left.

Standard Colors: White (010), Bone (037), Bisque (018).

Aggregate Colors: See color listing for details

SIDE SPLASH PANEL FOR CHESAPEAKE

Model	Part	Dimensions (in)	Weight (lbs)	FedEx	Carton Size (in)	C/F	Solid \$	Aggregate \$
CHVTSS	CHVTSS.XXX	21-¾ W x 3-½ H x ¾ D	3	✓	25 x 4 x 2	0.1	102	136

***Note:** Side splashes are universal; no right or left.

SIDE SPLASH PANEL FOR EUROPA

Model	Part	Dimensions (in)	Weight (lbs)	FedEx	Carton Size (in)	C/F	Solid \$	Aggregate \$
EVTSS	EVO0022SS.XXX	21-¼ W x 3-½ H x ¾ D	3	✓	25 x 4 x 2	0.1	95	127

***Note:** Side splashes are universal; no right or left.



SWANSTONE

VANITY BOWLS AND ACCESSORIES

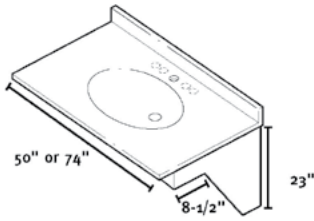

Accessible Vanity Top Finish Kit

FRONT APRON PANEL

Model	Part	Dimensions (in)	Weight (lbs)	FedEx	Carton Size (in)	C/F	Solid \$	Aggregate \$
VT37FA	VT02237FA.XXX	37 W x 8 H x 1/2 D	9	✓	10 x 38 x 2	0.4	169	228
VT55FA	VT02255FA.XXX	55 W x 8 H x 1/2 D	12	✓	56 X 9 X 2	0.6	253	340
VT61FA	VT02261FA.XXX	61 W x 8 H x 1/2 D	14	✓	63 x 9 x 1	0.3	279	376

Standard Colors: White (010), Bone (037), Bisque (018).

Aggregate Colors: See color listing for details

Packaging: Individual cartons.

SIDE APRON PANEL VT22SA

Model	Part	Dimensions (in)	Weight (lbs)	FedEx	Carton Size (in)	C/F	Solid \$	Aggregate \$
VT22SA	VT00022SA.XXX	21 W x 8 H x 1/2 D	5	✓	22 x 9 x 2	0.2	99	132

Standard Colors: White (010), Bone (037), Bisque (018).

Aggregate Colors: See color listing for details

Packaging: Individual cartons.

SWANSTONE ACCESSIBLE VANITY TOP FINISH KIT VTS-50ADA / VTS-74ADA

Model	Part	Dimensions (in)	Weight (lbs)	FedEx	Carton Size (in)	C/F	Solid \$	Aggregate \$
VTS-50ADA	VTS50ADA.XXX	50 W x 23 H x 21-1/2 D	20	✓	52 x 28 x 3	2.5	1382	1865
VTS-74ADA	VTS74ADA.XXX	74 W x 23 H x 21-1/2 D	30	—	76 x 29 x 3	3.8	1382	1865

Includes: Front apron, two side panels and metal clips. This does not include the vanity frame support. Please see installation manual for additional information.

Standard Colors: White (010), Bone (037), Bisque (018).

Aggregate Colors: See color listing for details

Packaging: Regular cartons.

Note: This product meets the dimensional requirements to allow for installation in ADA applications when installed to ADA guidelines. For up-to-date regulations, visit ADA.gov.

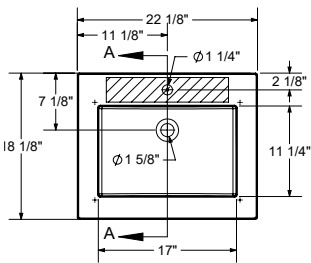

VESSEL SINK WB-2218

Model	Part	Dimensions (in)	Weight (lbs)	FedEx	Carton Size (in)	C/F	Solid \$	Aggregate \$
WB-2218	WB02218	22 1/8" D x 18 1/8" xW	10	✓	27 x 23 x 9	3.04	352	410

Includes: One sink

Standard Colors: White (010), Bone (037), Bisque (018).

Aggregate Colors: See color listing for details

Packaging: Regular carton.

Note: This model not available in Black Galaxy (018) and Charcoal Gray (209).

Color Code Reference Guide (Alphabetical order)

Replace XXX in part number with 3-digit color code.

Note: Some colors available by quote only.

Granite Colors are only available for Granite Kitchen Sinks.

* Kitchen/Utility Sinks only. Flock is only available for specific products.

GRANITE

Opal White (210)
Espresso (170)
Granito (076)
Metallico (173)
Nero (077)

SOLID

White (010)
Bisque (018)
Bone (037)
Flock (033)*

AGGREGATE

Bermuda Sand (040)
Black Galaxy (015)*
Carrara (221)
Concrete Ash Gray (203)
Concrete Birch (226)
Concrete Charcoal Gray (209)
Concrete Clay (212)
Concrete Limestone (218)
Concrete Sandstone (215)
Ice (130)
Tahiti White (011)

SWANSTONE

VANITY BOWLS AND ACCESSORIES

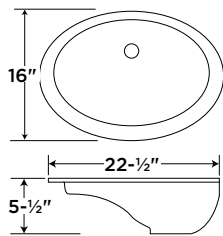
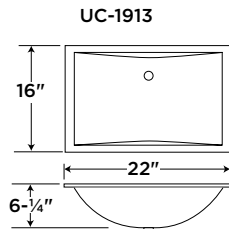
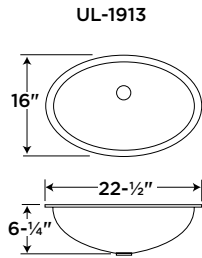
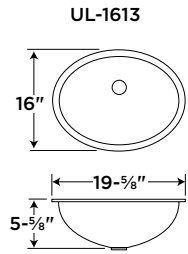

UNDERMOUNT VANITY BOWLS

Model	Part	Dimensions (in)	Weight (lbs)	FedEx	Carton Size (in)	C/F	Solid \$	Aggregate \$
UL-1613	UL01613.XXX	13-1/2 D x 16-1/2 W	11	✓	26 x 21 x 9	2.8	310	331
UL-1913	UL01913.XXX	13 D x 19 W	13	✓	28 x 21 x 9	3.1	344	366
UC-1913	UC01913.XXX	13 D x 19 W	15	✓	28 x 21 x 9	3.1	344	366

Includes: One compression-molded vanity bowl with overflow.

Standard Colors: White (010), Bone (037), Bisque (018).

Aggregate Colors: See color listing for details

Packaging: Regular carton.

Note: This product meets the dimensional requirements to allow for installation in ADA applications when installed to ADA guidelines. For up-to-date regulations, visit ADA.gov.

ACCESSIBLE VANITY BOWL

Model	Part	Dimensions (in)	Weight (lbs)	FedEx	Carton Size (in)	C/F	Solid \$	Aggregate \$
ULAD-1913	ULAD01913.XXX	13 D x 19 W	14	✓	26 x 21 x 9	2.8	344	366

Includes: One compression-molded vanity bowl with overflow.

Standard Colors: White (010), Bone (037), Bisque (018).

Aggregate Colors: See color listing for details

Packaging: Regular carton.

Note: This product meets the dimensional requirements to allow for installation in ADA applications when installed to ADA guidelines. For up-to-date regulations, visit ADA.gov.

 Universal Design

Color Code Reference Guide (Alphabetical order)

	GRANITE	SOLID	AGGREGATE
Replace XXX in part number with 3-digit color code.	Opal White (210)	White (010)	Bermuda Sand (040)
Note: Some colors available by quote only.	Espresso (170)	Bisque (018)	Black Galaxy (015)*
Granite Colors are only available for Granite Kitchen Sinks.	Granito (076)	Bone (037)	Carrara (221)
	Metallico (173)	Flock (033)*	Concrete Ash Gray (203)
* Kitchen/Utility Sinks only. Flock is only available for specific products.	Nero (077)		Concrete Birch (226)
			Concrete Charcoal Gray (209)
			Concrete Clay (212)
			Concrete Limestone (218)
			Concrete Sandstone (215)
			Ice (130)
			Tahiti White (011)



VERITEK®

BATH WALL KITS

TF-57

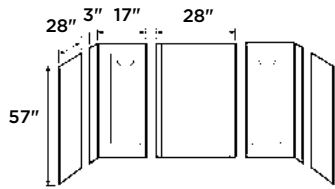

Model	Part	Dimensions (in)	Weight (lbs)	Carton Size (in)	C/F	White \$	Bone / Bisque \$
TF-57	TF57000.XXX	See illustration	51	61 x 31 x 5	5.5	781	837

Fits tub areas: 28" to 30" D, 58" to 60" W; 57" H. Extension kit not available.

Includes: One back panel, two corner panels with four molded-in soap shelves, and two side panels.

Standard Colors: White (010), Bisque (018), and Bone (037).

Packaging: Flat, rectangular carton.

GN-58

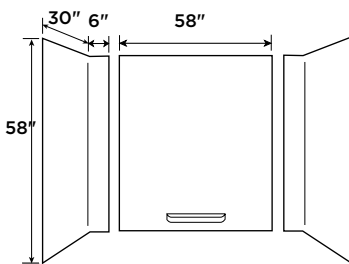

Model	Part	Dimensions (in)	Weight (lbs)	Carton Size (in)	C/F	White \$	Bone / Bisque \$
GN-58	GN58000.XXX	See illustration	73	62 x 54 x 8	15.5	1110	1162

Fits tub areas: 30" D x 60" W or smaller; 58" H. Lower soap dish placement allows for installation of grab bars.

Includes: One back panel with molded-in soap dish, and two side panels.

Standard Colors: White (010), Bisque (018), and Bone (037).

Packaging: Flat, rectangular carton.

Note: Meets ADA guidelines for soap shelf height and grab bar installation when installed to ADA guidelines. For up-to-date regulations, visit ADA.gov.

TI-7260

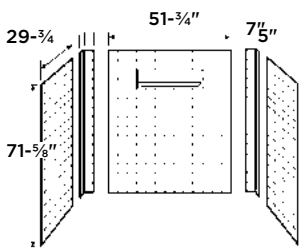

Model	Part	Dimensions (in)	Weight (lbs)	Carton Size (in)	C/F	White \$	Bone / Bisque \$
TI-7260	TI07260.XXX	See illustration	103	76 x 57 x 7	17.5	2047	2199

Fits tub areas: 31" to 36" D x 53-1/4" to 64-3/4" W. This is a five-piece shower wall panel system.

Includes: One back panel with molded-in soap dish, two corner panels, and two side panels.

Standard Colors: White (010), Bisque (018), and Bone (037).

Packaging: Flat, rectangular carton.

TI-3

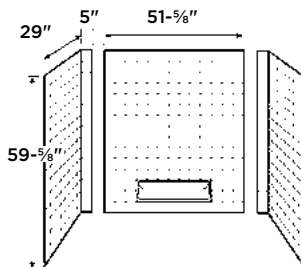

Model	Part	Dimensions (in)	Weight (lbs)	Carton Size (in)	C/F	White \$	Bone / Bisque \$
TI-3	TI30000.XXX	See illustration	75	64 x 58 x 7	15.0	1310	1406

Fits tub areas: 29" to 30" D; 53" to 60" W; 59-5/8" H.

Includes: One back panel with molded-in soap dish, and two side panels.

Standard Colors: White (010), Bisque (018), and Bone (037).

Packaging: Flat, rectangular carton.

VERITEK®

BATH WALL KITS

TI-5

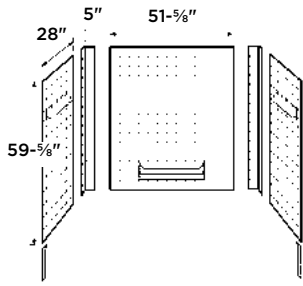

Model	Part	Dimensions (in)	Weight (lbs)	Carton Size (in)	C/F	White \$	Bone / Bisque \$
TI-5	TI50000.XXX	See illustration	87	64 x 58 x 7	15.0	1440	1550

Fits tub areas: 29" to 32" D; 53" to 60" W; 59-5/8" H.

Includes: One back panel with molded-in soap dish, two corner panels, two side panels with molded-in convenience shelves, and two side panels.

Standard Colors: White (010), Bisque (018), and Bone (037).

Packaging: Flat, rectangular carton.

Universal Design



VERITEK®

ALCOVE WALL KITS AND BATHTUB

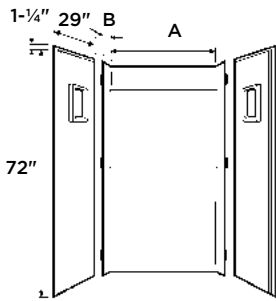

Back Panel Dimensions

	A	B
SA-3232	32"	3"
SA-3448	48"	5"
SA-3636	36"	7"

VERITEK® SHOWER ALCOVE WALL KIT SA-3232

Model	Part	Dimensions (in)	Weight (lbs)	Carton Size (in)	C/F	White \$	Bone / Bisque \$
SA-3232	SA03232.XXX	32 D x 32 W x 72 H	100	80 x 36 x 10	16.7	969	1014

Fits shower pan size: 32" D x 32" W

VERITEK® SHOWER ALCOVE WALL KIT SA-3448

Model	Part	Dimensions (in)	Weight (lbs)	Carton Size (in)	C/F	White \$	Bone / Bisque \$
SA-3448	SA03448.XXX	34 D x 48 W x 72 H	129	80 x 51 x 11	26.0	1163	1217

Fits shower pan size: 34" D x 48" W

VERITEK® SHOWER ALCOVE WALL KIT SA-3636

Model	Part	Dimensions (in)	Weight (lbs)	Carton Size (in)	C/F	White \$	Bone / Bisque \$
SA-3636	SA03636.XXX	36 D x 36 W x 72 H	106	80 x 40 x 10	18.5	1084	1138

Fits shower pan size: 36" D x 36" W

Includes: One right side panel, one left side panel, one back panel with six factory installed wall mounting clips.

Standard Colors: White (010), Bisque (018), and Bone (037).

Packaging: Flat, rectangular carton.

Note: Additional wall space required to accommodate nailing flange. See installation instructions at Swanstone.com

The SA series is a compression-molded material with molded-in color and a natural gloss surface..

VERITEK® BATHTUB ALCOVE WALL KIT BA-3060

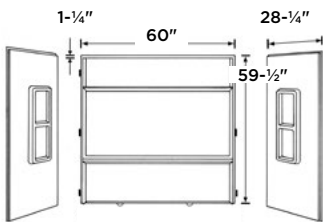

Model	Part	Dimensions (in)	Weight (lbs)	Carton Size (in)	C/F	White \$	Bone / Bisque \$
BA-3060	BA03060.XXX	30 D x 60 W x 59-1/2 H	98	67 x 64 x 7	17.4	858	898

Fits tub areas: 30" D x 60" W x 59-1/2" H. It is a compression-molded material with molded-in color and a natural gloss surface.

Includes: One right side panel, one left side panel, one back panel with six factory installed wall mounting clips

Standard Colors: White (010), Bisque (018), and Bone (037).

Packaging: Flat, rectangular carton.

Note: Additional wall space required to accommodate nailing flange. See installation instructions.

VERITEK® L/R BATHTUB BT-3060L/R

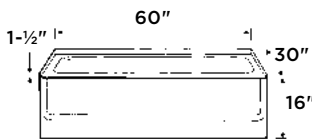

Right or left option

Model	Part	Dimensions (in)	Weight (lbs)	Carton Size (in)	C/F	White \$	Bone / Bisque \$
BT-3060L/R	BT03060 LD/RD.XXX	30 D x 60 W	73	62 x 33 x 20	23.7	611	640

Fits tub areas: 30" D and 60" W. It is a compression-molded material with molded-in color and a natural gloss surface.

Includes: One bathtub with six bathtub clips.

Standard Colors: White (010), Bisque (018), and Bone (037).

Packaging: Flat, rectangular carton.

Color Code Reference Guide (Alphabetical order)

Replace XXX in part number with 3-digit color code.

Note: Some colors available by quote only.

Granite Colors are only available for Granite Kitchen Sinks.

* Kitchen/Utility Sinks only. Flock is only available for specific products.

GRANITE

Opal White (210)
Espresso (170)
Granito (076)
Metallico (173)
Nero (077)

SOLID

White (010)
Bisque (018)
Bone (037)
Flock (033)*

AGGREGATE

Bermuda Sand (040)
Black Galaxy (015)*
Carrara (221)
Concrete Ash Gray (203)
Concrete Birch (226)
Concrete Charcoal Gray (209)
Concrete Clay (212)
Concrete Limestone (218)
Concrete Sandstone (215)
Ice (130)
Tahiti White (011)

VERITEK®

SHOWER PANS

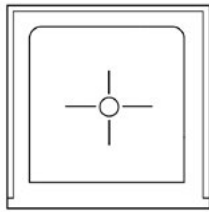

Center drain

SINGLE THRESHOLD SHOWER PANS

Model	Part	Dimensions (in)	Weight (lbs)	Carton Size (in)	C/F	White \$	Bone / Bisque \$
R-3232	FF03232MD.XXX	32 D x 32 W	30	38 x 37 x 10	8.1	331	360
R-3248	FF03248MD.XXX	32 D x 48 W	44	54 x 38 x 10	11.9	473	519
R-3260	FF03260MD.XXX	32 D x 60 W	50	66 x 38 x 10	14.5	573	629
R-3442	FF03442MD.XXX	34 D x 42 W	40	48 x 40 x 10	11.1	438	482
R-3448	FF03448MD.XXX	34 D x 48 W	39	55 x 40 x 10	12.7	486	534
R-3454	FF03454MD.XXX	34 D x 54 W	55	60 x 40 x 10	13.9	538	589
R-3460	FF03460MD.XXX	34 D x 60 W	58	66 x 40 x 10	15.3	581	639
R-3636	FF03636MD.XXX	36 D x 36 W	35	42 x 41 x 10	10.0	369	408
R-3660	FF03660MD.XXX	36 D x 60 W	71	66 x 42 x 10	19.0	637	701
R-4236	FF04236MD.XXX	42 D x 36 W	41	48 x 42 x 10	11.7	433	475
R-4242	FF04242MD.XXX	42 D x 42 W	51	48 x 48 x 10	13.3	502	554
R-4260	FF04260MD.XXX	42 D x 60 W	79	66 x 48 x 10	22.0	743	816

Includes: One code-compliant compression-molded Veritek® shower pan with molded-in Fit-Flo™ drain.

Accommodates: 2" cast iron, 2" no-hub and 2" PVC pipe.

Standard Colors: White (010), Bisque (018), and Bone (037).

Packaging: Individual carton.



Right-side drain

RETROFIT SHOWER PANS FR-3260L/R

Model	Part	Dimensions (in)	Weight (lbs)	Carton Size (in)	C/F	White \$	Bone / Bisque \$
FR-3260L	FR03260LM.XXX	32 D x 60 W	55	67 x 38 x 10	14.7	568	624
FR-3260R	FR03260RM.XXX	32 D x 60 W	55	67 x 38 x 10	14.7	568	624

Includes: One code-compliant compression-molded Veritek® shower pan with molded-in Fit-Flo™ drain.

Accommodates: 2" cast iron, 2" no-hub and 2" PVC pipe.

Standard Colors: White (010), Bisque (018), and Bone (037).

Packaging: Individual carton.



Left-side drain

Color Code Reference Guide (Alphabetical order)

Replace XXX in part number with 3-digit color code.

Note: Some colors available by quote only.

Granite Colors are only available for Granite Kitchen Sinks.

* Kitchen/Utility Sinks only. Flock is only available for specific products.

GRANITE	SOLID	AGGREGATE
Opal White (210)	White (010)	Bermuda Sand (040)
Espresso (170)	Bisque (018)	Black Galaxy (015)*
Granito (076)	Bone (037)	Carrara (221)
Metallico (173)	Flock (033)*	Concrete Ash Gray (203)
Nero (077)		Concrete Birch (226)
		Concrete Charcoal Gray (209)
		Concrete Clay (212)
		Concrete Limestone (218)
		Concrete Sandstone (215)
		Ice (130)
		Tahiti White (011)



VERITEK®

SHOWER PANS

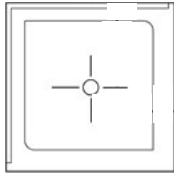

Center drain

DOUBLE THRESHOLD SHOWER PANS R-36DTF

Model	Part	Dimensions (in)	Weight (lbs)	Carton Size (in)	C/F	White \$	Bone / Bisque \$
R-36DTF	FD03636MD.XXX	36 D x 36 W	42	41 x 41 x 10	9.7	480	526

Includes: One code-compliant compression-molded Veritek® shower pan with molded-in Fit-Flo™ drain.

Accommodates: 2" cast iron, 2" no-hub and 2" PVC pipe.

Standard Colors: White (010), Bisque (018), and Bone (037).

Packaging: Individual carton.

NEO ANGLE SHOWER PANS R-36NEO AND R-38NEO

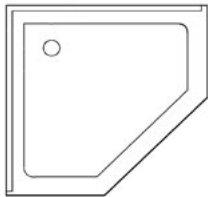

Model	Part	Dimensions (in)	Weight (lbs)	Carton Size (in)	C/F	White \$	Bone / Bisque \$
R-36NEO	FN00036MD.XXX	36 D x 36 W	40	42 x 42 x 10	11	396	437
R-38NEO	FN00038MD.XXX	38 D x 38 W	42	44 x 43 x 10	11	446	492

Includes: One code-compliant compression-molded Veritek® shower pan with molded-in Fit-Flo™ drain.

Accommodates: 2" cast iron, 2" no-hub and 2" PVC pipe.

Standard Colors: White (010), Bisque (018), and Bone (037).

Packaging: Individual carton.

Note: See Swan's Specification Guide for rough-in dimensions reference chart for Veritek® Shower Pans.

Color Code Reference Guide (Alphabetical order)

Replace XXX in part number with 3-digit color code.

Note: Some colors available by quote only.

Granite Colors are only available for Granite Kitchen Sinks.

* Kitchen/Utility Sinks only. Flock is only available for specific products.

GRANITE

Opal White (210)
Espresso (170)
Granito (076)
Metallico (173)
Nero (077)

SOLID

White (010)
Bisque (018)
Bone (037)
Flock (033)*

AGGREGATE

Bermuda Sand (040)
Black Galaxy (015)*
Carrara (221)
Concrete Ash Gray (203)
Concrete Birch (226)
Concrete Charcoal Gray (209)
Concrete Clay (212)
Concrete Limestone (218)
Concrete Sandstone (215)
Ice (130)
Tahiti White (011)

VERITEK®

ACCESSIBLE SHOWER PANS AND ACCESSORIES

VERITEK® ACCESSIBLE SHOWER PAN FOR RENOVATION FBF-3060L/R AND FBF-1260

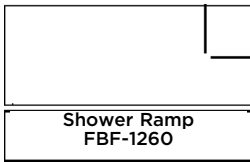

Left or Right Drain

Model	Part	Dimensions (in)	Weight (lbs)	Carton Size (in)	C/F	White \$	Bone / Bisque \$
FBF-3060LM	FB03060LM.XXX	30 D x 60 W left drain	58	66 x 36 x 10	13.8	1141	1256
FBF-3060RM	FB03060RM.XXX	30 D x 60 W right drain	58	66 x 36 x 10	13.8	1141	1265
FB-1260	FB01260.XXX	12 D x 60 W ramp	23	67 x 13 x 2	1.0	556	556

Includes: One code-compliant compression-molded Veritek® shower pan with molded-in Fit-Flo™ drain.

Note: Shower pan can be used with SK-366072 or SK-366296 to create Barrier-Free Shower System.

Standard Colors: White (010), Bisque (018), and Bone (037).

Packaging: Individual carton.

VERITEK® PERFORMIX ROLL-IN TRENCH BASE FBF-3462

Barrier-Free Shower Pans Available in Right- or Left-Side Drain



Roll-in Trench Base

Model	Part	Dimensions (in)	Weight (lbs)	Carton Size (in)	C/F	White \$	Bone / Bisque \$
FBF-3462	FB03462.XXX	34 D x 62 W	67	69 x 39 x 10	15.18	Quote	Quote

Includes: One code-compliant Veritek® trench base.

Standard Colors: White (010), Bisque (018), and Bone (037).

Packaging: Rectangular carton.

Note: Shower floor can be used with SK-366296 and CM-2096 to create 96" Barrier-Free

Shower Wall System. This product meets dimensional requirements to allow installation in ADA applications for new construction. For up-to-date regulations, visit ADA.gov.

VERITEK® PERFORMIX TRANSFER TRENCH BASE FTF-3838

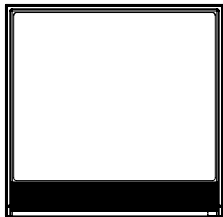

Transfer Trench Base

Model	Part	Dimensions (in)	Weight (lbs)	Carton Size (in)	C/F	White \$	Bone / Bisque \$
FTF-3838	FF03838MD.XXX	38 D x 38 W	50	45 x 43 x 10	12	Quote	Quote

Includes: One code-compliant Veritek® trench base.

Standard Colors: White (010), Bisque (018), and Bone (037).

Packaging: Rectangular carton.

Note: This product meets the dimensional requirements to allow for installation in ADA applications when installed to ADA guidelines. For up-to-date regulations, visit ADA.gov.

Color Code Reference Guide (Alphabetical order)

Replace XXX in part number with 3-digit color code.

Note: Some colors available by quote only.

Granite Colors are only available for Granite Kitchen Sinks.

* Kitchen/Utility Sinks only. Flock is only available for specific products.

GRANITE

Opal White (210)
Espresso (170)
Granito (076)
Metallico (173)
Nero (077)

SOLID

White (010)
Bisque (018)
Bone (037)
Flock (033)*

AGGREGATE

Bermuda Sand (040)
Black Galaxy (015)*
Carrara (221)
Concrete Ash Gray (203)
Concrete Birch (226)
Concrete Charcoal Gray (209)
Concrete Clay (212)
Concrete Limestone (218)
Concrete Sandstone (215)
Ice (130)
Tahiti White (011)



VERITEK®

ACCESSIBLE SHOWER PANS AND ACCESSORIES

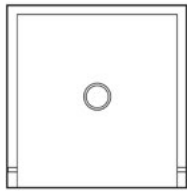

Transfer Base
Center Drain

VERITEK® TRANSFER SHOWER PAN FTS-3738

Model	Part	Dimensions (in)	Weight (lbs)	Carton Size (in)	C/F	White \$	Bone / Bisque \$
FTS-3738	FF03738MD.XXX	37 D x 38 W	44	44 x 43 x 10	10.9	526	581

Includes: One code-compliant compression-molded Veritek® shower pan with molded-in Fit-Flo™ drain.

Standard Colors: White (010), Bisque (018), and Bone (037).

Packaging: Rectangular carton.

SHOWER PAN ACCESSORIES - DRAIN COVERS

Model	Part	Weight (lbs)	FedEx	Carton Size (in)	C/F	Color \$
DC-MD*	DC20000ID.010	1	✓	5 x 5 x 3	Plastic - White	21
DC-MD**	DC00000MD.086	1	✓	5 x 5 x 3	Stainless	46
DC-MD	DC00000MD.187	1	✓	5 x 5 x 3	Brushed Nickel	46
DC-MD	DC00000MD.088	1	✓	5 x 5 x 3	Polished Brass	46
DC-MD	DC00000MD.089	1	✓	5 x 5 x 3	Antiqued Bronze	46
DC-MD*	DC20000ID.XXX	1	✓	5 x 5 x 3	Plastic - Bisque, Bone,	21

*Includes: Drain covers are included with all Swanstone and Veritek pans in White (010), Bisque (018) and Bone (037)

**Includes: Stainless steel drain covers are included with all Swanstone, except White (010), Bisque (018) and Bone (037)

SHOWER PAN DRAIN KIT TO CONNECT TO STANDARD BATHTUB 1-1/2" DRAIN PIPING

Model	Part	Weight (lbs)	FedEx	Carton Size (in)	C/F	Color \$
DCK-1000	DCK1000.010	3	✓	14 x 14 x 4	White	124

SHOWER PAN DRAIN RUBBER GASKET ADAPTER FOR USE WITH 2" COPPER PIPE

Model	Part	Weight (lbs)	FedEx	Carton Size (in)	C/F	Color \$
DD-CC	DD20000CP.000	1	✓	5 x 5 x 3	—	17

PVC PIPE WELD CONNECTOR - USE WITH 2" PVC

Model	Part	Weight (lbs)	FedEx	Carton Size (in)	C/F	Color \$
PVC-MD	PV00000MD.000	1	✓	5 x 5 x 3	—	35

2" STANDARD RUBBER GASKET

Model	Part	Weight (lbs)	FedEx	Carton Size (in)	C/F	Color \$
DD-RG	DD50000CP.000	1	✓	5 x 5 x 3	—	20

ACCESSIBLE

BATH ACCESSORIES

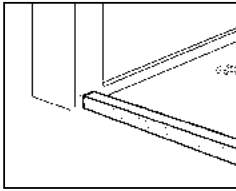

ALUMINUM REMOVABLE THRESHOLD BF-6000

Model	Part	Dimensions (in)	Weight (lbs)	FedEx	Carton Size (in)	C/F	Colors	Price \$
BF-6000	BF60000.010	2-1/2 D x 60 W x 2-1/4 H	5	✓	61 x 3 x 3	0.32	—	666

BARRIER-FREE THRESHOLD BF-FT

Model	Part	Dimensions (in)	Weight (lbs)	FedEx	Carton Size (in)	C/F	Colors	Price \$
BF-FT	BF60000FT.000	Vinyl Strip 1-1/4 x 1; Alum. Ext. 3/4	4	✓	61 x 3 x 3	0.3	—	165

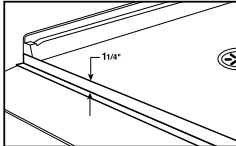

BARRIER-FREE COLLAPSIBLE SILICONE THRESHOLD BF-CT

Model	Part	Dimensions (in)	Weight (lbs)	FedEx	Carton Size (in)	C/F	Colors	Price \$
BF-CT	BF60000CT.000	1 D x 67 W x 1 H	2	✓	19 x 15 x 3	0.5	—	93

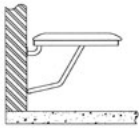

FOLDING SHOWER SEAT RIGHT- OR LEFT-SIDE WALL INSTALLATION BF-2300L/R

Model	Part	Dimensions (in)	Weight (lbs)	FedEx	Carton Size (in)	C/F	Colors	Price \$
BF-2300L	BF00023LH.000	23-1/2 W x 21 D	18	✓	34 x 27 x 6	3.2	White	1368
BF-2300R	BF00023RH.000	23-1/2 W x 21 D	18	✓	34 x 27 x 6	3.2	White	1368

Note: Mounting materials not included

L-SHAPED STAINLESS STEEL GRAB BAR BF-2448



Model	Part	Dimensions (in)	Weight (lbs)	FedEx	Carton Size (in)	C/F	Colors	Price \$
BF-2448	BF02448.000	24 W x 48 D	8	✓	51 x 26 x 4	3.1	—	496

Note: For use when shower seat is installed on side

STRAIGHT STAINLESS STEEL GRAB BAR BF-5024



Model	Part	Dimensions (in)	Weight (lbs)	FedEx	Carton Size (in)	C/F	Colors	Price \$
BF-5024	BF05024.000	24	4	✓	37 x 12 x 4	1.0	—	161

Note: For use when shower seat is installed on back wall.

STAINLESS STEEL GRAB BAR KIT BF-5072

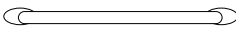

Model	Part	Dimensions (in)	Weight (lbs)	FedEx	Carton Size (in)	C/F	Colors	Price \$
BF-5072	BF05072.000	Includes 24" and 48" bars	8	✓	51 x 8 x 5	.94	—	368

Note: For use when shower seat is installed on back wall.

L-SHAPED STAINLESS STEEL GRAB BAR KIT GB-1432

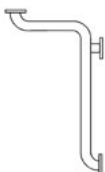

Model	Part	Dimensions (in)	Weight (lbs)	FedEx	Carton Size (in)	C/F	Colors	Price \$
GB-1432	GB01432.000	14 W x 32 D	5	✓	37 x 17 x 5	1.8	—	406

Note: For use when shower seat is installed on side



VERITEK® PRO

TUB SHOWERS

CLASSIC TUB SHOWERS

Model	Part	Weight (lbs)	FedEx	Carton Size (in)	Color	Price \$
VP6030CTS	VP6030CTSL/R.XXX	130	✓	Tub: 62 1/2 x 34 x 17 3/4 Back Wall: 65 x 61 1/2 x 8 1/2 Side Wall Set: 64 x 26 1/2 x 5 1/4	White	1050
VP6030CTSA	VP6030CTSAL/R.XXX	160	✓	Tub: 62 1/2 x 34 x 17 3/4 Back Wall: 65 x 61 1/2 x 8 1/2 Side Wall Set: 64 x 26 1/2 x 5 1/4	White	1271
VP6030CTS2	VP6030CTS2L/R.XXX	130	✓	Tub: 62 1/2 x 34 x 17 3/4 Back Wall: 65 x 61 1/2 x 8 1/2 Side Wall Set: 64 x 26 1/2 x 5 1/4	White	1050
VP6030CTS2A	VP6030CTS2AL/R.XXX	160	✓	Tub: 62 1/2 x 34 x 17 3/4 Back Wall: 65 x 61 1/2 x 8 1/2 Side Wall Set: 64 x 26 1/2 x 5 1/4	White	1271
VP6030CTSM	VP6030CTSML/R.XXX	130	✓	Tub: 62 1/2 x 34 x 21 1/4 Back Wall: 65 x 61 1/2 x 8 1/2 Side Wall Set: 64 x 26 1/2 x 5 1/4	White	1098
VP6030CTSM A	VP6030CTSMAL/R.XXX	160	✓	Tub: 62 1/2 x 34 x 21 1/4 Back Wall: 65 x 61 1/2 x 8 1/2 Side Wall Set: 64 x 26 1/2 x 5 1/4	White	1319
VP6030CTSM2	VP6030CTSM2L/R.XXX	130		Tub: 62 1/2 x 34 x 21 1/4 Back Wall: 65 x 61 1/2 x 8 1/2 Side Wall Set: 64 x 26 1/2 x 5 1/4	White	1098
VP6030CTSM2A	VP6030CTSM2AL/R.XXX	160		Tub: 62 1/2 x 34 x 21 1/4 Back Wall: 65 x 61 1/2 x 8 1/2 Side Wall Set: 64 x 26 1/2 x 5 1/4	White	1319
VP6036CTS	VP6036CTSL/R.XXX	130		Tub: 63 x 40 1/2 x 21 Back Wall: 65 x 61 1/2 x 8 1/2 Side Wall Set: 64 1/4 x 32 1/2 x 5	White	1622
VP6036CTSA	VP6036CTSAL/R.XXX	160		Tub: 63 x 40 1/2 x 21 Back Wall: 65 x 61 1/2 x 8 1/2 Side Wall Set: 64 1/4 x 32 1/2 x 5	White	1877
VP6036CTS2	VP6036CTS2L/R.XXX	158		Tub: 63 x 40 1/2 x 21 Back Wall: 65 x 61 1/2 x 8 1/2 Side Wall Set: 64 1/4 x 32 1/2 x 5	White	1622
VP6036CTS2A	VP6036CTS2AL/R.XXX	188		Tub: 63 x 40 1/2 x 21 Back Wall: 65 x 61 1/2 x 8 1/2 Side Wall Set: 64 1/4 x 32 1/2 x 5	White	1877
VP6036CTSM	VP6036CTSML/R.XXX	158		Tub: 63 x 40 1/2 x 24 1/2 Back Wall: 65 x 61 1/2 x 8 1/2 Side Wall Set: 64 1/4 x 32 1/4 x 5	White	1665
VP6036CTSM A	VP6036CTSMAL/R.XXX	188		Tub: 63 x 40 1/2 x 24 1/2 Back Wall: 65 x 61 1/2 x 8 1/2 Side Wall Set: 64 1/4 x 32 1/4 x 5	White	1920
VP6036CTSM2	VP6036CTSM2L/R.XXX	158		Tub: 63 x 40 1/2 x 24 1/2 Back Wall: 65 x 61 1/2 x 8 1/2 Side Wall Set: 64 1/4 x 32 1/4 x 5	White	1665
VP6036CTSM2A	VP6036CTSM2AL/R.XXX	188		Tub: 63 x 40 1/2 x 24 1/2 Back Wall: 65 x 61 1/2 x 8 1/2 Side Wall Set: 64 1/4 x 32 1/4 x 5	White	1920
VP6042CTS	VP6042CTSL/R.XXX	172		Tub: 63 x 47 x 21 1/2 Back Wall: 65 x 61 1/2 x 8 1/2 Side Wall Set: 64 1/4 x 38 1/2 x 5	White	1703

VERITEK® PRO

TUB SHOWERS

CLASSIC TUB SHOWERS

Model	Part	Weight (lbs)	FedEx	Carton Size (in)	Color	Price \$
VP6042CTSA	VP6042CTSAL/R.XXX	202	✓	Tub: 63 x 47 x 21 1/2 Back Wall: 65 x 61 1/2 x 8 1/2 Side Wall Set: 64 1/4 x 38 1/2 x 5	White	1959
VP6042CTS2	VP6042CTS2L/R.XXX	172	✓	Tub: 63 x 47 x 21 1/2 Back Wall: 65 x 61 1/2 x 8 1/2 Side Wall Set: 64 1/4 x 38 1/2 x 5	White	1703
VP6042CTS2A	VP6042CTS2AL/R.XXX	202	✓	Tub: 63 x 47 x 21 1/2 Back Wall: 65 x 61 1/2 x 8 1/2 Side Wall Set: 64 1/4 x 38 1/2 x 5	White	1959
VP6042CTSM	VP6042CTSML/R.XXX	172	✓	Tub: 63 x 47 x 24 1/2 Back Wall: 65 x 61 1/2 x 8 1/2 Side Wall Set: 64 1/4 x 38 1/2 x 5	White	1750
VP6042CTSMA	VP6042CTSMAL/R.XXX	202	✓	Tub: 63 x 47 x 24 1/2 Back Wall: 65 x 61 1/2 x 8 1/2 Side Wall Set: 64 1/4 x 38 1/2 x 5	White	2006
VP6042CTSM2	VP6042CTSM2L/R.XXX	172	✓	Tub: 63 x 47 x 24 1/2 Back Wall: 65 x 61 1/2 x 8 1/2 Side Wall Set: 64 1/4 x 38 1/2 x 5	White	1750
VP6042CTSM2A	VP6042CTSM2AL/R.XXX	202	✓	Tub: 63 x 47 x 24 1/2 Back Wall: 65 x 61 1/2 x 8 1/2 Side Wall Set: 64 1/4 x 38 1/2 x 5	White	2006

Description: Modern, matte finish multipiece tub shower kit. Slip resistant, textured bottom with left or right drain.

Includes: One bathtub, one back wall, and two side walls.

Standard Colors: White (010)

Packaging: Rectangular cartons.

ACCESSIBLE TUB SHOWERS

Model	Part	Weight (lbs)	FedEx	Carton Size (in)	Color	Price \$
VPF6030CTS2	VPF6030CTS2L/R.XXX	120	✓	Tub: 62 1/2 x 34 x 17 3/4 Back Wall: 65 x 61 1/2 x 8 1/2 Side Wall Set: 64 x 26 1/2 x 10 1/2	White	2959
VPF6030CTSMN2	VPF6030CTSMN2L/R.XXX	120	✓	Tub: 62 1/2 x 34 x 7 3/4 Back Wall: 65 x 61 1/2 x 8 1/2 Side Wall Set: 64 x 26 1/2 x 10 1/2	White	3164
VPF6032CTSMN2	VPF6032CTSMN2L/R.XXX	123	✓	Tub: 63 x 36 1/2 x 21 Back Wall: 65 x 61 1/2 x 8 1/2 Side Wall Set: 64 1/4 x 28 1/2 x 5	White	3306

Description: Modern, matte finish multipiece tub shower kit. Slip resistant, textured bottom with left or right drain. Comes with four grab bars.

Includes: One bath tub, one back wall, and two side walls.

Standard Colors: White (010)

Packaging: Rectangular cartons.



VERITEK[®] PRO

TUB SHOWERS

MINIMALIST TUB SHOWERS

Model	Part	Weight (lbs)	FedEx	Carton Size (in)	Color	Price \$
VP6030CTSMIN	VP6030CTSMINL/R.XXX	133	✓	Tub: 62 1/2 x 34 x 17 3/4 Back Wall: 65 x 61 1/2 x 8 1/2 Side Wall Set: 64 x 26 1/2 x 5 1/4	White	1255
VP6030CTSMINA	VP6030CTSMINAL/R.XXX	163	✓	Tub: 62 1/2 x 34 x 17 3/4 Back Wall: 65 x 61 1/2 x 8 1/2 Side Wall Set: 64 x 26 1/2 x 5 1/4	White	1476
VP6030CTSMIN2	VP6030CTSMIN2L/R.XXX	133	✓	Tub: 62 1/2 x 34 x 17 3/4 Back Wall: 65 x 61 1/2 x 8 1/2 Side Wall Set: 64 x 26 1/2 x 5 1/4	White	1255
VP6030CTSMN2A	VP6030CTSMN2AL/R.XXX	163	✓	Tub: 62 1/2 x 34 x 17 3/4 Back Wall: 65 x 61 1/2 x 8 1/2 Side Wall Set: 64 x 26 1/2 x 5 1/4	White	1476
VP6030CTSMML	VP6030CTSMML/R.XXX	143	✓	Tub: 62 1/2 x 34 x 21 1/4 Back Wall: 65 x 61 1/2 x 8 1/2 Side Wall Set: 64 x 26 1/2 x 5 1/4	White	1255
VP6030CTSMMA	VP6030CTSMMAL/R.XXX	173	✓	Tub: 62 1/2 x 34 x 21 1/4 Back Wall: 65 x 61 1/2 x 8 1/2 Side Wall Set: 64 x 26 1/2 x 5 1/4	White	1474
VP6030CTSMML2	VP6030CTSMML2L/R.XXX	143		Tub: 62 1/2 x 34 x 21 1/4 Back Wall: 65 x 61 1/2 x 8 1/2 Side Wall Set: 64 x 26 1/2 x 5 1/4	White	1255
VP6030CTSMML2A	VP6030CTSMML2AL/R.XXX	173		Tub: 62 1/2 x 34 x 21 1/4 Back Wall: 65 x 61 1/2 x 8 1/2 Side Wall Set: 64 x 26 1/2 x 5 1/4	White	1476
VP6032CTSMIN	VP6032CTSMINL/R.XXX	135		Tub: 63 x 36 1/2 x 21 Back Wall: 65 x 61 1/2 x 8 1/2 Side Wall Set: 64 1/4 x 28 1/2 x 5	White	1412
VP6032CTSMINA	VP6032CTSMINAL/R.XXX	165		Tub: 63 x 36 1/2 x 21 Back Wall: 65 x 61 1/2 x 8 1/2 Side Wall Set: 64 1/4 x 28 1/2 x 5	White	1640
VP6032CTSMIN2	VP6032CTSMIN2L/R.XXX	135		Tub: 63 x 36 1/2 x 21 Back Wall: 65 x 61 1/2 x 8 1/2 Side Wall Set: 64 1/4 x 28 1/2 x 5	White	1412
VP6032CTSMN2A	VP6032CTSMN2AL/R.XXX	165		Tub: 63 x 36 1/2 x 21 Back Wall: 65 x 61 1/2 x 8 1/2 Side Wall Set: 64 1/4 x 28 1/2 x 5	White	1640
VP6032CTSMML	VP6032CTSMML/R.XXX	145		Tub: 63 x 36 1/2 x 24 1/2 Back Wall: 65 x 61 1/2 x 8 1/2 Side Wall Set: 64 1/4 x 28 1/2 x 5	White	1412
VP6032CTSMMA	VP6032CTSMMAL/R.XXX	175		Tub: 63 x 36 1/2 x 24 1/2 Back Wall: 65 x 61 1/2 x 8 1/2 Side Wall Set: 64 1/4 x 28 1/2 x 5	White	1640
VP6032CTSMML2	VP6032CTSMML2L/R.XXX	145		Tub: 63 x 36 1/2 x 24 1/2 Back Wall: 65 x 61 1/2 x 8 1/2 Side Wall Set: 64 1/4 x 28 1/2 x 5	White	1412
VP6032CTSMML2A	VP6032CTSMML2AL/R.XXX	175		Tub: 63 x 36 1/2 x 24 1/2 Back Wall: 65 x 61 1/2 x 8 1/2 Side Wall Set: 64 1/4 x 28 1/2 x 5	White	1640

Description: Modern, matte finish multipiece tub shower kit. Slip resistant, textured bottom with left or right drain.

Includes: One bathtub, one back wall, and two side walls.

Standard Colors: White (010)

Packaging: Rectangular cartons.

VERITEK® PRO

SHOWERS AND SHOWER PANS

SHOWERS

Model	Part	Weight (lbs)	FedEx	Carton Size (in)	Color	Price \$
VP3232CS	VP3232CS.XXX	101	✓	Pan: 33 1/2 x 33 1/2 x 8 1/4 Back Wall: 76 1/4 x 33 3/4 x 10 1/2 Side Wall Set: 76 1/4 x 26 3/4 x 5 1/4	White	960
VP3232CSA	VP3232CSA.XXX	131	✓	Pan: 33 1/2 x 33 1/2 x 8 1/4 Back Wall: 76 1/4 x 33 3/4 x 10 1/2 Side Wall Set: 76 1/4 x 26 3/4 x 5 1/4	White	1157
VP3636CS	VP3636CS.XXX	109	✓	Pan: 37 1/2 x 37 1/2 x 8 1/2 Back Wall: 76 1/4 x 37 3/4 x 10 1/2 Side Wall Set: 76 1/4 x 30 1/2 x 5	White	1012
VP3636CSA	VP3636CSA.XXX	139	✓	Pan: 37 1/2 x 37 1/2 x 8 1/2 Back Wall: 76 1/4 x 37 3/4 x 10 1/2 Side Wall Set: 76 1/4 x 30 1/2 x 5	White	1209
VP4834CS	VP4834CS.XXX	117	✓	Pan: 48 1/2 x 35 3/4 x 8 3/4 Back Wall: 76 1/4 x 49 1/2 x 8 1/2 Side Wall Set: 76 1/4 x 30 1/2 x 5	White	1088
VP4834CSA	VP4834CSA.XXX	147	✓	Pan: 48 1/2 x 35 3/4 x 8 3/4 Back Wall: 76 1/4 x 49 1/2 x 8 1/2 Side Wall Set: 76 1/4 x 30 1/2 x 5	White	1279
VP6030CS*	VP6030CSL/R.XXX	136		Pan: 61 x 31 3/4 x 8 1/2 Back Wall: 76 x 61 3/4 x 8 1/2 Side Wall Set: 76 1/4 x 26 3/4 x 5 1/4	White	1241
VP6030CSA*	VP6030CSAL/R.XXX	166		Pan: 61 x 31 3/4 x 8 1/2 Back Wall: 76 x 61 3/4 x 8 1/2 Side Wall Set: 76 1/4 x 26 3/4 x 5 1/4	White	1422
VP6034CS	VP6034CS.XXX	141		Pan: 61 1/4 x 35 1/2 x 8 1/2 Back Wall: 76 x 61 3/4 x 8 1/2 Side Wall Set: 76 1/4 x 30 1/2 x 5	White	1258
VP6034CSA	VP6034CSA.XXX	171		Pan: 61 1/4 x 35 1/2 x 8 1/2 Back Wall: 76 x 61 3/4 x 8 1/2 Side Wall Set: 76 1/4 x 30 1/2 x 5	White	1440

Description: Modern, matte finish multipiece shower kit. Slip resistant, textured bottom with center drain unless other wise noted.

Includes: One shower pan, one back wall, and two side walls.

Standard Colors: White (010)

Packaging: Rectangular cartons.

***Note:** This model is available as left or right drain only.

SHOWER PANS

Model	Part	Weight (lbs)	FedEx	Carton Size (in)	Color	Price \$
VP3232CPANNS	VP3232CPANNS.XXX	28	✓	33 1/2 x 33 1/2 x 8 1/4	White	302
VP3636CPANNS	VP3636CPANNS.XXX	32	✓	37 1/4 x 37 1/4 x 8 1/2	White	317
VP4242CPANNS	VP4242CPANNS.XXX	42	✓	43 1/2 x 43 1/2 x 8 1/4	White	416
VP4834CPANNS	VP4834CPANNS.XXX	36	✓	48 1/2 x 35 3/4 x 8 3/4	White	369
VP6030CPANNSL/R*	VP6030CPANNSL/R.XXX	46	✓	61 x 31 3/4 x 8 1/2	White	466
VP6034CPANNS	VP6034CPANNS.XXX	50	✓	61 1/4 x 35 1/2 x 8 1/2	White	466
VP3232CPAN	VP3232CPAN.XXX	28	✓	33 1/2 x 33 1/2 x 8 1/4	White	302
VP3636CPAN	VP3636CPAN.XXX	32	✓	37 1/4 x 37 1/4 x 8 1/2	White	317
VP4242CPAN	VP4242CPAN.XXX	40	✓	43 1/2 x 43 1/2 x 8 1/4	White	416
VP4834CPAN	VP4834CPAN.XXX	36	✓	48 1/2 x 35 3/4 x 8 3/4	White	369
VP6030CPANL/R*	VP6030CPANL/R.XXX	47	✓	61 x 31 3/4 x 8 1/2	White	466
VP6034CPAN	VP6034CPAN.XXX	50	✓	61 1/4 x 35 1/2 x 8 1/2	White	466

Description: Modern, matte finish on a pre-leveled base designed for tile wall application. Slip resistant, textured bottom with center drain unless otherwise noted.

Includes: One shower pan.

Standard Colors: White (010)

Packaging: Flat, rectangular carton.

***Note:** This model is available as left or right drain only.



VERITEK[®] PRO

BATHTUBS

CLASSIC TUBS

Model	Part	Weight (lbs)	FedEx	Carton Size (in)	Color	Price \$
VP6030CTL/R	VP6030CTL/R.XXX	54	✓	62 1/2 x 34 x 17 3/4	White	417
VP6030CTML/R	VP6030CTML/R.XXX	54	✓	62 1/2 x 34 x 21 3/4	White	465
VP6036CTL/R	VP6036CTL/R.XXX	71	✓	63 x 40 1/2 x 21	White	947
VP6036CTML/R	VP6036CTML/R.XXX	71	✓	63 x 40 1/2 x 24 1/2	White	990
VP6042CTL/R	VP6042CTL/R.XXX	77	✓	63 x 47 x 21 1/2	White	990
VP6042CTML/R	VP6042CTML/R.XXX	77	✓	63 x 47 x 24 1/2	White	1037

Description: Left or right hand options available. Features a pre-leveled base and a slip resistant, textured bottom in a modern, matte finish.

Includes: One bathtub.

Standard Colors: White (010)

Packaging: Flat, rectangular cartons.

MINIMALIST TUBS

Model	Part	Weight (lbs)	FedEx	Carton Size (in)	Color	Price \$
VP6030CTMINL/R	VP6030CTMINL/R.XXX	57	✓	62 1/2 x 34 x 17 3/4	White	622
VP6030CTMML/R	VP6030CTMML/R.XXX	67	✓	62 1/2 x 34 x 21 3/4	White	622
VP6032CTMINL/R	VP6032CTMINL/R.XXX	57	✓	63 x 36 1/2 x 21	White	764
VP6032CTMML/R	VP6032CTMML/R.XXX	67	✓	63 x 36 1/2 x 24 1/2	White	764

Description: Left or right hand options available. Features a pre-leveled base and a slip resistant, textured bottom in a modern, matte finish.

Includes: One bathtub.

Standard Colors: White (010)

Packaging: Flat, rectangular cartons.







SWANSTONE

Design your own **Swanstone Custom Vanity Top**

- Authentic solid surface allows for consistent color and texture and won't fade or wear away.
- Design your vanity top any size up to 173"
- Add one of many sculpted edge options.
- Select from a wide variety of solid and aggregate colors.
- Place the bowl where and how you want, with drop-in, vessel and seamless undermount options.
- Visit [swanstone.com/customvanity](https://www.swanstone.com/customvanity) to design and configure your vanity top to your specifications.



Swan



KITCHEN AND
UTILITY SOLUTIONS

GRANITE

KITCHEN SINKS

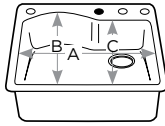

9" deep bowl
A 21-3/8", B 17-7/8", C 16"

SINGLE BOWL QZSB-2522 AND QUSB-2522

Model	Part	Dimensions (in)	Weight (lbs)	FedEx	Carton Size (in)	C/F	Mount Type	Price \$
QZSB-2522	QZ02522SB.XXX	25 W x 22 D	40	✓	29 x 26 x 14	6.1	Drop In	740
QUSB-2522	QU02522SB.XXX	24 W x 21 D	39	✓	29 x 26 x 14	6.1	Undermount	822

Granite: Opal White (210), Espresso (170), Granito (076), Nero (077), Metallico (173)

Packaging: Rectangular carton.

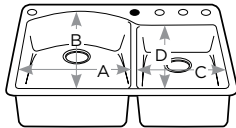

9" deep bowls
A 15-1/4", B 18-3/8"
C 12-7/8", D 16"

DOUBLE BOWL QZDB-3322 AND QUDB-3322

Model	Part	Dimensions (in)	Weight (lbs)	FedEx	Carton Size (in)	C/F	Mount Type	Price \$
QZDB-3322	QZ03322DB.XXX	33 W x 22 D	51	✓	37 x 26 x 15	8.4	Drop In	891
QUDB-3322	QU03322DB.XXX	32 W x 21 D	44	✓	37 x 27 x 15	8.7	Undermount	977

Granite: Opal White (210), Espresso (170), Granito (076), Nero (077), Metallico (173)

Packaging: Rectangular carton.

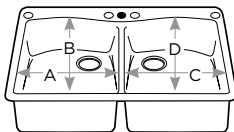

9" deep bowls
A 14-1/2", B 17-1/8"
C 14-1/2", D 17-1/8"

EVEN DOUBLE BOWL QZED-3322 AND QUED-3322

Model	Part	Dimensions (in)	Weight (lbs)	FedEx	Carton Size (in)	C/F	Mount Type	Price \$
QZED-3322	QZ03322ED.XXX	33 W x 22 D	48	✓	38 x 27 x 13	7.7	Drop In	891
QUED-3322	QU03322ED.XXX	32 W x 21 D	46	✓	38 x 26 x 13	7.4	Undermount	977

Granite: Espresso (170), Granito (076), Nero (077), Metallico (173)

Packaging: Rectangular carton.

Note: Not available in Opal White (210)

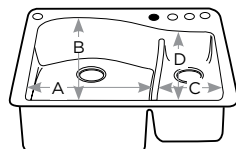

10" deep bowl, 7-1/2" deep bowl
A 17-1/4", B 18"
C 11", D 15-1/4"

LARGE/SMALL BOWL QZLS-3322 AND QULS-3322

Model	Part	Dimensions (in)	Weight (lbs)	FedEx	Carton Size (in)	C/F	Mount Type	Price \$
QZLS-3322	QZ03322LS.XXX	33 W x 22 D	48	✓	37 x 27 x 15	8.7	Drop In	928
QULS-3322	QU03322LS.XXX	32 W x 21 D	49	✓	37 x 26 x 15	8.4	Undermount	1014

Granite: Opal White (210), Espresso (170), Granito (076), Nero (077), Metallico (173)

Packaging: Rectangular carton.

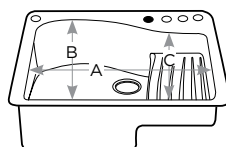

10" deep bowl, 6" deep bowl
A 29-1/2", B 18", C 15-1/4"

LARGE SINGLE ASCEND™ BOWL QZAD-3322 AND QUAD-3322

Model	Part	Dimensions (in)	Weight (lbs)	FedEx	Carton Size (in)	C/F	Mount Type	Price \$
QZAD-3322	QZ03322AD.XXX	33 W x 22 D	50	✓	37 x 26 x 15	8.4	Drop In	928
QUAD-3322	QU03322AD.XXX	32 W x 21 D	45	✓	37 x 26 x 15	8.4	Undermount	1014

Granite: Opal White (210), Espresso (170), Granito (076), Nero (077), Metallico (173)

Packaging: Rectangular carton.



GRANITE

KITCHEN SINKS

LARGE SINGLE BOWL SINK QZSB-3322 AND QUSB-3322

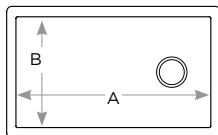

9" deep bowl
A 29", B 16-3/8"

Model	Part	Dimensions (in)	Weight (lbs)	FedEx	Carton Size (in)	C/F	Mount Type	Price \$
QZSB-3322	QZ03322SB.XXX	33 W x 22 D	50	✓	38 x 27 x 15	8.9	Drop In	884
QUSB-3322	QU03322SB.XXX	32 W x 21 D	40	✓	37 x 26 x 13	7.2	Undermount	1014

Granite: Opal White (210), Espresso (170), Granito (076), Nero (077), Metallico (173)

Packaging: Rectangular carton.

BAR SINK QZBS-1816

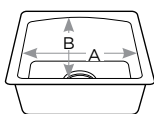

7-1/2" deep bowl
A 15", B 13"

Model	Part	Dimensions (in)	Weight (lbs)	FedEx	Carton Size (in)	C/F	Mount Type	Price \$
QZBS-1816	QZ01816BS.XXX	18 W x 16 D	23	✓	22 x 21 x 12	3.2	Dual Mount	639

Granite: Opal White (210), Espresso (170), Granito (076), Nero (077), Metallico (173)

Packaging: Rectangular carton.

SWANSTONE

DUAL MOUNT KITCHEN SINKS

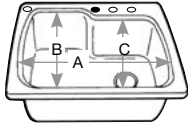

9" deep bowl
A 21-1/8", B 17-5/8", C 15-5/8"

SINGLE BOWL KSSB-2522

Model	Part	Dimensions (in)	Weight (lbs)	FedEx	Carton Size (in)	C/F	Solid \$	Aggregate \$
KSSB-2522	KS02522SB.XXX	25 W x 22 D	23	✓	30 x 26 x 13	5.9	313	413

Standard Colors: White (010), Bone (037), Bisque (018).
Aggregate Colors: See color listing for details
Packaging: Rectangular carton.

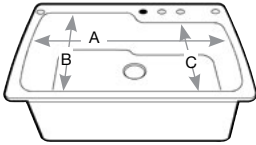

10" deep bowl
A 29-1/2", B 18-3/4", C 16-1/4"

SINGLE BOWL KSSB-3322

Model	Part	Dimensions (in)	Weight (lbs)	FedEx	Carton Size (in)	C/F	Solid \$	Aggregate \$
KSSB-3322	KS03322SB.XXX	33 W x 22 D	34	✓	36 x 24 x 14	7.0	412	540

Standard Colors: White (010), Bone (037), Bisque (018).
Aggregate Colors: See color listing for details
Packaging: Rectangular carton.

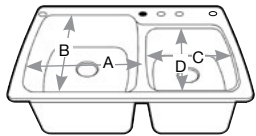

9" deep bowls
A 14-1/4", B 18-7/8"
C 13-3/4", D 15-1/4"

DOUBLE BOWL KSDB-3322

Model	Part	Dimensions (in)	Weight (lbs)	FedEx	Carton Size (in)	C/F	Solid \$	Aggregate \$
KSDB-3322	KS03322DB.XXX	33 W x 22 D	32	✓	38 x 27 x 13	7.7	348	455

Standard Colors: White (010), Bone (037), Bisque (018).
Aggregate Colors: See color listing for details
Packaging: Rectangular carton.

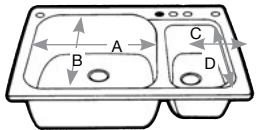

9" deep large bowl,
7" deep small bowl
A 19-3/8", B 18-7/8"
C 8-7/8", D 15-5/8"

LARGE/SMALL BOWL KSLB-3322

Model	Part	Dimensions (in)	Weight (lbs)	FedEx	Carton Size (in)	C/F	Solid \$	Aggregate \$
KSLB-3322	KS03322LS.XXX	33 W x 22 D	32	✓	38 x 27 x 13	7.7	388	507

Standard Colors: White (010), Bone (037), Bisque (018).
Aggregate Colors: See color listing for details
Packaging: Rectangular carton.

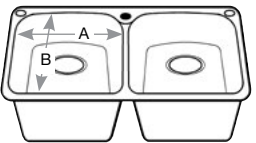

10" deep bowls
A 14-1/8", B 18-7/8"

SUPER DOUBLE BOWL KSLB-3322

Model	Part	Dimensions (in)	Weight (lbs)	FedEx	Carton Size (in)	C/F	Solid \$	Aggregate \$
KSLB-3322	KS02233LB.XXX	33 W x 22 D	37	✓	36 x 25 x 14	7.3	432	568

Standard Colors: White (010), Bone (037), Bisque (018).
Aggregate Colors: See color listing for details
Packaging: Rectangular carton.



SWANSTONE

DUAL MOUNT KITCHEN SINKS

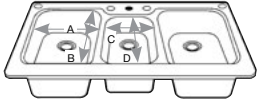

9" deep bowls
7" deep middle bowl
A 14-1/4", B 18-3/8"
C 8-7/8", D 16"

TRIPLE BOWL KSTB-4422

Model	Part	Dimensions (in)	Weight (lbs)	FedEx	Carton Size (in)	C/F	Solid \$	Aggregate \$
KSTB-4422	KS04422TB.XXX	44 W x 22 D	45	✓	48 x 25 x 13	9.0	500	656

Standard Colors: White (010), Bone (037), Bisque (018).
Aggregate Colors: See color listing for details
Packaging: Rectangular carton.

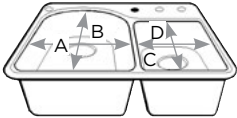

7" deep bowls
A 11-7/8", B 14-1/2"
C 8-5/8", D 12-1/4"

SPACE SAVER DOUBLE BOWL KSDB-2518

Model	Part	Dimensions (in)	Weight (lbs)	FedEx	Carton Size (in)	C/F	Solid \$	Aggregate \$
KSDB-2518	KS02518DB.XXX	25 W x 18 D	16	✓	29 x 22 x 11	4.1	189	246

Standard Colors: White (010), Bone (037), Bisque (018).
Aggregate Colors: See color listing for details
Packaging: Rectangular carton.

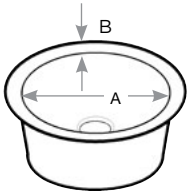

7" deep bowl
A 15-3/4", B 1-3/8"

ROUND BOWL KSRB-18

Model	Part	Dimensions (in)	Weight (lbs)	FedEx	Carton Size (in)	C/F	Solid \$	Aggregate \$
KSRB-18	KS00018RB.XXX	18-1/2 D	14	✓	21 x 21 x 10	2.6	205	272

Standard Colors: White (010), Bone (037), Bisque (018).
Aggregate Colors: See color listing for details
Packaging: Rectangular carton.

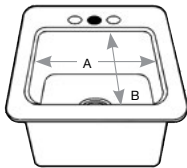

5" deep bowl
A 12", B 10"

ENTERTAINMENT BOWL BS-1515

Model	Part	Dimensions (in)	Weight (lbs)	FedEx	Carton Size (in)	C/F	Solid \$	Aggregate \$
BS-1515	BS01515.XXX	15 W x 15 D	9	✓	18 x 18 x 8	1.5	180	233

Standard Colors: White (010), Bone (037), Bisque (018).
Aggregate Colors: See color listing for details
Packaging: Rectangular carton.

SWANSTONE

UNDERMOUNT SINKS

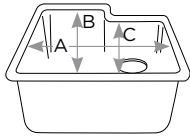

8" deep bowl
A 22", B 18-1/4", C 15-5/16"

SINGLE BOWL US-2215

Model	Part	Dimensions (in)	Weight (lbs)	FedEx	Carton Size (in)	C/F	Solid \$	Aggregate \$
US-2215	US02215SB.XXX	25 W x 21-1/4 D	26	✓	30 x 26 x 13	5.9	537	664

Standard Colors: White (010), Bone (037), Bisque (018).
Aggregate Colors: See color listing for details
Packaging: Rectangular carton.

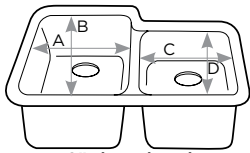

8" deep bowl
A 14-1/2", B 18-1/8"
C 14-1/2", D 15-5/8"

DOUBLE BOWL US-3015

Model	Part	Dimensions (in)	Weight (lbs)	FedEx	Carton Size (in)	C/F	Solid \$	Aggregate \$
US-3015	US03015SB.XXX	32-3/4 W x 21-1/8 D	34	✓	38 x 27 x 13	7.7	596	739

Standard Colors: White (010), Bone (037), Bisque (018).
Aggregate Colors: See color listing for details
Packaging: Rectangular carton.

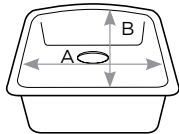

8-1/4" deep bowl
A 18-7/8", B 18-1/8"

LARGE BOWL US-2021

Model	Part	Dimensions (in)	Weight (lbs)	FedEx	Carton Size (in)	C/F	Solid \$	Aggregate \$
US-2021	US02021SB.XXX	20-7/8 W x 20-1/8 D	19	✓	25 x 24 x 11	3.8	468	578

Standard Colors: White (010), Bone (037), Bisque (018).
Aggregate Colors: See color listing for details
Packaging: Rectangular carton.

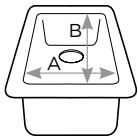

6-3/4" deep bowl
A 8-7/8", B 15-5/8"

SMALL BOWL US-1711

Model	Part	Dimensions (in)	Weight (lbs)	FedEx	Carton Size (in)	C/F	Solid \$	Aggregate \$
US-1711	US01711SB.XXX	10-7/8 W x 17-5/8 D	10	✓	21 x 14 x 8	1.4	194	244

Standard Colors: White (010), Bone (037), Bisque (018).
Aggregate Colors: See color listing for details
Packaging: Rectangular carton.

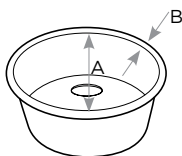

7" deep bowl
A 15-9/16", B 1-3/8"

ROUND BOWL USRB-18

Model	Part	Dimensions (in)	Weight (lbs)	FedEx	Carton Size (in)	C/F	Solid \$	Aggregate \$
USRB-18	US00018RB.XXX	18-3/8 diameter	16	✓	21 x 21 x 11	2.8	312	416

Standard Colors: White (010), Bone (037), Bisque (018).
Aggregate Colors: See color listing for details
Packaging: Rectangular carton.

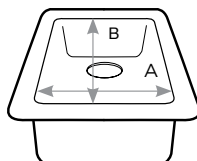

6-1/2" deep bowl
A 10-3/8", B 12-3/8"

ENTERTAINMENT SINK US-1210

Model	Part	Dimensions (in)	Weight (lbs)	FedEx	Carton Size (in)	C/F	Solid \$	Aggregate \$
US-1210	US01513SB.XXX	13-3/8 W x 15-3/8 D	11	✓	18 x 16 x 9	1.5	183	228

Standard Colors: White (010), Bone (037), Bisque (018).
Aggregate Colors: See color listing for details
Packaging: Rectangular carton.



VERITEK®

LAUNDRY TUBS

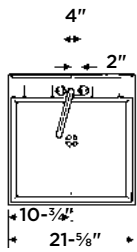

VERITEK® SINGLE LAUNDRY TUB WITH STEEL LEGS (MF-F)

Model	Part	Dimensions (in)	Weight (lbs)	FedEx	Carton Size (in)	C/F	Price \$
MF-F	MF0000FM.001	23- ³ / ₈ D x 21 ⁵ / ₈ W	26	✓	26 x 25 x 18	6.8	247

Includes: One tub with factory installed drain, one set of angular steel legs (4) with hardware.

Packaging: Rectangular carton.

Note: Available in White only.

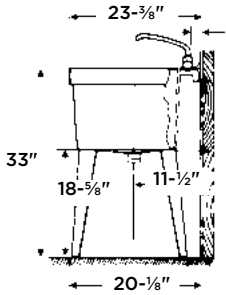

VERITEK® SINGLE WALL MOUNTED LAUNDRY TUB MF-W

Model	Part	Dimensions (in)	Weight (lbs)	FedEx	Carton Size (in)	C/F	Price \$
MF-W	MF0000WM.001	23- ³ / ₈ D x 21 ⁵ / ₈ W	27	✓	26 x 26 x 18	7.0	220

Includes: One tub with factory installed drain and wall bracket assembly.

Packaging: Rectangular carton.

Note: Available in White only.

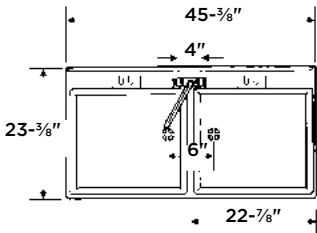

VERITEK® SIX-PACK LAUNDRY TUBS MF-6PK

Model	Part	Dimensions (in)	Weight (lbs)	FedEx	Carton Size (in)	C/F	Price \$
MF-6PK*	MF00006.001	23- ³ / ₈ D x 21 ⁵ / ₈ W	125	--	40 x 25 x 25	14.5	934

Includes: Six tubs with factory installed drains

Packaging: Rectangular carton.

Note: Six pack tubs can be used for pan or wall installation: legs and wall mounting brackets are sold separately, see below.

Note: Available in White only.

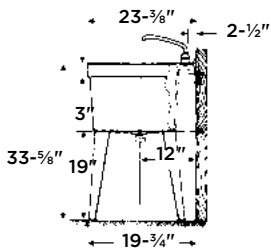

SIX-PACK METAL LAUNDRY TUB LEGS FOR MF

Model	Part	Dimensions (in)	Weight (lbs)	FedEx	Carton Size (in)	C/F	Price \$
LP-MF-6PK	LP60000MS.000	24 metal tub legs	24	✓	22 x 13 x 5	0.8	306

Includes: Six pack tub legs include 24 legs (six sets) with hardware and installation instructions.

Note: Available in White only.

VERITEK® DOUBLE LAUNDRY TUB WITH STEEL LEGS MF-2F

Model	Part	Dimensions (in)	Weight (lbs)	FedEx	Carton Size (in)	C/F	Price \$
MF-2F	MF20000FM.001	23- ³ / ₈ D x 45- ³ / ₈ W	48	✓	48 x 26 x 18	13.0	487

Includes: Six wall bracket assemblies with hardware and installation instructions. Packaging: Individual carton.

Note: Available in White only.

SWAN

UTILITY SINKS

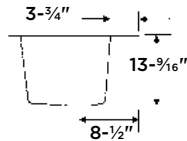
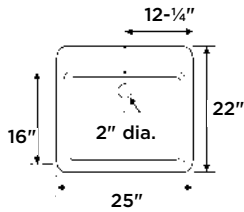

SWAN LARGE UTILITY SINK SSUS

Model	Part	Dimensions (in)	Weight (lbs)	FedEx	Carton Size (in)	C/F	Solid \$	Aggregate \$
SSUS	SSUS1000.XXX	25 W x 22 D	18	✓	26 x 25 x 17	6.4	200	352

Includes: Utility sink, matching drain, hardware for countertop attachment and installation instructions.

Standard Colors: White (010), Bisque (018)

Packaging: Individual carton.

Notes: Five starter holes are countersunk on the underside of the utility sink to accommodate a single, 4-inch or 8-inch faucet. Can be used as a drop-in or undermount sink.

VERITEK® LARGE UTILITY SINK DIT

Model	Part	Dimensions (in)	Weight (lbs)	FedEx	Carton Size (in)	C/F	Solid \$
DIT	DIT1000.033	25 W x 22 D	18	✓	26 x 23 x 16	5.4	231

Includes: Utility sink, hardware for countertop attachment, and installation instructions.

Standard Colors: Flock (033)

Packaging: Individual carton.

Notes: Three starter holes are countersunk on the underside of the utility sink to accommodate a single or 4-inch faucet.

SWAN COMPACT UTILITY SINK SSUS-S

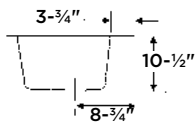
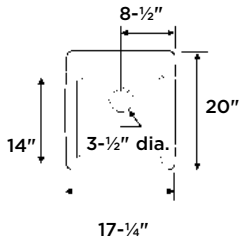

Model	Part	Dimensions (in)	Weight (lbs)	FedEx	Carton Size (in)	C/F	Solid \$
SSUS-S	SSUS2000.XXX	17-1/4 W x 20 D	12	✓	23 x 19 x 13	3.3	168

Includes: Utility sink, matching drain, hardware for countertop attachment and installation instructions.

Standard Colors: White (010)

Packaging: Individual carton.

Notes: Five starter holes are countersunk on the underside of the utility sink to accommodate a single, 4-inch or 8-inch faucet. Can be used as a drop-in or undermount sink.

VERITEK® COMPACT UTILITY SINK DIT-S

Model	Part	Dimensions (in)	Weight (lbs)	FedEx	Carton Size (in)	C/F	Solid \$
DIT-S	DIT2000.033	17-1/4 W x 20 D	12	✓	23 x 22 x 14	4.1	211

Includes: Utility sink, hardware for countertop attachment, and installation instructions.

Standard Colors: Flock (033)

Packaging: Individual carton.

Notes: Three starter holes are countersunk on the underside of the utility sink to accommodate a single or 4-inch faucet.



MOP SERVICE SINKS

AND SINK ACCESSORIES

REMOVEABLE WORK SURFACE FOR SSUS WS-1 (NOT SHOWN)

Model	Part	Dimensions (in)	Weight (lbs)	FedEx	Carton Size (in)	C/F	Colors	Price \$
WS-1	WS10000.000	7 D X 17 W	3	✓	17 X 8 X 1	.08	White	80

CELCON BODY FAUCET CF10000 (NOT SHOWN)

Model	Part	Dimensions (in)	Weight (lbs)	FedEx	Carton Size (in)	C/F	Colors	Price \$
CF10000	CF10000.000	—	2	✓	6 x 11 x 4	0.2	Chrome	76

FAUCET BLOCK FB10000 (NOT SHOWN)

Model	Part	Dimensions (in)	Weight (lbs)	FedEx	Carton Size (in)	C/F	Colors	Price \$
FB10000	FB10000.010	—	1	✓	3 x 6 x 2	0.01	White	17

RUBBER DRAIN ADAPTER 3" TO 2" MS-2410



Model	Part	Weight (lbs)	FedEx	Carton Size (in)	C/F	Price \$
MS-2410	MS00302DA.000	1	✓	5 x 5 x 3	0.01	31

RUBBER DRAIN ADAPTER 3" TO 3" MS-4211

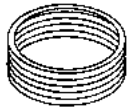

Model	Part	Weight (lbs)	FedEx	Carton Size (in)	C/F	Price \$
MS-4211	MS00303DA.000	1	✓	5 x 5 x 3	0.01	31

VERITEK® DOUBLE WALL MOUNTED UTILITY SINK MF-2W (NOT SHOWN)

Model	Part	Dimensions (in)	Weight (lbs)	FedEx	Carton Size (in)	C/F	Price \$
MF-2W	MF20000WM.001	23- ³ / ₈ D x 45- ³ / ₈ W	48	✓	48 x 26 x 18	13.0	487

Includes: One tub with factory installed drain, wall bracket assembly and twin waste. Not available in six-pack.

Packaging: Individual cartons

VERITEK® MOP SERVICE SINKS MS-2424 AND MS-2436

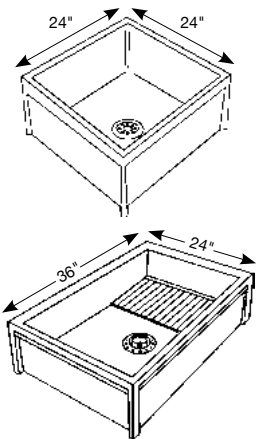

Model	Part	Dimensions (in)	Weight (lbs)	FedEx	Carton Size (in)	C/F	Price \$
MS-2424	MS02424WA.033	24 D x 24 W	48	✓	26 x 25 x 12	4.5	631
MS-2436	MS02436WA.033	36 D x 24 W	64	✓	35 x 27 x 12	6.6	688

Includes: One sink, one code approved 3" IPS cast brass drain and a 3" rubber drain adapter (MS-2411).

Packaging: Individual cartons

MOP SERVICE SINKS

AND SINK ACCESSORIES



MOP SERVICE SINK FAUCET MS-2412

Model	Part	Weight (lbs)	FedEx	Carton Size (in)	C/F	Price \$
MS-2412	MS24000SF.000	7	✓	11 x 11 x 6	0.42	363



MOP HANGER MS-2437

Model	Part	Weight (lbs)	FedEx	Carton Size (in)	C/F	Price \$
MS-2437	MS24000MH.000	2	✓	25 x 5 x 3	0.2	119



VINYL RIM GUARD, FOR BOTH SIZES MS-2408

Model	Part	Weight (lbs)	FedEx	Carton Size (in)	C/F	Price \$
MS-2408	MS24000RG.000	2	✓	39 x 3 x 2	0.14	61

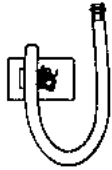

HOSE & HOSE HOLDER MS-2405

Model	Part	Weight (lbs)	FedEx	Carton Size (in)	C/F	Price \$
MS-2405	MS24000HH.000	2	✓	11 x 11 x 4	0.28	71

3" MOP SINK DRAIN ASSEMBLY MS-2403N (NOT SHOWN)

Model	Part	Weight (lbs)	FedEx	Carton Size (in)	C/F	Price \$
MS-2403	MS02403DA.000	3	✓	6 x 6 x 3	0.1	121

STAINLESS STEEL WALL GUARD MS-1224-2 (NOT SHOWN)

Model	Part	Weight (lbs)	FedEx	Carton Size (in)	C/F	Price \$
MS-1224-2	WG22240.000	2	✓	2 x 24 x 5	0.14	317





REFERENCE

CARE AND CLEANING

GUIDE

Swanstone Walls and Pans

Clean regularly with common household liquid cleaners and rinse within five minutes of application. Occasional scrubbing with abrasive cleaners ensures that the original luster will be maintained. For hard water stains, scale removers can be used. If necessary, abrasive cleaners can be used with a nylon brush or pad to remove build up on the shower pan surface. Do not use a metal-scouring pad or a wire brush, as it will damage the surface.

Do not use “leave on” cleaning products, such as automatic spray shower cleaners. Prolonged contact with harsh chemicals could have an adverse reaction over time and discolor surfaces.

Do not use cleaning agents that caution use on acrylic, polyester or plastics.

Swanstone Vanity Tops and Bowls

Cleaning regularly with common household liquid cleaners is recommended. If necessary, abrasive liquids or detergents are safe and effective for use with nylon scouring pads, sponges, or other similar products. Mineral stain removers are acceptable as well.

Do not use metal scouring pads.

Veritek® Products

Clean regularly with common household liquid cleaners and a sponge or soft cloth. For hard water stains, scale removers can be used. To protect finish, any fiberglass wax or automotive paste wax can be applied.

Do not use cleaning agents that caution use on acrylic, polyester or plastics.

Do not use abrasive cleaners or scouring pads.

Do not use “leave on” cleaning products, such as automatic spray shower cleaners. Prolonged contact with harsh chemicals could have an adverse reaction over time and discolor surfaces.

Swanstone Kitchen Sink

Clean your Swanstone sink by using abrasive cleaners or other similar products. Use of a nylon scouring pad is also recommended. Food-based stains can be removed using a 50-50 mix of bleach and water solution and soaking for 15 minutes. For rust or other mineral stains, rust-removing products are acceptable. To restore luster or extend time between cleanings, Granite Cleaner & Polish is recommended. Do not use metal scouring pads.

Swan Granite Sink

Clean your Swan Granite Sink by using warm water and a soft clean cloth or sponge. Non-abrasive liquid cleaners and detergents can also be used. Hard water, calcium and lime deposits can be removed with white vinegar on a paper towel; rinsing after 20 minutes. To restore luster and extend time between cleanings Granite Cleaner & Polish is recommended. Staining liquids, such as dyes and vegetable juices should be rinsed off as soon as possible.

Do not use abrasive cleaners, metal-scouring pads, or bleach or alkali cleaners, such as ammonia.

Swan Utility Sink

Clean regularly with common household liquid cleaners, bleach or similar type products in conjunction with a sponge or soft cloth. For hard water stains, scale removers can be used. To protect finish, fiberglass wax or automotive paste wax can be applied.

Do not use abrasive cleaners or metal scouring pads.



COLOR AVAILABILITY

EFFECTIVE FEBRUARY 1, 2022

		SOLIDS				GRANITE				AGGREGATES											
		White (010)	Bisque (018)	Bone (037)	Flock (033)	Opal White (210)**	Espresso (170)	Granito (076)	Nero (077)	Metallico (173)	Bermuda Sand (040)	Black Galaxy (015)	Carrara (221)	Concrete Ash Gray (203)	Concrete Birch (226)	Concrete Charcoal Gray (209)	Concrete Clay (212)	Concrete Limestone (218)	Concrete Sandstone (215)	Ice (130)	Tahiti White (011)
BATH PRODUCTS																					
SWANSTONE	BATH WALL KITS	•	•	•							•		•	•	•	•	•	•	•	•	•
	BATH WALL PANELS	•	•	•							•		•	•	•	•	•	•	•	•	•
	TRIM KITS	•	•	•							•		•	•	•	•	•	•	•	•	•
	CORNER MOLDINGS	•	•	•							•		•	•	•	•	•	•	•	•	•
	SOAP SHELVES	•	•	•							•		•	•	•	•	•	•	•	•	•
	SHOWER PANS	•	•	•							•		•	•	•	•	•	•	•	•	•
	VANITY TOPS	•	•	•							•		•	•	•	•	•	•	•	•	•
	VANITY TOP ACCESSORIES	•	•	•							•		•	•	•	•	•	•	•	•	•
	UNDERMOUNT BOWLS	•	•	•							•		•	•	•	•	•	•	•	•	•
	VESSEL SINK	•	•	•							•		•	•	•	•	•	•	•	•	•
VERITEK®	WALLS	•	•	•																	
	BATHTUBS	•	•	•																	
	ALCOVE WALLS	•	•	•																	
	SHOWER PANS	•	•	•																	
VERITEK®PRO	WALLS	•																			
	BATHTUBS	•																			
	TUB SHOWERS	•																			
	SHOWERS	•																			
	SHOWER PANS	•																			
KITCHEN AND UTILITY PRODUCTS																					
	SWANSTONE SINKS	•	•	•							•	•								•	•
	GRANITE SINKS**					•	•	•	•	•											
	SWAN UTILITY SINKS	•	•		•																
	SWAN LAUNDRY TUBS	•																			•
	SWAN MOP SERVICE SINKS	•																			

* QZED-3322 Drop-In; QUED-3322 Undermount is not available in Opal White (210):

NOTE: Some colors available by quote only.





SWANSTONE

SPECIFICATIONS AND TECHNICAL DATA SHEET

Product

Swanstone Reinforced Solid Surface Products

Manufacturer

Swan, St. Louis, Missouri with manufacturing facilities in Centralia, Illinois.

Product Composition

Swanstone® is a compression-molded compound that consists of a blend of polymer resins, fillers and reinforcement additives. In the manufacturing process, Swanstone transforms into a thermoset material that has extreme resistance to heat, impact, expansion, and chemicals.

Product Category

Swanstone is available in bath walls, integral top and bowl vanity tops, kitchen sinks, kitchen countertops, bar sinks, undermount bowls and blank vanity tops. Offset vanity top bowl locations are available.

Colors

Swanstone is available in a variety of solid, solid bolds, and/or aggregate colors. Review products individually for complete color offerings.

Warranties

Swanstone wall panels and trim kits, vanity tops and bowls, kitchen and bar sinks, window trim kits and shower pans are covered by a limited lifetime warranty for residential applications. For commercial applications Swan offers the following limited warranties:

25-Year Limited Warranty on wall panels and trim kits.

25-Year Limited Warranty against thermal cracking on our vanity tops and bowls.

10-Year Limited Warranty against defects on countertops.

10-Year Limited Warranty against defects and/or thermal cracking on our kitchen sinks and bar sinks.

10-Year Limited Warranty against warping, blistering, loss of color, or fading on shower pans. Complete details and product warranty application for both residential and commercial are available by writing to Swan.

Maintenance

Swanstone should be cleaned as you would any other fine kitchen or bath fixture. For kitchen sinks and countertops, rinse any food or beverage residue as soon as possible; follow up with normal household cleaners. To remove residue that cannot be rinsed away or removed with other types of cleaners, use powdered abrasive cleaners and/or a nylon or plastic scrubbing pad. Vanity tops should be cleaned with normal household cleaners. Cleaners designed for removing mineral-based stains can be used on Swanstone, as well as a mild solution (50/50) of chlorine bleach and water. In the event of a scratch, start with powdered abrasive cleaner and a scrubbing pad; if further attention is needed, use white automotive rubbing compound or light sanding with a 400 grit or 40 micron sandpaper.

Application

Swanstone products can be used in any interior horizontal and vertical surfaces, including kitchen sinks, shower pans, lavatory bowls, and bar sink applications.

Limitations

Swanstone products are not recommended for exterior use. Material should not be used in areas exposed to sustained temperatures exceeding 450 degrees F. Follow all recommended installation procedures provided by manufacturer.

Finish

The decorative surface of Swanstone is a matte finish equal to a 320 grit sandpaper (gloss reading of 25). A higher sheen can be produced by buffing the product with commercial rubbing compound.

Flat Sheet Stock Tolerance

Flat sheet products used in shower walls, wainscoting, trim kits etc.:

+/- 0.080 inches

Flat sheet products with the side opposite the show side processed through a grinding operation:

+/- 0.030 inches

Fabrication flat sheet products with the side opposite the show side processed through a grinding operation, and the show side sanded and finished:

+/- 0.030 inches

Availability

Swanstone is available nationwide through local stocking distributors. Contact Swan for your nearest distributor.

Cost

Cost varies with product category. Contact your local distributor for applicable costs.

Installation

Swanstone reinforced solid surface products are shipped with complete installation manuals provided with every unit. Consult the specific product installation manual for step-by-step installation procedures. All manuals are available through Swan or your local distributor.

Chemical And Stain Resistance

Chemical and Stain Resistance-NEMA LD3-3,09

No lasting effect on Swanstone occurred from the exposure to the following.

Class I Chemicals

Solvents
Acetone
Amyl Acetate
Benzene
Carbon Tetrachloride
Ethyl Ether
Gasoline/Kerosene
Ethanol
Methanol
Toluene
Chloroform
Ethyl Acetate
Naphtha

Other

Ammonia (10%)
Iodine
Lye (1%)
Mercurochrome
Nail Polish Remover
Potassium Permanganate
Silver Nitrate (10%)
Sodium Bisulfate
Sodium Hypochlorite (5%)
Trisodium Phosphate
Urea (6%)
Vinegar

Class II Chemicals

Acids
Furfural
Methylene Chloride
Nitric Acid (30%, 70%)*
Phenol
Acids (99.5%)
Citric
Hydrochloric (20%)
Phosphoric
Sulfuric (77.96%)*
Trichlor Acetic
Formic
Hydrogen Peroxide
Alkalies
Ammonium Hydroxide
Sodium Hydroxide(10% & 40%)
Sodium Hydroxide Flake

*May cause slight lightening.

SWANSTONE

SPECIFICATIONS AND TECHNICAL DATA SHEET

PROPERTY TEST	TYPICAL RESULTS	TEST
Impact Resistance	No damage 1-1/2 Diameter Steel Ball. Over 72"	NEMA LD-3
Izod Impact Method A (with notch) Method E (reverse notch)	3.0 ft. - lb./in. 4.0 ft. - lb./in.	ASTM D256 ASTM D256
Stain Resistance	Passes	CSA B45.5/IAPMO Z124-2011
Cigarette Resistance	Passes	CSA B45.5/IAPMO Z124-2011
Boiling Water Resistance	No effect	NEMA LD-3
High Temperature Resistance	Slight effect	NEMA LD-3
Abrasion Assistance	Passes	ASTM D4060
Color Fastness and Aging	No change	NEMA LD-3
Tensile Strength	4439 PSI	ASTM D638
Tensile Modulus	7.48 x 10 ⁵ PSI	ASTM D638
Tensile Elongation	.45%	ASTM D638
Hardness	Barcol Hardness: 51 Rockwell RB Hardness: 60.5 15-T Hardness: 34.7	ASTM D2583
Slip Resistance	Passes	ASTM F462
Fungus Resistance	Passes: 0 growth	ASTM G21-96
Bacterial Resistance	Passes: 0 growth	ASTM G22-90
Wear and Cleanability	Passes	CSA B45.5/IAPMO Z124-2011
Flexural Strength	8225 PSI	ASTM D790
Flexural Modulus	7.49 x 10 ⁵ PSI	ASTM D790
Thermal Expansion	1.23 x 10 ⁻⁵ in/in/°F	ASTM D696
Gloss (60°)	40	NEMA LD3
Water Absorption	.321%	ASTM D570
Specific Gravity	1.55	

FLAMMABILITY

Flame Spread Index	Meets Class A	ASTM E84
Smoke Developed Index	85	ASTM E84
Fire Rating	Class A	

Approximate weight per square foot 2 lbs. for 1/4" sheet. See product guide for actual weights.

RATINGS AND LISTINGS

American National Standard
Institute-ANSI Z124.3 and Z124.6

National Plumbing Code of Canada
CSA B45 Series

International Association
of Plumbing and
Mechanical Officials
(IAPMO)-listed

New York City Material Acceptance
Application #298-88-M

Housing and Urban Development
-HUD UM 73 Certified

Swanstone® is NSF
Standard 51 Certified for
Both Food and Splash
Zone Applications

TECHNICAL SERVICES

Please call (800) 325-7008 or email us at help@swanstone.com. Visit Swanstone.com for details, including specifications and drawings.



VERITEK

SPECIFICATIONS AND TECHNICAL DATA SHEET

Product

Veritek compression molded products.

Manufacturer

Swan is headquartered in St. Louis, Missouri with manufacturing in Centralia, Illinois.

Product Composition

Veritek® is a compression-molded material with no surface coating to chip or crack. It's a non-porous material that will not mold or mildew.

Product Category

Veritek® is available in bathtubs, bath walls and shower pans.

Colors

White (010), Bisque (018), Bone (037) and for some product, Flock (033). Please review products individually for color offerings.

Warranties

Veritek® wall panels, bathtubs, and shower pans are covered by a limited lifetime warranty for residential applications. For commercial applications, Swan offers the following warranties: five year Limited Warranty on bathtubs, bath walls, and shower pans. Complete details on these warranties are available on our website: swanstone.com.

Maintenance

The Veritek® finish is stain and abrasion resistant; however, the finish requires reasonable care. Clean regularly with common household liquid cleaners and a sponge or soft cloth. For hard water stains, scale removers can be used. To protect finish, fiberglass wax or automotive paste wax can be applied. Do not use abrasive cleaners or scouring pads. Do not use "leave on" cleaning products, such as automatic spray shower cleaners. Prolonged contact with harsh chemicals could have an adverse reaction over time and discolor surfaces. Do not use cleaning agents that caution use on acrylic, polyester or plastics.

Limitations

Veritek® products are not recommended for exterior use. Follow all recommended installation procedures provided by the manufacturer.

Finish

Natural-gloss

Cost

Cost varies with product category. Contact your local distributor for applicable costs.

Installation

Veritek® products are shipped with complete installation manuals provided with every unit. Consult the specific product installation manual for step-by-step installation procedures. All manuals are available through Swan or your local distributor.

PROPERTY

Impact Resistance on wall surrounds

Loads on wall surrounds

Izod Impact

Method A (with notch)
Method B (rev. notch)

Stain Resistance

Cigarette Resistance

Boiling Water Resistance

Chemical Resistance

High Temperature Resistance

Color Fastness Test

Thermal Conductivity

Tensile Strength

Tensile Modules

Elongation

Hardness

Bacterial Resistance

Wear and Cleanability

Flexural Strength

Flexural Modules

Thermal Expansion

Gloss (60°)

Water Absorption

Specific Gravity

FLAMMABILITY

Ignition Test

Flame Spread

TYPICAL RESULT

No cracks (10 lbs dropped 48" on unit)

No cracks (25 lbs. for one minute repeated at 2 minute intervals)

Passes

Passes

Passes

Passes

Passes

Passes

Passes

Class I

TEST

ANSI-Z 124.1.2

ANSI-Z 124.1.2

ASTM D256

ANSI-Z 124.1.2

ANSI-Z 124.1.2

ANSI-Z 124.1.2

NEMA LD3

ASTM D2565

ASTMD3-3.08

ASTM 638

ASTM D-638

ASTM D-638

ASTM D-638

ASTM D-785

ASTM G-22

ANSI-Z 124.1.2

ASTM D-790

ASTM D-638

ASTM D-696

NEMA LD3

ASTM D-570

N/A



LIMITED WARRANTY

INFORMATION

Limited Warranty For Residential Applications

If a Swanstone product covered by this warranty is found to be defective in materials or workmanship, after inspection by an authorized Swan representative, we will repair, or at our option, exchange the product for a similar model. This warranty extends for a designated period of time, so long as it remains in use in its original place of installation.

This warranty covers only products installed in accordance with Swan's installation instructions, used as recommended, and not damaged due to misuse, abuse or improper installation. Gloss reduction and scratching of the finish over time due to use, cleaning practices or water or atmospheric conditions are not manufacturing defects but are indicative of normal wear and tear. It does not apply to any seams or changes made to the product by professional tradesmen or fabricators.

The warranty applies only to the original purchaser and installation of these products in residential applications. It does not apply to commercial applications.

Swan's option to repair or exchange products under this warranty does not cover any labor or other costs of removal or installations, nor shall Swan be responsible for any other incidental or consequential damages attributable to a product defect or to the repair or exchange of a defective product.

Limited Lifetime Warranty

SWANSTONE KITCHEN SINKS
GRANITE KITCHEN SINKS
SWANSTONE VANITY TOPS AND BOWLS
SWANSTONE BATH WALLS AND ACCESSORIES
SWANSTONE SHOWER PANS
SWANSTONE WAINSCOTING
VERITEK® BATH WALLS
VERITEK® SHOWER PANS
VERITEK® BATHTUBS
VERITEK® ALCOVE WALLS
SWANSTONE VANITY TOP BLANKS
SWANSTONE VESSEL SINK
SWANSTONE UTILITY SINKS

15-Year Limited Warranty

VERITEK® PRO TUBS
VERITEK® PRO TUB SHOWERS
VERITEK® PRO SHOWER PANS
VERITEK® PRO SHOWERS
VERITEK® PRO WALLS

10-Year Limited Warranty

SWANSTONE COUNTERTOPS

1-Year Limited Warranty

VERITEK® LAUNDRY AND MOP SINKS

Limited Warranty For Commercial Applications

If a Swanstone product covered by this warranty is found to be defective in materials or workmanship, after inspection by an authorized Swan representative, we will repair, or at our option, exchange the product for a similar model. This warranty extends for a designated period of time, so long as it remains in use in its original place of installation.

This warranty covers only products installed in accordance with Swan's installation instructions, used as recommended, and not damaged due to misuse, abuse or improper installation. Gloss reduction and scratching of the finish over time due to use, cleaning practices or water or atmospheric conditions are not manufacturing defects but are indicative of normal wear and tear. It does not apply to any seams or changes made to the product by professional tradesmen or fabricators.

The warranty applies only to the original purchaser and installation of these products in commercial applications.

Swan's option to repair or exchange products under this warranty does not cover any labor or other costs of removal or installations, nor shall Swan be responsible for any other incidental or consequential damages attributable to a product defect or to the repair or exchange of a defective product.

30-Year Limited Warranty

SWANSTONE VANITY TOPS AND BOWLS
SWANSTONE BATH WALLS AND ACCESSORIES
SWANSTONE WAINSCOTING
SWANSTONE VANITY TOP BLANKS
SWANSTONE VESSEL SINK
SWANSTONE SHOWER PANS
SWANSTONE PERFORMIX TRENCH BASES

10-Year Limited Warranty

SWANSTONE KITCHEN SINKS
GRANITE KITCHEN SINKS
SWANSTONE COUNTERTOPS

5-Year Limited Warranty

VERITEK® BATH WALLS
VERITEK® SHOWER PANS
VERITEK® BATHTUBS
VERITEK® ALCOVE WALLS
SWANSTONE UTILITY SINKS

3-Year Limited Warranty

VERITEK® PRO TUBS
VERITEK® PRO TUB SHOWERS
VERITEK® PRO SHOWER PANS
VERITEK® PRO SHOWERS
VERITEK® PRO WALLS

1-Year Limited Warranty

VERITEK® LAUNDRY AND MOP SINKS





Building Better Surfaces | swanstone.com