

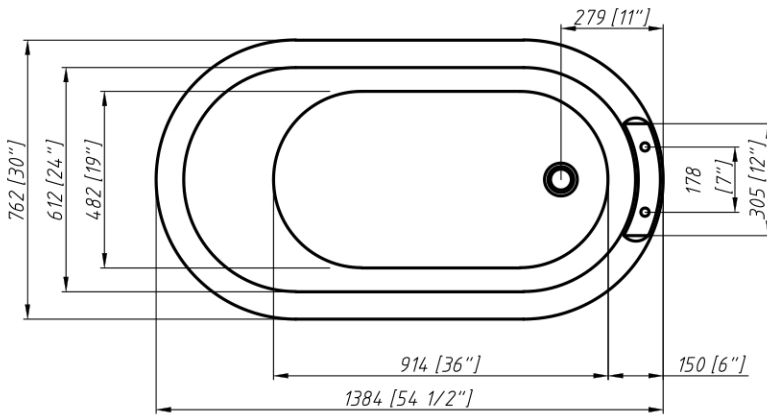

MAIDSTONE

www.MaidstoneSupply.com

Acry Hull Slipper Rim Drill Part No: 1202SL54-7

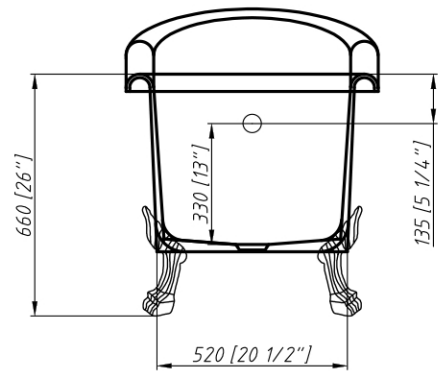
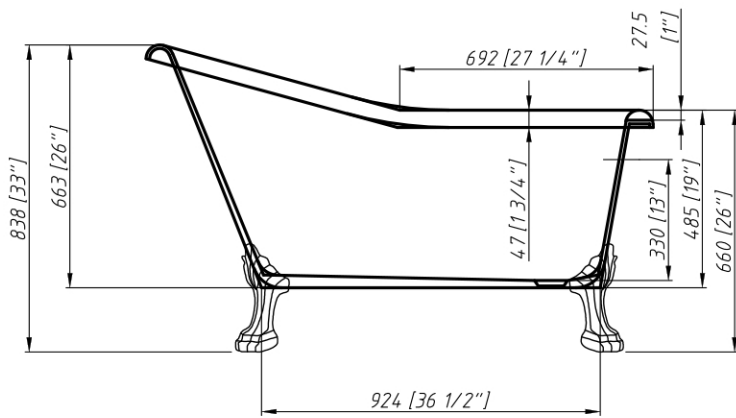

Measurement 尺寸范围	Tolerance 公差
<100mm	±2mm
100≤1000mm	±20mm
>1000mm	±20mm

Contact Maidstone for additional information and specifications. For complete warranty information and a list of dealers visit www.MaidstoneSupply.com. All products and specifications are subject to change without notice. Maidstone is not responsible for typographical and/or dimensional errors. Typographical errors are subject to correction.

Note: Rough-in dimensions may vary +/- 1/2" and are subject to change. No responsibility is assumed by Maidstone.