

NAPOLEON<sup>®</sup>  
U.S. PRICING



# PRICE BOOK

EFFECTIVE: MARCH 15, 2016  
REVISED DATE: MAY 19, 2016



Part # W415-0409  
Replaces All Previous Versions



WOLF STEEL LTD.  
 24 Napoleon Road, Barrie, Ontario, Canada L4M 0G8  
 Tel: (705) 721-1212  
 www.napoleonfireplaces.com  
 Order Desk Tel: 1-888-721-7253  
 Order Desk Fax: 1-877-725-7120



## TABLE OF CONTENTS

DESCRIPTION	IGNITION SYSTEM		PAGE #
	Pilot	Electronic	
<b>WHILE SUPPLIES LAST</b>			
1100,1900 (Huntsville™ Series)			5-6
1150M (Wood Gourmet™)			7
<b>GAS STOVES</b>			
GDS20NSB (Arlington™)	✓		8
GDS25NSB (Bayfield™)		✓	9
GDS26NSB (Castlemore™)		✓	10
GDS28-1NSB (Haliburton™)	✓		11
GDS50-1NSB (Havelock™)	✓		12
GDS60-1NSB (Knightsbridge™)		✓	13
GVFS20 (Arlington™ VF)	✓		14
GVFS60-1N (Knightsbridge™ VF)	✓		15
<b>GAS FIREPLACES</b>			
Ascent Series B30 (Ascent™ 30)	✓	✓	16
Ascent Series B35 (Ascent™ 35)	✓	✓	17
Ascent Series B36 (Ascent™ 36)			18
Ascent Series B42 (Ascent™ 42)	✓	✓	19
Ascent Series B46 (Ascent™ 46) <b>NEW</b>	✓	✓	20
BL36NTE (Linear 36)		✓	21
Ascent Series BHD4 (Ascent™ Multi-view)		✓	22-23
Ascent X GX36	✓	✓	24
Ascent X GX70	✓	✓	25
BGD36CFGN-2 (Crystallo™) <b>NEW</b>		✓	26
BGD36CFNTRSB (Grandville™)	✓		27
GD19NSB (Vittoria™)	✓	✓	28
GD82NT-PASB (Park Avenue™)		✓	29
GD82NT-TE (Tureen™)		✓	30
GT8 (Torch™) & GSST8 (Outdoor Torch™)		✓	31
GVF36 (Grandville™ VF36)	✓		32
GVF42 (Grandville™ VF42)	✓		33
GVFT8 (Torch™ VF)		✓	34
HD35NT-1 - High Definition Clean Face Series <b>NEW</b>		✓	35
HD40NT-1 - High Definition Clean Face Series <b>NEW</b>		✓	36
HD46NT-1 - High Definition Clean Face Series <b>NEW</b>		✓	37
HD81NSB - High Definition See Thru		✓	38
HDX35NT (STARfire™ 35)		✓	39
HDX40NT-2 (STARfire™ 40) <b>NEW</b>		✓	40
HDX52NT-1 (STARfire™ 52)		✓	41
HDX52PT-1 (STARfire™ 52)		✓	42
LHD45NSB (VECTOR™)		✓	43-44
LHD62NSB (VECTOR™)		✓	45
LV38 (VECTOR™) <b>NEW</b>		✓	46
LV50-1 (VECTOR™) <b>NEW</b>		✓	47
WHD31NSB - (Plazmafire™) Wall Hanging Fireplace		✓	48
WHVF31 / WHVF24 (Plazmafire™)		✓	49
<b>INSERTS</b>			
GI3600NSB (Roxbury™)	✓		50-51
GDIZC-NSB (Inspiration™)	✓		52-53
GDI-30NSB (Roxbury™)	✓		54-55
IR3/IR3G/XIR3 (Infrared Series)		✓	56-57
XIR4 (Infrared Series)		✓	58
<b>GAS LOG SETS</b>			
GL18E/GL24E/GL30E - Vented (Fiberglow™ Series)		✓	59
GL22/GL28/GL32 - Vented (Reversible Series)		✓	60
GVFL (Fiberglow™ Vent Free Series)	✓		61

WOLF STEEL LTD.  
 24 Napoleon Road, Barrie, Ontario, Canada L4M 0G8  
 Tel: (705) 721-1212  
 www.napoleonfireplaces.com  
 Order Desk Tel: 1-888-721-7253  
 Order Desk Fax: 1-877-725-7120



TABLE OF CONTENTS

DESCRIPTION	PAGE #
<b>VENT FREE FIREBOX</b>	
ZCVF36 / ZCVF42	62
<b>WOOD BURNING</b>	
S Series	63
1400 (Huntsville™ Series)	64-65
1450 (Independence™)	66
1100C and 1400C (Banff™ Series)	67
EPI3 (Oakdale™)	68
EPI-1101M (Oakdale™)	69
EPI-1402 (Oakdale™)	70
NZ6000-1 (High Country™ Series)	71
NZ7000 (High Country™ Series)	72
NZ8000 (High Country™ Series)	73
<b>Timberwolf</b> 2100/2200/2300 & EPI22 Wood Burning Stoves & Insert	74
<b>KEENAN MANTEL COLLECTION</b>	
Mantels	75
Shelves	76
<b>PELLET PRODUCTS</b>	
NPS45 (Eco Pellet Series)	77
NPI45 (Eco Pellet Series)	78
<b>Timberwolf</b> Pellet Stove (TPS35) & Pellet Insert (TPI35)	79
<b>VENTING COMPONENTS</b>	
DV Fireplace Venting Components 4"X7"	80
DV Fireplace Venting Components 5"X8"	81
DV Fireplace Venting Components 8"X10" & 8"X11"	82
DV Stoves Venting Components	83
DV Rigid Venting 4"X7"	84
GPV Gas Power Vent Kit (for Direct Vent Gas Fireplaces)	85
Compressed Aluminum Gas Liner	86
<b>OUTDOOR PRODUCTS</b>	
GSS36N Outdoor Gas Fireplace (Riverside™ Series)	87
GSS42N Outdoor Gas Fireplace (Riverside™ Series)	88
GSS48 Outdoor Gas Fireplace (Linear) (Galaxy™ Series)	89
GPF Outdoor Patioflame	90
<b>MAP POLICY</b>	
	91-92

TERMS: NET 30 DAYS on approved credit, 2% monthly service charge on overdue accounts.  
 All products remain the property of Wolf Steel Ltd. until fully paid.  
 All taxes extra.  
 FOB Wolf Steel Ltd. warehouse



While Supplies Last

Effective: March 15, 2016

1100, 1900 HUNTSVILLE™

**1100, 1900 HUNTSVILLE™ DELUXE EPA WOOD BURNING STOVES**

Venting 6"

- Pedestal
- Louvres
- Black trivet
- Ash pan w/ lid

**BLACK PAINTED LOUVRES ARE STANDARD ON PEDESTAL UNITS ONLY.**

**NOTE: DOOR MUST BE ORDERED SEPARATELY.**

US \$

Product	Model Description	Finish	WT/lbs.	MSRP/MAP
 1100M	Small wood stove	Metallic black	330	\$1,589
1100K-1	Small wood stove porcelain enamel	Black - <b>Limited Quantities Available</b>	330	\$2,089
1900M	Large wood stove	Metallic black	435	\$2,249
1900K-1	Large wood stove porcelain enamel	Black - <b>Limited Quantities Available</b>	435	\$2,839



**MODEL EPA STOVE WITH LEG OPTIONS**

**NOTE: DOOR AND LEGS MUST BE ORDERED SEPARATELY.**

**UNIT INCLUDES: REAR SHIELD WITH HOT AIR CIRCULATION DEFLECTOR.**



Product	Model Description	Finish	WT/lbs.	MSRP/MAP
 1100ML	Small wood stove	Metallic black	305	\$1,029
200M	Traditional steel legs	Metallic black	8	\$175
202CM	Ornamental cast iron legs	Metallic black	12	\$205
202CG	Ornamental cast iron legs	Gold plated (24 karat) - <b>Limited Quantities Available</b>	12	\$485
202CSS	Ornamental cast iron legs	Stainless Steel	12	\$485
*115KT	Outside air kit, 4ft. Insul. Flex and through the wall vent		2	\$85
EPAD-1KT	Ash drawer kit (suitable for - 1 leg models only)	<b>Limited Quantities Available</b>	8	\$215
EPAD-KTM	Ash drawer kit (suitable for - 1 leg models only)	Metallic black	8	\$215

**DOORS (Matching spring handles for door and air control are included with door)**

Product	Model Description	Finish	WT/lbs.	MSRP/MAP
 H222M	Cast iron door - standard arch	Metallic black	25	\$305
H222-G	Cast iron door - standard arch	Gold plated (24 Karat)	25	\$535
H222-SS	Cast iron door - standard arch	Satin chrome plated	25	\$535
 H222-GW	Cast iron door - Early American webbed arch	<b>Limited Quantities Available</b>	25	\$569

**OPTIONS/ACCESSORIES**

**DECORATIVE**

Product	Model Description	Finish	WT/lbs.	MSRP/MAP
 CL28G	Louvres and acrylic trim for pedestal models	Gold plated (24 karat) - <b>Limited Quantities Available</b>	1	\$85
CL28SS	Louvres and acrylic trim for pedestal models	Satin chrome plated - <b>Limited Quantities Available</b>	1	\$85
 GS200-G	Ornamental trivet for model 1100	Gold plated (24 Karat)	1	\$109
GS200-SS	Ornamental trivet for model 1100	Satin chrome plated	1	\$109
CM30	COOKMATE (fits 1400 and 1900 pedestal series only)		6	\$159
 W325-0043	Spring door handle (large)	Black	1	\$9
W325-0045	Spring door handle (large)	Brass	1	\$9
W325-0033	Spring door handle (large)	Satin chrome	1	\$9
W325-0042	Spring air control handle (small)	Black	1	\$9
W325-0044	Spring air control handle (small)	Brass	1	\$9
W325-0032	Spring air control handle (small)	Satin chrome	1	\$9
W470-0002	Enamel touch up and brush (Specify colour)		1	\$15
270-BULK	Paint, ThurmaloX -Case of 12, black 13 oz.		12	\$235
209M-BULK	Paint, Forrest - metallic black 12 oz. (Case of 12)		1	\$300

\*115KT Requires EPAD-KT to complete Outside Air Connection - Suitable for Leg Models Only



While Supplies Last

Effective: March 15, 2016

1100, 1900 HUNTSVILLE™

**1100, 1900 HUNTSVILLE™ DELUXE EPA WOOD BURNING STOVES**

**CONTINUED**

<b>HEAT CIRCULATION</b>				
<b>Product</b>	<b>Model Description</b>	<b>Finish</b>	<b>WT/lbs.</b>	<b>MSRP/MAP</b>
EPLK	Air circulation chamber louvres (for "L" models only)	Painted black - <b>Limited Quantities Available</b>	2	\$59
EPLM	Air circulation chamber louvres (for "L" models only)	Metallic black	2	\$59
EPLG	Air circulation chamber louvres (for "L" models only)	Gold plated (24 karat) - <b>Limited Quantities Available</b>	2	\$119
EPLSS	Air circulation chamber louvres (for "L" models only)	Satin chrome plated - <b>Limited Quantities Available</b>	2	\$95
	EP62-1	Variable speed blower <b>Limited Quantities Available</b>	5	\$269
	EP62M	Variable speed blower	5	\$269
EP36	Thermostatic sensor control		1	\$49
W320-0011M	Blower guard (for "L" models only)	Metallic black	1	\$25
111KT	Outside air kit, 4ft. Insul. Flex and through the wall vent		2	\$95
W500-0064M-SER	Fresh air cover plate (for pedestal models only)	Metallic black	1	\$25
<b>MISC</b>				
62140	Heat Resistant Gloves		1	\$55

\* Note: IF using the EP62-1 blower on a woodstove WITH LEGS then the blower guard W320-0011M must be installed



While Supplies Last

Effective: March 15, 2016

1150M WOOD GOURMET™

**1150M EPA WOOD GOURMET™ COOK STOVE**

*Venting 6"*

- Cast iron cook top surface
- Pot fender to guard cookware on surface
- Pedestal with wood storage
- Removable hot plate and lifter with designated "hot zones"
- Ash pan with stainless steel handle
- Crilaplastic chrome color pedestal trim
- Flush top design for Easy Slide™ pan
- Refractory lined firebox

US \$

	Product	Model Description	Finish	WT/lbs.	MSRP/MAP
	1150M	EPA Wood Gourmet™ cook stove	Metallic black	430	\$2,679

**OPTIONS/ACCESSORIES**

**DECORATIVE**

**DOORS**

	Product	Model Description	Finish	WT/lbs.	MSRP/MAP
	H222M	Cast iron door - standard arch	Metallic black	25	\$305
	H222-SS	*Cast iron door - standard arch	Satin chrome plated	25	\$535
	W325-0033	Spring door handle (large)	Satin chrome plated	1	\$9
	W325-0032	Spring door handle (small)	Satin chrome plated	1	\$9
	270-BULK	Paint, ThurmaloX -Case of 12, black 13 oz.		12	\$235
	209M-BULK	Paint, Forrest - metallic black 12 oz. (Case of 12)		1	\$300

**HEAT CIRCULATION**

	Product	Model Description	Finish	WT/lbs.	MSRP/MAP
	EP65M	Blower kit with variable speed and thermostatic control	Metallic black	7	\$309
	111KT	Outside air kit (4ft. Insul.flex with through the wall vent)		2	\$95

**MISC**

	62140	Heat Resistant Gloves		1	\$55
--	-------	-----------------------	--	---	------

\* Note: Matching spring handles for door and air control are included with door



Effective: March 15, 2016

## GDS20NSB ARLINGTON™

### GDS20NSB ARLINGTON™ DIRECT VENT CAST IRON GAS STOVE (45° VENT)

Tested as a heater to ANSI Z21.50 and CSA 2.22

Venting - 4" & 7"

- Millivolt ignition
- Built-in adjustable flame heat control
- On/off switch and safety "pilot on" indicator light
- Porcelain reflective rear panel
- Piezo ignitor
- Ember bed and logs
- Exclusive Phazeramic™ burner
- Ceramic glass
- Safety barrier
- Mobile home approved
- Up to 20,000 BTU's
- 50% Flame/heat adjustment

US \$

	Product	Model Description	Finish	WT/lbs.	MSRP/MAP
	GDS20NSB	Arlington™ cast iron stove - Natural gas (With Safety Barrier)	Painted black	160	\$1,739
	GDS20NNSB	Arlington™ cast iron stove - Natural gas (With Safety Barrier)	Porcelain majolica brown	160	\$2,179
	W175-0234	Conversion kit - Natural gas to propane		2	\$55
	FC-12	12" stainless steel gas flex connector & shut off (25/crtn)		18	\$535

### OPTIONS/ACCESSORIES

#### DECORATIVE

	GS-331S	Stove top inset soapstone	Lorena slate	10	\$209
	GS-331F	Stove top inset granite	Ubatauba green	20	\$209
	270-BULK	Paint, ThurmaloX -Case of 12, black 13 oz.		12	\$235

#### HEAT CIRCULATION/VENTING

	GS-65KT	Blower kit with variable speed and thermostatic control		8	\$299
	GD-176	24" through the wall vent kit, c/w mounting plate, black trim collar, 45° elbow and terminal		8	\$279
	BM6745	7" - 45° degree elbow - MUST ORDER MULTIPLES OF 4		8	\$35

#### CONTROLS

	W660-0081	Thermostat, wall mount - digital		1	\$69
	F45	Napoleon on/off hand held battery operated remote w/digital screen		1	\$95
	F45-6	Napoleon on/off hand held battery operated remote w/digital screen - bulk of 6		7	\$535
	F60	Napoleon thermostatic hand held battery operated remote w/digital screen		1	\$149
	F60-6	Napoleon thermostatic hand held battery operated remote w/digital screen - bulk of 6		7	\$859

#### MISC

	GDSLK-KT	Leg leveling/stove securing kit		1	\$35
	RP4	Restrictor Plate (recommended for aggressive vertical venting)		2	\$25

Note: See Direct Vent Stoves - Venting Components for additional venting.

Note: Terminal extension plate (W500-0103-see venting) may be required (Refer to instructions)





Effective: March 15, 2016

## GDS25NSB BAYFIELD™

### GDS25NSB BAYFIELD™ DIRECT VENT CAST IRON GAS STOVE (45° VENT)

Tested as a heater to ANSI Z21.50 and CSA 2.22

Venting - 4" & 7"

- Electronic ignition w/ battery backup & on/off switch
- Piezo ignitor
- Safety barrier
- Built-in adjustable flame heat control
- Ember bed and logs
- Mobile home approved
- Night Light™
- Exclusive Phazeramic™ burner
- Up to 24,500 BTU's
- Stainless steel gas flex connector & shutoff
- Ceramic glass
- 50% Flame/heat adjustment
- Secondary heat exchanger

US \$

	Product	Model Description	Finish	WT/lbs.	MSRP/MAP
	GDS25NSB	Bayfield™ cast iron stove - Natural gas (With Safety Barrier)	Painted black	220	\$2,639
	GDS25NNSB	Bayfield™ cast iron stove - Natural gas (With Safety Barrier)	Porcelain majolica brown	230	\$2,949
	GDS25NWSB	Bayfield™ cast iron stove - Natural gas (With Safety Barrier)	Winter frost	230	\$2,949
	W175-0246	Conversion kit - Natural gas to propane		2	\$55
	W175-0244	Conversion kit high altitude - Natural gas to natural gas (2,000 to 4,500 ft.)		2	\$0
W175-0245	Conversion kit high altitude - Propane to propane		2	\$0	

### OPTIONS/ACCESSORIES



#### DECORATIVE

	PRP25	Porcelain reflective radiant panels (rear & sides)		5	\$145
	GDS813KT	Decorative brick panels	<b>Limited Quantities Available</b>	5	\$125
	GS-331S	Stove top inset soapstone	Lorena slate	10	\$209
	GS-331F	Stove top inset granite	Ubatuba green	10	\$209
	270	Paint, Thormalox - black 13 oz. MUST ORDER IN MULTIPLES OF 12		1	\$25

#### HEAT CIRCULATION/VENTING

	GS-65KT	Blower kit with variable speed and thermostatic control		8	\$299
	GD-176	24" through the wall vent kit, c/w mounting plate, black trim collar, 45° elbow and terminal		20	\$279
	BM6745	7" - 45 degree elbow - MUST ORDER MULTIPLES OF 4		8	\$35

#### CONTROLS

	W660-0081	Thermostat, wall mount - digital		1	\$69
	F45	Napoleon on/off hand held battery operated remote w/digital screen		1	\$95
	F45-6	Napoleon on/off hand held battery operated remote w/digital screen - bulk of 6		7	\$535
	F60	Napoleon thermostatic hand held battery operated remote w/digital screen		1	\$149
	F60-6	Napoleon thermostatic hand held battery operated remote w/digital screen - bulk of 6		7	\$859
	ACS-1	Anti-Condensation Switch		1	\$65

#### MISC

GDSLL-KT	Leg leveling/stove securing kit		1	\$35
S25-KT	Screen kit	<b>Limited Quantities Available</b>	5	\$175

Note: See Direct Vent Stoves - Venting Components for additional venting.



Effective: March 15, 2016

## GDS26NSB CASTLEMORE™

### GDS26NSB CASTLEMORE™ DIRECT VENT CAST IRON GAS STOVE (TOP OR REAR VENT)

Tested as a heater to ANSI Z21.50 and CSA 2.22



Venting - 4" & 7"

- Electronic ignition w/ battery backup & on/off switch
- Built-in adjustable flame heat control
- Stainless steel gas flex connector & shutoff
- Ember bed and logs
- Exclusive Phazeramic™ burner
- Ceramic glass
- Night Light™ w/ on/off switch
- Safety barrier
- Mobile home approved
- Up to 25,000 BTU's
- 50% Flame/heat adjustment

US \$

	Product	Model Description	Finish	WT/lbs.	MSRP/MAP
	GDS26NSB	Castlemore™ cast iron stove, with standard glass - Natural gas (With Safety Barrier)	Metallic black	245	\$3,159
	GDS26NNSB	Castlemore™ cast iron stove, with standard glass - Natural gas (With Safety Barrier)	Porcelain majolica brown	245	\$3,579
	GDS26NMSB	Castlemore™ cast iron stove, with standard glass - Natural gas (With Safety Barrier)	Summer moss	245	\$3,579
	GDS26NWSB	Castlemore™ cast iron stove, with standard glass - Natural gas (With Safety Barrier)	Winter frost	245	\$3,579
	W175-0268	Conversion kit - Natural gas to propane		2	\$55

### OPTIONS/ACCESSORIES

DECORATIVE					
	PRP19	Porcelain reflective radiant panels (rear & sides)		10	\$145
	GD839KT	Decorative brick/stone panels	Sandstone	6	\$129
	GS332F	Stove top inset granite for rear vent only (recommended)	Ubatuba green	17	\$209
	GS332N	Stove top inset granite for rear vent only (recommended)	Giallo golden brown	17	\$209
	W470-0017A	Paint, Wrought Iron 13 oz.		1	\$25
209M-BULK	Paint, Forrest - metallic black 12 oz. (Case of 12)		1	\$300	
HEAT CIRCULATION/VENTING					
	GD177	24" through the wall vent kit, c/w mounting plate, black trim collar and terminal		20	\$225
	GS67	Fan kit with variable speed & thermostatic control		5	\$195
	RP4	Restrictor Plate (recommended for aggressive vertical venting)		2	\$25
CONTROLS					
	W660-0081	Thermostat, wall mount - digital		1	\$69
	F45	Napoleon on/off hand held battery operated remote w/digital screen		1	\$95
	F45-6	Napoleon on/off hand held battery operated remote w/digital screen - bulk of 6		7	\$535
	F60	Napoleon thermostatic hand held battery operated remote w/digital screen		1	\$149
	F60-6	Napoleon thermostatic hand held battery operated remote w/digital screen - bulk of 6		7	\$859
	ACS-1	Anti-Condensation Switch		1	\$65

Note: See Direct Vent Stoves - Venting Components for additional venting.



Effective: March 15, 2016

## GDS28-1NSB HALIBURTON™

### GDS28-1NSB HALIBURTON™ DIRECT VENT/B VENT GAS STOVE (TOP VENT)

Tested as a heater. Direct vent and b-vent models meet department of energy requirements as a wall furnace tested to both ANSI Z21.86, Z21.88 and CSA 2.32 and CSA 2.33

Venting - 4" & 7"

- Millivolt ignition
- Built-in adjustable flame heat control
- Stainless steel gas flex connector & shutoff
- Ornamental inset and trivet
- Metallic black accent bar
- Exclusive Phazer® log set & embers
- Heat circulating blower & thermostat
- Triple flame burner
- Piezo ignitor
- Mobile home approved
- Up to 30,000 BTU's

NOTE: All units are natural gas. If propane is required - please order conversion kit.



US \$



Product	Model Description	Finish	WT/lbs.	MSRP/MAP
 GDS28-1NSB	Direct vent gas stove - Pedestal - Natural gas		110	\$2,309
W175-0124	Conversion kit - Natural gas to propane		2	\$55

**DOORS MUST BE ORDERED TO COMPLETE UNIT, SAFETY BARRIER SHIPPED COMPLETE WITH DOOR**

 GS328KSB	Door	Painted metallic black	14	\$465
GS328GSB	Door	Gold plated (24 Karat)	14	\$685
GS328SSB	Door	Satin chrome	14	\$685

### OPTIONS/ACCESSORIES

DECORATIVE				
 GS200-G	Trivet	Gold plated (24 Karat)	1	\$109
GS200-SS	Trivet	Satin chrome plated	1	\$109
 AR28G	Accent bar/acrylic trim	Gold plated (24 Karat)	1	\$65
AR28SS	Accent bar/acrylic trim	Satin chrome plated	1	\$65
 ANI-K	Andirons	Painted black	2	\$75
ANI-G	Andirons	Gold plated (24 karat) - Limited Quantities Available	2	\$149
209M-BULK	Paint, Forrest - metallic black 12 oz. (Case of 12)		1	\$300

CONTROLS				
 W660-0081	Thermostat, wall mount - digital		1	\$69
 F45	Napoleon on/off hand held battery operated remote w/digital screen		1	\$95
F45-6	Napoleon on/off hand held battery operated remote w/digital screen - bulk of 6		7	\$535
F60	Napoleon thermostatic hand held battery operated remote w/digital screen		1	\$149
F60-6	Napoleon thermostatic hand held battery operated remote w/digital screen - bulk of 6		7	\$859

Note: See Direct Vent Stoves - Venting Components for B-Vent adaptor kit.



Effective: March 15, 2016

## GDS50-1NSB HAVELOCK™

### GDS50-1NSB HAVELOCK™ DIRECT VENT/B VENT GAS STOVE (TOP VENT)



Tested as a heater. Direct vent and b-vent models meet department of energy requirements as a wall furnace tested to both ANSI Z21.86, Z21.88 and CSA 2.32 and CSA 2.33.

Venting - 4" & 7"





<ul style="list-style-type: none"> <li>• Millivolt ignition</li> <li>• Built-in adjustable flame heat control</li> <li>• Stainless steel gas flex connector &amp; shutoff</li> <li>• Exclusive Phazer® log set &amp; embers</li> <li>• Heat circulating blower w/variable speed control</li> </ul>	<ul style="list-style-type: none"> <li>• Metallic black accent bar</li> <li>• Ornamental inset trivet</li> <li>• Ceramic glass</li> <li>• Triple flame burner including turbo burner</li> </ul>	<ul style="list-style-type: none"> <li>• Piezo ignitor</li> <li>• Mobile home approved</li> <li>• 30,000 BTU with 14,000 BTU Turbo Boost Burner</li> </ul>
--	---	--

NOTE: All units are natural gas. If propane is required - please order conversion kit.

US \$

Product	Model Description	Finish	WT/lbs.	MSRP/MAP
	GDS50-1NSB Direct vent gas stove - Natural gas		250	\$2,879
	W175-0231 Conversion kit - Natural gas to propane		2	\$55
	W175-0061 Conversion Kit high altitude - Natural gas to natural gas		2	\$0
<b>DOORS MUST BE ORDERED TO COMPLETE UNIT, SAFETY BARRIER SHIPPED COMPLETE WITH DOOR</b>				
	GS350KSB Door	Painted metallic black	20	\$485
	GS350GSB Door	Gold plated (24 Karat)	20	\$709
	GS350SSB Door	Satin chrome	20	\$709

#### OPTIONS/ACCESSORIES

DECORATIVE					
	AR50G	Accent bar/acrylic trim	Gold plated (24 Karat)	1	\$69
	AR50SS	Accent bar/acrylic trim	Satin chrome plated	1	\$69
	ANI-K	Andirons painted black	Painted black	2	\$75
	209M-BULK	Paint, Forrest - metallic black 12 oz. (Case of 12)		1	\$300
CONTROLS					
	W660-0081	Thermostat, wall mount - digital		1	\$69
	F45	Napoleon on/off hand held battery operated remote w/digital screen		1	\$95
	F45-6	Napoleon on/off hand held battery operated remote w/digital screen - bulk of 6		7	\$535
	F60	Napoleon thermostatic hand held battery operated remote w/digital screen		1	\$149
	F60-6	Napoleon thermostatic hand held battery operated remote w/digital screen - bulk of 6		7	\$859

Note: See Direct Vent Stoves - Venting Components for B-Vent adaptor kit.



Effective: March 15, 2016

## GDS60-1NSB KNIGHTSBRIDGE™

### GDS60-1NSB KNIGHTSBRIDGE™ DIRECT VENT/B VENT CAST IRON GAS STOVE (TOP OR REAR VENT)

Tested as a heater. Direct vent meets department of energy requirements as a wall furnace tested to ANSI Z21.86 and CSA 2.32 as well as ANSI Z21.50 and CSA 2.22

Venting - 4" & 7"





- Electronic ignition w/ battery backup & on/off switch
- Exclusive Phazer™ log set & embers
- Safety barrier
- Built-in adjustable flame heat control
- Cast iron door w/ ceramic glass
- Mobile home approved
- Up to 35,000 BTU's

**NOTE: All units are natural gas. If propane is required - please order conversion kit.**

US \$

Product	Model Description	Finish	WT/lbs.	MSRP/MAP
 GDS60-1NSB	Cast iron stove with door - Natural gas (With Safety Barrier)	Painted metallic black	170	\$2,799
GDS60-1NNSB	Cast iron stove with door - Natural gas (With Safety Barrier)	Porcelain majolica brown	170	\$3,259
W175-0318	Conversion kit - Natural gas to propane		12	\$55
FC-12	12" stainless steel gas flex connector & shut off (25/crtn)		18	\$535

#### OPTIONS/ACCESSORIES

DECORATIVE				
 GDS819KT	Decorative brick panels	Sandstone	5	\$125
 GS831K	Trivet (required when installing a "rear vent")	Painted black	2	\$85
 ANI-K	Andirons	Painted black	2	\$75
209M-BULK	Paint, Forrest - metallic black 12 oz. (Case of 12)		1	\$300
HEAT CIRCULATION				
 GS-64KT	Blower kit with variable speed and thermostatic control		8	\$299
CONTROLS				
 W660-0081	Thermostat, wall mount - digital		1	\$69
F45	Napoleon on/off hand held battery operated remote w/digital screen		1	\$95
F45-6	Napoleon on/off hand held battery operated remote w/digital screen - bulk of 6		7	\$535
F60	Napoleon thermostatic hand held battery operated remote w/digital screen		1	\$149
F60-6	Napoleon thermostatic hand held battery operated remote w/digital screen - bulk of 6		7	\$859
MISC				
GDSLL-KT	Leg leveling/stove securing kit		1	\$35
RP4	Restrictor Plate (recommended for aggressive vertical venting)		2	\$25

Note: See Direct Vent Stoves - Venting Components for B-Vent adaptor kit.



## GVFS20 ARLINGTON™

### GVFS20 ARLINGTON™ VENT FREE CAST IRON GAS STOVE





Tested as a heater to the unvented heating standard ANSI Z21.11.2B

• Millivolt ignition	• Piezo ignitor	• Safety barrier
• Built-in adjustable flame heat control	• Ember bed and logs	• Mobile home approved
• On/off switch and safety "pilot on" indicator light	• Exclusive Phazeramic™ burner	• Up to 23,000 BTU's
• Porcelain reflective rear panel	• Oxygen depletion sensor (ODS)	

US \$

	Product	Model Description	Finish	WT/lbs.	MSRP/MAP
	GVFS20N	Arlington™ cast iron stove - Natural gas	Painted black	160	\$1,609
	GVFS20P	Arlington™ cast iron stove - Propane	Painted black	160	\$1,609
	FC-12	12" stainless steel gas flex connector & shut off (25/crtn)		18	\$535

### OPTIONS/ACCESSORIES

DECORATIVE					
	GS-331S	Stove top inset soapstone	Lorena slate	10	\$209
	GS-331F	Stove top inset granite	Ubatuba green	10	\$209
	270-BULK	Paint, Thuralox -Case of 12, black 13 oz.		12	\$235
HEAT CIRCULATION					
	GS-65KT	Blower kit with variable speed and thermostatic control		8	\$299
CONTROLS					
	W660-0081	Thermostat, wall mount - digital		1	\$69
	F45	Napoleon on/off hand held battery operated remote w/digital screen		1	\$95
	F45-6	Napoleon on/off hand held battery operated remote w/digital screen - bulk of 6		7	\$535
	F60	Napoleon thermostatic hand held battery operated remote w/digital screen		1	\$149
	F60-6	Napoleon thermostatic hand held battery operated remote w/digital screen - bulk of 6		7	\$859
MISC					
	GDSLL-KT	Leg leveling/stove securing kit		1	\$35



GVFS60-1N KNIGHTSBRIDGE™

**GVFS60-1N KNIGHTSBRIDGE™ VENT FREE CAST IRON GAS STOVE**

Tested as a heater to the unvented heating standard ANSI Z21.11.2B

• Millivolt ignition	• Exclusive Phazer® log set & embers	• Oxygen depletion sensor (ODS)
• Built-in adjustable flame heat control	• Pan type burner	• Mobile home approved
• Piezo ignitor	• Black painted trivet	• Up to 30,000 BTU's

US \$

	Product	Model Description	Finish	WT/lbs.	MSRP/MAP
	GVFS60-1N	Cast iron stove body - Natural gas	Painted metallic black	170	\$2,149
	GVFS60-1NN	Cast iron stove body - Natural gas	Porcelain majolica brown	170	\$2,469
	GVFS60-1P	Cast iron stove body - Propane	Painted metallic black	170	\$2,149
	GVFS60-1PN	Cast iron stove body - Propane	Porcelain majolica brown	170	\$2,469
	FC-12	12" stainless steel gas flex connector & shut off (25/crtn)		18	\$535

**OPTIONS/ACCESSORIES**

	Product	Model Description	Finish	WT/lbs.	MSRP/MAP
<b>DECORATIVE</b>					
	GDS819KT	Decorative brick panels	Sandstone	5	\$125
	ANI-K	Andirons (not available in 24 karat gold finish)	Painted black	2	\$75
	209M-BULK	Paint, Forrest - metallic black 12 oz. (Case of 12)		1	\$300
<b>HEAT CIRCULATION</b>					
	GS-64KT	Blower kit with variable speed and thermostatic		8	\$299
<b>CONTROLS</b>					
	W660-0081	Thermostat, wall mount - digital		1	\$69
	F45	Napoleon on/off hand held battery operated remote w/digital screen		1	\$95
	F45-6	Napoleon on/off hand held battery operated remote w/digital screen - bulk of 6		7	\$535
	F60	Napoleon thermostatic hand held battery operated remote w/digital screen		1	\$149
	F60-6	Napoleon thermostatic hand held battery operated remote w/digital screen - bulk of 6		7	\$859
<b>MISC</b>					
	GDSLL-KT	Leg leveling/stove securing kit		1	\$35



Effective: March 15, 2016

## B30NTR ASCENT™ SERIES

### B30NTR ASCENT™ SERIES DIRECT VENT CLEAN FACE BUILDER GAS FIREPLACE

Certified to the test standards, ANSI Z21.50 and CSA 2.22 for vented gas fireplaces

**Venting - 4" & 7" Top and Rear Vent**

- Dual receptable junction box
- Heat resistant glass door
- 20 ft. wire
- Pan style burner
- Exclusive Phazer® log set & embers
- Mobile home approved
- Firestop
- Safety barrier
- Up to 15,000 BTU's









**NOTE: All units are natural gas. If propane is required - please order conversion kit.**

**US \$**



Product	Model Description	Finish	WT/lbs.	MSRP/MAP	
	B30NTR	Millivolt 15,000 BTU's - Natural gas	Black	80	\$1,659
	W175-0375	Conversion kit - Natural gas to propane		2	\$55
	B30NTRE	Electronic 15,000 BTU's - Natural gas	Black	82	\$1,659
	W175-0395	Conversion kit - Natural gas to propane		2	\$55
	FC-12	12" stainless steel gas flex connector & shut off (25/crtn)		18	\$535
<b>*Note: Flex Connector comes standard with electronic ignition model</b>					

### OPTIONS/ACCESSORIES

#### DECORATIVE

	PRPB30	Porcelain reflective radiant panels	Gloss black	7	\$185
	H30F	Decorative front - Heritage	Black	12	\$139
	Z30F	Decorative front - Zen	Black	12	\$139
	TK30	Basic 2" trim kit (covers opening 32 1/2" W X 34 1/2" H)	Painted black	5	\$129
	BT30K	Premium 3" bevelled trim kit	Black	6	\$179
	MKE30	Shore Fire Kit mixture of rocks, sand, vermiculite, glass and rock tray		8	\$209
<b>MUST ORDER A W655-0609K SUPPORT BRACKET IF ORDERING A DLE OR REK KIT</b>					
	W655-0609K	Support Bracket for Media Kit		2	\$19
	DLE	Beach Fire kit, 4 Driftwood Logs		4	\$155
	REK	Mineral rock kit, mixture of multi-color rocks		2	\$209
	W361-0239-BULK	AMBIENT-GLOW Fireplace Embers (master packs of 50) individual packages suggested retail of \$15.95		2	\$799
	BANB100	Kit, Builders Ajd Nailing Bracket, 100 pieces			\$155
	270-BULK	Paint, Thurmalox -Case of 12, black 13 oz.		12	\$235

#### HEAT CIRCULATION

	GA-566	Hot air distribution kit		11	\$409
	GA-72	Hot air exhaust kit (GA-566 also required)		3	\$119
	GA-70	Extension kit, 5 ft flex vent		1	\$55
	AUB	Ascent Universal Blower, Blower kit with variable speed		5	\$195

#### CONTROLS

	F45	Napoleon on/off hand held battery operated remote w/digital screen		1	\$95
	F45-6	Napoleon on/off hand held battery operated remote w/digital screen - bulk of 6		7	\$535
	F60	Napoleon thermostatic hand held battery operated remote w/digital screen		1	\$149
	F60-6	Napoleon thermostatic hand held battery operated remote w/digital screen - bulk of 6		7	\$859
	ACS-SIT	Anti-Condensation Switch (SIT electronic valve system only)		1	\$19





## B35NT ASCENT™ SERIES

### B35NT ASCENT™ SERIES DIRECT VENT CLEAN FACE BUILDER GAS FIREPLACES

Certified to the test standards, ANSI Z21.50 and CSA 2.22 for vented gas fireplaces

**Venting - 5" & 8" Top Vent**













<ul style="list-style-type: none"> <li>• Dual receptable junction box</li> <li>• Pan style burner</li> <li>• Firestop</li> </ul>	<ul style="list-style-type: none"> <li>• Heat resistant glass door</li> <li>• Exclusive Phazer® log set &amp; embers</li> <li>• Safety barrier</li> </ul>	<ul style="list-style-type: none"> <li>• 20 ft. wire</li> <li>• Mobile home approved</li> <li>• Up to 20,000 BTU's</li> </ul>
--	---	---

NOTE: All units are natural gas. If propane is required - please order conversion kit.

US \$

Product	Model Description	Finish	WT/lbs.	MSRP/MAP
 B35NT	Millivolt 20,000 BTU's - Natural gas	Black	93	\$1,759
W175-0371	Conversion kit - Natural gas to propane		2	\$55
B35NTE	Electronic 20,000 BTU's - Natural gas	Black	95	\$1,759
W175-0366	Conversion kit - Natural gas to propane		2	\$55
FC-12	12" stainless steel gas flex connector & shut off (25/crtn)		18	\$535
*Note: Flex Connector comes standard with electronic ignition model				

#### OPTIONS/ACCESSORIES

DECORATIVE					
	GD852KT	Decorative brick panels	Sandstone	10	\$259
	GD853KT	Decorative brick panels	Herringbone	13	\$259
	PRPB35	Porcelain reflective radiant panels	Gloss black	7	\$209
	H35F	Decorative front - Heritage	Black	12	\$159
	Z35F	Decorative front - Zen	Black	12	\$159
	CFF	Decorative front - Clean Face (rectangular)	Flat black	24	\$415
	X36WI	Decorative front	Wrought iron	35	\$725
	TK35	Basic 2" trim kit (covers opening 37 1/2" W X 34 1/2" H)	Painted black	5	\$129
	BT36K	Premium 3" bevelled trim kit	Black	6	\$199
	W361-0239-BULK	AMBIENT-GLOW Fireplace Embers (master packs of 50) individual packages suggested retail of \$15.95		2	\$799
	BANB100	Kit, Builders Ajd Nailing Bracket, 100 pieces			\$155
	270-BULK	Paint, Thumalox -Case of 12, black 13 oz.		12	\$235
HEAT CIRCULATION					
	GA-566	Hot air distribution kit		11	\$409
	GA-72	Hot air exhaust kit (GA-566 also required)		3	\$119
	GA-70	Extension kit, 5 ft flex vent		1	\$55
	AUB	Ascent Universal Blower, Blower kit with variable speed		5	\$195
CONTROLS					
	F45	Napoleon on/off hand held battery operated remote w/digital screen		1	\$95
	F45-6	Napoleon on/off hand held battery operated remote w/digital screen - bulk of 6		7	\$535
	F60	Napoleon thermostatic hand held battery operated remote w/digital screen		1	\$149
	F60-6	Napoleon thermostatic hand held battery operated remote w/digital screen - bulk of 6		7	\$859
	ACS-SIT	Anti-Condensation Switch (SIT electronic valve system only)		1	\$19



Effective: March 15, 2016

## B36NTR ASCENT™ SERIES

### B36NTR ASCENT™ SERIES DIRECT VENT CLEAN FACE GAS FIREPLACE (TOP OR REAR VENT)

Certified to the test standards, ANSI Z21.50 and CSA 2.22 for vented gas fireplaces

Venting - 4' & 7" Top & Rear Vent















• Dual receptable junction box	• Heat resistant glass door	• 20 ft. wire
• Pan style burner	• Exclusive Phazer® log set & embers	• Mobile home approved
• Firestop	• Safety barrier	• Up to 18,000 BTU's

NOTE: All units are natural gas. If propane is required - please order conversion kit.

US \$

Product	Model Description	Finish	WT/lbs.	MSRP/MAP
 B36NTR	Top/rear vent fireplace with black door - Natural gas	Black	96	\$1,859
W175-0387	Conversion kit - Natural gas to propane		2	\$55
B36NTRRE	Top/rear vent fireplace with black door - Natural gas - electronic ignition		98	\$1,859
W175-0399	Conversion kit (electronic ignition) - Natural gas to propane		2	\$55
FC-12	12" stainless steel gas flex connector & shut off (25/crtn)		18	\$535
<b>*Note: Flex Connector comes standard with electronic ignition model</b>				

#### OPTIONS/ACCESSORIES

DECORATIVE					
	PRPB36	Porcelain reflective radiant panels	Gloss black	7	\$209
	H35F	Decorative front - Heritage	Black	12	\$159
	Z35F	Decorative front - Zen	Black	12	\$159
	CFF	Decorative front - Clean Face (rectangular)	Flat black	24	\$415
	X36WI	Decorative front	Wrought iron	35	\$725
	TK35	Basic 2" trim kit - 4 piece (covers opening 37 1/2" W X 34 1/2" H)	Painted black	5	\$129
	BT36K	Premium 3" bevelled trim kit	Black	6	\$199
	MKE36	Shore Fire Kit, mixture of rocks, sand, vermiculite, glass and rock tray		8	\$259
<b>MUST ORDER A W655-0608K SUPPORT BRACKET IF ORDERING A DLE OR REK KIT</b>					
	W655-0608K	Support Bracket for Media Kit		2	\$29
	DLE	Beach Fire kit, 4 Driftwood Logs		4	\$155
	REK	Mineral rock kit, mixture of multi-color rocks		2	\$209
	W361-0239-BULK	AMBIENT-GLOW Fireplace Embers (master packs of 50) individual packages suggested retail of \$15.95		2	\$799
	BANB100	Kit, Builders Ajd Nailing Bracket, 100 pieces			\$155
	270-BULK	Paint, Thuralox -Case of 12, black 13 oz.		12	\$235
HEAT CIRCULATION					
	GA-566	Hot air distribution kit		11	\$409
	GA-72	Hot air exhaust kit (GA-566 also required)		3	\$119
	GA-70	Extension kit, 5 ft flex vent		1	\$55
	AUB	Ascent Universal Blower, Blower kit with variable speed		5	\$195
CONTROLS					
	F45	Napoleon on/off hand held battery operated remote w/digital screen		1	\$95
	F45-6	Napoleon on/off hand held battery operated remote w/digital screen - bulk of 6		7	\$535
	F60	Napoleon thermostatic hand held battery operated remote w/digital screen		1	\$149
	F60-6	Napoleon thermostatic hand held battery operated remote w/digital screen - bulk of 6		7	\$859
	ACS-SIT	Anti-Condensation Switch (SIT electronic valve system only)		1	\$19



Effective: March 15, 2016

## B42NTR ASCENT™ SERIES

### B42NTR ASCENT™ SERIES DIRECT VENT CLEAN FACE BUILDER GAS FIREPLACES

Certified to the test standards, ANSI Z21.50 and CSA 2.22 for vented gas fireplaces

Venting - 4" & 7" Top & Rear Vent















• Dual receptacle junction box	• Heat resistant glass door	• 20 ft. wire
• Pan style burner	• Exclusive Phazer® log set & charcoal embers	• Mobile home approved
• Firestop	• Safety barrier	• Up to 22,000 BTU's

NOTE: All units are natural gas. If propane is required - please order conversion kit.

US \$

Product	Model Description	Finish	WT/lbs.	MSRP/MAP
 B42NTR	Millivolt 22,000 BTU's - Natural gas	Black	115	\$1,969
W175-0420	Conversion kit - Natural gas to propane		2	\$55
B42NTRE	Electronic 22,000 BTU's - Natural gas	Black	117	\$1,969
W175-0418	Conversion kit - Natural gas to propane		2	\$55
FC-12	12" stainless steel gas flex connector & shut off (25/crtn)		18	\$535
*Note: Flex Connector comes standard with electronic ignition model				

### OPTIONS/ACCESSORIES

DECORATIVE					
	GD871KT	decorative brick panels	Sandstone	13	\$275
	GD872KT	decorative brick panels	Herringbone	13	\$275
	PRPB42TR	porcelain reflective radiant panels	Gloss black	7	\$239
	H42F	decorative front - Heritage	Black	12	\$185
	Z42F	decorative front - Zen	Black	12	\$185
	TK42	Basic 2" trim kit (covers opening 44 1/2" W X 34 1/2" H)	painted black	5	\$159
	BT42K	Premium 3" bevelled trim kit	Black	6	\$229
	MKE42	Shore Fire Kit, mixture of rocks, sand, vermiculite, glass and rock tray		8	\$289
<b>MUST ORDER A W655-0610K SUPPORT BRACKET IF ORDERING A DLE OR REK KIT</b>					
	W655-0610K	Support Bracket for Media Kit		2	\$25
	DLE	Beach Fire kit, 4 Driftwood Logs		4	\$155
	REK	Mineral rock kit, mixture of multi-color rocks		2	\$209
	X42WI	Decorative front	Wrought Iron	39	\$829
	W361-0239-BULK	AMBIENT-GLOW Fireplace Embers (master packs of 50) individual packages suggested retail of \$15.95		2	\$799
	BANB100	Kit, Builders Ajd Nailing Bracket, 100 pieces			\$155
	270-BULK	Paint, Thurmalox -Case of 12, black 13 oz.		12	\$235
HEAT CIRCULATION					
	GA-566	Hot air distribution kit		11	\$409
	GA-72	Hot air exhaust kit (GA-566 also required)		3	\$119
	GA-70	Extension kit, 5 ft flex vent		1	\$55
	AUB	Ascent Universal Blower, Blower kit with variable speed		5	\$195
CONTROLS					
	F45	Napoleon on/off hand held battery operated remote w/digital screen		1	\$95
	F45-6	Napoleon on/off hand held battery operated remote w/digital screen - bulk of 6		7	\$535
	F60	Napoleon thermostatic hand held battery operated remote w/digital screen		1	\$149
	F60-6	Napoleon thermostatic hand held battery operated remote w/digital screen - bulk of 6		7	\$859
	ACS-SIT	Anti-Condensation Switch (SIT electronic valve system only)		1	\$19



Effective: March 21, 2016

## B46NTR ASCENT™ SERIES

### B46NTR ASCENT™ SERIES DIRECT VENT CLEAN FACE BUILDER GAS FIREPLACES

Certified to the test standards, ANSI Z21.50 and CSA 2.22 for vented gas fireplaces

Venting - 4" & 7" Top & Rear Vent













• Dual receptable junction box	• Heat resistant glass door	• 20 ft. wire
• Pan style burner	• Exclusive Phazer® log set & charcoal embers	• Mobile home approved
• Firestop	• Safety barrier	• Up to 22,000 BTU's

NOTE: All units are natural gas. If propane is required - please order conversion kit.

US \$

Product	Model Description	Finish	WT/lbs.	Sugg. List
 B46NTR	Millivolt 22,000 BTU's - Natural gas	black	120	\$1,999
W175-0420	Conversion kit - Natural gas to propane		2	\$55
B46NTRE	Electronic 22,000 BTU's - Natural gas	black	122	\$1,999
W175-0418	Conversion kit - Natural gas to propane		2	\$55
FC-12	12" stainless steel gas flex connector & shut off (25/crtn)		18	\$535
*Note: Flex Connector comes standard with electronic ignition model				

### OPTIONS/ACCESSORIES

DECORATIVE					
	GD873KT	decorative brick panels	sandstone	15	\$279
	PRPB46	porcelain reflective radiant panels	gloss black	9	\$259
	H46F	decorative front - Heritage	black	14	\$199
	Z46F	decorative front - Zen	black	14	\$199
	BT46K	Premium 3" beveled trim	painted black	6	\$249
	MKE42	Shore Fire Kit mixture of rocks, sand, vermiculite, glass and rock tray		13	\$289
	DLE	Beach Fire kit, 4 Driftwood Logs		4	\$155
	REK	Mineral rock kit, mixture of multi-color rocks		2	\$209
	W361-0239-BULK	AMBIENT-GLOW Fireplace Embers (master packs of 50) individual packages suggested retail of \$15.95		2	\$799
	BANB100	Kit, Builders Ajd Nailing Bracket, 100 pieces			\$155
	270-BULK	Paint, Thurmalox -Case of 12, black 13 oz.		12	\$235
HEAT CIRCULATION					
	GA-566	Hot air distribution kit		11	\$409
	GA-72	Hot air exhaust kit (GA-566 also required)		3	\$119
	GA-70	Extension kit, 5 ft flex vent		1	\$55
	AUB	Ascent Universal Blower, Blower kit with variable speed		5	\$195
CONTROLS					
	F45	Napoleon on/off hand held battery operated remote w/digital screen		1	\$95
	F45-6	Napoleon on/off hand held battery operated remote w/digital screen - bulk of 6		7	\$535
	F60	Napoleon thermostatic hand held battery operated remote w/digital screen		1	\$149
	F60-6	Napoleon thermostatic hand held battery operated remote w/digital screen - bulk of 6		7	\$859
	ACS-SIT	Anti-Condensation Switch (SIT electronic valve system only)		1	\$19



Effective: March 15, 2016

BL36NTE

**BL36NTE DIRECT VENT LINEAR GAS FIREPLACE (TOP VENT)**

Certified to the test standards, ANSI Z21.50 and CSA 2.22 for vented gas fireplaces

**Venting - 4" & 7"**

• Dual receptable junction box	• Heat resistant glass door	• 20 ft. wire
• Tube style burner	• Exclusive Topaz ember bed	• Firestop
• 40% Flame/heat adjustmentw/ shutoff	• Cement Board	• Mobile home approved
• Stainless steel flex connector (FC-12)	• Electronic Ignition only	• Up to 18,000 BTU's

NOTE: All units are natural gas. If propane is required - please order conversion kit.

US \$

	Product	Model Description	Finish	WT/lbs.	MSRP/MAP
	BL36NTE	Top vent fireplace with glass door - Natural gas - electronic ignition		90	\$1,899
	W175-0414	Conversion kit - Natural gas to propane		2	\$49

**DECORATIVE**

**MUST CHOOSE SURROUND OR FRONT TO COMPLETE UNIT**

	Product	Model Description	Finish	WT/lbs.	MSRP/MAP
	SL36K	Classic 4-Sided Surround with safety screen	Powder coat low sheen black	21	\$399
	SL36SS	Premium 4-Sided Surround with safety screen	Brushed stainless steel	16	\$599
	LFG36	Stylo™ Front with safety screen	Grey	37	\$749

**OPTIONS/ACCESSORIES**

	Product	Model Description	Finish	WT/lbs.	MSRP/MAP
	PRPL36	Porcelain reflective radiant panels	Gloss black	8	\$199
	MKE36	Shore Fire Kit, mixture of rocks, sand, vermiculite, glass and rock tray		8	\$259
	DLE	Beach Fire kit, 4 Driftwood Logs		4	\$155
	REK	Mineral rock kit, mixture of multi-color rocks		2	\$209
	W361-0239-BULK	AMBIENT-GLOW Fireplace Embers (master packs of 50) Individual packages suggested retail of \$15.95		2	\$799
	270-BULK	Paint, Thuralox -Case of 12, black 13 oz.		12	\$235

**HEAT CIRCULATION**

	Product	Model Description	WT/lbs.	MSRP/MAP
	GA-566	Hot air distribution kit	11	\$409
	GA-72	Hot air exhaust kit (GA-566 also required)	3	\$119
	GA-70	Extension kit, 5 ft flex vent	1	\$55
	AUB	Ascent Universal Blower, Blower kit with variable speed	5	\$195

**CONTROLS**

	Product	Model Description	WT/lbs.	MSRP/MAP
	F45	Napoleon on/off hand held battery operated remote w/digital screen	1	\$95
	F45-6	Napoleon on/off hand held battery operated remote w/digital screen - bulk of 6	7	\$535
	F60	Napoleon thermostatic hand held battery operated remote w/digital screen	1	\$149
	F60-6	Napoleon thermostatic hand held battery operated remote w/digital screen - bulk of 6	7	\$859
	W690-0005	Thermostat, 110 volt (for use with hot air distribution kit)	1	\$45
	ACS-SIT	Anti-Condensation Switch (SIT electronic valve system only)	1	\$19



Effective: March 15, 2016

## BHD4 ASCENT™ MULTI VIEW

### BHD4 HIGH DEFINITION CLEAN FACE MULTI VIEW DIRECT VENT GAS FIREPLACE (ZERO CLEARANCE TOP OR REAR/45° VENT)

TESTED AS A HEATER TO ANSI Z21.50 AND CSA 2.22

Venting - 5" & 8"

- Electronic ignition w/ battery backup
- ACS (Anti-condensation switch)
- Stainless steel gas flex connector
- Dual receptable junction box
- Pivoted heat resistant glass door
- Safety barrier
- Firestop
- Mobile home approved
- Up to 30,000 BTU's

NOTE: All units are natural gas. If propane is required - please order conversion kit.



US \$

Product	Model Description	Finish	WT/lbs.	MSRP/MAP
 BHD4STN	Clean face fireplace - See Thru with Logs - Natural gas		240	\$3,729
BHD4PN	Clean face fireplace - Peninsula with Logs - Natural gas		240	\$3,729
BHD4STGN	Clean face fireplace - See Thru with Glass - Natural gas		225	\$3,519
BHD4PGN	Clean face fireplace - Peninsula with Glass - Natural gas		225	\$3,519
W175-0383	Conversion kit - Natural gas to propane		2	\$55

### OPTIONS/ACCESSORIES

#### DECORATIVE

ALL MEDIA ENHANCEMENT KITS ARE DESIGNED FOR RANDOM PLACEMENT WITHIN THE FIREBOX AS AN ADDITION TO THE TOPAZ GLASS EMBER BED

	MKGK	Media kit (2 suggested)	Glass embers - black	5	\$105
	MKGB	Media kit (2 suggested)	Glass embers - blue	5	\$105
	MKGR	Media kit (2 suggested)	Glass embers - red	5	\$105
	MKGA	Media kit (2 suggested)	Glass embers - amber	5	\$105
	MKGT	Media kit (2 suggested)	Glass embers - topaz	5	\$105
	MKGC	Media kit (2 suggested)	Glass embers - clear	5	\$105
	MEGK	Media enhancement kit	1 lb. glass embers - black	1	\$55
	MEGB	Media enhancement kit	1 lb. glass embers - blue	1	\$55
	MEGR	Media enhancement kit	1 lb. glass embers - red	1	\$55
	MEGT	Media enhancement kit	1 lb. glass embers - topaz	1	\$55
MEGA	Media enhancement kit	1 lb. glass embers -amber	1	\$55	
	REK	Mineral rock kit, mixture of multi-color rocks		2	\$209

LDAC	Designer Fire Art - Coil design	Painted black	1	\$215
LDNS	Designer Fire Art - Nickel Stix	Nickel plated	9	\$535
GD851KT	End brick panel (2 required for See Thru)	Newport	4	\$85
PRPHD4	End porcelain panel kit (2 required for See Thru)		8	\$85

NOTE: GD851KT suitable for log version only

W361-0239-BULK	AMBIENT-GLOW Fireplace Embers (master packs of 50) individual packages suggested retail of \$15.95		2	\$799
270-BULK	Paint, Thuralox -Case of 12, black 13 oz.		12	\$235

#### CONTROLS

GD826N	Modulating valve regulator with remote control- natural		2	\$345
GD826P	Modulating valve regulator with remote control - propane		2	\$345
	F45	Napoleon on/off hand held battery operated remote w/digital screen	1	\$95
	F45-6	Napoleon on/off hand held battery operated remote w/digital screen - bulk of 6	7	\$535
	F60	Napoleon thermostatic hand held battery operated remote w/digital screen	1	\$149
	F60-6	Napoleon thermostatic hand held battery operated remote w/digital screen - bulk of 6	7	\$859

#### MISC

NOTE VENT TERMINAL: Round wall terminal is required - Please order GD422R-1 (Standard GD-422 NOT suitable for BHD4)

GD422R-1	Round wall terminal kit		4	\$175
----------	-------------------------	--	---	-------

This unit also suitable for Power Vent Kit - refer to GPV (power vent) price list for details



Effective: March 15, 2016

## BHD4 ASCENT™ MULTI VIEW

**BHD4 HIGH DEFINITION CLEAN FACE MULTI VIEW DIRECT VENT GAS FIREPLACE (ZERO CLEARANCE TOP OR REAR/45° VENT)**

TESTED AS A HEATER TO ANSI Z21.50 AND CSA 2.22

**Venting - 5" & 8"**

- Electronic ignition w/ battery backup
- ACS (Anti-condensation switch)
- Stainless steel gas flex connector
- Dual receptable junction box
- Pivoted heat resistant glass door
- Safety barrier
- Firestop
- Mobile home approved
- Up to 30,000 BTU's

**NOTE: All units are natural gas. If propane is required - please order conversion kit.**



**US \$**

	Product	Model Description	Finish	WT/lbs.	MSRP/MAP
	BHD4STFCN	Clean face fireplace - See Thru with Fire Cradle - Natural gas		225	\$3,729
	BHD4PFCN	Clean face fireplace - Peninsula with Fire Cradle - Natural gas		225	\$3,729
	W175-0383	Conversion kit - Natural gas to propane		2	\$55

### OPTIONS/ACCESSORIES

#### DECORATIVE

**ALL MEDIA ENHANCEMENT KITS ARE DESIGNED FOR RANDOM PLACEMENT WITHIN THE FIREBOX AS AN ADDITION TO THE TOPAZ GLASS EMBER BED**

	MKRY*	Media kit	River rocks - grey	10	\$139
	MKRM*	Media kit	River rocks - multi-coloured	10	\$139
	REK	Mineral rock kit, mixture of multi-color rocks		2	\$209
	MKGG	Media kit	Glass embers - black	5	\$105
	MKGB	Media kit	Glass embers - blue	5	\$105
	MKGR	Media kit	Glass embers - red	5	\$105
	MKGA	Media kit	Glass embers - amber	5	\$105
	MKGC	Media kit	Glass embers - topaz	5	\$105
	MKGT	Media kit	Glass embers - clear	5	\$105
	MEGK	Media enhancement kit	1 lb. glass embers - black	1	\$55
	MEGB	Media enhancement kit	1 lb. glass embers - blue	1	\$55
	MEGR	Media enhancement kit	1 lb. glass embers - red	1	\$55
	MEGT	Media enhancement kit	1 lb. glass embers - topaz	1	\$55
	MEGA	Media enhancement kit	1 lb. glass embers -amber	1	\$55
	PRPHD4	End porcelain panel kit (2 required for See Thru)		8	\$85
	W361-0239-BULK	AMBIENT-GLOW Fireplace Embers (master packs of 50) individual packages suggested retail of \$15.95		2	\$799
	270-BULK	Paint, ThurmaloX -Case of 12, black 13 oz.		12	\$235

#### CONTROLS

	GD826N	Modulating valve regulator with remote control- natural		2	\$345
	GD826P	Modulating valve regulator with remote control - propane		2	\$345
	F45	Napoleon on/off hand held battery operated remote w/digital screen		1	\$95
	F45-6	Napoleon on/off hand held battery operated remote w/digital screen - bulk of 6		7	\$535
	F60	Napoleon thermostatic hand held battery operated remote w/digital screen		1	\$149
	F60-6	Napoleon thermostatic hand held battery operated remote w/digital screen - bulk of 6		7	\$859

#### MISC

**NOTE VENT TERMINAL: Round wall terminal is required - Please order GD422R-1 (Standard GD-422 NOT suitable for BHD4)**

	GD422R-1	Round wall terminal kit		4	\$175
--	----------	-------------------------	--	---	-------

\*NOTE: Grey and/or multicoloured river rocks may be combined, if 2 kits are ordered

This unit also suitable for Power Vent Kit - refer to GPV (power vent) price list for details



Effective: March 15, 2016

## GX36NTR ASCENT™ X

### GX36NTR ASCENT™ X DIRECT VENT CLEAN FACE GAS FIREPLACE (TOP OR REAR VENT)

Certified to the test standards, ANSI Z21.50 and CSA 2.22 for vented gas fireplaces

Venting - 4" & 7" Top & Rear Vent

• Dual receptacle junction box	• Ceramic glass door	• 20 ft. wire
• Pan style burner	• Exclusive Phazer® log set & embers	• Firestop
• 40% Flame/heat adjustment	• Safety barrier & safety screen	• Mobile home approved
• Adjustable flame/heat control		• Up to 26,000 BTU's











NOTE: All units are natural gas. If propane is required - please order conversion kit.

US \$



Product	Model Description	Finish	WT/lbs.	MSRP/MAP
 GX36NTR	Top/rear vent fireplace with black door - Natural gas		96	\$2,069
W175-0389	Conversion kit - Natural gas to propane		2	\$55
GX36NTRE	Top/rear vent fireplace with black door - Natural gas - electronic ignition		98	\$2,069
W175-0401	Conversion kit (electronic ignition) - Natural gas to propane		2	\$55
FC-12	12" stainless steel gas flex connector & shut off (25/crtn)		18	\$535
<b>*Note: Flex Connector comes standard with electronic ignition model</b>				

#### OPTIONS/ACCESSORIES



##### DECORATIVE

	GD862KT	Decorative brick panels	Sandstone	10	\$215
	GD861KT	Decorative brick panels	Herringbone	10	\$245
	GD863KT	Decorative brick panels	Newport	10	\$235
	PRPB36	Porcelain reflective radiant panels	Gloss black	7	\$209
	H35F	Decorative front - Heritage	Black	12	\$159
	Z35F	Decorative front - Zen	Black	12	\$159
	CFF	Decorative front - Clean Face (rectangular)	Flat black	24	\$415
	X36WI	Decorative front	Wrought Iron	35	\$725
	TK35	Basic 2" trim kit - 4 piece (covers opening 37 1/2" W X 34 1/2" H)	Painted black	5	\$129
	BT36K	Premium 3" bevelled trim kit	Black	6	\$199
	W361-0239-BULK	AMBIENT-GLOW Fireplace Embers (master packs of 50) individual packages suggested retail of \$15.95		2	\$799
	270-BULK	Paint, ThurmaloX -Case of 12, black 13 oz.		12	\$235

##### ALTERNATE MEDIA KITS ARE AVAILABLE TO REPLACE GLOWING LOG SET SUPPLIED WITH UNIT

	MKE36	Shore Fire Kit, mixture of rocks, sand, vermiculite, glass and rock tray		8	\$259
<b>MUST ORDER A W655-0608K SUPPORT BRACKET IF ORDERING A DLE OR REK KIT</b>					
	W655-0608K	Support Bracket for Media Kit		2	\$29
	DLE	Beach Fire kit, 4 Driftwood Logs		4	\$155
	REK	Mineral rock kit, mixture of multi-color rocks		2	\$209
	BANB100	Kit, Builders Ajd Nailing Bracket, 100 pieces			\$155

##### HEAT CIRCULATION

	GA-566	Hot air distribution kit		11	\$409
	GA-72	Hot air exhaust kit (GA-566 also required)		3	\$119
	GA-70	Extension kit, 5 ft flex vent		1	\$55
	AUB	Ascent Universal Blower, Blower kit with variable speed		5	\$195

##### CONTROLS

	F45	Napoleon on/off hand held battery operated remote w/digital screen		1	\$95
	F45-6	Napoleon on/off hand held battery operated remote w/digital screen - bulk of 6		7	\$535
	F60	Napoleon thermostatic hand held battery operated remote w/digital screen		1	\$149
	F60-6	Napoleon thermostatic hand held battery operated remote w/digital screen - bulk of 6		7	\$859
	W690-0005	Thermostat, 110 volt (for use with hot air distribution kit)		1	\$45
	ACS-SIT	Anti-Condensation Switch (SIT electronic valve system only)		1	\$19





Effective: March 15, 2016

## GX70NTE ASCENT™ SERIES







### GX70NTE ASCENT™ SERIES DIRECT VENT CLEAN FACE BUILDER GAS FIREPLACES







Certified to the test standards, ANSI Z21.50 and CSA 2.22 for vented gas fireplaces

Venting - 5" & 8" Top Vent

- Dual receptable junction box
- Phazeramic™ burner
- 50% Flame/heat adjustment
- Adjustable flame/heat control
- Proflame II hand held remote controller; Controls Flame, Night Light™ w/ on/off/dimmer & blower
- Ceramic glass door
- Logs w/ ember bed & charcoals
- Safety barrier
- Nightlight™
- 20 ft. wire
- Firestop
- Mobile home approved
- Up to 35,000 BTU's
- Flex connector

US \$					
	Product	Model Description	Finish	WT/lbs.	MSRP/MAP
	GX70NTE	Electronic 35,000 BTU's - Natural gas	Black	93	\$2,699
	GX70PTE	Electric 35,000 BTU's - Propane		93	\$2,699

DECORATIVE					
	H35F	Decorative front - Heritage	Black	12	\$159
	Z35F	Decorative front - Zen	Black	12	\$159
	CFF	Decorative front - Clean Face (rectangular)	Flat black	24	\$415
	X36WI	Decorative front	Wrought iron	35	\$725
	GX427K	Faceplate with operable screen	Black	51	\$889
	GX725WI	Wrought iron front	Wrought iron	56	\$1,199

OPTIONS/ACCESSORIES					
	GD869KT	Decorative brick panels	Newport	10	\$249
	GD870KT	Decorative brick panels	Old town red	10	\$249
	GD868KT	Decorative brick panels	Herringbone	13	\$249
	PRPGX70	Porcelain reflective radiant panels	Gloss black	7	\$279
	TK35	Basic 2" trim kit (covers opening 37 1/2" W X 34 1/2" H)	Painted black	5	\$129
	BT36K	Premium 3" bevelled trim kit	Black	6	\$199
	W361-0239-BULK	AMBIENT-GLOW Fireplace Embers (master packs of 50) individual packages suggested retail of \$15.95		2	\$799
	BANB100	Kit, Builders Ajd Nailing Bracket, 100 pieces			\$155
	270-BULK	Paint, Thuralox -Case of 12, black 13 oz.		12	\$235

This unit also suitable for Power Vent Kit - refer to GPV (power vent) price list for details



Effective: March 15, 2016

## BGD36CFGN-2 CRYSTALLO™

### BGD36CFGN-2 CRYSTALLO™ DIRECT VENT CLEAN FACE GAS FIREPLACE (ZERO CLEARANCE TOP OR REAR VENT)

Tested as a heater to ANSI Z21.88 and CSA 2.33

Venting - 4" & 7"

<ul style="list-style-type: none"> <li>• Electronic ignition w/ battery backup and built in adjustable flame heat control</li> <li>• Safety barrier</li> <li>• Hinged heat resistant glass door</li> </ul>	<ul style="list-style-type: none"> <li>• Clean face front with hinged valve compartment access door</li> <li>• Dual receptable junction box</li> <li>• Stainless steel gas flex connector w/ shutoff</li> </ul>	<ul style="list-style-type: none"> <li>• Exclusive Crystalline™ ember bed with multi colored LED's</li> <li>• Mobile home approved</li> <li>• Up to 17,000 BTU's</li> </ul>
--	---	---

NOTE: All units are natural gas. If propane is required - please order conversion kit.

US \$



	Product	Model Description	Finish	WT/lbs.	MSRP/MAP
	BGD36CFGN-2	Top/rear vent clean face fireplace with black door - Natural gas (Includes Safety Barrier)		117	\$2,429
	W175-0278	Conversion kit - Natural gas to propane		2	\$55

#### OPTIONS/ACCESSORIES





##### DECORATIVE

ALL MEDIA ENHANCEMENT KITS ARE DESIGNED FOR RANDOM PLACEMENT WITHIN THE FIREBOX



AS AN ADDITION TO THE CRYSTALLINE™ EMBER BED

	Product	Model Description	Finish	WT/lbs.	MSRP/MAP
	MEGK	Media enhancement kit	1 lb. glass embers - black	1	\$55
	MEGB	Media enhancement kit	1 lb. glass embers - blue	1	\$55
	MEGR	Media enhancement kit	1 lb. glass embers - red	1	\$55
	MEGA	Media enhancement kit	1 lb. glass embers - topaz	1	\$55
	MEGT	Media enhancement kit	1 lb. glass embers - amber	1	\$55
	S36CVP	* Convex surround c/w top & hearth satin chrome trim with non combustable facing material	Diamond dust	40	\$945
	CFT36CV	lower trim for convex surround	Satin chrome	7	\$139
	W361-0239-BULK	AMBIENT-GLOW Fireplace Embers (master packs of 50) individual packages suggested retail of \$15.95		2	\$799
	270-BULK	Paint, Thuralox -Case of 12, black 13 oz.		12	\$235

##### HEAT CIRCULATION

	Product	Model Description	WT/lbs.	MSRP/MAP
	GZ550-1KT	Blower kit with variable speed	5	\$289
	B440-KT	Blower-economy, with variable speed (for ZC Fireplaces only)	5	\$195
	GA-566	Hot air distribution kit	11	\$409
	GA-72	Hot air exhaust kit (GA-566 also required)	3	\$119
	GA-70	Extension kit, 5 ft flex vent	1	\$55

##### CONTROLS

	Product	Model Description	WT/lbs.	MSRP/MAP
	W660-0081	Thermostat, wall mount - digital	1	\$69
	F45	Napoleon on/off hand held battery operated remote w/digital screen	1	\$95
	F45-6	Napoleon on/off hand held battery operated remote w/digital screen - bulk of 6	7	\$535
	F60	Napoleon thermostatic hand held battery operated remote w/digital screen	1	\$149
	F60-6	Napoleon thermostatic hand held battery operated remote w/digital screen - bulk of 6	7	\$859
	ACS-1	Anti-Condensation Switch	1	\$65
	GD36	Thermostat sensor control (for GA-72 and GA-566)	1	\$45
	W690-0005	Thermostat, 110 volt (for use with hot air distribution kit)	1	\$45



Effective: March 15, 2016

## BGD36CFNTRSB

### BGD36CFNTRSB GRANDVILLE™ 36 DIRECT VENT CLEAN FACE GAS FIREPLACE (ZERO CLEARANCE TOP OR REAR VENT)

Certified to the test standards, ANSI Z21.50 and CSA 2.22 for vented gas fireplaces

Venting - 4" & 7"

<ul style="list-style-type: none"> <li>• Millivolt gas valve w/ piezo ignitor</li> <li>• Dual receptable junction box</li> <li>• 40% Flame/heat adjustment</li> <li>• Adjustable flame/heat control w/ shutoff</li> </ul>	<ul style="list-style-type: none"> <li>• Heat resistant glass door</li> <li>• Exclusive Phazer® log set &amp; embers</li> <li>• Safety barrier</li> <li>• Clean face front</li> </ul>	<ul style="list-style-type: none"> <li>• 20 ft. wire</li> <li>• Firestop</li> <li>• Mobile home approved</li> <li>• Up to 17,000 BTU's</li> </ul>
---	---	---





NOTE: All units are natural gas. If propane is required - please order conversion kit.

US \$





Product	Model Description	Finish	WT/lbs.	MSRP/MAP
 BGD36CFNTRSB	Top/rear vent clean face fireplace with black door - Natural gas		117	\$2,179
W175-0159	Conversion kit - Natural gas to propane		2	\$55
BGD36CFNTRESB	Top/rear vent clean face fireplace with black door - Natural gas - electronic ignition		117	\$2,179
W175-0178	Conversion kit (electronic ignition) - Natural gas to propane		2	\$55

#### OPTIONS/ACCESSORIES



##### DECORATIVE

	**MKRY	media kit (replaces log set supplied with unit)	River rocks - multicoloured	10	\$139
	**MKRM	media kit (replaces log set supplied with unit)	River rocks - multicoloured	10	\$139
	S36CVP	* Convex surround c/w top & hearth satin chrome trim with non combustable facing material	Diamond dust	40	\$945
	<b>**Rock adaptor kit (must be ordered in conjunction with MKRY or MKRM)</b>				
	**RAK36	rock adaptor kit		1	\$29
	PRP36	Porcelain reflective radiant panels		6	\$179
	W361-0239-BULK	AMBIENT-GLOW Fireplace Embers (master packs of 50) individual packages suggested retail of \$15.95		2	\$799
	270-BULK	Paint, Thurmalox -Case of 12, black 13 oz.		12	\$235

##### HEAT CIRCULATION

	GZ550-1KT	Blower kit with variable speed		5	\$289
	B440-KT	Blower-economy, with variable speed (for ZC Fireplaces only)		5	\$195
	W500-0033	Variable speed switch wall mounting plate		1	\$5
	GA-566	Hot air distribution kit		11	\$409
	GA-72	Hot air exhaust kit (GA-566 also required)		3	\$119
	GA-70	Extension kit, 5 ft flex vent		1	\$55

##### CONTROLS

	W660-0081	Thermostat, wall mount - digital		1	\$69
	F45	Napoleon on/off hand held battery operated remote w/digital screen		1	\$95
	F45-6	Napoleon on/off hand held battery operated remote w/digital screen - bulk of 6		7	\$535
	F60	Napoleon thermostatic hand held battery operated remote w/digital screen		1	\$149
	F60-6	Napoleon thermostatic hand held battery operated remote w/digital screen - bulk of 6		7	\$859
	ACS-1	Anti-Condensation Switch		1	\$65
	GD36	Thermostat sensor control (for GA-72 and GA-566)		1	\$45
	W690-0005	Thermostat, 110 volt (for use with hot air distribution kit)		1	\$45

This unit also suitable for Power Vent Kit - refer to GPV (power vent) price list for details



Effective: March 15, 2016

## GD19-1NSB VITTORIA™

### GD19-1NSB VITTORIA™ DIRECT VENT GAS FIREPLACE (ZERO CLEARANCE TOP OR REAR VENT)

Tested to ANSI Z21.50 and CSA 2.22

Venting - 4" & 7"





<ul style="list-style-type: none"> <li>• Electronic ignition w/ battery backup, shutoff and built in adjustable flame heat control (NG)</li> <li>• Night Light™</li> </ul>	<ul style="list-style-type: none"> <li>• Exclusive Phazer® log set &amp; embers OR river rock/stone accent burner system</li> <li>• Ceramic glass</li> </ul>	<ul style="list-style-type: none"> <li>• Firestop</li> <li>• Mobile home approved</li> <li>• 45% Flame/heat adjustment (NG)</li> <li>• Up to 11,500 BTU's</li> </ul>
--	--	--

NOTE: All units are natural gas. If propane is required - please order conversion kit.

US \$

Product	Model Description	Finish	WT/lbs.	MSRP/MAP	
	GD19-1NSB	Vittoria™ top/rear vent fireplace with black door	Natural gas	75	\$1,555
<b>NOTE: MUST CHOOSE ONE BURNER ASSEMBLY TO COMPLETE UNIT</b>					
	B19NL	Burner assembly	Log configuration	10	\$385
	B19NS	Burner assembly	River Rock/Stone configuration	10	\$429
	W175-0266	Conversion kit - Natural gas to propane		2	\$55
	FC-12	12" stainless steel gas flex connector & shut off (25/crtn)		18	\$535

#### OPTIONS/ACCESSORIES

DECORATIVE					
<b>NOTE: MUST CHOOSE ONE FACING KIT AND ONE ORNAMENTAL INSET TO COMPLETE UNIT</b>					
	FK19SB	Facing kit with safety barrier	Painted metallic	20	\$325
	FK19PWSB	Facing kit with safety barrier	Hammered pewter	20	\$485
	VOIK	Victorian ornamental insets, upper & lower	Painted metallic black	4	\$185
	VOISS	Victorian ornamental insets, upper & lower	Brushed stainless steel - Limited Quantities Available	4	\$325
	CFK19SB	Contemporary Facing Kit with safety barrier	Painted black	20	\$429
	CFS19SB	Contemporary Facing Kit with safety barrier	Brushed stainless steel	20	\$485
	GD839KT	Decorative brick/stone panels Sandstone GD839KT Suitable for B19NL "Log" Burner Assembly Only		6	\$129
	PRP19	Porcelain reflective radiant panels PRP19 Suitable for either "Log" or "River Rock" Burner Assembly		10	\$145
	W361-0239-BULK	AMBIENT-GLOW Fireplace Embers (master packs of 50) individual packages suggested retail of \$15.95		2	\$799
	209M-BULK	Paint, Forrest - metallic black 12 oz. (Case of 12)		1	\$300
HEAT CIRCULATION					
	GS66	Fan kit with variable speed		5	\$159
	W500-0033	Variable speed switch wall mounting plate		1	\$5
	RP4	Restrictor Plate (recommended for aggressive vertical venting)		2	\$25
CONTROLS					
	W660-0081	Thermostat, wall mount - digital		1	\$69
	F45	Napoleon on/off hand held battery operated remote w/digital screen		1	\$95
	F45-6	Napoleon on/off hand held battery operated remote w/digital screen - bulk of 6		7	\$535
	F60	Napoleon thermostatic hand held battery operated remote w/digital screen		1	\$149
	F60-6	Napoleon thermostatic hand held battery operated remote w/digital screen - bulk of 6		7	\$859
	ACS-1	Anti-Condensation Switch		1	\$65

Fireplace Clearances have changed, Consult Installation Instructions for Specifics



Effective: March 15, 2016

## GD82NT-PAESB PARK AVENUE™

### GD82NT-PAESB PARK AVENUE™ DIRECT VENT GAS FIREPLACE (ZERO CLEARANCE TOP VENT)

Tested as a heater to ANSI Z21.88 and CSA 2.33

Venting - 4" & 7"

<ul style="list-style-type: none"> <li>• Electronic ignition w/ battery backup and built in adjustable flame heat control</li> <li>• Phazermatic™ burner</li> <li>• Stainless steel gas flex connector w/ shut off</li> <li>• Night Light™</li> </ul>	<ul style="list-style-type: none"> <li>• Ember bed and logs</li> <li>• Dual receptable junction box</li> <li>• Heat circulating blower w/ variable speed</li> </ul>	<ul style="list-style-type: none"> <li>• Firestop</li> <li>• Mobile home approved</li> <li>• 50% Flame/heat adjustment</li> <li>• Up to 26,000 BTU's</li> </ul>
---	---	---







NOTE: Burner & decorative brick or porcelain panels must be installed to complete unit.

NOTE: All units are natural gas. If propane is required - please order conversion kit.

US \$

	Product	Model Description	Finish	WT/lbs.	MSRP/MAP
	GD82NT-PAESB	Park Avenue™ top vent gas fireplace - Natural gas		189	\$3,629
	W175-0292	Conversion kit with modulating regulator - Natural gas to propane		2	\$95
<b>MUST CHOOSE ONE FACING KIT TO COMPLETE UNIT</b>					
	AFK82-1SB	Arched facing kit w/heritage pattern with safety barrier	Painted black	22	\$535
	RFK82-1SB	Rectangular facing kit with safety barrier	Painted black	10	\$465
	SFK82SSSB	Surround facing kit with safety barrier	Brushed stainless steel	60	\$1,929

#### OPTIONS/ACCESSORIES

<b>DECORATIVE</b>					
	HK82SSSB	Surround facing hearth kit	Brushed stainless steel	10	\$325
<b>MUST CHOOSE ONE DECORATIVE BRICK OR PORCELAIN PANELS &amp; ONE SET OF ANDIRONS TO COMPLETE UNIT</b>					
	GD811-KT	Decorative brick panels	Herringbone/sandstone	7	\$235
	GD812-KT	Fluted refractory bricks - Napoleon® insignia	Sandstone - Limited Quantities Available	72	\$279
	PRP82	Porcelain reflective radiant panels		6	\$215
	ANI-K	Andirons traditional	Painted black	2	\$75
	ANI-O	Andirons obelisk	Painted black - Limited Quantities Available	2	\$75
	W361-0239-BULK	AMBIENT-GLOW Fireplace Embers (master packs of 50) individual packages suggested retail of \$15.95		2	\$799
	270-BULK	Paint, Thurmalox -Case of 12, black 13 oz.		12	\$235
	W470-0017A	Paint, Wrought Iron 13 oz.		1	\$25
<b>HEAT CIRCULATION</b>					
	GA-566	Hot air distribution kit		11	\$409
	GA-72	Hot air exhaust kit (GA-566 also required)		3	\$119
	GA-70	Extension kit, 5 ft flex vent		1	\$55
	RP4	Restrictor Plate (recommended for aggressive vertical venting)		2	\$25
<b>CONTROLS</b>					
	W690-0005	Thermostat, 110 volt (for use with hot air distribution kit)		1	\$45



Effective: March 15, 2016

## GD82NT-TESB TUREEN™

### GD82NT-TESB TUREEN™ DIRECT VENT GAS FIREPLACE (ZERO CLEARANCE TOP VENT)

Tested as a heater to ANSI Z21.88 and CSA 2.33

Venting - 4" & 7"

- Electronic ignition w/ battery backup and built in adjustable flame heat control
- Night Light™ w/ on/off switch
- Exclusive Tureen™ stone accent Phazeramic™ burner
- Stainless steel gas flex connector w/ shut off
- Heat circulating blower w/ variable speed & thermostatic control
- Ember bed and logs
- Dual receptacle junction box
- Handheld remote control
- Firestop
- Mobile home approved
- Up to 26,000 BTU's
- 50% Flame/heat adjustment

NOTE: All units are natural gas. If propane is required - please order conversion kit.

US \$



	Product	Model Description	Finish	WT/lbs.	MSRP/MAP
	GD82NT-TESB	Tureen™ top vent gas fireplace - Natural gas - Electronic Ignition		176	\$4,249
	W175-0292	Conversion kit with modulating regulator - Natural gas to propane		2	\$95
<b>MUST CHOOSE ONE FACING KIT TO COMPLETE UNIT</b>					
	AFK82-1SB	Arched facing kit w/heritage pattern with safety barrier	Painted black	22	\$535
	RFK82-1SB	Rectangular facing kit with safety barrier	Painted black	10	\$465

#### OPTIONS/ACCESSORIES

##### DECORATIVE

SFK82SSSB	Surround facing kit with safety barrier	Brushed stainless steel	60	\$1,929
HK82SS	Surround facing hearth kit	Brushed stainless steel	10	\$325
W361-0239-BULK	AMBIENT-GLOW Fireplace Embers (master packs of 50) individual packages suggested retail of \$15.95		2	\$799
270-BULK	Paint, ThurmaloX -Case of 12, black 13 oz.		12	\$235
W470-0017A	Paint, Wrought Iron 13 oz.		1	\$25

##### HEAT CIRCULATION

	GA-566	Hot air distribution kit		11	\$409
	GA-72	Hot air exhaust kit (GA-566 also required)		3	\$119
	GA-70	Extension kit, 5 ft flex vent		1	\$55
	RP4	Restrictor Plate (recommended for aggressive vertical venting)		2	\$25

##### CONTROLS

W690-0005	Thermostat, 110 volt (for use with hot air distribution kit)		1	\$45
-----------	--	--	---	------



**GT8 INDOOR AND GSST8 OUTDOOR TORCHES**

**GT8NSB TORCH™**

**GT8NSB INDOOR TORCH™ DIRECT VENT GAS FIREPLACE (ZERO CLEARANCE REAR VENT)**

Tested to ANSI Z21.50 AND CSA 2.22

**Venting - 3" & 5"**

<ul style="list-style-type: none"> <li>• Electronic ignition w/ battery backup and on/off switches (optional light kit)</li> <li>• Gas shutoff</li> </ul>	<ul style="list-style-type: none"> <li>• Porcelain reflective panel</li> <li>• Glass embers</li> <li>• Exclusive Torch™ burner</li> </ul>	<ul style="list-style-type: none"> <li>• Mobile home approved</li> <li>• Up to 6,000 BTU's</li> </ul>
---	---	---

**US \$**

	Product	Model Description	Finish	WT/lbs.	MSRP/MAP
	GT8NSB	Torch™ rear vent gas fireplace (indoor only) - Natural gas		40	\$1,659
	GT8PSB	Torch™ rear vent gas fireplace (indoor only) - Propane		40	\$1,659
<b>MUST CHOOSE ONE FRAME/FRONT TO COMPLETE UNIT (SEE OPTIONS/ACCESSORIES FOR LIGHT KIT)</b>					
	TFK8SB	Torch™ frame/front, complete with safety barrier	Painted metallic black	7	\$445
	TFSS8SB	Torch™ frame/front, complete with safety barrier <b>APRIL 2015</b>	Brushed stainless steel	7	\$519

**OPTIONS/ACCESSORIES**

**DECORATIVE**

Product	Model Description	Finish	WT/lbs.	MSRP/MAP
LK8	Low voltage LED light kit (4) pre-wired for installation into TF kit		5	\$235
TMCK	Adjustable mounting cabinet	Painted metallic black	23	\$449
TMCSS	Adjustable mounting cabinet	Brushed stainless steel	23	\$699
W361-0239-BULK	AMBIENT-GLOW Fireplace Embers (master packs of 50) individual packages suggested retail of \$15.95		2	\$799
209M-BULK	Paint, Forrest - metallic black 12 oz. (Case of 12)		1	\$300

**HEAT CIRCULATION/VENTING**

Product	Model Description	Finish	WT/lbs.	MSRP/MAP
GD178	12" through the wall vent kit, c/w terminal		5	\$159
GDT5	Vent kit - 5 ft. (incl. 1-3"x5'+1-5"x5' flexible aluminum liner)		8	\$85
GDT10	Vent kit - 10 ft. (incl. 1-3"x10'+1-5"x10' flexible aluminum liner)		10	\$185
W585-0328	vent pipe shield (3" x 5")		2	\$25
GD179	Wall terminal kit		4	\$95
W175-0271	3" x 5" coupler kit		2	\$29
GDT110	Roof terminal kits	1/12 to 7/12 pitch	8	\$299
GDT111	Roof terminal kits	8/12 to 12/12 pitch	8	\$299
GDT112	Roof terminal kits	Flat roof	10	\$299
GDT113	Roof terminal		6	\$175

**GSST8 TORCH™**

**GSST8 OUTDOOR TORCH™ - STAINLESS STEEL**

Tested in Canada and U.S. as an outdoor gas fireplace. Listed to UL CR97-003 and CSA CAN1-2.21 and IASUS4

<ul style="list-style-type: none"> <li>• Electronic ignition w/ battery backup and on/off switches (optional light kit)</li> <li>• Gas shutoff</li> </ul>	<ul style="list-style-type: none"> <li>• Porcelain reflective panel</li> <li>• Glass embers</li> <li>• Exclusive Torch™ burner</li> </ul>	<ul style="list-style-type: none"> <li>• Approved for outdoor use</li> <li>• Up to 6,000 BTU's</li> <li>• Ceramic glass</li> </ul>
---	---	--

Full stainless steel front, mounting cabinet and stainless steel frame/front are included with Outdoor Torch™ and shipped in one carton.

**US \$**

	Product	Model Description	Finish	WT/lbs.	MSRP/MAP
	GSST8N	Outdoor SS Gas Torch™ c/w cabinet and frame/front - Natural gas	Brushed stainless steel	68	\$2,639
	GSST8P	Outdoor SS Gas Torch™ c/w cabinet and frame/front - Propane	Brushed stainless steel	68	\$2,639

**OPTIONS/ACCESSORIES**

**DECORATIVE**

Product	Model Description	Finish	WT/lbs.	MSRP/MAP
LK8	Low voltage LED light kit (4) pre-wired for installation into TF kit		5	\$235
W361-0239-BULK	AMBIENT-GLOW Fireplace Embers (master packs of 50) individual packages suggested retail of \$15.95		2	\$799

\* All frame/fronts are fabricated to accept optional light kit.



GVF36-2N GRANDVILLE™











**GVF36-2N GRANDVILLE™ 36 VENT FREE GAS FIREPLACE (ZERO CLEARANCE)**

Tested as a heater to the unvented heating standard ANSI Z21.11.2

• Millivolt ignition	• Piezo ignitor	• 20 ft. wire
• Built-in adjustable flame heat control	• Exclusive Phazer® glowing log set	• Up to 30,000 BTU's
• Dual receptable junction box	• Oxygen depletion sensor (ODS)	• Fireplace screen
• Double flame burner		

		US \$		
	Product	Model Description	WT/lbs.	MSRP/MAP
	GVF36-2N	Vent free fireplace - Natural gas	91	\$1,129
	GVF36-2P	Vent free fireplace - Propane	91	\$1,129
	FC-12	12" stainless steel gas flex connector & shut off (25/crtn)	18	\$535

**OPTIONS/ACCESSORIES**

DECORATIVE				
MUST CHOOSE ONE OF "A", "B" OR "C" OPTIONS TO COMPLETE UNIT				
	L36K	A) Contour louvre kit, upper and lower	Painted black	4 \$209
	L36PB	Contour louvre kit, upper and lower	Polished brass finish - <b>Limited Quantities Available</b>	4 \$209
	L36AB	Contour louvre kit, upper and lower	Antique brass finish	4 \$209
	L36SS	Contour louvre kit, upper and lower	Brushed stainless steel finish	4 \$209
	HOIK-3	B) Flush ornamental inset, upper and lower	Painted black	10 \$279
	HOIG-3	Flush ornamental inset, upper and lower	Gold plated (24 Karat)	10 \$429
	HOISS-3	Flush ornamental inset, upper and lower	Satin chrome	10 \$465
	GD36B-KT	C) *Bay front complete with pull screen & standard front brick (bay glass not available)	<b>Limited Quantities Available</b>	36 \$535
<b>* Note: Bay louvres or ornamental insets are required to complete bay front</b>				
	GDBLK	Bay louvre kit, upper and lower	Painted black	7 \$259
	GDBLPB	Bay louvre kit, upper and lower	Polished brass finish - <b>Limited Quantities Available</b>	7 \$245
	GDBLSS	Bay louvre kit, upper and lower	Brushed stainless steel finish - <b>Limited Quantities Available</b>	7 \$245
	GDBOIK	Bay ornamental inset - HERITAGE, upper & lower	Painted black - <b>Limited Quantities Available</b>	10 \$325
	GV824KT	Decorative brick panels	Sandstone	5 \$185
	PRP36VF	Porcelain reflective radiant panels		6 \$175
	TB336K	Bevelled trim kit - 3" (covers opening 37" W x 33" H)	Textured painted black	4 \$245
	TB336AB	Bevelled trim kit - 3" (covers opening 37" W x 33" H)	Antique brass finish - <b>Limited Quantities Available</b>	4 \$245
	TB336PB	Bevelled trim kit - 3" (covers opening 37" W x 33" H)	Polished brass finish - <b>Limited Quantities Available</b>	4 \$245
	TB336SS	Bevelled trim kit - 3" (covers opening 37" W x 33" H)	Brushed stainless steel finish	4 \$245
	TB636K	Bevelled trim kit - 6" (covers opening 44" W x 36" H)	Textured painted black	4 \$269
	TB636AB	Bevelled trim kit - 6" (covers opening 44" W x 36" H)	Antique brass finish - <b>Limited Quantities Available</b>	4 \$269
	TB636PB	Bevelled trim kit - 6" (covers opening 44" W x 36" H)	Polished brass finish - <b>Limited Quantities Available</b>	4 \$269
	TB636SS	Bevelled trim kit - 6" (covers opening 44" W x 36" H)	Brushed stainless steel finish - <b>Limited Quantities Available</b>	4 \$269
	CFSK-A	Cast iron surround kit (covers opening 44" W x 36" H)	Painted black	80 \$615
	ANI-K	Andirons	Painted black	2 \$75
	ANI-G	Andirons	Gold plated (24 karat) - <b>Limited Quantities Available</b>	2 \$149
	GD-565-1KT	Safety screen		4 \$195
	270-BULK	Paint, Thumalox -Case of 12, black 13 oz.		12 \$235
HEAT CIRCULATION				
	GZ550-1KT	Blower kit with variable speed		5 \$289
	B440-KT	Blower-economy, with variable speed (for ZC Fireplaces only)		5 \$195
	W500-0033	Variable speed switch wall mounting plate		1 \$5
	111KT	Outside air kit, 4ft. Insul. Flex and through the wall vent		2 \$95
	112KT	Adaptor plate for outside air kit		1 \$25
CONTROLS				
	W660-0081	Thermostat, wall mount - digital		1 \$69
	F45	Napoleon on/off hand held battery operated remote w/digital screen		1 \$95
	F45-6	Napoleon on/off hand held battery operated remote w/digital screen - bulk of 6		7 \$535
	F60	Napoleon thermostatic hand held battery operated remote w/digital screen		1 \$149
	F60-6	Napoleon thermostatic hand held battery operated remote w/digital screen - bulk of 6		7 \$859
	W660-0013	Modulating 110 volt thermostatic remote (controls flame & blower)		3 \$375
	GD825N	Modulating valve regulator for W660-0013 - Natural gas		1 \$55
	GD825P	Modulating valve regulator for W660-0013 - Propane		1 \$55





GVF42-1N GRANDVILLE™

**GVF42-1N GRANDVILLE™ 42 VENT FREE GAS FIREPLACE (ZERO CLEARANCE)**

Tested as a heater to the unvented heating standard ANSI Z21.11.2

- Millivolt ignition
- Built-in adjustable flame heat control
- Dual receptacle junction box
- Multi-level pan style burner
- Piezo ignitor
- Exclusive Phazer® glowing log set
- Oxygen depletion sensor (ODS)
- 20 ft. wire
- Up to 30,000 BTU's
- Fireplace screen & hood





US \$

	Product	Model Description	Finish	WT/lbs.	MSRP/MAP
	GVF42-1N	Vent free fireplace - Natural gas		170	\$1,289
	GVF42-1P	Vent free fireplace - Propane		170	\$1,289
	FC-12	12" stainless steel gas flex connector & shut off (25/crtn)		18	\$535

**OPTIONS/ACCESSORIES**

**DECORATIVE**



**NOTE: LOUVRES OR ORNAMENTAL INSETS MUST BE ORDERED SEPARATELY**

	L42K	Contour louvre kit	Painted black	5	\$215
	L42PB	Contour louvre kit	Polished brass finish - <b>Limited Quantities Available</b>	5	\$215
	L42SS	Contour louvre kit	Brushed stainless steel finish	5	\$215
	GDOI42K-1	Heritage ornamental insets	Painted black - <b>Limited Quantities Available</b>	10	\$279
	GDOI42G-1	Heritage ornamental insets	Gold plated (24 karat) - <b>Limited Quantities Available</b>	10	\$409
	GV825KT	Decorative brick panels	Sandstone	5	\$185
	PRP42	Porcelain reflective radiant panels		6	\$205
	CFSKN-B	Cast iron surround kit (covers opening 50" W x 39" H)	Porcelain enamel majolica brown - <b>Limited Quantities Available</b>	80	\$859
	ANI-K	Andirons	Painted black	2	\$75
	ANI-G	Andirons	Gold plated (24 karat) - <b>Limited Quantities Available</b>	2	\$149
	270-BULK	Paint, Thurmalox -Case of 12, black 13 oz.		12	\$235

**HEAT CIRCULATION**

	GZ550-1KT	Blower kit with variable speed and thermostatic control		5	\$289
	B440-KT	Blower-economy, with variable speed and thermostatic control (for ZC Fireplaces only)		5	\$195
	W500-0033	Variable speed switch wall mounting plate		1	\$5
	111KT	Outside air kit, 4ft. Insul. Flex and through the wall vent		2	\$95
	112KT	Adaptor plate for outside air kit		1	\$25

**CONTROLS**

	W660-0081	Thermostat, wall mount - digital		1	\$69
	F45	Napoleon on/off hand held battery operated remote w/digital screen		1	\$95
	F45-6	Napoleon on/off hand held battery operated remote w/digital screen - bulk of 6		7	\$535
	F60	Napoleon hand held battery operated remote w/digital screen		1	\$149
	F60-6	Napoleon hand held battery operated remote w/digital screen - bulk of 6		7	\$859
	W660-0013	Modulating 110 volt remote (controls flame & blower)		3	\$375
	GD825N	Modulating valve regulator for W660-0013 - Natural gas		1	\$55
	GD825P	Modulating valve regulator for W660-0013 - Propane		1	\$55

\*Note: (NOT SUITABLE FOR ELECTRONIC IGNITION) Modulating thermostatic remote can only be used in conjunction with modulating valve regulator.



## GVFT8 TORCH™

### GVFT8 INDOOR VENT FREE TORCH™

Tested as a heater to ANSI Z21.11.2 titled unvented room heater

- "No pilot" minivolt ignition
- Porcelain reflective panel
- Mobile home approved
- and on/off switches (optional light kit)
- Glass embers
- Up to 6,000 BTU's
- Gas shutoff & Oxygen Depletion Sensor (ODS)
- Exclusive Torch™ burner
- Ceramic glass

US \$

	Product	Model Description	Finish	WT/lbs.	MSRP/MAP
	GVFT8N	Vent Free Torch™ gas fireplace - Natural gas		40	\$1,719
	GVFT8P	Vent Free Torch™ gas fireplace - Propane		40	\$1,719

### OPTIONS/ACCESSORIES

#### DECORATIVE

**MUST CHOOSE ONE FRAME/FRONT & CABINET TO COMPLETE UNIT (SEE OPTIONS/ACCESSORIES FOR LIGHT KIT)**

TFK	Torch™ frame/front	Painted metallic black	7	\$355
TFR	Torch™ frame/front	Red	7	\$355
TFP	Torch™ frame/front	Diamond dust	7	\$355
TFW	Torch™ frame/front	White	7	\$355
TFB	Torch™ frame/front	Steel blue	7	\$355
TFSS	Torch™ frame/front	Brushed stainless steel	7	\$429
TMCK	Adjustable mounting cabinet	Painted metallic black	23	\$449
TMCSS	Adjustable mounting cabinet	Brushed stainless steel	23	\$699
209M-BULK	Paint, Forrest - metallic black 12 oz. (Case of 12)		1	\$300
LK8	Low voltage LED light kit (4) pre-wired for installation into TF kit		5	\$235

\* All frame/fronts are fabricated to accept optional light kit.

**IMPORTANT: GVFT8 CANNOT BE RECESSED AND MUST BE INSTALLED IN CONJUNCTION WITH TMCK OR TMCSS (ADJUSTABLE MOUNTING CABINET) AND a TF\_\_ (TORCH FRAME/FRONT)**



Effective: March 15, 2016  
Updated: May 4, 2016

HD35NT-1

**HD35NT-1 DIRECT VENT CLEAN FACE HIGH DEFINITION GAS FIREPLACE**

Tested as a heater to ANSI Z21.88 and CSA 2.33

*Venting - 4" & 7" Top Vent*

- Electronic ignition w/ battery backup
- Exclusive Phazer® log set & embers
- 20 ft. wire & firestop
- and built in adjustable flame heat control
- Dual receptacle junction box
- Mobile home approved
- Pan style burner
- Heat resistant glass door
- 43% Flame/heat adjustment
- Stainless steel gas flex connector w/ shut off
- Non-combustible material included
- Up to 25,000 BTU's

NOTE: All units are natural gas. If propane is required - please order conversion kit.

US \$

	Product	Model Description	Finish	WT/lbs.	MSRP/MAP
	HD35NT-1	Top vent fireplace with black door - Natural gas		155	\$2,059
	W175-0304	Conversion kit - Natural gas to propane		2	\$55
<b>NOTE: SAFETY BARRIER OR DECORATIVE SAFETY BARRIER MUST BE ORDERED TO COMPLETE UNIT</b>					
	SBHD35K	Basic Safety Barrier	Black	15	\$219
	D35BC	Decorative Safety Barrier with Brushed Copper Inlay	Brushed Copper	18	\$639
	D35BN	Decorative Safety Barrier with Brushed Nickel Inlay	Brushed Nickel	18	\$639
	DS35K	Decorative Safety Barrier with Straight Accents in Black	Black	10	\$299
	DS35BC	Decorative Safety Barrier with Straight Accents in Brushed Copper	Brushed Copper	18	\$649
	DS35BN	Decorative Safety Barrier with Straight Accents in Brushed Nickel	Brushed Nickel	18	\$649
	DC35K	Decorative Safety Barrier with Curved Accents in Black	Black	8	\$299
	DC35BC	Decorative Safety Barrier with Curved Accents in Brushed Copper	Brushed Copper	18	\$649
	DC35BN	Decorative Safety Barrier with Curved Accents in Brushed Nickel	Brushed Nickel	18	\$649

**OPTIONS/ACCESSORIES**

**DECORATIVE**

	GD841KT	Decorative brick panels	Sandstone	10	\$259
	GD846KT	Decorative brick kit	Mayan Desert sandstone - Limited Quantities Available	10	\$275
	PRPH35	Porcelain reflective radiant panels		21	\$279
	PRPHR35	Porcelain reflective radiant panels	Ribbed - Limited Quantities Available	22	\$299

ALTERNATE MEDIA KITS ARE AVAILABLE TO REPLACE PHAZER® LOG SET SUPPLIED WITH UNIT

	MKRY	Media kit (2 suggested for HD46)	River rocks - grey	10	\$139
	MKRM	Media kit (2 suggested for HD46)	River rocks - multi-coloured	10	\$139
	RAK35/40	River rock media tray w/satin chrome decorative fender (complete w/5 lb. Bag of sand)		8	\$59
	RAK46	River rock media tray w/satin chrome decorative fender (complete w/8 lb. Bag of sand)		12	\$85
	DLE	Beach Fire kit, 4 Driftwood Logs		4	\$155
	REK	Mineral rock kit, mixture of multi-color rocks		2	\$209

RIVER ROCKS MUST BE USED IN CONJUNCTION WITH A MEDIA TRAY. ALL MEDIA ENHANCEMENT KITS ARE DESIGNED FOR RIVER ROCK BURNER MEDIA

	MEGK*	Media enhancement kit	1 lb. glass embers - black	1	\$55
	MEGB*	Media enhancement kit	1 lb. glass embers - blue	1	\$55
	MEGR*	Media enhancement kit	1 lb. glass embers - red	1	\$55
	MEGA*	Media enhancement kit	1 lb. glass embers - topaz	1	\$55
	MEGT*	Media enhancement kit	1 lb. glass embers - amber	1	\$55

\*GLASS ENHANCEMENT KITS MUST ONLY BE PLACED ON THE FIREBOX BASE - DO NOT INSTALL OVER BURNER

	ANIH	Andirons	Painted black	7	\$105
	W361-0239-BULK	AMBIENT-GLOW Fireplace Embers (master packs of 50) Individual packages suggested retail of \$15.95		2	\$799
	270-BULK	Paint, Thurmalox -Case of 12, black 13 oz.		12	\$235

**HEAT CIRCULATION**

	GZ550-1KT	Blower kit with variable speed and thermostatic control		5	\$289
	B440-KT	Blower-economy, with variable speed and thermostatic control		5	\$195
	W500-0033	Variable speed switch wall mounting plate		1	\$5
	GA-566	Hot air distribution kit		11	\$409
	GA-72	Hot air exhaust kit (GA-566 also required)		3	\$119
	GA-70	Extension kit, 5 ft flex vent		1	\$55

**CONTROLS**

	W660-0081	Thermostat, wall mount - digital		1	\$69
	F45	Napoleon on/off hand held battery operated remote w/digital screen		1	\$95
	F45-6	Napoleon on/off hand held battery operated remote w/digital screen - bulk of 6		7	\$535
	F60	Napoleon hand held battery operated remote w/digital screen		1	\$149
	F60-6	Napoleon hand held battery operated remote w/digital screen - bulk of 6		7	\$859
	ACS-1	Anti-Condensation Switch		1	\$65
	W690-0005	Thermostat, 110 volt (for use with hot air distribution kit)		1	\$45

NOTE: Grey and/or multi-coloured river rocks may be combined, if 2 kits are ordered.



Effective: March 15, 2016  
Updated: May 4, 2016

HD40NT-1

**HD40NT-1 DIRECT VENT CLEAN FACE HIGH DEFINITION GAS FIREPLACE**











Tested as a heater to ANSI Z21.88 and CSA 2.33

**Venting - 4" & 7" Top Vent**

<ul style="list-style-type: none"> <li>• Electronic ignition w/ battery backup and built in adjustable flame heat control</li> <li>• Pan style burner</li> <li>• Stainless steel gas flex connector w/ shut off</li> </ul>	<ul style="list-style-type: none"> <li>• Exclusive Phazer® log set &amp; embers</li> <li>• Dual receptable junction box</li> <li>• Heat resistant glass door</li> <li>• Non-combustible material included</li> </ul>	<ul style="list-style-type: none"> <li>• 20 ft. wire &amp; firestop</li> <li>• Mobile home approved</li> <li>• 43% Flame/heat adjustment</li> <li>• Up to 27,000 BTU's</li> </ul>
--	--	---





NOTE: All units are natural gas. If propane is required - please order conversion kit.

US \$







Product	Model Description	Finish	WT/lbs.	MSRP/MAP
 HD40NT-1	Top vent fireplace with black door - Natural gas		177	\$2,259
W175-0286	Conversion kit - Natural gas to propane		2	\$55
<b>NOTE: SAFETY BARRIER OR DECORATIVE SAFETY BARRIER MUST BE ORDERED TO COMPLETE UNIT</b>				
 SBHD40K	Basic Safety Barrier	Black	15	\$239
 D40BC	Decorative Safety Barrier with Brushed Copper Inlay	Brushed Copper	19	\$679
 D40BN	Decorative Safety Barrier with Brushed Nickel Inlay	Brushed Nickel	19	\$679
 DS40K	Decorative Safety Barrier with Straight Accents in Black	Black	8	\$349
 DS40BC	Decorative Safety Barrier with Straight Accents in Brushed Copper	Brushed Copper	19	\$699
 DS40BN	Decorative Safety Barrier with Straight Accents in Brushed Nickel	Brushed Nickel	19	\$699
 DC40K	Decorative Safety Barrier with Curved Accents in Black	Black	8	\$349
 DC40BC	Decorative Safety Barrier with Curved Accents in Brushed Copper	Brushed Copper	19	\$699
 DC40BN	Decorative Safety Barrier with Curved Accents in Brushed Nickel	Brushed Nickel	19	\$699

**OPTIONS/ACCESSORIES**

**DECORATIVE**

 GD842KT	Decorative brick panels	Sandstone	12	\$275
 GD845KT	Decorative brick kit	Mayan Desert sandstone - Limited Quantities Available	12	\$299
 PRPH40	Porcelain reflective radiant panels		22	\$299
 PRPHR40	Porcelain reflective radiant panels	Ribbed - Limited Quantities Available	22	\$325



ALTERNATE MEDIA KITS ARE AVAILABLE TO REPLACE PHAZER® LOG SET SUPPLIED WITH UNIT

 MKRY	Media kit (2 suggested for HD46)	River rocks - grey	10	\$139
 MKRM	Media kit (2 suggested for HD46)	River rocks - multi-coloured	10	\$139
 RAK35/40	River rock media tray w/satin chrome decorative fender (complete w/5 lb. Bag of sand)		8	\$59
 RAK46	River rock media tray w/satin chrome decorative fender (complete w/8 lb. Bag of sand)		12	\$85
 DLE	Beach Fire kit, 4 Driftwood Logs		4	\$155
 REK	Mineral rock kit, mixture of multi-color rocks		2	\$209







RIVER ROCKS MUST BE USED IN CONJUNCTION WITH A MEDIA TRAY. ALL MEDIA ENHANCEMENT KITS ARE DESIGNED FOR RIVER ROCK BURNER MEDIA

 MEGK*	Media enhancement kit	1 lb. glass embers - black	1	\$55
 MEGB*	Media enhancement kit	1 lb. glass embers - blue	1	\$55
 MEGR*	Media enhancement kit	1 lb. glass embers - red	1	\$55
 MEGA*	Media enhancement kit	1 lb. glass embers - topaz	1	\$55
 MEGT*	Media enhancement kit	1 lb. glass embers - amber	1	\$55







\*GLASS ENHANCEMENT KITS MUST ONLY BE PLACED ON THE FIREBOX BASE - DO NOT INSTALL OVER BURNER

 ANIH	Andirons	Painted black	7	\$105
 W361-0239-BULK	AMBIENT-GLOW Fireplace Embers (master packs of 50) individual packages suggested retail of \$15.95		2	\$799
 270-BULK	Paint, Thuralox - Case of 12, black 13 oz.		12	\$235

**HEAT CIRCULATION**

 GZ550-1KT	Blower kit with variable speed and thermostatic control		5	\$289
 B440-KT	Blower-economy, with variable speed and thermostatic control		5	\$195
 W500-0033	Variable speed switch wall mounting plate		1	\$5
 GA-566	Hot air distribution kit		11	\$409
 GA-72	Hot air exhaust kit (GA-566 also required)		3	\$119
 GA-70	Extension kit, 5 ft flex vent		1	\$55

**CONTROLS**

 W660-0081	Thermostat, wall mount - digital		1	\$69
 F45	Napoleon on/off hand held battery operated remote w/digital screen		1	\$95
 F45-6	Napoleon on/off hand held battery operated remote w/digital screen - bulk of 6		7	\$535
 F60	Napoleon hand held battery operated remote w/digital screen		1	\$149
 F60-6	Napoleon hand held battery operated remote w/digital screen - bulk of 6		7	\$859
 ACS-1	Anti-Condensation Switch		1	\$65
 W690-0005	Thermostat, 110 volt (for use with hot air distribution kit)		1	\$45

NOTE: Grey and/or multi-coloured river rocks may be combined, if 2 kits are ordered.



Effective: March 15, 2016  
Updated: May 4, 2016

HD46NT-1

**HD46NT-1 DIRECT VENT CLEAN FACE HIGH DEFINITION GAS FIREPLACE**

Tested as a heater to ANSI Z21.88 and CSA 2.33

**Venting - 4" & 7" Top Vent**

<ul style="list-style-type: none"> <li>• Electronic ignition w/ battery backup and built in adjustable flame heat control</li> <li>• Pan style burner</li> <li>• Stainless steel gas flex connector w/ shut off</li> </ul>	<ul style="list-style-type: none"> <li>• Exclusive Phazer® log set &amp; embers</li> <li>• Dual receptable junction box</li> <li>• Heat resistant glass door</li> </ul>	<ul style="list-style-type: none"> <li>• 20 ft. wire &amp; firestop</li> <li>• Mobile home approved</li> <li>• 43% Flame/heat adjustment</li> <li>• Non-combustible material included</li> <li>• Up to 30,000 BTU's</li> </ul>
--	---	--

NOTE: All units are natural gas. If propane is required - please order conversion kit.

	Product	Model Description	Finish	WT/lbs.	MSRP/MAP	US \$
	HD46NT-1	Top vent fireplace with black door - Natural gas		209		\$2,469
	W175-0288	Conversion kit - Natural gas to propane		2		\$55
<b>NOTE: SAFETY BARRIER OR DECORATIVE SAFETY BARRIER MUST BE ORDERED TO COMPLETE UNIT</b>						
	SBHD46K	Basic Safety Barrier	Black	15		\$299
	D46BC	Decorative Safety Barrier with Brushed Copper Inlay	Brushed Copper	21		\$699
	D46BN	Decorative Safety Barrier with Brushed Nickel Inlay	Brushed Nickel	22		\$699
	DS46K	Decorative Safety Barrier with Straight Accents in Black	Black	20		\$399
	DS46BC	Decorative Safety Barrier with Straight Accents in Brushed Copper	Brushed Copper	22		\$749
	DS46BN	Decorative Safety Barrier with Straight Accents in Brushed Nickel	Brushed Nickel	22		\$749
	DC46K	Decorative Safety Barrier with Curved Accents in Black	Black	20		\$399
	DC46BC	Decorative Safety Barrier with Curved Accents in Brushed Copper	Brushed Copper	22		\$749
	DC46BN	Decorative Safety Barrier with Curved Accents in Brushed Nickel	Brushed Nickel	21		\$749

**OPTIONS/ACCESSORIES**

<b>DECORATIVE</b>						
	GD843KT	Decorative brick panels	Sandstone	14		\$299
	GD847KT	Decorative brick kit	Mayan Desert sandstone - Limited Quantities Available	14		\$309
	PRPH46	Porcelain reflective radiant panels		23		\$309
	PRPHR46	Porcelain reflective radiant panels	Ribbed - Limited Quantities Available	24		\$355
<b>ALTERNATE MEDIA KITS ARE AVAILABLE TO REPLACE PHAZER® LOG SET SUPPLIED WITH UNIT</b>						
	MKRY	Media kit (2 suggested for HD46)	River rocks - grey	10		\$139
	MKRM	Media kit (2 suggested for HD46)	River rocks - multi-coloured	10		\$139
	RAK35/40	River rock media tray w/satin chrome decorative fender (complete w/5 lb. Bag of sand)		8		\$59
	RAK46	River rock media tray w/satin chrome decorative fender (complete w/8 lb. Bag of sand)		12		\$85
	DLE	Beach Fire kit, 4 Driftwood Logs		4		\$155
	REK	Mineral rock kit, mixture of multi-color rocks		2		\$209

2 river rock media kits are required for HD46

RIVER ROCKS MUST BE USED IN CONJUNCTION WITH A MEDIA TRAY. ALL MEDIA ENHANCEMENT KITS ARE DESIGNED FOR RIVER ROCK BURNER MEDIA

	MEGK*	Media enhancement kit	1 lb. glass embers - black	1		\$55
	MEGB*	Media enhancement kit	1 lb. glass embers - blue	1		\$55
	MEGR*	Media enhancement kit	1 lb. glass embers - red	1		\$55
	MEGA*	Media enhancement kit	1 lb. glass embers - topaz	1		\$55
	MEGT*	Media enhancement kit	1 lb. glass embers - amber	1		\$55
<b>*GLASS ENHANCEMENT KITS MUST ONLY BE PLACED ON THE FIREBOX BASE - DO NOT INSTALL OVER BURNER</b>						
	ANIH	Andirons	Painted black	7		\$105
	W361-0239-BULK	AMBIENT-GLOW Fireplace Embers (master packs of 50) individual packages suggested retail of \$15.95		2		\$799
	270-BULK	Paint, Thurmalox -Case of 12, black 13 oz.		12		\$235

<b>HEAT CIRCULATION</b>						
	GZ550-1KT	Blower kit with variable speed and thermostatic control		5		\$289
	B440-KT	Blower-economy, with variable speed and thermostatic control		5		\$195
	W500-0033	Variable speed switch wall mounting plate		1		\$5
	GA-566	Hot air distribution kit		11		\$409
	GA-72	Hot air exhaust kit (GA-566 also required)		3		\$119
	GA-70	Extension kit, 5 ft flex vent		1		\$55

<b>CONTROLS</b>						
	W660-0081	Thermostat, wall mount - digital		1		\$69
	F45	Napoleon on/off hand held battery operated remote w/digital screen		1		\$95
	F45-6	Napoleon on/off hand held battery operated remote w/digital screen - bulk of 6		7		\$535
	F60	Napoleon hand held battery operated remote w/digital screen		1		\$149
	F60-6	Napoleon hand held battery operated remote w/digital screen - bulk of 6		7		\$859
	ACS-1	Anti-Condensation Switch		1		\$65
	W690-0005	Thermostat, 110 volt (for use with hot air distribution kit)		1		\$45

NOTE: Grey and/or multi-coloured river rocks may be combined, if 2 kits are ordered.



## HD81NTSB HIGH DEFINITION SEE THRU

### HD81NTSB HIGH DEFINITION SEE THRU DIRECT VENT GAS FIREPLACE (ZERO CLEARANCE TOP VENT)

Tested as a heater to ANSI Z21.50 and CSA 2.22

Venting - 8" & 10"

- Electronic ignition w/ battery backup
- Split flow burner system & room selector heat deflector
- Remote control - Flame, Night Light™ & optional blower
- and built in adjustable flame heat control
- Ember bed and logs
- Mobile home approved
- Night Light™ w/ on/off switch
- Dual receptacle junction box
- Up to 60,000 BTU's
- ACS (Anti-condensation switch)
- Non-combustible material
- 72% Flame/heat adjustment
- Stainless steel gas flex connector w/ shut off

NOTE: Burner, decorative brick or porcelain panels and safety screen must be installed to complete unit.

US \$

Product	Model Description	Finish	WT/lbs.	MSRP/MAP
 HD81NTSB	Top vent see thru gas fireplace body & valve assembly - Natural gas		325	\$5,959
T81KSB	trim kit, complete with safety barrier	Black	14	\$309
<b>T81KSB TRIM KIT MUST BE ORDERED TO COMPLETE UNIT, 2 REQUIRED</b>				
<b>NOTE: MUST CHOOSE ONE BURNER ASSEMBLY AND ONE DECORATIVE BRICK OR PORCELAIN REFLECTIVE PANEL TO COMPLETE UNIT</b>				
B81NL	Burner assembly	Logs configuration	64	\$999
W175-0308	Conversion kit	Natural gas to propane - logs only	2	\$55
B81NG	Burner assembly	Glass (TOPAZ)	36	\$835
B81NS	Burner assembly	River Rock/Stone configuration	48	\$999
W175-0313	Conversion kit (for Glass CRYSTALINE™) or River Rock/Stone) - Natural gas to propane		2	\$55
GD844KT	Decorative brick panels	Sandstone finish	12	\$265
PRP81	Porcelain reflective radiant panels	Gloss black	22	\$289

#### OPTIONS/ACCESSORIES

##### DECORATIVE

T81-BNSB	Faceplate (designed to go over the T81KSB)	brushed nickel	10	\$215
T81-BCSB	Faceplate (designed to go over the T81KSB)	brushed copper	10	\$215

ALTERNATE MEDIA KITS ARE AVAILABLE TO REPLACE TOPAZ GLASS SUPPLIED WITH B81NG

MKGG	Media kit	Glass embers - black	5	\$105
MKGB	Media kit	Glass embers - blue	5	\$105
MKGR	Media kit	Glass embers - red	5	\$105
MKGA	Media kit	Glass embers - amber	5	\$105
MKGC	Media kit	Glass embers - clear	5	\$105
MKGT	Media kit	Glass embers - topaz	5	\$105

ALL MEDIA ENHANCEMENT KITS ARE DESIGNED FOR RANDOM PLACEMENT WITHIN THE FIREBOX AS AN ADDITION TO EITHER THE TOPAZ EMBER BED OR ANY OF THE OTHER OPTIONAL MEDIA KITS

MEGK	Media enhancement kit	1 lb. glass embers - black	1	\$55
MEGB	Media enhancement kit	1 lb. glass embers - blue	1	\$55
MEGR	Media enhancement kit	1 lb. glass embers - red	1	\$55
MEGA	Media enhancement kit	1 lb. glass embers - topaz	1	\$55
MEGT	Media enhancement kit	1 lb. glass embers -amber	1	\$55

ANIH	Andirons - 2/kit (NOTE: 2 kits required if installing both sides)	Painted black	7	\$105
GBAT	Glass/Burner accent trim	Polished chrome - Limited Quantities Available	3	\$215
SBAT	Stone burner accent trim	Polished chrome - Limited Quantities Available	4	\$195
GL81L2*	Top diagonal decorative logs (1-side supplied with Log Burner Assembly)	Limited Quantities Available	4	\$49
W361-0239-BULK	AMBIENT-GLOW Fireplace Embers (master packs of 50) individual packages suggested retail of \$15.95		2	\$799
270-BULK	Paint, Thurmaiox -Case of 12, black 13 oz.		12	\$235

##### HEAT CIRCULATION

NZ64	Air circulating blower system with decorative grill & washable filter for circulation of either interior or outside		25	\$645
GAG5	6" x 10" Air circulation vent and collar for use with NZ64 blower		8	\$95

##### VENT KITS AND COMPONENTS

GD622R	Wall terminal		5	\$215
GD610	Roof terminal kits	1/12 to 7/12 pitch	25	\$385
GD611	Roof terminal kits	8/12 to 12/12 pitch	25	\$385
GD612	Roof terminal kits	Flat roof	25	\$385
GD613	Roof terminal		12	\$279
GD620	Vent kit - 5 ft. (incl. 1 - 8"x5" + 1 - 10"x5" flexible aluminum liner)		7	\$155
GD630	Vent kit - 10 ft. (incl. 1 - 8"x10" + 1 - 10"x10" flexible aluminum liner)		14	\$279
RP8	Restrictor plate (Recommended for aggressive verticle venting)		2	\$25
W175-0002	8" coupler		2	\$25
W175-0249	10" coupler		3	\$25
W010-1797	Firestop		3	\$39
W585-0222	Vent pipe shield		4	\$39
W170-0116	Vent pipe collar		2	\$29
W573-0007	Hi-temperature sealant, (millpac) 10.3 oz cartridge		2	\$25
W573-0012	Hi-temperature sealant, (millpac) 10.3 oz cartridge (bulk - 24 per carton)		25	\$495

NOTE: The log configuration is designed to be different from each side. To duplicate the view from both sides add GL81L2 to one side.

This unit also suitable for Power Vent Kit - refer to GPV (power vent) price list for details



# HDX35NT

## HDX35NT STARFIRE™ DELUXE FIREPLACE - ZERO CLEARANCE TOP VENT





Certified to the test standards, ANSI Z21.50 and CSA 2.22 for vented gas fireplaces

Venting - 4" & 7"



<ul style="list-style-type: none"> <li>• Electronic ignition with ability for standing pilot</li> <li>• Stainless steel gas flex connector</li> <li>• 40% Flame/heat adjustment</li> <li>• Night Light™</li> </ul>	<ul style="list-style-type: none"> <li>• Ceramic glass door</li> <li>• Non combustible material included</li> <li>• Dual receptable junction box</li> <li>• Proflame II hand held controller; Controls Flame, Night Light™ w/ on/off/dimmer &amp; optional blowerv</li> </ul>	<ul style="list-style-type: none"> <li>• 20 ft. wire</li> <li>• Firestop</li> <li>• Mobile home approved</li> <li>• Up to 35,000 BTU's</li> </ul>
--	---	---

Note: Burner, barrier, front & decorative brick or porcelain panels must be installed to complete unit.

US \$

	Product	Model Description	Finish	WT/lbs.	MSRP/MAP
	HDX35NT	Top vent gas fireplace - Natural gas		254	\$3,209
	W175-0407	Conversion kit - Natural gas to propane		2	\$55
<b>NOTE: MUST CHOOSE ONE BURNER ASSEMBLY TO COMPLETE UNIT</b>					
	B35NL	Burner assembly	Logs configuration	62	\$1,035
	B35NG	Burner assembly	Glass (TOPAZ)	21	\$1,035
<b>NOTE: MUST CHOOSE ONE FRONT AND ONE DECORATIVE BRICK OR PORCELAIN REFLECTIVE PANEL TO COMPLETE UNIT</b>					
	F35K	Classic front (complete with screen)	Black	14	\$519
	FD35K	Decorative front (complete with screen)	Black	16	\$625
	GD864KT	Decorative brick panels	Newport finish	10	\$365
	GD865KT	Decorative brick panels	Herringbone	10	\$365
	GD866KT	Decorative brick panels	Ledgerock - Antique White	12	\$569
	GD867KT	Decorative brick panels	Ledgerock - Custom Blend	12	\$569
	PRP35BN	Porcelain reflective radiant panels	Beige/brown - cappuccino	18	\$365
	PRP35GY	Porcelain reflective radiant panels	Platinum	18	\$365
	PRP35BK	Porcelain reflective radiant panels	Black	18	\$365
	HP35K	Hearth pad	Black	4	\$79
<b>*HP35K HEARTH PAD IS REQUIRED WHEN ORDERING A LOG CONFIGURATION WITH ANY PORCELAIN REFLECTIVE RADIANT PANEL KIT</b>					

### OPTIONS/ACCESSORIES

<b>DECORATIVE</b>					
	RS35WI	Decorative surround (rectangular)	Wrought iron	76	\$1,425
	AS35WI	Decorative surround (arched) <b>AVAILABLE SEPTEMBER</b>	Wrought iron	78	\$1,239
<b>ALTERNATE MEDIA KITS ARE AVAILABLE TO REPLACE CLEAR GLASS SUPPLIED WITH B35GN (TOPAZ)</b>					
	DLR35	Rock and Driftwood log set		10	\$309
<b>NOTE: DLR35 can only be used with B35GN, Glass Burner Assembly</b>					
	MKRY	Media kit	River rocks - grey	10	\$139
	MKGK	Media kit	Glass embers - black	5	\$105
	MKGB	Media kit	Glass embers - blue	5	\$105
	MKGR	Media kit	Glass embers - red	5	\$105
	MKGA	Media kit	Glass embers - amber	5	\$105
	MKGC	Media kit	Glass embers - clear	5	\$105
	MKGT	Media kit	Glass embers - topaz	5	\$105
<b>ALL MEDIA ENHANCEMENT KITS ARE DESIGNED FOR RANDOM PLACEMENT WITHIN THE FIREBOX AS AN ADDITION TO EITHER THE TOPAZ GLASS EMBER BED OR ANY OF THE OTHER OPTIONAL MEDIA KITS.</b>					
	MEGK	Media enhancement kit 1 lb.	Glass embers - black	1	\$55
	MEGB	Media enhancement kit 1 lb.	Glass embers - blue	1	\$55
	MEGR	Media enhancement kit 1 lb.	Glass embers - red	1	\$55
	MEGA	Media enhancement kit 1 lb.	Glass embers - amber	1	\$55
	MEGT	Media enhancement kit 1 lb.	Glass embers - topaz	1	\$55
	W361-0239-BULK	AMBIENT-GLOW Fireplace Embers (master packs of 50) individual packages suggested retail of \$15.95		2	\$799
	270-BULK	Paint, ThurmaloX -Case of 12, black 13 oz.		12	\$235
	W470-0017A	Paint, - Wrought Iron Grey 12 oz.		1	\$25

### HEAT CIRCULATION

	GA-566	Hot air distribution kit		11	\$409
	NZ64	Air circulating blower system with decorative grill & washable filter for circulation of either interior or outside fresh air. (NOTE: GA65 vent and collar required.)		25	\$645
	GA65	6" x 10' Air circulation vent and collar for use with NZ64 blower		8	\$95

### CONTROLS

	W660-0160	SIT wall mount remote		3	\$85
--	-----------	-----------------------	--	---	------

This unit also suitable for Power Vent Kit - refer to GPV (power vent) price list for details



Effective: March 15, 2016  
Updated: May 4, 2016

## HDX40NT-2 STARFIRE™

### HDX40NT-2 STARFIRE™ 40 DIRECT VENT CLEAN FACE HIGH DEFINITION GAS FIREPLACE

Tested to ANSI Z21.50 and CSA 2.22





Venting - 5" x 8" T

Venting - 5" & 8" Top Vent

- Electronic ignition w/ battery backup
- Exclusive Phazer® log set & embers
- Firestop
- and built in adjustable flame heat control
- Dual receptacle junction box
- Mobile home approved
- Stainless steel gas flex connector w/ shut off
- Ceramic glass door
- Non-combustible material included
- Proflame II hand held controller ; Controls Flame, Night Light™ w/ on/off/dimmer & optional blower
- Night Light
- Up to 40,000 BTU's

NOTE: All units are natural gas. If propane is required - please order conversion kit.





US \$

Product	Model Description	Finish	WT/lbs.	MSRP/MAP
	HDX40NT-2 Top vent fireplace with black door - Natural gas		187	\$3,479
	W175-0358 Conversion kit - Natural gas to propane		2	\$75
<b>NOTE: SAFETY BARRIER OR DECORATIVE SAFETY BARRIER MUST BE ORDERED TO COMPLETE UNIT</b>				
	SBHD40K Basic Safety Barrier	Black	15	\$239
	D40BC Decorative Safety Barrier with Brushed Copper Inlay	Brushed Copper	19	\$679
	D40BN Decorative Safety Barrier with Brushed Nickel Inlay	Brushed Nickel	19	\$679
	DS40K Decorative Safety Barrier with Straight Accents in Black	Black	8	\$349
	DS40BC Decorative Safety Barrier with Straight Accents in Brushed Copper	Brushed Copper	19	\$699
	DS40BN Decorative Safety Barrier with Straight Accents in Brushed Nickel	Brushed Nickel	19	\$699
	DC40K Decorative Safety Barrier with Curved Accents in Black	Black	8	\$349
	DC40BC Decorative Safety Barrier with Curved Accents in Brushed Copper	Brushed Copper	19	\$699
	DC40BN Decorative Safety Barrier with Curved Accents in Brushed Nickel	Brushed Nickel	19	\$699

### OPTIONS/ACCESSORIES

#### DECORATIVE

ALTERNATE MEDIA KITS ARE AVAILABLE TO REPLACE PHAZER® LOG SET SUPPLIED WITH UNIT







	MKRY Media kit	River rocks-grey	10	\$139
	MKRM Media kit	River rocks - multi-coloured	10	\$139
	RAK35/40 River rock media tray w/satin chrome decorative fender (complete w/5 lb. Bag of sand)		8	\$59
	DLE Beach Fire kit, 4 Driftwood Logs		4	\$155
	REK Mineral rock kit, mixture of multi-color rocks		2	\$209

RIVER ROCKS MUST BE USED IN CONJUNCTION WITH A MEDIA TRAY





ALL MEDIA ENHANCEMENT KITS ARE DESIGNED FOR RIVER ROCK BURNER MEDIA

	MEGK* Media enhancement kit 1 lb.	Glass embers - black	1	\$55
	MEGB* Media enhancement kit 1 lb.	Glass embers - blue	1	\$55
	MEGR* Media enhancement kit 1 lb.	Glass embers - red	1	\$55
	MEGA* Media enhancement kit 1 lb.	Glass embers - amber	1	\$55
	MEGT* Media enhancement kit 1 lb.	Glass embers - topaz	1	\$55

\*GLASS ENHANCEMENT KITS MUST ONLY BE PLACED ON THE FIREBOX BASE - DO NOT INSTALL OVER BURNER

	ANIH Andirons	Painted black	7	\$105
	W361-0239-BULK 270-BULK	AMBIENT-GLOW Fireplace Embers (master packs of 50) individual packages suggested retail of \$15.95 Paint, Thurmalox - Case of 12, black 13 oz.	2 12	\$799 \$235
	PRPX40 Porcelain reflective radiant panels		22	\$289
	PRPHR40 Porcelain reflective radiant panels	Ribbed - Limited Quantities Available	23	\$325
	GD842-1KT Decorative brick panels	Sandstone	14	\$285
	GD845-1KT Decorative brick kit	Mayan Desert sandstone	12	\$299
	GD848KT Deluxe decorative brick panels	Newport	12	\$325

#### HEAT CIRCULATION

	GZ550-1KT Blower kit with variable speed		5	\$289
	B440-KT Blower-economy, with variable speed (for ZC Fireplaces only)		5	\$195
	W500-0033 Variable speed switch wall mounting plate		1	\$5
	GA-566 Hot air distribution kit		11	\$409
	GA-72 Hot air exhaust kit (GA-566 also required)		3	\$119
	GA-70 Extension kit, 5 ft flex vent		1	\$55
	RP5 Restrictor Plate (recommended for aggressive vertical venting)		2	\$25

#### CONTROLS

	W660-0160 SIT wall mount remote		3	\$85
	W690-0005 Thermostat, 110 volt (for use with hot air distribution kit)		1	\$45

This unit also suitable for Power Vent Kit - refer to GPV (power vent) price list for details





Effective: March 15, 2016

## HDX52NT-1 STARFIRE™

### HDX52NT-1 STARFIRE™ DELUXE FIREPLACE - ZERO CLEARANCE TOP VENT

Tested as a heater to ANSI Z21.50 and CSA 2.33

Venting - 8" & 11"



- Electronic ignition w/ ability for standing pilot and built in adjustable flame heat control
- Safety barrier
- Stainless steel gas flex connector w/ shut off
- Proflame II hand held controller - Flame, Night Light™ w/ on/off/dimmer & optional blower
- Dual receptable junction box
- Firestop
- Ceramic glass door
- Mobile home approved
- 54% Flame/heat adjustment
- Non-combustible material included
- Up to 55,000 BTU's

NOTE: Burner & decorative brick or porcelain panels must be installed to complete unit.

US \$

	Product	Model Description	Finish	WT/lbs.	MSRP/MAP
	HDX52NT-1	Top vent gas fireplace - Natural gas		435	\$4,699
<b>NOTE: MUST CHOOSE ONE BURNER ASSEMBLY TO COMPLETE UNIT</b>					
	B52NL-1	Burner assembly must order hearth pad when ordering log configuration	Logs configuration	92	\$1,605
	B52NG-1	Burner assembly	Glass (TOPAZ)	28	\$1,605
<b>NOTE: MUST CHOOSE ONE DECORATIVE BRICK OR PORCELAIN REFLECTIVE PANEL TO COMPLETE UNIT</b>					
	GD855KT	Decorative brick panels	Newport finish	29	\$535
	GD854KT	Decorative brick panels	Herringbone	29	\$535
	GD859KT	Decorative brick panels	Ledgerock - Antique White	36	\$855
	GD860KT	Decorative brick panels	Ledgerock - Custom Blend	36	\$855
	PRP52BN	Porcelain reflective radiant panels	Beige/brown - cappuccino	42	\$535
	PRP52GY	Porcelain reflective radiant panels	Platinum	42	\$535
	PRP52BK	Porcelain reflective radiant panels	Black	42	\$535
	HP52K*	Hearth pad	Black	6	\$109
<b>*HP52K HEARTH PAD IS REQUIRED WHEN ORDERING A LOG CONFIGURATION BURNER AND ANY PORCELAIN REFLECTIVE RADIANT PANEL KIT</b>					

#### OPTIONS/ACCESSORIES

<b>DECORATIVE</b>					
	RS52WI	Decorative surround (rectangular)	Wrought iron	105	\$1,985
	AS52WI	Decorative surround (arched)	Wrought iron	105	\$1,745
	FD52K	Decorative front (screen included)	Black	27	\$859
<b>ALTERNATE MEDIA KITS ARE AVAILABLE TO REPLACE CLEAR GLASS SUPPLIED WITH B52NG-1 (TOPAZ)</b>					
	DLR52	Rock and Driftwood log set		10	\$365
<b>NOTE: DLR52 can only be used with B52NG-1, Glass Burner Assembly</b>					
	MKRY	Media kit	River rocks - grey	10	\$139
	MK GK	Media kit	Glass embers - black	5	\$105
	MK GB	Media kit	Glass embers - blue	5	\$105
	MK GR	Media kit	Glass embers - red	5	\$105
	MK GA	Media kit	Glass embers - amber	5	\$105
	MK GC	Media kit	Glass embers - clear	5	\$105
	MK GT	Media kit	Glass embers - topaz	5	\$105
<b>ALL MEDIA ENHANCEMENT KITS ARE DESIGNED FOR RANDOM PLACEMENT WITHIN THE FIREBOX AS AN ADDITION TO EITHER THE CRYSTALLINE™ EMBER BED OR ANY OF THE OTHER OPTIONAL MEDIA KITS.</b>					
	ME GK	Media enhancement kit 1 lb.	Glass embers - black	1	\$55
	ME GB	Media enhancement kit 1 lb.	Glass embers - blue	1	\$55
	ME GR	Media enhancement kit 1 lb.	Glass embers - red	1	\$55
	ME GA	Media enhancement kit 1 lb.	Glass embers - amber	1	\$55
	ME GT	Media enhancement kit 1 lb.	Glass embers - topaz	1	\$55
	W361-0239-BULK	AMBIENT-GLOW Fireplace Embers (master packs of 50) individual packages suggested retail of \$15.95		2	\$799
	270-BULK	Paint, Thurnalox -Case of 12, black 13 oz.		12	\$235
	W470-0017A	Paint, - Wrought Iron Grey 12 oz.		1	\$25
<b>HEAT CIRCULATION</b>					
	NZ64	Air circulating blower system with decorative grill & washable filter for circulation of either interior or outside		25	\$645
	GA65	6" x 10' Air circulation vent and collar for use with NZ64 blower		8	\$95
<b>CONTROLS</b>					
	W660-0160	SIT wall mount remote		3	\$85

This unit also suitable for Power Vent Kit - refer to GPV (power vent) price list for details



Effective: March 15, 2016

## HDX52PT-1 STARFIRE™

### HDX52PT-1 STARFIRE™ DELUXE FIREPLACE - ZERO CLEARANCE TOP VENT

Tested as a heater to ANSI Z21.50 and CSA 2.33

Venting - 8" & 11"



- Electronic ignition w/ ability for standing pilot
- Dual receptable junction box
- Mobile home approved
- and built in adjustable flame heat control
- Firestop
- 54% Flame/heat adjustment
- Safety barrier
- Ceramic glass door
- Non-combustible material included
- Stainless steel gas flex connector w/ shut off
- Up to 55,000 BTU's
- Proflame II hand held controller - Flame, Night Light™ w/ on/off/dimmer & optional blower

NOTE: Burner & decorative brick or porcelain panels must be installed to complete unit.

US \$

	Product	Model Description	Finish	WT/lbs.	MSRP/MAP
	HDX52PT-1	Top vent gas fireplace - Propane		435	\$4,699
<b>NOTE: MUST CHOOSE ONE BURNER ASSEMBLY TO COMPLETE UNIT</b>					
	B52PL-1	Burner assembly must order hearth pad when ordering log configuration	Logs configuration	92	\$1,605
	B52PG-1	Burner assembly	Glass (TOPAZ)	28	\$1,605
<b>NOTE: MUST CHOOSE ONE DECORATIVE BRICK OR PORCELAIN REFLECTIVE PANEL TO COMPLETE UNIT</b>					
	GD855KT	Decorative brick panels	Newport finish	29	\$535
	GD854KT	Decorative brick panels	Herringbone	29	\$535
	GD859KT	Decorative brick panels	Ledgerock - Antique White	36	\$855
	GD860KT	Decorative brick panels	Ledgerock - Custom Blend	36	\$855
	PRP52BN	Porcelain reflective radiant panels	Beige/brown - cappuccino	42	\$535
	PRP52GY	Porcelain reflective radiant panels	Platinum	42	\$535
	PRP52BK	Porcelain reflective radiant panels	Black	42	\$535
	HP52K*	Hearth pad	Black	6	\$109
<b>*HP52K HEARTH PAD IS REQUIRED WHEN ORDERING A LOG CONFIGURATION BURNER AND ANY PORCELAIN REFLECTIVE RADIANT PANEL KIT</b>					

#### OPTIONS/ACCESSORIES

<b>DECORATIVE</b>					
	RS52WI	Decorative surround (rectangular)	Wrought iron	105	\$1,985
	AS52WI	Decorative surround (arched)	Wrought iron	105	\$1,745
	FD52K	Decorative front (screen included)	Black	27	\$859
<b>ALTERNATE MEDIA KITS ARE AVAILABLE TO REPLACE CLEAR GLASS SUPPLIED WITH B52PG-1 (TOPAZ)</b>					
	DLR52	Rock and Driftwood log set		10	\$365
<b>NOTE: DLR52 can only be used with B52NG-1, Glass Burner Assembly</b>					
	MKRY	Media kit	River rocks - grey	10	\$139
	MKGG	Media kit	Glass embers - black	5	\$105
	MKGB	Media kit	Glass embers - blue	5	\$105
	MKGR	Media kit	Glass embers - red	5	\$105
	MKGA	Media kit	Glass embers - amber	5	\$105
	MKGC	Media kit	Glass embers - clear	5	\$105
	MKGT	Media kit	Glass embers - topaz	5	\$105
<b>ALL MEDIA ENHANCEMENT KITS ARE DESIGNED FOR RANDOM PLACEMENT WITHIN THE FIREBOX AS AN ADDITION TO EITHER THE CRYSTALLINE™ EMBER BED OR ANY OF THE OTHER OPTIONAL MEDIA KITS.</b>					
	MEGK	Media enhancement kit 1 lb.	Glass embers - black	1	\$55
	MEGB	Media enhancement kit 1 lb.	Glass embers - blue	1	\$55
	MEGR	Media enhancement kit 1 lb.	Glass embers - red	1	\$55
	MEGA	Media enhancement kit 1 lb.	Glass embers - amber	1	\$55
	MEGT	Media enhancement kit 1 lb.	Glass embers - topaz	1	\$55
	W361-0239-BULK	AMBIENT-GLOW Fireplace Embers (master packs of 50) individual packages suggested retail of \$15.95		2	\$799
	270-BULK	Paint, Thuralox -Case of 12, black 13 oz.		12	\$235
	W470-0017A	Paint, - Wrought Iron Grey 12 oz.		1	\$25
<b>HEAT CIRCULATION</b>					
	NZ64	Air circulating blower system with decorative grill & washable filter for circulation of either interior or outside fresh air. (NOTE: GA65 vent and collar required.)		25	\$645
	GA65	6" x 10' Air circulation vent and collar for use with NZ64 blower		8	\$95
<b>CONTROLS</b>					
	W660-0160	SIT wall mount remote		3	\$85

This unit also suitable for Power Vent Kit - refer to GPV (power vent) price list for details



Effective: March 15, 2016

## LHD45NSB VECTOR™

### LHD45NSB VECTOR™ LINEAR GAS SERIES





Tested to: ANSI Z21.88 and CSA2.33 vented gas fireplace heaters

Venting - 4" & 7"

- Electronic ignition w/ battery backup
- Exclusive Topaz Crystalline™ ember bed
- 20 ft. wire
- Pivoted heat resistant glass door
- Dual receptable junction box
- Firestop
- Ribbon Burner
- Up to 24,000 BTU's
- Non-combustible facing material
- Stainless steel gas flex connector w/ shut off
- Mobile home approved

NOTE: All units are natural gas. If propane is required - please order conversion kit.

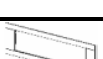













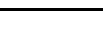

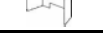

US \$

Product	Model Description	Finish	WT/lbs.	MSRP/MAP
 LHD45NSB	Linear Fireplace - Natural gas	Painted black	175	\$2,939
W175-0326	Conversion kit - Natural gas to propane		2	\$55
<b>MUST CHOOSE ONE SURROUND TO COMPLETE UNIT</b>				
 LS45KSB	Basic 4-sided surround w/safety barrier (covers opening 46 1/2" W x 19" H)	Painted flat black	15	\$375
 LDS45KSB	Deluxe 4-sided surround w/safety barrier (covers opening 46 1/2" W x 19" H)	Painted gloss black	15	\$559
 LDS45WSB	Deluxe 4-sided surround w/safety barrier (covers opening 46 1/2" W x 19" H)	Painted gloss white	15	\$559
 LPS45SSSB	Premium 4-sided surround w/safety barrier (covers opening 51" W x 19 1/2" H)	Brushed stainless steel	15	\$879
LFG45SB	Linear Frame - Grey (With Safety Barrier)	Grey		\$805

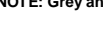
### OPTIONS/ACCESSORIES

#### DECORATIVE

ALTERNATE MEDIA KITS ARE AVAILABLE TO REPLACE GLASS EMBERS SUPPLIED WITH UNIT

 MKRY*	Media kit (2 suggested)	River rock - grey	10	\$139
 MKRM*	Media kit (2 suggested)	River rock - multi-colour	10	\$139
 MKGK	Media kit	Glass embers - black	5	\$105
 MKGB	Media kit	Glass embers - blue	5	\$105
 MKGR	Media kit	Glass embers - red	5	\$105
 MKGA	Media kit	Glass embers - amber	5	\$105
 MKGC	Media kit	Glass embers - clear	5	\$105
 MKGT	Media kit	Glass embers - topaz	5	\$105
<b>ALL MEDIA ENHANCEMENT KITS ARE DESIGNED FOR RANDOM PLACEMENT WITHIN THE FIREBOX AS AN ADDITION TO EITHER THE CRYSTALLINE™ EMBER BED OR ANY OF THE OTHER OPTIONAL MEDIA KITS</b>				
 MEKR	Media enhancement kit	6 river rocks - grey	3	\$49
 MEGK	Media enhancement kit 1 lb.	Glass embers - black	1	\$55
 MEGB	Media enhancement kit 1 lb.	Glass embers - blue	1	\$55
 MEGR	Media enhancement kit 1 lb.	Glass embers - red	1	\$55
 MEGA	Media enhancement kit 1 lb.	Glass embers - amber	1	\$55
 MEGT	Media enhancement kit 1 lb.	Glass embers - topaz	1	\$55
 LDAC	Designer Fire Art - Coil design	Painted black	1	\$215
 LDNS	Designer Fire Art - Nickel Stix	Nickel plated	9	\$535
 DL45	Driftwood Log Set (includes log set & 6 river rocks)		20	\$325
 PRP45	Porcelain reflective radiant panels		15	\$235
 W361-0239-BULK	AMBIENT-GLOW Fireplace Embers (master packs of 50) individual packages suggested retail of \$15.95		2	\$799
 270-BULK	Paint, Thuralox - Case of 12, black 13 oz.		12	\$235



\*NOTE: Grey and/or multicoloured river rocks may be combined, if 2 kits are ordered





Effective: March 15, 2016

LHD45NSB VECTOR™

**LHD45NSB VECTOR™ LINEAR GAS SERIES**

HEAT CIRCULATION				
	Product	Model Description	WT/lbs.	MSRP/MAP
	GZ550-1KT**	Blower kit with variable speed	5	\$289
	B440-KT**	Blower-economy, with variable speed (for ZC Fireplaces only)	5	\$195
	W500-0033	Variable speed switch wall mounting plate	1	\$5
	GA-566	Hot air distribution kit	11	\$409
	GA-72	Hot air exhaust kit (GA-566 also required)	3	\$119
	GA-70	Extension kit, 5 ft flex vent	1	\$55
	RP4	Restrictor Plate (recommended for aggressive vertical venting)	2	\$25

**\*\* NOTE: Blower installation will be simplified if installed through the pre-finishing access panel prior to framing/finishing.**

CONTROLS				
	Product	Model Description	WT/lbs.	MSRP/MAP
	W660-0081	Thermostat, wall mount - digital	1	\$69
	F45	Napoleon on/off hand held battery operated remote w/digital screen	1	\$95
	F45-6	Napoleon on/off hand held battery operated remote w/digital screen - bulk of 6	7	\$535
	F60	Napoleon hand held battery operated remote w/digital screen	1	\$149
	F60-6	Napoleon hand held battery operated remote w/digital screen - bulk of 6	7	\$859
	ACS-SIT	Anti-Condensation Switch	1	\$19
	W690-0005	Thermostat, 110 volt (for use with hot air distribution kit)	1	\$45

This unit also suitable for Power Vent Kit - refer to GPV (power vent) price list for details



Effective: March 15, 2016

## LHD62NSB VECTOR™

### LHD62NSB VECTOR™ LINEAR GAS SERIES

Tested to: ANSI Z21.50 and CSA2.22 vented gas fireplace

Venting - 8" & 10"

- Electronic ignition w/ battery backup
- Ribbon pan burner
- Pivoted ceramic glass door
- Porcelain reflective radiant panels & burner tray
- Stainless steel gas flex connector w/ shut off
- Proflame II hand held controller - Flame, ...Night Light™ w/ on/off/dimmer
- Exclusive Topaz Crystalline™ ember bed
- Dual receptable junction box
- Firestop
- Night Light™
- Mobile home approved
- Up to 50,000 BTU's

US \$

Product	Model Description	Finish	WT/lbs.	MSRP/MAP
LHD62NSB	Linear Fireplace - Natural gas	Painted black	575	\$8,279
LHD62PSB	Linear Fireplace - Propane	Painted black	575	\$8,279

### OPTIONS/ACCESSORIES

#### DECORATIVE

NOTE: 4-SIDED SURROUND MUST BE ORDERED TO COMPLETE UNIT TO MEET SAFETY BARRIER REQUIREMENT

LDS62KSB	Deluxe 4-sided surround w/safety barrier (covers opening 70" W x 22" H)	Painted gloss black	25	\$859
LPS62SSSB	Premium 4-sided surround w/safety barrier (covers opening 70" W x 22" H)	Brushed stainless steel	25	\$1,179

ALTERNATE MEDIA KITS ARE AVAILABLE TO REPLACE GLASS EMBERS SUPPLIED WITH UNIT

DL62	Driftwood Kit - Includes Sand, Rocks, Vermiculite and Logs (11 pieces)		22	\$429
RK62	Rock Kit - Includes Sand, Rocks, Vermiculite and multi-coloured rocks		12	\$259
MKGK	Media kit	Glass embers - black	5	\$105
MKGB	Media kit	Glass embers - blue	5	\$105
MKGR	Media kit	Glass embers - red	5	\$105
MKGA	Media kit	Glass embers - amber	5	\$105
MKGC	Media kit	Glass embers - clear	5	\$105
MKGT	Media kit	Glass embers - topaz	5	\$105
GD849KT	Decorative Fluted Brick Panels	California Sun	18	\$335

ALL MEDIA ENHANCEMENT KITS ARE DESIGNED FOR RANDOM PLACEMENT WITHIN THE FIREBOX AS AN ADDITION TO EITHER THE CRYSTALLINE™ EMBER BED OR ANY OF THE OTHER OPTIONAL MEDIA KITS

MEKR	Media enhancement kit	6 river rocks - grey	3	\$49
MEGK	Media enhancement kit 1 lb.	Glass embers - black	1	\$55
MEGB	Media enhancement kit 1 lb.	Glass embers - blue	1	\$55
MEGR	Media enhancement kit 1 lb.	Glass embers - red	1	\$55
MEGA	Media enhancement kit 1 lb.	Glass embers - amber	1	\$55
MEGT	Media enhancement kit 1 lb.	Glass embers - topaz	1	\$55
LDNS	Designer Fire Art - Nickel Stix (2 suggested)	Nickel plated	9	\$535
W361-0239-BULK	AMBIENT-GLOW Fireplace Embers (master packs of 50) individual packages suggested retail of \$15.95		2	\$799
270-BULK	Paint, ThurmaloX -Case of 12, black 13 oz.		12	\$235

#### VENT KITS AND COMPONENTS

GD622R	Wall terminal		5	\$215
GD610	Roof terminal kits	1/12 to 7/12 pitch	25	\$385
GD611	Roof terminal kits	8/12 to 12/12 pitch	25	\$385
GD612	Roof terminal kits	Flat roof	25	\$385
GD613	Roof terminal		12	\$279
GD620	Vent kit - 5 ft. (incl. 1 - 8"x5' + 1 - 10"x5' flexible aluminum liner)		7	\$155
GD630	Vent kit - 10 ft. (incl. 1 - 8"x10' + 1 - 10"x10' flexible aluminum liner)		14	\$279
RP8	Restrictor plate (Recommended for aggressive verticle venting)		2	\$25
W175-0002	8" coupler		2	\$25
W175-0249	10" coupler		3	\$25
W010-1797	Firestop		3	\$39
W585-0222	Vent pipe shield		4	\$39
W170-0116	Vent pipe collar		2	\$29
W573-0007	Hi-temperature sealant, (millpac) 10.3 oz cartridge		2	\$25
W573-0012	Hi-temperature sealant, (millpac) 10.3 oz cartridge (bulk - 24 per carton)		25	\$495

#### CONTROLS

W660-0160	SIT wall mount remote		3	\$85
-----------	-----------------------	--	---	------

\*NOTE: Grey and/or multicoloured river rocks may be combined, if 2 kits are ordered

This unit also suitable for Power Vent Kit - refer to GPV (power vent) price list for details



Effective: May 3, 2016

LV38

**LV38 VECTOR™ LINEAR GAS SERIES**

Certified to the test standards, ANSI Z21.50 and CSA 2.22 for vented gas fireplaces

**Venting - 5" & 8"**



- E Fire Module for Blue Tooth Application
- Ceramic glass door
- Firestop
- Electronic ignition w/ battery backup
- Clear Glass beads w/ multi-color LED lighting
- Mobile home approved
- Stainless steel flex connector
- Non-combustible material included
- Hand held remote controls
- Adjustable flame/heat control w/ shutoff
- Dual receptable junction box
- Control Service Lights
- Mirror Flame™ porcelain reflective radiant panels
- Easy Access Air Control Lever

US \$

Product	Model Description	Finish	WT/lbs.	MSRP/MAP
 LV38N	Linear Fireplace - Natural gas	Painted black	349	\$3,899
LV38N2	2-Sided See Thru Linear Fireplace - Natural gas	Painted black	355	\$4,399
W175-0424	Conversion kit - Natural gas to propane		2	\$55

**DECORATIVE**

**MUST CHOOSE FLUSH FRAME OR SURROUND TO COMPLETE UNIT**

 FF38K	Flush Frame with Safety Screen	Powder coat low sheen black	20	\$499
FF38W	Flush Frame with Safety Screen <b>COMING SOON</b>	Powder coat gloss white		
FF38SS	Flush Frame with Safety Screen	Stainless steel	20	\$849
 S38K	Surround complete with Safety Screen	Powder coat low sheen black	20	\$649
S38W	Surround complete with Safety Screen <b>COMING SOON</b>	Powder coat gloss white		
S38SS	Surround complete with Safety Screen	Stainless steel	20	\$999
S38HS	Surround complete with Safety Screen	Hammered steel	50	\$1,299

**OPTIONS/ACCESSORIES**



**FINISHING TRIM DESIGNED FOR FLUSH FRAME ONLY**

 FT38K	Finishing trim (1")	Powder coat low sheen black	12	\$299
FT38W	Finishing trim (1") <b>COMING SOON</b>	Powder coat gloss white		
FT38SS	Finishing trim (1")	Stainless steel	12	\$599

**ALTERNATE MEDIA KITS ARE AVAILABLE TO REPLACE GLASS BEADS SUPPLIED WITH UNIT**

LDNS	Designer Fire Art - Nickel Stix	Nickel plated	9	\$535
DLE	Beach Fire Kit, 4 Driftwood Logs(maximum 2 sets)		4	\$155
MKE38	Shore Fire Kit: Mixture of rocks, sand, crushed topaz glass, and vermiculite with sand pans (maximum 1 set)		13	\$275
REK	Mineral rock kit, mixture of multi-color rocks ( 2 suggested)		2	\$209
 MKRY*	Media kit (2 suggested)	River rocks - grey	10	\$139
MKRM*	Media kit (2 suggested)	River rocks - multi-coloured	10	\$139

**NOTE: ANY COLOUR COMBINATION OF THE GLASS BEADS CAN BE USED - DO NOT EXCEED 10 LBS**

 MKBK	Media kit	Glass beads - black	5	\$75
MKBB	Media kit	Glass beads - blue	5	\$75
MKBR	Media kit	Glass beads - red	5	\$75
MKBA	Media kit	Glass beads - amber	5	\$75
MKBC	Media kit	Glass beads - clear	5	\$75
MKBT	Media kit	Glass beads - topaz	5	\$75
 MKGK	Media kit	Glass embers - black	5	\$105
MKGB	Media kit	Glass embers - blue	5	\$105
MKGR	Media kit	Glass embers - red	5	\$105
MKGA	Media kit	Glass embers - amber	5	\$105
MKGC	Media kit	Glass embers - clear	5	\$105
MKGT	Media kit	Glass embers - topaz	5	\$105
 MEGK	Media enhancement kit 1 lb.	Glass embers - black	1	\$55
MEGB	Media enhancement kit 1 lb.	Glass embers - blue	1	\$55
MEGR	Media enhancement kit 1 lb.	Glass embers - red	1	\$55
MEGA	Media enhancement kit 1 lb.	Glass embers - amber	1	\$55
MEGT	Media enhancement kit 1 lb.	Glass embers - topaz	1	\$55

**HEAT CIRCULATION**

GA-566	Hot air distribution kit		11	\$409
--------	--------------------------	--	----	-------

**NOTE: Hot air distribution kit must be installed during fireplace installation - Electrical components: wire, switch, etc. not supplied**

**VENTING**

GD422R-1**	Round wall terminal kit		4	\$175
RP5**	Restrictor Plate (recommended for aggressive vertical venting)		2	\$25

\* Note: Grey and/or multi-coloured river rocks may be combined, if 2 kits are ordered.

\*\* Note: See Direct Vent Fireplaces - Venting Components for additional venting

This unit also suitable for Power Vent Kit - refer to GPV (power vent) price list for details



Effective: May 19, 2016

## LV50N-1 VECTOR™

### LV50N-1 VECTOR™ LINEAR GAS SERIES

Tested to ANSI Z21.50 AND CSA 2.22

Venting - 5" & 8"



• E FIRE Module for Blue Tooth Application	• Ceramic glass door	• Firestop
• Electronic ignition w/ battery backup	• Clear Glass beads w/ multi-color LED lighting	• Mobile home approved
• Stainless steel flex connector	• Non-combustible material included	• Proflame II hand held controller; Controls Flame, Night Light™ w/on/off/dimmer
• Adjustable flame/heat control w/ shutoff	• Dual receptable junction box	• Up to 40,000 BTU's
• Porcelain Reflective Panels		

US \$

Product	Model Description	Finish	WT/lbs.	MSRP/MAP
 LV50N-1	Linear Fireplace - Natural gas	Painted black	443	\$4,699
LV50N2-1	2-Sided See Thru Linear Fireplace - Natural gas	Painted black	407	\$5,199
W175-0409	Conversion kit - Natural gas to propane		2	\$55

#### DECORATIVE

MUST CHOOSE FLUSH FRAME OR SURROUND TO COMPLETE UNIT

 FF50K	Flush Frame with Safety Screen	Powder coat low sheen black	20	\$569
FF50W	Flush Frame with Safety Screen	Powder coat gloss white	20	\$675
FF50SS	Flush Frame with Safety Screen	Stainless steel	20	\$935
 S50K	Surround complete with Safety Screen	Powder coat low sheen black	20	\$715
S50W	Surround complete with Safety Screen	Powder coat gloss white	20	\$805
S50SS	Surround complete with Safety Screen	Stainless steel	20	\$1,089
S50HS	Surround complete with Safety Screen	Hammered steel	50	\$1,449

#### OPTIONS/ACCESSORIES

NOTE: FT50K/W/SS FOR USE WITH FF50K/W/SS SURROUND ONLY

 FT50K	Finishing trim (1")	Powder coat low sheen black	12	\$309
FT50SS	Finishing trim (1")	Stainless steel	12	\$675
FT50W	Finishing trim (1")	Powder coat gloss white	12	\$365

ALTERNATE MEDIA KITS ARE AVAILABLE TO REPLACE GLASS BEADS SUPPLIED WITH UNIT

LDNS	Designer Fire Art - Nickel Stix	Nickel plated	9	\$535
DLE	Media enhancement kit, Driftwood Logs(maximum 2 sets)		4	\$155
 MKE50	Media enhancement kit, mixture of rocks, sand and vermiculite complete with sand pans (maximum 1 set)		15	\$365
MKRY	* Media kit (2 suggested)	River rocks - grey	10	\$139
MKRM	* Media kit (2 suggested)	River rocks - multi-coloured	10	\$139

NOTE: ANY COLOUR COMBINATION OF THE GLASS BEADS CAN BE USED - DO NOT EXCEED 10 lbs.

 MKBK	Media kit	Glass beads - black	5	\$75
MKBB	Media kit	Glass beads - blue	5	\$75
MKBR	Media kit	Glass beads - red	5	\$75
MKBA	Media kit	Glass beads - amber	5	\$75
MKBC	Media kit	Glass beads - clear	5	\$75
MKBT	Media kit	Glass beads - topaz	5	\$75

W361-0239-BULK AMBIENT-GLOW Fireplace Embers (master packs of 50)  
individual packages suggested retail of \$15.95

#### HEAT CIRCULATION

GA-566	Hot air distribution kit		11	\$409
--------	--------------------------	--	----	-------

NOTE: Hot air distribution kit must be installed during fireplace installation - Electrical components: wire, switch, etc. not supplied

#### VENTING

GD422R-1	** Round wall terminal kit		4	\$175
RP5	** Restrictor Plate (recommended for aggressive vertical venting)		2	\$25

\* Note: Grey and/or multi-coloured river rocks may be combined, if 2 kits are ordered.

\*\* Note: See Direct Vent Fireplaces - Venting Components for additional venting

This unit also suitable for Power Vent Kit - refer to GPV (power vent) price list for details



Effective: March 15, 2016

## WHD31NSB PLAZMAFIRE™

### WHD31NSB - PLAZMAFIRE™ WALL HANGING FIREPLACE

Tested as a heater to ANSI Z21.88 and CSA 2.33

Venting - 4" & 7"

- Electronic ignition
- Exclusive slate brick panel
- Firestop
- Ceramic glass
- Topaz glass embers
- Mobile home approved
- 4" x 7" x 20" rigid vent
- Dual receptable junction box
- Up to 20,000 BTU's

NOTE: All units are natural gas. If propane is required - please order conversion kit.



US \$

Product	Model Description	Finish	WT/lbs.	MSRP/MAP
 WHD31NSB	Plazmafire™ Wall Hanging Fireplace complete w/slate brick panel		105	\$1,759
W175-0327	Conversion kit - Natural gas to propane		2	\$55

#### OPTIONS/ACCESSORIES

##### DECORATIVE

##### MUST CHOOSE ONE SURROUND TO COMPLETE UNIT

	S31RKSB	* Rectangular surround, Includes Safety Barrier	Painted black	26	\$485
	S31RSSSB	* Rectangular surround, Includes Safety Barrier	Stainless steel	26	\$485
	S31RPSB	* Rectangular surround, Includes Safety Barrier	Diamond dust	26	\$485
	S31CVSSSB	* Convex surround, Includes Safety Barrier	Brushed stainless steel	30	\$665
	WHT31SB	** Trim for Convex Surround	Painted black	2	\$59
	LK31	Low voltage LED light kit (2) with switch, complete with wire harness		5	\$195



##### ALTERNATE MEDIA KITS ARE AVAILABLE TO REPLACE GLASS SUPPLIED WITH UNIT (TOPAZ)

	MKGG	Media kit	Glass embers - black	5	\$105
	MKGB	Media kit	Glass embers - blue	5	\$105
	MKGR	Media kit	Glass embers - red	5	\$105
	MKGA	Media kit	Glass embers - amber	5	\$105
	MKGC	Media kit	Glass embers - clear	5	\$105
	MKGT	Media kit	Glass embers - topaz	5	\$105

##### ALL MEDIA ENHANCEMENT KITS ARE DESIGNED FOR EITHER RANDOM PLACEMENT WITHIN THE FIREBOX AS AN ADDITION TO OR REPLACEMENT FOR THE TOPAZ EMBER BED SUPPLIED WITH THE UNIT

	MEGK	Media enhancement kit 1 lb.	Glass embers - black	1	\$55
	MEGB	Media enhancement kit 1 lb.	Glass embers - blue	1	\$55
	MEGR	Media enhancement kit 1 lb.	Glass embers - red	1	\$55
	MEGA	Media enhancement kit 1 lb.	Glass embers - amber	1	\$55
	MEGT	Media enhancement kit 1 lb.	Glass embers - topaz	1	\$55
	W361-0239-BULK	AMBIENT-GLOW Fireplace Embers (master packs of 50) individual packages suggested retail of \$15.95		2	\$799

##### CONTROLS

	W660-0081	Thermostat, wall mount - digital		1	\$69
	F45	Napoleon on/off hand held battery operated remote w/digital screen		1	\$95
	F45-6	Napoleon on/off hand held battery operated remote w/digital screen - bulk of 6		7	\$535
	F60	Napoleon hand held battery operated remote w/digital screen		1	\$149
	F60-6	Napoleon hand held battery operated remote w/digital screen - bulk of 6		7	\$859
	ACS-SIT	Anti-Condensation Switch		1	\$19

\* NOTE: All surrounds are fabricated to accept optional light kit on the underside.

\*\*NOTE: WHT31 Upper Trim is a decorative cover recommended only if the top of the surround is located below eye level





## WHVF31N / WHVF24N PLAZMAFIRE™

### WHVF31N PLAZMAFIRE™ VENT FREE 31 WALL HANGING FIREPLACE

Tested as a heater to ANSI Z21.11.2 titled Unvented Room Heaters

<ul style="list-style-type: none"> <li>• Electronic ignition</li> <li>• Catalytic filtering tiles</li> <li>• Ceramic glass</li> </ul>	<ul style="list-style-type: none"> <li>• Burner with decorative topaz embers</li> <li>• Exclusive slate brick panel</li> <li>• Multi-lever pan style burner</li> </ul>	<ul style="list-style-type: none"> <li>• Mobile home approved</li> <li>• Up to 20,000 BTU's</li> </ul>
---	--	--

US \$

	Product	Model Description	Finish	WT/lbs.	MSRP/MAP
	WHVF31N	Vent Free Plazmafire™ Wall Hanging Fireplace complete w/slate brick panel		92	\$1,829
	WHVF31P	Vent Free Plazmafire™ Wall Hanging Fireplace complete w/slate brick panel		92	\$1,829

#### OPTIONS/ACCESSORIES

##### DECORATIVE

**MUST CHOOSE ONE SURROUND TO COMPLETE UNIT**

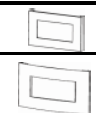
	Product	Model Description	Finish	WT/lbs.	MSRP/MAP
	S31RKSB	* Rectangular surround, Safety Barrier Approved	Painted black	26	\$485
	S31RPSB	* Rectangular surround, Safety Barrier Approved	Diamond dust	26	\$485
	S31CVSSSB	* Convex surround, Safety Barrier Approved	Brushed stainless steel	30	\$665
	WHT31SB	** Trim for Convex Surround, Safety Barrier Approved	Painted black	2	\$59
	LK31	Low voltage LED light kit (2) with switch, complete with wire harness		2	\$195
	GD567	Safety Screen		4	\$159

##### CONTROLS

	Product	Model Description	WT/lbs.	MSRP/MAP
	W660-0081	Thermostat, wall mount - digital	1	\$69
	F45	Napoleon on/off hand held battery operated remote w/digital screen	1	\$95
	F45-6	Napoleon on/off hand held battery operated remote w/digital screen - bulk of 6	7	\$535
	F60	Napoleon hand held battery operated remote w/digital screen	1	\$149
	F60-6	Napoleon hand held battery operated remote w/digital screen - bulk of 6	7	\$859

\* NOTE: All surrounds are fabricated to accept optional light kit on the underside.

### WHVF24N - PLAZMAFIRE™ 24 VENT FREE WALL HANGING FIREPLACE

Tested as a heater to ANSI Z21.11.2 titled Unvented Room Heaters

<ul style="list-style-type: none"> <li>• Electronic ignition</li> <li>• Catalytic filtering tiles</li> <li>• Ceramic glass</li> </ul>	<ul style="list-style-type: none"> <li>• Burner with decorative topaz embers</li> <li>• Gas flex connector</li> <li>• Wall template (mount screws not supplied)</li> </ul>	<ul style="list-style-type: none"> <li>• Mobile home approved</li> <li>• Up to 9,000 BTU's</li> </ul>
---	--	---

US \$

	Product	Model Description	WT/lbs.	MSRP/MAP
	WHVF24N	Vent Free Wall Hanging Fireplace complete w/catalytic tiles and curved glass front - natural gas	52	\$1,079
	WHVF24P	Vent Free Wall Hanging Fireplace complete w/catalytic tiles and curved glass front - propane	52	\$1,079



Effective: March 15, 2016

GI3600-4NSB ROXBURY™

**GI3600-4NSB ROXBURY™ GAS FIREPLACE INSERT**

Tested to ANSI Z21.50 and CSA 2.22

• Millivolt ignition	• Piezo ignitor	• Ceramic glass
• Phazer® Logs & charcoal embers	• Spill switch	• Up to 24,000 BTU's
• Stainless steel burner	• Heat circulating blower w/ variable speed control	• Adjustable flame/heat control

NOTE: All units are natural gas. If propane is required - please order conversion kit. US \$

Product	Model Description	Finish	WT/lbs.	MSRP/MAP
 GI3600-4NSB	Basic fireplace insert with glass - Natural gas	Painted black	75	\$1,969
W175-0172	Conversion kit - Natural gas to propane		2	\$59
FC-12	12" stainless steel gas flex connector & shut off (25/crtn)		18	\$535

NOTE: MUST ORDER A OR B SAFETY BARRIER TO COMPLETE UNIT

<b>A:</b>	SF36SB	Safety Barrier (Must order Faceplate)	Painted black	15	\$109
-----------	--------	---------------------------------------	---------------	----	-------

NOTE: MUST ORDER A FACEPLATE WITH SF36SB

NOTE: IF ORDER A FACEPLATE BELOW, MUST ORDER GIFK6SB OR GIFK9SB TO COMPLETE UNIT

FPGI36-BNSB	Faceplate (Required with SF36SB)	Brushed nickel	25	\$289
-------------	----------------------------------	----------------	----	-------

FPGI36-BCSB	Faceplate (Required with SF36SB)	Brushed copper	25	\$289
-------------	----------------------------------	----------------	----	-------

FPGI36-KSB	Faceplate (Required with SF36SB)	Painted black	25	\$215
------------	----------------------------------	---------------	----	-------

<b>B:</b>	S3600SB	Curved Safety Barrier (Must order Louvres)	Painted black	10	\$215
-----------	---------	--	---------------	----	-------

Flush louvre assemblies, Required With S3600SB CURVED SAFETY BARRIER

	GI-1LK	black upper and lower louvres	Painted black	3	\$105
	GI-1LPB	black upper and polished brass lower	Polished brass	3	\$105
	GI-1LAB	black upper & antique brass lower louvres	Antique brass	3	\$105
	GI-1LSS	black upper and brushed stainless steel lower louvres	Brushed stainless steel	3	\$105
	GI-1LG	gold plated (24 Karat) upper and lower louvres	Limited Quantities Available	2	\$309

**OPTIONS/ACCESSORIES**

**DECORATIVE**

NOTE: FLASHINGS OR CAST IRON SURROUND KIT MUST BE ORDERED TO COMPLETE INSTALLATION.

Basic flashing kits for openings less than 26"Hx42"W

\* Cast iron flashing kit for openings smaller than 29"H x 46"W

	GICSK	Arched cast iron surround	Painted black	80	\$395
	GIFBK6SB	6" flashing (req'd for GICSK attachment)	Painted black	9	\$205
	GI-941K-6	Bull nose outer trim	Black	2	\$209
	GI-63K	6" flashing	Black	5	\$125

	GI-2PB	2" Trim for GI-63K	Limited Quantities Available	2	\$215
---	--------	--------------------	------------------------------	---	-------

Basic flashing kits for openings less than 28"Hx47"W

GI-93K	9" flashing	Black	9	\$195
--------	-------------	-------	---	-------

Bevelled flashing (for openings smaller than 27"Hx42"W)

GI-910K	Bevelled flashing textured black - 6"	Black	10	\$185
---------	---------------------------------------	-------	----	-------

GI-942K	Trim for bevelled flashing black	Black	3	\$109
---------	----------------------------------	-------	---	-------

Deluxe flashing kits for openings smaller than 27"Hx42"W

GIFK6SB	6" Black (Required for SF36SB)	Painted black	12	\$235
---------	--------------------------------	---------------	----	-------

Deluxe flashing kits for openings smaller than 30"Hx48"W

GIFK9SB	9" Black (Required for SF36SB)	Painted black	20	\$269
---------	--------------------------------	---------------	----	-------

	GI-RB	Riser box (3"Hx45"W)		11	\$139
---	-------	----------------------	--	----	-------









Effective: March 15, 2016

GI3600-4NSB ROXBURY™

**GI3600-4NSB ROXBURY™ GAS FIREPLACE INSERT**

**CONTINUED**

<b>DECORATIVE</b>					
	<b>Product</b>	<b>Model Description</b>	<b>Finish</b>	<b>WT/lbs.</b>	<b>MSRP/MAP</b>
<b>*Cast iron surround for openings smaller than 28"H x 42"W</b>					
	CISK	Cast iron surround kit	Painted black	80	\$535
	CISKN	Cast iron surround kit	Porcelain enamel majolica brown	80	\$785
	GI814KT	Decorative brick panels	Sandstone	5	\$125
	PRP3600	Porcelain reflective radiant panels		5	\$129
	ANI-K	Andirons	Painted black	2	\$75
	ANI-G	Andirons	<b>Limited Quantities Available</b>	2	\$149
	W470-0002	Enamel touch up and brush (specify color)		1	\$15
	270-BULK	Paint, Thuralox - case of 12, black 13 oz.		12	\$235
<b>CONTROLS</b>					
	W660-0081	Thermostat, wall mount - digital		1	\$69
	F45	Napoleon on/off hand held battery operated remote w/digital screen		1	\$95
	F45-6	Napoleon on/off hand held battery operated remote w/digital screen - bulk of 6		7	\$535
	F60	Napoleon hand held battery operated remote w/digital screen		1	\$149
	F60-6	Napoleon hand held battery operated remote w/digital screen - bulk of 6		7	\$859
	GD-660	Remote wall switch with 20" wire	<b>Limited Quantities Available</b>	1	\$35



Effective: March 15, 2016

## GDIZC-NSB INSPIRATION™





### GDIZC-NSB INSPIRATION™ DIRECT VENT GAS FIREPLACE INSERT

Tested as a heater. Meets department of energy requirements as a wall furnace tested to both Z21.86, Z21.88 and CSA 2.32 and CSA 2.33

- Millivolt ignition
- Multi-flame pan burner
- Heat circulating blower w/ variable speed control
- Stainless steel gas flex connector w/ shutoff
- Piezo ignitor
- Exclusive Phazer® logs and embers
- Adjustable flame/heat control
- Mobile home approved
- Up to 24,000 BTU's
- Ceramic glass

NOTE: All units are natural gas. If propane is required - please order conversion kit.







US \$

	Product	Model Description	Finish	WT/lbs.	MSRP/MAP
	GDIZC-NSB	Basic fireplace insert with glass - Natural gas	Painted black	90	\$2,429
	W175-0162	Conversion kit - Natural gas to propane		2	\$59
	<b>NOTE: SAFETY BARRIER MUST BE ORDERED TO COMPLETE UNIT</b>				
	SZCSB	Safety Barrier	Painted black	10	\$109
	<b>Note: MUST ORDER A TRIM KIT TO COMPLETE UNIT</b>				
	Trim kits (3 sided) covers opening up to 20 1/4" Hx35 3/4" W				
	GIZTRM3	Aluminum Extrusion	Painted textured satin black	12	\$365
	GIZT3K	Contemporary Trim Kit	Painted black	15	\$365
	Trim kits (4 sided) covers openings up to 23 3/4" Hx35 3/4" W				
	GIZTRM4	Aluminum Extrusion	Painted textured satin black	17	\$429

#### OPTIONS/ACCESSORIES

	FPZC-BNSB	Faceplate	Brushed nickel	10	\$269
	FPZC-BCSB	Faceplate	Brushed copper	10	\$269
	FPZC-KSB	Faceplate	Painted black	10	\$185
	GIFBK6SB	6" flashing	Painted black	9	\$205
	GI-941K-6	bullnose outer trim	Black	2	\$209

#### DECORATIVE

	<b>Basic 3 sided backer plate: Designed to fit/cover fireplace openings/facing smaller than 26 1/4" Hx 44 3/4" W (also required if utilizing cast iron surround kit)</b>				
	GIZBP6-3	* 3 sided	Painted black	8	\$95
	<b>Basic 4 sided backer plate: Designed to fit/cover fireplace openings/facing smaller than 36 1/2" Hx44 3/4" W</b>				
	GIZBP6-4	4 sided	Painted black	11	\$105
	<b>Cast iron surround kit (finished outside dimension 32" Hx53 1/2" W)</b>				
	CISM-A	Cast iron surround kit	Painted black	80	\$535
	CISKN-A	Cast iron surround kit	Limited Quantities Available	70	\$785
	AK-4	* Adaptor kit for cast iron surround		1	\$29
	GI-RB	Riser box (3"Hx45"W)	Painted black	11	\$139
	GI823KT	Decorative brick panels	Sandstone	5	\$125
	PRPZC	Porcelain reflective radiant panels	Gloss black	5	\$139
	ANI-K	Andirons	Painted black	2	\$75
	ANI-G	Andirons	Limited Quantities Available	2	\$149
	270-BULK	Paint, Thurmalox - case of 12, black 13 oz.		12	\$235







Effective: March 15, 2016

GDIZC-NSB INSPIRATION™

**GDIZC-NSB INSPIRATION™ DIRECT VENT GAS FIREPLACE INSERT**

CONTINUED

<b>CONTROLS</b>				
	<b>Product</b>	<b>Model Description</b>	<b>WT/lbs.</b>	<b>MSRP/MAP</b>
	W660-0081	Thermostat, wall mount - digital	1	\$69
	F45	Napoleon on/off hand held battery operated remote w/digital screen	1	\$95
	F45-6	Napoleon on/off hand held battery operated remote w/digital screen - bulk of 6	7	\$535
	F60	Napoleon hand held battery operated remote w/digital screen	1	\$149
	F60-6	Napoleon hand held battery operated remote w/digital screen - bulk of 6	7	\$859
	GD-660	Remote wall switch with 20" wire	1	\$35
			<b>Limited Quantities Available</b>	
<b>VENTING KITS</b>				
<b>For optimum performance use two 3" liners (GDI-320, GDI-325 &amp; GDI-335) where space permits</b>				
	GDI-223	Terminal	4	\$175
	GDI-226	Terminal, High Wind Co-Linear	4	\$175
	GDI-2320KT	Vent kit 20ft. (1-2" & 1-3" double ply aluminum liner-inlet and exhaust & 2-3" to 2" reducer)	18	\$215
	GDI-2325KT	Vent kit 25ft. (1-2" & 1-3" double ply aluminum liner-inlet and exhaust & 2-3" to 2" reducer)	19	\$259
	GDI-2335KT	Vent kit 35ft. (1-2" & 1-3" double ply aluminum liner-inlet and exhaust & 2-3" to 2" reducer)	20	\$335
	GDI-320KT	Vent kit 20ft. (2-3" double ply aluminum liner-inlet and exhaust)	18	\$199
	GDI-325KT	Vent kit 25ft. (2-3" double ply aluminum liner-inlet and exhaust)	19	\$245
	GDI-335KT	Vent kit 35ft. (2-3" double ply aluminum liner-inlet and exhaust)	20	\$325

\*Note: Adapter kit (AK-4) and 3 sided backer plate (GIZBP6-3) required to install cast iron surround.



Effective: March 15, 2016

## GDI-30NSB ROXBURY™



### GDI-30NSB ROXBURY™ DIRECT VENT GAS FIREPLACE INSERT

Tested as a heater to ANSI Z21.88 and CSA 2.33







- Millivolt ignition
- Phazer® Logs & charcoal embers
- Adjustable flame/heat control
- Piezo ignitor
- Heat circulating blower w/ variable speed control
- Ceramic glass
- Up to 24,500 BTU's

NOTE: All units are natural gas. If propane is required - please order conversion kit.

US \$

Product	Model Description	Finish	WT/lbs.	MSRP/MAP
	GDI-30NSB Basic fireplace insert c/w glass door	Painted black	90	\$2,429
	W175-0216 Conversion kit		2	\$55
	FC-12 12" stainless steel gas flex connector & shut off (25/crtn)		18	\$535
<b>NOTE: MUST ORDER A OR B SAFETY BARRIER TO COMPLETE UNIT</b>				
<b>A:</b>	SF30SB Safety Barrier (Must order Faceplate)	Painted black	15	\$109
<b>NOTE: MUST ORDER A FACEPLATE WITH SF30SB</b>				
<b>NOTE: IF ORDER A FACEPLATE BELOW, MUST ORDER GIFK6SB OR GIFK9SB TO COMPLETE UNIT</b>				
	FPG30-BNSB Faceplate (Required with SF30SB)	Brushed nickel	30	\$289
	FPG30-BCSB Faceplate (Required with SF30SB)	Brushed copper	30	\$289
	FPG30-KSB Faceplate (Required with SF30SB)	Painted black	30	\$215
<b>B:</b>	S30SB Curved Safety Barrier (Must order Louvres)	Painted black	15	\$215
<b>Flush louvre assemblies, Required With S30SB CURVED SAFETY BARRIER</b>				
	GI-1LK Black upper and lower louvres	Painted black	3	\$105
	GI-1LPB Black upper and polished brass lower	Polished brass	3	\$105
	GI-1LAB Black upper & antique brass lower louvres	Antique brass	3	\$105
	GI-1LSS Black upper and brushed stainless steel lower louvres	Brushed stainless steel	3	\$105
	GI-1LG Gold plated (24 upper and lower louvres)	Limited Quantities Available	2	\$309

### OPTIONS/ACCESSORIES

DECORATIVE				
	**MKRY Media kit (replaces log set supplied with unit)	River rocks - grey	10	\$139
	**MKRM Media kit (replaces log set supplied with unit)	River rocks - multicoloured	10	\$139
<b>**Rock adaptor kit (must be ordered in conjunction with MKRY or MKRM)</b>				
	**RAK30 Rock adaptor kit (must be ordered in conjunction with MKRY or MKRM)		1	\$29
<b>NOTE: FLASHINGS OR CAST IRON SURROUND KIT MUST BE ORDERED TO COMPLETE INSTALLATION.</b>				
	GICSK Arched cast iron surround	Painted black	80	\$395
	GIFBK6SB 6" flashing (req'd for GICSK attachment)	Painted black	9	\$205
<b>Deluxe flashing kits for openings smaller than 27"Hx42"W</b>				
	GIFK6SB 6" Black (Required for SF30SB)	Painted black	12	\$235
<b>Deluxe flashing kits for openings smaller than 30"Hx48"W</b>				
	GIFK9SB 9" Black (Required for SF30SB)	Painted black	20	\$269
<b>Bevelled flashing (for openings smaller than 27"Hx42"W)</b>				
	GI-910K Bevelled flashing textured 6"	Black	10	\$185
	GI-942K Trim for bevelled flashing	Black	3	\$109
<b>NOTE: GI-942K Border Trim for use with the GI-910K Beveled Flashing Kit only</b>				









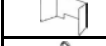

Effective: March 15, 2016

GDI-30NSB ROXBURY™

GDI-30NSB ROXBURY™ DIRECT VENT GAS FIREPLACE INSERT

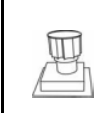
CONTINUED

DECORATIVE (con't)					
	Product	Model Description	Finish	WT/lbs.	MSRP/MAP
	GI-RB	Riser box (3"Hx45"W)		11	\$139
	CISK	Cast iron surround kit	Painted black	80	\$535
	CISKN	Cast iron surround kit	Porcelain enamel majolica brown	80	\$785
	GI829KT	Decorative brick panels	Sandstone	5	\$125
	PRP30	Porcelain reflective radiant panels		5	\$135
	ANI-K	Andirons	Painted black	2	\$75
	ANI-G	Andirons	Limited Quantities Available	2	\$149
	W470-0002	Enamel touch up and brush (specify color)		1	\$15
	270-BULK	case of 12, black 13 oz.		12	\$235
CONTROLS					
	W660-0081	Thermostat, wall mount - digital		1	\$69
	F45	Napoleon on/off hand held battery operated remote w/digital screen		1	\$95
	F45-6	Napoleon on/off hand held battery operated remote w/digital screen - bulk of 6		7	\$535
	F60	Napoleon hand held battery operated remote w/digital screen		1	\$149
	F60-6	Napoleon hand held battery operated remote w/digital screen - bulk of 6		7	\$859
	GD-660	Remote wall switch with 20" wire	Limited Quantities Available	1	\$35
VENTING KITS					
For optimum performance use two 3" liners (GDI-320, GDI-325 & GDI-335) where space permits					
	GDI-223	Terminal		1	\$175
	GDI-226	Terminal, High Wind Co-Linear		4	\$175
	GDI-2320KT	Vent kit 20ft. (1-2" & 1-3" double ply aluminum liner-inlet and exhaust & 2-3" to 2" reducer)		18	\$215
	GDI-2325KT	Vent kit 25ft. (1-2" & 1-3" double ply aluminum liner-inlet and exhaust & 2-3" to 2" reducer)		19	\$259
	GDI-2335KT	Vent kit 35ft. (1-2" & 1-3" double ply aluminum liner-inlet and exhaust & 2-3" to 2" reducer)		20	\$335
	GDI-320KT	Vent kit 20ft. (2-3" double ply aluminum liner-inlet and exhaust)		18	\$199
	GDI-325KT	Vent kit 25ft. (2-3" double ply aluminum liner-inlet and exhaust)		19	\$245
	GDI-335KT	Vent kit 35ft. (2-3" double ply aluminum liner-inlet and exhaust)		20	\$325



Effective: March 15, 2016

## IR3 INFRARED SERIES

### IR3 INFRARED SERIES DIRECT VENT GAS FIREPLACE INSERTS

Tested as a heater to ANSI Z21.88 and CSA 2.33



<ul style="list-style-type: none"> <li>• Electronic ignition w/ battery backup</li> <li>• Adjustable flame/heat control</li> <li>• Pivoted heat resistant ceramic glass door</li> </ul>	<ul style="list-style-type: none"> <li>• Mobile home approved</li> <li>• Remote control</li> <li>• Optional Blower</li> </ul>	<ul style="list-style-type: none"> <li>• Night Light™</li> </ul>
---	---	--

NOTE: All units are natural gas. If propane is required - please order conversion kit.



US \$







Product	Model Description	Finish	WT/lbs.	MSRP/MAP
				
<b>IR3 SERIES DIMENSIONS: 21" H x 28 3/4" W x 13 1/4" D</b> <b>Note: One decorative brick or porcelain reflective panel and front/surround or cast iron surround must be ordered to complete installation</b>				
IR3N-1SB	Basic fireplace insert (24,000 BTU'S) C/W RADIANT PHAZER® IRONWOOD LOG SET		100	\$2,029
IR3GNSB	Basic fireplace insert (24,000 BTU'S) C/W NIGHT LIGHT, RIBBON BURNER, TOPAZ CRYSTALLINE EMBER BED AND PORCELAIN PANELS		106	\$2,339
W175-0342	Conversion kit - Natural gas to propane		2	\$75
XIR3NSB	Deluxe fireplace insert (31,000 BTU'S) C/W NIGHT LIGHT, RADIANT PHAZER® IRONWOOD LOG SET		106	\$2,559
W175-0338	Conversion kit - Natural gas to propane		2	\$75
<b>MANDATORY REQUIREMENTS</b>				
<b>MUST ORDER THE FOLLOWING SAFETY SCREEN</b>				
I3SB	Safety Screen, Safety Barrier Approved (not required when ordering CI3SSB, I3CRFKSB, I3CRFSSSB, I3DZMKSB, I3DZWISB, I3DPSSB)		5	\$145

### OPTIONS/ACCESSORIES - COMMON TO ALL MODELS

DECORATIVE					
	**MKRY3	Media kit (replaces log set supplied with unit)	River rocks - grey	10	\$189
<b>**Note: MKRY3 NOT SUITABLE FOR IR3G INSERT</b>					
	**GI-RB	Riser box (3"Hx45"W)	Painted black	11	\$139

CONTROLS					
	ACS-SIT	Anti-Condensation Switch		1	\$19

VENTING KITS					
	GDI-226	Terminal, High Wind Co-Linear		4	\$175
	GDI-223	Terminal		4	\$175
	GDI-320KT	Vent kit 20ft. (2-3" double ply aluminum liner-inlet and exhaust)		18	\$199
	GDI-325KT	Vent kit 25ft. (2-3" double ply aluminum liner-inlet and exhaust)		19	\$245
	GDI-335KT	Vent kit 35ft. (2-3" double ply aluminum liner-inlet and exhaust)		20	\$325

OPTIONS/ACCESSORIES					
	I3S6	5 Pce. Surround (for openings smaller than 25 1/2 h x 37 1/2 w)	Painted black	12	\$185
	I3S7	5 Pce. Surround (for openings smaller than 28 h x 42 w)	Painted black	12	\$195
	I3S9	5 Pce. Surround (for openings smaller than 30 h x 48 w)	Painted black	18	\$215
	I3DS6	1 Pce. Surround (for openings smaller than 25 1/2 h x 37 1/2 w)	Painted black	15	\$269
	I3DS9	1 Pce. Surround (for openings smaller than 30 h x 48 w)	Painted black	26	\$375
	CI3SSB	Cast Iron Surround kit complete with Safety Barrier (for openings smaller than 29 h x 46 w)	Painted black	92	\$915





Effective: March 15, 2016

## IR3 INFRARED SERIES

### IR3 INFRARED SERIES DIRECT VENT GAS FIREPLACE INSERTS

CONTINUED

#### OPTIONS/ACCESSORIES

	Product	Model Description	Finish	WT/lbs.	MSRP/MAP
	I3CRFKSB	Contemporary Rectangular Front, With Safety Barrier (32 1/2" W X 23" H)	Porcelain black	24	\$515
	I3CRFHC	Contemporary Rectangular Front (32 1/2" W X 23" H)	Limited Quantities Available	27	\$465
	I3CRFSSSB	Contemporary Rectangular Front, With Safety Barrier (32 1/2" W X 23"H)	Satin chrome plated	24	\$699
	I3DZMKSB	Zen Modern door, With Safety Barrier	Painted black	21	\$699
	I3DZWISB	Zen Modern door, With Safety Barrier	Wrought iron	22	\$699
	I3DPSSB	Premium Scalloped Artisan Steel Door, With Safety Barrier	Wrought iron	22	\$805
	I3FS6	Premium Scalloped Steel Frame (for I3DS6 and I3S6)	Limited Quantities Available	15	\$289
	I3FS9	Premium Scalloped Steel Frame (for I3DS9 and I3S9)	Limited Quantities Available	20	\$325
	PRP3	Porcelain reflective radiant panels	Black	9	\$129
	GI83	Deluxe decorative brick panels	Newport	5	\$205
	GI85	Old England decorative brick panel	Grey	5	\$215
	<b>ALTERNATE MEDIA KITS ARE AVAILABLE TO REPLACE TOPAZ EMBER BED SUPPLIED WITH IR3G</b>				
	MK GK	Media kit	Glass embers - black	5	\$105
	MK GB	Media kit	Glass embers - blue	5	\$105
	MK GR	Media kit	Glass embers - red	5	\$105
	MK GA	Media kit	Glass embers - amber	5	\$105
	MK GC	Media kit	Glass embers - clear	5	\$105
	MK GT	Media kit	Glass embers - topaz	5	\$105
	<b>ALL MEDIA ENHANCEMENT KITS ARE DESIGNED FOR RANDOM PLACEMENT WITHIN THE FIREBOX AS AN ADDITION TO EITHER THE TOPAZ EMBER BED OR ANY OF THE OTHER OPTIONAL MEDIA KITS</b>				
	ME GK	Media enhancement kit 1 lb.	Glass embers - black	1	\$55
	ME GB	Media enhancement kit 1 lb.	Glass embers - blue	1	\$55
	ME GR	Media enhancement kit 1 lb.	Glass embers - red	1	\$55
	ME GA	Media enhancement kit 1 lb.	Glass embers - amber	1	\$55
	ME GT	Media enhancement kit 1 lb.	Glass embers - topaz	1	\$55
	I3BK	Blower Kit (For IR3N & IR3N-1 Only)		8	\$235
	XI3BK	Blower Kit (For IR3G & XIR3 Only - Controlled By Remote Supplied with Unit)		8	\$205



Effective: March 15, 2016

## XIR4N-1SB INFRARED SERIES















### XIR4N-1SB INFRARED SERIES DIRECT VENT GAS FIREPLACE INSERTS

Tested as a heater to ANSI Z21.88 and CSA 2.33

- Electronic ignition w/ battery backup
- Adjustable flame/heat control
- Pivoted heat resistant ceramic glass door
- Mobile home approved
- Remote control
- Blower
- Night Light™

NOTE: All units are natural gas. If propane is required - please order conversion kit.

US \$

Product	Model Description	Finish	WT/lbs.	MSRP/MAP	
	<b>XIR4N-1 SERIES DIMENSIONS: 24 1/2" H x 33 5/8" W x 16 5/8" D</b>				
	<b>Note: front/surround or cast iron surround must be ordered to complete installation</b>				
XIR4N-1SB	Large Deluxe fireplace insert (40,000 BTU'S) C/W NIGHT LIGHT, RADIANT PHAZER® IRONWOOD LOG SET		118	\$2,779	
W175-0364	Conversion kit - Natural gas to propane		2	\$75	
<b>MANDATORY REQUIREMENTS</b>					
<b>MUST ORDER THE FOLLOWING SAFETY SCREEN</b>					
	I4SB	Safety Screen, Safety Barrier Approved (not required when ordering I4CRFKSB, I4CRFSSSB, I4DZMKSB, I4DZWISB or I4DPSSB)	5	\$165	
<b>OPTIONS/ACCESSORIES</b>					
<b>DECORATIVE</b>					
	**MKRY3	Media kit (replaces log set supplied with unit)	River rocks - grey	10	\$189
	**MKRY4	Media kit (replaces log set supplied with unit)	River rocks - grey	10	\$209
<b>CONTROLS</b>					
	ACS-SIT	Anti-Condensation Switch		1	\$19
<b>VENTING KITS</b>					
	GDI-223	Terminal		4	\$175
	GDI-320KT	Vent kit 20ft. (2-3" double ply aluminum liner-inlet and exhaust)		18	\$199
	GDI-325KT	Vent kit 25ft. (2-3" double ply aluminum liner-inlet and exhaust)		19	\$245
	GDI-335KT	Vent kit 35ft. (2-3" double ply aluminum liner-inlet and exhaust)		20	\$325
<b>Note: One decorative brick or porcelain reflective panel and front/surround must be ordered to complete installation.</b>					
	I4S9	5 Pce. Surround (for openings smaller than 30 h x 48 w )	Painted black	18	\$215
	I4S7	5 Pce. Surround (for openings smaller than 29 h x 42 w )	Painted black	18	\$195
	I4DS9	1 Pce. Surround (for openings smaller than 30 h x 48 w )	Painted black	15	\$375
	I4CRFKSB	Contemporary Rectangular Front, With Safety Barrier (37 5/8" W x 27 1/16" H)	Porcelain black	24	\$515
	I4CRFSSSB	Contemporary Rectangular Front, With Safety Barrier (37 5/8" W x 27 1/16" H)	Satin chrome plated	24	\$749
	I4DZMKSB	Zen Modern Front, With Safety Barrier	Painted black	24	\$805
	I4DZWISB	Zen Modern Front, With Safety Barrier	Wrought iron	24	\$805
	I4DPSSB	Premium Scalloped Artisan Steel Door, With Safety Barrier (Single door)	Wrought iron	22	\$915
	I3FS9	Premium Scalloped Steel Frame (for I4S9 and I4DS9)	<b>Limited Quantities Available</b>	20	\$325
	PRP4-1	Porcelain reflective radiant panels	Black	9	\$165
	GI84-1	Deluxe decorative brick panels	Newport	5	\$205
	GI86-1	Old England decorative brick panel	Grey	5	\$215



## GL18/24/30 FIBERGLOW™

### GL18/24/30 FIBERGLOW™ GAS LOG SETS

Certified in Canada and U.S. to CGA 2.26 & ANSI Z21.60. Suitable for installation into a solid fuel burning appliance

**Vented Log Set**

- Electronic ignition
- Grate
- Andirons
- 5lbs Lava rock/cinders
- Damper clamp
- Exclusive Phazer® logs and embers
- Adjustable flame/heat control
- 50% flame/heat adjustment

NOTE: All units are natural gas. If propane is required - please order conversion kit.



US \$

Product	Model Description	WT/lbs.	MSRP/MAP
GL18NE	18" Log set (BTU's 55,000) - Natural gas	38	\$699
W175-0347	Conversion Kit - Natural gas to propane	2	\$55
GL24NE	24" Log set (BTU's 60,000) - Natural gas	39	\$749
W175-0348	Conversion Kit - Natural gas to propane	2	\$55
GL30NE	30" Log set (BTU's 65,000) - Natural gas	53	\$859
W175-0346	Conversion Kit - Natural gas to propane	2	\$55

Packaged in one carton, unitized burner/log system, for ease of installation



### OPTIONS/ACCESSORIES

DECORATIVE					
	MKRY	Media kit (2 suggested)	River rocks - grey	10	\$139
	MKRM	Media kit (2 suggested)	River rocks - multi-coloured	10	\$139
CONTROLS					
	W660-0081	Thermostat, wall mount - digital		1	\$69
	F45	Napoleon on/off hand held battery operated remote w/digital screen		1	\$95
	F45-6	Napoleon on/off hand held battery operated remote w/digital screen - bulk of 6		7	\$535
	F60	Napoleon thermostatic hand held battery operated remote w/digital screen		1	\$149
	F60-6	Napoleon thermostatic hand held battery operated remote w/digital screen - bulk of 6		7	\$859
	BPD	Battery Pack (D Cell)		1	\$35
	W550-0006	Additional Lava rock/cinders	Limited Quantities Available	5	\$65
	GD-660	Remote wall switch with 20' wire	Limited Quantities Available	2	\$35
MISC					
	ADDBGL-1	Display stand		80	\$645



## GL22/28/32 REVERSIBLE SERIES

### GL22/28/32 REVERSIBLE SERIES GAS LOG SETS

Certified in Canada and U.S. A. to CSA 2.26 & ANSI Z21.60. Suitable for installation into a solid fuel burning appliance

**Vented Log Set**

- Electronic ignition
- Grate
- Sand (NG models)
- Glass (LP models)
- Damper clamp
- Exclusive Phazer® logs and embers
- Charcoal, glowing embers
- Charcoal lumps

US \$



Product	Model Description	WT/lbs.	MSRP/MAP
GL22N	22" Log set (6 logs included), 70,000 BTU'S - Natural gas	47	\$969
GL22P	22" Log set (6 logs included), 50,000 BTU'S - Propane	47	\$969
GL28N	28" Log set (6 logs included), 80,000 BTU'S - Natural gas	60	\$1,079
GL28P	28" Log set (6 logs included), 65,000 BTU'S - Propane	60	\$1,079
GL32N	32" Log set (7 logs included), 90,000 BTU's - Natural gas	71	\$1,179
GL32P	32" Log set (7 logs included), 65,000 BTU's - Propane	71	\$1,179

Packaged in one carton, unitized burner/log system, for ease of installation



### OPTIONS/ACCESSORIES

#### CONTROLS

	F45	Napoleon on/off hand held battery operated remote w/digital screen	1	\$95	
	GLRKT	Hand held remote control (includes 2 fibre log pieces to conceal the receiver)	5	\$159	
	GD-660	Remote wall switch with 20' wire	Limited Quantities Available	2	\$35

#### MISC

ADDBGL-1	Display stand	80	\$645
----------	---------------	----	-------



Effective: March 15, 2016

## GVFL18/24/30 FIBERGLOW™

### GVFL FIBERGLOW™ VENT FREE GAS LOG SETS

Certified in U.S. to ANSI Z21.11.2 unvented room heaters and ANSI Z21.60 vented decorative appliances for installation in solid fuel burning fireplaces.

**Vent Free Gas Log Sets**

<ul style="list-style-type: none"> <li>• Millivolt ignition</li> <li>• Grate</li> <li>• Adjustable flame/heat control</li> <li>• Oxygen Depletion Sensor (ODS)</li> </ul>	<ul style="list-style-type: none"> <li>• Damper clamp</li> <li>• Exclusive Phazeramic™ burner and logs + embers</li> <li>• Piezo ignitor + 50% heat/flame adjustment</li> <li>• Andirons</li> </ul>
---	---

SUITABLE FOR INSTALLATION AS AN UNVENTED GAS LOG HEATER OR VENTED DECORATIVE APPLIANCE



US \$

Product	Model Description	WT/lbs.	MSRP/MAP
GVFL18N	18" Log set (BTU's 40,000) - Natural gas	38	\$749
GVFL18P	18" Log set (BTU's 40,000) - Propane	38	\$749
GVFL24N	24" Log set (BTU's 40,000) - Natural gas	39	\$809
GVFL24P	24" Log set (BTU's 40,000) - Propane	39	\$809
GVFL30N	30" Log set (BTU's 40,000) - Natural gas	53	\$969
GVFL30P	30" Log set (BTU's 40,000) - Propane	53	\$969

Packaged in one carton, unitized burner/log system, for ease of installation.



### OPTIONS/ACCESSORIES

CONTROLS			
	W660-0081	Thermostat, wall mount - digital	\$69
	F45	Napoleon on/off hand held battery operated remote w/digital screen	\$95
	F45-6	Napoleon on/off hand held battery operated remote w/digital screen - bulk of 6	\$535
	F60	Napoleon thermostatic hand held battery operated remote w/digital screen	\$149
	F60-6	Napoleon thermostatic hand held battery operated remote w/digital screen - bulk of 6	\$859
	W550-0006	Additional Lava rock/cinders	Limited Quantities Available \$65
	GD-660	Remote wall switch with 20' wire	Limited Quantities Available \$35
MISC			
	ADDBGL-1	Display stand	\$645



## ZCVF36 / ZCVF42

### ZCVF36 FIRE BOX



Certified in U.S. to ANSI Z21.91 as a ventless firebox enclosure for gas fired unvented room heaters

<ul style="list-style-type: none"> <li>• Fireplace screen</li> <li>• Blower - ready circulating chamber</li> <li>• Cobblestone refractory base</li> <li>• 5 knockouts for ease of gas connection</li> </ul>
---

US \$

	Product	Model Description	Finish	WT/lbs.	MSRP/MAP
	ZCVF36	Firebox 36"		98	\$539

### OPTIONS/ACCESSORIES

	DECORATIVE				
	GD810-KT	36" Brick kit	Cobblestone	8	\$175
	TBZC36K	36" 3" bevelled trim	Limited Quantities Available	4	\$189
	HEAT CIRCULATION				
	GZ550-1KT	Blower kit with variable speed and thermostatic control		5	\$289
	111KT	Outside air kit, 4ft. Insul. Flex and through the wall vent		2	\$95
	112KT	Adaptor plate for outside air kit		1	\$25



### ZCVF42 FIRE BOX

Unit includes: Fireplace screen, blower-ready circulating chamber, cobblestone refractory base, 5 knockouts for ease of gas connection.

US \$

	Product	Model Description	Finish	WT/lbs.	MSRP/MAP
	ZCVF42	Firebox 42"		113	\$649

### OPTIONS/ACCESSORIES

	DECORATIVE				
	GD809-KT	42" Brick kit	Cobblestone	10	\$199
	HEAT CIRCULATION				
	GZ550-1KT	Blower kit with variable speed and thermostatic control		5	\$289
	111KT	Outside air kit, 4ft. Insul. Flex and through the wall vent		2	\$95
	112KT	Adaptor plate for outside air kit		1	\$25





S SERIES

S SERIES EPA WOOD BURNING STOVE

Venting 6"

- Comes eady for installation
- Pedestal base
- Cast iron bar
- Slide out ash drawer

US \$

	Product	Model Description	Finish	WT/lbs.	MSRP/MAP
	S1	Small woodstove c/w pedestal, cast iron door and ash pan	Metallic charcoal	400	\$1,759
	S4	Medium woodstove c/w pedestal, cast iron door and ash pan	Metallic charcoal	430	\$1,919
	S9	Large woodstove c/w pedestal, cast iron door and ash pan	Metallic charcoal	460	\$2,279

OPTIONS/ACCESSORIES

DECORATIVE

W470-0038	Paint, metallic charcoal 13 oz. MUST ORDER IN MULTIPLES OF 12 - Stove Bright 6201	12	\$25
-----------	---	----	------

HEAT CIRCULATION

	EP65M	Blower kit with variable speed and thermostatic control	7	\$309
	111KT	Outside air kit - 4 feet insulated flexpipe (4" dia.) with through the wall vent	3	\$95
	W475-0870	Outside air pedestal back plate (require with 111KT)	1	\$25
	DTS4-SS	Door accent trim	2	\$75

MISC

62140	Heat Resistant Gloves	1	\$55
-------	-----------------------	---	------





1400 HUNTSVILLE™

1400 HUNTSVILLE™ DELUXE EPA WOOD BURNING STOVES	
<b>Venting 6"</b>	
<ul style="list-style-type: none"> <li>• Pedestal</li> <li>• Louvres</li> <li>• Black trivet</li> <li>• Ash pan w/ lid</li> </ul>	

BLACK PAINTED LOUVRES ARE STANDARD ON PEDESTAL UNITS ONLY.

NOTE: DOOR MUST BE ORDERED SEPARATELY.

US \$

	Product	Model Description	Finish	WT/lbs.	MSRP/MAP
	1400M	Medium wood stove	Metallic black	400	\$1,829



MODEL EPA STOVE WITH LEG OPTIONS

NOTE: DOOR AND LEGS MUST BE ORDERED SEPARATELY.

UNIT INCLUDES: REAR SHIELD WITH HOT AIR CIRCULATION DEFLECTOR.



	Product	Model Description	Finish	WT/lbs.	MSRP/MAP
	1400ML	Medium wood stove	Metallic black	325	\$1,239
	200M	Traditional steel legs	Metallic black	8	\$175
	202CM	Ornamental cast iron legs	Metallic black	12	\$205
	202CG	Ornamental cast iron legs	Gold plated (24 karat) - <b>Limited Quantities Available</b>	12	\$485
	202CSS	Ornamental cast iron legs	Stainless Steel	12	\$485
	*115KT	Outside air kit, 4ft. Insul. Flex and through the wall vent		2	\$85
	EPAD-1KT	Ash drawer kit (suitable for - 1 leg models only)	<b>Limited Quantities Available</b>	8	\$215
	EPAD-KTM	Ash drawer kit (suitable for - 1 leg models only)	Metallic black	8	\$215

DOORS (Matching spring handles for door and air control are included with door)

	Product	Model Description	Finish	WT/lbs.	MSRP/MAP
	H222M	Cast iron door - standard arch	Metallic black	25	\$305
	H222-G	Cast iron door - standard arch	Gold plated (24 Karat)	25	\$535
	H222-SS	Cast iron door - standard arch	Satin chrome plated	25	\$535
	H222-GW	Cast iron door - Early American webbed arch	<b>Limited Quantities Available</b>	25	\$569

OPTIONS/ACCESSORIES

DECORATIVE

	Product	Model Description	Finish	WT/lbs.	MSRP/MAP
	CL28G	Louvres and acrylic trim for pedestal models	Gold plated (24 karat) - <b>Limited Quantities Available</b>	1	\$85
	CL28SS	Louvres and acrylic trim for pedestal models	Satin chrome plated - <b>Limited Quantities Available</b>	1	\$85
	GS200-G	Ornamental trivet for model 1100	Gold plated (24 Karat)	1	\$109
	GS200-SS	Ornamental trivet for model 1100	Satin chrome plated	1	\$109
	CM30	COOKMATE (fits 1400 and 1900 pedestal series only)		6	\$159
	W325-0043	Spring door handle (large)	Black	1	\$9
	W325-0045	Spring door handle (large)	Brass	1	\$9
	W325-0033	Spring door handle (large)	Satin chrome	1	\$9
	W325-0042	Spring air control handle (small)	Black	1	\$9
	W325-0044	Spring air control handle (small)	Brass	1	\$9
	W325-0032	Spring air control handle (small)	Satin chrome	1	\$9
	W470-0002	Enamel touch up and brush (Specify colour)		1	\$15
	270-BULK	Paint, Thuralox -Case of 12, black 13 oz.		12	\$235
	209M-BULK	Paint, Forrest - metallic black 12 oz. (Case of 12)		1	\$300

\*115KT Requires EPAD-KT to complete Outside Air Connection - Suitable for Leg Models Only





1400 HUNTSVILLE™

**1400 HUNTSVILLE™ DELUXE EPA WOOD BURNING STOVES**

CONTINUED

<b>HEAT CIRCULATION</b>				
<b>Product</b>	<b>Model Description</b>	<b>Finish</b>	<b>WT/lbs.</b>	<b>MSRP/MAP</b>
EPLK	Air circulation chamber louvres (for "L" models only)	Painted black - <b>Limited Quantities Available</b>	2	\$59
EPLM	Air circulation chamber louvres (for "L" models only)	Metallic black	2	\$59
EPLG	Air circulation chamber louvres (for "L" models only)	Gold plated (24 karat) - <b>Limited Quantities Available</b>	2	\$119
EPLSS	Air circulation chamber louvres (for "L" models only)	Satin chrome plated - <b>Limited Quantities Available</b>	2	\$95
	EP62-1	Variable speed blower <b>Limited Quantities Available</b>	5	\$269
	EP62M	Variable speed blower	Metallic black	5
EP36	Thermostatic sensor control		1	\$49
W320-0011M	Blower guard (for "L" models only)	Metallic black	1	\$25
111KT	Outside air kit, 4ft. Insul. Flex and through the wall vent		2	\$95
W500-0064M-SER	Fresh air cover plate (for pedestal models only)	Metallic black	1	\$25
<b>MISC</b>				
62140	Heat Resistant Gloves		1	\$55

\* Note: IF using the EP62-1 blower on a woodstove WITH LEGS then the blower guard W320-0011M must be installed



Effective: March 15, 2016

## 1450M INDEPENDENCE™

### 1450M EPA INDEPENDENCE™ WOOD BURNING STOVE

*Venting 6"*

- Comes ready for installation
- Pedestal base
- Cast iron door

US \$

	Product	Model Description	Finish	WT/lbs.	MSRP/MAP
	1450M	Medium woodstove c/w pedestal and cast iron door	Metallic black	355	\$1,559

#### OPTIONS/ACCESSORIES

##### DECORATIVE

	209M-BULK	Paint, Forrest - metallic black 12 oz. (Case of 12)		1	\$300
---	-----------	---	--	---	-------

##### HEAT CIRCULATION

	EP62M	Variable speed blower	Metallic black	5	\$269
	EP36	Thermostatic sensor control	Painted black	1	\$49
	111KT	Outside air kit - 4 feet insulated flexpipe (4" dia.) with through the wall vent		3	\$95
	W475-0217	Outside air pedestal back plate (require with 111KT)		1	\$25

##### MISC

	62140	Heat Resistant Gloves		1	\$55
--	-------	-----------------------	--	---	------



## 1100C BANFF™ SERIES

### 1100C/1400C BANFF™ SERIES CAST IRON EPA WOOD BURNING STOVES

- Full front w/ concealed hinges
- Ceramic glass
- Rear shield
- Ash pan
- Refractory lined firebox

### 1100C BANFF™ CAST IRON EPA WOOD BURNING STOVE

Venting 6"

US \$

	Product	Model Description	Finish	WT/lbs.	MSRP/MAP
	1100CP-1	Cast iron wood burning stove	Metallic black	420	\$2,149
	1100CN-1	Cast iron wood burning stove	Porcelain enamel majolica brown	420	\$2,789

### OPTIONS/ACCESSORIES

#### DECORATIVE

	209M-BULK	Paint, Forrest - metallic black 16 oz. (Case of 12)		1	\$300
---	-----------	---	--	---	-------

#### HEAT CIRCULATION

	Product	Model Description	Finish	WT/lbs.	MSRP/MAP
	EP62M	Variable speed blower		5	\$269
	EP36	Thermostatic sensor control	Painted black	1	\$49
	115KT	Outside air kit, 4ft. Insul. Flex and through the wall vent		2	\$85
	W320-0011M	*Blower guard	Metallic black	2	\$25

#### MISC

	62140	Heat Resistant Gloves		1	\$55
--	-------	-----------------------	--	---	------

## 1400C BANFF™ SERIES

### 1400C BANFF™ CAST IRON EPA WOOD BURNING STOVE

Venting 6"

US \$

	Product	Model Description	Finish	WT/lbs.	MSRP/MAP
	1400CP	Cast iron wood burning stove	Metallic black	512	\$2,579
	1400CN	Cast iron wood burning stove	Porcelain enamel majolica brown	512	\$2,999

### OPTIONS/ACCESSORIES

#### DECORATIVE

	209M-BULK	Paint, Forrest - metallic black 16 oz. (Case of 12)		1	\$300
---	-----------	---	--	---	-------

#### HEAT CIRCULATION

	Product	Model Description	Finish	WT/lbs.	MSRP/MAP
	EP62M	variable speed blower		5	\$269
	EP36	Thermostatic sensor control	Painted black	1	\$49
	115KT	Outside air kit, 4ft. Insul. Flex and through the wall vent		2	\$85
	W320-0011M	*Blower guard	Metallic black	2	\$25

#### MISC

	62140	Heat Resistant Gloves			\$55
--	-------	-----------------------	--	--	------

\* Note: If using the EP62 blower on a woodstove WITH LEGS then the blower guard W320-0011 must be installed



Effective: March 15, 2016

## EPI3 OAKDALE™ SERIES

### EPI3 OAKDALE™ SERIES CAST IRON EPA WOOD BURNING INSERT

EPA Certified. Safety tested to North American Standards:

**Venting 6"**

- Fully refractory lined firebox
- Heat circulating blower w/ variable speed control
- Ceramic glass
- Cast surround w/ door

**US \$**

	Product	Model Description	Finish	WT/lbs.	MSRP/MAP
	EPI3C	Fireplace insert complete with Cast Iron Surround and Door - Contemporary	Painted black	500	\$3,209
	EPI3T	Fireplace insert complete with Cast Iron Surround and Door - Traditional	Painted black	500	\$3,209
	EPI3TN	Fireplace insert complete with Cast Iron Surround and Door - Traditional	Majolica brown	500	\$3,519

#### OPTIONS/ACCESSORIES

BP3	Backer Plate (Attaches to the surround to cover openings less than 49" W x 32.5" H)	10	\$75
209M-BULK	Paint, Stove Bright - metallic black 16 oz. (Case of 12)	12	\$300

MISC			
62140	Heat Resistant Gloves		\$55



EPI-1101M OAKDALE™ SERIES



EPI-1101M OAKDALE™ SERIES DELUXE EPA WOOD BURNING INSERT

Venting 6"

- Whisper Quiet™ heat circulating blower
- Automatic thermodisc
- Variable speed control

NOTE: DOOR MUST BE ORDERED SEPARATELY.



US \$

	Product	Model Description	Finish	WT/lbs.	MSRP/MAP
	EPI-1101M	Fireplace insert	Metallc black	305	\$1,719
<b>DOORS (Matching spring handles for door and air control are included with door)</b>					
	H222M	Cast iron door - standard arch	Metallc black	25	\$305
	H222-G	Cast iron door - standard arch	Gold plated (24 Karat)	25	\$535
	H222-SS	Cast iron door - standard arch	Satin chrome plated	25	\$535
	H222-GW	Cast iron door - Early American webbed arch	Gold plated (24 karat) - <b>Limited Quantities Available</b>	25	\$569

OPTIONS/ACCESSORIES

DECORATIVE

NOTE: FLASHING /SURROUND MUST BE ORDERED TO COMPLETE UNIT

	EI-900M10	Standard flashing complete with trim (designed to fit/cover openings smaller than 32"h x 44 1/2"w)	Metallc black	12	\$235
<b>Cast iron surround kit (finished outside dimension 28 1/8 "H x 42 1/4"W)</b>					
	CISM	*Cast iron surround kit	Painted black	80	\$535
	CISKN	*Cast iron surround kit	Porcelain enamel majolica brown	80	\$785
	AK-1	*Adaptor kit for cast iron surround	<b>Limited Quantities Available</b>	6	\$95
	AK-1M	*Adaptor kit for cast iron surround	Metallc black	6	\$95
	CLTRIM	Flashing (surround) trim	Polished brass finish - <b>Limited Quantities Available</b>	2	\$119
	W325-0043	Spring door handle (large)	Black	1	\$9
	W325-0045	Spring door handle (large)	Polished brass finish	1	\$9
	W325-0033	Spring door handle (large)	Satin chrome	1	\$9
	W325-0042	Spring air control handle (small)	Black	1	\$9
	W325-0044	Spring air control handle (small)	Polished brass finish	1	\$9
	W325-0032	Spring air control handle (small)	Satin chrome	1	\$9
	270-BULK	Paint, Thuralox -Case of 12, black 13 oz.		12	\$235
	209M-BULK	Paint, Forrest - metallc black 12 oz. (Case of 12)		1	\$300
<b>MISC</b>					
	62140	Heat Resistant Gloves		1	\$55

\*NOTE: Adaptor kit (AK-1) required to install cast iron surround.



EPI-1402M OAKDALE™ SERIES

EPI-1402M OAKDALE™ SERIES DELUXE EPA WOOD BURNING INSERT

Venting 6"



- 2 Whisper Quiet™ heat circulating blowers
- Automatic thermodisc
- Variable speed control
- Surround & trim to cover fireplace opening (up to 32" H x 44½" W)

NOTE: DOOR MUST BE ORDERED SEPARATELY.

US \$



Product	Model Description	Finish	WT/lbs.	MSRP/MAP
 EPI-1402M	Fireplace insert	Metallic black	365	\$2,249
EPI-1402K	Fireplace insert	Porcelain enamel black - Limited Quantities Available	365	\$2,579

DOORS (Matching spring handles for door and air control are included with door)

 H222M	Cast iron door - standard arch	Metallic black	25	\$305
H222-G	Cast iron door - standard arch	Gold plated (24 Karat)	25	\$535
H222-SS	Cast iron door - standard arch	Satin chrome plated	25	\$535
 H222-GW	Cast iron door - Early American webbed arch	Gold plated (24 karat) - Limited Quantities Available	25	\$569

OPTIONS/ACCESSORIES

DECORATIVE

Cast iron surround kit (finished outside dimension 32"H x 53½"W)				
 CISM-A	*Cast iron surround kit	Metallic black	80	\$535
CISKN-A	*Cast iron surround kit	Porcelain enamel majolica brown - Limited Quantities Available	80	\$785
AK-2M	*Adaptor kit for cast iron surround		6	\$95
 W325-0043	Spring door handle (large)	Black	1	\$9
W325-0045	Spring door handle (large)	Polished brass finish	1	\$9
W325-0033	Spring door handle (large)	Satin chrome	1	\$9
W325-0042	Spring air control handle (small)	Black	1	\$9
W325-0044	Spring air control handle (small)	Polished brass finish	1	\$9
W325-0032	Spring air control handle (small)	Satin chrome	1	\$9
CLTRIM	Flashing (surround) trim	Polished brass finish - Limited Quantities Available	2	\$119
W470-0002	Enamel touch up & brush (specify color)		1	\$15
209M-BULK	Paint, Forrest - metallic black 12 oz. (Case of 12)		1	\$300
MISC				
EPA335KT	Low clearance flue connector	stainless steel	5	\$119
62140	Heat Resistant Gloves		1	\$55

\*NOTE: Adaptor kit (AK-2M),required to install cast iron surround.



## NZ6000-1 HIGH COUNTRY™ SERIES

### NZ6000-1 HIGH COUNTRY™ EPA ZERO CLEARANCE WOOD BURNING FIREPLACE

Safety tested to North American Standards: ULC S610, UL 127

**Chimney 8"**

- Firebrick lined with cast Napoleon insignia
- Grate
- 2-6"x10 ft. outside combustion air vents and 1-6"x10 ft. circulation vent
- Andirons
- Steel template included to ensure proper fit for facing material

**NOTE: DOORS, FACEPLATE, UPPER GRILL AND KEYSTONE MUST BE ORDERED SEPARATELY TO COMPLETE UNIT**

					US \$
	Product	Model Description	Finish	WT/lbs.	MSRP/MAP
	NZ6000-1	High Country™ wood burning fireplace	Painted black	870	\$5,629
<b>DOORS</b>					
	H335-1K	Arched double door	Painted black	40	\$1,039
	H335-1WI	Arched double door	Wrought iron finish	55	\$1,555
<b>FACEPLATE</b>					
	FPK-1	Faceplate arched	Painted black	35	\$589
	FPWI-1	Faceplate arched <b>complete with</b> upper grill & keystone	Wrought iron finish	35	\$1,769
<b>UPPER GRILL</b>					
	UGK	Upper grill arched	Painted black	8	\$205
	UGSC	Upper grill arched	Satin chrome plated - <b>Limited Quantities Available</b>	8	\$365
<b>KEYSTONE</b>					
	KSK	Keystone	Painted black	2	\$65
	KSSC	Keystone	Satin chrome plated - <b>Limited Quantities Available</b>	2	\$109

#### OPTIONS/ACCESSORIES

<b>DECORATIVE</b>					
	NSK6	Arched screen kit	Painted black	23	\$355
	CP	Country crane and hearth pot	Painted black	14	\$325
	W470-0017A	Paint, Wrought Iron 13 oz.		1	\$25
	270-BULK	Paint, ThurmaloX -Case of 12, black 13 oz.		12	\$235
<b>HEAT CIRCULATION</b>					
	NZ221	Gravity hot air vent includes: 5' long flexible insulated aluminum air vent radiation shield, 13" x 13" white grill, with air flow control Note: if installing two gravity hot air vents, two kits are required	<b>Limited Quantities Available</b>	20	\$245
	NZ150-KT	Mounting plate/collar & intake grill for 6" circulation vent (not required if installing NZ64 blower system)		5	\$69
	NZ64	Air circulating blower system with decorative grill & washable filter for circulation of either interior or outside fresh air. (Safety door switch and heat activated thermal switch is included with unit)		25	\$645
	NZ620-KT	6" x 10' outside combustion air or blower extension kit, includes coupler and hardware		8	\$85
	NZAC-KT	Starter collars for the air cooled chimney		3	\$55
	NZ220-2	5' x 8" dia. flexible insulated aluminum vent (for gravity hot air vent)	<b>Limited Quantities Available</b>	7	\$109
	W010-0067	Flexible vent support assembly (for central heating systems)		2	\$19
	NM228-M	*8" Flue tile support		10	\$139
	W175-0002	8" coupler		2	\$25
	W690-0005	120 volt thermostat		2	\$45
<b>MISC</b>					
	62140	Heat Resistant Gloves		1	\$55

\* NOTE: Flue tile support must be used with masonry installations.

NOTE: Heat circulating blower system must be installed during fireplace installation - Electrical components: wire, switch, etc. not supplied



NZ7000



**NZ7000 HIGH COUNTRY™ ZERO CLEARANCE LINEAR WOOD BURNING FIREPLACE**

Safety tested to North American Standards: ULC S610, UL 127

*Chimney 10"*

- 21 Day Lead Time for this product
- "ZERO GRAVITY™ glass and screen door
- Steel andirons
- Heat Resistant Gloves

US \$

	Product	Model Description	Finish	WT/lbs.	MSRP/MAP
	NZ7000	High Country™ linear wood burning fireplace	Painted black	1050	\$6,999
	NZ7SBK	Decorative brick kit	Smooth	300	\$799
	NZ7FBK	Decorative brick kit	Fluted	300	\$899

**NOTE: MUST ORDER BRICK KIT TO COMPLETE UNIT**

**OPTIONS/ACCESSORIES**

<b>DECORATIVE</b>					
W470-0038	Paint, metallic charcoal 13 oz. MUST ORDER IN MULTIPLES OF 12 - Stove Bright		12		\$25
<b>HEAT CIRCULATION</b>					
111KT	Outside air kit - 4 feet insulated flexpipe (4" dia.) with through the wall vent		3		\$95
<b>MISC</b>					
62140	Heat Resistant Gloves				\$55





NZ8000

**NZ8000 HIGH COUNTRY™ ZERO CLEARANCE WOOD BURNING FIREPLACE**

Safety tested to North American Standards: ULC S610, UL 127

*Chimney 10"*

- 21 Day Lead Time for this product
- "ZERO GRAVITY™ glass and screen door
- Steel andirons
- Heat Resistant Gloves

US \$

	Product	Model Description	Finish	WT/lbs.	MSRP/MAP
	NZ8000	High Country™ wood burning fireplace	Painted black	1150	\$6,999
	NZ8TBK	Decorative brick kit	Traditional	300	\$899
	NZ8SBK	Decorative brick kit	Smooth	300	\$949
	NZ8HBK	Decorative brick ki	Herringbone	300	\$999

**NOTE: MUST ORDER BRICK KIT TO COMPLETE UNIT**

**OPTIONS/ACCESSORIES**

DECORATIVE		
W470-0038	Paint, metallic charcoal 13 oz. MUST ORDER IN MULTIPLES OF 12 - Stove Bright	\$25
HEAT CIRCULATION		
111KT	Outside air kit - 4 feet insulated flexpipe (4" dia.) with through the wall vent	\$95
MISC		
62140	Heat Resistant Gloves	\$55



Effective: March 15, 2016

## 2100 / 2200/ 2300/ EPI22 ECONOMIZER™

### 2100/2200/2300 ECONOMIZER™ EPA WOOD BURNING STOVES

Venting 6"



- Full refractory lined firebox
- Painted black door

US \$



	Product	Model Description	Finish	WT/lbs.	MSRP/MAP
	2100	Small woodstove c/w door	Painted black	238	\$829
	2200	Medium woodstove c/w door	Painted black	275	\$939
	2300	Large Woodstove c/w door, pedestal and ash pan	Painted black	410	\$2,039

#### OPTIONS/ACCESSORIES

MUST CHOOSE PEDESTAL OR LEGS TO COMPLETE MODEL 2100 & 2200

	EP20P	Pedestal kit fits both models		23	\$245
	EP21L	Leg Kit w/bottom heat shield - small stove		13	\$135
	EP22L	Leg Kit w/bottom heat shield - medium stove		13	\$135

#### DECORATIVE

	EP20PAD	Pedestal Model ash pan kit		12	\$195
	EP20LAD	Leg Model ash pan kit		13	\$195
	270-BULK	Paint, Thurmalox -Case of 12, black 13 oz.		12	\$235

#### HEAT CIRCULATION

	EPT70	Variable speed blower w/thermostatic control		7	\$289
---	-------	--	--	---	-------

#### MISC

	62140	Heat Resistant Gloves			\$55
--	-------	-----------------------	--	--	------



2100 EPA Wood Burning Stove  
Shown As Leg Model with Optional Ash Pan



2200 EPA Wood Burning Stove  
Shown As A Pedestal Model with Optional Ash Pan



2300 EPA Wood Burning Stove  
Includes Pedestal and Ash Pan As "Standard"

## EPI22 ECONOMIZER™

### EPI22 ECONOMIZER™ EPA WOOD BURNING INSERT

Venting 6"

- Full refractory lined firebox
- 2 heat circulating blowers with automatic thermodisc and variable speed control
- Painted black door
- Standard black flashing with trim

US \$

	Product	Model Description	Finish	WT/lbs.	MSRP/MAP
	EPI22	Insert c/w door, dual blowers and standard flashing	Painted black	303	\$1,659

#### MISC

	62140	Heat Resistant Gloves		1	\$55
--	-------	-----------------------	--	---	------





## NPS45 ECO PELLET SERIES



### NPS45 ECO PELLET SERIES ELECTRONIC PELLET STOVE THERMOSTATIC CAPABLE (REAR VENT)

3" or 4" Pellet Vent







- Conceal millivolt ignition
- Mobile home approved
- Pedestal with concealed ash pan
- Thermostatic ready
- Dual painted black accent rods
- Auto ignitor & air wash
- Heat exchanger
- 120 cfm convection fan
- 55lb hopper, up to 40,000 BTU's

NOTE: DOOR MUST BE ORDERED TO COMPLETE UNIT

US \$

	Product	Model Description	Finish	WT/lbs.	MSRP/MAP
	NPS45	Pellet stove	Painted black	202	\$2,949
<b>DOORS</b>					
	GS328-1K	Door	Painted black	14	\$465
	GS328-1G	Door	Gold plated (24 Karat)	14	\$685
	GS328-1SS	Door	Satin chrome	14	\$685

#### OPTIONS/ACCESSORIES

<b>DECORATIVE</b>					
	NP841KT	Decorative brick panels	Sandstone	6	\$85
	PRPP40	Porcelain reflective radiant panels	Limited Quantities Available	5	\$95
	NPL41	Decorative log set		10	\$85
	GS200-G	Trivet	Gold plated (24 Karat)	1	\$109
	GS200-SS	Trivet	Satin chrome plated	1	\$109
	209M-BULK	Paint, Forrest - metallic black 12 oz. (Case of 12)		1	\$300
<b>CONTROLS</b>					
	W660-0081	Thermostat, wall mount - digital		1	\$69
	F60	Napoleon thermostatic hand held battery operated remote w/digital screen		1	\$149
	F60-6	Napoleon thermostatic hand held battery operated remote w/digital screen - bulk of 6		7	\$859
<b>MISC</b>					
	NPHE40-1	Hopper extension (increases hopper capacity from 55 lbs to 80 lbs pellets)		8	\$159
	114KT	Outside air kit - 5 feet (2" dia.) with through the wall vent		2	\$75

\* Note: For optimum performance, it is recommended that 4" diameter venting be utilized in high altitude regions (above 4,000ft) or when vertical venting exceeds 15ft





## NPI45 ECO PELLET SERIES

### NPI45 ECO PELLET SERIES PELLET INSERT

3" or 4" Pellet Vent

- Conceal millivolt ignition
- Thermostatic ready
- Heat exchanger
- Mobile home approved
- Dual painted black accent rods
- 120 cfm convection fan
- Pedestal with concealed ash pan
- Auto ignitor & air wash
- 45lb hopper
- Up to 40,000 BTU's







US \$

	Product	Model Description	Finish	WT/lbs.	MSRP/MAP
	NPI45	Pellet insert	Painted black	170	\$2,999
<b>DOORS (MUST BE ORDERED TO COMPLETE THE UNIT)</b>					
	GS328-1K	Door	Painted black	14	\$465
	GS328-1G	Door	Gold plated (24 Karat)	14	\$685
	GS328-1SS	Door	Satin chrome	14	\$685

### OPTIONS/ACCESSORIES

#### DECORATIVE

**NOTE: FLASHING /SURROUND MUST BE ORDERED TO COMPLETE UNIT**

	NI800	8" black flashing with black trim	Painted black	13	\$195
	GICSK	Arched cast iron surround (covers opening smaller than 29" H x 46" W)	Painted black	80	\$395
	AK8	Adaptor kit (req'd for GICSK)		10	\$159
	CISK	Cast iron surround kit (covers opening smaller than 28" H x 46" W)	Painted black	80	\$535
	CISKN	Cast iron surround kit (covers opening smaller than 28" H x 46" W)	Porcelain enamel majolica brown	80	\$785
	AK9	Adaptor kit (req'd for CISK series)		7	\$175
	NP841KT	Decorative brick panels	Sandstone	6	\$85
	PRPP40	Porcelain reflective radiant panels	<b>Limited Quantities Available</b>	5	\$95
	NPL41	Decorative log set		10	\$85
	GS200-G	Trivet	Gold plated (24 Karat)	1	\$109
	GS200-SS	Trivet	Satin chrome plated	1	\$109
	209M-BULK	Paint, Forrest - metallic black 12 oz. (Case of 12)		1	\$300
	<b>CONTROLS</b>				
	W660-0081	Thermostat, wall mount - digital		1	\$69
	F60	Napoleon thermostatic hand held battery operated remote w/digital screen		1	\$149
	F60-6	Napoleon thermostatic hand held battery operated remote w/digital screen - bulk of 6		7	\$859
	<b>MISC</b>				
	114KT	Outside air kit - 5 feet (2" dia.) with through the wall vent		2	\$75

\* Note: For optimum performance, it is recommended that 4" diameter venting be utilized in high altitude regions (above 4,000ft) or when vertical venting exceeds 15ft





## TPS35/TPI35

### TPS35 PELLE STOVE (REAR VENT) & TPI35 PELLE INSERT



3" or 4" Pellet Vent

• Thermostatic ready	• Mobile home approved	• Auto ignitor & air wash
• Heat exchanger	• 120 cfm convection fan	• 45lb hopper, up to 43,000 BTU's
• Digital control panel		

US \$

	Product	Model Description	Finish	WT/lbs.	MSRP/MAP
	TPS35	Pellet stove with pedestal base and black door	Painted black	158	\$2,149
	TPI35	Pellet insert with black door	Painted black	140	\$1,929

#### OPTIONS/ACCESSORIES

DECORATIVE					
<b>NOTE: FLASHING/SURROUND MUST BE ORDERED TO COMPLETE INSERT</b>					
	TI800	Adjustable flashing with black trim (covers opening smaller than 29 1/2" H x 38 1/2" W)		15	\$235
	270-BULK	Paint, ThurmaloX -Case of 12, black 13 oz.		12	\$235
CONTROLS					
	F60	Napoleon thermostatic hand held battery operated remote w/digital screen		1	\$149
	F60-6	Napoleon thermostatic hand held battery operated remote w/digital screen - bulk of 6		7	\$859
MISC					
	TPHE	Hopper extension (Suitable for Stove Only) Stackable to 2 high for 160 lbs pellet capacity)		13	\$215
	114KT	Outside air kit - 5 feet (2" dia.) with through the wall vent		2	\$75

**Note:** For optimum performance, it is recommended that 4" diameter venting be utilized in high altitude regions (above 4,000ft) or when vertical venting exceeds 15ft

**Note:** Both stove and insert are tested and certified to burn a 50% mixture of corn & pellet.



# Keenan Mantel Collection

Images	Base	Size	Product Code	Cabinet Series	Colour	Model Number	Weight (lbs)	US \$
	Bonaparte	Small	MBS			B30	137	\$1,049
		Medium	MBM			B36, B35 OR GX36	191	\$1,149
		Large	MBL			B42 OR GX70	223	\$1,249
	Princess	Small	MPS			B30	137	\$1,149
		Medium	MPM			B36, B35 OR GX36	191	\$1,249
		Large	MPL			B42 OR GX70	223	\$1,349
	Imperial	Small	MIS			B30	137	\$1,199
		Medium	MIM			B36, B35 OR GX36	191	\$1,299
		Large	MIL			B42 OR GX70	223	\$1,399
	Empire	Small	MES			B30	137	\$1,249
		Medium	MEM			B36, B35 OR GX36	191	\$1,349
		Large	MEL			B42 OR GX70	223	\$1,549
	Dynasty	Small	MDS			B30	137	\$1,249
		Medium	MDM			B36, B35 OR GX36	191	\$1,349
		Large	MDL			B42 OR GX70	223	\$1,449
	Marquess	Small	MMS			B30	137	\$1,449
		Medium	MMM			B36, B35 OR GX36	191	\$1,549
		Large	MML			B42 OR GX70	223	\$1,649

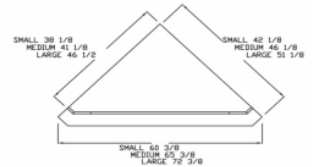
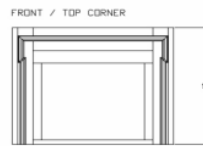

**How to Order:**

Choose a cabinet series and a colour, then record the first bolded letter in the columns above.

Choose Cabinet Series	Choose Colour
Full Cabinet	<b>W</b> hite (made of MDF)
Standard Flush Cabinet	<b>B</b> lack (made of MDF)
Corner Cabinet	<b>E</b> spresso (made of Maple)
	<b>U</b> nfinished (made of Maple)
	<b>P</b> ewter (made of Maple)
	<b>N</b> atural (made of Maple)

Note: Due to the custom nature of wood mantels, once the order is placed it cannot be cancelled. Please ensure that the model, size, colour, etc. is correct. Please allow 21 day production lead time. Each individual mantel is made. Due to the natural characteristics of wood, there may be variations to the finish colour. Mantels for GX70 will ship with non-combustible cement board. Customer must supply non-combustible finishing material of choice to complete the installation.

Finished code example:

Mantel	Size	Code	Cabinet	Colour	Model #	Finished Code
Bonaparte	Large	MBL	Corner	Espresso	B42	MBLCEB42



# Keenan Shelf Collection

Images	Base	Size	Product Code	Colour	Weight (lbs)	US \$
	Empire	Small	MSES	_____	80	\$539
		Medium	MSEM	_____	90	\$569
		Large	MSEL	_____	100	\$619
	Imperial	Small	MSIS	_____	80	\$539
		Medium	MSIM	_____	90	\$569
		Large	MSIL	_____	100	\$619
	Princess	Small	MSPS	_____	80	\$589
		Medium	MSPM	_____	90	\$619
		Large	MSPL	_____	100	\$669
	Bonaparte	Small	MSBS	_____	80	\$589
		Medium	MSBM	_____	90	\$619
		Large	MSBL	_____	100	\$669
	Dynasty	Small	MSDS	_____	80	\$589
		Medium	MSDM	_____	90	\$619
		Large	MSDL	_____	100	\$659
	Marquess	Small	MSMS	_____	80	\$589
		Medium	MSMM	_____	90	\$619
		Large	MSML	_____	100	\$669
	Rustic (made of solid pine)	Small	MSRS	N/A	80	\$709
		Medium	MSRM	N/A	90	\$739
		Large	MSRL	N/A	100	\$799

**How to Order:** Choose your colour below, and record the first bolded letter in the "Colour" column above.

Choose Colour
<b>W</b> hite (made of MDF)
<b>B</b> lack (made of MDF)
<b>E</b> spresso (made of Maple)
<b>U</b> nfinished (made of Maple)
<b>P</b> ewter (made of Maple)
<b>N</b> atural (made of Maple)

**Please note that the Rustic Style shelf does not come in multiple colours. The code is complete based on the size option selected. Shelf sizes correspond with mantel sizes, see mantel price sheet.**

Note: Due to the custom nature of wood mantels, once the order is placed it cannot be cancelled.

Please ensure that the model size, colour etc. is correct.

Please allow 21 days production lead time. Each individual shelf is made.

Due to the natural characteristics of wood, there may be variations to the finish colour.

Finished code example:

Shelf	Size	Code	Colour	Finished Code
Bonaparte	Large	MSBL	Espresso	MSBLE



**DIRECT VENT FIREPLACE - VENTING COMPONENTS 4" X 7"**

				US \$
Product	Model Description	Style	WT/lbs.	MSRP/MAP
GD-222	Wall terminal/vinyl siding shield		4	\$169
GD-222-BULK	Wall terminal/vinyl siding sheild - bulk pack of 12		35	\$1,655
GD-222R	Round wall terminal kit (required for GD70NT )		9	\$175
GD-113	Roof terminal		18	\$175
GD-113-BULK	Roof terminal - bulk pack of 7		100	\$925
GD-110	Roof terminal kits	1/12 to 7/12 pitch	18	\$299
GD-111	Roof terminal kits	8/12 to 12/12 pitch	18	\$299
GD-112	Roof terminal kits	Flat roof	18	\$299
GD-201	Periscope (snorkel) for wall penetration below grade		15	\$405
GD-220	Vent kit - 5ft. (incl.1-4"x5'+1-7"x5' flexible aluminum liner)		5	\$75
GD-220-BULK	Vent kit - 5ft. - bulk pack of 30		128	\$1,865
GD-330	Vent kit - 10 ft. (incl. 1 - 4"x10' + 1-7"x10" flexible aluminum liner)		10	\$165
GD-330-BULK	Vent kit - 10 ft. - bulk pack of 10		96	\$1,399
GD7RVK	Rear vent kits includes: 1-20" flex vent (4" inner and 7" outer), 1-GD222 wall terminal/vinyl siding shield.		10	\$209
GD7TVK	Top vent kit - includes: 1-5ft flex vent (4" inner and 7" outer),1-GD222 wall terminal/vinyl siding shield.		13	\$259

**VENT COMPONENTS**

W175-0053	Simpson duravent adaptor		2	\$59
W175-0001	4" coupler		2	\$15
W175-0013	7" coupler		2	\$15
W175-0195	4/7 coupler kit		3	\$29
W010-0370	Wall support assembly		2	\$19
VS47KT	Firestop/vent sleeve assembly (included for 33" fireplaces)		2	\$65
W010-1777	Additional firestop for vent sleeve assembly		2	\$35
W500-0103	Terminal extension plate	<b>Limited Quantities Available</b>	2	\$19
	(req. on GD70NT only when terminating through a combustibile wall with less than 2 ft of venting)			
W500-0292	Firestop		2	\$15
	(req. on GD70NT only when terminating through a combustibile wall with less than 2 ft of venting)			
W573-0007	Hi-temperature sealant, (millpac) 10.3 oz cartridge		2	\$25
W573-0012	Hi-temperature sealant, (millpac) 10.3 oz cartridge (bulk - 24 per carton)			\$495
AVS47KT-1	Attic Firestop/Vent Sleeve Assembly (Replaces W585-0072 & W170-0063)		2	\$65
GD-301	Heat guard (NOT SUITABLE FOR USE WITH GD-222R)		4	\$115
RP4	Restrictor Plate (recommended for aggressive vertical venting)		2	\$25

Note: To order rigid venting see "rigid venting components" price sheet.

**GD-222R (ROUND TERMINAL) REQUIRED FOR GD70 THROUGH THE WALL INSTALLATION - GD222 (SQUARE TERMINAL) NOT SUITABLE FOR GD70.**





**DIRECT VENT FIREPLACE - VENTING COMPONENTS 5" x 8"**

US \$

Product	Model Description	Style	WT/lbs.	MSRP/MAP
GD422-1	Wall terminal/vinyl siding shield		4	\$169
GD422-1BULK	Wall terminal/vinyl siding shield - bulk pack of 12		35	\$1,655
GD422R-1	Round wall terminal kit (required for GD80NT & LHD50)		4	\$175
GD413	Roof terminal		9	\$175
GD413-BULK	Roof terminal - bulk pack of 7		100	\$925
GD410	Roof terminal kits	1/12 to 7/12 pitch	18	\$299
GD411	Roof terminal kits	8/12 to 12/12 pitch	18	\$299
GD412	Roof terminal kits	Flat roof	18	\$299
GD401	Periscope (snorkel) for wall penetration below grade		15	\$415
GD420	Vent kit - 5ft. (incl. 1 - 5"x5' + 1 - 8"x5' flexible aluminum liner)		5	\$75
GD420-BULK	Vent kit - 5ft. - bulk pack of 18		128	\$1,139
GD430	Vent kit - 10 ft.(incl. 1-5"x10' + 1 8"x10' flexible aluminum liner)		10	\$165
GD430-BULK	Vent kit - 10 ft. - bulk pack of 7		96	\$1,035
GD8TVK	Top vent kit - includes: 1-5ft flex vent (5" inner and 8" outer),1-GD422 wall terminal/vinyl siding shield		13	\$259

**VENT COMPONENTS**

W175-0170	Simpson duravent adaptor		2	\$55
W175-0166	5" coupler		2	\$15
W175-0002	8" coupler		2	\$25
W175-0196	5/8 coupler kit		3	\$29
W010-0067	Flexible vent support assembly		2	\$19
W500-0028	Firestop		2	\$15
W573-0007	Hi-temperature sealant, (millpac) 10.3 oz cartridge		2	\$25
W573-0012	Hi-temperature sealant, (millpac) 10.3 oz cartridge (bulk - 24 per carton)		25	\$495
W585-0096	Soffit heat shield		4	\$35
W585-0092	Vent pipe shield		1	\$29
W170-0086	Vent pipe collar		1	\$25
GD-501	Heat guard		4	\$155
RP5	Restrictor Plate (recommended for aggressive vertical venting)		2	\$25

**NOTE: GD422R-1 (ROUND TERMINAL) REQUIRED FOR GD80NT AND LHD50 THROUGH THE WALL INSTALLATION - GD422 (SQUARE TERMINAL) NOT SUITABLE.**



**DIRECT VENT FIREPLACE - VENTING COMPONENTS 8" X 10"**

				US \$
Product	Model Description	Style	WT/lbs.	MSRP/MAP
GD622R	Wall terminal		5	\$215
GD610	Roof terminal kits	1/12 to 7/12 pitch	25	\$385
GD611	Roof terminal kits	8/12 to 12/12 pitch	25	\$385
GD612	Roof terminal kits	Flat roof	25	\$385
GD613	Roof terminal		12	\$279
GD620	Vent kit - 5 ft. (incl. 1 - 8"x5' + 1 - 10"x5' flexible aluminum liner)		7	\$155
GD630	Vent kit - 10 ft. (incl. 1 - 8"x10' + 1 - 10"x10' flexible aluminum liner)		14	\$279

**VENT COMPONENTS**

RP8	Restrictor plate (Recommended for aggressive vertical venting)		2	\$25
W175-0002	8" coupler		2	\$25
W175-0249	10" coupler		3	\$25
W010-1797	Firestop		3	\$39
W585-0222	Vent pipe shield		4	\$39
W170-0116	Vent pipe collar		2	\$29
W573-0007	Hi-temperature sealant, (millpac) 10.3 oz cartridge		2	\$25
W573-0012	Hi-temperature sealant, (millpac) 10.3 oz cartridge (bulk - 24 per carton)		25	\$495

**DIRECT VENT FIREPLACE - VENTING COMPONENTS 8" X 11"**

GD822R	Wall terminal - round		5	\$215
GD-810	Roof terminal kits	1/12 to 6/12 pitch	25	\$385
GD-811	Roof terminal kits	7/12 to 12/12 pitch	25	\$385
GD-812	Roof terminal kits	Flat roof	25	\$385
GD-813	Roof terminal		12	\$279
GD-820	Vent kit - 5 ft. (incl. 1 - 8"x5' + 1 - 11"x5' flexible aluminum liner)		7	\$175
GD-830	Vent kit - 10 ft. (incl. 1 - 8"x10' + 1 - 11"x10' flexible aluminum liner)		14	\$309

**VENT COMPONENTS**

RP8	Restrictor plate (Recommended for aggressive vertical venting)		2	\$25
W175-0002	8" coupler		2	\$25
W010-3364	Firestop		3	\$155
W170-0181	Vent pipe collar		2	\$29
W573-0007	Hi-temperature sealant, (millpac) 10.3 oz cartridge		2	\$25
W573-0012	Hi-temperature sealant, (millpac) 10.3 oz cartridge (bulk - 24 per carton)		25	\$495
W585-0834	11" vent pipe shield		4	\$39
W175-0385	11" aluminum coupler		2	\$29

Note: To order rigid venting see "rigid venting components" price sheet.



**DIRECT VENT STOVES - VENTING COMPONENTS**

				US \$
Product	Model Description	Style	WT/lbs.	MSRP/MAP
GS-150KT	B-vent adaptor kit (includes spill switch & decorative metallic black band)		5	\$145
GD-175	Wall terminal kit includes: 1-7" vent termination, 1 adjustable pipe from 28" to 54", 1-24" pipe, 1-90 degree elbow, 1 10 ft. 4" alum. Flex vent with spacers, 1 fire stop, 1 black trim collar and 3 decorative metallic black bands.		26	\$415
GD-176	24" through the wall vent kit, c/w black mounting plate, black trim collar, 45° elbow and terminal		20	\$279
GD-180	Periscope kit includes: 1 periscope (GD201), 1 adjustable pipe from 28" to 54", 1-24" pipe, 1-90 degree elbow, 1 10ft. 4" alum. Flex vent with spacers, 1 firestop, 1 black trim collar and 3 decorative metallic black bands.		41	\$599
GD-113	Roof terminal		9	\$175
GD-113-BULK	Roof terminal - bulk pack of 7		100	\$925
GD-110	Roof terminal kits	1/12 to 7/12 pitch	18	\$299
GD-111	Roof terminal kits	8/12 to 12/12 pitch	18	\$299
GD-112	Roof terminal kits	Flat roof	18	\$299







**VENT COMPONENTS - NOTE: 24" BLACK STOVE PIPE, 45° & 90° ELBOWS ARE SOLD IN FULL CARTONS ONLY**

GDS924N	DuraVent adaptor (for use with Simpson DuraVent GS direct vent pipe)		1	\$55
GD-201	Periscope (snorkel) for wall penetration below grade		15	\$405
BM6724	7"-24" Stove pipe - MUST ORDER MULTIPLES OF 10		30	\$25
BM67ADJ	7" - 28" to 54" adjustable stove pipe EA.		5	\$99
BM6745	7" - 45 degree elbow - MUST ORDER MULTIPLES OF 4		8	\$35
BM6790	7" - 90 degree elbow - MUST ORDER MULTIPLES OF 4		8	\$29
W010-0300	4" X 10' alum. Flexible liner with spacers		2	\$105
W175-0001	4" coupler		2	\$15
W025-0001	Decorative brass band		1	\$29
W025-0003	Decorative metallic black band		1	\$29
BRTC7	7" Brass trim collar - MUST ORDER MULTIPLES OF 12	Limited Quantities Available	2	\$39
BM3730	7" Black trim collar - MUST ORDER MULTIPLES OF 12		2	\$15
W500-0077	Firestop/ceiling plate		2	\$15
W500-0103	Terminal extension plate	Limited Quantities Available	1	\$19
W573-0007	Hi-temperature sealant, (millpac) 10.3 oz cartridge		2	\$25
W573-0012	Hi-temperature sealant, (millpac) 10.3 oz cartridge (bulk - 24 per carton)		25	\$495
AVS47KT-1	Attic Firestop/Vent Sleeve Assembly (Replaces W585-0072 & W170-0063)		2	\$65
GD-301	Heat guard (NOT SUITABLE FOR USE WITH GD-222R)		4	\$115
RP4	Restrictor plate (recommended for aggressive vertical venting)		2	\$25



Effective: March 15, 2016

**DIRECT VENT RIGID VENTING 4" x 7"**

					US \$
	Product	Components	# Per Package	WT/lbs.	MSRP/MAP
	RV445	45 Degree elbow	4 pack	9	\$209
	RV490	90 Degree elbow	4 pack	11	\$239
	RV420	20 Inch coupler	4 pack	14	\$165
	RV436	36 Inch length	4 pack	23	\$239
	RV418	10"-18" Adjustable	4 pack	16	\$209
	RV466	34"-66" Adjustable	4 pack	44	\$385

**NOTE: Rigid venting cannot be combined with Wolf Steel flexible venting!**



## GPV GAS POWER VENT

### GPV GAS POWER VENT KIT FOR DIRECT VENT GAS FIREPLACES

Venting - 4" & 7"

POWER VENT MUST EXTEND MINIMUM 10 FEET, MAXIMUM 110 FEET, DEPENDING ON SPECIFIC FIREPLACE MODEL.

POWER VENT KIT INCLUDES: POWER VENT TERMINAL AND POWER VENT CORD/WIRE HARNESS (20 ft.) ELECTRONIC JUNCTION CONTROL BOX AND 20 FT. OF WIRE ARE INCLUDED WITH SPECIFIC POWER VENT ADAPTOR KITS LISTED BELOW, WHERE REQUIRED.

US \$

Product	Model Description	Finish	WT/lbs.	MSRP/MAP
GPV	Power Vent Terminal		25	\$829
<b>NOTE: MUST CHOOSE ONE FIREPLACE ADAPTOR KIT TO MATCH FIREPLACE MODEL</b>				
PVA36-1	Power Vent Adaptor kit for 36 Series Fireplaces (Excluding Ascent Series & BGNV36) & LHD45 Series Fireplace		6	\$465
PVA40X-1	Power Vent Adaptor kit for HDX40-1, HDX35NT & GX70 Fireplaces		6	\$465
PVA80	Power Vent Adaptor kit for GD80 Series Fireplaces	Limited Quantities Available	9	\$625
PVA81	*Power Vent Adaptor kit for HD81 Series Fireplaces (Compatible with hand-held remote control)		9	\$625
PVALV38-50	*Power Vent Adaptor kit for LV50, LHD50 Series Fireplaces, HD4 Series Fireplaces, BHD4 Series Fireplaces & GD80-1ME series fireplaces (Compatible with hand-held remote control)		9	\$519
PVA52	*Power Vent Adaptor kit for HDX52 Fireplace		9	\$625
PVA62	*Power Vent Adaptor kit for LHD62		9	\$625

NOTE: Power vent cord/wire harness is 20 feet, if this length is not sufficient to meet the fireplace, splice additional wires in a junction box installed inside the building. Ensure all applicable electrical codes are followed.

\* NOTE: Unless otherwise specified, hand-held remotes are not compatible with all fireplace/power vent combinations

## GAS POWER VENT (GPV)

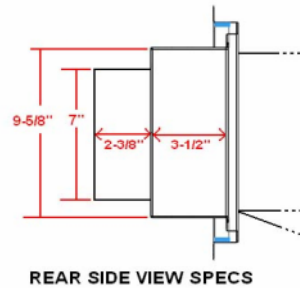
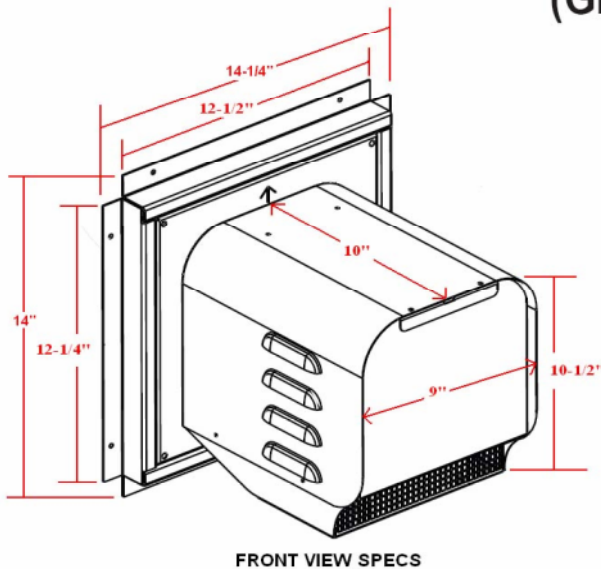



Effective: March 15, 2016

**COMPRESSED ALUMINUM FLEXIBLE GAS LINER**

**US \$**

	Product	Model Description	DIA	No. of Feet	MSRP/MAP
	GAKIT320	Complete kit includes: double ply aluminum liner, deluxe raincap, chimney flashing & termination plate.	3"	20	\$145
	GAKIT325		3"	25	\$175
	GAKIT330		3"	30	\$199
	GAKIT335		3"	35	\$209
	GAKIT420		4"	20	\$175
	GAKIT425		4"	25	\$209
	GAKIT430		4"	30	\$239
	GAKIT435		4"	35	\$249

**Note: 5" and 6" special order only**



## GSS36N RIVERSIDE™ SERIES

### GSS36N RIVERSIDE™ SERIES OUTDOOR GAS FIREPLACE-STAINLESS STEEL

Tested in Canada and U.S. as an outdoor gas fireplace. Listed to UL CR97-003 and CSA CAN1-2.21 and IASUS4





<ul style="list-style-type: none"> <li>• Stainless steel louvres (upper &amp; lower)</li> <li>• Millivolt ignition</li> <li>• Adjustable flame/heat control</li> </ul>	<ul style="list-style-type: none"> <li>• Piezo ignitor</li> </ul>	<ul style="list-style-type: none"> <li>• Stainless steel cover</li> <li>• Up to 40,000 BTU's</li> </ul>
--	---	---

**NOTE: All units are natural gas. If propane is required - please order conversion kit.**

**US \$**

	Product	Model Description	Finish	WT/lbs.	MSRP/MAP
	GSS36N	Outdoor gas fireplace - Natural gas	Brushed stainless steel	125	\$2,899
	W175-0214	Conversion kit - Natural gas to propane	Brushed stainless steel	2	\$55
	FC-12	12" stainless steel gas flex connector & shut off (25/crtn)		18	\$535

#### OPTIONS/ACCESSORIES

DECORATIVE					
	*MKRY	Media kit (replaces log set supplied with unit)	River rocks - grey	10	\$139
	*MKRM	Media kit (replaces log set supplied with unit)	River rocks - multicoloured	10	\$139
	*RAK36	Rock adaptor kit (must be ordered in conjunction with MKRY or MKRM)		1	\$29
	*ANI-K	Andirons	Painted black	2	\$75
	*ANI-G	Andirons	Gold Plated (24 Karat) - <b>Limited Quantities Available</b>	2	\$149
	270-BULK	Paint, Thumalox -Case of 12, black 13 oz.		12	\$235
CONTROLS					
	F45	Napoleon on/off hand held battery operated remote w/digital screen		1	\$95
	F45-6	Napoleon on/off hand held battery operated remote w/digital screen - bulk of 6		7	\$535

**Note: This unit is designed for "outdoor" use only. The firebox may be painted matte black to enhance the flame appearance**

\* Exposure to outdoor weather extremes may affect appearance of painted/plated andirons.

\* Both receiver and transmitter of hand held remote must be kept dry and protected from the elements.

See Outdoor Torch In the Gas Fireplaces - Modern section of this book



## GSS42N RIVERSIDE™ SERIES

### GSS42N RIVERSIDE™ SERIES OUTDOOR GAS FIREPLACE - STAINLESS STEEL

Tested in Canada and U.S. as an outdoor gas fireplace. Listed to UL CR97-003 and CSA CAN1-2.21 and IASUS4



<ul style="list-style-type: none"> <li>Stainless steel louvres (upper &amp; lower)</li> <li>Millivolt ignition</li> <li>Adjustable flame/heat control</li> </ul>	<ul style="list-style-type: none"> <li>Piezo ignitor</li> <li>Exclusive Phazer® logs and embers</li> <li>Heat resistant glass</li> </ul>	<ul style="list-style-type: none"> <li>Stainless steel burner</li> <li>Andirons</li> <li>Up to 65,000 BTU's</li> </ul>
--	--	--

**NOTE: All units are natural gas. If propane is required - please order conversion kit.**

**US \$**

Product	Model Description	Finish	WT/lbs.	MSRP/MAP
 GSS42N	Outdoor gas fireplace - Natural gas	Brushed stainless steel	150	\$3,859
W175-0272	Conversion kit - Natural gas to propane	Brushed stainless steel	2	\$55

#### OPTIONS/ACCESSORIES

DECORATIVE				
 GD840KT	Decorative brick panels	Sandstone	45	\$209
270-BULK	Paint, Thurmalox -Case of 12, black 13 oz.		12	\$235
CONTROLS				
 F45	Napoleon on/off hand held battery operated remote w/digital screen		1	\$95
F45-6	Napoleon on/off hand held battery operated remote w/digital screen - bulk of 6		7	\$535

\* Both receiver and transmitter of hand held remote must be kept dry and protected from the elements.

Note: This unit is designed for "outdoor" use only. The firebox and burner may be painted matte black to enhance the flame appearance.

See Outdoor Torch In the Gas Fireplaces - Modern section of this book

\* Exposure to outdoor weather extremes may affect appearance of painted/plated andirons.

\* Both receiver and transmitter of hand held remote must be kept dry and protected from the elements.





## GSS48 GALAXY™ SERIES

### GSS48 GALAXY™ SERIES OUTDOOR LINEAR GAS FIREPLACE

Tested in Canada and U.S.A as an outdoor gas fireplace. Listed to ANSI Z21.97-2012 / CSA 2.41-2012



- Gas flex connector
- LED lighting with 3 color modes
- Stainless steel burner
- Electronic ignition
- Topaz glass embers
- Up to 55,000 BTU's (NG/LP)
- Glass fender (2 for GSS48ST)

**NOTE: Unit comes complete with both LP and NG orifices and is shipped as natural gas - The conversion instructions are included in the manual**

US \$

Product	Model Description	Finish	WT/lbs.	MSRP/MAP
 GSS48	Outdoor linear gas fireplace - 1-Sided - Natural gas	Stainless steel finish	142	\$2,899
GSS48ST	Outdoor linear gas fireplace - See Thru - 2-Sided - Natural gas	Stainless steel finish	156	\$3,109

### OPTIONS/ACCESSORIES

DECORATIVE					
	LT48SS	Stainless steel trim (2 required for see-thru, 2-sided unit)	Stainless steel	13	\$859
	GSS48COV	Cover (2 required for see-thru model)			\$309
<b>*Note: For use with optional trim kit, or without trim kit but facing material cannot extend past the front surface.</b>					
	GSS48BRT	Brackets, 3" cover extension (for GSS48COV)			\$95
<b>**Note: For use with facing material that extends up to 3" past front with no LT48SS</b>					
	MKRY	Media kit ( 3 suggested)	River rocks-grey	10	\$139
	MKRM	Media kit ( 3 suggested)	River rocks - multi-coloured	10	\$139
	MKGK	Media kit ( 3 suggested)	Glass embers - black	5	\$105
	MKGB	Media kit ( 3 suggested)	Glass embers - blue	5	\$105
	MKGR	Media kit ( 3 suggested)	Glass embers - red	5	\$105
	MKGA	Media kit ( 3 suggested)	Glass embers - amber	5	\$105
	MKGC	Media kit ( 3 suggested)	Glass embers - clear	5	\$105
	MKGT	Media kit ( 3 suggested)	Glass embers - topaz	5	\$105
	DL45	Dirftwood log set (includes log set & 6 river rocks)		20	\$325

**Note: This unit is designed for "outdoor" use only. The firebox and burner may be painted matte black to enhance the flame appearance.**



## GPF OUTDOOR PATIOFLAME®

### GPF OUTDOOR PATIOFLAME®

Tested in Canada and U.S. as an outdoor gas appliance. Listed to UL CR97-O03 and CSA CAN1-2.21 and IASUS4

<ul style="list-style-type: none"> <li>• Exclusive Glocast™ logs &amp; lava rock</li> </ul>	<ul style="list-style-type: none"> <li>• Flexible connector &amp; shutoff (NG)</li> <li>• 60" hose, regulator &amp; tank stand (LP)</li> </ul>	<ul style="list-style-type: none"> <li>• Stainless steel burner &amp; base</li> <li>• Up to 60,000 BTU's</li> </ul>
---	--	---

US \$

	Product	Model Description	Finish	WT/lbs.	MSRP/MAP
	GPFN-1	Outdoor Patioflame®, stainless steel firepit with logs - Natural gas	Brushed stainless steel	38	\$361
	GPFP-1	Outdoor Patioflame®, stainless steel firepit with logs - Propane	Brushed stainless steel	38	\$361



<ul style="list-style-type: none"> <li>• Exclusive Topaz glass ember bed</li> </ul>	<ul style="list-style-type: none"> <li>• Flexible connector &amp; shutoff (NG)</li> <li>• 60" hose, regulator &amp; tank stand (LP)</li> </ul>	<ul style="list-style-type: none"> <li>• Stainless steel burner &amp; base</li> <li>• Up to 60,000 BTU's</li> </ul>
---	--	---





	Product	Model Description	Finish	WT/lbs.	MSRP/MAP
	GPFNG-1	Outdoor Patioflame®, stainless steel firepit with Topaz Glass - Natural gas	Brushed stainless steel	38	\$268
	GPFPG-1	Outdoor Patioflame®, stainless steel firepit with Topaz Glass - Propane	Brushed stainless steel	38	\$268

<ul style="list-style-type: none"> <li>• Electronic ignition</li> <li>• Stainless steel cover &amp; handles</li> </ul>	<ul style="list-style-type: none"> <li>• Topaz Crystalline™ ember bed</li> <li>• Rust resistant surround</li> </ul>	<ul style="list-style-type: none"> <li>• Stainless steel burner chassis</li> <li>• Up to 60,000 BTU's</li> </ul>
--	---	--

	Product	Model Description	Finish	WT/lbs.	MSRP/MAP
	GPFL48MHP	Outdoor Linear Patioflame® - Propane, complete with natural gas conversion kit and painted cabinet	Brushed stainless steel (burner & cover) hammertone pewter (cabinet)	80	\$1,344

### OPTIONS/ACCESSORIES

DECORATIVE					
<b>ALTERNATE MEDIA KITS ARE AVAILABLE TO REPLACE GLOCAST™ LOGS SUPPLIED WITH UNIT</b>					
	MKRY	Media kit	River rocks - grey	10	\$139
	MKRM	Media kit	River rocks - multi-coloured	10	\$139
	MKGC	Media kit (3 bags suggested)	Glass embers - clear	5	\$105
	MK GK	Media kit (3 bags suggested)	Glass embers - black	5	\$105
	MKGB	Media kit (3 bags suggested)	Glass embers - blue	5	\$105
	MKGR	Media kit (3 bags suggested)	Glass embers - red	5	\$105
	MKGA	Media kit (3 bags suggested)	Glass embers -amber	5	\$105
	MKGT	Media kit (3 bags suggested)	Glass embers -topaz	5	\$105

ALL MEDIA ENHANCEMENT KITS ARE DESIGNED FOR RANDOM PLACEMENT WITHIN THE FIREPIT					
<b>AS AN ADDITION TO EITHER THE GLOCAST™ LOGS OR ANY OF THE OTHER OPTIONAL MEDIA KITS</b>					
	MEKR	Media enhancement kit	6 river rocks - grey	3	\$49
	MEGK	Media enhancement kit	1 lb. glass embers - black	1	\$55
	MEGB	Media enhancement kit	1 lb. glass embers - blue	1	\$55
	MEGR	Media enhancement kit	1 lb. glass embers - red	1	\$55
	MEGA	Media enhancement kit	1 lb. glass embers - amber	1	\$55
	MEGT	Media enhancement kit	1 lb. glass embers - topaz	1	\$55
	GPFL-WNDSCRN	Glass windscreen deflector (for GPFL48MHP - linear model only)		27	\$329
	PFT	Patioflame Table (Not suitable for Linear model)		46	\$289
	PFTT-GK	Patioflame Granite Table Top (Not suitable for Linear model)		75	\$289
	PFS	Patioflame® safety screen (Not suitable for Linear model)		6	\$93
	PFC	Patioflame® cover* (package of 6) (Not suitable for Linear model)		24	\$516
	01748	Patioflame® cover* (single cover) (Not suitable for Linear model)		6	\$99

See Outdoor Torch In the Gas Fireplaces - Modern section of this book



## DEALER MINIMUM ADVERTISED PRICE (MAP) POLICY Summary Document

**Disclaimer:** This document is only a SUMMARY of the Napoleon Minimum Advertised Price (MAP) Policy. The MAP Policy is located in the MyNapoleon Dealer Portal or it can be requested directly from the MAP Policy Administrator.

**The Minimum Advertised Price (MAP) for all Napoleon products shall be no less than the Manufacturer's Suggested Retail Price (MSRP)**

### **The Minimum Advertised Price policy applies to:**

- All forms of trade, public and consumer advertising, including the internet
- All dealers / retailers that sell direct to consumers
- All dealers in Canada and the United States
- All Wolf Steel Brands
- All Napoleon Products listed in current Price Books

### **A Reseller will violate the MAP policy by:**

- Advertising a price that is lower than the relevant MSRP/MAP
- Advertising a percentage reduction from a reference price that results in a price lower than the relevant MSRP/MAP
- Using such website features, but not inclusive to, as 'click for price', automated pricing emails, automated price displays that show price lower than MSRP/MAP
- Using website statements such as, but not inclusive to, 'Call for Price', 'email for best price'
- Bundling the Company's products that are lower than the sum of each MAP for the relevant product
- Using strike-through or other alteration of the advertised text that indicates a price lower than MSRP/MAP

### **Exclusions:**

- This Policy only sets forth suggested advertised prices and does not apply to the price at which the products are sold or offered for sale
- Offering 'free shipping' and 'free financing' by the Reseller is allowed at point of sale of Napoleon products
- Website discounts applied at checkout to the entire order based on consumer loyalty/history with Reseller, such as discounts for 'frequent shoppers' is acceptable
- Products marked in the Price Books, as 'Going Obsolete' or 'While Supplies Last' is not applicable to the Policy

24 Napoleon Road  
Barrie, Ontario, Canada  
L4M 0G8  
705-721-1212

214 Bayview Drive  
Barrie, Ontario, Canada  
L4N 4Y8  
705 726-4278

103 Miller Drive  
Crittenden, Kentucky, USA  
41030  
859 428-9555

[www.napoleonproducts.com](http://www.napoleonproducts.com)

FEBRUARY 2016





## DEALER MINIMUM ADVERTISED PRICE (MAP) POLICY Summary Document

### Enforcement:

**1<sup>st</sup> Violation:** A first violation will have occurred when the Dealer violates the Policy for the first time in a 12-month period. The Dealer will have **24 hours to comply with the MAP Policy** from the date of the notification before the infraction is considered a second (2<sup>nd</sup>) violation.

**2<sup>nd</sup> Violation:** A second violation will have occurred when the Dealer violates the Policy within a 12-month period from the date of the 1<sup>st</sup> violation. The Dealer will have **24 hours to comply with the MAP Policy** from the date of the 2<sup>nd</sup> notification before the infraction is considered a third (3<sup>rd</sup>) violation.

A second violation **will result** in:

- Ineligibility to participate in advertising and sales promotions by Napoleon for the period the violation remains uncorrected
- Loss of access to any discounts, coop or rebates offered by Napoleon for the period the violation remains uncorrected
- Removal from the Napoleon website dealer locators for the period the violation remains uncorrected

**3<sup>rd</sup> Violation:** A third violation will have occurred when the Reseller violates the Policy within a 12-month period from the date of the 1<sup>st</sup> violation. The Dealer will have **24 hours to comply with the MAP Policy** from the date of the 3<sup>rd</sup> notification before the infraction is considered a fourth (4<sup>th</sup>) violation.

A third violation **will result** in:

- Loss of any discounts, coop or rebates offered by Napoleon for a period of 12 months
- Limited access to some or all of Napoleon's products until the dealer has remedied
- Being added to the Do-Not-Sell list for some or all of Napoleon's products until dealer has remedied

**4<sup>th</sup> Violation:** A fourth violation will have occurred when the Dealer violates the Policy within a 12-month period from the date of the 1<sup>st</sup> violation.

A fourth violation **will result** in:

- Limited access to some or all of Napoleon's products for an indefinite period
- Being added to Napoleon's Do-Not-Sell list for an indefinite period

**Napoleon's sales personnel, representatives or Dealers (including distributors and wholesalers) have no authority to modify or grant exceptions to the MAP policy.** All question and comments regarding the Policy should be directed to the 'Policy Administrator'. The Policy Administrator shall be responsible for determining whether a violation of this policy has occurred.

The MAP Policy Administrator  
24 Napoleon Road  
Barrie, Ontario  
L4M 0G8  
Canada  
Email: [MapPolicy@napoleonproducts.com](mailto:MapPolicy@napoleonproducts.com)

24 Napoleon Road  
Barrie, Ontario, Canada  
L4M 0G8  
705-721-1212

[www.napoleonproducts.com](http://www.napoleonproducts.com)

214 Bayview Drive  
Barrie, Ontario, Canada  
L4N 4Y8  
705 726-4278

103 Miller Drive  
Crittenden, Kentucky, USA  
41030  
859 428-9555

FEBRUARY 2016





## NAPOLEON - CELEBRATING OVER 40 YEARS OF HOME COMFORT PRODUCTS



103 Miller Drive, Crittenden, Kentucky, USA 41030  
24 Napoleon Road, Barrie, Ontario, Canada L4M 0G8  
7200 Trans Canada Highway, Montreal, Quebec H4T 1A3

Tel: 705-721-1212 Fax: 705-722-6031  
[napoleonfireplaces.com](http://napoleonfireplaces.com)