

Installation, Operation
and Maintenance Manual



Series e³-4 / e³-6

Instant hot water recirculating systems



Bell & Gossett

a xylem brand

Table of Contents

1	Introduction and Safety	4
1.1	Introduction	4
1.2	Safety	4
1.2.1	Danger levels and safety symbols	4
1.2.2	User Safety	6
2	Handling and Storage	9
2.1	Handling of the packed unit	9
2.2	Unit inspection upon delivery	9
2.2.1	Inspect the package	9
2.2.2	Unpacking and inspection of the unit	9
2.3	Unit handling	10
2.4	Storage	10
3	Technical Description	11
3.1	Designation	11
3.2	Integrated features and functions	11
3.3	Data plate	12
3.4	Model description	12
3.5	Names of the main components and accessories	13
3.6	Intended use	14
3.7	Improper use	16
4	Installation	17
4.1	Precautions	17
4.2	Installation area	17
4.3	Hydraulic connection	18
4.3.1	Guidelines for the hydraulic system	18
4.3.2	Installation	22
4.3.3	Rotation of the pump motor	25
4.4	Electrical connection	27
4.4.1	Ground	27
4.4.2	Guidelines for electrical connection	28
4.4.3	Guidelines for timer connection	29
5	Use and Operation	30
5.1	Precautions	30
5.2	Before starting	30
5.3	First starting	30
5.4	Air purge	31
5.5	Setting the timer	31
5.6	Operation modes	33

5.6.1	Fix speed models	33
5.6.2	Variable speed models	33
5.6.3	Fix speed models with fix value temperature control	33
5.6.4	Fix speed models with variable value temperature control	33
5.6.5	Autocirc pumps	34
5.6.6	LED light	34
5.6.7	Motor protection from overtemperature	34
5.6.8	Dry run protection	35
5.6.9	Power Down Reset (PDR)	35
5.6.10	Temperature sensor error mode	35
6	Maintenance	36
6.1	Precautions	36
6.2	Maintenance	36
6.3	Autocirc pumps	37
6.4	Disassembly	37
7	Troubleshooting	38
7.1	Precautions	38
7.2	Error signals	38
7.3	Pump not running	38
7.4	Pump running for 1 minute periods only (temperature controlled models only)	38
7.5	Noise in the system	39
7.6	Water taking too long to get to faucet/tap	39
7.7	Signs of dry run	39
8	Technical Information	40
8.1	Certifications	40
8.2	Operating environment	40
8.3	Pumped liquid	40
8.4	Electrical characteristics	40
8.5	Mechanical characteristics	41
8.6	Dimensions and weights	41
8.7	Hydraulic curves	43
8.8	OEM models	45
9	Disposal	46
9.1	Precautions	46
10	Warranty	47

1 Introduction and Safety

1.1 Introduction

Purpose of this manual

This manual provides information on how to do the following in the correct manner:

- Installation
- Operation
- Maintenance



CAUTION:

This manual is an integral part of the unit. Make sure to have read and understood the manual before installing the unit and putting it to use. Failure to follow these instructions can cause personal injury and damage to property, and may void the warranty and result in the loss of all entitlement to claim damages.

NOTICE:

The manual must always be made available to the user either as a printout or as a downloaded and offline stored electronic file.

Supplementary instructions

The instructions and warnings of this manual apply to the standard unit as described in the sale documentation. Special version pumps may be supplied with supplementary instruction manuals. For situations not considered in the manual or in the sales document, contact Xylem or the Authorized Distributor.

1.2 Safety



WARNING:



- The operator must be aware of safety precautions to prevent physical injury.
 - Operating, installing, or maintaining the unit in any way that is not covered in this manual could cause death, serious personal injury, or damage to the equipment. This includes any modification to the equipment or use of parts not provided by Xylem. If there is a question regarding the intended use of the equipment, please contact a Xylem representative before proceeding.
 - Do not change the service application without the approval of an authorized Xylem representative.
-

1.2.1 Danger levels and safety symbols









Before using the unit, the user must read, understand and comply with the indications of the danger warnings in order to avoid the following risks:

- Injuries and health hazards
- Damage to the product and its surroundings
- Unit malfunction

Danger levels

Hazard level	Indication
 DANGER:	It identifies a dangerous situation which, if not avoided, causes serious injury, or even death.
 WARNING:	It identifies a dangerous situation which, if not avoided, may cause serious injury, or even death.
 CAUTION:	It identifies a dangerous situation which, if not avoided, may cause small or medium level injuries.
NOTICE:	It identifies a situation which, if not avoided, may cause damage to property but not to people.

Complementary symbols

Symbol	Description
	Electrical hazard
	Hot surface hazard
	Danger, system pressurized
	Do not use flammable liquids
	Do not use corrosive liquids
	For indoor use only Protect the unit against freezing
	For indoor use only Protect the unit against water dripping
	For indoor use only Protect the unit against direct sunlight

1.2.2 User Safety

IMPORTANT SAFETY INSTRUCTIONS



CAUTION:

When installing and using this equipment, basic safety precautions should always be followed. Read, follow and save all these instructions!



WARNING:

To reduce the risk of injury, do not permit children to use this product unless they are closely supervised at all times.

The pump models covered by this manual are certified generally under the safety standard UL 778, but in case of some special OEM models (usually with plastic pump housing for spa application) the UL 1081 certification is also available. This reference is indicated on the data plate, see item 1 in **Figure 1** on page 12.

These pumps are also certified as a Drinking Water System Component according to NSF/ANSI 61.

SAFETY INSTRUCTIONS according to UL 778



CAUTION:

Acceptable for indoor use only. This pump has been evaluated for use with water only. Use with maximum 203 °F (95 °C) water.



WARNING: Risk of electric shock

This pump has not been investigated for use in swimming pool or marine areas. This pump is not submersible.



WARNING: Risk of electric shock

This pump is supplied with a grounding conductor and grounding-type attachment plug. To reduce risk of electric shock, connect only to a properly grounded, grounding-type receptacle.



WARNING:

To reduce the risk of electric shock, replace damaged cord immediately. For supply connection, use wires acceptable for at least 194 °F (90 °C). Use copper conductors only.

SAFETY INSTRUCTIONS according to UL 1081



WARNING:

To reduce the risk of electric shock, replace damaged cord immediately.



WARNING: Risk of electric shock

Do not install within an outer enclosure or beneath the skirt of a hot tub or spa. This pump is not submersible.



WARNING: Risk of electric shock

Connect only to a branch circuit protected by a ground-fault circuit-interrupter (GFCI). Contact a qualified electrician if you cannot verify that the circuit is protected by a GFCI.

The unit must be connected only to a supply circuit that is protected by a ground-fault circuit-interrupter (GFCI). Such a GFCI should be provided by the installer and should be tested on a routine basis. To test the GFCI, push the test button. The GFCI should interrupt power. Push the reset button. Power should be restored. If the GFCI fails to operate in this manner, the GFCI is defective. If the GFCI interrupts power to the pump without the test button being pushed, a ground current is flowing, indicating the possibility of an electric shock. Do not use this pump. Disconnect the pump and have the problem corrected by a qualified service representative before using.

NSF/ANSI 61 limitation

CAUTION:

Do not allow the temperature above 140 °F (60 °C) in systems circulating drinking water.

California Proposition 65

WARNING: California Proposition 65 warning

This product contains chemicals known to the state of California to cause cancer and birth defects or other reproductive harm.

Qualified personnel

WARNING:

This unit must be used only by qualified users. Qualified users are people able to recognize the risks and avoid hazards during installation, use and maintenance of the unit.

General safety rules

- Always keep the work area clean.
- Pay attention to the risks presented by gas and vapors in the work area.
- Avoid all electrical dangers. Pay attention to the risks of electric shock or arc flash hazards.
- Always bear in mind the risk of electrical accidents and burn injuries.

Safety equipment

It is recommended to use the proper safety equipment within the work area:

- Hard hat
- Safety goggles
- Protective shoes
- Protective gloves
- Hearing protection

Electrical connections

Electrical connections must be made by certified electricians in compliance with all international, national, state, and local regulations.

Precautions before work

Observe these safety precautions before you work with the product:

- Make sure that you have a clear path of retreat.
- Allow all system and pump components to cool before you handle them.
- Make sure that the product has been thoroughly cleaned.
- Disconnect and lock out power before you service the pump.

Precautions during work

Observe these safety precautions when you work with the product:

- Rinse the components in water after you disassemble the pump.
- Do not exceed the maximum working pressure of the pump.
- Do not open any vent or drain valve or remove any plugs while the system is pressurized. Make sure that the pump is isolated from the system and that pressure is relieved before you disassemble the pump, remove plugs, or disconnect piping.

2 Handling and Storage

2.1 Handling of the packed unit



WARNING:

Take appropriate measures during transport, installation and storage to prevent contamination from external substances.

The Manufacturer delivers the unit and its components in a cardboard box.

2.2 Unit inspection upon delivery

2.2.1 Inspect the package

1. Check that quantity, descriptions and product codes match the order.
2. Check the packaging for any damage or missing components.
3. In case of immediately detectable damage or missing parts:
 - accept the goods with reserve, indicating any findings on the transport document, or
 - reject the goods, indicating the reason on the transport document.

In both cases, promptly contact Xylem or the Authorized Distributor from whom the product was purchased.

2.2.2 Unpacking and inspection of the unit



CAUTION: Cut and abrasion hazard

Always wear personal protective equipment.

1. Remove packing materials from the product. Dispose of all packing materials in accordance with local regulations.
2. Check the unit for integrity and to make sure that there are no missing components.
3. In case of damage or missing components, promptly contact Xylem or the Authorized Distributor.

Content of the package

- Pump unit
- Union fitting for 1/2" copper pipe – 1-18 UNSx1/2" – 2 pcs.
(for models: e³-__/BU___ only)
- Fixing bracket
(for models: e³-4V/BAP_C only)
- Fixing screw – 5/32"x1 9/16" (4x40 mm) – 2 pcs.
(for models: e³-4V/BAP_C only)
- Plastic anchor for wall mount – 1/4"x1 3/16" (6x30 mm) – 2 pcs.
(for models: e³-4V/BAP_C only)
- Safety Instructions and Quick Startup Guide

2.3 Unit handling



WARNING: Electrical hazard

Holding the unit by the supply cord is strictly forbidden.



WARNING:

During handling, make sure to avoid injury to people and animals, and/or damage to property.

2.4 Storage

Storage of the packed unit

The unit must be stored:

- In a covered and dry place
- Away from heat sources
- Protected from dirt
- Protected from vibrations
- At an ambient temperature between -40 °F and 185 °F (-40 °C and 85 °C), and relative humidity between 5 % and 95 %.

NOTICE:

Do not place heavy loads on top of the unit.

NOTICE:

Protect the unit from collisions.

3 Technical Description

3.1 Designation

Domestic hot water circulating pump.

OEM applications

For special OEM applications the pump has customized versions, which differ from the standard versions in one or more features of the followings:

- Special software functions
- Customized power supply cable (special connectors or terminals)
- Alternative circulating fluid
- Built-in applications (water pumps for use in water heaters, spas, etc.)

3.2 Integrated features and functions

Identification based on part number:

	60A__0...	60A__1...	60A__2...	60A__3...	60A__4...	60A__5...	60A__6...
Fix speed	●				●		
Variable speed		●				●	
PWM control			○**				
Temperature control				●			●
Timer control					●	●	●
Standby mode		●		○*		●	○*
Air purge function		●		○*		●	○*
Error code flashing LED light		●		○*		●	○*
Dry run protection	○**				○**		
Power Down Reset	○**				○**		

* The function is available only in models with control knob

** The function is available only in special OEM models

Identification based on model description:

	e ³ __/BT__	e ³ __/BS__	e ³ __/BU__	e ³ -4V/BAP_C
Brass pump housing	●	●	●	●
Integrated shut-off valve			●	
Integrated check valve			●	
Integrated air vent			●	
Internal 1/2-14 NPT thread connections	●			
Sweat connections for 1/2" copper pipes		●		
External 1-18 UNS thread connections			●	
External 1/2-14 NPT thread connections for water inlet				●
External 9/16-24 UNEF thread connections for water outlet				●

3.3 Data plate

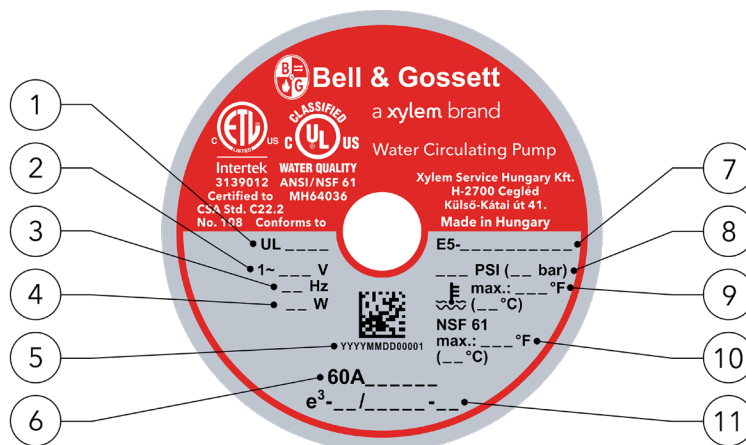

Figure 1

No.	Description	No.	Description
1	Applied UL standard	7	Technical code
2	Rated voltage	8	Nominal system pressure
3	Frequency	9	Maximum water temperature
4	Input power	10	Maximum water temperature for using with drinking water (NSF 61 classified)
5	Serial number incl. manufacturing date		
6	Part number	11	Model description

3.4 Model description

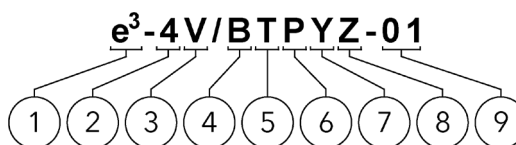

Figure 2

No.	Description	Notes
1	Series model name	e ³
2	Maximum flow	4 = 4 gpm (15 l/min) 6 = 6 gpm (23 l/min)
3	Motor control*	V = Variable speed P = PWM control (only for OEM applications) F = Fix speed
4	Pump housing material*	B = Brass D = Plastic for drinking water (NSF 61 compliant) S = Stainless steel P = Plastic, not approved for drinking water
5	Pump housing connection*	H = Hose T = Threaded S = Sweat U = Union A = Autocirc X = Drive unit (without pump housing)
6	Power cord	P = With cord X = Without cord
7	Temperature control	Q = Temperature control, fix value R = Temperature control, adjustable Y = Without temperature control
8	Timer control	C = With built-in timer Z = Without timer
9	Constructional variations*	01-49 = Not potted models 50-99 = Potted models (only for OEM applications)

* Not all the listed options are covered by this manual

3.5 Names of the main components and accessories

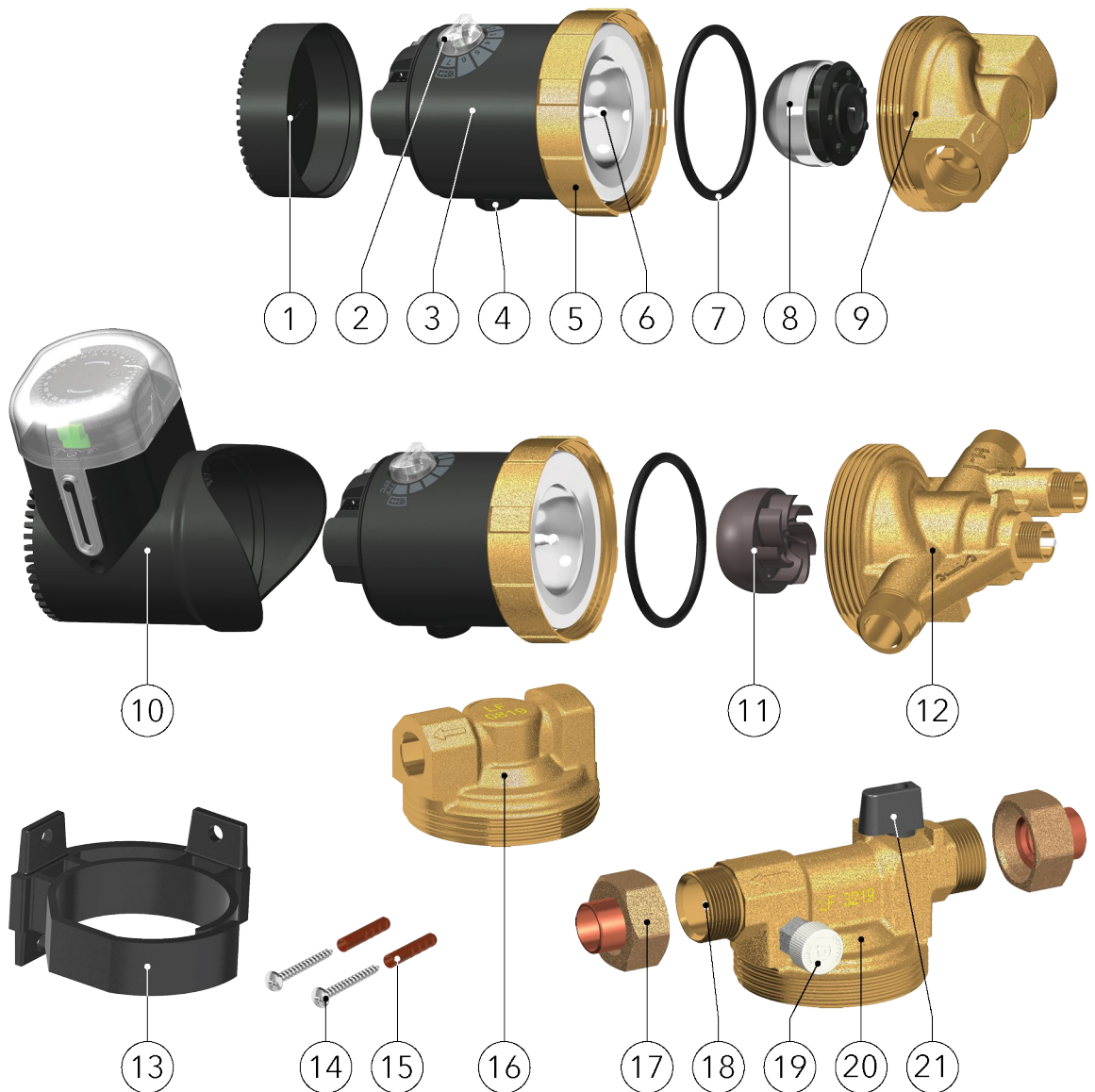

Figure 3

No.	Description	No.	Description
1	End cap	12	Pump housing Autocirc (code: BA)
2	Control knob	13	Fixing bracket
3	Stator (pump motor)	14	Screw 5/32"x1 9/16" (4x40 mm); 2 pcs.
4	Cable gland	15	Plastic anchor 1/4"x1 3/16" (6x30 mm); 2 pcs.
5	Screw ring	16	Pump housing Sweat (code: BS)
6	Ceramic bearing ball	17	Union fitting for 1/2" copper pipe; 2 pcs.
7	O-ring	18	Integrated check valve
8	Rotor with closed impeller	19	Integrated air vent
9	Pump housing 1/2-14 NPT (code: BT)	20	Pump housing 1-18 UNS (code: BU)
10	Timer	21	Integrated ball shut-off valve
11	Rotor with open impeller		

3.6 Intended use

Circulating pump for domestic hot water systems.

If hot water is not used for longer periods of time, the water in the hot water pipe cools off. Domestic hot water pumps (also called sanitary or drinking water circulating pumps) pump this cold water back into the water heater via a separate recirculation pipe, or directly into the cold water supply line (see **Figure 5** and **Figure 6** on page **19** and **20**). At the same time fresh hot water is flowing out of the water heater and provides a constant supply of hot water at the tap.



WARNING: Risk of electric shock

This pump has not been investigated for use in swimming pool or marine areas. Do not install within an outer enclosure or beneath the skirt of a hot tub or spa. This pump is not submersible.



CAUTION:

Acceptable for indoor use only. This pump has been evaluated for use with water only. Use with maximum 203 °F (95 °C) water.

Pump selection

The **e³-4 series** models are designed to handle the recirculation requirements of residences with a pipe loop (the total length of hot water supply line plus the recirculation line) up to 250 ft (76 m).

The **e³-6 series** pumps are designed to handle the recirculation requirements of residences and small apartment complexes with pipe loop runs to 700-1000 ft (213-305 m).

Because the system is pressurized, the number of floors in a home is not taken into consideration in sizing the circulating pump. The pump has only to produce continuous flow at a pressure sufficient to overcome the friction losses created by the piping in the house water supply line and the return line.

NOTICE: Water pressure

A recirculating system is a pressurized system operating at the city water pressure, as determined by the pressure regulator on your line, or by a well pump, if you are on a well system. In most residential plumbing systems, water pressure is set at 35 psi (241 kPa) and above. Below 35 psi (241 kPa), water pressure may not be sufficient to fill the pipe diameter, leaving space for air to accumulate in the lines.

If your system pressure is less than 35 psi (241 kPa), use the next larger pump on the Pump Selection Guide.

NOTICE: Oversized pumps

Pumps should not be so large as to produce flow rates that may eventually erode holes in the pipes. According to the Copper Development Association, excessive erosion occurs at a velocity of about 5 ft (1.5 m) per second and higher; or about 4 gpm (15 l/min) in 1/2" Type M copper pipe.

Use the recommended recirculation line size shown in the Pump Selection Guide. The **e³ series** pumps are sized so that flow velocities are below these limits.

Autocirc pumps

In case using an Autocirc pump, there is no need to build a separate recirculation line, the unit should be installed under the sink farthest from the water heater, where hot water takes longest to arrive. The pump then moves the cool water in the hot water supply line into the cold water supply line, ensuring instant availability of shower warm water with maximum temperature hot water only seconds behind. When the pump is off, a built-in auto closure device prevents hot and cold water mixing. Hot water will also be instantly available at all other faucets/taps between the water heater and the sink under which the Autocirc pump is installed. See the operating principle in **Figure 4** on page **15**.

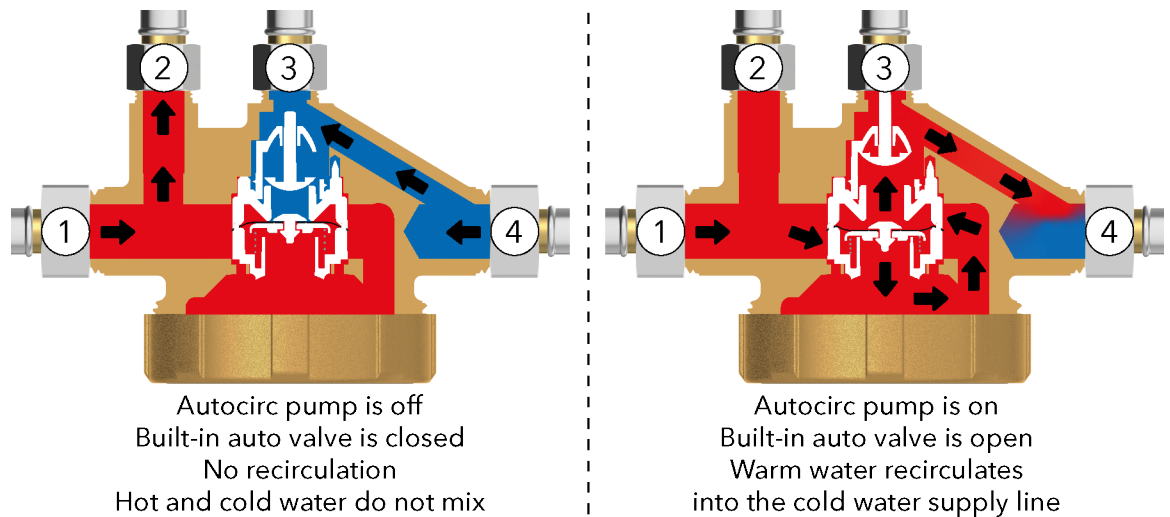

Figure 4

No.	Description	No.	Description
1	Pump inlet from hot water supply line	3	Pump outlet to faucet/tap for cold water
2	Pump outlet to faucet/tap for hot water	4	Pump inlet from cold water supply line

Pumped liquids



CAUTION:

This pump has been designed and tested for use with water only. Its suitability for use with liquids other than water is the end user's responsibility.



WARNING:

In domestic hot water systems, the water is recommended to be pumped at a temperature above 122 °F (50 °C) to prevent the risk of legionella.

NOTICE:

Keep the hot water temperature below 140 °F (60 °C). Higher temperatures can cause calcium and magnesium elements to come out of solution and create solids which could not only cause damage to the pump, but also reduce water heater efficiency and premature failure of the water heater.

Hard Water Conditions

Use a water conditioner if you have hard water. Hard water can cause scale build-up and eventually reduce the life of the pump and other system components.

OEM applications

For use with alternative circulating fluids contact Xylem or the Authorized Distributor.

The liquids must be:

- Clean
- Free of solid - especially metallic - particles or fibers
- Free of mineral oils
- Chemically and mechanically non aggressive
- Non-flammable
- Non-explosive

Observe the operating limits in section **8 Technical Information** on page **40**.

3.7 Improper use



WARNING:

The unit was designed and built for the use described in section **3.6 Intended use** on page **14**. Any other uses are prohibited, as they could compromise the safety of the user and the efficiency of the unit itself.



DANGER:

It is prohibited to use this unit to pump flammable and/or explosive liquids.



CAUTION:

It is prohibited to use the unit to pump aggressive liquids, acids and seawater.



DANGER: Potentially explosive atmosphere hazard

It is prohibited to start the unit in environments with potentially explosive atmospheres or with combustible dusts.



WARNING:

It is prohibited to pump drinking water after use with other fluids.

Examples of improper use

- Pumping liquids not compatible with the construction materials of the unit.
- Pumping liquids with temperatures higher than what shown in section **8 Technical Information** on page **40**.
- Pumping hazardous, toxic, explosive, flammable or corrosive liquids.
- Pumping seawater.

4 Installation

4.1 Precautions

Before starting, make sure that the safety instructions shown in section **1.2 Safety** on page **4** have been fully read and understood.



DANGER: Potentially explosive atmosphere hazard

It is prohibited to start the unit in environments with potentially explosive atmospheres or with combustible dusts.



WARNING:

Always wear personal protective equipment.



WARNING:

Always use suitable working tools.



WARNING:

When selecting the place of installation and connecting the unit to the hydraulic and electric power supplies, strictly comply with current regulations.



WARNING:

Remove the unit from its packaging just before installation to prevent contamination from external substances.

4.2 Installation area

- Only install in dry rooms where the pump and the piping is protected from freezing.
- Install in one of the permitted mounting positions (see **Figure 8** on page **23**).
- Observe the instructions given in the section **8.2 Operating environment** on page **40**.



WARNING: Risk of electric shock

This pump has not been investigated for use in swimming pool or marine areas. Do not install within an outer enclosure or beneath the skirt of a hot tub or spa. This pump is not submersible.



CAUTION:

Acceptable for indoor use only.

This pump has been evaluated for use with water only. Use with maximum 203 °F (95 °C) water.



WARNING: Hot surface hazard

If the pump, motor or piping are operating at extremely high or low temperature, guarding or insulation is required.



CAUTION: Property damage hazard

It is not advisable to install circulators in an attic or upper floor over finished living space. If the circulator must be installed over head, or over expensive equipment, provide adequate drainage in the event of leakage. Failure to follow these instructions could result in property damage.

4.3 Hydraulic connection



WARNING:

All the hydraulic connections must be completed by a technician possessing the technical-professional requirements outlined in the current regulations.



WARNING: Excessive system pressure hazard

Piping must be sized to ensure safety at the maximum operating pressure.

The maximum pressure value of the pump is listed on the data plate. Do not exceed this pressure.



WARNING: Excessive system pressure hazard

The heating of water and other fluids causes volumetric expansion. The associated forces may cause failure of system components and the release of high temperature fluids.

This can be prevented by installing properly sized and located compression tanks and pressure relief valves.

4.3.1 Guidelines for the hydraulic system

Recirculating pumps installed in the return line

- Before starting piping work shut off the water to the house and drain the affected sections of the plumbing lines and the water heater if necessary.
- Select the sink under which to connect the recirculation line (the sink where the hot water takes longest to arrive, which is usually the sink farthest from the water heater).
- Use 1/2" tubing for the recirculation line.
- Connect the return line with a tee fitting at the last faucet/taps riser, as close to the end of the hot water supply line as possible and run the line back to the water heater.
- Decide on the course of the recirculation pipe (also determining the length of the pipe required) and whether the return line should be connected to the water heater cold water inlet line (tee fitting required) or to the bottom water heater drain valve ("Y" type fitting required to fit to existing drain valve outlet). See **Figure 5** and **Figure 6** on page **19** and **20** for the installation schematic.
- The pump must always be installed in the recirculation line, below the water level of the water heater.
- Do not mount the pump above the water heater, if possible, install the unit at the lowest point of the system.
- Do not install the unit pumping away from the water heater, or directly in the supply line.
- Support the pipes independently, so that their weight does not load the unit.
- Check to be sure there are no crimps or sharp bends in the recirculation line that would restrict the flow.
- Remove any welding residues, deposits and impurities in the pipes that could damage the unit.
- Check that other units do not come in contact with the unit.
- When using pump models with pump housing code **BT** or **BS** (item **9** and **16** in **Figure 3** on page **13**), use a 1/2" swing check valve with appropriate closing pressure. This prevents water from flowing through the pump backwards when any faucet is opened, thus causing damage.
- Install the check valve after the pump in the direction of flow, so that the arrows on the pump housing and on the check valve point in the same direction.

- We recommend, that for pump models with pump housing code **BT** or **BS**, you install a ball shut-off valve before the pump at least, for future maintenance or repair works.
- A properly installed system should include a method of automatically venting the air that enters the water supply line during use. Air enters the system each time fresh, cold water is introduced into the hot water heater. Air may also enter the system any time a plumbing line is opened, for instance during a faucet/taps change or adding a sprinkler system. We recommend, that for pump models with pump housing code **BT** or **BS**, you install an air vent mounted in a vertical position.
- Pumps with pump housing code **BU** (item 20 in **Figure 3**) incorporate a check valve (item 18 in **Figure 3**), a ball shut-off valve (item 21 in **Figure 3**) and a manual air vent valve (item 19 in **Figure 3**) into the brass pump housing eliminating the need to install these components.
- With the shut-off valve closed at the suction side of the pump and with the check valve installed at the discharge side, the screw ring (item 5 in **Figure 3**) can be loosen, thus the pump motor can be turned in proper position (see section **4.3.3 Rotation of the pump motor** on page 25), or even removed for maintenance (see section **6.4 Disassembly** on page 37) without completely draining the system.
- To be able to exclude the complete unit from the system, e.g. for replacement of the pump housing without draining the whole system, install additional shut-off valves both at the suction and at the discharge side of the pump.

The next examples in **Figure 5** and **Figure 6** show typical installation arrangements for different return line connection layout, but for single line returns only. For multiple branched supply line installations, a recirculation line should be installed for each branch.

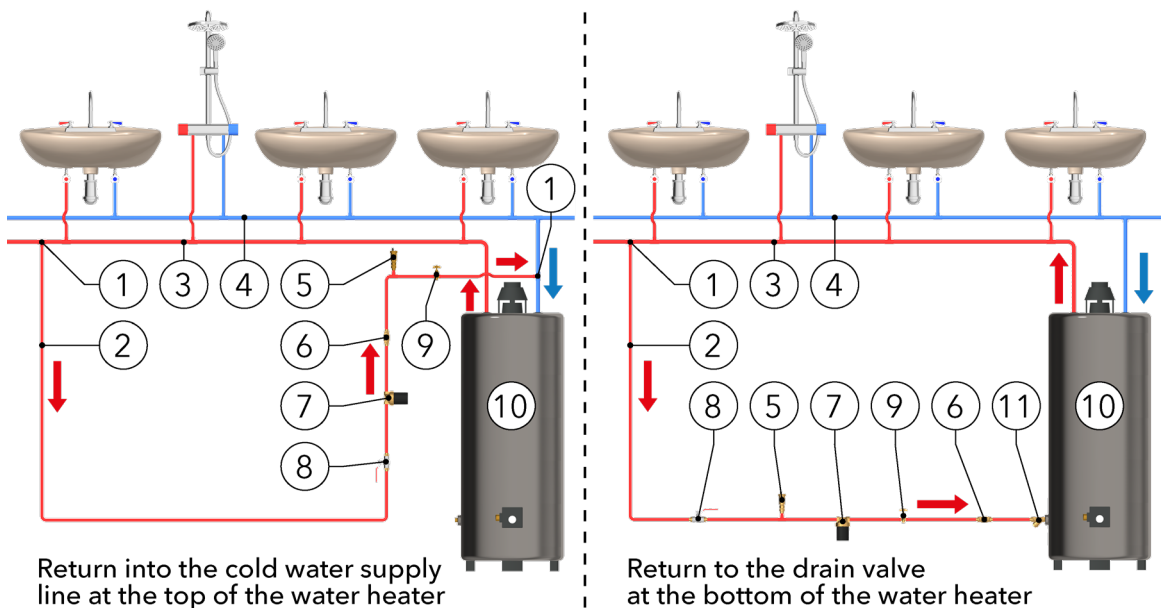

Figure 5

No.	Description	No.	Description
1	Tee fitting	7	Circulating pump model BT / BS
2	Hot water return (recirculation) line	8	Ball shut-off valve
3	Hot water supply line	9	Hose bib
4	Cold water supply line	10	Water heater
5	Air vent	11	"Y" fitting
6	Check valve		

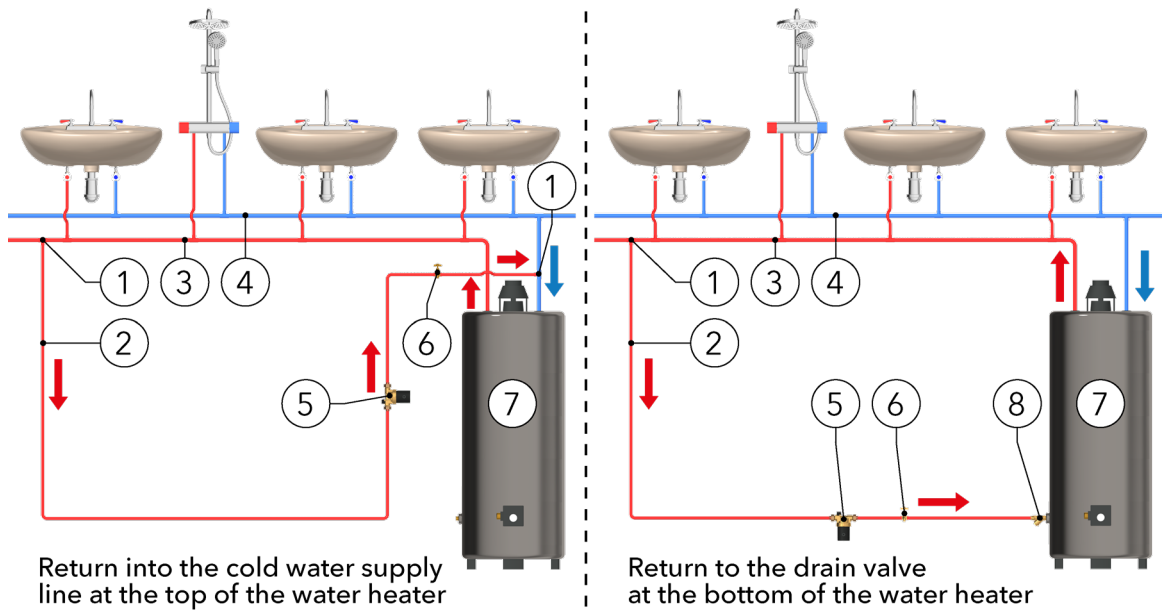

Figure 6

No.	Description	No.	Description
1	Tee fitting	5	Circulating pump model BU
2	Hot water return (recirculation) line	6	Hose bib
3	Hot water supply line	7	Water heater
4	Cold water supply line	8	"Y" fitting

Autocirc pumps

- Select the sink under which the Autocirc pump is to be located (the sink where the hot water takes longest to arrive, which is usually the sink farthest from the water heater).

NOTICE:

At the sink under which the Autocirc pump is installed some "lukewarm" water will appear in the cold water line due to the transfer of water from the hot side to cold side. This lukewarm water will, however, disappear in a short time (4-5 seconds) once the cold faucet/taps is opened.

- Take care that a 115 V / 60 Hz grounded electrical outlet must be available within 6 feet of the installation site, as the unit is supplied with a 6 feet long, grounded cord.

NOTICE:

The next installation guide applies to most situations where faucets/taps are connected to the hot and cold water supply lines with braided flexible hose/shut off valve arrangements. If the under sink arrangement is different (i.e. the risers are hard copper or plastic), then other parts may be required for the installation.

- Plan the installation position of the Autocirc pump on the wall under the sink, so that the existing flexible hoses can be reused and connected to the unit without kinking or straining (see **Figure 7** on page 21). The pump must be installed only in a vertical position as shown.

NOTICE:

Do not fasten the pump to a thin wood panel wall as this might create a vibration noise when the pump is operating.

- Measure the distance between the connections of the pump outlets and the faucets/taps and purchase two stainless steel flexible hoses (1/2" – 9/16") in the length required. If felt necessary, replace also the existing flexible hoses with new stainless steel braided flexible hoses in the lengths required.

- Before starting installation work close the under sink hot and cold water riser shut-off valves and open the hot and cold water faucets/taps to relieve the water pressure. Close the water faucets/taps.

NOTICE:

In some older homes, the riser shut-off valves may be difficult to shut off completely, or maybe it is necessary to turn the valves into a different orientation. If this is the case shut the water off at the main water inlet valve to the house.

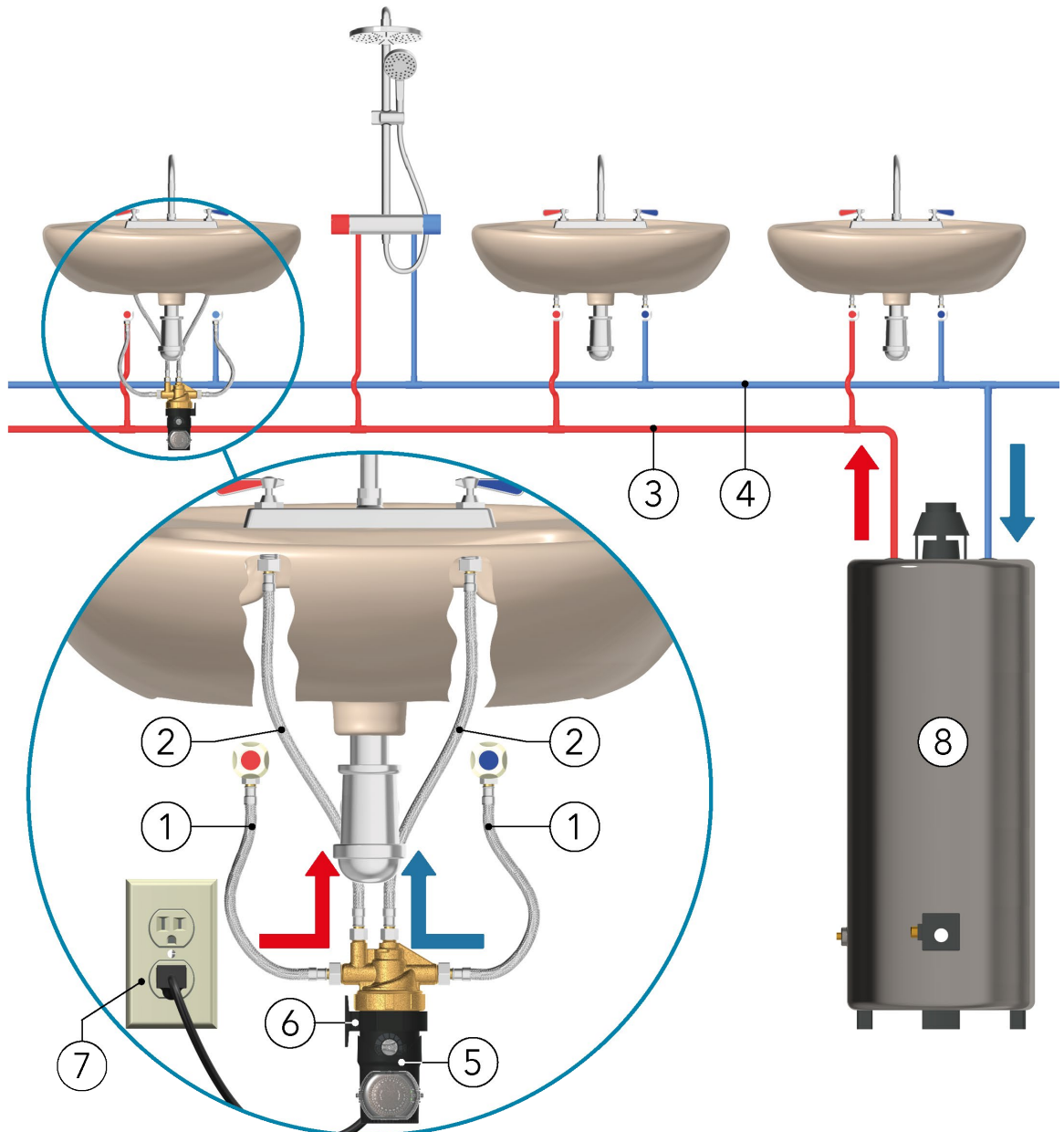

Figure 7

No.	Description	No.	Description
1	Existing flexible hoses	5	Autocirc pump model BA
2	New flexible hoses	6	Mounting bracket
3	Hot water supply line	7	Grounded electric outlet 115 V / 60 Hz
4	Cold water supply line	8	Water heater

4.3.2 Installation



WARNING: Danger, system pressurized

Before starting work, close the shut-off valves on the suction and discharge sides or drain the system.



CAUTION:

Install appropriate seals between the unit couplings and the piping system.



WARNING: Hot water leakage hazard

Pressurize the system slowly while checking for leaks at all joints with gaskets or solder connections.



WARNING:

After installation, run the unit for a few minutes with several utilities open in order to wash the inside of the system.

Recirculating pumps - Installation sequence

1. First read and follow the concerning instructions in section **4.3.1 Guidelines for the hydraulic system** on page **18-19**.
2. Unscrew the screw ring (item **5** in **Figure 3** on page **13**) and remove the motor unit and o-ring from the pump housing. Do not sweat the housing into the plumbing line with the motor or o-ring attached.
3. Identify the arrow, cast on the pump housing to define the flow direction of the liquid.
4. Install the pump housing into the plumbing line in the proper flow direction and in one of the permitted mounting positions (see **Figure 8** on page **23**).
5. The **BU** models are supplied with 1/2" union fittings. These fittings should be removed from the pump housing before soldering to avoid damaging the internal valves.
6. For **BT** models, use the proper gaskets or thread seal and tighten the connections.
7. Close the shut-off valve on the inlet side of the pump and turn the water supply to the house back on.
8. Flush system of debris. Before reattaching the pump motor, open the shut-off valve on the inlet side of the pump housing and let water flow through the housing. Use a bucket to catch the water. Let the water run long enough to clear all sand, solder pellets, plumbers tape flakes, etc. from the lines. Close the inlet shut-off valve when finished.
9. If the pump unit is supplied without a power cord, prepare the electrical connection according to the instructions in section **4.4 Electrical connection** on page **27**.
10. Connect the pump motor to the housing. Make sure the rubber o-ring is in place in the housing and the screw ring is securely tightened.

NOTICE:

Do not over tighten the screw ring! Do not use plumbers putty on its thread!

Applicable tightening torque:

Brass screw ring (standard product range): ~110 lb-in (12.5 Nm)

Plastic screw ring (only for OEM applications): ~80 lb-in (9 Nm)

11. Reopen the shut-off valve or valves and let the water flood the pump housing.
12. Purge air from the supply line. Turn on the faucet/taps or shower farthest from the water heater. Open the line until you get a good, steady stream of water without sputter or evidence of air.
13. Purge air from the return line. Connect the pump to the electrical supply. With the pump running, open the hose bib and let water run until the pump is running quietly and there is no sputtering or other evidence of air coming from the hose bib. Then close the hose bib.
14. Your system is now in operation. Allow a few minutes for instant hot water to recirculate to all of your faucet/taps.

Permitted positions for recirculating pumps

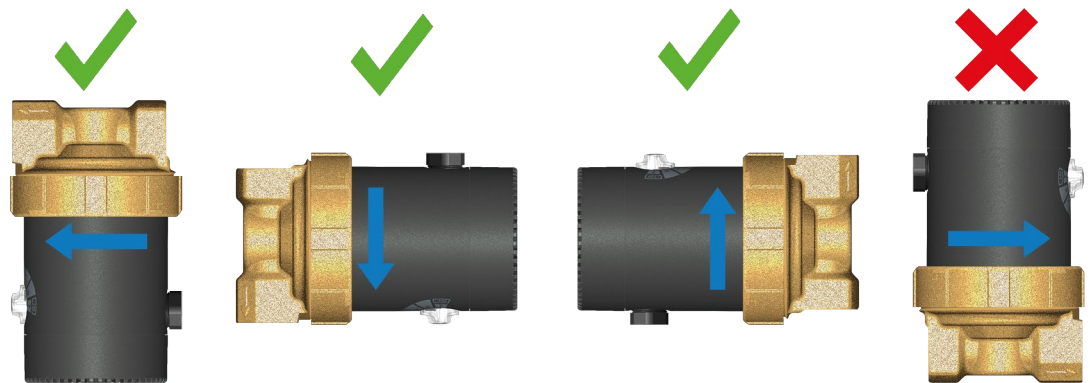

Figure 8

Autocirc pumps - Installation sequence

1. First read and follow the concerning instructions in section **4.3.1 Guidelines for the hydraulic system** on page 20-21.
2. Fasten the Autocirc unit to the wall under the sink using the wall bracket provided in the Autocirc kit. Be sure the pump timer is turned toward the front and is accessible for setting and changing the time. The pump must be installed only in vertical position, as shown in **Figure 9**.

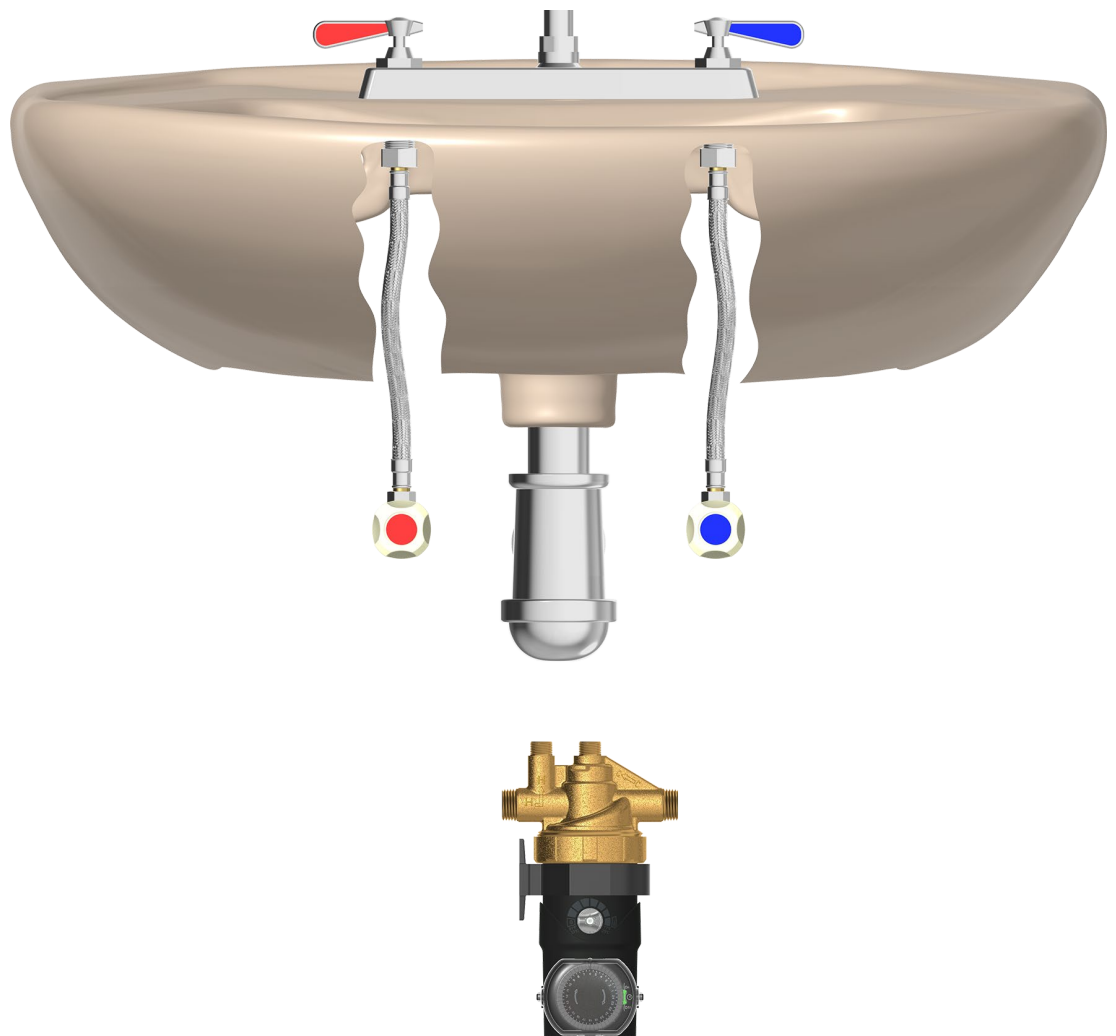

Figure 9

3. Remove the existing flexible line connection to the hot and cold water faucet/tap threaded nipples.
4. Screw on the two existing 1/2" hose connections to the corresponding hot and cold sides of the pump housing (see **Figure 10**). Be sure not to "kink" these existing hose lines during bending which may prevent adequate flow and/or cause the valves to break. If necessary turn the riser shut-off valves into a more favorable orientation. If this is the case shut the water off at the main water inlet valve to the house first.

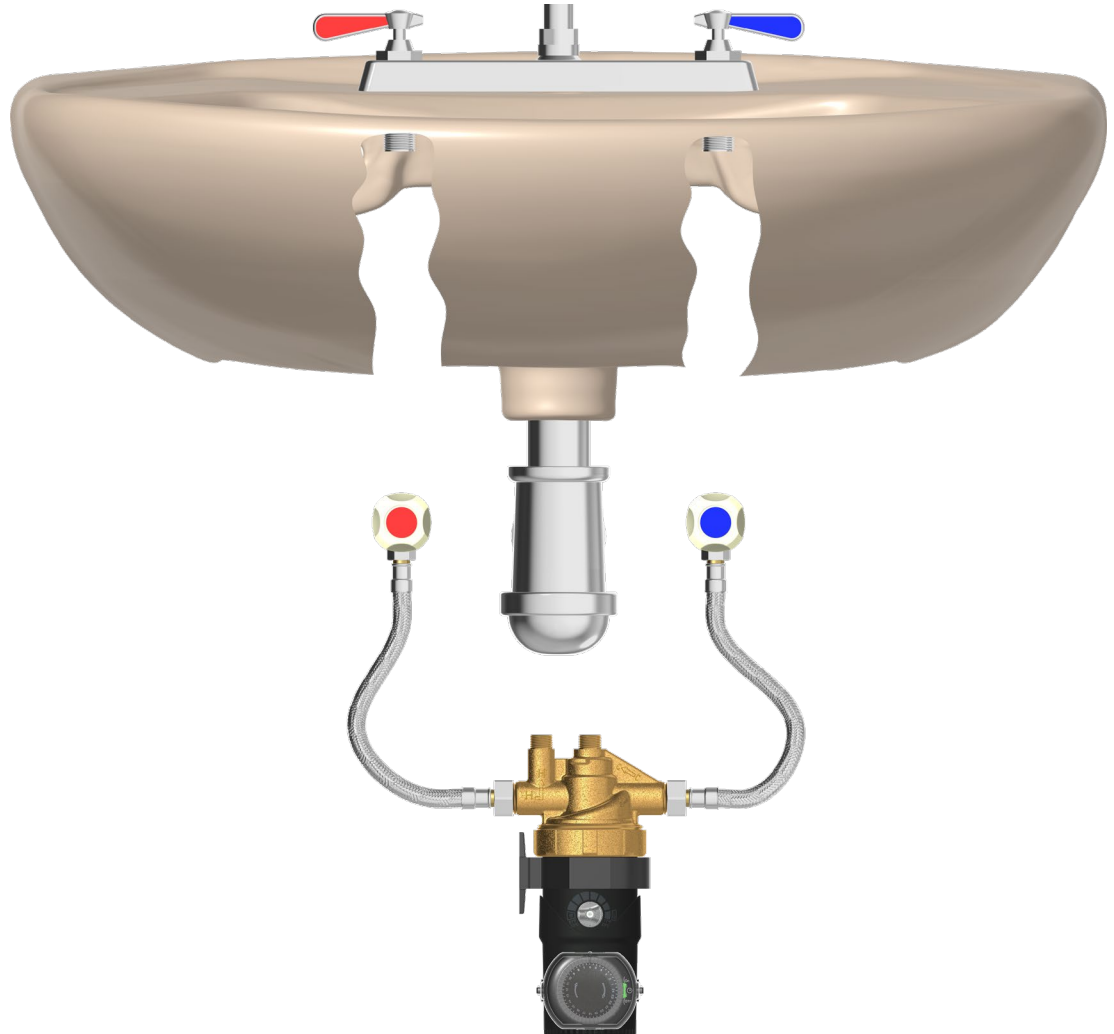

Figure 10

NOTICE:

It is recommended that the rubber washers in the hose connections be inspected to ensure they are in reusable condition. If not, they should be replaced.

5. Screw on the 9/16" end of the purchased flexible hoses to the outlet connections on the pump housing. Screw on the 1/2" end of these same two hoses to the underside of the hot and cold water faucets/taps making sure to match the hot and cold sides marked on the pump housing with the corresponding faucet/tap. Be sure the hot side connection hose is attached to the hot water faucet/tap and the cold water side connection is attached to the cold water faucet/tap (see **Figure 11** on page 25).
6. Be sure the hoses used are long enough to allow the pump to be positioned as originally planned.
7. Be sure the screw ring attaching the motor to the pump housing is securely hand tightened. Do not over tighten the screw ring, but fasten it until tight to prevent leakage.
8. Open the faucet/tap hot and cold riser shut off valves to insure there are no water leaks at any connections.
9. Plug the pump cord into the wall outlet and start up the pump system.

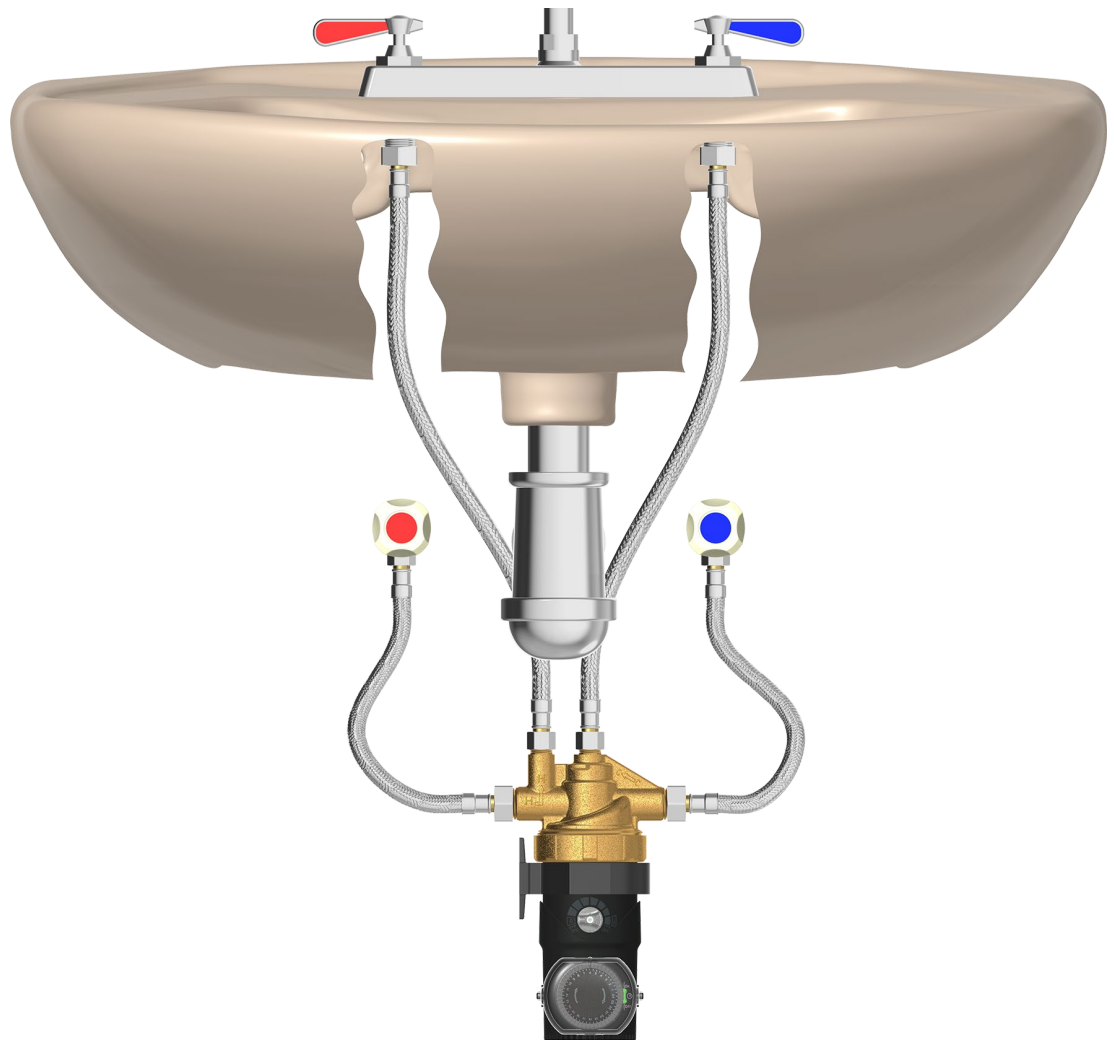

Figure 11

4.3.3 Rotation of the pump motor



WARNING: Danger, system pressurized

Before starting work, close the shut-off valves on the suction and discharge sides or drain the system.



CAUTION:

During the loosening of the screw ring from the pump housing, it is possible the leakage of residual very hot or cold liquid: pay attention to the risk of damages to persons.



CAUTION:

Be careful not to damage the internal seal: risk of leakage of very hot or cold liquid during the operation of the unit.



CAUTION:

The use of PTFE impregnated pipe compound and PTFE tape on pipe threads provides lubricity which can lead to overtightening and breakage. Do not overtighten. Failure to follow this instruction can result in moderate personal injury from hot water and/or property damage.

When installing pumps with a control knob and/or a timer in a vertical position, the pump motor may be turned in 360° stepless, so that the knob and/or the timer may be positioned in a well visible orientation (see **Figure 12** on page 26).

1. Loosen the screw ring before installation.
2. Rotate the pump motor to the required installation position.
3. Tighten the screw ring.

When installing the recirculating pump in a horizontal position, the timer shall point upwards. It may be turned in the range from 10:30 to 13:30 ($\pm 45^\circ$) at maximum, in order to maintain the ingress protection class (see **Figure 13** on page 26).

Rotating the pump motor (vertical installation)

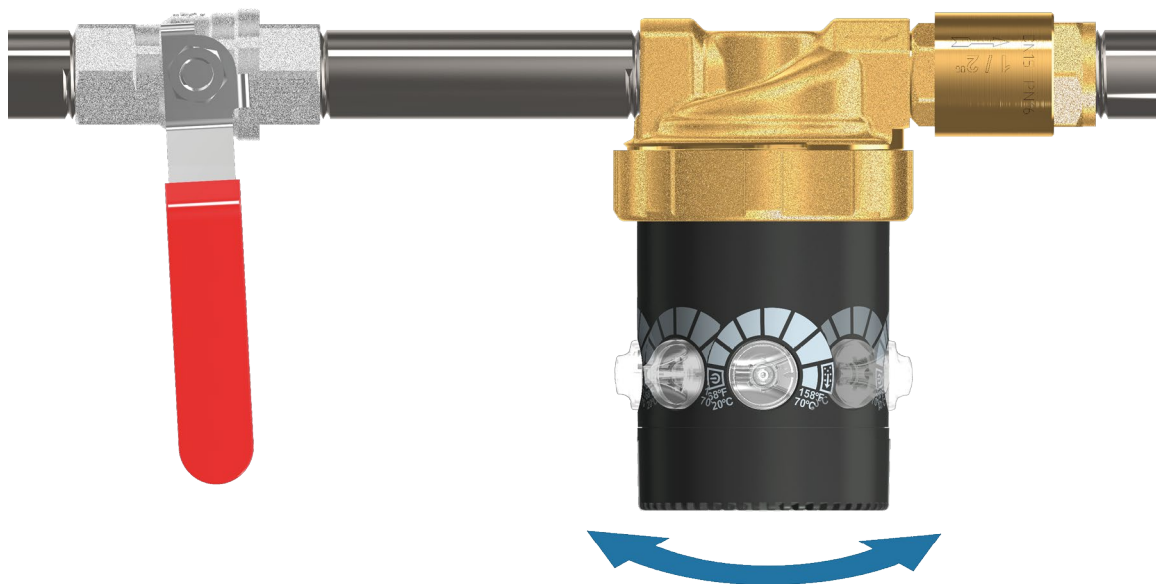

Figure 12

Rotating the pump motor (horizontal installation)

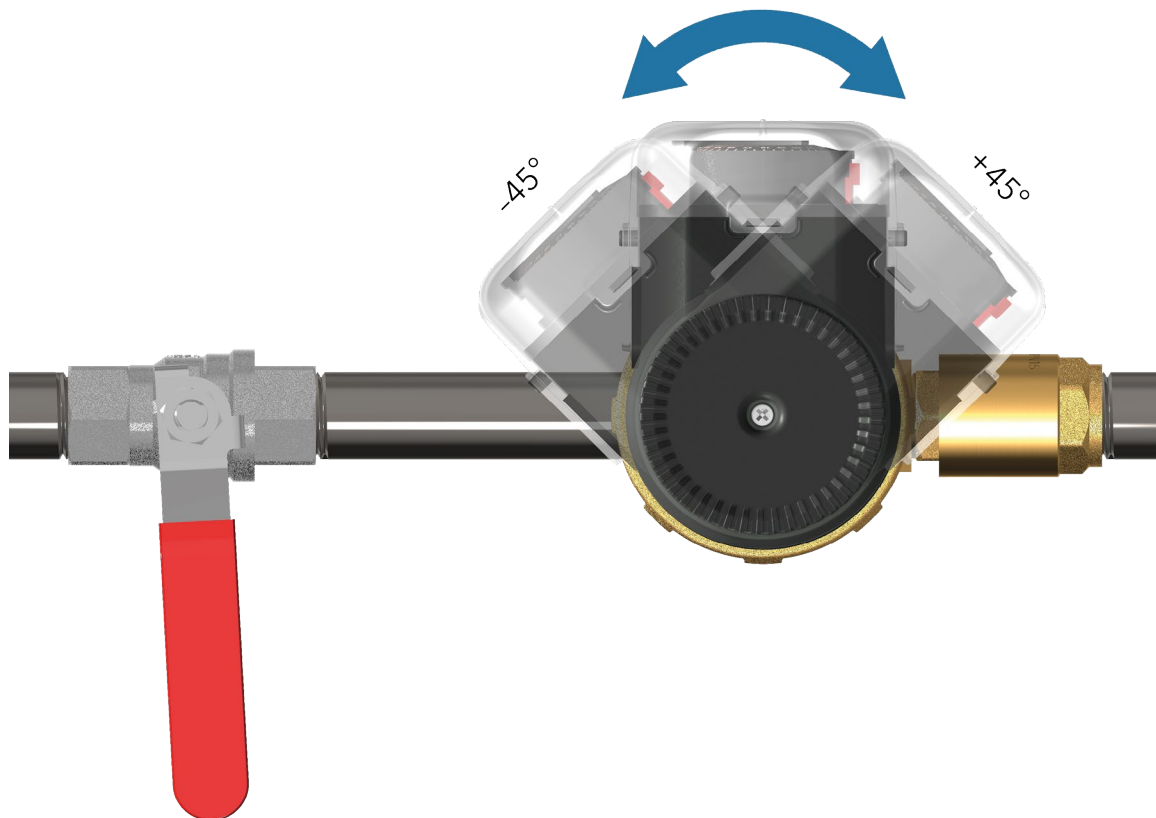

Figure 13

4.4 Electrical connection



WARNING: Risk of electric shock

Electrical connections are to be made by a qualified electrician in accordance with all applicable codes, ordinances and good practices.



DANGER: Electrical hazard

Disconnect and lock out the power before making electrical connections. Before starting work, check that the unit cannot restart, even unintentionally.



CAUTION:

For supply connection, use wires acceptable for at least 194 °F (90 °C).
Use copper conductors only.



WARNING: Risk of electric shock

Connect only to a branch circuit protected by a ground-fault circuit-interrupter (GFCI). Contact a qualified electrician if you cannot verify that the circuit is protected by a GFCI.

The unit must be connected only to a supply circuit that is protected by a ground-fault circuit-interrupter (GFCI). Such a GFCI should be provided by the installer and should be tested on a routine basis. To test the GFCI, push the test button. The GFCI should interrupt power. Push the reset button. Power should be restored. If the GFCI fails to operate in this manner, the GFCI is defective. If the GFCI interrupts power to the pump without the test button being pushed, a ground current is flowing, indicating the possibility of an electric shock. Do not use this pump. Disconnect the pump and have the problem corrected by a qualified service representative before using.

4.4.1 Ground



DANGER: Electrical hazard

Adequate electrical grounding is required for the safe operation of the pumps. Ground the pump back to the service using a copper conductor at least the size of the circuit connectors supplying the pump. Connect the ground wire to the ground terminal in the wiring compartment.



DANGER: Electrical hazard

Always connect the external protection conductor (ground) to the ground terminal before attempting to make any other electrical connections.



DANGER: Electrical hazard

Connect the pump unit and any electric accessories to a socket with protection conductor (ground).



DANGER: Electrical hazard

Check that the external protection conductor (ground) is longer than the phase conductors. In case of accidental disconnection of the unit from the phase conductors, the protection conductor must be the last one to detach itself from the terminal.





DANGER: Electrical hazard

Install suitable systems for protection against indirect contact, in order to prevent lethal electric shocks.

4.4.2 Guidelines for electrical connection

- Check that the mains voltage and frequency match the specifications on the data plate.
- Protect the supply cord from high temperatures, vibrations, collisions and abrasions.
- Check that the power supply line is provided with a short circuit protection device of appropriate size.
- If the pump unit is supplied with a power cord with grounding-type attachment plug, connect it only to a properly grounded, grounding-type receptacle.
- Do not use an extension cord.
- If the pump unit is supplied without a power cord, use only a (UL) certified, SJTW type, PVC insulated and sheathed, hard service flexible cord with copper conductors, with a cross section of 18 AWG. Follow the next connection steps.

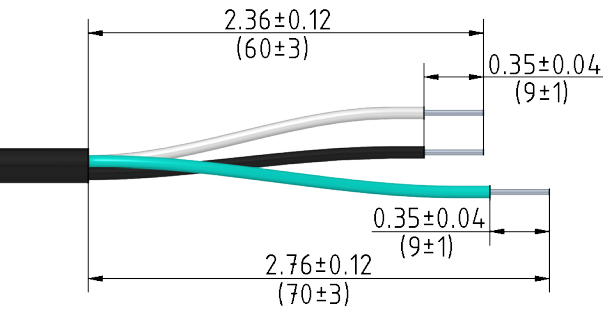
Power cord connection

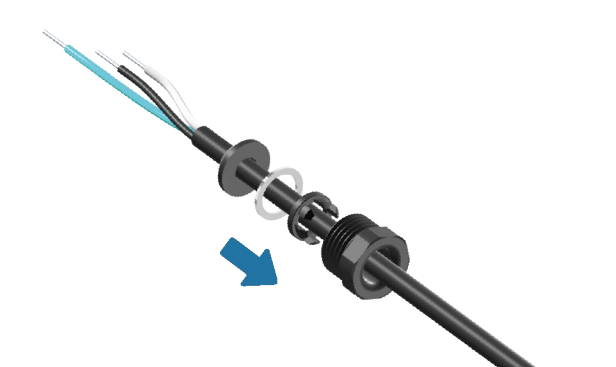
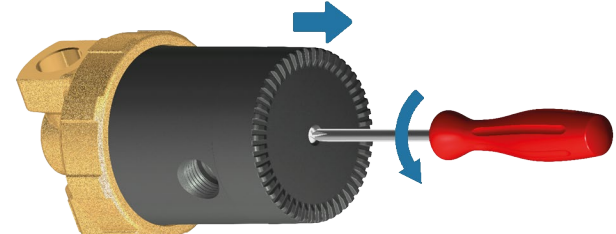
<p>1. Prepare the power cord:</p> <ul style="list-style-type: none"> • Strip the wires according to the next dimensions in inch (and in mm). • Coat the stripped copper cores with lead free solder or apply end splices of a proper size. 	
<p>2. Unscrew the cable gland components from the motor housing.</p>	
<p>3. Install the cable gland components onto the prepared cable. Take care of the proper order and orientation.</p>	
<p>4. Remove the screw that holds the end cap to the motor housing, and remove the end cap.</p>	

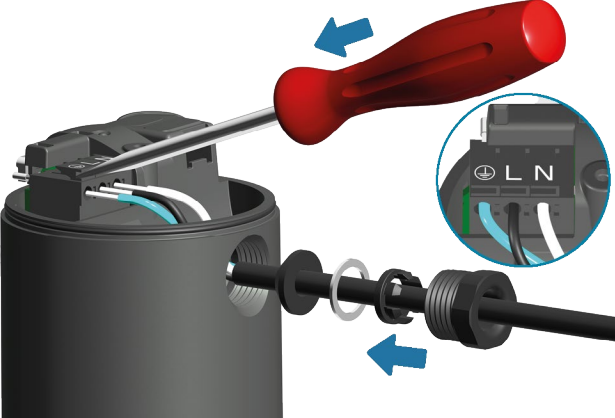
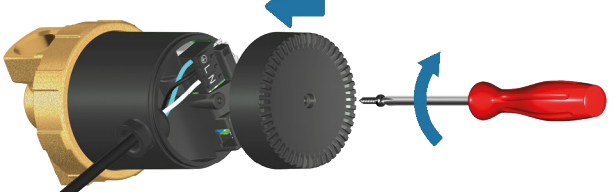
<p>5. Cable installation:</p> <ul style="list-style-type: none"> • Insert the cable through the threaded hole into the motor housing. • Push the lever of the terminal block with a flat screw driver and get each stripped core into the proper hole. • Take care of matching the markings of the terminal block with the proper cable colors. • The whole stripped conductor length must be inside of the terminal block. • Insert the cable gland components into the housing and tighten the nut. 	
<p>6. Final assembly:</p> <ul style="list-style-type: none"> • Put the end cap back to the motor housing. • Take care of its orientation, only one angular position is correct. • Tighten the screw (~5.3 lb-in / 0.6 Nm). 	



DANGER: Electrical hazard

Be certain that all connections are secure and the conduit box cover is closed before electrical power is connected.



DANGER: Electrical hazard

Pumps, that do not equipped with standard power supply plug, may only be connected to the electrical system in a separate protective box. For identification, check the 8th character of the technical code (counting after the prefix "E5-") of the product (see item 10 on **Figure 1** on page 12), codes C, S, and X are affected.

NOTICE:

Before the electrical connection is energized, the pump unit must be filled with water; if not, the bearings will be destroyed by dry operation.

4.4.3 Guidelines for timer connection

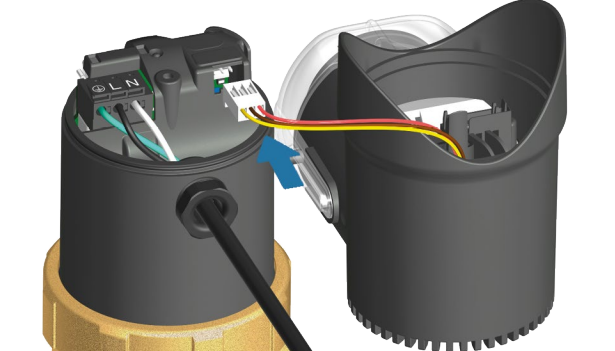
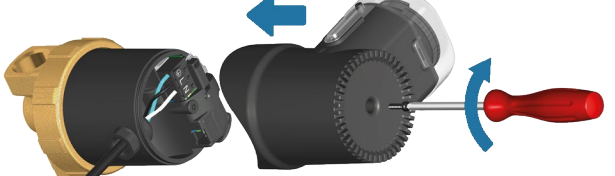
<p>1. Follow the steps 1. to 5. of section 4.4.2</p>	
<p>2. Connect the 3-pin connector of the timer into the proper opening of the motor housing.</p>	
<p>3. Final assembly:</p> <ul style="list-style-type: none"> • Put the timer to the motor housing. • Take care of its orientation, only one angular position is correct. • Tighten the screw (~5.3 lb-in / 0.6 Nm). 	

5 Use and Operation

5.1 Precautions



WARNING

Make sure that the discharged liquid cannot cause damage to persons or things.



WARNING: Electrical hazard

Check that the unit is properly connected to the mains power supply.



WARNING: Hot surface hazard

Motor housing may be very hot. Burn hazard. Do not touch.

NOTICE:

Dry run of the unit is prohibited, as this can destroy the bearings in a very short time.

NOTICE:

It is prohibited to operate the unit with the shut-off valve closed.

5.2 Before starting

Before ever starting the pump, verify that:

- The instructions in section **4 Installation** on page **17** have been performed.
- The system has been flushed thoroughly to prevent foreign objects and impurities from blocking the pump.
- The system has been filled and air purged (see section **5.4 Air purge** on page **31**).

5.3 First starting

1. Connect the plug to the mains.
 - In case of models with timer, check that the green slider is in "On" position (see point **4** on page **32**).
 - In case of models without control knob, the pump starts to operate immediately.
 - In case of models with control knob the unit stays idle (Standby mode) or starts to operate depending on the position of the knob (see **Figure 14** for the different scale layouts).



Figure 14

2. With the unit in operation, check that:
 - No liquid is leaking from the pipes.
 - There is no unwanted noise or vibrations.
 - Liquid is actually being pumped.

5.4 Air purge

After filling the system with liquid, any residual air shall be removed from the pump housing. To aid this effort, the standard pump models with control knob are equipped with a built-in air purge function.

For activation, turn the knob to the right end position for 5 seconds (the air purge symbol is shown on the scale, see **Figure 15**). A 10 minute long air purging sequence starts, which includes several max and min speed sequences, stoppages. It is indicated with the knob flashing green. You may set the knob to the desired speed level during the air purge sequence. After the sequence is finished, the pump will continue to operate in the preset speed level.

You can interrupt the air purge sequence via turning the knob under its halfway position and turning it back to the end position again. Or simply switch off and then on the mains power. Audible flow noises indicate if there is still air in the pump. In this case repeat the air purging.

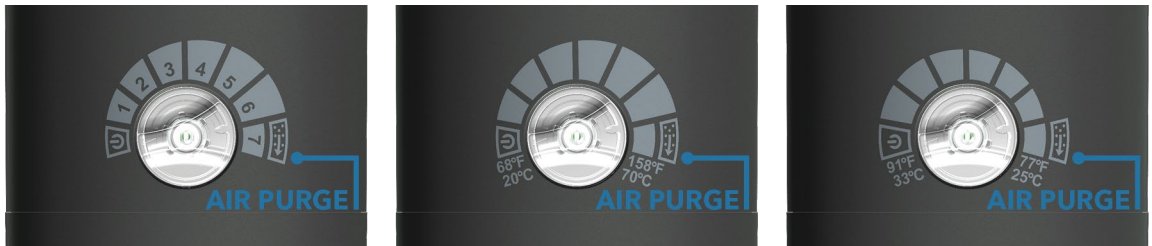

Figure 15

5.5 Setting the timer

To increase the overall efficiency of a hot water recirculating system, some pump models are equipped with a plug-in timer unit (it is also available as an installation kit for retrofitting; for ordering, contact your local distributor). The timer control is programmable to turn the circulator on and off automatically at preset times. This allows domestic hot water to be circulated only at the expected times of high usage.

NOTICE:

The timer mechanism allows turning the setting dial only in clockwise direction (as indicated by the arrows as well). Do not force it counterclockwise, it may damage the unit.

Timer programming

<p>1. Using a small flat-head screwdriver, pry the timer cover open and fold it under the unit.</p>	
<p>2. Set the current time by turning the setting dial in the direction of the arrows, until the actual time is aligned with the pointer above the dial face. The illustration shows the correct setting in case the actual time is 6 a.m. The scaling is for a whole 24 hours in a graduation of 30 minutes. The ratchet mechanism allows turning the dial only in clockwise direction, do not force it counterclockwise. One "click" represents approx. 5 minutes.</p>	

<p>3. Program the on/off times by pulling the tabs outward until flushing with the dial face for the pump to operate on during selected time periods. Push the tabs inward, one step behind the dial face for the pump to remain off during the selected time periods. Each timer tab covers a 30-minute period. The illustration shows a setting, where the pump is to be in operation between 4 a.m. and 2 p.m.</p>	
<p>4. Move the green slider to: "On" for continuous running "Off" to turn the circulator off "⌚" for running according to the program, that is selected by the tabs</p>	
<p>5. Close the timer cover in order to maintain the ingress protection class.</p>	

In the case of a power outage, the timer must be adjusted for the correct time of day after power is restored.

Timer retrofitting

If you install the timer as retrofitting, follow the instructions of section **4.4.2 Guidelines for electrical connection** (only point 4 on page 28.) and section **4.4.3 Guidelines for timer connection** (points 2 - 3 on page 29).



DANGER:
All the hydraulic and electrical connections must be completed by a technician possessing the technical-professional requirements outlined in the current regulations.



DANGER: Electrical hazard
Disconnect and lock out the power before servicing. Before starting work, check that the unit cannot restart, even unintentionally.



DANGER: Electrical hazard
The timer has both a 115 V / 60 Hz and a 230 V / 50 Hz version. Before purchasing check it for the proper supply voltage.

NOTICE:
When purchasing a timer kit for retrofitting, take care of choosing the proper timer model. Pumps produced before 2020 (with 8 bit electronics) has a different timer connection than the ones produced starting from 2020 (with 32 bit electronics). The timers with different connectors are not interchangeable.

5.6 Operation modes

According to the chart in section **3.2 Integrated features and functions** on page 11, the different pump versions have different integrated functions, thus operation modes.

5.6.1 Fix speed models

These pumps are not equipped with a control knob; run on a constant speed if energized, until reaching the power limit, then the speed may be reduced.

Timer controlled version is available, standby and air purge functions are not available.

5.6.2 Variable speed models

These pumps are equipped with a control knob, with which the speed can be controlled stepless between a factory preset minimum and maximum value. For reference see the hydraulic curves at the dedicated speeds based on the scaling of 1-7 in section **8.7 Hydraulic curves** on page 43.

Timer controlled version is available, standby and air purge functions are standard, except some special OEM versions.

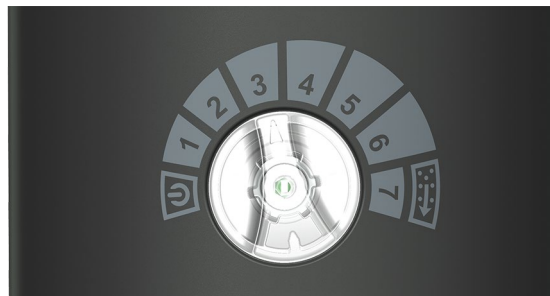

Figure 16

5.6.3 Fix speed models with fix value temperature control

These pumps are not equipped with a control knob; run on a constant speed if energized, until reaching the factory preset temperature limit; it is around 97 °F (36 °C) as default, then the pump stops and switches to standby mode. When the fluid cools back to around 91 °F (33 °C) the pump restarts.

Timer controlled version is available, standby and air purge functions are not available.

5.6.4 Fix speed models with variable value temperature control

There are two versions:

- Adjustable switch off temperature (see **Figure 17** left side view). The desired switch off temperature can be selected between 68-158 °F (20-70 °C) using the selector knob. The pump stops when it reaches the set temperature (switches to standby mode). When the fluid cools back with ~5 °F (~3 °C) below the switch off temperature, the pump restarts.
- Adjustable restart temperature (see **Figure 17** right side view). The factory preset temperature limit is around 97 °F (36 °C) as default, reaching this value the pump stops and switches to standby mode. The desired restart temperature can be selected between 91-77 °F (33-25 °C) using the selector knob. When the fluid cools back to the set temperature, the pump restarts.

Timer controlled version is available, standby and air purge functions are standard, except some special OEM versions.



Figure 17

5.6.5 Autocirc pumps

These pumps are the timer controlled versions of the fix speed models with temperature control, equipped with a special pump housing for simple under sink installation.

There are two models:

- **e³-4F/BAPQC**: Fix value temperature controlled (for operation details see section 5.6.3 on page 33).
- **e³-4F/BAPRC**: Variable value temperature controlled with adjustable restart temperature (see the second paragraph of section 5.6.4 on page 33).

Depending on the set position of the timer's green slider (see point 4 of section 5.5 **Setting the timer** on page 32), the pump operation can be controlled either by both the temperature sensor and the timer (slider is in "⌚" position), or only by the temperature sensor (slider is in "On" position).

The timer mode will provide the most cost effective method of operation and can be programmed to run only during the time periods when hot water is most frequently required. Even during timer controlled operation, the Autocirc will only turn on when the built-in temperature sensor senses that additional hot water is required at the point of installation.

NOTICE:

The Autocirc will most likely start running immediately and turn off after a few minutes once hot water reaches the faucet. It will then continue cycling on and off, as required during the programmed sequence of operation. Do not be concerned if the pump does not begin running immediately after the pump is plugged in. This just means that there is already hot water at the hot water faucet and the pump will turn on automatically when the hot water line cools down.

5.6.6 LED light

The standard pump models with control knob, have a green operation light integrated in the knob. It indicates the main operating modes and the error codes as well, if any is present. This function may be switched off in some special OEM versions.

Mode indications:

Operating mode	LED light status
Normal operation, the pump is running	Continuous on
Air purge sequence is active	Blinking 200 ms on - 200 ms off - 200 ms on...
Standby mode	Blinking 50 ms on - 1.5 s off - 50 ms on...

For error codes see section 7.2 **Error signals** on page 38.

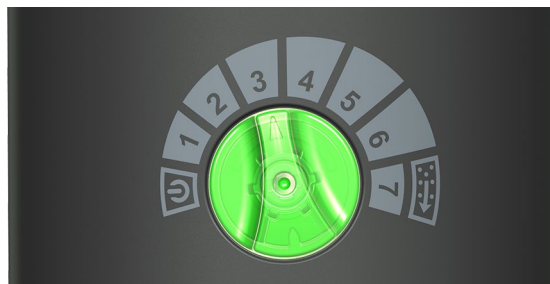

Figure 18

5.6.7 Motor protection from overtemperature

In order to protect the electronics inside the pumps from temperatures that are dangerously high, the pump is equipped with an internal temperature sensor and a self-protecting algorithm. The temperature is measured directly at the electronics. When the temperature of the electronics is between 221 and 239 °F (105 and 115 °C), the pump power is continuously lowered to minimum power and thus the flow of water is also decreasing. If despite the power regulation the temperature still rises and reaches around 257 °F (125 °C), the pump stops completely. Once the electronics have cooled down again to around 239 °F (115 °C) the pump automatically restarts.

5.6.8 Dry run protection

This function is available only for some fix speed models. This algorithm protects the unit from dry running during normal operation.

The pump monitors the input power level and if it drops below a preset value for a specified time interval, the pump starts a sequence with 9 cycles of 30 s on and 60 s off, then a 10-minute pause and so on, until the expected power level restored and the pump can continue the normal operation.

5.6.9 Power Down Reset (PDR)

This function is available only for some fix speed models. This algorithm protects the unit from dry running during normal operation.

This algorithm is a special version of the dry run protection.

If the expected power level cannot be restored in 3 x 9 cycles, described in the section **5.6.8 Dry run protection**, the pump stops and restarts only after the termination of the power supply.

5.6.10 Temperature sensor error mode

This function is available only for some temperature controlled models. It is activated if the signal from the water temperature sensor is interrupted. In this case the pump runs in a kind of emergency mode with repeating the operation cycle of 1 minute running - 1 minute standby mode. In this situation the pump will not react on the control knob settings anymore, the operation can only be stopped by disconnecting the power supply.

6 Maintenance

6.1 Precautions

Before starting, make sure that the instructions shown in section 1 **Introduction and Safety** on page 4 have been fully read and understood.



DANGER: Electrical hazard

The unit must not be used if the cable or the electrical compartment is damaged. Damaged cable may only be replaced (so that danger is avoided) by the manufacturer, its service agent or a trained professional electrician.



WARNING:

Maintenance must be done by a technician possessing the technical-professional requirements outlined in the current regulations.



DANGER: Electrical hazard

Disconnect and lock out the power before servicing. Before starting work, check that the unit cannot restart, even unintentionally.



WARNING:

Always wear personal protective equipment.



WARNING:

Always use suitable working tools.



WARNING: Hot water hazard

Before draining the system, allow water to cool to at least 100 °F (38 °C), open the drain valve (take precautions against water damage) and leave the drain valve open until servicing is complete.



WARNING: High Pressure Hazard

Pressure may be present in the pump body. This pressure can be relieved by loosening the pipe connections and shifting the pump unit slightly to allow the pressurized water to escape.

6.2 Maintenance

- Check the integrity of the supply cord every 6 months of operation; if the cable is damaged contact Xylem or the Authorized Distributor for its replacement. Do not use the unit with damaged cord.
- Carefully clean the unit from outside.
- Do not attempt to lubricate the pump. The pump is self-lubricating.
- Prevent the pump from running dry.
- Flush the system of any debris and re-purge all air from the system in the event of any water supply interruptions in the plumbing line.
- Prevent heavy scale build-up by keeping the hot water temperature 140 °F (60 °C) or less.
- Don't over salt your water conditioner.

6.3 Autocirc pumps

If you are away from home for extended periods of time (2 weeks or more) you may choose to turn the system off (slide the timer switch to the "Off" position) as there is no need to maintain hot water in the supply line when no one is home to enjoy this convenience. When returning home, prior to turning on the system, we recommend that you turn on the hot and cold faucets/taps at the sink where the Autocirc system is installed until all air is purged from the dormant system and the water flows smoothly from the faucets/taps. Then slide the timer switch back to either the "On" or "☺" position.

6.4 Disassembly

Pumps are subject to wear. If the pump is blocked or grinding noises are audible, check the pump and replace it if necessary.

Procedure:

- Disconnect the electrical supply lines to the pump.
- Close the valves on the suction and discharge sides of the pump (if no valves have been installed, it may be necessary to drain the system).
- Loosen the screw ring and remove the motor. Residual water may leak out of the rotor cavity. Prevent the electrical connection to the pump from getting wet.
- Check for any foreign object in the rotor cavity, if you find any, remove it.
- If necessary remove the rotor from the stator (check **Figure 3** on page **13** for reference), by grasping the impeller blades and gently pulling straight up. Do not pull up on one side only or push the rotor sideways.
- Check for wear marks on the rotor cavity and magnet surface. If there are many, the pump has worn off and shall be replaced.
- If no issues are found, the rotor can be re-installed into the stator. Do not let the rotor drop to the ceramic bearing, but lower it slowly, then spin the rotor with your fingers to ensure that it turns freely.
- For reconnection/new pump installation follow the installation rules.

7 Troubleshooting

7.1 Precautions



WARNING:

Maintenance must be done by a technician possessing the technical-professional requirements outlined in the current regulations.



WARNING:

Observe the safety requirements in section **5 Use and Operation** on page **30** and section **6 Maintenance** on page **36**.



WARNING:

If a fault cannot be corrected or is not mentioned, contact Xylem or the Authorized Distributor.

7.2 Error signals

The pump is equipped with self-diagnostics and malfunction detection. Defects detected by the pump system are signaled to the user with alternating short and long LED light flashes. This function may be switched off in some special OEM versions.

Operating mode / Error code	LED light status
Normal operation, the pump is running	Continuous on
Air purge sequence is active	Blinking 200 ms on - 200 ms off - 200 ms on...
Standby mode	Blinking 50 ms on - 1.5 s off - 50 ms on...
Low voltage failure	Blinking 1 x short - 1 x long...
Overtemperature failure	Blinking 3 x short - 1 x long...
Speed feedback failure	Blinking 4 x short - 1 x long...
Blocked rotor	Blinking 5 x short - 1 x long...

7.3 Pump not running

Cause	Remedy
Not connected or connected incorrectly	Connect correctly
The pump is in standby mode	Turn the control knob into the operation range, see section 5.3 First starting on page 30
The slider of the timer is set in "Off" position	Set it to "⌚" or "On" position, see point 4 of section 5.5 Setting the timer on page 32
Pump too hot, dry operation- or overheating protection active	Allow to cool, pump restarts automatically
Pump blocked	See section 6.4 Disassembly on page 37

7.4 Pump running for 1 minute periods only (temperature controlled models only)

Cause	Remedy
Water temperature signal is interrupted	Replace pump

7.5 Noise in the system

The pump should be virtually noiseless during operation. The rotor may make a brief but hardly perceptible fluttering noise immediately after the pump is turned off. During normal operation, an occasional air bubble may pass through the pump housing causing a momentary gurgling noise. However, if noise at the pump persists for any prolonged period, correct the problem.

Cause	Remedy
Check valve installed on the inlet side of the pump or in wrong direction	Check and correct the installation
Inlet side shut-off valve closed or clogged	Check and open or clean the valve
Not thoroughly air purged	See section 5.4 Air purge on page 31 , if this function is not available or not efficient, open the hose bib for manual venting
	In case of an Autocirc pump, turn it off and turn the hot and cold faucets/taps on, to be sure all air is purged from the system
Foreign objects in pump	See section 6.4 Disassembly on page 37
Worn bearing causing the rotor to wobble during operation	Replace pump
If the return line connects to the cold water supply at the top of water heater, the warm water may be creating back pressure in the cold supply line	Add a check valve on the cold supply line above the return line tee connector
If the noise occurs when an Autocirc pump turns off it is likely to be "water hammer" that results from the closure of the built-in valve.	Water hammer arresters may be installed on the hot and cold lines

7.6 Water taking too long to get to faucet/tap

The faucet/tap involved may be on a branch line off the main hot water supply line in which case there may be a slightly longer wait for hot water to arrive than at faucet/tap directly off the main supply line.

Cause	Remedy
Hot water supply from the water heater exhausted	Check the water heater
Check valve installed backwards	Check and correct the installation
Pump not running	See section 7.3 on page 38
The timer is not operating properly.	Replace the timer

7.7 Signs of dry run

Dry run results from inadequate water supply to the pump, which prevents lubrication of the bearing ball. It may be caused by operating the pump without water in the plumbing lines, which may occur with frozen pipes, or by failing to turn the pump off when the system is drained for servicing. It can also occur as the result of large air bubbles collecting in the pump housing and preventing the flow of water over the bearing ball. If the problem is air in the system, check that the air vent is functioning, that the system is properly purged of air and that the pump and various system components are installed.

8 Technical Information

8.1 Certifications

The pump models covered by this manual are certified generally under the safety standard UL 778, but in case of some special OEM models (usually with plastic pump housing for spa application) the UL 1081 certification is also available. This reference is indicated on the data plate, see item 1 in **Figure 1** on page 12.

These pumps are also certified as a Drinking Water System Component according to NSF/ANSI 61.

8.2 Operating environment

Non-aggressive, non-explosive and frost-free atmosphere

Ambient temperature

Must be between 32 - 122 °F (0 - 50 °C)

Relative humidity of the air

Maximum 95 % at 122 °F (50 °C)

NOTICE:

In the event, that temperature and humidity exceed the indicated limits, contact Xylem or the Authorized Distributor.

NOTICE:

To avoid condensation in the stator or in the electronics, the liquid temperature must be higher than the ambient temperature.

8.3 Pumped liquid



CAUTION:

This pump has been designed and tested for use with water only. Its suitability for use with liquids other than water is the end user's responsibility.

For use with alternative circulating fluids (e.g. in special OEM applications) contact Xylem or the Authorized Distributor.

Allowed liquid temperature range:

UL 778 certified models (safety aspect only):	41 - 203 °F (5 - 95 °C)
UL 1081 certified models (safety aspect only):	41 - 185 °F (5 - 85 °C)
NSF/ANSI 61 (in case of circulating drinking water):	41 - 140 °F (5 - 60 °C)

8.4 Electrical characteristics

Supply voltage

Without timer: 1~ 100 - 240 V ± 10 %; 50/60 Hz; PE
 With timer: 1~ 115 V ± 10 %; 60 Hz; PE

Power consumption

10 W (e³-4F/BA___ series models)
 12 W (e³-4F/_____ series models)
 27 W (e³-6F/_____ series models)
 3 - 12 W (e³-4V/_____ series models)
 3 - 27 W (e³-6V/_____ series models)
 For special OEM applications the maximum value is 40 W.

Insulation class

Class 155 (F)

8.5 Mechanical characteristics

Ingress protection class

Without timer: IP 44

With timer: IP 42

Maximum working pressure

UL 778 certified models: 145 psi (1.0 MPa)

UL 1081 certified models: 29 psi (0.2 MPa)

Sound pressure level

≤ 40 dB(A)

8.6 Dimensions and weights

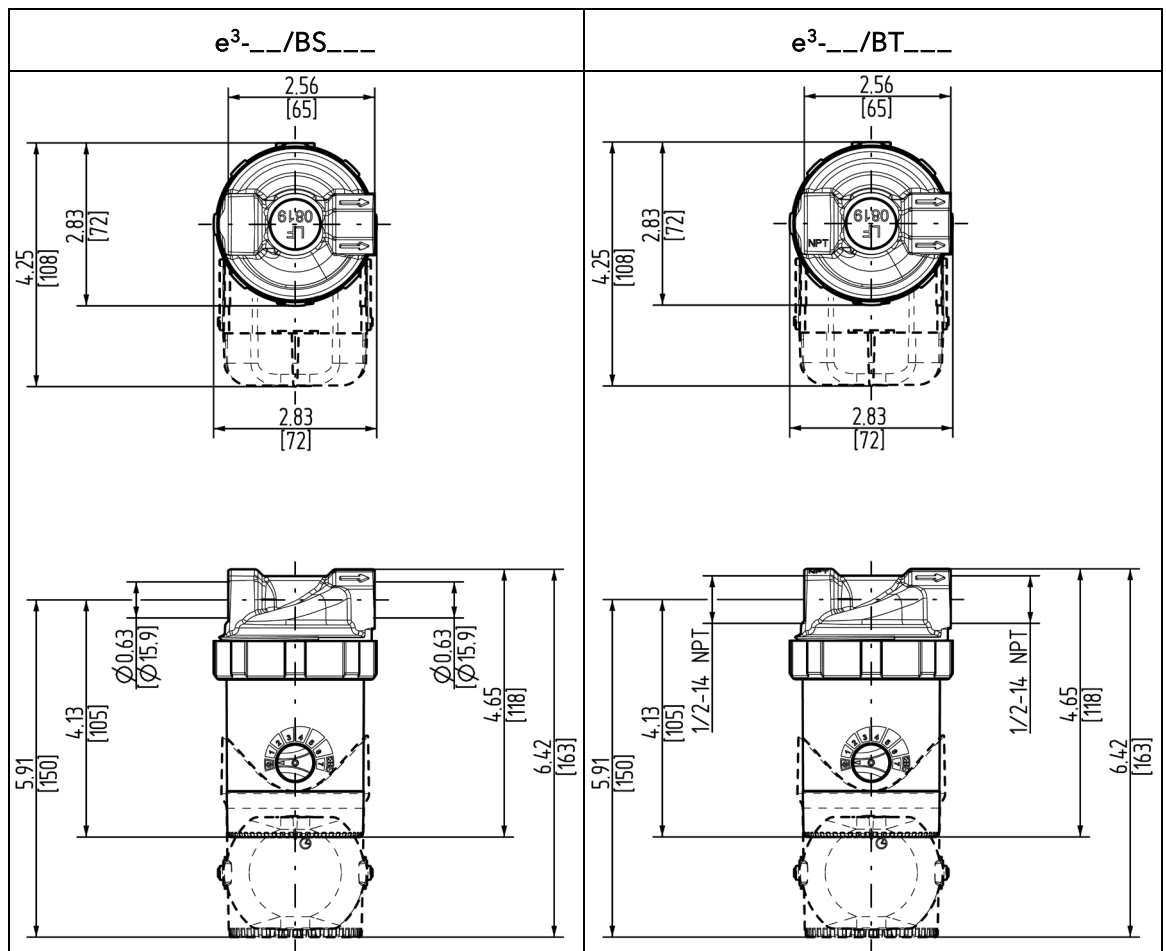

Models				Weight [lb (kg)]
e ³ -_V/BSPYZ-01	e ³ -_F/BSPQZ-01	e ³ -_F/BSPRZ-01	e ³ -_F/BSPYZ-01	2.2 (1.0)
e ³ -_V/BSXYZ-01	e ³ -_F/BSXQZ-01	e ³ -_F/BSXRZ-01	e ³ -_F/BSXYZ-01	1.8 (0.8)
e ³ -_V/BSPYC-01	e ³ -_F/BSPQC-01	e ³ -_F/BSPRC-01	e ³ -_F/BSPYC-01	2.4 (1.1)
e ³ -_V/BSXYC-01	e ³ -_F/BSXQC-01	e ³ -_F/BSXRC-01	e ³ -_F/BSXYC-01	2.0 (0.9)
e ³ -_V/BTPYZ-01	e ³ -_F/BTPQZ-01	e ³ -_F/BTPRZ-01	e ³ -_F/BTPYZ-01	2.2 (1.0)
e ³ -_V/BTXYZ-01	e ³ -_F/BTXQZ-01	e ³ -_F/BTXRZ-01	e ³ -_F/BTXYZ-01	1.8 (0.8)
e ³ -_V/BTPYC-01	e ³ -_F/BTPQC-01	e ³ -_F/BTPRC-01	e ³ -_F/BTPYC-01	2.4 (1.1)
e ³ -_V/BTXYC-01	e ³ -_F/BTXQC-01	e ³ -_F/BTXRC-01	e ³ -_F/BTXYC-01	2.0 (0.9)

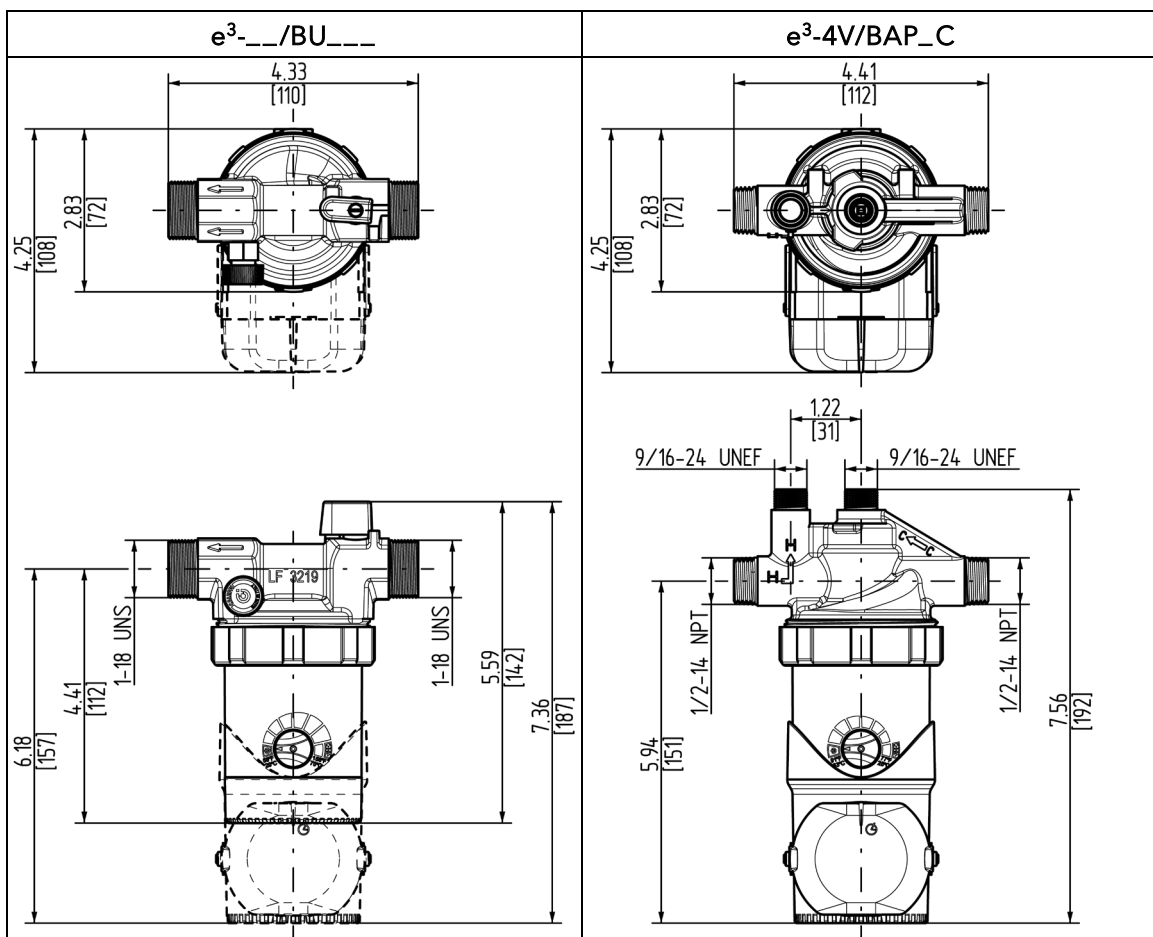

Models				Weight [lb (kg)]
e³-_V/BUPYZ-01	e³-_F/BUQZ-01	e³-_F/BU PRZ-01	e³-_F/BUPYZ-01	2.6 (1.2)
e³-_V/BUXYZ-01	e³-_F/BUXQZ-01	e³-_F/BUXRZ-01	e³-_F/BUXYZ-01	2.2 (1.0)
e³-_V/BUPYC-01	e³-_F/BUQC-01	e³-_F/BU PRC-01	e³-_F/BUPYC-01	2.9 (1.3)
e³-_V/BUXVC-01	e³-_F/BUXQC-01	e³-_F/BUXRC-01	e³-_F/BUXVC-01	2.4 (1.1)
-	e³-_F/BAQC-01	e³-_F/BA PRC-01	-	2.9 (1.3)

8.7 Hydraulic curves

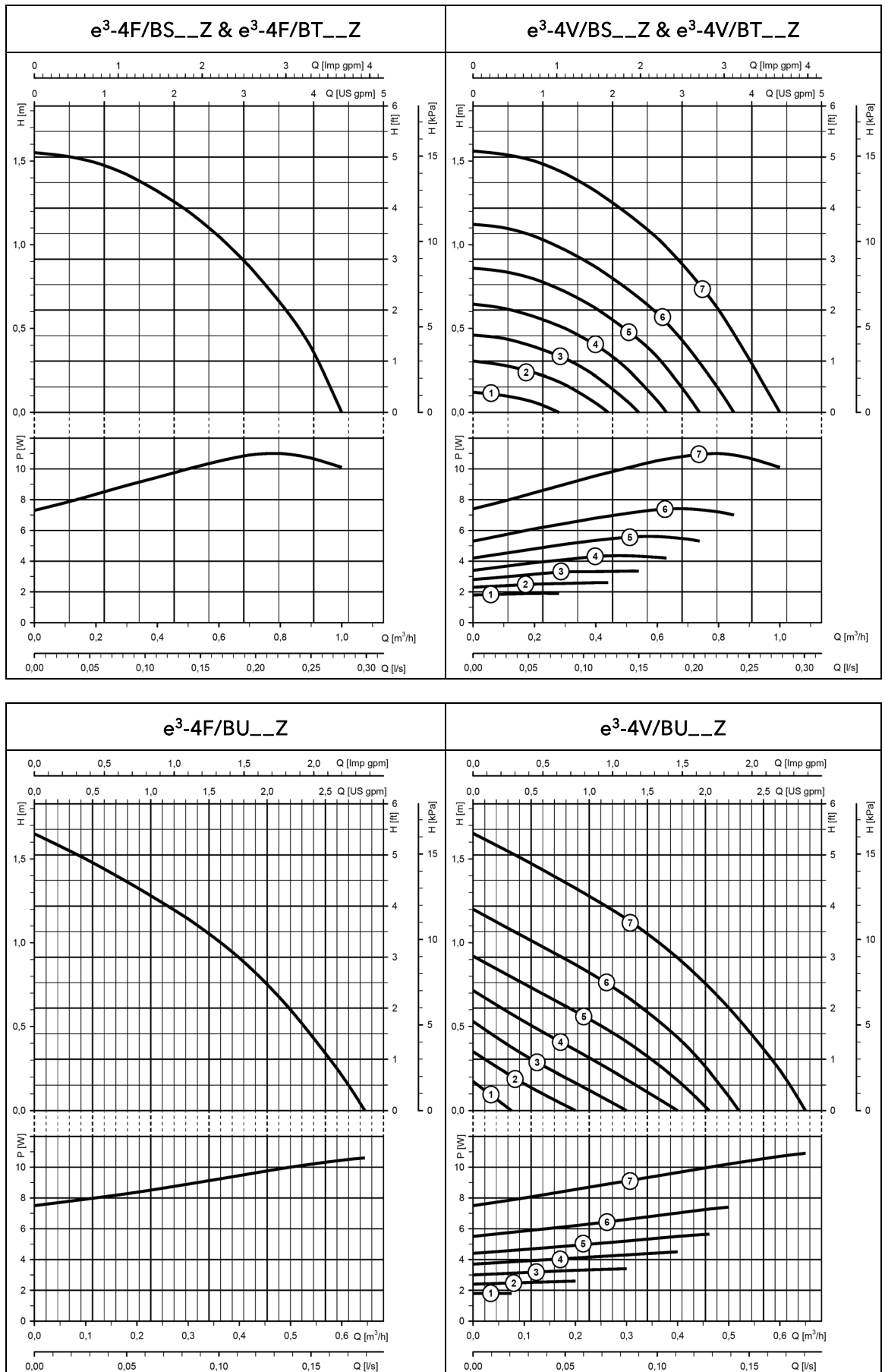

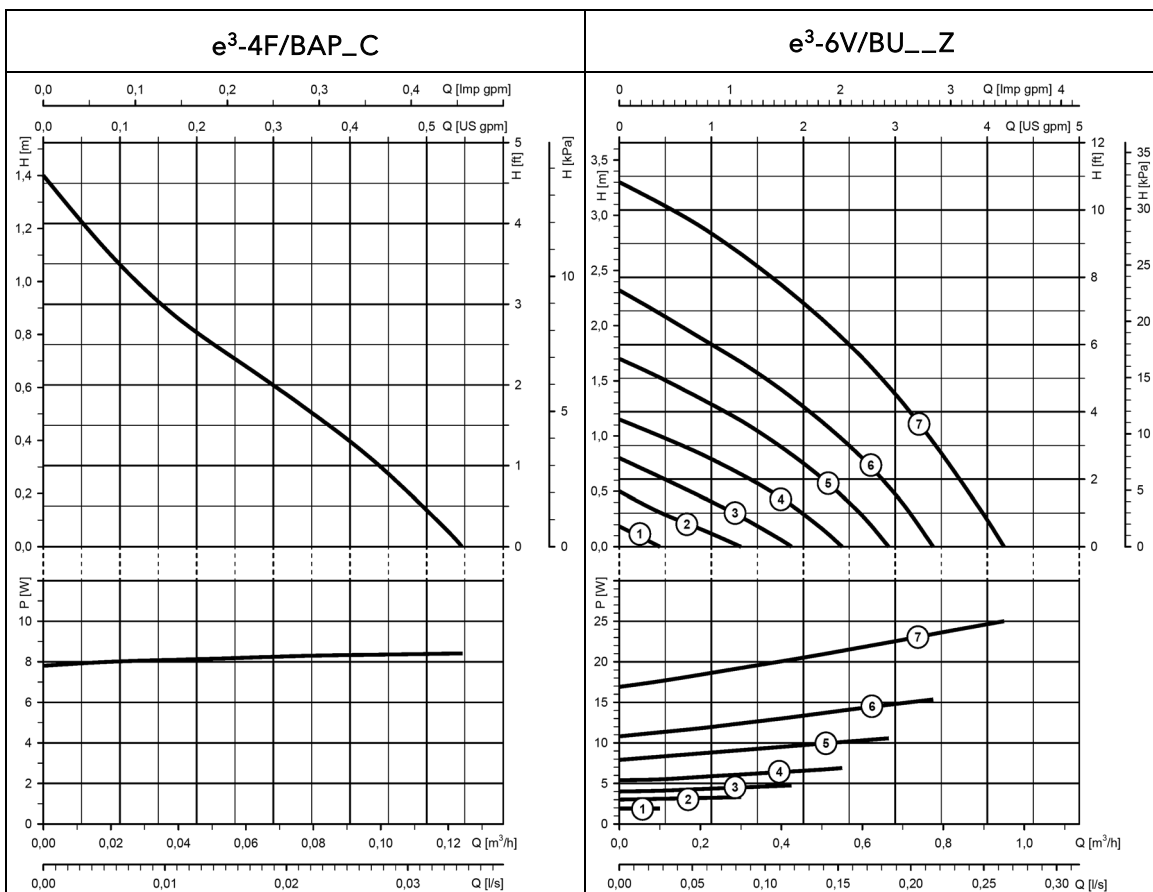
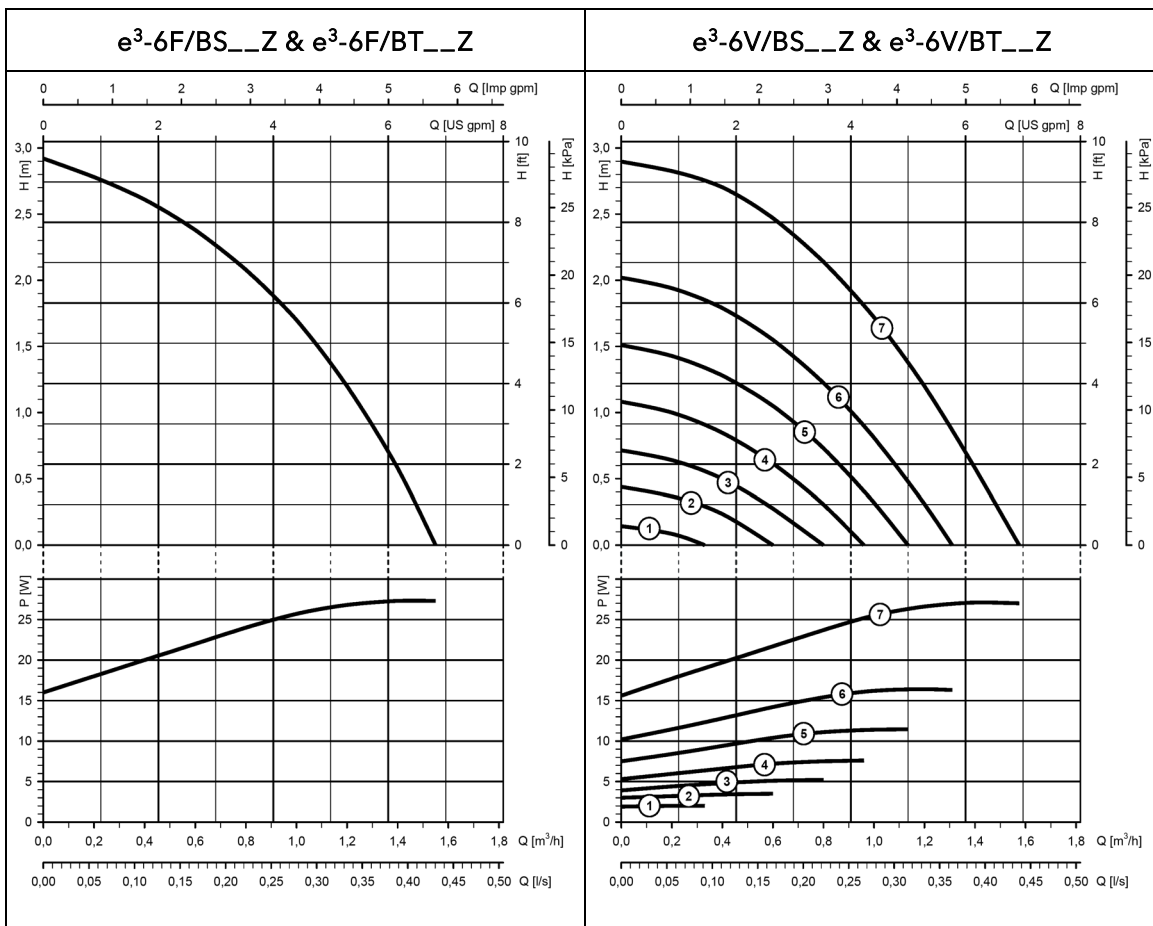

8.8 OEM models

For special OEM (Original Equipment Manufacturer) applications the pump has customized versions, which differ from the standard trade versions in some features. An individual PSS (Product Specification Sheet) document is issued for each of these versions including the hydraulic curve and the technical details highlighting the difference from the standard versions.

9 Disposal

9.1 Precautions



WARNING:

The unit must be disposed of through approved companies specialized in the identification of different types of materials (steel, copper, plastic, etc.).



WARNING:

It is prohibited to dispose of lubricating fluids and other hazardous substances in the environment.

Recycling guidelines

Always follow local laws and regulations regarding recycling.

10 Warranty

Commercial warranty

For goods sold to commercial buyers, Seller warrants the goods sold to Buyer hereunder (with the exception of membranes, seals, gaskets, elastomer materials, coatings and other "wear parts" or consumables all of which are not warranted except as otherwise provided in the quotation or sales form) will be (i) be built in accordance with the specifications referred to in the quotation or sales form, if such specifications are expressly made a part of this Agreement, and (ii) free from defects in material and workmanship for a period of twelve (12) from the date of installation or twenty-four (24) months from the date of shipment (which date of shipment shall not be greater than after receipt of notice that the goods are ready to ship), whichever shall occur first, unless a longer period is specified in the product documentation.

Except as otherwise required by law, Seller shall, at its option and at no cost to Buyer, either repair or replace any product which fails to conform with the Warranty provided Buyer gives written notice to Seller of any defects in material or workmanship within ten (10) days of the date when any defects or nonconformance are first manifest. Under either repair or replacement option, Seller shall not be obligated to remove or pay for the removal of the defective product or install or pay for the installation of the replaced or repaired product and Buyer shall be responsible for all other costs, including, but not limited to, service costs, shipping fees and expenses. Seller shall have sole discretion as to the method or means of repair or replacement. Buyer's failure to comply with Seller's repair or replacement directions shall terminate Seller's obligations under this Warranty and render the Warranty void. Any parts repaired or replaced under the Warranty are warranted only for the balance of the warranty period on the parts that were repaired or replaced.

Seller shall have no warranty obligations to Buyer with respect to any product or parts of a product that have been: (a) repaired by third parties other than Seller or without Seller's written approval; (b) subject to misuse, misapplication, neglect, alteration, accident, or physical damage; (c) used in a manner contrary to Seller's instructions for installation, operation and maintenance; (d) damaged from ordinary wear and tear, corrosion, or chemical attack; (e) damaged due to abnormal conditions, vibration, failure to properly prime, or operation without flow; (f) damaged due to a defective power supply or improper electrical protection; or (g) damaged resulting from the use of accessory equipment not sold or approved by Seller. In any case of products not manufactured by Seller, there is no warranty from Seller; however, Seller will extend to Buyer any warranty received from Seller's supplier of such products.

THE FOREGOING WARRANTY IS EXCLUSIVE AND IN LIEU OF ANY AND ALL OTHER EXPRESS OR IMPLIED WARRANTIES, GUARANTEES, CONDITIONS OR TERMS OF WHATEVER NATURE RELATING TO THE GOODS PROVIDED HEREUNDER, INCLUDING WITHOUT LIMITATION ANY IMPLIED WARRANTIES OF MERCHANTABILITY AND FITNESS FOR A PARTICULAR PURPOSE, WHICH ARE HEREBY EXPRESSLY DISCLAIMED AND EXCLUDED. EXCEPT AS OTHERWISE REQUIRED BY LAW, BUYER'S EXCLUSIVE REMEDY AND SELLER'S AGGREGATE LIABILITY FOR BREACH OF ANY OF THE FOREGOING WARRANTIES ARE LIMITED TO REPAIRING OR REPLACING THE PRODUCT AND SHALL IN ALL CASES BE LIMITED TO THE AMOUNT PAID BY THE BUYER FOR THE DEFECTIVE PRODUCT. IN NO EVENT SHALL SELLER BE LIABLE FOR ANY OTHER FORM OF DAMAGES, WHETHER DIRECT, INDIRECT, LIQUIDATED, INCIDENTAL, CONSEQUENTIAL, PUNITIVE, EXEMPLARY OR SPECIAL DAMAGES, INCLUDING BUT NOT LIMITED TO LOSS OF PROFIT, LOSS OF ANTICIPATED SAVINGS OR REVENUE, LOSS OF INCOME, LOSS OF BUSINESS, LOSS OF PRODUCTION, LOSS OF OPPORTUNITY OR LOSS OF REPUTATION.

Limited consumer warranty

For goods sold for personal, family or household purposes, Seller warrants the goods purchased hereunder (with the exception of membranes, seals, gaskets, elastomer materials, coatings and other "wear parts" or consumables all of which are not warranted except as otherwise provided in the quotation or sales form) will be free from defects in material and workmanship for a period of twelve (12) from the date of installation or twenty-four (24) months from the product date code, whichever shall occur first, unless a longer period is provided by law or is specified in the product documentation.

Except as otherwise required by law, Seller shall, at its option and at no cost to Buyer, either repair or replace any product which fails to conform with the Warranty provided Buyer gives written notice to Seller of any defects in material or workmanship within ten (10) days of the date when any defects or nonconformance are first manifest. Under either repair or replacement option, Seller shall not be obligated to remove or pay for the removal of the defective product or install or pay for the installation of the replaced or repaired product and Buyer shall be responsible for all other costs, including, but not limited to, service costs, shipping fees and expenses. Seller shall have sole discretion as to the method or means of repair or replacement. Buyer's failure to comply with Seller's repair or replacement directions shall terminate Seller's obligations under this Warranty and render this Warranty void. Any parts repaired or replaced under the Warranty are warranted only for the balance of the warranty period on the parts that were repaired or replaced. The Warranty is conditioned on Buyer giving written notice to Seller of any defects in material or workmanship of warranted goods within ten (10) days of the date when any defects are first manifest.

Seller shall have no warranty obligations to Buyer with respect to any product or parts of a product that have been: (a) repaired by third parties other than Seller or without Seller's written approval; (b) subject to misuse, misapplication, neglect, alteration, accident, or physical damage; (c) used in a manner contrary to Seller's instructions for installation, operation and maintenance; (d) damaged from ordinary wear and tear, corrosion, or chemical attack; (e) damaged due to abnormal conditions, vibration, failure to properly prime, or operation without flow; (f) damaged due to a defective power supply or improper electrical protection; or (g) damaged resulting from the use of accessory equipment not sold or approved by Seller. In any case of products not manufactured by Seller, there is no warranty from Seller; however, Seller will extend to Buyer any warranty received from Seller's supplier of such products.

THE FOREGOING WARRANTY IS PROVIDED IN PLACE OF ALL OTHER EXPRESS WARRANTIES. ALL IMPLIED WARRANTIES, INCLUDING BUT NOT LIMITED TO THE IMPLIED WARRANTIES OF MERCHANTABILITY AND FITNESS FOR A PARTICULAR PURPOSE, ARE LIMITED TO TWELVE (12) MONTHS FROM THE DATE OF INSTALLATION OR TWENTY-FOUR (24) MONTHS FROM THE PRODUCT DATE CODE , WHICHEVER SHALL OCCUR FIRST. EXCEPT AS OTHERWISE REQUIRED BY LAW, BUYER'S EXCLUSIVE REMEDY AND SELLER'S AGGREGATE LIABILITY FOR BREACH OF ANY OF THE FOREGOING WARRANTIES ARE LIMITED TO REPAIRING OR REPLACING THE PRODUCT AND SHALL IN ALL CASES BE LIMITED TO THE AMOUNT PAID BY THE BUYER FOR THE DEFECTIVE PRODUCT. IN NO EVENT SHALL SELLER BE LIABLE FOR ANY OTHER FORM OF DAMAGES, WHETHER DIRECT, INDIRECT, LIQUIDATED, INCIDENTAL, CONSEQUENTIAL, PUNITIVE, EXEMPLARY OR SPECIAL DAMAGES, INCLUDING BUT NOT LIMITED TO LOSS OF PROFIT, LOSS OF ANTICIPATED SAVINGS OR REVENUE, LOSS OF INCOME, LOSS OF BUSINESS, LOSS OF PRODUCTION, LOSS OF OPPORTUNITY OR LOSS OF REPUTATION.

Some states do not allow limitations on how long an implied warranty lasts, so the above limitation may not apply to you. Some states do not allow the exclusion or limitation of incidental or consequential damages, so the above exclusions may not apply to you. This warranty gives you specific legal rights, and you may also have other rights which may vary from state to state.

To make a warranty claim, check first with the dealer from whom you purchased the product or visit www.xyleminc.com for the name and location of the nearest dealer providing warranty service.

Xylem |'zīləm|

- 1) The tissue in plants that brings water upward from the roots;
- 2) A leading global water technology company.

We're a global team unified in a common purpose: creating innovative solutions to meet our world's water needs. Developing new technologies that will improve the way water is used, conserved, and re-used in the future is central to our work. We move, treat, analyze, and return water to the environment, and we help people use water efficiently, in their homes, buildings, factories and farms. In more than 150 countries, we have strong, long-standing relationships with customers who know us for our powerful combination of leading product brands and applications expertise, backed by a legacy of innovation.

For more information on how Xylem can help you, go to www.xylem.com



Bell & Gossett
a xylem brand

Xylem Inc.
8200 N. Austin Avenue
Morton Grove, Illinois 60053
Phone: (847) 966-3700
Fax: (847) 965-8379
www.xylem.com/brands/bellgossett

Bell & Gossett is a trademark of Xylem Inc. or one of its subsidiaries.