











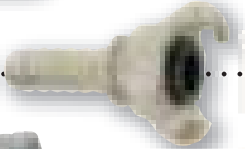

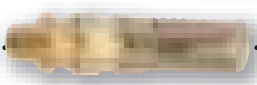

<i>PAGE 3... Cam-locks, fuel hose fittings, fuel nozzles, tank fittings</i>		<i>Cam-Locks & Fuel</i>	1
<i>PAGE 19... Combination nipples, menders, short shanks, strainers</i>		<i>Hose Shanks & Strainers</i>	2
<i>PAGE 26... Universals, double-lock, ground joint, mining fittings</i>		<i>Air & Mining</i>	3
<i>PAGE 31... Quick couplings for air, water & hydraulic</i>		<i>Quick Couplings</i>	4
<i>PAGE 48... Fire hose couplings, forestry fittings, nozzles, hydrant adapters.</i>		<i>Fire & Hydrant</i>	5
<i>PAGE 57... Garden nozzles & adapters, pressure washer accessories</i>		<i>Garden & Pressure Wash</i>	6
<i>PAGE 62... Brass hose barbs, pipe fittings, flare fittings</i>		<i>Brass</i>	7
<i>PAGE 74... Truck air brake fittings for hose & tubing</i>		<i>Truck</i>	8
<i>PAGE 78... Push to connect fittings for tubing</i>		<i>Push-to-Connect</i>	9
<i>PAGE 83... Nylon & polypropylene fittings</i>		<i>Nylon & Polypropylene</i>	10
<i>PAGE 86... Gear clamps, T-bolt, punch clamps, support clamps, strapping, ferrules</i>		<i>Clamps & Ferrules</i>	11
<i>PAGE 101... Valves: ball, gate, check, angle, drain, & ground plug valves</i>		<i>Valves</i>	12
<i>PAGE 107... Malleable & carbon steel pipe fittings, forged steel, hammer unions,</i>		<i>Iron & Steel Pipe Fittings</i>	13
<i>PAGE 118... Stainless Steel pipe fittings, hose barbs, & sanitary couplings</i>		<i>Stainless & Sanitary</i>	14
<i>PAGE 123... Sandblast, slurry, & concrete fittings.</i>		<i>Material Handling</i>	15
<i>PAGE 125... Gauges, regulators, blow guns, sealants & tools</i>		<i>Gauges & Accessories</i>	16
<i>PAGE 138... Technical Information & Index</i>		<i>Index</i>	17

Buy from us & get the Green Line advantage...

- ✓ Proven product quality and reliability at competitive prices.
- ✓ Large inventories at convenient shipping points across Canada.
- ✓ Many popular hose assemblies pre-made for convenience & quick delivery.
- ✓ If it's in this catalog... it's in our warehouse, ready to be shipped.
- ✓ The friendliest, most experienced & knowledgeable staff in the business.
- ✓ Dealer sales aids including labels, charts, posters & signs.
- ✓ Same day shipping for most orders.
- ✓ No order minimums.



**If you can't find it...
Call us at any of the
toll-free numbers on
the back cover**

**Products listed in this
catalog are in stock...
ready for shipping**

Sizing:

Fitting sizes are generally expressed as a dash size given in 100th's of an inch. Double dash sizes indicate the nominal thread size first, and the hose shank size second. For example, a G23S-050-075 steel hose barb has a 1/2" pipe thread and a 3/4" hose shank. Flare and other brass fittings are listed in 16th's of an inch.

Stock:

The items shown in this catalog are generally all in common use and in stock for immediate delivery. If you can't find what you need in this book or in our other catalogs, please call us.

Attaching:

The following schedule shows the labour charge for fitting installation. Clamp or ferrule costs must be added. If you are in doubt, please call us for a quote. And remember, commonly used assemblies are shown as pre-made units in our hose catalog.

Schedule of attaching charges:

Hose size (I.D.)	Price per end
up to 1/2"	\$ 2.10
5/8" to 1"	3.15
1-1/4" to 2"	5.25
2-1/2" to 4"	8.40
5" to 6"	17.90
8" to 12"	42.00

Testing:

Fittings attached using good workmanship generally do not require testing prior to use. However, some environmentally sensitive or potentially dangerous applications call for proof pressure testing, conductivity testing, or periodical inspection and testing. We can provide these services upon request at our facilities.

Hydrostatic Test charges:

Hose size (I.D.)	Net price per hose
<i>Low pressure testing up to 500 psi</i>	
up to 3"	\$ 52.50
4" to 6"	89.00
above 6"	115.00
<i>High pressure testing above 500 psi</i>	
up to 2"	63.00
above 2"	99.00



ALUMINUM CAM-LOCKS

Our aluminum cam-locks are manufactured from aluminum alloy 384 (JIS grade ADS12) and feature type 316 stainless pins, forged brass handles, and plated steel finger rings. G65 couplings fit Commercial Item Description (CID) #A-A-59326B for sizes 3/4" to 6" and will interchange with other couplings that meet this specification. No government standard has been established for 1/2", 8" and 10" so different manufacturers' couplings may not interchange in this size. Female couplers are supplied with locking clips.

Aluminum working pressures:

1/2" to 2"	250 psi
2 1/2" to 4"	150
5" & 6"	75
8"	50
10"	50

Standard gaskets are rated to 105°C (221°F)

Part No.	Size	IMPA Code	PRICE EACH
----------	------	-----------	------------

G65A... PART A FEMALE NPT ADAPTER

G65A-050	1/2"	35-17-01	\$3.90
G65A-075	3/4"	35-17-02	3.70
G65A-100	1"	35-17-03	3.80
G65A-125	1 1/4"	35-17-04	5.00
G65A-150	1 1/2"	35-17-05	4.60
G65A-200	2"	35-17-06	5.40
G65A-250	2 1/2"	35-17-07	9.60
G65A-300	3"	35-17-08	9.80
G65A-400	4"	35-17-09	15.90
G65A-500	5"	35-17-10	37.00
G65A-600	6"	35-17-11	35.20
G65A-800	8"	35-17-12	168.10
G65A-1000	10"		378.70



G65B... PART B MALE NPT COUPLER

G65B-050	1/2"	35-18-51	7.50
G65B-075	3/4"	35-18-52	8.50
G65B-100	1"	35-18-53	9.50
G65B-125	1 1/4"	35-18-54	11.90
G65B-150	1 1/2"	35-18-55	11.90
G65B-200	2"	35-18-56	12.80
G65B-250	2 1/2"	35-18-57	18.10
G65B-300	3"	35-18-58	21.70
G65B-400	4"	35-18-59	28.80
G65B-500	5"	35-18-60	66.60
G65B-600	6"	35-18-61	64.00
G65B-800	8"	35-18-62	326.20
G65B-1000	10"		613.60



G65C... PART C HOSE SHANK COUPLER

G65C-050	1/2"		6.70
G65C-075	3/4"	35-20-01	6.90
G65C-100	1"	35-20-02	8.30
G65C-125	1 1/4"	35-20-03	11.90
G65C-150	1 1/2"	35-20-04	11.40
G65C-200	2"	35-20-05	13.40
G65C-250	2 1/2"	35-20-06	18.40
G65C-300	3"	35-20-07	22.80
G65C-400	4"	35-20-08	30.40
G65C-500	5"	35-20-09	69.50
G65C-600	6"	35-20-10	70.50
G65C-800	8"	35-20-11	323.80
G65C-1000	10"		808.50



Part No.	Size	IMPA Code	PRICE EACH
----------	------	-----------	------------

G65D... PART D FEMALE NPT COUPLER

G65D-050	1/2"	35-18-01	\$8.10
G65D-075	3/4"	35-18-02	8.60
G65D-100	1"	35-18-03	9.20
G65D-125	1 1/4"	35-18-04	12.30
G65D-150	1 1/2"	35-18-05	11.90
G65D-200	2"	35-18-06	12.80
G65D-250	2 1/2"	35-18-07	19.10
G65D-300	3"	35-18-08	22.20
G65D-400	4"	35-18-09	29.90
G65D-500	5"	35-18-10	57.60
G65D-600	6"	35-18-11	64.90
G65D-800	8"	35-18-12	310.10
G65D-1000	10"		613.60



G65E... PART E HOSE SHANK ADAPTER

G65E-050	1/2"		4.10
G65E-075	3/4"	35-19-01	3.90
G65E-100	1"	35-19-02	4.50
G65E-125	1 1/4"	35-19-03	5.80
G65E-150	1 1/2"	35-19-04	5.60
G65E-200	2"	35-19-05	7.10
G65E-250	2 1/2"	35-19-06	12.10
G65E-300	3"	35-19-07	14.20
G65E-400	4"	35-19-08	23.50
G65E-500	5"	35-19-09	51.40
G65E-600	6"	35-19-10	57.60
G65E-800	8"	35-19-11	200.90
G65E-1000	10"		502.50



G65F... PART F MALE NPT ADAPTER

G65F-050	1/2"	35-17-51	4.70
G65F-075	3/4"	35-17-52	4.80
G65F-100	1"	35-17-53	5.20
G65F-125	1 1/4"	35-17-54	7.00
G65F-150	1 1/2"	35-17-55	6.00
G65F-200	2"	35-17-56	7.30
G65F-250	2 1/2"	35-17-57	12.50
G65F-300	3"	35-17-58	14.10
G65F-400	4"	35-17-59	22.80
G65F-500	5"	35-17-60	51.70
G65F-600	6"	35-17-61	52.50
G65F-800	8"	35-17-62	217.30
G65F-1000	10"		413.10



Safety Note: Cam-locks should not be used with compressed air or other compressed gases.

ALUMINUM CAM-LOCKS

Cam-locks & Fuel

Part No.	Size	IMPA Code	PRICE EACH
G65DC... PART DC DUST CAP			
			
G65DC-050	1/2"		\$6.40
G65DC-075	3/4"	35-20-51	7.30
G65DC-100	1"	35-20-52	8.30
G65DC-125	1 1/4"	35-20-53	11.10
G65DC-150	1 1/2"	35-20-54	10.00
G65DC-200	2"	35-20-55	11.60
G65DC-250	2 1/2"	35-20-56	14.90
G65DC-300	3"	35-20-57	19.00
G65DC-400	4"	35-20-58	25.80
G65DC-500	5"	35-20-59	46.70
G65DC-600	6"	35-20-60	57.10
G65DC-800	8"	35-20-61	255.50
G65DC-1000	10"		562.90

Part No.	Size	IMPA Code	PRICE EACH
G65DP... PART DP DUST PLUG			
			
G65DP-050	1/2"		\$3.30
G65DP-075	3/4"	35-19-51	3.20
G65DP-100	1"	35-19-52	3.80
G65DP-125	1 1/4"	35-19-53	4.60
G65DP-150	1 1/2"	35-19-54	4.00
G65DP-200	2"	35-19-55	5.30
G65DP-250	2 1/2"	35-19-56	8.90
G65DP-300	3"	35-19-57	8.70
G65DP-400	4"	35-19-58	14.20
G65DP-500	5"	35-19-59	29.70
G65DP-600	6"	35-19-60	31.20
G65DP-800	8"	35-19-61	155.60
G65DP-1000	10"		280.10

JUMP SIZE CAM-LOCKS

Part No.	Cam size	Thread or shank size	PRICE EACH
G65A... PART A FEMALE NPT ADAPTER			
			
G65A-200-300	2"	3"	40.90
G65A-300-200	3"	2"	36.30
G65A-300-400	3"	4"	46.60
G65A-400-300	4"	3"	44.80

Part No.	Cam size	Thread or shank size	PRICE EACH
G65D... PART D FEMALE NPT COUPLER			
			
G65D-200-150	2"	1 1/2"	38.90
G65D-300-200	3"	2"	53.00
G65D-400-300	4"	3"	76.90

Part No.	Cam size	Thread or shank size	PRICE EACH
G65B... PART B MALE NPT COUPLER			
			
G65B-200-300	2"	3"	56.80
G65B-300-200	3"	2"	54.50
G65B-300-400	3"	4"	88.80
G65B-400-300	4"	3"	83.20

Part No.	Cam size	Thread or shank size	PRICE EACH
G65E... PART E HOSE SHANK COUPLER			
			
G65E-300-200	3"	2"	23.90
G65E-300-250	3"	2 1/2"	60.40
G65E-300-400	3"	4"	69.60
G65E-400-300	4"	3"	49.60

Part No.	Cam size	Thread or shank size	PRICE EACH
G65C... PART C HOSE SHANK COUPLER			
			
G65C-300-200	3"	2"	47.60
G65C-300-250	3"	2 1/2"	59.40
G65C-300-400	3"	4"	73.20
G65C-400-300	4"	3"	61.40

Part No.	Cam size	Thread or shank size	PRICE EACH
G65F... PART F MALE NPT ADAPTER			
			
G65F-200-300	2"	3"	44.40
G65F-300-200	3"	2"	45.40
G65F-300-400	3"	4"	55.20
G65F-400-300	4"	3"	53.70

Safety Note: Cam-locks should not be used with compressed air or other compressed gases.

CAM-LOCKS FOR INTERLOCKING CRIMP FERRULES

G64 fittings feature a collar that, when used with G3F crimp ferrules, locks the coupling to the ferrule for extra fitting retention.

G64C... CRIMP STYLE HOSE SHANK COUPLER

G64C-150	1½"	\$13.30
G64C-200	2"	15.60
G64C-300	3"	26.40
G64C-400	4"	34.90
G64C-600	6"	81.00



G64E... CRIMP STYLE HOSE SHANK ADAPTER

G64E-150	1½"	6.70
G64E-200	2"	7.80
G64E-300	3"	16.60
G64E-400	4"	27.60
G64E-600	6"	63.80

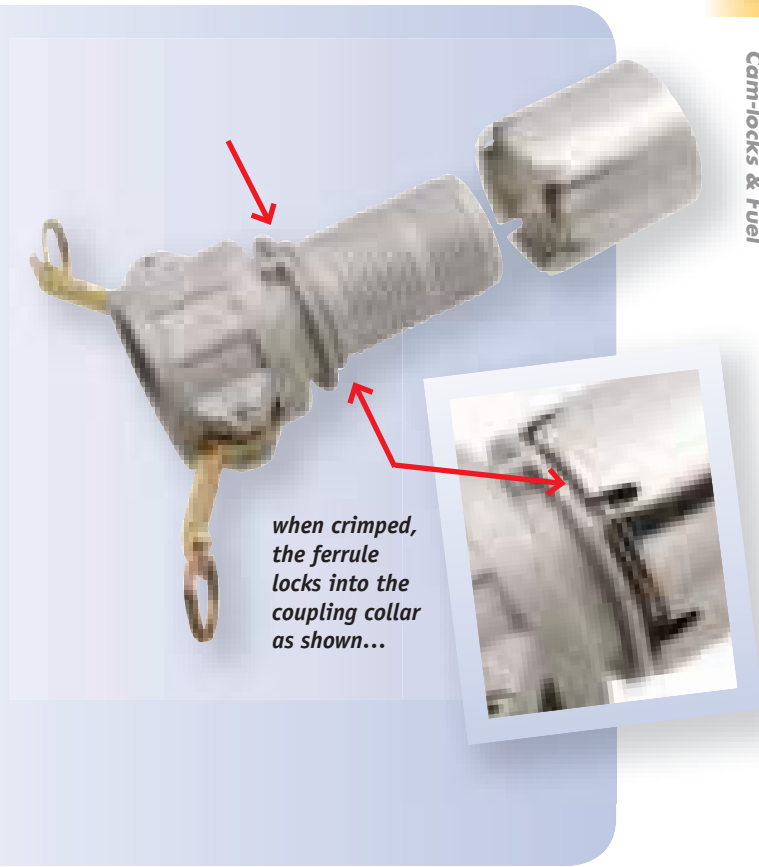

Part No.	Size	Size	PRICE EACH
----------	------	------	------------

G65AA... ALUMINUM DOUBLE MALE ADAPTER

G65AA-150-150	1½"	1½"	21.10
G65AA-200-200	2"	2"	23.40
G65AA-300-200	3"	2"	30.20
G65AA-300-300	3"	3"	40.10
G65AA-400-300	4"	3"	43.80
G65AA-400-400	4"	4"	53.60
G65AA-600-400	6"	4"	91.10
G65AA-600-600	6"	6"	96.70



Part No.	Size	Size	PRICE EACH
----------	------	------	------------

G65CA90... ELBOW COUPLER

	Female Size	Male Size	
G65CA90-200	2"	2"	\$103.40
G65CA90-300	3"	3"	150.10
G65CA90-400	4"	4"	211.20
G65CA90-600	6"	6"	440.50



G65CA... ALUMINUM REDUCER ADAPTER

	Female Size	Male Size	
G65CA-150-200	1½"	2"	39.50
G65CA-200-150	2"	1½"	39.50
G65CA-200-300	2"	3"	56.30
G65CA-200-400	2"	4"	75.70
G65CA-300-200	3"	2"	59.60
G65CA-300-400	3"	4"	84.80
G65CA-400-200	4"	2"	82.00
G65CA-400-300	4"	3"	82.30
G65CA-400-600	4"	6"	156.70
G65CA-600-300	6"	3"	167.30
G65CA-600-400	6"	4"	158.60
G65CA-800-600	8"	6"	415.50



G65DD... ALUMINUM DOUBLE FEMALE COUPLER

G65DD-200-200	2"	2"	64.10
G65DD-300-200	3"	2"	72.30
G65DD-300-300	3"	3"	86.80
G65DD-400-300	4"	3"	94.40
G65DD-400-400	4"	4"	98.70
G65DD-600-600	6"	6"	295.80



Safety Note: Cam-locks should not be used with compressed air or other compressed gases.

SPECIALTY ALUMINUM CAM-LOCKS

Part No. Size PRICE EACH

G65AFL... FLANGE ADAPTER

		
G65AFL-200	2"	\$91.60
G65AFL-300	3"	96.40
G65AFL-400	4"	134.10
G65AFL-600	6"	220.20

Part No. Size PRICE EACH

G65DFL... FLANGE ADAPTER

		
G65DFL-400	4"	\$ 196.50
G65DFL-600	6"	388.50

G65DCL... LOCKABLE DUST CAP

Arms can be secured with a pad-lock (lock not included)

		
G65DCL-150	1 1/2"	18.00
G65DCL-200	2"	20.50
G65DCL-300	3"	37.60
G65DCL-400	4"	44.30

G66LB... RING STYLE LOCKING ARM MALE NPT COUPLER

		
G66LB-200	2"	52.50
G66LB-300	3"	82.90
G66LB-400	4"	130.90

G65LC... LOCKING ARM HOSE SHANK COUPLER

		
G65LC-200	2"	55.70
G65LC-300	3"	82.40
G65LC-400	4"	108.40

G66LC... RING STYLE LOCKING ARM HOSE SHANK COUPLER

		
G66LC-200	2"	54.30
G66LC-300	3"	87.30
G66LC-400	4"	114.70

G65LD... LOCKING ARM FEMALE NPT COUPLER

		
G65LD-200	2"	53.30
G65LD-300	3"	79.90
G65LD-400	4"	110.50

G66LD... RING STYLE LOCKING ARM FEMALE NPT COUPLER

		
G66LD-200	2"	53.10
G66LD-300	3"	79.80
G66LD-400	4"	120.00

G65LDC... LOCKING ARM DUST CAP

		
G65LDC-200	2"	49.80
G65LDC-300	3"	66.80
G65LDC-400	4"	81.10

G66LDC... RING STYLE LOCKING ARM DUST CAP

		
G66LDC-200	2"	44.30
G66LDC-300	3"	58.30
G66LDC-400	4"	86.30

Safety Note: Cam-locks should not be used with compressed air or other compressed gases.

NYLON CAM-LOCKS

Nylon and Polypropylene cam-locks are fibreglass reinforced for extra strength. They are often used where weight is a concern; for example on portable forest fire fighting equipment. All sizes come complete with stainless arms. The yellow nylon parts are favored for their strength, while black polypropylene is more economical, and suitable for a wider range of chemicals. Female couplers are supplied with locking clips. Nylon parts are shown here.

***WORKING PRESSURES AT 20°C:**

3/4" to 2" 100 psi
3" & 4" 50 psi

*As temperatures rise, working pressures for these cam-locks drops dramatically. At 93°C, pressure ratings are reduced by 50% for nylon and polypropylene fittings.

Part No. Size PRICE EACH

G65NA NYLON PART A FEMALE NPT ADAPTER

			
G65NA-100	1"		\$3.70
G65NA-150	1 1/2"		5.60
G65NA-200	2"		7.00
G65NA-300	3"		15.10
G65NA-400	4"		31.20

G65NB... NYLON PART B MALE NPT COUPLER

			
G65NB-100	1"		12.00
G65NB-150	1 1/2"		15.80
G65NB-200	2"		20.90
G65NB-300	3"		32.00
G65NB-400	4"		51.10

G65NC... NYLON PART C HOSE SHANK COUPLER

			
G65NC-100	1"		11.30
G65NC-150	1 1/2"		15.80
G65NC-200	2"		20.90
G65NC-300	3"		32.00
G65NC-400	4"		51.10

G65ND... NYLON PART D FEMALE NPT COUPLER

			
G65ND-100	1"		11.70
G65ND-150	1 1/2"		16.50
G65ND-200	2"		20.90
G65ND-300	3"		32.00
G65ND-400	4"		51.10

Part No. Size PRICE EACH

G65NE... NYLON PART E HOSE SHANK ADAPTER

			
G65NE-100	1"		\$4.50
G65NE-150	1 1/2"		6.40
G65NE-200	2"		8.80
G65NE-300	3"		16.70
G65NE-400	4"		28.00

G65NF... NYLON PART F MALE NPT ADAPTER

			
G65NF-100	1"		5.00
G65NF-150	1 1/2"		6.60
G65NF-200	2"		8.80
G65NF-300	3"		18.30
G65NF-400	4"		29.50

G65NDC... NYLON PART DC DUST CAP

			
G65NDC-100	1"		10.70
G65NDC-150	1 1/2"		14.90
G65NDC-200	2"		17.50
G65NDC-300	3"		28.90
G65NDC-400	4"		43.80

G65NDP... NYLON PART DP DUST PLUG

			
G65NDP-100	1"		3.70
G65NDP-150	1 1/2"		4.60
G65NDP-200	2"		5.90
G65NDP-300	3"		15.80
G65NDP-400	4"		23.00

Safety Note: Cam-locks should not be used with compressed air or other compressed gases.

POLYPROPYLENE CAM-LOCKS

*WORKING PRESSURES AT 20°C:

3/4" to 2"	100 psi
3" & 4"	50 psi

*As temperatures rise, working pressures for these cam-locks drops dramatically. At 93°C, pressure ratings are reduced by 50% for nylon and polypropylene fittings.

Note: Polypropylene Buttress Adapters can be found in the Nylon & Polypropylene Section.

Part No. Size PRICE EACH

G65PA... POLYPROPYLENE PART A FEMALE NPT ADAPTER

		
G65PA-075	3/4"	\$2.00
G65PA-100	1"	2.30
G65PA-125	1 1/4"	2.70
G65PA-150	1 1/2"	3.20
G65PA-200	2"	3.60
G65PA-300	3"	8.90
G65PA-400	4"	18.20

G65PB... POLYPROPYLENE PART B MALE NPT COUPLER

		
G65PB-075	3/4"	6.80
G65PB-100	1"	8.10
G65PB-125	1 1/4"	10.60
G65PB-150	1 1/2"	11.00
G65PB-200	2"	13.00
G65PB-300	3"	21.30
G65PB-400	4"	35.80

G65PC... POLYPROPYLENE PART C HOSE SHANK COUPLER

		
G65PC-075	3/4"	6.10
G65PC-100	1"	7.40
G65PC-125	1 1/4"	10.70
G65PC-150	1 1/2"	10.70
G65PC-200	2"	12.60
G65PC-300	3"	20.80
G65PC-400	4"	35.10

G65PD... POLYPROPYLENE PART D FEMALE NPT COUPLER

		
G65PD-075	3/4"	7.10
G65PD-100	1"	8.30
G65PD-125	1 1/4"	10.80
G65PD-150	1 1/2"	11.30
G65PD-200	2"	13.10
G65PD-300	3"	21.80
G65PD-400	4"	37.70

Part No. Size PRICE EACH

G65PE... POLYPROPYLENE PART E HOSE SHANK ADAPTER

		
G65PE-075	3/4"	\$ 2.40
G65PE-100	1"	2.40
G65PE-125	1 1/4"	2.70
G65PE-150	1 1/2"	3.20
G65PE-200	2"	4.30
G65PE-300	3"	8.90
G65PE-400	4"	16.50

G65PF... POLYPROPYLENE PART F MALE NPT ADAPTER

		
G65PF-075	3/4"	2.20
G65PF-100	1"	2.30
G65PF-125	1 1/4"	3.10
G65PF-150	1 1/2"	3.40
G65PF-200	2"	4.30
G65PF-300	3"	9.30
G65PF-400	4"	16.50

G65PDC... POLYPROPYLENE PART DC DUST CAP

		
G65PDC-075	3/4"	5.70
G65PDC-100	1"	7.40
G65PDC-125	1 1/4"	10.20
G65PDC-150	1 1/2"	10.50
G65PDC-200	2"	11.30
G65PDC-300	3"	18.70
G65PDC-400	4"	29.90

G65PDP... POLYPROPYLENE PART DP DUST PLUG

		
G65PDP-075	3/4"	2.00
G65PDP-100	1"	2.00
G65PDP-125	1 1/4"	2.70
G65PDP-150	1 1/2"	2.90
G65PDP-200	2"	3.10
G65PDP-300	3"	7.30
G65PDP-400	4"	11.80

Safety Note: Cam-locks should not be used with compressed air or other compressed gases.

BRASS CAM-LOCKS

Brass cam-locks are used where the application requires corrosion resistance or extra strength. For example, they are popular in marine refueling where durability, salt water resistance, and non-sparking features are all important. G65BR couplings are manufactured from copper alloy grade 377 to the Commercial Item Description (CID) #A-A-59326B specification. Female couplers are supplied with locking clips.

BRASS WORKING PRESSURES:

1/2" to 2"	250 psi
2-1/2" to 4"	150
5" & 6"	75
8"	50
Standard gaskets are rated to 105°C (221°F)	

Part No. Size IMPA Code PRICE EACH

G65BRA... BRASS PART A FEMALE NPT ADAPTER

G65BRA-075	3/4"	35-17-16		\$10.50
G65BRA-100	1"	35-17-17		12.00
G65BRA-125	1 1/4"	35-17-18		16.40
G65BRA-150	1 1/2"	35-17-19		19.00
G65BRA-200	2"	35-17-20		24.40
G65BRA-250	2 1/2"	35-17-21		35.00
G65BRA-300	3"	35-17-22	42.80	
G65BRA-400	4"	35-17-23	76.00	
G65BRA-600	6"	35-17-25	148.80	

G65BRB... BRASS PART B MALE NPT COUPLER

				
G65BRB-075	3/4"	35-18-66		20.10
G65BRB-100	1"	35-18-67		23.70
G65BRB-125	1 1/4"	35-18-68		32.40
G65BRB-150	1 1/2"	35-18-69		32.90
G65BRB-200	2"	35-18-70		38.70
G65BRB-250	2 1/2"	35-18-71		53.20
G65BRB-300	3"	35-18-72		68.30
G65BRB-400	4"	35-18-73		97.50
G65BRB-600	6"	35-18-75		215.00

G65BRC... BRASS PART C HOSE SHANK COUPLER

				
G65BRC-075	3/4"	35-20-15		17.50
G65BRC-100	1"	35-20-16		23.60
G65BRC-125	1 1/4"	35-20-17		28.00
G65BRC-150	1 1/2"	35-20-18		32.10
G65BRC-200	2"	35-20-19		41.30
G65BRC-250	2 1/2"	35-20-20		56.90
G65BRC-300	3"	35-20-21		73.00
G65BRC-400	4"	35-20-22		110.30
G65BRC-600	6"	35-20-24		283.90

G65BRD... BRASS PART D FEMALE NPT COUPLER

				
G65BRD-075	3/4"	35-18-16		20.50
G65BRD-100	1"	35-18-17		26.00
G65BRD-125	1 1/4"	35-18-18		30.60
G65BRD-150	1 1/2"	35-18-19		35.40
G65BRD-200	2"	35-18-20		40.50
G65BRD-250	2 1/2"	35-18-21		58.80
G65BRD-300	3"	35-18-22		71.20
G65BRD-400	4"	35-18-23		113.50
G65BRD-600	6"	35-18-25		264.60

Number Size IMPA Code PRICE EACH

G65BRE... BRASS PART E HOSE SHANK ADAPTER

G65BRE-075	3/4"	35-19-15		\$12.10
G65BRE-100	1"	35-19-16		14.20
G65BRE-125	1 1/4"	35-19-17		18.80
G65BRE-150	1 1/2"	35-19-18		22.30
G65BRE-200	2"	35-19-19		33.40
G65BRE-250	2 1/2"	35-19-20		43.20
G65BRE-300	3"	35-19-21	61.30	
G65BRE-400	4"	35-19-22	94.20	
G65BRE-600	6"	35-19-24	247.20	

G65BRF... BRASS PART F MALE NPT ADAPTER

				
G65BRF-075	3/4"	35-17-66		12.50
G65BRF-100	1"	35-17-67		15.40
G65BRF-125	1 1/4"	35-17-68		21.70
G65BRF-150	1 1/2"	35-17-69		24.40
G65BRF-200	2"	35-17-70		30.10
G65BRF-250	2 1/2"	35-17-71		50.50
G65BRF-300	3"	35-17-72		59.50
G65BRF-400	4"	35-17-73		105.40
G65BRF-600	6"	35-17-75		202.70

G65BRDC... BRASS PART DC DUST CAP

				
G65BRDC-075	3/4"	35-20-65		17.40
G65BRDC-100	1"	35-20-66		20.10
G65BRDC-125	1 1/4"	35-20-67		27.00
G65BRDC-150	1 1/2"	35-20-68		29.80
G65BRDC-200	2"	35-20-69		33.80
G65BRDC-250	2 1/2"	35-20-70		43.80
G65BRDC-300	3"	35-20-71		57.00
G65BRDC-400	4"	35-20-72		82.60
G65BRDC-600	6"	35-20-74		178.50

G65BRDP... BRASS PART DP DUST PLUG

				
G65BRDP-075	3/4"	35-19-65		11.00
G65BRDP-100	1"	35-19-66		12.60
G65BRDP-125	1 1/4"	35-19-67		15.10
G65BRDP-150	1 1/2"	35-19-68		15.40
G65BRDP-200	2"	35-19-69		20.20
G65BRDP-250	2 1/2"	35-19-70		28.90
G65BRDP-300	3"	35-19-71		32.80
G65BRDP-400	4"	35-19-72		51.80
G65BRDP-600	6"	35-19-74		140.00

Safety Note: Cam-locks should not be used with compressed air or other compressed gases.

STAINLESS STEEL CAM-LOCKS

Our stainless couplings are manufactured from type 316 stainless for maximum corrosion resistance. Care is taken at the factory to ensure a smooth finish on wetted surfaces to minimize bacteria build-up in sanitary applications. Ductile iron cam-locks are not plated. Female couplers are supplied with locking clips.

STAINLESS STEEL WORKING PRESSURES

3/4" to 2"	250 psi
2 1/2 to 4	150
6	100

Standard gaskets are rated to 105°C (221°F)

Part No. Size IMPA Code PRICE EACH

G65SSA... STAINLESS STEEL PART A FEMALE NPT ADAPTER

G65SSA-050	1/2"			\$8.70
G65SSA-075	3/4"	35-17-32		10.20
G65SSA-100	1"	35-17-33		13.30
G65SSA-125	1 1/4"	35-17-34		18.70
G65SSA-150	1 1/2"	35-17-35		22.60
G65SSA-200	2"	35-17-36		27.60
G65SSA-250	2 1/2"	35-17-37		47.50
G65SSA-300	3"	35-17-38		54.40
G65SSA-400	4"	35-17-39		87.50
G65SSA-600	6"	35-17-41		194.10

G65SSB... STAINLESS STEEL PART B MALE NPT COUPLER

				
G65SSB-075	3/4"	35-18-82		18.00
G65SSB-100	1"	35-18-83		22.70
G65SSB-125	1 1/4"	35-18-84		33.40
G65SSB-150	1 1/2"	35-18-85		35.90
G65SSB-200	2"	35-18-86		42.90
G65SSB-250	2 1/2"	35-18-87		66.70
G65SSB-300	3"	35-18-88		77.90
G65SSB-400	4"	35-18-89		112.10
G65SSB-600	6"	35-18-91		269.80

G65SSC... STAINLESS STEEL PART C HOSE SHANK COUPLER

				
G65SSC-075	3/4"	35-20-31		17.10
G65SSC-100	1"	35-20-32		21.90
G65SSC-125	1 1/4"	35-20-33		33.90
G65SSC-150	1 1/2"	35-20-34		35.70
G65SSC-200	2"	35-20-35		49.80
G65SSC-250	2 1/2"	35-20-36		76.50
G65SSC-300	3"	35-20-37		96.60
G65SSC-400	4"	35-20-38		129.60
G65SSC-600	6"	35-20-40		331.10

G65SSD... STAINLESS STEEL PART D FEMALE NPT COUPLER

				
G65SSD-050	1/2"			17.50
G65SSD-075	3/4"	35-18-32		19.20
G65SSD-100	1"	35-18-33		24.60
G65SSD-125	1 1/4"	35-18-34		35.30
G65SSD-150	1 1/2"	35-18-35		37.50
G65SSD-200	2"	35-18-36		47.20
G65SSD-250	2 1/2"	35-18-37		71.30
G65SSD-300	3"	35-18-38		85.30
G65SSD-400	4"	35-18-39		127.00
G65SSD-600	6"	35-18-41		288.60

Part No. Size IMPA Code PRICE EACH

G65SSE... STAINLESS STEEL PART E HOSE SHANK ADAPTER

G65SSE-075	3/4"	35-19-31		\$9.80
G65SSE-100	1"	35-19-32		15.70
G65SSE-125	1 1/4"	35-19-33		22.40
G65SSE-150	1 1/2"	35-19-34		28.30
G65SSE-200	2"	35-19-35		40.20
G65SSE-250	2 1/2"	35-19-36		69.40
G65SSE-300	3"	35-19-37		77.80
G65SSE-400	4"	35-19-38		120.50
G65SSE-600	6"	35-19-40		324.10

G65SSF... STAINLESS STEEL PART F MALE NPT ADAPTER

				
G65SSF-050	1/2"			11.20
G65SSF-075	3/4"	35-17-82		13.00
G65SSF-100	1"	35-17-83		17.30
G65SSF-125	1 1/4"	35-17-84		27.00
G65SSF-150	1 1/2"	35-17-85		31.70
G65SSF-200	2"	35-17-86		40.00
G65SSF-250	2 1/2"	35-17-87		59.50
G65SSF-300	3"	35-17-88		72.50
G65SSF-400	4"	35-17-89		128.90
G65SSF-600	6"	35-17-91		286.70

G65SSDC... STAINLESS STEEL PART DC DUST CAP

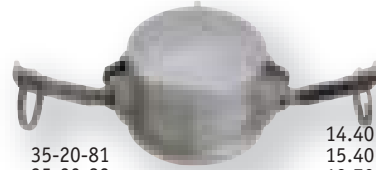
				
G65SSDC-050	1/2"			14.40
G65SSDC-075	3/4"	35-20-81		15.40
G65SSDC-100	1"	35-20-82		19.70
G65SSDC-125	1 1/4"	35-20-83		28.50
G65SSDC-150	1 1/2"	35-20-84		29.90
G65SSDC-200	2"	35-20-85		38.20
G65SSDC-250	2 1/2"	35-20-86		54.40
G65SSDC-300	3"	35-20-87		65.20
G65SSDC-400	4"	35-20-88		89.80
G65SSDC-600	6"	35-20-90		253.70

G65SSDP... STAINLESS STEEL PART DP DUST PLUG

				
G65SSDP-075	3/4"	35-19-81		6.80
G65SSDP-100	1"	35-19-82		9.30
G65SSDP-125	1 1/4"	35-19-83		16.60
G65SSDP-150	1 1/2"	35-19-84		17.30
G65SSDP-200	2"	35-19-85		26.90
G65SSDP-250	2 1/2"	35-19-86		45.70
G65SSDP-300	3"	35-19-87		46.50
G65SSDP-400	4"	35-19-88		81.50
G65SSDP-600	6"	35-19-90		172.50

Safety Note: Cam-locks should not be used with compressed air or other compressed gases.

CAM-LOCKS FOR INTERLOCKING CRIMP FERRULES

G64SS fittings feature a collar that, when used with G3F crimp ferrules, locks the coupling to the ferrule for extra fitting retention.

G64SSC... CRIMP STYLE HOSE SHANK COUPLER

G64SSC-150	1½"	\$37.10
G64SSC-200	2"	51.70
G64SSC-300	3"	100.30
G64SSC-400	4"	134.60



when crimped, the ferrule locks into the coupling collar as shown...

G64SSE... CRIMP STYLE HOSE SHANK COUPLER

G64SSE-150	1½"	29.40
G64SSE-200	2"	41.70
G64SSE-300	3"	80.80
G64SSE-400	4"	125.10



Part No.	Size	Size	PRICE EACH
----------	------	------	------------

G65SSAA... STAINLESS STEEL DOUBLE MALE ADAPTER

G65SSAA-200-200	2"	2"	123.00
G65SSAA-300-200	3"	2"	150.60
G65SSAA-300-300	3"	3"	200.30
G65SSAA-400-300	4"	3"	259.60
G65SSAA-400-400	4"	4"	263.70



G65SSDD... STAINLESS STEEL DOUBLE FEMALE ADAPTER

G65SSDD-200-200	2"	2"	150.60
G65SSDD-300-300	3"	3"	229.10
G65SSDD-400-400	4"	4"	337.30

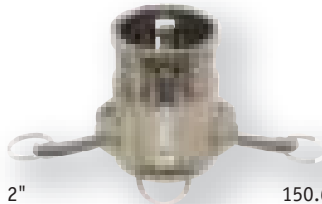

G65SSCA... STAINLESS STEEL REDUCER

	Female	Male	
G65SSCA-200-300	2"	3"	189.40
G65SSCA-300-200	3"	2"	196.00
G65SSCA-300-400	3"	4"	230.70
G65SSCA-400-300	4"	3"	281.20
G65SSCA-600-400	6"	4"	569.20



Safety Note: Cam-locks should not be used with compressed air or other compressed gases.

STAINLESS STEEL LOCKING ARM CAM-LOCKS

SAFETY BUMPS

Cam-locks & Fuel

Part No. Size PRICE EACH

G65SSLB... LOCKING ARM STAINLESS PART B MALE NPT COUPLER

G65SSLB-150	1½"	\$128.20
G65SSLB-200	2	141.80
G65SSLB-300	3	246.50
G65SSLB-400	4	372.40



G65SSLC... LOCKING ARM STAINLESS PART C HOSE SHANK COUPLER

G65SSLC-100	1"	110.90
G65SSLC-150	1½"	118.50
G65SSLC-200	2	126.90
G65SSLC-300	3	229.50
G65SSLC-400	4	327.00



G65SSLD... LOCKING ARM STAINLESS PART D FEMALE NPT COUPLER

G65SSLD-100	1"	110.80
G65SSLD-150	1½"	121.70
G65SSLD-200	2	133.80
G65SSLD-300	3	246.30
G65SSLD-400	4	341.40



G65SSLDC... LOCKING ARM STAINLESS PART DC DUST CAP

G65SSLDC-100	1"	110.80
G65SSLDC-150	1½"	108.30
G65SSLDC-200	2	125.80
G65SSLDC-300	3	164.60
G65SSLDC-400	4	222.60

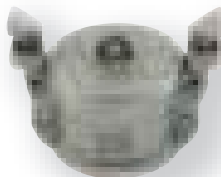

Safety Bumps™ replace traditional cam and groove caps and plugs, providing a comfortable handle for the driver's hand and a "bump" that extends beyond the hose fittings and ears, protecting them from damage.

Safety Bumps™ are available in two, three and four inch, male and female models, in both hazardous and food grade configurations.

Safety Bumps™ are made from a glass-filled black composite with an antistatic additive. White food-grade certified fittings are available on special order, as are blue fittings for non-flammable products.

Standard black Safety Bumps™ are biodiesel and ethanol safe.

Part No. Size PRICE EACH

Safety Bump Dust Caps

G65SBDC-200	2"	\$47.20
G65SBDC-300	3	62.80
G65SBDC-400	4	74.00



Safety Bump Dust Plugs

G65SBDP-200	2"	35.60
G65SBDP-300	3	49.60
G65SBDP-400	4	63.00



Replacement Arms for Safety Bump Dust Caps

G65SBY-200	Fits 2"	4.80
G65SBY-300	Fits 3" & 4"	6.10

Safety Locks™ are a companion product for the Safety Bump™ product line.

Safety Lock™ eliminates the chance for cam-lock ears to open up during deliveries due to pulsing or vibration. Spills due to cam-lock ears opening up have plagued the industry for years. Velcro straps tear and wear out against the edges of the ears and, like various other ear locking solutions, are difficult to use with gloved hands.

Safety Locks™ are made from a rugged material for long life and work with Green Line® standard female hose fittings with split rings.

It is recommended that Safety Locks™ be tethered to either the hose fitting split ring or to a Safety Bump™ to prevent loss and to allow the cable to be used to easily remove the Safety Lock™.

Safety Locks

G65SL-200	2"	7.40
G65SL-300	3	8.90
G65SL-400	4	11.20



Safety Note: Cam-locks should not be used with compressed air or other compressed gases.

Standard G65X Gaskets are made from buna-N (nitrile) rubber. We also stock common sizes of viton rubber gaskets as shown below for special chemical applications. Other sizes of viton gaskets as well as gaskets of other material are available on special order.

Temperature Range: G65X -35°C (-31°F) to 105°C (221°F)
G65VX -18°C (0°F) to 180°C (356°F)

Part No.	Size	PRICE EACH
----------	------	------------

G65X... CAM-LOCK GASKET

G65X-050	1/2"	\$0.60
G65X-075	3/4"	0.60
G65X-100	1"	0.70
G65X-125	1 1/4"	0.80
G65X-150	1 1/2"	0.80
G65X-200	2"	0.80
G65X-250	2 1/2"	1.20
G65X-300	3"	1.30
G65X-400	4"	1.70
G65X-500	5"	3.70
G65X-600	6"	4.00
G65X-800	8"	11.80
G65X-1000	10"	19.30

Extra Thick Gaskets:

G65THX-200	2"	2.30
G65THX-300	3"	3.10
G65THX-400	4"	3.80

Viton Gaskets:

G65VX-075	3/4"	7.00
G65VX-100	1"	8.10
G65VX-125	1 1/4"	10.00
G65VX-150	1 1/2"	12.70
G65VX-200	2"	16.00
G65VX-300	3"	22.60
G65VX-400	4"	34.80

G65Y... BRASS CAM-ARM c/w finger ring & pin

G65Y-075	3/4"	2.30
G65Y-100	1"	3.10
G65Y-125	1 1/4" up to 2 1/2"	4.60
G65Y-300	3" up to 5"	6.80
G65Y-600	6"	14.10
G65Y-800	8"	15.40

G65SSY... STAINLESS STEEL CAM-ARM c/w finger ring & pin

G65SSY-075	3/4"	3.20
G65SSY-100	1"	4.10
G65SSY-125	1 1/4" up to 2 1/2"	6.10
G65SSY-300	3" up to 4"	9.20
G65SSY-600	6"	29.80

G65LY... STAINLESS LOCKING CAM-ARM c/w pin & lock-plate

G65LY-200	2"	34.20
G65LY-300	3" up to 4"	38.90

Note: G65LY Locking Arms can only be installed on G65L series couplers

Part No.	Size	PRICE EACH
----------	------	------------

G65SC... CAM-LOCK SAFETY LOCK CLIP

G65SC	Safety clip	\$0.60
G65SC-600	Safety clip for 6"	2.10

G65R... CAM-LOCK RING

G65R	Standard cam-lock ring	1.00
------	------------------------	------

G65SSZ... SECURITY CHAIN WITH S-HOOKS

G65SSZX6	6" Stainless Steel	4.00
G65SSZX12	12" Stainless Steel	5.70

G65VS... VELCRO ARM STRAPS

	Diameter	Cam-lock Size	
G65VS-200	2"-4"	1 1/2"-2 1/2"	7.50
G65VS-300	3 1/2"-6"	2 1/2"-4"	8.00
G65VS-400	4 1/2"-10"	4"-6"	10.40

G65ST... ALUMINUM STRAINER

G65ST-200	2" NPT	29.40
G65ST-300	3" NPT	44.40
G65ST-400	4" NPT	58.40

This strainer has 1/4" holes and threads into female NPT threads.

G65SST... STAINLESS STRAINER

G65SST-200	2" NPT	65.10
G65SST-300	3" NPT	88.20
G65SST-400	4" NPT	140.50

Hose I.D. Part No. Weight Each (lb.) PRICE EACH

COMPOSITE HOSE FITTINGS...

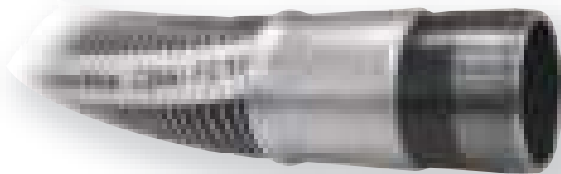

Carbon Steel Male NPT Inserts



2"	G81-200	0.36	\$63.10
3	G81-300	0.73	79.70
4	G81-400	1.32	110.20
6	G81-600	11.44	283.80

Type 304 Stainless Steel Male NPT Inserts*

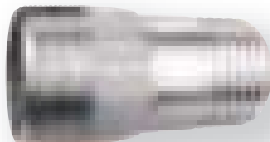

1 1/2"	G81SS-150	0.27	113.10
2	G81SS-200	0.36	119.30
3	G81SS-300	0.73	217.40
4	G81SS-400	1.32	284.10
6	G81SS-600	11.44	713.30

Grooved Nipple Insert



6"	G81V-600	11.44	267.70
----	----------	-------	--------

Turned Back Flange Nipple Insert*



4"	G81FL-400	4.84	213.10
6	G81FL-600	11.44	439.60

Type 316 Stainless Turned Back Flange Nipple Insert*

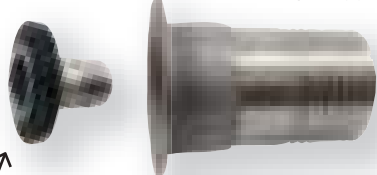

4"	G81SSFL-400	4.84	415.90
6	G81SSFL-600	11.84	881.80

*flanges not included

Hose I.D. Part No. Weight Each (lb.) PRICE EACH

Nitrile Sealing Gasket



1 1/2"	G82-150	0.01	\$8.10
2	G82-200	0.01	8.70
3	G82-300	0.02	16.50
4	G82L-400	0.02	18.80
6	G82-600	0.44	59.60

Carbon Steel Ferrules



1 1/2"	G83-150	0.05	25.00
2	G83-200	0.10	29.20
3	G83-300	0.17	35.40
4	G83W-400	0.32	49.10
6	G83-600	8.14	315.40

Note: For composite hose support slings, see HB Hose Buns in the accessories section



FUEL HOSE COUPLINGS

These low pressure couplings are designed for use with gravity feed or low pressure fuel dispensing hoses. The 3/4" & 1" sizes are made from diecast zinc with zinc dichromate plating. The 1 1/4" size is aluminum.

Part No.	Pipe Size	Hose Size	PRICE EACH Loose	EACH Std Pkg	Pkg Qty
G21Z... FARM TANK COUPLING					
G21Z-075	3/4"	3/4"	\$4.50	\$3.90	5
G21Z-100	1"	1"	6.00	5.50	5
G33A-125					
G33A-125	1 1/4"	1 1/4"		16.90	1

CURB PUMP CRIMP FITTINGS

G61C crimp fittings are machined from brass and chrome plated. Special o-rings used in the G61CX swivel fittings provide a long life with all modern fuel types. G63C ferrules are aluminum. These couplings are used to produce ULC approved assemblies at our approved and inspected assembly facility.

Part No.	Pipe Size	Hose I.D.	Hose O.D.	PRICE EACH
G61C... MALE NPT				
G61C-075-113	3/4"	3/4"	1.13"	12.20
G61C-100-150	1"	1"	1.50"	24.50
G61CX... LIVE SWIVEL MALE NPT				
G61CX-075-113	3/4"	3/4"	1.13"	22.50
G61CX-100-150	1"	1"	1.50"	33.00
G63C... CURB PUMP FERRULE				
G63C-075-113		3/4"	1.13"	4.00
G63C-100-150		1"	1.50"	5.60

INTERNAL EXPANSION & RE-USABLE CURB PUMP FITTINGS

These traditional style couplings are machined from brass and chrome plated. All curb pump fittings should be grounded to the wire reinforcement of the hose using a staple or pin during assembly. Correct matching of hose outside diameter to the coupling is necessary to ensure good coupling retention. Crimp fittings must be installed according to factory instructions

Part No.	Pipe Size	Hose I.D.	Hose O.D.	PRICE EACH
G21C... PERMANENT CURB PUMP FITTING				
G21C-075-113	3/4"	3/4"	1.13"	\$16.60
G21C-100-150	1"	1"	1.50"	31.60
G21CRLM... LIVE SWIVEL REUSABLE CURB PUMP FITTING				
G21CRLM-075-113	3/4"	3/4"	1.13"	32.40
G21CRLM-075-125	3/4"	3/4"	1.25"	52.50
G21CRLM-100-150	1"	1"	1.50"	84.10

INTERNAL EXPANSION COUPLINGS

Internal expansion couplings are manufactured from solid brass forgings. Ferrules are cold-drawn copper alloy. These couplings can only be installed using a Scovil type internal expansion machine. Internal expansion couplings are most commonly found in home fuel oil or marine refueling applications.

Part No.	Pipe Size	Hose Size	PRICE EACH
G61... BRASS MALE NPT			
G61-075	3/4"	3/4"	39.50
G61-100	1"	1"	39.50
G61-125	1 1/4"	1 1/4"	41.40
G61-138	1 1/2"	1 3/8"	58.40
G61-150	1 1/2"	1 1/2"	51.00
G61-200	2"	2"	93.10
G62... BRASS FEMALE NPSM			
G62-100	1"	1"	75.30
G62-125	1 1/4"	1 1/4"	77.10
G62-138	1 1/2"	1 3/8"	83.30
G62-150	1 1/2"	1 1/2"	97.40
G62-200	2"	2"	137.00
G63... FERRULES			
G63-075		Hose I.D. 3/4"	15.80
G63-100		1"	15.10
G63-125		1 1/4"	18.10
G63-138		1 3/8"	27.20
G63-150		1 1/2"	23.00
G63-200		2"	35.80

Specify ferrule letter designation from chart below to match hose O.D.

Hose I.D.	Hose O.D. and Ferrule Designation						
	AAA	AA	A	B	C	D	E
3/4"		1.17"	1.22"	1.27"	1.32"	1.37"	
1"		1.47	1.51	1.55	1.60	1.64	1.69
1 1/4"		1.69	1.75	1.80	1.86	1.91	1.97
1 3/8"				1.80	1.86	1.91	1.97
1 1/2"	1.90	1.97	2.04	2.10	2.16	2.22	2.29
2"		2.46	2.53	2.59	2.66	2.72	2.79

Utility nozzles are suitable for gravity feed or 12 volt utility pumps only. Please note that automotive filler necks on newer (unleaded gas) vehicles will only accept the 3/4" spout. The large capacity 1-1/4 nozzle is generally used for diesel service and is rated to 25 psi maximum.

G67... UTILITY NOZZLES

G67-075-100 3/4" 1" NPT Basic Nozzle \$52.90



G67

Note: Several of our utility nozzles previously carried a UL listing. Recently UL has changed some of the requirements that the nozzles must meet. The design changes required are cost prohibitive and so G67 products previously listed as G67UL are now listed as G67P. For customers requiring a UL listed nozzle, please see our G69 nozzles listed on the next page.

G67P-075-100 3/4" 1" 900W34S Premium with straight spout 78.40
 G67P-100-100 1" 1" 900S Premium with straight spout 78.40



G67P

G67PB-075-100 3/4" 1" 900W34B Premium with bent spout 78.40
 G67PB-100-100 1" 1" 900B Premium with bent spout 78.40



G67PB

G67-125-125 1 1/4" 1 1/4" 1250-94 Low pressure bulk nozzle 260.10



G67

G68 nozzles are designed for manual operation (no automatic shut-off) and are generally used for bulk oil delivery. G68A nozzles are used in card lock or industrial truck refueling stations and feature venturi type automatic shut-offs. Both series are aluminum construction with a bronze trigger and handle high pressures and flows up to 300 litres per minute. Please note that a minimum of 29 litres per minute of flow is required for the automatic shut-off to function. When supplied with a break-away spout, this nozzle meets UL/ULC requirements.

Part No.	Spout Size	Thread Size	Cross Reference	Description	PRICE EACH
----------	------------	-------------	-----------------	-------------	------------

G68... BULK DELIVERY NOZZLES

G68-125	1 1/4"	1 1/4" NPT	114D	Bulk delivery nozzle	\$516.90
G68-150	1 1/2"	1 1/2"	112D	Bulk delivery nozzle	505.80
G68A-150	1 1/2"	1 1/2"	1124D	Automatic shut off nozzle	1062.70



G68A

G68AUL-150 1 1/2" 1 1/2" AN150 UL/ULC Automatic shut off nozzle 989.40



G68AUL

The variety of fuel nozzles now available is quite staggering. Not only are there several brands with varying features, there are also several competing designs of vapor recovery systems in place in different geographic locations. Such vapor recovery systems include varying types of balance systems and vacuum assist systems that require the nozzle to be matched with the pumping and recovery system. Generally these products are supplied by the petroleum equipment distributors that service the pump equipment. Here we offer a limited range of the Husky conventional fueling nozzles, most often found in commercial and industrial dispensing applications.

Note: Due to changes in the National Fire Prevention Code, we can no longer sell nozzles with hold open clips unless they are pressure activated. This means that nozzles with hold open clips will not work on gravity feed systems. The pressure from the pump opens a check valve allowing the fuel to flow. All of the G69 nozzles shown are automatic shut-off and are ULC approved. Pressure activated nozzles require a minimum line pressure of 17 psi to activate flow.



3/4" Nozzle



1" Nozzle

Part Number	Cross Reference	Fuel	Thread Size	Hold Open Clip	Grip Color	PRICE EACH
Nozzles without hold open clips (not pressure activated)						
G69ULC-075-B	159408-04	unleaded gas	3/4" NPT	no	black	\$165.90
G69ULC-075-R	159408-02	unleaded gas	3/4"	no	red	165.90
G69ULC-100-B	173312-04	diesel or gas	1	no	black	298.10
G69ULC-100-R	173312-02	diesel or gas	1	no	red	298.10
G69ULC-100-Y	173312-05	diesel or gas	1	no	yellow*	298.10
Nozzles with hold open clips (pressure activated)						
G69PA-075-B	159504-04	unleaded gas	3/4" NPT	yes	black	162.10
G69PA-075-R	159504-02	unleaded gas	3/4"	yes	red	162.10
G69PA-100-B	177610-04	diesel or gas	1	yes	black	341.30
G69PA-100-R	177610-02	diesel or gas	1	yes	red	341.30
G69PA-100-Y	177610-05	diesel or gas	1	yes	yellow*	341.30

Husky Nozzle Features:

- UL/ULC listed.
- automatically shuts off when gas tank is full.
- nozzle shuts off if it raises above horizontal or falls from the filler neck.
- 3/4" nozzle is regulated to 43 litres per minute (10 U.S. GPM) maximum.
- 1" nozzle is for high volume with flow rates up to 325 litres per minute (75 U.S.GPM).
- smooth grip guards included (other colors are available - specify at time of ordering)
- optional splash guards available in various colors.

Part Number	Cross Reference	Description	Color	PRICE EACH
G69SG-B	1808-04	splash guard	black	9.10
G69SG-R	1808-02	splash guard	red	9.10
G69SG-Y	1808-05	splash guard	yellow*	9.10
G69HW-075-B	4145-04	hand warmer	black	13.30
G69HW-075-R	4145-02	hand warmer	red	13.30
G69HW-100-B	4740-04	hand warmer	black	17.90
G69HW-100-R	4740-02	hand warmer	red	17.90
G69HW-100-Y	4740-05	hand warmer	yellow*	17.90

*Note: Yellow typically designates diesel service

G0808BV... BREAKAWAY VALVES



G0808BV



G0808BVR

Part Number	Cross Reference	Pipe Size	Description	PRICE EACH
G0808BV-075-075	2273	3/4"	Single use valve	77.50
G0808BVR-075-075	3360	3/4"	Re-connectable valve	166.30
G0808BVR-100-100	2276	1	Re-connectable valve	245.00

Part No.	Pipe Size/Material	Cross Reference	PRICE EACH
FUEL HOSE SWIVELS			
G1608XA-075	3/4" Aluminum/zinc	36S-5080	\$57.50
G1608XA-100	1" Aluminum/zinc	36S-5090	89.40



G1608XAU-075	360° - 3/4" Aluminum/zinc		68.80
G1608XAU-100	360° - 1" Aluminum/zinc		116.30



G1608XA-125	1 1/4" Aluminum	SWMF-125	237.00
G1608XA-150	1 1/2" Aluminum	SWMF-150	256.10



The 2000L and 2500L are automatic pressure and vacuum relief caps for farm and industrial fuel storage tanks. The normally closed relief valve prevents fuel evaporation and dust contamination. It vents at 2psi pressure or 0.7"Hg vacuum. The body has an NPS male threaded body with a lockable cap (padlock not included).

Part No.	Description	PRICE EACH
----------	-------------	------------

LOCKING VENT CAP



2000L	2" Locking Vent Cap	\$67.80
2500L	2 1/2" Locking Vent Cap	67.80

The lockable cap rotates to control gravity flow from above ground storage tanks. (Padlock not included)

LOCKABLE ANGLE VALVES

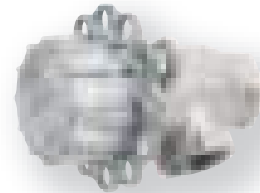

500AV	1" NPT Valve	112.60
525AV	1 1/4" NPT Valve	128.20

HOSE MENDERS

We offer hose menders in a variety of materials to suit the products being conveyed.

Part Number	Hose Size	PRICE EACH		Pkg Qty
		Loose	Std Pkg	
G20S... PLATED STEEL HOSE MENDER				
				
G20S-038	3/8"	\$2.70	\$2.40	5
G20S-050	1/2"	2.70	2.40	5
G20S-063	5/8"	5.10	4.60	5
G20S-075	3/4"	3.10	2.80	5
G20S-100	1"	3.90	3.50	5
G20S-113	1 1/8"	7.10	6.50	5
G20S-125	1 1/4"	5.10	4.60	5
G20S-150	1 1/2"	6.10	5.60	5
G20S-200	2"	8.30	7.40	5
G20S-250	2 1/2"	13.00	11.80	5
G20S-300	3"	17.50	15.70	5
G20S-400	4"	27.70	24.90	5
G20S-500	5"		55.00	1
G20S-600	6"		67.80	1
G20S-800	8"		143.50	1
G20S-1000	10"		251.20	1
G20S-1200	12"		385.10	1

G20SL... LONG STEEL HOSE MENDER

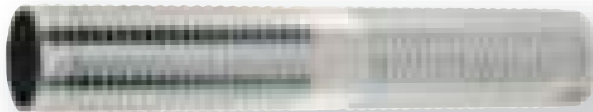

G20SL-150	1 1/2" x 9" long	17.00	15.40	5
G20SL-200	2" x 9" long	20.70	18.80	5

G20B... BRASS HOSE MENDER



G20B-013	1/8"		1.50	1
G20B-019	3/16"	1.90	1.70	5
G20B-025	1/4"	1.70	1.50	5
G20B-031	5/16"	1.70	1.50	5
G20B-038	3/8"	1.60	1.40	5
G20B-050	1/2"	2.20	2.00	5
G20B-063	5/8"		3.20	1
G20B-075	3/4"		3.80	1

Part Number	Hose Size	PRICE EACH		Pkg Qty
		Loose	Std Pkg	

G20N... NYLON HOSE MENDER



G20N-013	1/8"		\$0.95	\$0.81	10
G20N-019	3/16"		1.05	0.83	10
G20N-025	1/4"		0.83	0.72	10
G20N-031	5/16"		1.15	0.92	10
G20N-038	3/8"		1.05	0.83	10
G20N-038-025	3/8"	1/4"	1.15	0.98	10
G20N-050	1/2"		1.15	0.99	10
G20N-050-025	1/2"	1/4"	1.35	1.10	10
G20N-050-038	1/2"	3/8"	1.05	0.83	10
G20N-063	5/8"		1.35	1.10	10
G20N-063-038	5/8"	3/8"	1.46	1.20	10
G20N-063-050	5/8"	1/2"	1.75	1.45	10
G20N-075	3/4"		1.45	1.20	10
G20N-100	1"		1.66	1.40	10
G20N-125	1 1/4"		2.90	2.40	10
G20N-150	1 1/2"		4.60	3.90	10
G20N-200	2"		11.10	9.30	10

The collar on the following mender is designed for use with interlocking G29C style clamps for maximum holding strength.

G20M... COLLARED IRON HOSE MENDER



G20M-050	1/2"	5.20	4.80	5
G20M-075	3/4"	7.80	7.20	5
G20M-100	1"	14.20	12.70	5
G20M-125	1 1/4"	13.30	11.90	5
G20M-150	1 1/2"	14.60	13.10	5
G20M-200	2"	25.70	23.10	5
G20M-250	2 1/2"		46.00	1
G20M-300	3"		49.20	1
G20M-400	4"		87.30	1

G20SS... STAINLESS STEEL HOSE MENDER



G20SS-025	1/4"		2.40	1
G20SS-038	3/8"		3.30	1
G20SS-050	1/2"		4.50	1
G20SS-075	3/4"		8.30	1
G20SS-100	1"		9.70	1
G20SS-125	1 1/4"		12.00	1
G20SS-150	1 1/2"		16.10	1
G20SS-200	2"		22.00	1
G20SS-250	2 1/2"		33.90	1
G20SS-300	3"		63.20	1
G20SS-400	4"		77.60	1

COMBINATION NIPPLES

Combination nipples are most commonly used for water suction and discharge hoses. However, the availability of a wide variety of materials has made them useful in many marine, chemical, and food applications.

Hose Shanks & Strainers

Part Number	Pipe Size	Hose Size	PRICE EACH Loose	Std Pkg	Pkg Qty
-------------	-----------	-----------	------------------	---------	---------

G33... CARBON STEEL COMBINATION NIPPLE



G33-050	1/2"	1/2"	\$2.20	\$2.10	5
G33-075	3/4"	3/4"	2.50	2.20	5
G33-100	1"	1"	3.50	3.00	5
G33-125	1 1/4"	1 1/4"	5.10	4.30	5
G33-150	1 1/2"	1 1/2"	5.70	5.00	5
G33-200	2"	2"	6.30	5.70	5
G33-250	2 1/2"	2 1/2"	13.10	11.80	5
G33-300	3"	3"	15.60	14.00	5
G33-400	4"	4"	23.20	20.90	5
G33-500	5"	5"		54.70	1
G33-600	6"	6"		60.60	1
G33-800	8"	8"		120.90	1
G33-1000	10"	10"		210.20	1
G33-1200	12"	12"		320.80	1

Jump Sizes:

G33-100-125	1"	1 1/4"		12.10	1
G33-125-150	1 1/4"	1 1/2"		13.40	1
G33-150-125	1 1/2"	1 1/4"		14.90	1

G33G... GALVANIZED STEEL COMBINATION NIPPLE

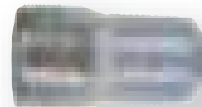

G33G-050	1/2"	1/2"	2.40	2.20	5
G33G-075	3/4"	3/4"	2.70	2.40	5
G33G-100	1"	1"	3.40	2.90	5
G33G-125	1 1/4"	1 1/4"	4.50	4.10	5
G33G-150	1 1/2"	1 1/2"	5.40	4.80	5
G33G-200	2"	2"	6.60	5.90	5
G33G-250	2 1/2"	2 1/2"	13.10	11.90	5
G33G-300	3"	3"	16.20	14.60	5
G33G-400	4"	4"	24.90	22.40	5
G33G-500	5"	5"		55.30	1
G33G-600	6"	6"		61.40	1
G33G-800	8"	8"		117.40	1
G33G-1000	10"	10"		229.20	1

Jump Sizes:



G33G-050-063	1/2"	5/8"		3.50	1
G33G-075-088	3/4"	7/8"		3.50	1
G33G-075-100	3/4"	1"		8.70	1
G33G-100-075	1"	3/4"		9.20	1
G33G-100-113	1"	1 1/8"		5.60	1
G33G-100-125	1"	1 1/4"		10.50	1
G33G-125-100	1 1/4"	1"		10.50	1
G33G-125-150	1 1/4"	1 1/2"		11.20	1
G33G-150-125	1 1/2"	1 1/4"		13.30	1
G33G-150-200	1 1/2"	2"		17.30	1
G33G-200-150	2"	1 1/2"		16.30	1
G33G-200-250	2"	2 1/2"		29.60	1
G33G-250-200	2 1/2"	2"		43.00	1
G33G-250-300	2 1/2"	3"		42.90	1
G33G-300-250	3"	2 1/2"		44.30	1
G33G-300-400	3"	4"		101.70	1

Part Number	Size	PRICE EACH Loose	Std Pkg	Pkg Qty
-------------	------	------------------	---------	---------

G33SS... TYPE 304 STAINLESS STEEL COMBINATION NIPPLE

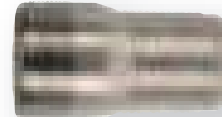

G33SS-050	1/2"	\$8.90	\$8.00	5
G33SS-075	3/4"	12.00	10.80	5
G33SS-100	1"	14.80	13.40	5
G33SS-125	1 1/4"	18.70	16.70	5
G33SS-150	1 1/2"	24.70	22.20	5

G33SS-200	2"	29.20	26.20	5
G33SS-250	2 1/2"		48.30	1
G33SS-300	3"		59.30	1
G33SS-400	4"		88.10	1
G33SS-600	6"		330.30	1

Jump Sizes:

G33SS-150-200	1 1/2"		58.40	1
---------------	--------	--	-------	---

G33A... ALUMINUM COMBINATION NIPPLE

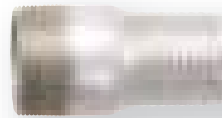

G33A-075	3/4"		18.80	1
G33A-100	1"		18.80	1
G33A-125	1 1/4"		16.90	1
G33A-150	1 1/2"		21.10	1
G33A-200	2"		24.90	1

G33B... BRASS COMBINATION NIPPLE

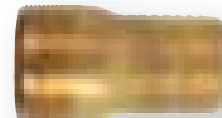

G33B-100	1"	33.30	29.90	5
G33B-125	1 1/4"	38.30	34.50	5
G33B-150	1 1/2"	41.60	37.60	5
G33B-200	2"	64.90	58.20	5
G33B-250	2 1/2"		97.50	1

G33B-300	3"		135.70	1
----------	----	--	--------	---

G33N... NYLON COMBINATION NIPPLE



G33N-075	3/4"	2.30	2.10	5
G33N-100	1"	2.80	2.40	5
G33N-125	1 1/4"	3.90	3.60	5
G33N-150	1 1/2"	5.30	4.80	5

G33N-200	2"	8.10	7.30	5
G33N-300	3"		15.70	1
G33N-400	4"		22.80	1

G33V... VICTAULIC GROOVED CARBON STEEL



G33V-150	1 1/2"	5.90	5.30	5
G33V-200	2"	7.60	6.80	5
G33V-250	2 1/2"	15.40	13.70	5
G33V-300	3"	18.60	16.70	5
G33V-400	4"	27.60	24.70	5

G33V-500	5"		59.80	1
G33V-600	6"		61.40	1
G33V-800	8"		126.20	1
G33V-1000	10"		226.70	1
G33V-1200	12"		315.70	1

COMBINATION NIPPLES

Part Number	Size	PRICE EACH		Pkg Qty
		Loose	Std Pkg	
G33VG... VICTAULIC GROOVED PLATED STEEL				
G33VG-200	2"	\$17.90	\$16.20	5
G33VG-300	3"	18.60	16.70	5
G33VG-400	4"	26.00	23.30	5
G33VG-600	6"		65.20	1
G33VG-800	8"		132.30	1

G33VLG... VICTAULIC GROOVED LONG BARB PLATED

G33VLG-200	2"	7" long	27.80	25.30	5
G33VLG-400	4"	10 ³ / ₄ " long	67.50	61.50	5

G33W... WELDABLE COMBINATION NIPPLE

G33W-200	2"	7.60	6.80	5
G33W-300	3"	18.60	16.70	5
G33W-400	4"	27.60	24.70	5
G33W-600	6"		61.40	1

CRIMP STYLE FITTINGS

Part Number	Hose I.D.	PRICE EACH
-------------	-----------	------------

G33C & G33SSC... CRIMP STYLE MALE NPT HOSE STEM

G33C fittings feature a collar that, when used with G3F crimp ferrules, locks the coupling to the ferrule for extra fitting retention as shown below.

Plated steel

G33C-100	1"	16.70
G33C-125	1 ¹ / ₄ "	19.10
G33C-150	1 ¹ / ₂ "	18.30
G33C-200	2"	20.50
G33C-300	3"	35.30
G33C-400	4"	52.90
G33C-600	6"	123.60

Type 316 stainless steel

G33SSC-100	1"	40.70
G33SSC-125	1 ¹ / ₄ "	47.40
G33SSC-150	1 ¹ / ₂ "	55.70
G33SSC-200	2"	71.00
G33SSC-300	3"	151.40
G33SSC-400	4"	214.90
G33SSC-600	6"	650.30



when crimped, the ferrule locks into the coupling collar as shown...

REUSABLE CLAMP FITTINGS

Part Number	Hose I.D.	PRICE EACH
-------------	-----------	------------

G38VR... GROOVED COUPLING c/w REUSABLE CLAMP

For general water discharge, fracking, mining and agricultural applications. G38VR fittings come complete with a reusable collar as well as all necessary bolts for attachment.

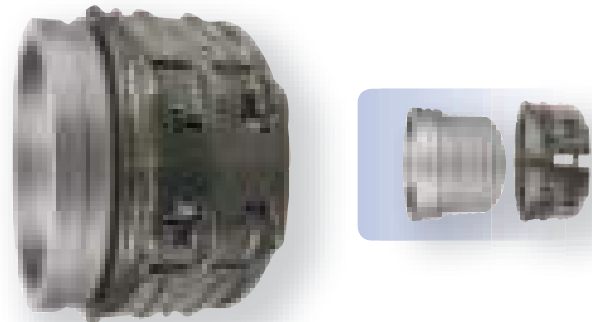

G38VR-800	8"	\$630.70
G38VR-1000	10"	857.50

BRASS LONG SHANK

Part Number	Pipe Size	Hose Size	PRICE EACH		Pkg Qty
			Loose	Std Pkg	

G31BLS... BRASS MALE LONG SHANK COUPLING

Brass long shanks are typically used on washdown hoses where the longer shank provides extra fitting retention. 3/4" and 1" fittings are machined brass - larger sizes are cast.



G31BLS-075	3/4"	3/4"	\$12.30	\$10.60	5
G31BLS-100	1"	1"	11.80	10.70	5
G31BLS-125	1 ¹ / ₄ "	1 ¹ / ₄ "	30.00	27.00	5
G31BLS-150	1 ¹ / ₂ "	1 ¹ / ₂ "	38.60	34.30	5
G31BLS-150-100	1 ¹ / ₂ "	1"		44.00	1
G31BLS-200	2"	2"	48.20	43.50	5

G32BLS... BRASS FEMALE LONG SHANK COUPLING



G32BLS-075	3/4"	3/4"	14.80	13.60	5
G32BLS-100	1"	1"	11.80	10.70	5
G32BLS-125	1 ¹ / ₄ "	1 ¹ / ₄ "	36.90	33.20	5
G32BLS-150	1 ¹ / ₂ "	1 ¹ / ₂ "	45.40	40.90	5
G32BLS-150-100	1 ¹ / ₂ "	1"		45.90	1
G32BLS-200	2"	2"	63.00	56.70	5

G30G... GASKETS

G30G gaskets fit short and long shank couplings.

G30G-100	1"	0.70	0.60	10
G30G-125	1 ¹ / ₄ "	0.70	0.60	10
G30G-150	1 ¹ / ₂ "	0.70	0.60	10
G30G-200	2"	0.90	0.70	10
G30G-250	2 ¹ / ₂ "	1.00	0.80	5
G30G-300	3"	1.40	1.20	5
G30G-400	4"	1.60	1.40	5

SHORT SHANK COUPLINGS

STRAINERS • FOOT VALVES

2

Hose Shanks & Strainers

Part Number	Size	Material	PRICE EACH		Pkg Qty
			Loose	Std Pkg	

G31... MALE SHORT SHANK COUPLING

Short shanks provide economical hose connections for water discharge lines. In many applications they have been replaced by cam-lock style couplings, due to the positive sealing and ease of connection features that cam-locks provide. We are gradually phasing out the plated iron short shanks, but the ones shown here and other sizes are still available.



G31-150	1 1/2"	Plated iron	\$9.50	\$8.50	5
G31-200	2"	Plated iron	12.40	11.00	5

G32... FEMALE SHORT SHANK COUPLING

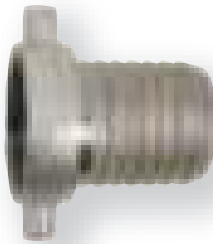

G32-125	1 1/4"	Plated iron	14.30	13.00	5
G32-150	1 1/2"	Plated iron	13.50	12.30	5
G32-200	2"	Plated iron	18.90	17.00	5
G32-300	3"	Plated iron		33.10	1

G31B... BRASS MALE



G31B-100	1"	Brass	10.30	8.90	5
G31B-150	1 1/2"	Brass	16.60	15.10	5
G31B-200	2"	Brass	26.90	24.40	5
G31B-250	2 1/2"	Brass		37.40	1

G32B... BRASS FEMALE

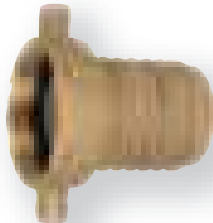

G32B-100	1"	Brass	9.80	8.80	5
G32B-150	1 1/2"	Brass	19.00	17.00	5
G32B-200	2"	Brass	29.00	25.90	5
G32B-250	2 1/2"	Brass		40.70	1

Part Number	Size	Diameter	Height	PRICE
				EACH

G34EFV... ECONOMY CAST IRON FOOT VALVE & STRAINER

To match lower priced products being sold, we have added a lighter version foot valve with a rubber flapper.



G34EFV-150	1 1/2"			\$19.00
G34EFV-200	2"			31.80
G34EFV-300	3"			57.00
G34EFV-400	4"			109.90
G34EFV-600	6"			259.40

G34FV... CAST IRON FOOT VALVE & STRAINER

Cast iron foot valves employ a leather flapper that prevents the pump from losing its prime. They are ideal where the pump must be left unattended for long periods. The weight of the iron ensures that the valve remains in the water.

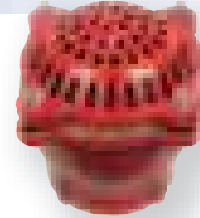

G34FV-150	1 1/2"	3.25"	4"	28.30
G34FV-200	2"	4.25"	5"	41.00
G34FV-250	2 1/2"	5.25"	5.5"	57.90
G34FV-300	3"	5.25"	6"	74.40
G34FV-400	4"	7"	9"	129.20
G34FV-600	6"	10"	11"	311.60
G34FV-800	8"	16"	15"	592.80

G34FVL... FOOT VALVE REPLACEMENT LEATHER

G34FVL-150	1 1/2"			6.30
G34FVL-200	2"			9.90
G34FVL-250	2 1/2"			10.80
G34FVL-300	3"			12.60
G34FVL-400	4"			17.10
G34FVL-600	6"			38.20
G34FVL-800	8"			85.60



G34FVS... FOOT VALVE REPLACEMENT STRAINER

G34FVS-150	1 1/2"			6.70
G34FVS-200	2"			10.40
G34FVS-250	2 1/2"			15.40
G34FVS-300	3"			21.00
G34FVS-400	4"			33.50
G34FVS-600	6"			66.30
G34FVS-800	8"			201.00



G34FVB... BRASS FOOT VALVE WITH STAINLESS SCREEN

G34FVB-075	3/4"			17.30
G34FVB-100	1"			23.00
G34FVB-125	1 1/4"			31.60
G34FVB-150	1 1/2"			42.60
G34FVB-200	2"			72.60



STRAINERS

Part Number	Pipe Size	Strainer Hole Size	Diameter	Height	PRICE EACH
-------------	-----------	--------------------	----------	--------	------------

G34... ROUND HOLE STRAINER (PLATED STEEL)

G34 strainers are made from zinc plated steel. The open area of 50% allows removal of damaging debris while still maintaining adequate flow.



G34-150	1 1/2"	3/8"	5"	3.75"	\$16.40
G34-200	2"	3/8"	6"	4.25"	19.00
G34-250	2 1/2"	3/8"	6"	4.25"	22.50
G34-300	3"	3/8"	7"	5.50"	29.60
G34-400	4"	3/8"	7"	5.50"	33.40
G34-600	6"	1"	9"	9.00"	101.70
G34-800	8"	1"	11"	11.50"	160.20
G34-1000	10"	1"	15"	18.00"	556.40

G34L... LONG STRAINER (PLATED STEEL)

G34L strainers are long and slim for use in narrow or confined openings. The design is generally no wider than the hose itself. G34L are popular when pumping from ice covered water supplies.



G34L-150	1 1/2"	3/8"	2.25"	6.50"	19.50
G34L-200	2"	3/8"	2.75"	6.63"	22.70
G34L-300	3"	3/8"	3.88"	9.63"	30.10
G34L-400	4"	3/8"	4.88"	9.63"	59.40

G34SK... REMOVABLE STRAINER ASSEMBLY

For Suction Hose Assemblies featuring male and female cam-locks, Green Line offers our G34SK Removable Strainer Assembly in sizes 2" through 6".



	Size				
G34SK-200	2"	3/8"	6"	6.25"	35.50
G34SK-300	3"	3/8"	6"	7.75"	75.50
G34SK-400	4"	3/8"	7"	8.00"	115.00
G34SK-600	6"	1"	9"	11.75"	273.50

Part Number	Pipe Size	Strainer Hole Size	Diameter	Height	PRICE EACH
-------------	-----------	--------------------	----------	--------	------------

G34SQ... SQUARE HOLE TRASH STRAINER

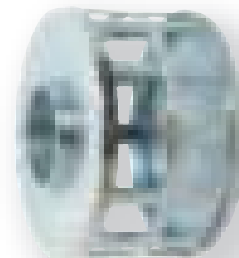

G34SQ-150	1 1/2"	1"	5"	3.5"	\$20.00
G34SQ-200	2"	1 1/8"	6"	4.0"	22.30
G34SQ-250	2 1/2"	1 1/2"	6"	4.5"	29.80
G34SQ-300	3"	1 1/2"	7"	5.0"	35.20
G34SQ-400	4"	1 1/2"	7"	5.0"	49.40
G34SQ-600	6"	1 1/2"	9"	9.5"	132.50

Part Number	Size	Diameter	Height	PRICE EACH
-------------	------	----------	--------	------------

G34P... POLYETHYLENE BASKET STRAINER

Polyethylene strainers are used where weight or corrosion resistance are important. They are particularly popular in marine applications.

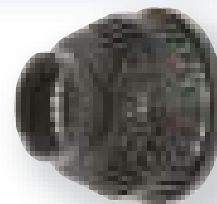

G34P-150	1 1/2"	4.88"	3.63"	10.00
G34P-200	2"	4.88"	3.63"	10.00
G34P-300	3"	7.13"	4.13"	22.40

G34F... SMALL HOLE STRAINER FOR FISH HABITAT

The Department of Fisheries and Oceans recommends that where water is being withdrawn from fish habitat, the maximum screen hole size on a strainer should be 1/10". In addition, to prevent juvenile fin fish from being dragged onto the screen, the fluid velocity must be limited to less than 4.33"/second by providing adequate screen area. Based on this data, we have increased our offering of strainers to suit various pumping rates. For eel, burbot, and other slow swimming species, flow rates should be 1/3 of the amounts shown.

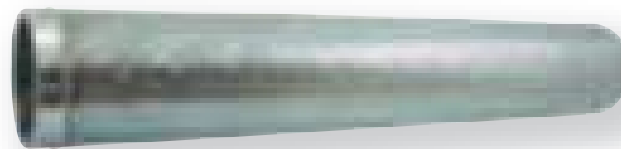

Part Number	Pipe Size	Strainer Hole Size	Dia.	Height	Max.Flow	PRICE EACH
G34F-300-4	3"	1/10"	4"	24"	130 USGPM	189.30

BALL-LOCK COUPLINGS

2

Hose Shanks & Strainers

These galvanized steel fittings are economical and are quick and simple to connect. The ball and socket design allows for couplings to be connected even when the parts are misaligned, and connections can flex up to 30° in all directions. Extra long hose shanks allow lots of room for multiple clamps, while crimp style fittings are also available for our ball-lock assemblies.

Green Line stocks two types of Ball-Lock Couplings...

TYPE A: Developed by Anfor in the early 1900s, Type A Ball-Lock couplings were originally used in agricultural applications. Today, Type A Ball-Lock couplings are the industry standard in 10" and 12" sizes and are predominantly used in dewatering applications.

TYPE B: Type B Ball-Lock Couplings were developed by Bauer in Germany. Engineered to include smaller sizes as well as higher pressure ratings, these couplings are applicable not only in dewatering applications, but also in sewer bypass, agricultural, and mining applications.

Part Number	Size	PRICE Loose	EACH Std Pkg	Pkg Qty
-------------	------	-------------	--------------	---------

TYPE B BAND STYLE BALL-LOCK COUPLINGS

G35MH... MALE X HOSE BARB c/w LEVER RING



G35MH-300	3"	\$49.50		1
G35MH-400	4"	74.00		1
G35MH-600	6"	133.10		1
G35MH-800	8"	245.50		1

G35FH... FEMALE X HOSE BARB c/w GASKET



G35FH-300	3"	19.90		1
G35FH-400	4"	39.00		1
G35FH-600	6"	69.60		1
G35FH-800	8"	133.70		1

TYPE B CRIMP STYLE BALL-LOCK COUPLINGS

G35MC... MALE X HOSE BARB c/w LEVER RING

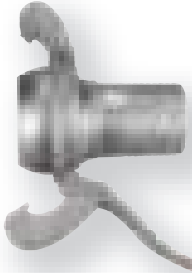

G35MC-400	4"	98.40		1
G35MC-600	6"	180.80		1
G35MC-800	8"	300.90		1
G35MC-1000	10"	791.30		1
G35MC-1200	12"	1032.10		1

G35FC... FEMALE X HOSE BARB c/w GASKET



G35FC-400	4"	64.20		1
G35FC-600	6"	121.40		1
G35FC-800	8"	210.40		1
G35FC-1000	10"	392.30		1
G35FC-1200	12"	552.80		1

Ball-Lock Type	Size	Degree Offset Allowed	Pressure Rating
B	3"	30°	290 psi
B	4"	20	217
B	6"	20	175
B	8"	20	175
B	10"	20	175
B	12"	16	175
A	10"	16	72
A	12"	16	58

Part Number	Size	PRICE Loose	EACH Std Pkg	Pkg Qty
-------------	------	-------------	--------------	---------

G35G... TYPE B EPDM RUBBER GASKET



G35G-300	3"	\$2.70	\$2.20	10
G35G-400	4"	4.50	3.70	10
G35G-600	6"	9.00	7.50	10
G35G-800	8"	20.40	17.00	10
G35G-1000	10"		20.60	1
G35G-1200	12"		37.60	1

G35SC... TYPE B SAFETY CLIP



G35SC-300	3"	4.60	3.80	10
G35SC-400	4"	4.90	4.10	10
G35SC-600	6" & 8"	4.90	4.10	10
G35SC-1000	10" & 12"		10.00	1

G35L... TYPE B OPENING LEVER



G35L	10" & 12"	29.80		1
------	-----------	-------	--	---

Safety Note: Always use safety clips to prevent accidental disconnection while in service.

BALL-LOCK COUPLINGS

Part Number	Size	PRICE Loose	EACH Std Pkg	Pkg Qty
-------------	------	-------------	--------------	---------

TYPE A BALL-LOCK COUPLINGS

G35MHA... MALE X HOSE BARB c/w RING

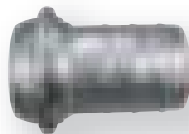

G35MHA-1000	10"	\$273.10		1
G35MHA-1200	12"	417.10		1

G35FHA... FEMALE X HOSE BARB c/w GASKET

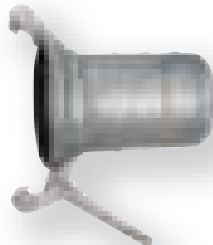

G35FHA-1000	10"	254.40		1
G35FHA-1200	12"	471.50		1

G35GA... TYPE A RUBBER GASKET



G35GA-1000	10"	19.30		1
G35GA-1200	12"	21.60		1

G35LA... TYPE A OPENING LEVER

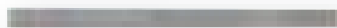

G35LA-1000	10"	29.80		1
G35LA-1200	12"	14.60		1

TYPE A BALL-LOCK COUPLING ADAPTERS

G35MFLA... MALE X FLANGE c/w RING

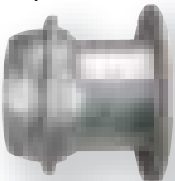

G35MFLA-1000	10"	595.30		1
G35MFLA-1200	12"	823.00		1

G35FFLA... FEMALE X FLANGE c/w GASKET

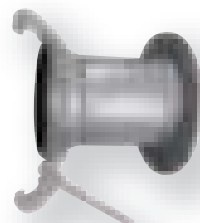

G35FFLA-1000	10"	601.40		1
G35FFLA-1200	12"	929.80		1

In addition to the adapters seen here, Green Line is able to offer custom Canadian manufactured Ball-Lock adapters to meet your needs - please contact us for more information.



Part Number	Size	PRICE Loose	EACH Std Pkg	Pkg Qty
-------------	------	-------------	--------------	---------

TYPE B BALL-LOCK COUPLING ADAPTERS

G35MP... MALE X MALE NPT c/w LEVER RING

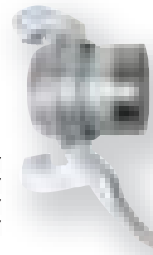

G35MP-300	3"	\$71.60		1
G35MP-400	4"	130.70		1
G35MP-600	6"	226.40		1
G35MP-800	8"	434.30		1

G35FP... FEMALE X MALE NPT c/w GASKET



G35FP-300	3"	32.40		1
G35FP-400	4"	68.80		1
G35FP-600	6"	102.30		1
G35FP-800	8"	209.70		1

G35MFL... MALE X FLANGE c/w LEVER RING

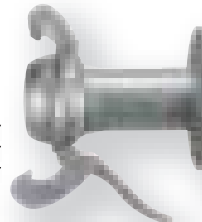

G35MFL-400	4"	190.50		1
G35MFL-600	6"	298.80		1
G35MFL-800	8"	521.50		1

G35FFL... FEMALE X FLANGE c/w GASKET



G35FFL-400	4"	131.40		1
G35FFL-600	6"	190.20		1
G35FFL-800	8"	322.60		1

G35MF45... MALE X FEMALE 45° ELBOW c/w GASKET & LEVER RING



G35MF45-400	4"	167.70		1
G35MF45-600	6"	313.10		1
G35MF45-800	8"	435.40		1

G35MF90... MALE X FEMALE 90° ELBOW c/w GASKET & LEVER RING



G35MF90-400	4"	167.60		1
G35MF90-600	6"	313.10		1
G35MF90-800	8"	522.40		1

Ground joint fittings are for heavy-duty applications such as steam, air supply for construction, roadbuilding, and drilling applications. The coarse threads make G29 couplings easy to couple in the field, and the heavy wing nuts can be tightened using a hammer or mallet. Collars on G29S hose stems are designed for use with G29C interlocking clamps while our G29SC hose stems are made to be crimped using our G29CR ferrules. Typical hose assemblies will have G29S or G29SC stems and G29N wing nuts on both ends fastened with G29C clamps or G29CR ferrules. Hose lengths can then be joined using G29DS double spuds. Male and female spuds are used to adapt to pipe thread ends on valves, pipe fittings, or manifolds. Green Line also now offers Female NPT Ground Joint adapters to adapt to male pipe hose assemblies if needed. Ground joint fittings are made from plated ductile iron. Small size stems are plated carbon steel and small double spuds are brass.



Part Number	Hose Size	PRICE E-ACH		Pkg Qty
		Loose	Std Pkg	

G29S... GROUND JOINT FEMALE STEM

G29S-050	1/2"	\$7.30	\$6.40	5
G29S-075	3/4"	9.60	8.70	5
G29S-100	1"	10.70	9.60	5
G29S-125	1 1/4"	14.20	12.80	5
G29S-150	1 1/2"	15.30	13.50	5
G29S-200	2"	17.20	15.60	5
G29S-250	2 1/2"		38.80	1
G29S-300	3"		44.70	1
G29S-400	4"		117.90	1

G29SC... CRIMPABLE GROUND JOINT FEMALE STEM

G29SC-075	3/4"		15.60	1
G29SC-100	1"		17.50	1
G29SC-200	2"		29.20	1

G29N... GROUND JOINT WING NUT

G29N-050	1/2"	5.60	5.20	5
G29N-075	3/4" & 1"	8.50	7.70	5
G29N-125	1 1/4" & 1 1/2"	14.40	13.10	5
G29N-200	2"	24.10	21.70	5
G29N-250	2 1/2"		50.00	1
G29N-300	3"		51.80	1
G29N-400	4"		141.70	1

G29F... GROUND JOINT FEMALE SPUD

Female Pipe				
G29F-050	1/2"	11.20	10.10	5
G29F-075	3/4"	13.10	11.80	5
G29F-100	1"	13.70	12.20	5
G29F-125	1 1/4"	22.40	20.20	5
G29F-150	1 1/2"	22.40	20.20	5
G29F-200	2"	25.80	23.10	5
G29F-250	2 1/2"		54.80	1
G29F-300	3"		72.30	1
G29F-400	4"		116.20	1

Part Number	Hose Size	PRICE EACH		Pkg Qty
		Loose	Std Pkg	

G29M... GROUND JOINT MALE SPUD

Male Pipe				
G29M-050	1/2"	\$13.00	\$11.70	5
G29M-075	3/4"	17.00	15.30	5
G29M-100	1"	19.70	17.60	5
G29M-125	1 1/4"	27.50	24.60	5
G29M-150	1 1/2"	31.80	28.50	5
G29M-200	2"	39.30	35.40	5

G29DS... GROUND JOINT DOUBLE SPUD

G29DS-050	1/2"	31.00	27.80	5
G29DS-075	3/4" & 1"	29.70	26.60	5
G29DS-125	1 1/4" & 1 1/2"	37.10	33.40	5
G29DS-200	2"	47.80	43.00	5
G29DS-300	3"		179.50	1

G2908N... FEMALE NPT TO GROUND JOINT ADAPTER c/w WING NUT

Female Pipe				
G2908N-075	3/4"		52.80	1
G2908N-100	1"		56.90	1

HOSE STEMS

G23S Stems feature long shanks for extra fitting retention, and collars for use with G29C interlocking clamps. Sizes up to and including 1" are carbon steel. Sizes above 1" are made from ductile iron. All G23S series stems are zinc plated.

Part Number	Pipe Size	Hose Size	PRICE EACH		Pkg Qty
			Loose	Std Pkg	

G23S... STEEL MALE NPT HOSE BARB



G23S-013-025	1/8"	1/4"	4.10	3.70	5
G23S-025-025	1/4"	1/4"	4.10	3.70	5
G23S-025-038	1/4"	3/8"	3.80	3.50	5
G23S-025-050	1/4"	1/2"	5.60	5.20	5
G23S-038-025	3/8"	1/4"	5.30	4.80	5
G23S-038-038	3/8"	3/8"	3.90	3.50	5
G23S-038-050	3/8"	1/2"	5.50	5.10	5
G23S-050-038	1/2"	3/8"	5.20	4.80	5
G23S-050-050	1/2"	1/2"	6.10	5.70	5
G23S-050-075	1/2"	3/4"	10.70	9.50	5
G23S-075-050	3/4"	1/2"	10.10	9.00	5
G23S-075-075	3/4"	3/4"	9.90	8.80	5
G23S-075-100	3/4"	1"	11.90	10.60	5
G23S-100-075	1"	3/4"	15.20	13.70	5
G23S-100-100	1"	1"	14.00	12.50	5
G23S-125-125	1 1/4"	1 1/4"	14.90	13.30	5
G23S-150-150	1 1/2"	1 1/2"	18.70	16.70	5
G23S-200-200	e2"	2"	26.50	24.00	5
G23S-250-250	2 1/2"	2 1/2"		48.20	1
G23S-300-300	3"	3"		59.60	1
G23S-400-400	4"	4"		109.00	1

G23C... CRIMP STYLE NPT HOSE BARB



G23C-038-050	3/8"	1/2"	\$9.50		
G23C-050-050	1/2"	1/2"	9.50		
G23C-075-075	3/4"	3/4"	13.30		
G23C-100-100	1"	1"	17.90		

Safety Note: G29CR Crimp Ferrules are to be used with G29SC Crimpable Ground Joint Stems only. For pipe thread, please use Pulsar 9600 Series Crimp Fittings.

G29C CLAMPS

G29C bolt clamps are designed to lock into the collars provided on G23S and G29S hose stems. This feature prevents fitting pull-out. G29C bolt clamps are plated ductile iron, having two, four, or even six bolts depending on size.

Part Number	Nom. Hose Size	Hose Min	O.D. Max	Cross Ref	Tighten Torque*	PRICE EACH		Pkg Qty
						Loose	StdPkg	

G29C... BOLT CLAMPS

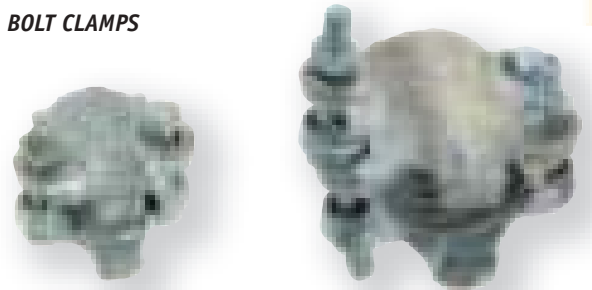

G29C-038	3/8"	0.69"	0.88"	CD	6	\$5.70	\$5.30	5
G29C-050AA	1/2"	0.81"	0.94"	DD	6	6.00	5.60	5
G29C-050A	1/2"	0.94"	1.06"	B4	12	6.00	5.60	5
G29C-050B	1/2"	1.06"	1.19"	B5	12	6.70	5.90	5
G29C-075AA	3/4"	1.16"	1.28"	BU9S	21	7.40	6.80	5
G29C-075A	3/4"	1.19"	1.31"	BU9	21	7.40	6.80	5
G29C-075B	3/4"	1.31"	1.50"	B9	21	8.80	8.10	5
G29C-075C	3/4"	1.50"	1.69"	B10	21	10.20	9.10	5
G29C-100AA	1"	1.41"	1.56"	156	21	13.00	11.80	5
G29C-100A	1"	1.53"	1.72"	BU14	21	13.00	11.80	5
G29C-100B	1"	1.63"	1.84"	B14	21	13.60	12.20	5
G29C-100C	1"	1.88"	2.06"	B15	21	17.40	15.60	5
G29C-125	1 1/4"	2.06"	2.25"	B19	40	19.80	17.60	5
G29C-150AAA	1 1/2"	1.81"	2.00"	BU22	40	21.60	19.40	5
G29C-150AA	1 1/2"	2.00"	2.22"	B22	40	21.60	19.40	5
G29C-150A	1 1/2"	2.09"	2.28"	BU24	40	23.10	20.80	5
G29C-150B	1 1/2"	2.25"	2.44"	B24	40	23.10	20.80	5
G29C-150C	1 1/2"	2.47"	2.72"	B25	60	27.20	24.50	5
G29C-200AA	2"	2.34"	2.53"	BU28	60	28.20	25.30	5
G29C-200A	2"	2.50"	2.78"	BU29	60	28.20	25.30	5
G29C-200B	2"	2.75"	3.06"	B29	60	34.10	30.60	5
G29C-200C	2"	3.09"	3.44"	B30	150	57.20	51.40	5
G29C-250	2 1/2"	3.50"	3.94"	B34	150		57.80	1
G29C-300AA	3"	3.50"	3.94"	BU35	150		57.20	1
G29C-300A	3"	3.81"	4.19"	B35	200		59.60	1
G29C-400AA	4"	4.25"	4.81"	BS39	200		189.30	1

* Recommended tightening torque for dry (un-lubricated) bolts in ft. lbs.

G29CR crimp ferrules are designed to interlock with our G29SC ground joint hose stems and allow for a crimpable ground joint steam hose option. G29CR crimp ferrules are all plated steel.

Part Number	Nom. Size	Ferrule I.D.	Ferrule Length	PRICE EACH		Pkg Qty
				Loose	Std Pkg	

G29CR... STEAM HOSE CRIMP FERRULES



G29CR-075	3/4"	1.252"	2.465"	\$10.20		1
G29CR-100	1"	1.562"	2.618"	17.40		1
G29CR-200	2"	2.689"	4.000"	34.10		1

MINING HOSE FITTINGS

FOUR-LUG UNIVERSAL FITTINGS

Part Number	Pipe Size	Hose Size	PRICE EACH		Pkg Qty
			Loose	Std Pkg	

G19S... FEMALE STEM

G19 series fittings are unique to the mining industry and are not typically found in other applications. Our mining fittings are made from plated steel.



G19S-050-050	1/2"	1/2"	\$5.30	\$4.60	10
G19S-100-050	1"	1/2"	6.60	5.90	10
G19S-100-075	1"	3/4"	7.80	7.00	10
G19S-100-100	1"	1"	6.40	5.70	10
G19S-125-125	1 1/4"	1 1/4"	18.20	16.60	10
G19S-150-150	1 1/2"	1 1/2"	23.00	20.70	10
G19S-200-200	2"	2"	37.70	34.50	10

G19N... HEX NUT



	Pipe Size				
G19N-050	1/2"	4.50	4.00	10	
G19N-100*	1"	4.90	4.30	10	
G19N-125	1 1/4"	11.90	10.70	10	
G19N-150	1 1/2"	17.90	16.10	10	
G19N-200	2"	24.60	22.00	10	

* The 1" hex nut is used with G19S-100-050, -100-075, and -100.

G19F... FEMALE SPUD



	Female Pipe	Male Pipe			
G19F-038-100	3/8"	1"	10.00	9.00	10
G19F-075-100	3/4"	1"	10.00	9.00	10
G19F-100-100	1"	1"	12.60	11.40	10

G19DS... MINING HOSE UNION



	Pipe Size			
G19DS-100	1"	5.60	5.00	10

Four lug universals are still occasionally found in pulp mill wash-down and other mill applications. As with standard universals, they should be used with safety clips.

Not recommended for steam or compressed air service.

Part Number	Hose Size	Material	PRICE EACH		Pkg Qty
			Loose	Std Pkg	

G25... FOUR-LUG UNIVERSAL HOSE END

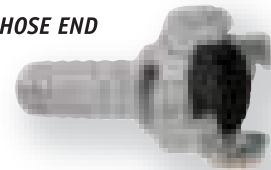

G25-125	1 1/4"	Plated iron	\$16.40	\$14.70	10
G25-150	1 1/2"	Plated iron	18.90	17.00	10
G25-200	2"	Plated iron	22.60	20.40	10

G27... FOUR-LUG FEMALE PIPE ADAPTER



	Pipe Size				
G27-125	1 1/4"	Plated iron	17.40	15.60	10
G27-150	1 1/2"	Plated iron	17.40	15.60	10
G27-200	2"	Plated iron	17.40	15.60	10

G28... FOUR-LUG GASKET



G28-125	1 1/4" Standard gasket	2.30	2.00	
---------	------------------------	------	------	--

Hoses can whip if they become accidentally uncoupled or tear away from the fitting. G29R safety cables act to control whipping in the event of a failure. To function properly, restraint cables must be installed in a fully extended position with no slack.

Part No.	Description	PRICE EACH
----------	-------------	------------

G29R... HOSE RESTRAINT CABLES



G29R-125	1/8" Cable for 1/2" to 1 1/4" Hose	\$13.30
G29R-300	1/4" Cable for 1 1/2" to 3" Hose	22.30

G29WS... WHIP SOCK HOSE RESTRAINT



G29WS-200

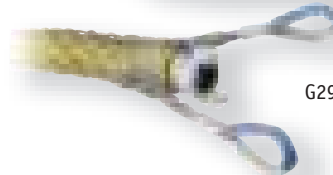

G29WS-100



G29WS

Whip Socks slide over air hose and attach to the compressor to control whipping if the hose tears away from the fittings.

G29WS-100	Fits hose O.D.s from 1.18" to 1.57"	143.40
G29WS-200	Fits hose O.D.s from 2.36" to 2.76"	195.60
G29SH-038	3/8" safety shackle for whip socks	19.60

Universal fittings are designed to offer a quick connection on air hoses, typically for jackhammer and similar applications. To ensure that couplings are fully connected, and to prevent accidental disconnection, safety clips should always be used. Universal couplings are rated to 110 psi under Mil. Spec. A-A-59553, however our two lug universals will handle 150 psi air or water. These fittings are not designed for steam service.

Part Number	Hose Size	IMPA Code	PRICE Loose	EACH Std Pkg	Pkg Qty
-------------	-----------	-----------	-------------	--------------	---------

G25... UNIVERSAL HOSE END

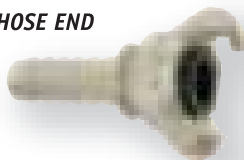

G25-038	3/8"	35-10-21	\$4.00	\$3.60	10
G25-050	1/2"	35-10-22	4.00	3.60	10
G25-075	3/4"	35-10-23	4.30	3.90	10
G25-100	1"	35-10-24	5.20	4.60	10

G25C... UNIVERSAL HOSE END WITH CRIMP FERRULE

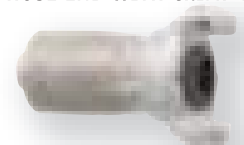

	Fits Hose O.D.				
G25C-050	1/2"	0.84"-1.03"	8.30	8.10	10
G25C-075	3/4"	1.06"-1.34"	9.30	9.00	10
G25C-100	1"	1.28"-1.53"	10.20	9.80	10
G25C-101	1"	1.46"-1.71"	10.20	9.80	10

G26... UNIVERSAL MALE PIPE ADAPTER

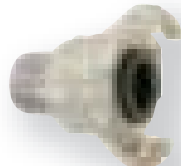

	Pipe Size				
G26-025	1/4"		11.20	10.20	10
G26-038	3/8"	35-10-26	5.30	4.80	10
G26-050	1/2"	35-10-27	4.80	4.30	10
G26-075	3/4"	35-10-28	5.10	4.50	10
G26-100	1"	35-10-29	5.60	5.10	10

G27... UNIVERSAL FEMALE PIPE ADAPTER



G27-025	1/4"		8.50	7.80	10
G27-038	3/8"	35-10-31	4.90	4.30	10
G27-050	1/2"	35-10-32	4.50	4.00	10
G27-075	3/4"	35-10-33	4.70	4.20	10
G27-100	1"	35-10-34	5.30	4.70	10

G28C... CAP

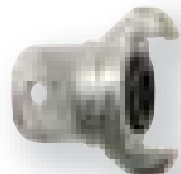

G28C	Cap		9.10	8.10	5
------	-----	--	------	------	---

Part Number		PRICE Loose	EACH Std Pkg	Pkg Qty
-------------	--	-------------	--------------	---------

G28Y... THREE-WAY CONNECTOR



G28Y	Three-way connector	\$12.10	\$10.80	5
------	---------------------	---------	---------	---

G28... UNIVERSAL FITTING ACCESSORIES



G28



G28L



G28P

G28	Standard gasket	0.50	0.40	50
G28L	Lanyard	0.40	0.20	50
G28P	Oil resistant gasket	1.30	1.10	50



G28SC



G28SP

G28SC	Safety clip	0.30	0.20	50
G28SP	Heavy duty safety pin	2.70	2.30	25

G25B... BRONZE UNIVERSAL HOSE END

Hose Size

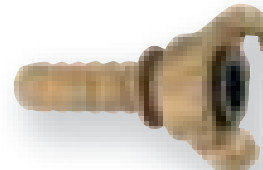

G25B-038	3/8"	18.20	16.40	10
G25B-050	1/2"	15.10	13.40	10
G25B-075	3/4"	18.80	17.00	10
G25B-100	1"	22.90	20.70	10

G26B... BRONZE UNIVERSAL MALE PIPE ADAPTER



G26B-025	1/4"	19.40	17.70	10
G26B-050	1/2"	17.40	15.60	10
G26B-075	3/4"	20.20	18.20	10
G26B-100	1"	21.70	19.50	10

G27B... BRONZE UNIVERSAL FEMALE PIPE ADAPTER



G27B-038	3/8"	19.40	17.50	10
G27B-050	1/2"	18.40	16.50	10
G27B-075	3/4"	18.40	16.50	10
G27B-100	1"	22.70	20.60	10

DOUBLE-LOCK QUICK ACTING COUPLINGS

Double-Lock Couplings offer maximum protection against accidental disconnection. All hose ends feature locking sleeves. To disconnect, the sleeve must be pulled back and the fitting rotated at the same time. For even additional protection, users can insert a spring-lock clip into the coupling that must be removed to allow disconnection. Brass fittings are available on special order.

Part Number	Hose Size	Material	PRICE EACH		Pkg Qty
			Loose	Std Pkg	

G15L... DOUBLE-LOCK HOSE END



G15L-038	3/8"	Steel	\$39.00	\$35.20	10
G15L-050	1/2"	Steel	39.00	35.20	10
G15L-075	3/4"	Steel	41.30	37.30	10
G15L-100	1"	Steel	54.20	48.80	10

G16... DOUBLE-LOCK MALE PIPE ADAPTER



	Pipe Size				
G16-038	3/8"	Steel	21.90	19.80	10
G16-050	1/2"	Steel	21.50	19.40	10
G16-075	3/4"	Steel	22.50	20.20	10
G16-100	1"	Steel	25.30	22.80	10

G16L... DOUBLE-LOCK MALE W/LOCKING SLEEVE



G16L-038	3/8"	Steel	37.00	33.30	10
G16L-050	1/2"	Steel	36.90	33.20	10
G16L-075	3/4"	Steel	36.90	33.20	10

G17... DOUBLE-LOCK FEMALE PIPE ADAPTER

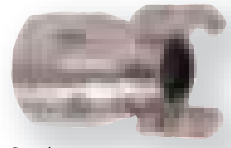

G17-038	3/8"	Steel	25.20	22.70	10
G17-050	1/2"	Steel	27.20	24.70	10
G17-075	3/4"	Steel	27.50	24.80	10
G17-100	1"	Steel	29.80	26.90	10

G17L... DOUBLE-LOCK FEMALE W/LOCKING SLEEVE



G17L-050	1/2"	Steel	42.00	37.80	10
G17L-075	3/4"	Steel	42.00	37.80	10

G18... GASKETS & SPRING LOCKS



G18



G18SL



G18V

G18	Standard gasket	2.40	2.20	50
G18SL	Spring locking clip	2.00	1.90	10
G18V	Viton gasket	5.70	5.30	50

TWIST-LOCK COUPLINGS

Twist-Lock couplings are fast and easy to use but provide maximum protection against accidental disconnection. They easily connect with a simple push and twist assisted by locking grooves on the sleeve body. Twist-Lock couplings seal at positive pressures as low as 10 psi to a maximum operating pressure of 300 psi and can be interchanged with similar Bowes and National products. The oil-resistant nitrile rubber gasket fits any size coupling and expands to prevent costly air leaks. These zinc plated couplings provide full air flow for efficient tool operation.

Part Number	Hose Size	PRICE EACH		Pkg Qty
		Loose	Std Pkg	

G45M... MALE COUPLER TO HOSE END

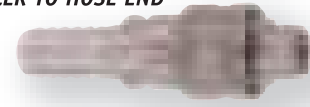

G45M-038	3/8"	\$27.10	\$24.60	10
G45M-050	1/2"	26.60	24.00	10
G45M-075	3/4"	26.60	24.00	10

G46M... MALE COUPLER TO MALE PIPE ADAPTER



	Pipe Size			
G46M-050	1/2"	27.50	24.80	10
G46M-075	3/4"	27.50	24.80	10

G47M... MALE COUPLER TO FEMALE PIPE ADAPTER



G47M-038	3/8"	26.60	24.00	10
G47M-050	1/2"	26.60	24.00	10
G47M-075	3/4"	26.60	24.00	10

G45F... FEMALE COUPLER TO HOSE END

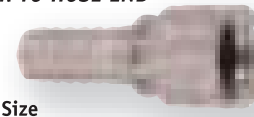

	Hose Size			
G45F-038	3/8"	21.50	19.40	10
G45F-050	1/2"	21.50	19.40	10
G45F-075	3/4"	21.50	19.40	10

G46F... FEMALE COUPLER TO MALE PIPE ADAPTER



	Pipe Size			
G46F-038	3/8"	21.50	19.40	10
G46F-050	1/2"	21.50	19.40	10
G46F-075	3/4"	21.50	19.40	10

G47F... FEMALE COUPLER TO FEMALE PIPE ADAPTER



G47F-038	3/8"	21.50	19.40	10
G47F-050	1/2"	21.50	19.40	10
G47F-075	3/4"	21.50	19.40	10

G48... TWIST-LOCK GASKET



G48		1.60	1.50	10
-----	--	------	------	----

NEW**PREMIUM HIGH-FLOW QUICK COUPLINGS****NEW**

Part Number	Cross Reference	Body Size	Thread Size	PRICE EACH		Pkg Qty
				Loose	Std Pkg	

INDUSTRIAL INTERCHANGE COUPLINGS**MALE PIPE THREAD COUPLER**

CH21	2DM2-B	1/4"	1/4"	\$15.90	\$14.50	10
CH21-03	2DM3-B	1/4"	3/8"	16.50	16.00	10
CH25	3DM3-B	3/8"	3/8"	27.20	24.50	10
CH29	4DF4-B	1/2"	1/2"	32.90	29.70	10

FEMALE PIPE THREAD COUPLER

CH20	2DF2-B	1/4"	1/4"	15.90	13.90	10
CH20-23	2DF3-B	1/4"	3/8"	16.50	16.20	10
CH26	3DF3-B	3/8"	3/8"	27.20	24.50	10
CH30	4DF4-B	1/2"	1/2"	33.60	30.30	10

HOSE BARB COUPLER

		Hose Size				
		1/4"	3/8"			
CH20-42	2DS2	1/4"	1/4"	16.75	14.50	10
CH20-44	2DS3	1/4"	3/8"	17.35	15.10	10

ARO INTERCHANGE COUPLINGS**MALE PIPE THREAD COUPLER**

CH37	2MM2-PL	1/4"	1/4"	15.90	13.90	10
CH37-03	2MM3-PL	1/4"	3/8"	16.50	16.20	10

FEMALE PIPE THREAD COUPLER

CH38	2MF2-PL	1/4"	1/4"	15.90	13.90	10
CH38-23	2MF3-PL	1/4"	3/8"	16.50	16.20	10

Part Number	Cross Reference	Body Size	Thread Size	PRICE EACH		Pkg Qty
				Loose	Std Pkg	

CEJN INTERCHANGE COUPLINGS**MALE PIPE THREAD COUPLER**

CH61	2CJM2-B	1/4"	1/4"	\$15.90	\$13.90	10
CH61-03	2CJM3-B	1/4"	3/8"	16.50	16.20	10

FEMALE PIPE THREAD COUPLER

CH60	2CJF2-B	1/4"	1/4"	\$15.90	\$13.90	10
CH60-23	2CJF3-B	1/4"	3/8"	16.50	16.20	10

If you're looking to cut down on compressed air costs, then our Premium High-Flow Quick Couplings may be your answer. The aerodynamic tapered valve found inside will allow greater air tool efficiency than our standard quick couplings. Featuring nickel-plated brass construction and color-coding for easy identification, the push-to-connect design allows for ease of connection under pressure while the identical plug profile allows interchange between corresponding standard and High-Flow couplings. Instead of going up in size, try our Premium High-Flow Couplings to get the most out of your air tools.

Aerodynamic valve allows for up to 40% higher flow than standard couplings*



*Note: Flow rates may vary by size and coupling series. The following table demonstrates high-flow capabilities.

Green Line Part #	Flow Rate at 90 psi
CH37 & CH38	28.3 cfm
C37 & C38	19.8 cfm
C37B & C38B	21.9 cfm

For more information on quick couplings and our Interchange Guide, visit us online at www.greenlinehose.com or see the Technical Information section of this catalog.

4

Quick Couplings

AUTOMOTIVE INTERCHANGE COUPLINGS

Our Automotive Interchange quick couplers have been designed for superior performance. These manual connect couplings are made from solid brass and steel bar stock. Stainless steel balls and springs maximize corrosion resistance. A tubular valve is standard for all body sizes for improved flow. Plugs are machined from solid steel and brass. Steel plugs are hardened and zinc plated to provide maximum service life.

4

Quick Couplings

Part Number	Cross Reference	Body Size	Thread Size	PRICE EACH		Pkg Qty
				Loose	Std Pkg	

MALE PIPE THREAD COUPLER

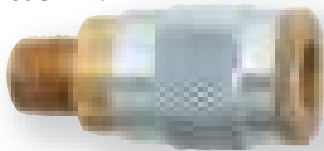

C1	2JM2-B	1/4"	1/4"	\$9.80	\$8.70	10
C1B (Brass)	2JM2-BS	1/4"	1/4"	12.80	11.90	10
C1-03	2JM3-B	1/4"	3/8"	12.70	11.70	10
C7	3JM2	3/8"	1/4"	21.10	18.80	10
C5	3JM3	3/8"	3/8"	20.50	18.30	10
C5-04	3JM4	3/8"	1/2"	26.50	23.70	10
C9-03	4FM3	1/2"	3/8"	29.40	26.40	5
C9	4FM4	1/2"	1/2"	23.10	20.90	5
C9-06	4FM6	1/2"	3/4"	33.30	30.10	5

FEMALE PIPE THREAD COUPLER



C2	2JF2-B	1/4"	1/4"	9.80	8.70	10
C2B (Brass)	2JF2-BS	1/4"	1/4"	12.80	11.70	10
C2-23	2JF3-B	1/4"	3/8"	12.70	11.40	10
C8	3JF2	3/8"	1/4"	20.60	18.40	10
C6	3JF3	3/8"	3/8"	19.40	17.40	10
C6-24	3JF4	3/8"	1/2"	26.90	24.30	10
C10-23	4FF3	1/2"	3/8"	26.00	23.50	5
C10	4FF4	1/2"	1/2"	24.60	22.20	5
C10-26	4FF6	1/2"	3/4"	32.00	29.20	5

HOSE BARB COUPLER



Part Number	Cross Reference	Body Size	Thread Size	PRICE EACH		Pkg Qty
				Loose	Std Pkg	
C2-42	2JS2-B	1/4"	1/4"	13.50	12.10	10
C2-42B (Brass)	2JS2-BS	1/4"	1/4"	16.10	14.40	10
C2-44	2JS3-B	1/4"	3/8"	14.20	12.70	10
C6-44	3JS3	3/8"	3/8"	22.40	20.20	10
C6-45	3JS4	3/8"	1/2"	26.40	23.70	10
C10-44	4FS3	1/2"	3/8"	31.80	28.60	5
C10-45	4FS4	1/2"	1/2"	29.30	26.40	5
C10-46	4FS6	1/2"	3/4"	31.20	28.10	5

Part Number	Cross Reference	Body Size	Thread Size	PRICE EACH		Pkg Qty
				Loose	Std Pkg	

MALE PIPE THREAD NIPPLE



CP1-01	J2M1	1/4"	1/8"	\$3.60	\$2.90	10
CP1	J2M2	1/4"	1/4"	2.30	2.00	10
CP1B	J2M2-B	1/4"	1/4"	3.40	2.70	10
CP1-03	J2M3	1/4"	3/8"	4.00	3.70	10
CP7	J3M2	3/8"	1/4"	3.90	3.50	10
CP5	J3M3	3/8"	3/8"	3.90	3.50	10
CP5-04	J3M4	3/8"	1/2"	7.20	6.70	10
CP9-03	J4M3	1/2"	3/8"	6.50	6.00	5
CP9	J4M4	1/2"	1/2"	6.30	5.80	5

FEMALE PIPE THREAD NIPPLE

Note: Couplers designated with suffix 'B' have brass valves



CP2	J2F2	1/4"	1/4"	2.50	2.20	10
CP2B (Brass)	J2F2-B	1/4"	1/4"	3.80	3.40	10
CP2-23	J2F3	1/4"	3/8"	4.90	4.30	10
CP8	J3F2	3/8"	1/4"	3.90	3.60	10
CP6	J3F3	3/8"	3/8"	4.80	4.20	10
CP10-23	J4F3	1/2"	3/8"	7.60	6.80	5
CP10	J4F4	1/2"	1/2"	7.70	7.10	5

HOSE BARB NIPPLE



Part Number	Cross Reference	Body Size	Thread Size	PRICE EACH		Pkg Qty
				Loose	Std Pkg	
CP1-42	J2S2	1/4"	1/4"	4.10	3.80	10
CP1-44	J2S3	1/4"	3/8"	4.30	4.00	10
CP5-42	J3S2	3/8"	1/4"	7.10	6.40	10
CP5-44	J3S3	3/8"	3/8"	6.10	5.70	10
CP5-45	J3S4	3/8"	1/2"	7.50	6.90	10
CP9-45	J4S4	1/2"	1/2"	9.10	8.50	5



For clamshell packaged parts add:
PAK to the part number.
Eg... C1:PAK, CP1:PAK, etc.

INDUSTRIAL INTERCHANGE COUPLINGS

Our Industrial Interchange quick couplings have been designed for superior performance. These manual connect couplings are made from solid brass and steel bar stock. Stainless steel balls and springs maximize corrosion resistance. A tubular valve is standard for all body sizes for improved flow. Plugs are machined from solid steel and brass. Steel plugs are hardened and zinc plated to provide maximum service life. This series conforms to the MIL-4109C Interchange Standard.

Note: Couplers designated with suffix 'B' have brass valves

Part Number	Cross Reference	Body Size	Thread Size	PRICE EACH	Pkg	Qty
				Loose	Std	

MALE PIPE THREAD COUPLER



C21	2FM2-B	1/4"	1/4"	\$9.50	\$8.60	10
C21B(Brass)	2FM2-BS	1/4"	1/4"	13.00	11.70	10
C21SS(Stainless)	2FM2-S	1/4"	1/4"		49.30	1
C21-03	2FM3-B	1/4"	3/8"	12.10	11.10	10
C21-03B(Brass)	2FM3-BS	1/4"	3/8"	14.70	13.30	10
C25-02	3FM2	3/8"	1/4"	19.90	17.70	10
C25	3FM3	3/8"	3/8"	19.90	17.70	10
C25-04	3FM4	3/8"	1/2"	24.50	22.20	10
C9-03	4FM3	1/2"	3/8"	29.40	26.40	5
C9	4FM4	1/2"	1/2"	23.10	20.90	5
C9-06	4FM6	1/2"	3/4"	33.30	30.10	5

FEMALE PIPE THREAD COUPLER



C20	2FF2-B	1/4"	1/4"	8.70	8.10	10
C20B(Brass)	2FF2-BS	1/4"	1/4"	13.50	12.60	10
C20SS(Stainless)	2FF2-S	1/4"	1/4"		53.10	1
C20-23	2FF3-B	1/4"	3/8"	11.90	11.00	10
C20-23B(Brass)	2FF3-BS	1/4"	3/8"	18.00	14.20	10
C26-22	3FF2	3/8"	1/4"	20.90	18.80	10
C26	3FF3	3/8"	3/8"	19.30	17.30	10
C26-24	3FF4	3/8"	1/2"	26.60	24.00	10
C10-23	4FF3	1/2"	3/8"	26.00	23.50	5
C10	4FF4	1/2"	1/2"	24.60	22.20	5
C10-26	4FF6	1/2"	3/4"	32.00	29.20	5

HOSE BARB COUPLER



Part Number	Cross Reference	Body Size	Hose Size	Thread Size	PRICE EACH	Pkg	Qty
					Loose	Std	
C20-42	2FS2-B	1/4"	1/4"	1/4"	12.60	11.30	10
C20-42B(Brass)	2FS2-BS	1/4"	1/4"	1/4"	17.10	13.30	10
C20-44	2FS3-B	1/4"	3/8"	3/8"	13.40	12.00	10
C20-44B(Brass)	2FS3-BS	1/4"	3/8"	3/8"	17.50	13.80	10
C26-42	3FS2	3/8"	1/4"	1/4"	24.30	21.80	10
C26-44	3FS3	3/8"	3/8"	3/8"	22.70	20.50	10
C26-45	3FS4	3/8"	1/2"	1/2"	22.60	20.40	10
C10-44	4FS3	1/2"	3/8"	3/8"	31.80	28.60	5
C10-45	4FS4	1/2"	1/2"	1/2"	29.30	26.40	5
C10-46	4FS6	1/2"	3/4"	3/4"	31.20	28.10	5

Part Number	Cross Reference	Body Size	Thread Size	PRICE EACH	Pkg	Qty
				Loose	Std	

MALE PIPE THREAD NIPPLE



CP21-01	D2M1	1/4"	1/8"	\$2.40	\$2.20	10
CP21	D2M2	1/4"	1/4"	2.20	2.00	10
CP21B(Brass)	D2M2-B	1/4"	1/4"	2.90	2.50	10
CP21SS(Stainless)	D2M2-S	1/4"	1/4"		9.90	1
CP21-03	D2M3	1/4"	3/8"	3.30	2.90	10
CP21-03B	D2M3-B	1/4"	3/8"	5.20	4.60	10
CP25-02	D3M2	3/8"	1/4"	3.90	3.60	10
CP25	D3M3	3/8"	3/8"	3.90	3.60	10
CP25-04	D3M4	3/8"	1/2"	7.10	6.50	10
CP17-02	D4M2	1/2"	1/4"	6.40	5.90	5
CP17-03	D4M3	1/2"	3/8"	6.00	5.50	5
CP17	D4M4	1/2"	1/2"	6.30	5.80	5
CP17-06	D4M6	1/2"	3/4"	11.20	10.40	5

FEMALE PIPE THREAD NIPPLE



CP20-21	D2F1	1/4"	1/8"	3.50	2.90	10
CP20	D2F2	1/4"	1/4"	2.40	2.10	10
CP20B(Brass)	D2F2-B	1/4"	1/4"	3.80	3.50	10
CP20SS(Stainless)	D2F2-S	1/4"	1/4"		12.50	1
CP20-23	D2F3	1/4"	3/8"	4.00	3.70	10
CP26-22	D3F2	3/8"	1/4"	4.90	4.30	10
CP26	D3F3	3/8"	3/8"	4.60	4.10	10
CP26-24	D3F4	3/8"	1/2"	7.20	6.50	10
CP18-23	D4F3	1/2"	3/8"	8.10	7.30	5
CP18	D4F4	1/2"	1/2"	7.60	6.90	5
CP18-26	D4F6	1/2"	3/4"	13.90	12.60	5

HOSE BARB NIPPLE



Part Number	Cross Reference	Body Size	Hose Size	Thread Size	PRICE EACH	Pkg	Qty
					Loose	Std	
CP21-42	D2S2	1/4"	1/4"	1/4"	3.90	3.60	10
CP21-42B(Brass)	D2S2-B	1/4"	1/4"	1/4"	4.60	4.20	10
CP21-43	D2S2.5	1/4"	5/16"	1/4"	5.10	3.90	10
CP21-44	D2S3	1/4"	3/8"	3/8"	4.10	3.80	10
CP21-44B(Brass)	D2S3-B	1/4"	3/8"	3/8"	5.40	4.90	10
CP25-42	D3S2	3/8"	1/4"	1/4"	7.50	6.90	10
CP25-44	D3S3	3/8"	3/8"	3/8"	5.80	5.40	10
CP25-45	D3S4	3/8"	1/2"	1/2"	7.80	7.30	10
CP17-44	D4S3	1/2"	3/8"	3/8"	8.10	7.30	5
CP17-45	D4S4	1/2"	1/2"	1/2"	7.20	6.50	5
CP17-46	D4S6	1/2"	3/4"	3/4"	12.80	11.40	5



For clamshell packaged parts add:
PAK to the part number.
Eg... C1:PAK, CP1:PAK, etc.

4

Quick Couplings

PUSH-TO-CONNECT INDUSTRIAL INTERCHANGE

UNIVERSAL QUICK COUPLINGS

This proprietary design allows automatic connect and pull to disconnect to accommodate one hand operation. Machined from solid brass bar stock. Stainless steel balls and springs maximize corrosion resistance. Tubular valve is standard in 1/4" body size, and prong valve standard in 3/8" & 1/2" body size. Push to connect couplers connect to industrial interchange nipples found on the previous page. They also conform to the MIL-4109C Interchange Standard.

Universal couplers are designed to accept the most common styles of 1/4" nipples; Automotive, Industrial, and Aro. These couplers also interchange with the European high-flow style offered by Cejn, OBAC, and Nitto. The design of this coupler combines the easy push-to-connect feature while still maintaining a sleeve coupler profile to prevent accidental disconnection when hoses are dragged.

Universal style couplings employ a different valve design than common North American parts that allows much higher air flow rates (see chart below).

4

Quick Couplings

Part Number	Cross Reference	Body Size	Thread Size	PRICE EACH Loose Std Pkg	Pkg Qty
-------------	-----------------	-----------	-------------	-----------------------------	---------

MALE PIPE THREAD COUPLER



B32	2DM2	1/4"	1/4"	\$15.40	\$13.60	5
B32E	2DM3	1/4"	3/8"	17.00	15.30	5
B34	3DM3	3/8"	3/8"	28.80	26.00	5
B36	4DM4	1/2"	1/2"	34.90	31.50	5

FEMALE PIPE THREAD COUPLER

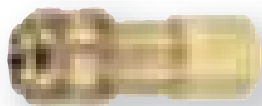

B33	2DF2	1/4"	1/4"	14.70	13.30	5
B33-SL*	2DF2-B-SL	1/4"	1/4"	21.30	19.30	5
B33E	2DF3	1/4"	3/8"	17.20	15.40	5
B35	3DF3	3/8"	3/8"	28.80	26.00	5
B37	4DF4	1/2"	1/2"	35.60	32.10	5

* This coupler has a sleeve lock to prevent accidental disconnection. It is commonly used on breathing air hose assemblies

HOSE BARB COUPLER



Part Number	Cross Reference	Body Size	Hose Size	Thread Size	PRICE EACH Loose Std Pkg	Pkg Qty	
B30-3B	2DS2	1/4"	1/4"	1/4"	15.40	13.90	5
B30-5B	2DS3	1/4"	3/8"	1/4"	16.00	14.30	5
B34-5B	3DS3	3/8"	3/8"	3/8"	29.90	27.00	5

Body size	Interchange Series	Air flow at 100 psi
-----------	--------------------	---------------------

1/4"	Automotive	37 CFM
	Industrial	37
	Aro	37
	Lincoln	35
3/8"	Cejn	70
	Automotive	70 CFM
	Industrial	70
1/2"	Aro	37
	Cejn	136

Part Number	Cross Reference	Body Size	Thread Size	PRICE EACH Loose Std Pkg	Pkg Qty
-------------	-----------------	-----------	-------------	-----------------------------	---------

MALE PIPE THREAD COUPLER



C61	2UM2-B	1/4"	1/4"	\$21.70	\$19.40	5
C61-03	2UM3-B	1/4"	3/8"	22.60	20.40	5
C65	3UM3-B	3/8"	3/8"	45.80	41.10	5

FEMALE PIPE THREAD COUPLER

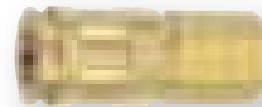

C60	2UF2-B	1/4"	1/4"	21.70	19.40	5
C60-23	2UF3-B	1/4"	3/8"	23.20	20.90	5
C66	3UF3-B	3/8"	3/8"	45.80	41.10	5

CEJN INTERCHANGE NIPPLES

The following nipples interchange with Cejn 320/410 European style fittings and in 1/4" body size, they have a locking groove that allows connection to Rectus 25KS series couplers. They will also connect to the Combo Couplers shown above.

MALE PIPE THREAD NIPPLE



CP61	CJ2M2-LG	1/4"	1/4"	4.60	4.10	5
CP61-03	CJ2M3-LG	1/4"	3/8"	5.80	5.40	5
CP65	CJ3M3	3/8"	3/8"	5.70	5.20	5

FEMALE PIPE THREAD NIPPLE



CP60	CJ2F2-LG	1/4"	1/4"	4.80	4.20	5
CP60-23	CJ2F3	1/4"	3/8"	6.00	5.50	5
CP66	CJ3F3	3/8"	3/8"	6.10	5.60	5



For clamshell packaged parts add:
PAK to the part number.
Eg... C1:PAK, CP1:PAK, etc.

ARO INTERCHANGE COUPLINGS

We stock ARO 210/310 style couplings in the traditional bar-lock push-to-connect style as well as a brass body version manual-connect design.

Part Number	Cross Reference	Body Size	Thread Size	PRICE EACH		Pkg Qty
				Loose	Std Pkg	

MALE PIPE THREAD COUPLER - AUTOMATIC



C37	2MM2-PL	1/4"	1/4"	\$13.30	\$11.90	10
C37-03	2MM3-PL	1/4"	3/8"	15.30	13.60	10
C35	3MM3-PL	3/8"	3/8"	28.60	25.90	10

MALE PIPE THREAD COUPLER - MANUAL



C37B	2MM2-B	1/4"	1/4"	12.50	11.30	10
C37-03B	2MM3-B	1/4"	3/8"	17.20	15.30	10

FEMALE PIPE THREAD COUPLER - AUTOMATIC



C38	2MF2-PL	1/4"	1/4"	12.50	11.20	10
C38-23	2MF3-PL	1/4"	3/8"	14.40	12.80	10
C36	3MF3-PL	3/8"	3/8"	27.70	25.00	10

FEMALE PIPE THREAD COUPLER - MANUAL



C38B	2MF2-B	1/4"	1/4"	11.90	10.70	10
------	--------	------	------	-------	-------	----

HOSE BARB COUPLER - AUTOMATIC



Part Number	Cross Reference	Body Size	Thread Size	Hose Size	PRICE EACH		Pkg Qty
					Loose	Std Pkg	
C38-42	2MS2-PL	1/4"	1/4"	1/4"	16.60	14.90	10
C38-44	2MS3-PL	1/4"	3/8"	3/8"	18.10	16.20	10

HOSE BARB COUPLER - MANUAL



C38-42B	2MS2-B	1/4"	1/4"	17.20	15.50	10
C38-44B	2MS3-B	1/4"	3/8"	19.70	17.50	10

Part Number	Cross Reference	Body Size	Thread Size	PRICE EACH		Pkg Qty
				Loose	Std Pkg	

MALE PIPE THREAD NIPPLE



CP37	M2M2	1/4"	1/4"	\$2.50	\$2.30	10
CP37-03	M2M3	1/4"	3/8"	5.40	4.80	10
CP35	M3M3	3/8"	3/8"	7.10	6.50	10

FEMALE PIPE THREAD NIPPLE



CP38	M2F2	1/4"	1/4"	2.40	2.20	10
CP38-23	M2F3	1/4"	3/8"	6.80	6.30	10
CP36	M3F3	3/8"	3/8"	7.50	6.90	10

HOSE BARB NIPPLE



Part Number	Cross Reference	Body Size	Thread Size	Hose Size	PRICE EACH		Pkg Qty
					Loose	Std Pkg	
CP37-42	M2S2	1/4"	1/4"	1/4"	4.60	4.20	10
CP37-44	M2S3	1/4"	3/8"	3/8"	5.70	5.10	10
CP35-44	M3S3	3/8"	3/8"	3/8"	10.40	9.30	10

LINCOLN INTERCHANGE COUPLINGS

Part Number	Cross Reference	Body Size	Thread Size	PRICE EACH		Pkg Qty
				Loose	Std Pkg	

MALE PIPE THREAD COUPLER



C27	2LM2	1/4"	1/4"	17.40	15.80	5
-----	------	------	------	-------	-------	---

FEMALE PIPE THREAD COUPLER



C28	2LF2	1/4"	1/4"	16.70	15.20	5
-----	------	------	------	-------	-------	---

MALE PIPE THREAD NIPPLE



CP27	L2M2	1/4"	1/4"	4.10	3.70	5
------	------	------	------	------	------	---

FEMALE PIPE THREAD NIPPLE



CP28	L2F2	1/4"	1/4"	4.20	3.80	5
------	------	------	------	------	------	---



For clamshell packaged parts add:
PAK to the part number.
Eg... C1:PAK, CP1:PAK, etc.

JAPANESE INTERCHANGE COUPLINGS

These quick couplers were developed in Japan and are often found in Japanese Automotive Manufacturing facilities.

Part Number	Body Size	Thread Size	PRICE EACH
-------------	-----------	-------------	------------

SM MALE PIPE THREAD COUPLER



20SM	1/4"	1/8"	\$12.30
30SM	1/4"	3/8"	12.30
40SM	1/4"	1/2"	16.30
400SM	1/2"	1/2"	45.10
600SM	1/2"	3/4"	49.00
800SM	1/2"	1"	68.20
20SM-SS	1/4" (Stainless)	1/4"	51.80
30SM-SS	1/4" (Stainless)	3/8"	53.40
40SM-SS	1/4" (Stainless)	1/2"	57.90
400SM-SS	1/2" (Stainless)	1/2"	99.10
600SM-SS	1/2" (Stainless)	3/4"	110.10
800SM-SS	1/2" (Stainless)	1"	168.90

Part Number	Body Size	Thread Size	PRICE EACH
-------------	-----------	-------------	------------

PM MALE PIPE THREAD NIPPLE



10PM	1/4"	1/8"	\$3.30
20PM	1/4"	1/8"	3.30
30PM	1/4"	3/8"	3.60
40PM	1/4"	1/2"	4.70
400PM	1/2"	1/2"	10.40
600PM	1/2"	3/4"	11.00
800PM	1/2"	1"	16.20
20PM-SS	1/4" (Stainless)	1/4"	11.10
30PM-SS	1/4" (Stainless)	3/8"	12.90
40PM-SS	1/4" (Stainless)	1/2"	17.20
400PM-SS	1/2" (Stainless)	1/2"	33.50
600PM-SS	1/2" (Stainless)	3/4"	40.50

SF FEMALE PIPE THREAD COUPLER



20SF	1/4"	1/4"	12.30
30SF	1/4"	3/8"	12.30
40SF	1/4"	1/2"	16.20
600SF	1/2"	3/4"	49.00
800SF	1/2"	1"	57.70
20SF-SS	1/4" (Stainless)	1/4"	51.80
30SF-SS	1/4" (Stainless)	3/8"	56.40
40SF-SS	1/4" (Stainless)	1/2"	60.90
400SF-SS	1/2" (Stainless)	1/2"	99.10
600SF-SS	1/2" (Stainless)	3/4"	110.10
800SF-SS	1/2" (Stainless)	1"	172.60

PF FEMALE PIPE THREAD NIPPLE

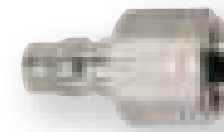

20PF	1/4"	1/4"	3.60
30PF	1/4"	3/8"	3.70
40PF	1/4"	1/2"	5.80
600PF	1/2"	3/4"	15.90
800PF	1/2"	1"	17.20
20PF-SS	1/4" (Stainless)	1/4"	13.10
30PF-SS	1/4" (Stainless)	3/8"	14.80
40PF-SS	1/4" (Stainless)	1/2"	19.90
400PF-SS	1/2" (Stainless)	1/2"	36.70
600PF-SS	1/2" (Stainless)	3/4"	38.20
800PF-SS	1/2" (Stainless)	1"	67.30

SH HOSE BARB COUPLER



Part Number	Body Size	Hose Size	PRICE EACH
20SH	1/4"	1/4"	12.30
30SH	1/4"	3/8"	12.30
40SH	1/4"	1/2"	16.30
400SH	1/2"	1/2"	45.10
600SH	1/2"	3/4"	49.00
800SH	1/2"	1"	56.40
20SH-SS	1/4" (Stainless)	1/4"	52.70
30SH-SS	1/4" (Stainless)	3/8"	55.70
40SH-SS	1/4" (Stainless)	1/2"	59.00
400SH-SS	1/2" (Stainless)	1/2"	102.90
600SH-SS	1/2" (Stainless)	3/4"	106.60
800SH-SS	1/2" (Stainless)	1"	172.60

PH HOSE BARB NIPPLE



Part Number	Body Size	Hose Size	PRICE EACH
20PH	1/4"	1/4"	3.50
30PH	1/4"	3/8"	3.50
40PH	1/4"	1/2"	4.40
400PH	1/2"	1/2"	10.40
600PH	1/2"	3/4"	11.00
20PH-SS	1/4" (Stainless)	1/4"	13.20
30PH-SS	1/4" (Stainless)	3/8"	13.90
40PH-SS	1/4" (Stainless)	1/2"	17.40
400PH-SS	1/2" (Stainless)	1/2"	36.70
600PH-SS	1/2" (Stainless)	3/4"	42.70
800PH-SS	1/2" (Stainless)	1"	62.00

4

Quick Couplings

INJECTION MOLD COUPLINGS

Injection mold couplings provide quick coupling for cooling and heating hoses used on injection molding equipment. In 1/2" size these couplers are gaining popularity for glycol connections to drive units on progressive cavity jack pumps.

They are machined from solid brass bar stock. Stainless steel balls, retaining ring, and spring provide maximum service life. A high temperature silicone seal is standard. Plugs are machined from solid brass and steel bar stock. Steel plugs are zinc plated for superior corrosion resistance. Mold couplings are usually installed by adding G21B or G2016 hose barb fittings - see Brass Section of this Catalog. Where coupler must be valved, the valve and spring are inserted and retained when the hose barb or other fitting is attached.

Part Number	Cross Reference	Body Size	NPT Size	PRICE EACH	Pkg Qty
-------------	-----------------	-----------	----------	------------	---------

BRASS UN-VALVED COUPLER



2CMF1-B-E		1/4"	1/8"	\$8.10	1
4CMF4-B-E		1/2"	1/2"	23.30	1

BRASS UN-VALVED COUPLER, MALE PIPE THREAD



4CMM4-B-E		1/2"	1/2"	26.60	1
-----------	--	------	------	-------	---

BRASS VALVED COUPLER

2CMF1-B		1/4"	1/8"	8.70	1
---------	--	------	------	------	---

PLATED STEEL FEMALE PIPE THREAD NIPPLE



CM2F1		1/4"	1/8"	1.90	1
CM2F2		1/4"	1/4"	2.00	1
CM2F3		1/4"	3/8"	2.40	1

BRASS FEMALE PIPE THREAD NIPPLE



CM4F4-B		1/2"	1/2"	7.50	1
---------	--	------	------	------	---

BRASS MALE PIPE THREAD NIPPLE



CM2M1-B		1/4"	1/8"	1.70	1
CM2M2-B		1/4"	1/4"	1.80	1
CM2M3-B		1/4"	3/8"	2.20	1
CM4M4-B		1/2"	1/2"	4.80	1

GARDEN HOSE COUPLINGS

Our garden hose quick couplings are the heavy-duty answer to plastic and brass residential garden hose quick disconnects. They are a straight-through (no shut-off) design and feature brass bodies with garden hose threads.

Part Number	Description	PRICE EACH		Pkg Qty
		Loose	Std Pkg	

GARDEN HOSE FEMALE COUPLER



CST-GHTB	GHT	\$6.70	\$6.00	5
----------	-----	--------	--------	---

GARDEN HOSE MALE NIPPLE



CPST-GHTB	GHT	4.60	4.10	5
CST-G	Replacement gasket	0.30	0.26	5

KEW STYLE PRESSURE WASH COUPLINGS

Part Number	Description	PRICE EACH
-------------	-------------	------------

CST-KEW BSP COUPLING SET

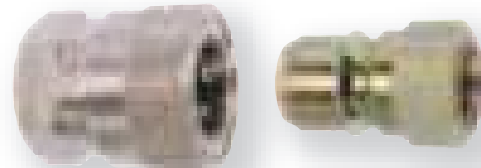

CST-KEW	Coupler & nipple with 3/8" BSP threads	\$185.40
CST-KEWC	Coupler only	123.50
CPST-KEW	Nipple only	61.90

WATERBLAST COUPLINGS

Part Number	Cross Reference	Size	PRICE EACH
-------------	-----------------	------	------------

COUPLER 10,000 PSI



CST-WB	4EAF4	1/2"	179.50
--------	-------	------	--------

NIPPLE 10,000 PSI

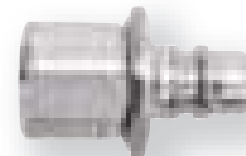

CPST-WB	EA4F4	1/2"	48.50
---------	-------	------	-------

STRAIGHT-THROUGH COUPLINGS

These manual connect and disconnect couplings are commonly used in fluid transfer applications where unrestricted flow and high operating pressures are desired. In 1/2" size these couplers are also gaining popularity for glycol connections to drive units of progressive cavity jack pumps.

Couplers are machined from solid brass and 303 stainless steel bar stock. Stainless steel balls, retaining ring, and spring provide maximum service life. Plugs are machined from solid brass, steel, and 303 stainless steel bar stock. Steel plugs are hardened and zinc plated for maximum service life.

4

Quick Couplings

Part Number	Cross Reference	Size	PRICE EACH		Pkg Qty
			Loose	Std Pkg	

BRASS MALE PIPE COUPLER



CST1B	1EM1-B	1/8"	\$10.00	\$9.00	5
CST3B	2EM2	1/4"	7.80	7.10	5
CST5B	3EM3	3/8"	8.40	8.00	5
CST7B	4EM4	1/2"		15.60	1
CST9B	6EM6	3/4"		32.00	1
CST11B	8EM8	1"		48.10	1

STAINLESS STEEL MALE PIPE COUPLER



CST1SS	1EM1-S	1/8"		38.20	1
CST3SS	2EM2-S	1/4"		15.80	1
CST5SS	3EM3-S	3/8"		19.20	1
CST7SS	4EM4-S	1/2"		63.90	1

BRASS FEMALE PIPE COUPLER



CST2B	1EF1-B	1/8"	10.00	9.00	5
CST4B	2EF2	1/4"	7.30	6.80	5
CST6B	3EF3	3/8"	8.10	7.30	5
CST8B	4EF4	1/2"		16.70	5
CST10B	6EF6	3/4"		29.70	1
CST12B	8EF8	1"		44.90	1

STAINLESS STEEL FEMALE PIPE COUPLER



CST2SS	1EF1-S	1/8"		38.20	1
CST4SS	2EF2-S	1/4"		13.50	1
CST6SS	3EF3-S	3/8"		16.00	1
CST8SS	4EF4-S	1/2"		67.70	1

BRASS HOSE BARB COUPLER



CSTH6B	3ES3-B	3/8"		18.80	1
CSTH8B	4ES4-B	1/2"		24.60	1
CSTH10B	6ES6-B	3/4"		36.30	1
CSTH12B	8ES8-B	1"		50.50	1

G11 REPLACEMENT O-RINGS



	Coupler Size	Material	PRICE EACH		Qty
			Loose	Std Pkg	
G11-N70-110	1/4"	Nitrile	0.23	0.20	10
G11-N70-112	3/8"	Nitrile	0.23	0.20	10
G11-N70-114	1/2"	Nitrile	0.23	0.20	10
G11-V-110	1/4"	FPM (Viton®)	0.95	0.90	10
G11-V-112	3/8"	FPM (Viton®)	1.05	0.95	10
G11-V-114	1/2"	FPM (Viton®)	1.15	1.09	10

Nitrile o-rings are rated for use up to 130°C (266°F)
FPM (Viton®) o-rings are rated up to 200°C (392°F)

Part Number	Cross Reference	Size	PRICE EACH		Pkg Qty
			Loose	Std Pkg	

PLATED STEEL MALE NIPPLE



CPST1	E1M1	1/8"	\$4.30	\$4.00	5
CPST3	E2M2	1/4"	2.20	2.00	5
CPST5	E3M3	3/8"	2.40	2.20	5
CPST7	E4M4	1/2"		5.60	1
CPST9	E6M6	3/4"		12.70	1
CPST11	E8M8	1"		25.80	1

BRASS MALE NIPPLE



CPST1B	E1M1-B	1/8"	3.00	2.70	5
CPST3B	E2M2-B	1/4"	3.60	3.30	5
CPST5B	E3M3-B	3/8"	4.50	4.10	5
CPST7B	E4M4-B	1/2"		6.10	1
CPST9B	E6M6-B	3/4"		12.00	1
CPST11B	E8M8-B	1"		24.90	1

STAINLESS STEEL MALE NIPPLE



CPST1SS	E1M1-SS	1/8"		18.10	1
CPST3SS	E2M2-S	1/4"		5.10	1
CPST5SS	E3M3-S	3/8"		7.80	1
CPST7SS	E4M4-S	1/2"		36.90	1

PLATED STEEL FEMALE NIPPLE



CPST2	E1F1	1/8"	4.00	3.70	5
CPST4	E2F2	1/4"	2.20	2.00	5
CPST6	E3F3	3/8"	2.50	2.20	5
CPST8	E4F4	1/2"		5.50	1
CPST10	E6F6	3/4"		14.30	1
CPST12	E8F8	1"		25.80	1

BRASS FEMALE NIPPLE



CPST2B	E1F1-B	1/8"	3.20	2.80	5
CPST4B	E2F2-B	1/4"	4.00	3.70	5
CPST6B	E3F3-B	3/8"	4.30	3.90	5
CPST8B	E4F4-B	1/2"		6.70	1
CPST10B	E6F6-B	3/4"		12.00	1
CPST12B	E8F8-B	1"		25.00	1

STAINLESS STEEL FEMALE NIPPLE



CPST2SS	E1F1-SS	1/8"		17.70	1
CPST4SS	E2F2-S	1/4"		6.50	1
CPST6SS	E3F3-S	3/8"		7.60	1
CPST8SS	E4F4-S	1/2"		36.30	1

PROPANE COUPLINGS

Our Propane Quick Coupler product line is CSA certified for Natural Gas and LP Gas. We carry low pressure couplings perfect for outdoor gas appliances such as barbecue grills, patio heaters, and fire pits as well as high pressure couplings in 1/4" for torches and weed burners.

Part Number	Cross Reference	Body Size	Thread Size	PRICE EACH Std Pkg	Pkg Qty
-------------	-----------------	-----------	-------------	-----------------------	---------

C632... FEMALE PIPE THREAD COUPLER



C632-04	104068	1/4"	1/4"	\$27.50	1
C632-06	104406	3/8	3/8	33.40	1
C632-08	104088	1/2	1/2	45.40	1
C632-12	104089	3/4	3/4	61.30	1

C632HP... HIGH PRESSURE FEMALE PIPE THREAD COUPLER

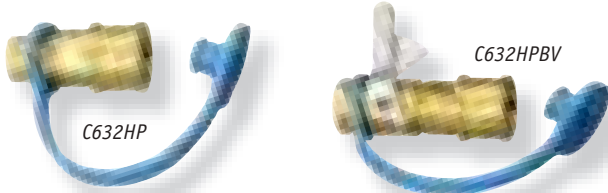

C632HP-04	104061	1/4	1/4	27.60	1
C632HPBV-04	104057	1/4	1/4	30.70	1

C638... DUST PLUG

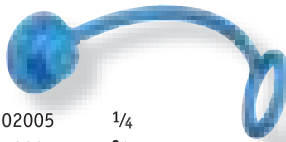

C638-04	302005	1/4		3.20	1
C638-06	302001	3/8		4.30	1
C638-08	302039	1/2		5.20	1
C638-12	302042	3/4		5.90	1

C639... DUST CAP

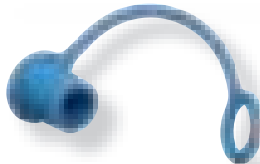

C639-06	302001	3/8		4.30	1
C639-08	302038	1/2		5.20	1
C639-12	302041	3/4		5.90	1

Size	Max Pressure Rating (Natural Gas)	Max Flow Capacity (at 1/2 psi Natural Gas)
------	--------------------------------------	---

Low Pressure Couplings

1/4"	1/2 psi	19,000 BTU
3/8	1/2	60,000
1/2	1/2	170,000
3/4	1/2	270,000

High Pressure Couplings

1/4	1/2 (250 psi LP Gas)	19,000 (50,000 BTU at 1/2 psi LP Gas)
-----	-------------------------	--



4

Quick Couplings

Part Number	Cross Reference	Body Size	Thread Size	PRICE EACH Std Pkg	Pkg Qty
-------------	-----------------	-----------	-------------	-----------------------	---------

CP632M... MALE PIPE THREAD NIPPLE



CP632M-04	401132	1/4"	1/4"	\$6.60	1
-----------	--------	------	------	--------	---

CP632... FEMALE PIPE THREAD NIPPLE



CP632-06	401207	3/8	3/8	19.30	1
CP632-08	401506	1/2	1/2	21.40	1
CP632-12	401606	3/4	3/4	52.40	1

CP632HPM... HIGH PRESSURE MALE PIPE THREAD NIPPLE



CP632HPM-04	401111	1/4	1/4	6.60	1
-------------	--------	-----	-----	------	---

CP632HP-POL... HIGH PRESSURE POL THREAD NIPPLE



CP632HP-POL	401148	1/4	POL	11.20	1
-------------	--------	-----	-----	-------	---

C100 couplings are compliant with the ISO-7241-B standard. They also interchange with the following Manufacturer's: Snavtite 72, Hansen HK, Parker 60, Faster HNV, & Areoquip FD45. Larger sleeves on this manual connect and disconnect provide rugged resistance to deformation. Steel sleeves are hardened to provide maximum service life. Machined from solid brass, steel, and 303 stainless steel bar stock. Stainless steel balls, retaining rings, and springs provide maximum service life. Steel and stainless steel units incorporate a Teflon back-up ring to withstand dynamic impulse. A backup o-ring seal is standard in all brass and 1 1/4" size units and above. Buna-N (Nitrile) seals are standard. Steel Plugs are hardened and zinc plated to provide heavy duty performance.

4

Quick Couplings

Part Number	Cross Reference	Body Size	Female NPTF	PRICE EACH		Pkg Qty
				Loose	Std Pkg	
C101... PLATED STEEL COUPLER						
C101-02	1HF1	1/8"	1/8"	\$25.20	\$22.70	5
C101-04	2HF2	1/4"	1/4"	20.10	18.20	5
C101-06	3HF3	3/8"	3/8"	23.50	21.00	5
C101-08	4HF4	1/2"	1/2"	35.60	31.90	5
C101-12	6HF6	3/4"	3/4"		47.90	1
C101-16	8HF8	1"	1"		69.00	1
C101-24	12HF12	1 1/2"	1 1/2"		413.00	1



C101L... PLATED STEEL COUPLER WITH LOCKING SLEEVE						
C101L-04	2HF2-LS	1/4"	1/4"		27.70	1
C101L-06	3HF3-LS	3/8"	3/8"		37.50	1
C101L-08	4HF4-LS	1/2"	1/2"		42.70	1
C101L-12	6HF6-LS	3/4"	3/4"		68.30	1
C101L-16	8HF8-LS	1"	1"		102.50	1

C101B... BRASS COUPLER						
C101B-02	1HF1B	1/8"	1/8"	24.10	21.70	5
C101B-04	2HF2B	1/4"	1/4"	24.20	21.80	5
C101B-06	3HF3B	3/8"	3/8"	34.80	31.30	5
C101B-08	4HF4B	1/2"	1/2"	53.20	47.90	5
C101B-12	6HF6B	3/4"	3/4"		77.20	1
C101B-16	8HF8B	1"	1"		109.20	1

C101BL... BRASS COUPLER WITH LOCKING SLEEVE						
C101BL-04	2HF2B-LS	1/4"	1/4"	31.30	28.50	5
C101BL-06	3HF3B-LS	3/8"	3/8"	40.20	36.60	5

C101SS... TYPE 303 STAINLESS STEEL COUPLER*						
C101SS-02	1HF1-SS	1/8"	1/8"	65.60		1
C101SS-04	2HF2-SS	1/4"	1/4"	61.90		1
C101SS-06	3HF3-SS	3/8"	3/8"	87.00		1
C101SS-08	4HF4-SS	1/2"	1/2"	138.00		1
C101SS-12	6HF6-SS	3/4"	3/4"	224.30		1
C101SS-16	8HF8-SS	1"	1"	358.10		1

*Also available in Type 316 Stainless Steel. Please inquire for pricing.

C101SSL... STAINLESS COUPLER WITH LOCKING SLEEVE						
C101SSL-04	2HF2-LSS	1/4"	1/4"	67.30		1
C101SSL-06	3HF3-LSS	3/8"	3/8"	92.60		1

Part Number	Cross Reference	Body Size	Female NPTF	PRICE EACH		Pkg Qty
				Loose	Std Pkg	

C102... PLATED STEEL NIPPLE

C102-02	H1F1	1/8"	1/8"	\$10.40	\$9.60	5
C102-04	H2F2	1/4"	1/4"	8.60	7.60	5
C102-06	H3F3	3/8"	3/8"	10.90	9.80	5
C102-08	H4F4	1/2"	1/2"	13.00	11.40	5
C102-12	H6F6	3/4"	3/4"		24.10	1
C102-16	H8F8	1"	1"		34.50	1
C102-24	H12F12	1 1/2"	1 1/2"		314.70	1



C102B... BRASS NIPPLE

C102B-02	H1F1-B	1/8"	1/8"	11.10	9.90	5
C102B-04	H2F2-B	1/4"	1/4"	13.10	11.80	5
C102B-06	H3F3-B	3/8"	3/8"	16.80	15.00	5
C102B-08	H4F4-B	1/2"	1/2"	21.80	19.80	5
C102B-12	H6F6-B	3/4"	3/4"		28.00	1
C102B-16	H8F8-B	1"	1"		44.80	1

C102SS... TYPE 303 STAINLESS STEEL NIPPLE*

C102SS-02	H1F1-SS	1/8"	1/8"		25.70	1
C102SS-04	H2F2-SS	1/4"	1/4"		25.40	1
C102SS-06	H3F3-SS	3/8"	3/8"		41.60	1
C102SS-08	H4F4-SS	1/2"	1/2"		67.30	1
C102SS-12	H6F6-SS	3/4"	3/4"		100.50	1
C102SS-16	H8F8-SS	1"	1"		159.10	1

*Also available in Type 316 Stainless Steel. Please inquire for pricing.

C108D... DUAL DUST CAP & PLUG

Part Number	Cross Reference	Body Size	Female NPTF	PRICE EACH		Pkg Qty	
				Loose	Std Pkg		
C108D-04							
C108D-04	2HDP-H2DC	1/4"		Nitrile rubber	3.40	3.20	5
C108D-06	3HDP-H3DC	3/8"		Nitrile rubber	3.60	3.30	5
C108D-08	4HDP-H4DC	1/2"		Nitrile rubber	4.10	3.60	5
C108D-12	6HDP-H6DC	3/4"		Nitrile rubber	8.20	8.20	1
C108D-16	8HDP-H8DC	1"		Nitrile rubber	9.50	9.50	1



Material

The following couplers and nipples come equipped with special seals for steam service. The coupler is also provided with a zinc plated steel flanged sleeve for ease of handling with gloved hands.

C111B BRASS STEAM COUPLER

C111B-06	3PHF3-B	3/8"	Female NPTF 3/8"		41.70	1
----------	---------	------	------------------	--	-------	---

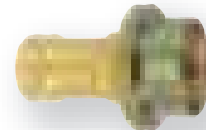

C112B BRASS STEAM NIPPLE

C112B-06	PH3F3-B	3/8"	3/8"		19.40	1
----------	---------	------	------	--	-------	---



C200 SERIES HYDRAULIC COUPLINGS

C200VV SERIES HYDRAULIC COUPLINGS

C200 couplings are compliant with the ISO-7241-A standard. They also interchange with the following Series: Snaptite 61, Hansen IA, Parker 6600, Faster ANV, & Aeroquip FD56(5600). The manual connect and disconnect are machined from solid steel bar stock. Steel sleeves are hardened to provide maximum service life. Stainless steel balls, retaining rings, and springs provide maximum service life. All units incorporate a Teflon backup ring to withstand dynamic impulse. Buna-N (Nitrile) seals are standard. Steel Plugs are hardened and zinc plated to provide heavy duty performance.

C200VV Series thread connect couplings allow users to connect under residual pressure and are commonly found on snow removal equipment. These couplers have a working pressure up to 4350 psi and are steel plated. The screw connect design eliminates brunelling and common built-up pressure connection problems. C200VV couplings are interchangeable with Faster VV Series and DNP VV Series.

Part Number	Cross Reference	Body Size	Female NPTF	PRICE EACH		Pkg Qty
				Loose	Std Pkg	

C201... PLATED STEEL COUPLER



C201-04-04	2KF2	1/4"	1/4"	\$19.90	\$17.90	5
C201-06-06	3KF3	3/8"	3/8"	22.80	20.70	5
C201-08-08	4KF4	1/2"	1/2"	25.10	22.70	5
C201-12-12	6KF6	3/4"	3/4"		40.60	1
C201-16-16	8KF8	1"	1"		72.50	1

C202... PLATED STEEL NIPPLE



C202-04-04	K2F2	1/4"	1/4"	9.40	8.40	5
C202-06-06	K3F3	3/8"	3/8"	10.90	9.80	5
C202-08-08	K4F4	1/2"	1/2"	10.90	9.80	5
C202-12-12	K6F6	3/4"	3/4"		21.40	1
C202-16-16	K8F8	1"	1"		40.40	1

C208... DUST PLUG



Part Number	Cross Reference	Body Size	Material		Price Each	Pkg Qty
			Material	Price Each		
C208-08	4KDP	1/2"	Polyurethane	4.20	3.80	5

C208D... DUAL DUST CAP & PLUG



C208D-04	2KDP-K2DC	1/4"	Nitrile rubber	4.20	3.80	5
C208D-06	3KDP-K3DC	3/8"	Nitrile rubber	4.20	3.80	5
C208D-12	6KDP-K6DC	3/4"	Nitrile rubber		8.40	1
C208D-16	8KDP-K8DC	1"	Nitrile rubber		11.00	1

C209... DUST CAP



C209-08	K4DC	1/2"	Polyurethane	4.20	3.80	5
---------	------	------	--------------	------	------	---

Part Number	Cross Reference	Body Size	Female NPTF	PRICE EACH		Pkg Qty
				Loose	Std Pkg	

C201VV... PLATED STEEL COUPLER



C201VV-04	PLC06-F-04N	1/4"	1/4"			\$22.80	1
C201VV-06	PLC10-F-06N	3/8"	3/8"			24.90	1
C201VV-08	PLC12-F-08N	1/2"	1/2"			34.80	1
C201VV-12	PLC19-F-12N	3/4"	3/4"			62.50	1
C201VV-16	PLC25-F-16N	1"	1"			92.90	1

C202VV... PLATED STEEL NIPPLE



C202VV-04	PLC06-M-04N	1/4"	1/4"			11.60	1
C202VV-06	PLC10-M-06N	3/8"	3/8"			16.80	1
C202VV-08	PLC12-M-08N	1/2"	1/2"			21.20	1
C202VV-12	PLC19-M-12N	3/4"	3/4"			36.10	1
C202VV-16	PLC25-M-16N	1"	1"			53.20	1

C208VV... DUST PLUG



C208VV-04	PLC06-F-PLUG	1/4"				11.10	1
C208VV-06	PLC10-F-PLUG	3/8"				13.40	1
C208VV-08	PLC12-F-PLUG	1/2"				19.20	1
C208VV-12	PLC19-F-PLUG	3/4"				24.00	1
C208VV-16	PLC25-F-PLUG	1"				37.40	1

C209VV... DUST CAP



C209VV-04	PLC06-M-CAP	1/4"				11.10	1
C209VV-06	PLC10-M-CAP	3/8"				13.40	1
C209VV-08	PLC12-M-CAP	1/2"				19.60	1
C209VV-12	PLC19-M-CAP	3/4"				30.90	1
C209VV-16	PLC25-M-CAP	1"				45.90	1

C300 EXTREME PRESSURE COUPLINGS

C300 couplings are interchangeable with the following Brands: Parker 3000, Enerpac C604, and Faster PVV. The Urethane seal resists extrusion when subjected to high pressure. The Chrome steel ball valve is coined to the valve seat to improve low pressure sealing performance on this 10,000 psi unit.

C400 INDUSTRIAL INTERCHANGE HYDRAULIC

C400 couplings are interchangeable with Parker/Pioneer 4000, Aeroquip FD76, Safeway S20 and comply with ISO standard 5675. In the 1/2" size only, they also meet ISO-7421-A, and so interchange with C200 series 1/2" parts. Traditionally, C400 were supplied with ball type valves. However, to reduce unsightly dripping, many users now use poppet valves.

4

Quick Couplings

Part Number	Cross Reference	Body Size	Female NPTF	PRICE EACH		Pkg Qty
				Loose	Std Pkg	

C301... PLATED STEEL COUPLER



C301-04	2TM2	1/4"	1/4"	\$21.80	\$19.80	5
C301-06	3TM3	3/8"	3/8"	25.30	22.80	5

C301F... PLATED STEEL FEMALE NPT COUPLER



C301F-06	3TF3	3/8"	3/8"	40.80	36.70	5
----------	------	------	------	-------	-------	---

C302... PLATED STEEL NIPPLE



C302-04	T2F2	1/4"	1/4"	15.20	13.60	5
C302-06	T3F3	3/8"	3/8"	15.70	14.00	5

C308... DUST PLUG



C308-04	2TDP	1/4"		7.90	7.30	5
C308-06	3TDP	3/8"		8.00	7.40	5

C309... DUST CAP

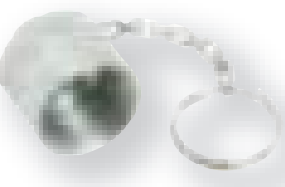

C309-04	T2DC	1/4"		9.80	8.80	5
C309-06	T3DC	3/8"		9.90	8.90	5

Part Number	Cross Reference	Body Size	Thread Size	PRICE EACH		Pkg Qty
				Loose	Std Pkg	

C401... AGRICULTURAL INTERCHANGE COUPLER

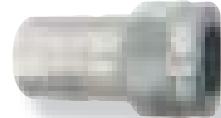

C401-04	S25A-2	1/4"	1/4"	\$18.40	\$16.60	5
C401-06	S25A-3	3/8"	3/8"	22.70	20.60	5
C401-08	S25-4	1/2"	1/2"	21.20	19.40	5
C401-12	S25F-6	3/4"	3/4"		57.00	1
C401-16	S25-8	1"	1"		74.50	1

C403... O-RING BOSS COUPLER



C403-08	S25-15	1/2"	3/4-16	35.30	32.10	5
C403-10	S25-16	1/2"	7/8-14	26.90	24.10	5

C405... TWO-WAY SLEEVE COUPLER



C405-06	S45-3	3/8"	3/8"	39.20	35.40	5
C405-08	S45-4	1/2"	1/2"	35.20	31.50	5
C405ORB-08	4250-15P	1/2"	3/4"	33.10	29.60	5
C405-08-12	S45-6	1/2"	3/4"	53.00	47.80	5

C406... CONNECT UNDER PRESSURE COUPLER



C406-08	S75-4	1/2"	1/2"	50.90	48.30	5
C406ORB-10	S75-16	1/2"	7/8-14	51.10	48.40	5

C402... AGRICULTURAL INTERCHANGE NIPPLE



C402-04	S41-2	1/4"	1/4"	10.20	9.20	5
C402-06	S41-3	3/8"	3/8"	10.90	9.80	5
C402-08	S71-4	1/2"	1/2"	10.50	9.60	5
C402-08-12	S71-6	1/2"	3/4"	18.90	17.20	5
C402-12	S21F-6	3/4"	3/4"		23.30	1
C402-16	S21-8	1"	1"		40.40	1

C404... O-RING BOSS NIPPLE

		Female ORB				
C404-08	S71-15	1/2"	3/4-16	15.50	14.00	5
C404-10	S71-16	1/2"	7/8-14	15.50	14.00	5

C400 INDUSTRIAL INTERCHANGE HYDRAULIC

C500 SERIES HYDRAULIC COUPLINGS

Part Number	Cross Reference	Body Size	Material	PRICE EACH		Pkg Qty
				Loose	Std Pkg	

C408R... DUST PLUG WITH CHAIN

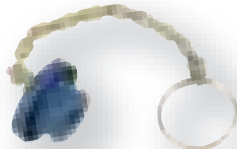

C408R-04	S44-2	1/4"	Rubber	\$6.10	\$5.70	5
C408R-06	S44-3	3/8"	Rubber	8.30	7.50	5
C408R-08	S44-4	1/2"	Rubber	6.90	6.30	5
C408-12	S44-6	3/4"	Thermoplastic		12.20	1
C408-16	S44-8	1"	Thermoplastic		15.20	1

C409R... DUST CAP WITH CHAIN



C409R-04	S49-2	1/4"	Rubber	5.70	5.30	5
C409R-06	S49-3	3/8"	Rubber	8.30	7.50	5
C409R-08	S49-4	1/2"	Rubber	6.90	6.30	5
C409-12	S49-6	3/4"	Thermoplastic		13.30	1
C409-16	S49-8	1"	Thermoplastic		16.50	1

NOTE: For the 1/2" body size, more economical thermoplastic dust caps and plugs are available. See C208-08 and C209-08

C400C... BREAK-AWAY CLAMPS



C400C-06	S42-3	3/8"		26.30	1
C400C-08	S42-4	1/2"		44.00	1

C405-8-KIT... BREAKAWAY COUPLER KIT



C405-8-KIT	S47-4	1/2"		156.10	1
------------	-------	------	--	--------	---

C406MR... MOUNTING RING



C406MR-08		1/2"		1.80	1.60	10
-----------	--	------	--	------	------	----

Our connect under pressure Wing Nut style couplings are interchangeable with the following Manufacturers: Parker 6100, Faster FB, Arequip 5100, Snaptite 78, and Hansen 96. Stainless steel retaining rings maximize corrosion resistance and extend service life. The internal sleeve seal incorporates a Teflon back-up ring on the valve sleeve to extend service life. This Non Spill coupling provides minimal air inclusion and fluid loss.

Part Number	Cross Reference	Body Size	Thread Size	PRICE EACH

C501... WING NUT COUPLER

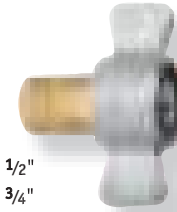

C501-12-08	6WF4-B	3/4"	1/2"	\$90.70
C501-12	6WF6-B	3/4"	3/4"	85.60
C501-16	8WF8-B	1"	1"	101.50
C501-20	10WF10-B	1 1/4"	1 1/4"	135.90
C501-24	12WF12-B	1 1/2"	1 1/2"	223.10

C502... WING NUT NIPPLE



Part Number	Cross Reference	Body Size	Thread Size	PRICE EACH
C502-12-08	W6F4-B	3/4"	1/2"	59.30
C502-12	W6F6-B	3/4"	3/4"	56.40
C502-16	W8F8-B	1"	1"	68.10
C502-20	W10F10-B	1 1/4"	1 1/4"	124.20
C502-24	W12F12-B	1 1/2"	1 1/2"	205.30

C508... DUST PLUG

C508-12	6WDP	3/4"		20.80
C508-16	8WDP	1"		24.10
C508-20	10WDP	1 1/4"		33.50
C508-24	12WDP	1 1/2"		58.60

C509... DUST CAP

C509-12	W6DC	3/4"		17.20
C509-16	W8DC	1"		20.30
C509-20	W10DC	1 1/4"		29.00
C509-24	W12DC	1 1/2"		51.30

C501RK... REPAIR KIT FOR COUPLER

C501RK-12	6W-RKIT	3/4"		34.30
C501RK-16	8W-RKIT	1"		39.20
C501RK-20	10W-RKIT	1 1/4"		41.20

C502RK... REPAIR KIT FOR NIPPLE

C502RK-12	W6-RKIT	3/4"		11.50
C502RK-16	W8-RKIT	1"		12.10
C502RK-20	W10-RKIT	1 1/4"		20.90

4

Quick Couplings

C500H & C600 SERIES HYDRAULIC COUPLINGS

C700 SERIES HYDRAULIC COUPLINGS

C500H Heavy-Duty Wing Nut couplings are found in oilfield and mining applications where high pressure, shockloads, or external abuse make other couplings unsuitable. These robust couplings are rated to 5000 psi and interchange with Snap-Tite 75 series and Hydraulics Inc 5TV style. Seals can easily be replaced in the field (even the valve seal). C500H couplings comply with Det Norske Veritas North Sea standards.

C700 Flush-Face Couplings were developed to handle dirty conditions in construction and maintenance applications. The flat faces on both coupler and nipple are easily wiped clean before connection, avoiding difficult connection and fluid contamination. Other features include a built-in sleeve lock (by rotating the sleeve), single handed connection, non-spill design, excellent flow performance, and an enhanced zinc-nickel plating for superior corrosion resistance. Flush-Face Couplings are most often seen on hydraulic jackhammers and emergency rescue equipment, but they are gaining in popularity in a variety of applications. The 3/8" size conforms to HTMA (Hydraulic Tool Manufacturers Association) specifications and interchange with Parker FF and Aeroquip FD89. We stock C700 series for standard pressure applications, and C700H for pressures up to 10,000 psi (see Technical Index for pressure ratings by size). C700 Series Couplings exceed ISO 16028 specifications.

4

Quick Couplings

Part Number	Cross Reference	Body Size	Thread Size	PRICE EACH
-------------	-----------------	-----------	-------------	------------

C501H... HEAVY-DUTY WING NUT COUPLER

C501H-12	6WSF6	3/4"	3/4"	\$77.10
C501H-16	8WSF8	1"	1"	118.30
C501H-20	10WSF10	1 1/4"	1 1/4"	190.80
C501H-24	12WSF12	1 1/2"	1 1/2"	258.60
C501H-32	16WSF16	2"	2"	513.30



C502H... HEAVY-DUTY NIPPLE

C502H-12	WS6F6	3/4"	3/4"	46.90
C502H-16	WS8F8	1"	1"	73.40
C502H-20	WS10F10	1 1/4"	1 1/4"	136.40
C502H-24	WS12F12	1 1/2"	1 1/2"	248.90
C502H-32	WS16F16	2"	2"	492.10



C508H... DUST PLUG

C508H-12	6WSDP-A	3/4"		20.50
C508H-16	8WSDP-A	1"		34.30
C508H-20	10WSDP-A	1 1/4"		45.70
C508H-24	12WSDP-A	1 1/2"		73.80
C508H-32	16WSDP-A	2"		131.20



C509H... DUST CAP

C509H-12	WS6DC-A	3/4"		24.40
C509H-16	WS8DC-A	1"		37.90
C509H-20	WS10DC-A	1 1/4"		52.90
C509H-24	WS12DC-A	1 1/2"		73.80
C509H-32	WS16DC-A	2"		152.40



C601... BRUNING SM INTERCHANGE COUPLER

C600 series occur in certain niche markets and have been around for years. They interchange with Parker/Bruning SM series and Aeroquip FD48 series and are often found on material handling equipment, small tractors, and hydraulic presses. This series is rated at 3 GPM flow rate and for 6000 psi maximum operating pressure.

C601-04-04	SH25-2P	1/4"	1/4"	34.80
C601-04-06	SH25-2-3P	1/4"	3/8"	34.80



C602... BRUNING SM INTERCHANGE NIPPLE

C602-04-04	SH21-2P	1/4"	1/4"	16.10
C602-04-06	SH21-2-3P	1/4"	3/8"	25.60



Part Number	Cross Reference	Body Size	Thread Size	PRICE EACH
-------------	-----------------	-----------	-------------	------------

C701... STANDARD FLAT FACE COUPLER

C701-04-04	HQ06-F-04N	1/4"	1/4"	\$44.70
C701-06-06	HQ10-F-06N	3/8"	3/8"	54.70
C701-06-08	HQ10-F-08N	3/8"	1/2"	54.70
C701-08-08	HQ12-F-08N	1/2"	1/2"	66.00
C701-08-12	HQ12-F-12N	1/2"	3/4"	81.90
C701-10-12	HQ16-F-12N	5/8"	3/4"	158.50
C701-12-12	HQ19-F-12N	3/4"	3/4"	102.40
C701-12-16	HQ19-F-16N	3/4"	1"	150.10
C701-16-16	HQ25-F-16N	1"	1"	334.70

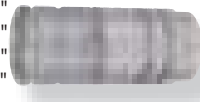

C702... STANDARD FLAT FACE NIPPLE

C702-04-04	HQ06-M-04N	1/4"	1/4"	17.20
C702-06-06	HQ10-M-06N	3/8"	3/8"	22.50
C702-06-08	HQ10-M-08N	3/8"	1/2"	22.50
C702-08-08	HQ12-M-08N	1/2"	1/2"	34.80
C702-08-12	HQ12-M-12N	1/2"	3/4"	38.20
C702-10-12	HQ16-M-12N	5/8"	3/4"	44.70
C702-12-12	HQ19-M-12N	3/4"	3/4"	64.30
C702-12-16	HQ19-M-16N	3/4"	1"	64.30
C702-16-16	HQ25-M-16N	1"	1"	124.60



C703... FLAT FACE COUPLER WITH ORB THREAD

C703-06-06	HQ10-F-06S	3/8"	9/16-18	66.50
C703-06-08	HQ10-F-08S	3/8"	3/4-16	64.00
C703-08-10	HQ12-F-10S	1/2"	7/8-14	78.10
C703-08-12	HQ12-F-12S	1/2"	1 1/16-12	78.30
C703-12-12	HQ16-F-12S	3/4"	1 1/16-12	198.90
C703-16-16	HQ19-F-16S	1"	1 5/16-12	219.80

C704... FLAT FACE NIPPLE WITH ORB THREAD

C704-06-06	HQ10-M-06S	3/8"	9/16-18	41.60
C704-06-08	HQ10-M-08S	3/8"	3/4-16	36.20
C704-08-10	HQ12-M-10S	1/2"	7/8-14	51.20
C704-08-12	HQ12-M-12S	1/2"	1 1/16-12	51.20
C704-12-12	HQ16-M-12S	3/4"	1 1/16-12	67.90
C704-16-16	HQ19-M-16S	1"	1 5/16-12	118.90

A common problem with flat face couplings is connecting them and overcoming built-up pressure in hydraulic lines. C700CP nipples will allow you to connect up to 5000 psi residual pressure when the coupler is at 0 psi. Commonly found on skid steers, as well as agriculture and construction equipment, C700CP Nipples are designed in accordance to ISO 16028 and will interchange with our C700 couplers.

C702CP... CONNECT UNDER PRESSURE NIPPLE

C702CP-06-06	HCP10-M-06N	3/8"	3/8"	\$87.00
C702CP-08-08	HCP12-M-08N	1/2"	1/2"	102.00
C702CP-08-12	HCP12-M-12N	1/2"	3/4"	109.90



NEW

C704CP... CONNECT UNDER PRESSURE NIPPLE WITH ORB THREAD

C704CP-06-08	HCP10-M-08S	3/8"	3/4-16	94.10
C704CP-08-08	HCP12-M-08S	1/2"	3/4-16	102.00

C700 SERIES HYDRAULIC COUPLINGS

Part Number	Cross Reference	Body Size	Thread Size	PRICE EACH
-------------	-----------------	-----------	-------------	------------

Our 90° couplings allow for easy mounting without the need for additional fittings reducing any potential leakage paths as well as overall cost. Popular on agriculture and construction equipment, such as skid steer attachments, these carbon steel fittings are designed in accordance to ISO 16028.

C703FB90... 90° COUPLER WITH ORB THREAD



C703FB90-08-08	HQ12-F-08S-90	1/2"	3/4-16	\$109.20
----------------	---------------	------	--------	----------

C704FB90... 90° NIPPLE WITH ORB THREAD



C704FB90-08-08	HQ12-M-08S-90	1/2"	3/4-16	61.70
----------------	---------------	------	--------	-------

C701H... HIGH PRESSURE COUPLER



C701H-06-06	FF495-3	3/8"	3/8"	107.90
C701H-06-08	FF495-4	3/8"	1/2"	107.90
C701H-12-12	FF495-6	3/4"	3/4"	175.50

C702H... HIGH PRESSURE NIPPLE



C702H-06-06	FF491-3	3/8"	3/8"	42.80
C702H-06-08	FF491-4	3/8"	1/2"	42.80
C702H-12-12	FF491-6	3/4"	3/4"	106.00

VEP series couplings are flush face but they thread together. This feature eliminates premature wear from brinelling of the locking balls in high impulse situations. In addition, the patented internal valve allows connection and disconnection with high residual pressures (up to 3600 psi). The flash face design is easy to clean and also avoids loss of hydraulic fluid during connection and disconnection. Our VEP Series Couplings are Interchangeable with Stucchi VEP, Parker FET, DNP FSI and Dixon VEP.

C701VEP... THREAD TOGETHER COUPLER



C701VEP-06-06	HFT10-F-06N	3/8"	3/8"	113.70
C701VEP-08-08	HFT12-F-08N	1/2"	1/2"	147.20
C701VEP-12-12	HFT16-F-12N	3/4"	3/4"	225.50
C701VEP-16-16	HFT19-F-16N	1"	1"	291.90
C701VEP-20-20	HFT25-F-20N	1 1/4"	1 1/4"	290.10
C701VEP-24-24	HFT32-F-24N	1 1/2"	1 1/2"	456.80

C702VEP... THREAD TOGETHER NIPPLE



C702VEP-06-06	HFT10-M-06N	3/8"	3/8"	91.70
C702VEP-08-08	HFT12-M-08N	1/2"	1/2"	120.40
C702VEP-12-12	HFT16-M-12N	3/4"	3/4"	134.80
C702VEP-16-16	HFT19-M-16N	1"	1"	213.60
C702VEP-20-20	HFT25-M-20N	1 1/4"	1 1/4"	276.80
C702VEP-24-24	HFT32-M-24N	1 1/2"	1 1/2"	416.60

Part Number	Cross Reference	Body Size	Thread Size	PRICE EACH
-------------	-----------------	-----------	-------------	------------

C703VEP... THREAD TOGETHER COUPLER WITH ORB THREAD

C703VEP-06-08	HFT10-F-08S	3/8"	3/4-16	\$137.10
C703VEP-08-08	HFT12-F-12S	1/2"	3/4-16	147.20
C703VEP-12-12	HFT16-F-12S	3/4"	1 1/16-12	224.10
C703VEP-16-16	HFT19-F-16S	1"	1 5/16-12	224.10

C704VEP... THREAD TOGETHER NIPPLE WITH ORB THREAD

C704VEP-06-08	HFT10-M-08S	3/8"	3/4-16	110.10
C704VEP-08-08	HFT12-M-12S	1/2"	3/4-16	120.40
C704VEP-12-12	HFT16-M-12S	3/4"	1 1/16-12	134.00
C704VEP-16-16	HFT19-M-16S	1"	1 5/16-12	212.20

C708... DUST PLUGS

Part	Cross Reference	Body Size	Thread Size	Material	Price
C708-06		3/8"		Rubber	1.80
C708-08		1/2"		Rubber	2.10
C708-12		3/4"		Rubber	2.90
C708-16		1"		Rubber	6.80
C708H-06		3/8"		Steel	14.90
C708VEP-06		3/8"		Aluminum	13.30
C708VEP-08		1/2"		Aluminum	17.90
C708VEP-12		3/4"		Aluminum	19.00
C708VEP-16		1"		Aluminum	19.50
C708VEP-20		1 1/4"		Aluminum	32.30
C708VEP-24		1 1/2"		Aluminum	64.50

C709... DUST CAPS

Part	Cross Reference	Body Size	Thread Size	Material	Price
C709-06		3/8"		Rubber	1.80
C709-08		1/2"		Rubber	2.10
C709-12		3/4"		Rubber	2.90
C709-16		1"		Rubber	6.80
C709H-06		3/8"		Steel	13.00
C709VEP-06		3/8"		Aluminum	13.90
C709VEP-08		1/2"		Aluminum	26.10
C709VEP-12		3/4"		Aluminum	19.90
C709VEP-16		1"		Aluminum	19.50
C709VEP-20		1 1/4"		Aluminum	36.60
C709VEP-24		1 1/2"		Aluminum	100.10

C710 SERIES HYDRAULIC COUPLINGS

C710 series Flush -Face couplings interchange with Snap-Tite 71 series and comply with Det Norske Veritas North Sea standards for coupling application.

Part Number	Cross Reference	Body Size	Thread Size	PRICE EACH
-------------	-----------------	-----------	-------------	------------

C711... HEAVY-DUTY FLUSH-FACE COUPLER

C711-12	6STF6	3/4"	3/4"	\$136.70
C711-16	8STF8	1"	1"	230.40
C711-16-20	8STF10	1"	1 1/4"	268.40



C712... HEAVY-DUTY FLUSH-FACE NIPPLE

C712-12	ST6F6	3/4"	3/4"	72.40
C712-16	ST8F8	1"	1"	102.90
C712-16-20	ST8F10	1"	1 3/4"	140.20

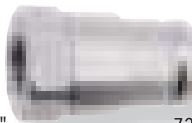

C718... DUST PLUG

C718-12	6STDP-A	3/4"		40.50
C718-16	8STDP-A	1"		51.30



C719... DUST CAP

C719-12	ST6DC-A	3/4"		35.10
C719-16	ST8DC-A	1"		45.40

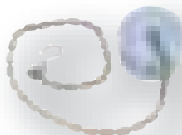

C800 SERIES HYDRAULIC COUPLINGS

Our C800 design interchanges with the following Series: SnapTite H, and Faster TNV. This manual connect and disconnect is machined from solid steel bar stock (also available in Brass and 316 stainless steel). Stainless steel balls, retaining rings, and springs maximize corrosion resistance and extend service life. All units incorporate a Teflon backup ring to withstand dynamic impulse. Also available in valved and non-valved, NPTF, BSPP, ORB, and larger sized configurations. Buna-N (Nitrile) seals are standard. Steel plugs are induction hardened and zinc plated to provide heavy duty performance.

Part Number	Cross Reference	Body Size	Thread Size	PRICE EACH
-------------	-----------------	-----------	-------------	------------

C801 HYDRAULIC COUPLER

C801-04	2VF2	1/4"	1/4"	\$25.10
C801-06	3VF3	3/8"	3/8"	34.80
C801-08	4VF4	1/2"	1/2"	40.50
C801-12	6VF6	3/4"	3/4"	65.40
C801-16	8VF8	1"	1"	102.00



C802 HYDRAULIC NIPPLE

C802-04	V2F2	1/4"	1/4"	17.20
C802-06	V3F3	3/8"	3/8"	21.60
C802-08	V4F4	1/2"	1/2"	27.80
C802-12	V6F6	3/4"	3/4"	38.70
C802-16	V8F8	1"	1"	61.80



C790 TEST PORT COUPLINGS

C790 couplers are used for test port diagnostic applications and are rated to 6000 psi. This series fits the ISO 15171-1 interchange and interchanges with Parker PD and Aeroquip FD90 designs.

C791... TEST PORT COUPLER

C791-02	1PDF1	1/8"	1/8"	49.20
C791-04	1PDF2	1/8"	1/4"	49.20



C792... TEST PORT NIPPLE

C792-02	PD1M1	1/8"	1/8"	13.30
C792-04	PD1M2	1/8"	1/4"	12.10



QUICK COUPLINGS FOR BOP SERVICE

The quick couplings shown on this page are designed for use with blow-out preventer systems on drilling rigs. They have been fire tested to 700°C and Lloyds witnessed to meet the API 16D standard. C100 & C500 series are all rated for 5000 psi. C700 series are rated for 5500 psi.

Part Number	Cross Reference	Body Size	Thread Size	PRICE EACH
-------------	-----------------	-----------	-------------	------------

C101BOP... ISO-7241B COUPLER FOR BOP SERVICE

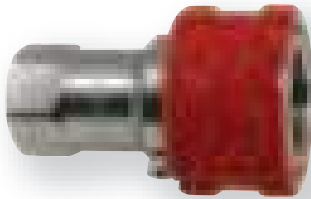

C101BOP-08	4HF4-BOP	1/2"	1/2"	\$117.10
C101BOP-12	6HF6-BOP	3/4"	3/4"	134.30
C101BOP-16	8HF8-BOP	1"	1"	163.10

C501BOP... WING NUT COUPLER FOR BOP SERVICE



C501BOP-12	6WSF6-BOP	3/4"	3/4"	216.70
C501BOP-16	8WSF8-BOP	1"	1"	259.60

C701BOP... VEP STYLE COUPLER FOR BOP SERVICE



C701BOP-06-06	3VEPF3-BOP	3/8"	3/8"	139.70
---------------	------------	------	------	--------

Part Number	Cross Reference	Body Size	Thread Size	PRICE EACH
-------------	-----------------	-----------	-------------	------------

C102BOP... ISO-7241B NIPPLE FOR BOP SERVICE



C102BOP-08	H4F4-BOP	1/2"	1/2"	\$71.80
C102BOP-12	H6F6-BOP	3/4"	3/4"	86.30
C102BOP-16	H8F8-BOP	1"	1"	108.90

C502BOP... WING NUT NIPPLE FOR BOP SERVICE



C502BOP-12	WS6F6-BOP	3/4"	3/4"	167.80
C502BOP-16	WS8F8-BOP	1"	1"	147.60

C702BOP... VEP STYLE NIPPLE FOR BOP SERVICE



C702BOP-06-06	VEP3F3-BOP	3/8"	3/8"	158.50
---------------	------------	------	------	--------

For more information on quick couplings and our Interchange Guide, visit us online at www.greenlinehose.com or see the Technical Information section of this catalog.

FIRE HOSE NOZZLES & WRENCHES

See Valve Section for Fire Hydrant & Forestry Valves

We sell a variety of fire hose coupling wrenches to suit various coupling & hydrant designs.

Part Number	Thread Size	PRICE EACH
-------------	-------------	------------

G97B... BRASS FOG NOZZLE



G97B-100	1" Pipe (NPSH)	\$65.20
G97B-150	1½" Pipe (NPSH) 	65.20

G97... RED PLASTIC FOG NOZZLE



G97E

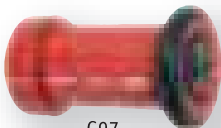

G97

G97-075	¾" Pipe (NPSH)	29.80
G97-100	1" Pipe (NPSH)	29.80
G97-150	1½" Pipe (NPSH) 	22.30
G97E-150	Red non-ULC Economy	17.30
G97-200	2" Pipe (NPSH)	104.90
G97-GHT	Garden hose thread	18.90
G97G-150	1½" Replacement gasket	1.50

G37... SOLID BRASS TAPERED NOZZLE

NOTE: For additional wash down nozzles with garden hose threads, see the Accessory Section of this catalog.



G37-075	¾" Pipe (NPSH)	12.80
G37-100	1" Pipe (NPSH)	17.30
G37-125	1¼" Pipe (NPSH)	37.70
G37-150	1½" Pipe (NPSH)	46.10
G37-200	2" Pipe (NPSH)	54.00
G37-GHT	Garden hose thread	12.10

G37P... RED PLASTIC TAPERED NOZZLE



G37P-150	1½" Pipe (NPSH)	13.30
----------	-----------------	-------

G97B-GHT... BRASS TWIST NOZZLE

This very compact nozzle is typically used for forest fire mop-up along with our small diameter garden hose threaded fire hoses.

G97B-GHT		7.50
----------	--	------

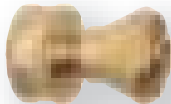

Part Number	Thread Size	PRICE EACH
-------------	-------------	------------

G84... STANDARD PENTAGON WRENCH



\$36.60

G84A... ALBERTA WRENCH



60.00

G84C... 1¼" SQUARE NUT CALGARY & ONTARIO WRENCH



47.10

G84E... EDMONTON HYDRANT WRENCH



63.60

G84NK... NAKAJIMA COUPLING WRENCH

G84NK-200		18.60
G84NK-250		26.90



G84SZ... STORZ COUPLING WRENCH



16.40

G84SZ-300... 3" STORZ COUPLING WRENCH



66.90

Why take a chance that your hydrant wrench won't work at a critical moment. Our Premium G84U universal adjustable wrench has a double spanner head and handles pentagonal hydrant heads to 1⅞" and square heads to 1½". The spanner head works with both rocker and pin lug couplings, and the tough manganese-bronze jaw is replaceable. The chrome plated steel handle is 18" long for extra torque.

G84U... ADJUSTABLE WRENCH



137.50

5

Fire & Hydrant

Instantaneous fittings are brass or aluminum couplings designed for use in forest fire fighting. Since ends are interchangeable (there are no male or female hose ends) and connections are made with a simple quarter-turn, multiple hoses can be laid out and joined quickly. Aluminum hose fittings have the advantage of light weight, while brass hose fittings are stronger and more resistant to cracking during installation.

All our couplings come complete with expansion rings, however we also offer replacement rings so that couplings can be reused.

Part Number	Hose Size	Bowl Size	PRICE EACH		Pkg Qty
			Loose	Std Pkg	

G85... INSTANTANEOUS HOSE FITTING



G85-100-119	1"	1 ³ / ₁₆ " Aluminum	\$17.60	\$15.80	10
G85-150-169	1 ¹ / ₂ "	1 ¹¹ / ₁₆ " Aluminum	15.40	13.80	10
G85B-150-169	1 ¹ / ₂ "	1 ¹¹ / ₁₆ " Brass	26.80	24.50	10

G86... INSTANTANEOUS MALE PIPE ADAPTER



		Pipe Size			
G86-100	1"		20.40	18.20	5
G86-150	1 ¹ / ₂ "		9.50	8.20	5
G86N-150	1 ¹ / ₂ "	Nylon	14.40	12.30	5

G87... INSTANTANEOUS FEMALE PIPE ADAPTER



G87-100	1" NPT		20.50	18.40	5
G87-150	1 ¹ / ₂ " NPT		9.50	8.20	5
G87N-150	1 ¹ / ₂ " NPSH Nylon		11.60	9.90	5
G87S-150	1 ¹ / ₂ " NPSH *		9.50	8.20	5

* G87S has a short, straight thread to connect to male fire hose threads.

G88C... INSTANTANEOUS CAP



G88C			9.50	8.20	5
------	--	--	------	------	---

G88... GROOVED GASKET



G88	Grooved gasket		1.50	1.30	10
G88W	Fits G87 NPSH thread		1.80	1.60	10

Part Number	Hose Size	Bowl Size	PRICE EACH		Pkg Qty
			Loose	Std Pkg	

G86-GHT... INSTANTANEOUS MALE GARDEN HOSE THREAD ADAPTER



G86-GHT	GHT		16.00	13.80	5
---------	-----	--	-------	-------	---

G87-GHT... INSTANTANEOUS FEMALE GARDEN HOSE THREAD ADAPTER



G87-GHT	GHT		27.20	23.60	5
---------	-----	--	-------	-------	---

G95-150... INSTANTANEOUS HOSE SHANK



G95-150	1 ¹ / ₂ "		13.00	11.80	10
---------	---------------------------------	--	-------	-------	----

G80WT... WATER THIEF WITH MALE THREADS



G80WT		1 ¹ / ₂ " NPSH x GHT			14.70
-------	--	--	--	--	-------

G87WT... WATER THIEF WITH INSTANTANEOUS ENDS

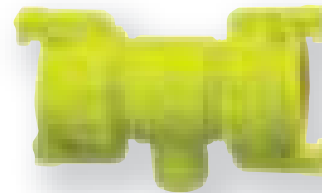

G87WT		Instantaneous x GHT			35.60
-------	--	---------------------	--	--	-------

Note: To add a garden hose shut off valve to the water thief, see the various options in the Garden & Pressure Wash section of the catalog

FIRE HOSE FITTINGS

G80B couplings are economically priced and are commonly found on stand-by and cabinet fire hoses. They feature pin lugs on the female coupling only. Standard couplings come with NPSH threads.

G80 Aluminum couplings are hard coated for superior corrosion and wear resistance and to resist thread galling. Both male and female couplings have rocker lugs for easy tightening. Standard 1½" couplings have NPSH threads.

Part Number	Hose Size	Bowl Size	PRICE EACH
-------------	-----------	-----------	------------

1½" BRASS COUPLINGS

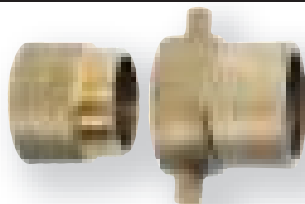

FULL SETS

G80B-150-169	1½"	1 ¹¹ / ₁₆ "	\$47.70
G80B-150-175	1½"	1 ³ / ₄ "	47.70
G80B-150-181	1½"	1 ¹³ / ₁₆ "	47.70
G80B-150-194	1½"	1 ¹⁵ / ₁₆ "	47.70

MALE ONLY

G80BM-150-169	1½"	1 ¹¹ / ₁₆ "	23.90
G80BM-150-175	1½"	1 ¹ / ₄ "	23.90
G80BM-150-181	1½"	1 ¹³ / ₁₆ "	23.90
G80BM-150-194	1½"	1 ¹⁵ / ₁₆ "	23.90

FEMALE ONLY

G80BF-150-169	1½"	1 ¹¹ / ₁₆ "	23.90
G80BF-150-175	1½"	1 ³ / ₄ "	23.90
G80BF-150-181	1½"	1 ¹³ / ₁₆ "	23.90
G80BF-150-194	1½"	1 ¹⁵ / ₁₆ "	23.90

For 2½" municipal fire hoses, the threads vary by province and state and sometimes even by city. Our basic part numbers are G80 for a coupling set, G80M for males, and G80F for females. In addition, please specify the threads from the list shown. For example, for a hose that will be used in Manitoba, specify G80WCT-250 thread couplings.

2½" BRASS COUPLINGS

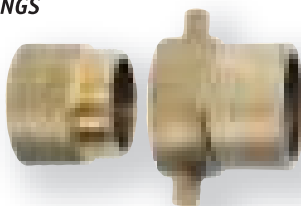

FULL SETS

G80B-250-275	2½"	2 ³ / ₄ "	97.10
--------------	-----	---------------------------------	-------

MALE ONLY

G80BM-250-275	2½"	2 ³ / ₄ "	33.90
---------------	-----	---------------------------------	-------

FEMALE ONLY

G80BF-250-275	2½"	2 ³ / ₄ "	63.20
---------------	-----	---------------------------------	-------

Part Number	Hose Size	Bowl Size	PRICE EACH		Pkg Qty
			Loose	Std Pkg	

G80G... REPLACEMENT GASKETS



G80G-150	1½"		0.80	0.60	10
G80G-250	2½"		1.10	0.80	10

Part Number	Hose Size	Bowl Size	PRICE EACH
-------------	-----------	-----------	------------

1" & 1½" HARDCOAT ALUMINUM ROCKER LUG COUPLINGS

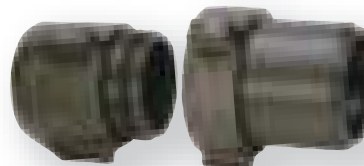

FULL SETS

G80-100-125	1"	1 ¹ / ₄ "	\$30.50
G80-150-169	1½"	1 ¹¹ / ₁₆ "	53.00
G80-150-175	1½"	1 ³ / ₄ "	53.00
G80-150-181	1½"	1 ¹³ / ₁₆ "	53.00
G80-150-194	1½"	1 ¹⁵ / ₁₆ "	53.00

MALE ONLY

G80M-100-125	1"	1 ¹ / ₄ "	15.30
G80M-150-169	1½"	1 ¹¹ / ₁₆ "	18.80
G80M-150-175	1½"	1 ³ / ₄ "	18.80
G80M-150-194	1½"	1 ¹⁵ / ₁₆ "	18.80

FEMALE ONLY

G80F-100-125	1"	1 ¹ / ₄ "	15.30
G80F-150-169	1½"	1 ¹¹ / ₁₆ "	34.20
G80F-150-175	1½"	1 ³ / ₄ "	34.20
G80F-150-194	1½"	1 ¹⁵ / ₁₆ "	34.20

2½" HARDCOAT ALUMINUM ROCKER LUG COUPLINGS



FULL SETS

G80-250-275	2½"	2 ³ / ₄ "	97.10
G80-250-281	2½"	2 ¹³ / ₁₆ "	97.10
G80-250-294	2½"	2 ¹⁵ / ₁₆ "	97.10
G80-250-300	2½"	3"	97.10

MALE ONLY

G80M-250-275	2½"	2 ³ / ₄ "	33.90
G80M-250-281	2½"	2 ¹³ / ₁₆ "	33.90
G80M-250-294	2½"	2 ¹⁵ / ₁₆ "	33.90
G80M-250-300	2½"	3"	33.90

FEMALE ONLY

G80F-250-275	2½"	2 ³ / ₄ "	63.20
G80F-250-281	2½"	2 ¹³ / ₁₆ "	63.20
G80F-250-294	2½"	2 ¹⁵ / ₁₆ "	63.20
G80F-250-300	2½"	3"	63.20

Part Number	Hose Size	Bowl Size	PRICE EACH		Pkg Qty
			Loose	Std Pkg	

G88R... EXPANSION RINGS



Coupling Type		PRICE EACH
G88R-100-122	G80	\$4.00
G88R-150-075	G80B	4.10
G88R-150-088	G85	4.10
G88R-150-115	G80	7.80
G88R-250-150	G80	8.50

HOW TO MEASURE A MALE FIRE HOSE THREAD:

Take a strip of paper about 1" wide and wrap it around the male thread snugly so that it overlaps. Where the two ends overlap, use a pin to pierce the paper so that there is a hole in both ends. Press your thumb against the paper so that the threads leave an impression. Remove the paper and measure the distance between the pinholes. This distance, divided by 3.1416, equals the thread o.d. Count the number of thread impressions showing on the paper and divide by the total width of the impressions (in inches). This figure is the pitch in threads per inch.

PARTIAL LISTING OF FIRE HOSE THREADS

Code	Region Used	Description	O.D.	Pitch
1½" Canadian Threads:				
NPSH		NPSH Straight Iron Pipe Thread	1.878"	11.5
2½" Canadian Threads:				
BAT	BC/Alberta	BCST British Columbia Standard Thread and AMA Alberta Mutual Aid combined*	2.990"	8*
CSA	Ontario	Canadian Standards Assn.	3.125"	5
NS1	Nova Scotia	Nova Scotia - zone 1	3.234"	5
QMT	Quebec	QST and QMT Quebec/Montreal Combination Thread	3.031"	7
WCT	Sask. & Manitoba	Western Canada Fire Underwriters Assn.	3.250"	6
1½" Other Threads:				
BSP		British Standard Pipe Thread	1.882"	11
NST		NH and NST and ANSI Thread	1.990"	9
2½" Other Threads:				
BSP		British Standard Pipe Thread	2.956"	11
NST		NH and NST and ANSI Thread	3.068"	7.5

* BAT Threads are designed to function with both BCST and AMA fittings. To accomplish this, the BAT male is cut to suit the smallest thread O.D., which is AMA fitting at 2.99", while the female coupling is machined to fit the largest I.D.

ALUMINUM SUCTION HOSE COUPLINGS

Part Number	Fire Thread	Hose Size	PRICE EACH
G31BAT-250	2½" Male BAT	2½"	\$80.50
G32BAT-250	2½" Female BAT	2½"	80.50

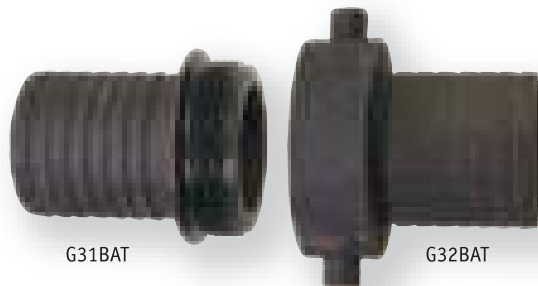

HYDRANT ADAPTERS

2½" FIRE HOSE THREAD ADAPTERS

G82... FEMALE FIRE BY MALE NPT

Fire Thread	Male Thread	Part Number	PRICE EACH
2½" BAT	1½" NPT	G82BAT-150	\$62.50
	2"	G82BAT-200	68.90
	2½"	G82BAT-250	94.30
	3"	G82BAT-300	130.40
2½" CSA	1½" NPT	G82CSA-150	93.30
	2"	G82CSA-200	101.80
	2½"	G82CSA-250	130.40
2½" NS1	1½" NPT	G82NS1-150	93.30
	2"	G82NS1-200	101.80
	3"	G82NS1-300	130.40
2½" QMT	1½" NPT	G82QMT-150	93.30
	2"	G82QMT-200	101.80
	2½"	G82QMT-250	130.40
	3"	G82QMT-300	130.40
2½" WCT	1½" NPT	G82WCT-150	93.30
	2"	G82WCT-200	101.80
	3"	G82WCT-300	130.40

There is a practically endless selection of custom machined hydrant adapters that can be ordered. The most important ones are listed below. Please call for other configurations.



G82BAT



G82SBAT

G82S... SWIVEL FEMALE FIRE BY MALE NPT

2½" BAT	2" NPT	G82SBAT-200	117.70
	2½" NPT	G82SBAT-250	127.20

G81... MALE FIRE BY MALE NPT

2½" BAT	1½" NPT	G81BAT-150	89.00
	2"	G81BAT-200	117.70
	2½"	G81BAT-250	127.20
	3"	G81BAT-300	167.50
2½" CSA	1½" NPT	G81CSA-150	89.00
	2"	G81CSA-200	117.70
	3"	G81CSA-300	167.50
2½" NS1	1½" NPT	G81NS1-150	89.00
	2"	G81NS1-200	117.70
	3"	G81NS1-300	167.50
2½" QMT	1½" NPT	G81QMT-150	89.00
	2"	G81QMT-200	117.70
	3"	G81QMT-300	167.50
2½" WCT	1½" NPT	G81WCT-150	89.00
	2"	G81WCT-200	117.70
	3"	G81WCT-300	167.50



G81

OTHER FIRE HOSE THREAD ADAPTERS

Thread	Size	Thread	Part Number	PRICE EACH
Female NPSH	1½"	Male GHT	G81FM-NPSH-GHT-150	\$89.00
Female NPSH	1½"	Male NPT	G81FM-NPSH-NPT-150-150	89.00
Male NPSH	1½"	Male NPT	G81MM-NPSH-NPT-150-150	89.00
Swivel NPSH	1½"	Male NPT	G81SM-NPSH-NPT-150-150	89.00
Storz	2"	Female BSP	G81BZF-BSP-200-200	77.60
Storz	2"	Female NPSH	G81BZF-NPSH-200-200	77.60

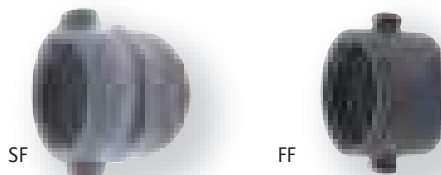

SF

FF

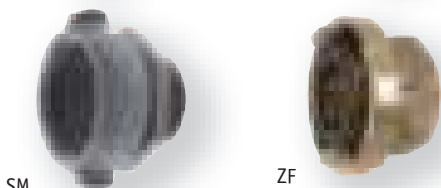

SM

ZF

INTERNATIONAL FIRE HOSE FITTINGS

INTERNATIONAL FIRE HOSE COUPLINGS

Fire hose fittings found on ships can be any of a multitude of designs from around the world. We stock the five standards that we have found to be the most popular. All of the couplings listed are brass.

Since many ships, and the ship chandlers that supply them, often rely on the IMPA (International Marine Purchasing Association) catalog as a reference when ordering products, we have provided the IMPA code where possible.

NAKAJIMA couplings conform to the Japanese JIS F7335 standard. The two halves are identical and a quarter turn locks the couplings together.

MACHINO fittings are also a Japanese design, but conform to JIS B9911. They are a push-to-connect coupling with a distinctive outer rubber bumper on the female half. Pushing the flange on the male half releases the fittings.

JOHN MORRIS couplings, also known as British Instantaneous, meet the BS 336 British Standard design. The distinctive arms on the female coupling are spring-loaded and lock onto the male fitting when pushed together. Pulling the arms away from the coupling releases the fitting.

STORZ fittings are based on a German design and conform to DIN 14302 and DIN 14303. A quarter turn mates the two identical halves.

PIN STYLE couplings are a male and female threaded coupling with pin lugs for tightening. They have NST (NH) US style threads or NPSH straight pipe threads as shown.

Part Number	IMPA Code	Size	Hose I.D.	PRICE EACH
-------------	-----------	------	-----------	------------

G95NK... NAKAJIMA HOSE SHANK



G95NK-150	33-08-51	1 1/2"	1 1/2"	\$24.30
G95NK-200	33-08-52	2"	2"	41.00
G95NK-250	33-08-53	2 1/2"	2 1/2"	56.00
G95NK-250-150	33-08-91	2 1/2"	1 1/2"	56.00
G95NK-250-200		2 1/2"	2"	56.00

G91MC... MACHINO MALE HOSE SHANK



G91MC-150	33-08-55	1 1/2"	1 1/2"	15.40
G91MC-200	33-08-56	2"	2"	28.00
G91MC-250	33-08-57	2 1/2"	2 1/2"	39.10

G92MC... MACHINO FEMALE HOSE SHANK



G92MC-150	33-08-55	1 1/2"	1 1/2"	23.10
G92MC-200	33-08-56	2"	2"	33.50
G92MC-250	33-08-57	2 1/2"	2 1/2"	53.40

Part Number	IMPA Code	Male Size	Hose I.D.	PRICE EACH
-------------	-----------	-----------	-----------	------------

G91JM... JOHN MORRIS MALE HOSE SHANK



G91JM-150	33-08-59	1 1/2"	1 1/2"	\$25.10
G91JM-250	33-08-61	2 1/2"	2 1/2"	48.40
G91JM-250-150		2 1/2"	1 1/2"	42.20

G92JM... JOHN MORRIS FEMALE HOSE SHANK

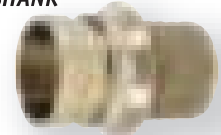

		Female Size	Hose I.D.	PRICE EACH
G92JM-150	33-08-59	1 1/2"	1 1/2"	36.30
G92JM-250	33-08-61	2 1/2"	2 1/2"	72.80

G95SZ... STORZ HOSE SHANK



		Size	Hose I.D.	PRICE EACH
G95SZ-150		1 1/2"	1 1/2"	28.30
G95SZ-200	33-08-75	2"	2"	50.10
G92SZ-200-150		2 1/2"	1 1/2"	93.00
G95SZ-250		2 1/2"	2 1/2"	66.30

	Thread O.D. & Pitch	PRICE EACH	Loose	Std Pkg	Qty
--	---------------------	------------	-------	---------	-----

G31B... NPSH MALE



G31B-150	1 1/2"	1.878"-11 1/2	\$16.60	\$15.10	5
G31B-200	2"	2.352"-11 1/2	26.90	24.40	5
G31B-250	2 1/2"	2.841" - 8		37.40	1

G32B... NPSH FEMALE

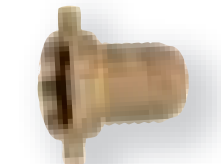

G32B-150	1 1/2"	1.878"-11 1/2	19.00	17.00	5
G32B-200	2"	2.352"-11 1/2	29.00	25.90	5
G32B-250	2 1/2"	2.841" - 8		40.70	1

G31BNST... NST PIN LUG MALE

Also called NH or ANSI thread



G31BNST-150	33-08-65M	1 1/2"	1.990" - 9	12.80	1
G31BNST-250	33-08-66M	2 1/2"	3.068" - 7 1/2	40.10	1
G31BNST-250-150	33-08-93M	2 1/2"	3.068" - 7 1/2	55.30	1

G32BNST NST PIN LUG FEMALE

Also called NH or ANSI thread

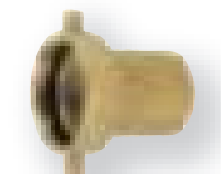

G32BNST-150	33-08-65F	1 1/2"	1.990" - 9	15.80	1
G32BNST-250	33-08-66F	2 1/2"	3.068" - 7 1/2	38.40	1
G32BNST-250-150	33-08-93F	2 1/2"	3.068" - 7 1/2	46.70	1

ADJUSTABLE INTERNATIONAL NOZZLES

We offer lightweight G37 aluminum compact nozzles as well as traditional G97 three position brass nozzle bodies. Both of these parts have female threads that will accept a wide variety of coupling styles. Simply choose the nozzle style, and then add the appropriate adapter to connect to your fire hose.

Part Number	Description	Hose Size	PRICE EACH
NOZZLES			
G37T-150	Compact nozzle	1½"	\$40.20
G37T-200	Compact nozzle	2"	47.10
G37T-250	Compact nozzle	2½"	56.10
G97-3-150	Three position nozzle	1½"	363.30
G97-3-200	Three position nozzle	2"	371.40
G97-3-250	Three position nozzle	2½"	412.00

NOZZLE ADAPTERS

G98JMA-150	John Morris adapter	1½"	19.00
G98JMA-250	John Morris adapter	2½"	48.40
G98MCA-150	Machino adapter	1½"	24.20
G98MCA-200	Machino adapter	2"	35.80
G98MCA-250	Machino adapter	2½"	57.30
G98NKA-150	Nakajima adapter	1½"	26.80
G98NKA-200	Nakajima adapter	2"	44.30
G98NKA-250	Nakajima adapter	2½"	55.10
G98NPSHA-150	NPSH thread adapter	1½"	21.80
G98NPSHA-250	NPSH thread adapter	2½"	43.40
G98NSTA-150	NST (ANSI) thread adapter	1 ½"	21.80
G98NSTA-250	NST (ANSI) thread adapter	2 ½"	43.40
G98SZA-150	Storz adapter	1½"	42.10
G98SZA-200	Storz adapter	2"	63.40
G98SZA-250	Storz adapter	2½"	88.40

G97-3-150

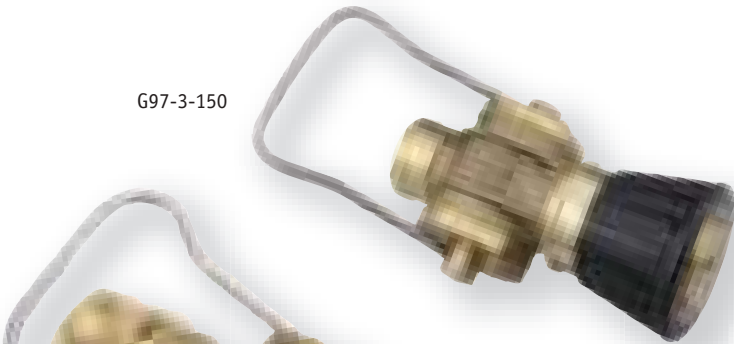

Complete John Morris Nozzle

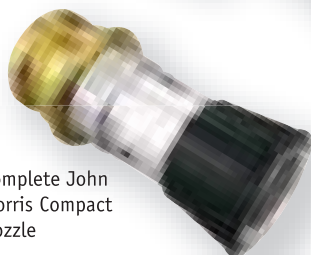

Complete John Morris Compact Nozzle

IMPA PART NUMBERS FOR COMPLETE NOZZLE ASSEMBLIES

Size	John Morris	Machino	Nakajima	NST (ANSI)	Storz
Compact Nozzle Assemblies					
1½"		33-08-37	33-08-31	33-08-34	
2"		33-08-38	33-08-32		
2½"		33-08-39	33-08-33	33-08-36	
Three Position Nozzle Assemblies					
1½"					
2"					33-08-22S
2½"	33-08-23JM				33-08-21SZ

ADAPTERS FOR THREE POSITION NOZZLES

Thread Dimensions for Nozzle Adapters

Nozzle Size	Male Thread O.D.	Threads per Inch
1½"	1.410"	12
2"	1.770"	12
2½"	2.158"	10



Complete NST Nozzle

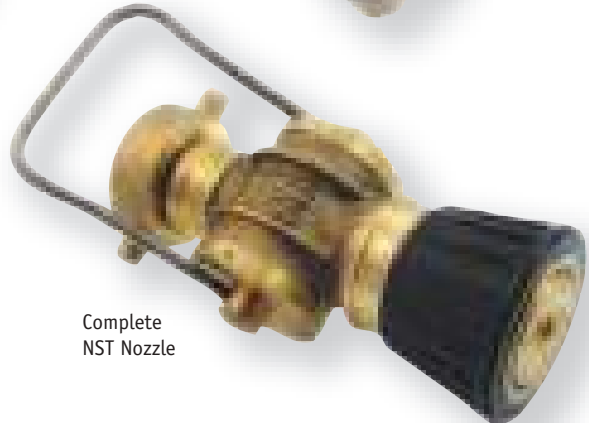

Our brass jet stream nozzles are available with a variety of coupling designs. The tips are designed to provide a straight stream flow, with tip diameters of 13mm in 1-1/2" nozzles, 15mm for 2", and 20mm in 2-1/2". Where a fog spray is preferable, the threaded jet stream tip can be removed and replaced with our G37T fog spray tip. The G37T is an adjustable fog nozzle with an aluminum body and a protective rubber bumper.

Jet Stream Fire Hose Nozzles

Part Number	IMPA Code	Size	PRICE EACH
-------------	-----------	------	------------

G37NK... NAKAJIMA JET NOZZLE



G37NK-150	33-08-01	1 1/2"	\$86.70
G37NK-200	33-08-03	2"	100.00
G37NK-250	33-08-04	2 1/2"	150.20

G37JM... JOHN MORRIS JET NOZZLE

G37JM-150		1 1/2"	52.80
G37JM-250		2 1/2"	116.90

G37SZ... STORZ JET NOZZLE

G37SZ-150		1 1/2"	76.70
G37SZ-200		2"	119.90
G37SZ-250		2 1/2"	148.40

G37MC... MACHINO JET NOZZLE

G37MC-150	33-08-09	1 1/2"	70.10
G37MC-200	33-08-10	2"	98.40
G37MC-250	33-08-11	2 1/2"	136.10

G37NST... NST JET NOZZLE

G37NST-150		1 1/2"	52.80
G37NST-250		2 1/2"	113.50

CAPS & GASKETS

Part Number	IMPA Code	Size	PRICE EACH
-------------	-----------	------	------------

G98NKC... NAKAJIMA CAP

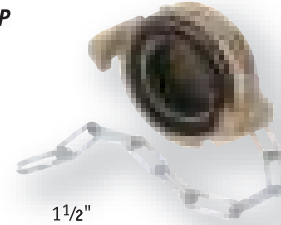

G98NKC-150		1 1/2"	\$21.70
G98NKC-200		2"	40.00
G98NKC-250		2 1/2"	60.10

G98JMC... JOHN MORRIS CAP



G98JMC-250		2 1/2"	75.00
------------	--	--------	-------

G98SZC... STORZ CAP

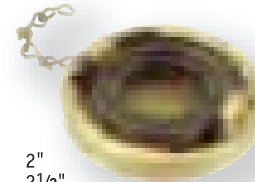

G98SZC-200		2"	48.30
G98SZC-250		2 1/2"	63.40

G98NHC... NH/NST CAP



G98NHC-250		2 1/2"	39.60
------------	--	--------	-------

G98NHP... NH/NST PLUG



G98NHP-250		2 1/2"	39.60
------------	--	--------	-------

To attach to 42mm threaded connections frequently used for stanchions on ocean going vessels, we stock a 42mm female threaded pin lug nut. This nut can combine with various sized hose shanks to produce complete fittings for hose sizes from 1/4" to 1". The conical shaped insert provides a metal-to-metal mechanical seal with the 42mm stanchion.

G32NK METRIC THREADED CONNECTIONS

Part Number	IMPA Code	Size	PRICE EACH
-------------	-----------	------	------------

G32NK... COMPLETE FITTINGS



G32NK-150-6MM	35-10-51	6 mm (1/4")	\$25.40
G32NK-150-10MM	35-10-53	10 mm (3/8")	25.40
G32NK-150-12MM	35-10-54	12 mm (1/2")	25.40
G32NK-150-15MM	35-10-55	15 mm (5/8")	25.40
G32NK-150-19MM	35-10-56	19 mm (3/4")	25.40
G32NK-150-25MM	35-10-57	25 mm (1")	25.40

G30NK... NUT ONLY



G30NK	all		5.20
-------	-----	--	------

Part Number	IMPA Code	Size	PRICE EACH
-------------	-----------	------	------------

G98NK... NAKAJIMA GASKET

G98NK-150	33-08-51G	1 1/2"	\$1.10
G98NK-200	33-08-52G	2"	1.40
G98NK-250	33-08-53G	2 1/2"	1.60

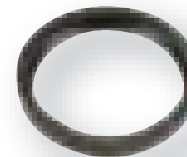

G98JM... JOHN MORRIS GASKET

G98JM-150	33-08-59G	1 1/2"	1.80
G98JM-250	33-08-61G	2 1/2"	2.80



G98SZ... STORZ GASKET

G98SZ-150		1 1/2"	1.10
G98SZ-200		2"	1.40
G98SZ-250		2 1/2"	1.60

G98MC... MACHINO GASKET

G98MC-150	33-03-55G	1 1/2"	1.80
G98MC-200	33-03-56G	2"	2.10
G98MC-250	33-03-57G	2 1/2"	2.30

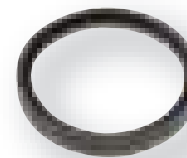

WASHDOWN & PRESSURE WASH

SEWER CLEANER & JETTING HOSE FITTINGS

Part No. Thread Size Hose Size Weight Ea. PRICE EACH

9800SC... HOSE MENDERS



9800SC-12-12	3/4"	3/4"	0.50	107.20
9800SC-16-16	1"	1"	0.80	40.50

9806SC... FEMALE NPSM FITTINGS



9806SC-12-12	3/4"	3/4"	0.52	56.00
9806SC-16-16	1"	1"	0.90	90.50

9816SC... MALE NPT FITTINGS



9816SC-02-02	1/8"	1/8"	0.04 lb	8.00
9816SC-02-03	1/8"	3/16"	0.08	11.60
9816SC-04-04	1/4"	1/4"	0.10	11.80
9816SC-06-06	3/8"	3/8"	0.17	11.20
9816SC-08-08	1/2"	1/2"	0.35	18.40
9816SC-08-10	1/2"	5/8"	0.36	36.90
9816SC-12-12	3/4"	3/4"	0.43	29.90
9816SC-16-16	1"	1"	0.71	31.30

PRESSURE WASHER ACCESSORIES

Part No. Description PRICE EACH



PW-GA-36	4000 psi 10 GPM gun and wand assembly with 36" insulated, plated steel lance with 3/8" quick coupling inlet and 1/4" female quick coupling tip	72.30
----------	--	-------

**THESE GUN AND GUN/
WAND ASSEMBLIES ARE
RATED TO 99°C (210°F)**



PW-G	5000 psi, 10 GPM gun with 3/8" female NPT inlet and 1/4" female NPT outlet	48.70
PW-G-W	Weeping version to prevent freezing <i>Note: Weeps at valve in handle assembly, not at outlet</i>	48.70

Part No. Description PRICE EACH

PW-L24	24" insulated, plated steel tip lance with 1/4" NPT	12.60
PW-L36	36" insulated, plated steel tip lance with 1/4" NPT	15.40
PW-L48	48" insulated, plated steel tip lance with 1/4" NPT	21.70

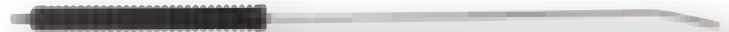

PW-LB-36	36" insulated, bent tip lance with 1/4" NPT	20.20
PW-GC	Gutter cleaner	14.30



METRIC PRESSURE WASHER ADAPTERS

These adapters fit 22 millimetre metric pressure wash connections



64008



74008



74016

64008-22-04	Female metric to 1/4" female NPT	9.40
64008-22-06	Female metric to 3/8" female NPT	9.60
74008-22-06	Male metric to 3/8" female NPT	5.70
74016-22-06	Male metric to 3/8" male NPT	6.30

MOLE NOZZLES WITH 1 FORWARD & 3 BACK JETS FOR SEWER CLEANING

PW-SC-02	1/8" female NPT	12.80
PW-SC-04	1/4" female NPT	13.30
PW-SC-06	3/8" female NPT	13.60



Note: For Pressure Washer Swivel Joints, see the Accessories section in this catalog - Section 16

WASHDOWN & PRESSURE WASH

Spray tips are designated by the spray angle (a narrower angle produces more force over a small area, which is great for tough jobs but may gouge or strip softer surfaces), and by orifice size. The orifice size designates the gallons per minute flow at 4000 psi. For pumps operating at other pressures, the correct orifice can be chosen from the chart. Using a larger orifice than recommended will cause loss of cleaning pressure. Using a smaller orifice will mean less flow of water at the maximum pump pressure.

Spray tips are available color coded by spray angle with quick disconnect ends, or with 1/4" male NPT ends. Common nozzles are shown below. Other sizes are available on request.

PRESSURE WASH SPRAY TIPS

Part No.	Color	Angle	Orifice	PRICE EACH
----------	-------	-------	---------	------------

RED 0° ANGLE NOZZLES FOR BLASTING

PW-S00-4	Red	0°	4.0	\$8.80
PW-S00-5	Red	0°	5.0	8.80



YELLOW 15° ANGLE NOZZLES FOR CLEANING HARD SURFACES

PW-S15-4	Yellow	15°	4.0	8.80
PW-S15-5	Yellow	15°	5.0	8.80



GREEN 25° ANGLE NOZZLES FOR FLUSHING AND WET SWEEPING

PW-S25-4	Green	25°	4.0	8.80
PW-S25-5	Green	25°	5.0	8.80



WHITE 40° ANGLE NOZZLES FOR WASHING SOFT SURFACES

PW-S40-4	White	40°	4.0	8.80
PW-S40-5	White	40°	5.0	8.80



NOZZLE KITS - SET OF FOUR NOZZLES

PW-S-KIT-4	Four colors	0,15,40,soap	4.0	33.60
PW-S-KIT-5	Four colors	0,15,40,soap	5.0	33.60

BLACK UNIVERSAL SOAP TIP

PW-SOAP	Black			8.80
---------	-------	--	--	------



1/4" MALE NPT NOZZLES

PW-T00-4		0°	4.0	8.80
PW-T00-5		0°	5.0	8.80
PW-T15-4		15°	4.0	8.80
PW-T15-5		15°	5.0	8.80
PW-T15-8		15°	8.0	8.80
PW-T25-4		25°	4.0	8.80
PW-T25-5		25°	5.0	8.80
PW-T25-8		25°	8.0	8.80
PW-T40-4		40°	4.0	8.80
PW-T40-5		40°	5.0	8.80



To choose the correct nozzle, find the pump pressure of your machine in the top row of the chart below. In that column, choose the row that shows the flow of your pressure washer. In the left column you will find the appropriate nozzle orifice size.

Orifice	Flow in gallons per minute (GPM) at various pump pressures							
	Pump Pressure							
	500	1000	1500	2000	2500	3000	4000	5000
3.0	1.0	1.5	1.8	2.1	2.3	2.5	3.0	3.3
3.5	1.2	1.8	2.1	2.5	2.8	3.0	3.5	3.9
4.0	1.4	2.0	2.4	2.8	3.1	3.5	4.0	4.5
4.5	1.5	2.2	2.7	3.1	3.5	3.8	4.5	5.0
5.0	1.8	2.5	3.1	3.5	3.9	4.3	5.0	5.6
5.5	1.9	2.8	3.4	3.9	4.3	4.8	5.5	6.2
6.0	2.1	3.0	3.7	4.2	4.7	5.2	6.0	6.7
6.5	2.3	3.3	4.0	4.6	5.1	5.6	6.5	7.3
7.0	2.5	3.5	4.3	4.9	5.5	6.1	7.0	7.8
7.5	2.7	3.8	4.6	5.3	5.9	6.5	7.5	8.4
8.0	2.8	4.0	4.9	5.7	6.3	6.9	8.0	8.9
8.5	3.0	4.3	5.2	6.0	6.7	7.4	8.5	9.5
9.0	3.2	4.5	5.5	6.4	7.1	7.8	9.0	10.1
10.0	3.5	5.0	6.1	7.1	7.9	8.7	10.0	11.2
12.5	4.4	6.3	7.7	8.8	9.8	10.8	12.5	14.0
15.0	5.3	7.5	9.2	10.6	11.8	12.9	15.0	16.8

ROTARY NOZZLE



PW-RN-04	Rotary Nozzle with 1/4" quick disconnect and in-line filter	\$123.90
----------	---	----------

GARDEN HOSE NOZZLES & CONNECTORS

All of our pistol grip nozzles have full size bodies with insulated grips. Additional features are listed below:

Part No. **Description** **PRICE EACH**

PISTOL GRIP NOZZLES & ATTACHMENTS



571TFRL		
571TFRL	Heavy duty nozzle rated to 38°C (100°F) Includes threaded front and rubber cap	\$14.50
572TFRL	As above but with brass nozzle insert For temperatures to 38°C (100°F)	17.30
0314	Rain shower attachment Threads onto 571TFRL or 572TFRL	9.00

TRIGGER GUARD NOZZLE

50502	Insulated nozzle	28.10
-------	------------------	-------



GREEN PLASTIC FOG NOZZLE

G97-GHT	Garden hose thread	18.90
---------	--------------------	-------

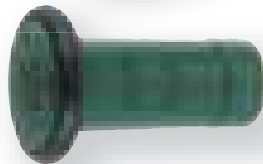

BRASS NOZZLES

Nozzles without shut-offs

G37M-GHT	Miniature brass tapered nozzle with 1/8" orifice	4.80
G37-GHT	Long brass tapered nozzle with 1/4" orifice	12.10

Twist shut-off nozzles

G97B-GHT	Miniature brass twist nozzle	7.50
G37AB-GHT	4" long twist nozzle	6.90
528	Gilmour heavy-duty twist nozzle with rubber grip	18.60



These plant washdown nozzles come in two sizes. The standard nozzles weigh just under 3 lb and measure about 6 1/2" long and high. The aluminum nozzle is full size but lighter in weight. Some users prefer the new Junior model, which weighs just 2 lb and measures in at 5 1/4". All nozzles are rated for a maximum of 150 psi water up to 93°C and are NOT for use with steam.

HOT WATER WASHDOWN NOZZLES & SWIVEL HOSE BARBS



Part No.	NPT Size	Hose Size	Description	PRICE EACH
S-150-W	1/2"		White standard spray nozzle	\$267.40
S-150-BL	1/2"		Blue standard spray nozzle	257.50
S-150-A	1/2"		Aluminum spray nozzle	219.70
S-150-JR-B	3/8"		Black junior spray nozzle	173.10

The brass and stainless steel swivel hose barbs listed here are generally used with these nozzles to reduce wrist fatigue but are ordered separately, depending on size required. They are supplied with hanger rings.

Part No.	NPT Size	Hose Size	Description	PRICE EACH
----------	----------	-----------	-------------	------------

SWIVEL HOSE BARBS & ADAPTERS



G0716SX-08	1/2"	GHT	Fits standard nozzle	\$68.90
G23SSX-050-050	1/2"	1/2"	Fits standard nozzle	60.00
G23SSX-050-075	1/2"	3/4"	Fits standard nozzle	69.70
G23SSX-038-075	3/8"	3/4"	Fits junior nozzle	63.10

See our stainless steel hose hangers in Section 16 of this catalog

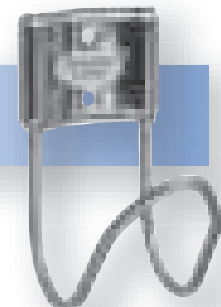

GARDEN HOSE COUPLINGS & ADAPTERS

Part No. Description PRICE EACH

G07Y77... 'Y' COUPLINGS

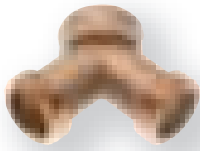

G07Y77B



G07Y77Z



G07Y77BV

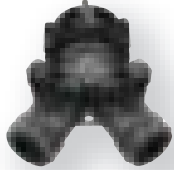

G07Y77PVG

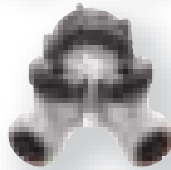

G07Y77ZV

G07Y77B	Forged brass	\$8.10
G07Y77Z	Cast zinc	7.60
G07Y77BV	Forged brass with valves	20.90
G07Y77PVG	Grey plastic with valves, heavier pattern	6.10
G07Y77ZV	Cast zinc with valves	12.90

Part Number Hose I.D. PRICE EACH Loose Std Pkg Pkg Qty

G36BM... MALE GARDEN HOSE INSERT

G36BM-038	3/8"	\$4.40	\$4.10	5
G36BM-050	1/2"	4.30	4.00	5
G36BM-063	5/8"	4.50	4.20	5
G36BM-075	3/4"	4.60	4.30	5

G36BFH... FEMALE GARDEN HOSE INSERT

G36BFH-038	3/8"	5.10	4.50	5
G36BFH-050	1/2"	4.40	4.10	5
G36BFH-063	5/8"	4.40	4.10	5
G36BFH-075	3/4"	5.10	4.50	5

G36BLF... LONG SHANK FEMALE GARDEN HOSE INSERT

G36BLF-050	1/2"	10.30	1
G36BLF-063	5/8"	10.30	1
G36BLF-075	3/4"	10.30	1

G36BLM... LONG SHANK MALE GARDEN HOSE INSERT

G36BLM-050	1/2"	9.50	1
G36BLM-063	5/8"	9.50	1
G36BLM-075	3/4"	9.50	1

For nylon garden hose couplings, see the NYLON & POLYPROPYLENE section of this catalog.

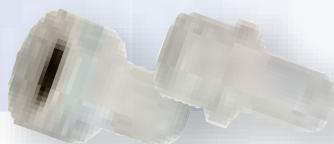

Part Number Hose I.D. PRICE EACH Loose Std Pkg Pkg Qty

G36... GARDEN HOSE WASHERS



G36RG



G36SG



G36VG

Material

G36RG	Rubber	\$0.22	\$0.19	10
G36SG	Stainless Screen	0.90	0.81	10
G36VG	Vinyl	0.22	0.19	10

V10-1707PG... PLASTIC GARDEN HOSE VALVE

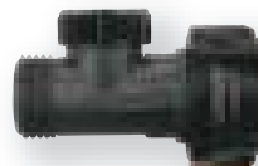

V10-1707PG Premium with swivel nut 4.10

V10-1707 brass garden hose shut off valves feature large 9/16" ports for better flow and are much more robust than typical home garden valves.

Part No. Pipe Size IMPA Code PRICE EACH

V10-1707... FEMALE GARDEN HOSE INLET/MALE GHT OUTLET

V10-1707	GHT		\$32.40
----------	-----	--	---------

V10-1707CV... CHECK VALVE

V10-1707CV	GHT		8.00
------------	-----	--	------

Vacuum breaker fittings are designed to prevent cross connection in a potable water supply. If the pressure suddenly drops in a water system, backflow can sometimes occur from a garden hose connected to an outside faucet. These backflow preventers meet CSA B64.2 standards and feature a manual drain feature on the stem and a break-away set screw for permanent installation and tamper prevention.

GARDEN HOSE ADAPTERS

Part Number	Thread Size	PRICE EACH		Pkg Qty
		Loose	Std Pkg	

G0707BSW... SWIVEL FEMALE COUPLING



G0707BSW	GHT	\$5.70	\$5.10	5
----------	-----	--------	--------	---

G0700B... MACHINED BRASS CAP



G0700B	GHT	2.30	2.10	5
G0700B-WC	GHT with chain	6.00	5.40	1

G1717B... MALE COUPLING



G1717B	GHT	3.90	3.50	1
--------	-----	------	------	---

All of our garden hose brass fittings are now lead-free.

Part Number	Pipe Size	PRICE EACH		Pkg Qty
		Loose	Std Pkg	

G0708B... FEMALE GHT TO FEMALE PIPE



G0708B-08	1/2"	\$3.70		1
G0708B-12	3/4"	4.70		1

G0716B... FEMALE GHT TO MALE PIPE



G0716B-08	1/2"	4.40		1
G0716B-12	3/4"	\$5.70	5.10	5

G1708B... MALE GHT TO FEMALE PIPE



G1708B-04	1/4"	4.40		1
G1708B-06	3/8"	5.90		1
G1708B-08	1/2"	3.80	3.40	5
G1708B-12	3/4"	5.20		1

G0708BSW... FEMALE GHT SWIVEL TO FEMALE PIPE



G0708BSW-08	1/2"	6.20	5.60	5
G0708BSW-12	3/4"	7.00	6.50	5

G0716BS... FEMALE GHT SWIVEL TO MALE PIPE



G0716BS-04	1/4"	6.30		1
G0716BS-06	3/8"	6.50		1
G0716BS-08	1/2"	6.60	6.00	5
G0716BS-12	3/4"	8.20		1

G1716B... MALE GHT TO MALE PIPE



G1716B-06	3/8"	4.70		1
G1716B-08	1/2"	4.80	4.30	5
G1716B-12	3/4"	4.90	4.30	5

BRASS HOSE BARBS



For clamshell packaged parts add:
PAK to the part number.
Eg... G20B-025:PAK, etc.

Part Number	Pipe Size	Hose I.D.	PRICE EACH Loose	PRICE EACH Std Pkg	Pkg Qty
-------------	-----------	-----------	------------------	--------------------	---------

G20B... BRASS HOSE MENDER



G20B-013	1/8"			\$1.50	1
G20B-019	3/16"		\$ 1.90	1.70	5
G20B-025	1/4"		1.70	1.50	5
G20B-031	5/16"		1.70	1.50	5
G20B-038	3/8"		1.60	1.40	5
G20B-050	1/2"		2.20	2.00	5
G20B-063	5/8"			3.20	1
G20B-075	3/4"			3.80	1

G20B90... 90° BRASS HOSE MENDER

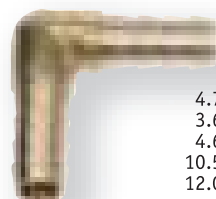

G20B90-025	1/4"			4.70	1
G20B90-038	3/8"			3.60	1
G20B90-050	1/2"			4.60	1
G20B90-063	5/8"			10.50	1
G20B90-075	3/4"			12.00	1

G20BT... BRASS HOSE TEE



G20BT-025	1/4"			3.50	1
G20BT-031	5/16"			4.60	1
G20BT-038	3/8"			4.70	1
G20BT-050	1/2"			6.30	1
G20BT-063	5/8"			8.70	1
G20BT-075	3/4"			14.80	1

G21B... MALE NPT HOSE BARB



G21B-013-013	1/8"	1/8"	1.12	0.98	5
G21B-013-019	1/8"	3/16"	1.18	1.08	5
G21B-013-025	1/8"	1/4"	1.29	1.13	5
G21B-013-031	1/8"	5/16"	1.29	1.14	5
G21B-013-038	1/8"	3/8"	1.52	1.29	5
G21B-025-013	1/4"	1/8"		1.60	1
G21B-025-019	1/4"	3/16"	1.30	1.20	5
G21B-025-025	1/4"	1/4"	1.35	1.23	5
G21B-025-031	1/4"	5/16"	1.60	1.50	5
G21B-025-038	1/4"	3/8"	1.35	1.24	5
G21B-025-050	1/4"	1/2"	2.00	1.80	5
G21B-038-025	3/8"	1/4"	2.10	1.90	5
G21B-038-031	3/8"	5/16"	2.30	2.10	5
G21B-038-038	3/8"	3/8"	2.20	1.90	5
G21B-038-050	3/8"	1/2"	2.30	2.00	5
G21B-038-063	3/8"	5/8"	2.40	2.20	5
G21B-050-025	1/2"	1/4"		4.60	1
G21B-050-038	1/2"	3/8"	3.20	3.00	5
G21B-050-050	1/2"	1/2"	3.40	3.20	5
G21B-050-063	1/2"	5/8"	3.80	3.40	5
G21B-050-075	1/2"	3/4"	3.90	3.70	5
G21B-075-050	3/4"	1/2"	7.80	7.00	5
G21B-075-063	3/4"	5/8"	6.90	6.10	5
G21B-075-075	3/4"	3/4"	5.40	4.90	5
G21B-075-100	3/4"	1"	6.30	5.70	5
G21B-100-075	1"	3/4"		9.50	1
G21B-100-100	1"	1"	10.10	9.10	5

Part Number	Pipe Size	Hose I.D.	PRICE EACH Loose	PRICE EACH Std Pkg	Pkg Qty
-------------	-----------	-----------	------------------	--------------------	---------

G21B45... 45° MALE NPT HOSE BARB



G21B45-013-038	1/8"	3/8"		\$5.90	1
G21B45-025-038	1/4"	3/8"	\$6.90	6.10	5
G21B45-038-038	3/8"	3/8"		9.20	1
G21B45-038-050	3/8"	1/2"	9.20	8.50	5

G21B90... 90° MALE NPT HOSE BARB



G21B90-013-019	1/8"	3/16"		3.00	1
G21B90-013-025	1/8"	1/4"	3.30	3.00	5
G21B90-013-031	1/8"	5/16"		3.30	1
G21B90-013-038	1/8"	3/8"	3.70	3.30	5
G21B90-025-025	1/4"	1/4"	3.70	3.30	5
G21B90-025-031	1/4"	5/16"		3.30	1
G21B90-025-038	1/4"	3/8"	3.80	3.40	5
G21B90-025-050	1/4"	1/2"	5.70	5.20	5
G21B90-038-025	3/8"	1/4"		5.50	1
G21B90-038-031	3/8"	5/16"		4.50	1
G21B90-038-038	3/8"	3/8"	4.80	4.20	5
G21B90-038-050	3/8"	1/2"	6.00	5.60	5
G21B90-038-063	3/8"	5/8"		4.80	1
G21B90-050-038	1/2"	3/8"		7.50	1
G21B90-050-050	1/2"	1/2"	8.80	7.70	5
G21B90-050-063	1/2"	5/8"		5.10	1
G21B90-050-075	1/2"	3/4"		16.60	1
G21B90-075-075	3/4"	3/4"		14.70	1

G21BLM... LIVE MALE NPT SWIVEL HOSE BARB

G21BLM-025-025	1/4"	1/4"		5.00	1
G21BLM-025-038	1/4"	3/8"		5.70	1
G21BLM-038-038	3/8"	3/8"		8.10	1
G21BLM-038-050	3/8"	1/2"		8.10	1
G21BLM-050-050	1/2"	1/2"		8.70	1

G21BRI... REUSABLE MALE NPT HOSE INSERT



G21BRI-025-038	1/4"	3/8"		3.30	1
G21BRI-038-038	3/8"	3/8"	4.00	3.60	5

G21BRS... REUSABLE HOSE SOCKET



G21BRS-038-063	3/8"	5/8"	4.00	3.60	5
G21BRS-038-069	3/8"	11/16"		4.20	1
G21BRS-038-075	3/8"	3/4"		4.00	1

BRASS HOSE BARBS

WELDING HOSE FITTINGS

Part Number	Pipe Size	Hose I.D.	PRICE EACH		Pkg Qty
			Loose	Std Pkg	

G22B... FEMALE NPT HOSE BARB



G22B-013-013	1/8"	1/8"		\$2.00	1
G22B-013-025	1/8"	1/4"	\$2.00	1.80	5
G22B-013-038	1/8"	3/8"	3.00	2.50	5
G22B-025-013	1/4"	1/8"		3.20	1
G22B-025-025	1/4"	1/4"	2.10	2.00	5
G22B-025-031	1/4"	5/16"		2.60	1
G22B-025-038	1/4"	3/8"	2.20	2.00	5
G22B-025-050	1/4"	1/2"		3.50	1
G22B-038-025	3/8"	1/4"		3.20	1
G22B-038-038	3/8"	3/8"		3.00	1
G22B-038-050	3/8"	1/2"	4.00	3.60	5
G22B-050-038	1/2"	3/8"		3.90	1
G22B-050-050	1/2"	1/2"		4.80	1

G22BFS... FEMALE NPSM SWIVEL HOSE BARB



G22BFS-013-019	1/8"	3/16"		3.40	1
G22BFS-013-025	1/8"	1/4"		3.70	1
G22BFS-025-019	1/4"	3/16"		4.00	1
G22BFS-025-025	1/4"	1/4"	2.90	2.60	5
G22BFS-025-031	1/4"	5/16"		3.70	1
G22BFS-025-038	1/4"	3/8"		3.10	1
G22BFS-038-025	3/8"	1/4"	5.70	5.00	5
G22BFS-038-038	3/8"	3/8"	3.60	3.40	5
G22BFS-038-050	3/8"	1/2"		7.70	1
G22BFS-050-050	1/2"	1/2"		4.70	1
G22BFS-075-075	3/4"	3/4"		12.30	1

G21SAE... MALE SAE HOSE BARB



Part Number	Tube O.D.	Hose I.D.	PRICE EACH		Pkg Qty
			Loose	Std Pkg	
G21SAE-025-025	1/4"	1/4"		3.30	1
G21SAE-038-025	3/8"	1/4"		3.30	1
G21SAE-038-038	3/8"	3/8"		3.30	1

G22SAE... FEMALE SAE SWIVEL HOSE BARB



Part Number	Tube O.D.	Hose I.D.	PRICE EACH		Pkg Qty
			Loose	Std Pkg	
G22SAE-019-019	3/16"	3/16"		2.20	1
G22SAE-025-025	1/4"	1/4"		2.30	1
G22SAE-031-031	5/16"	5/16"		2.70	1
G22SAE-038-025	3/8"	1/4"		2.60	1
G22SAE-038-031	3/8"	5/16"		6.00	1
G22SAE-038-038	3/8"	3/8"		3.40	1
G22SAE-050-050	1/2"	1/2"		4.90	1

Part Number	Pipe Size	PRICE EACH		Pkg Qty
		Loose	Std Pkg	

G42... WELDING HOSE INSERT



G42-019	3/16"	\$2.00	\$1.90	5
G42-025	1/4"	2.00	1.90	5
G42-031	5/16"		2.00	1
G42-038	3/8"		2.00	1

G4... WELDING HOSE COLLAR



G4-019	3/16"	2.40	1.90	5
G4-025	1/4"	2.60	2.00	5

G40L... ACETYLENE UNION CONNECTOR



Part Number	Type	Thread Size	PRICE EACH	Pkg Qty
G40L	Acetylene	9/16-18 Left	3.60	1

G40R... OXYGEN UNION CONNECTOR



G40R	Oxygen	9/16-18 Right	3.60	1
------	--------	---------------	------	---

G43... TYPE "B" WELDING HOSE NUT

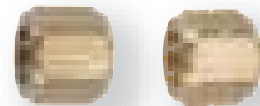

G43L	Acetylene	9/16-18 Left	1.70	1.50	10
G43R	Oxygen	9/16-18 Right	1.70	1.50	10

G41L... ACETYLENE (LEFT HAND) OUTLET ADAPTER



Part Number	Pipe Size	Thread Size	PRICE EACH	Pkg Qty
G41L-025	1/4"	9/16-18 Left	3.70	1
G41L-038	3/8"	9/16-18 Left	5.00	1

G41R... OXYGEN (RIGHT HAND) OUTLET ADAPTER



G41R-025	1/4"	9/16-18 Right	3.70	1
G41R-038	3/8"	9/16-18 Right	5.20	1

7

Brass

PUSH-ON FITTINGS

Push-on fittings have aggressive barbs that are designed to work without clamps **ONLY** on push-on hose. They will not hold pressure on ordinary general purpose hoses. Adding clamps when using push-on fittings may cause premature failure due to cutting of the hose tube under the clamp. For general purpose hoses or for applications where clamps are used, we recommend the regular brass hose barbs (see G20B, G21B, G22B, etc.)

Part Number	Hose I.D.	PRICE EACH		Pkg Qty
		Loose	Std Pkg	

G2000... HOSE MENDER

G2000-04	1/4"	\$2.20	\$2.00	5
G2000-06	3/8"	2.90	2.50	5
G2000-08	1/2"	3.70	3.40	5
G2000-10	5/8"	6.90	6.20	5
G2000-12	3/4"	8.00	7.20	5

G2001... PLAIN TUBE END

Part Number	Hose I.D.	Tube Size	PRICE EACH		Pkg Qty
			Loose	Std Pkg	
G2001-04-04	1/4"	1/4"	2.90	1	
G2001-05-04	5/16"	1/4"	3.60	1	
G2001-06-06	3/8"	3/8"	3.50	1	

G2002... FEMALE INVERTED FLARE

G2002-03-04	3/16"	1/4"	3.90	1
G2002-04-04	1/4"	1/4"	3.40	1
G2002-05-04	5/16"	1/4"	3.50	1
G2002-06-06	3/8"	3/8"	4.60	1

G2004... SAE 45° FEMALE SWIVEL

G2004-04-04	1/4"	1/4"	2.20	2.00	5
G2004-05-04	5/16"	1/4"	3.40	1	
G2004-05-05	5/16"	5/16"	3.60	1	
G2004-06-06	3/8"	3/8"	3.80	3.40	5
G2004-06-08	3/8"	1/2"	8.50	1	
G2004-08-06	1/2"	3/8"	4.90	1	
G2004-08-08	1/2"	1/2"	4.20	3.90	5
G2004-08-10	1/2"	5/8"	8.10	1	
G2004-10-08	5/8"	1/2"	7.20	1	
G2004-10-10	5/8"	5/8"	8.00	7.10	5
G2004-12-12	3/4"	3/4"	8.20	1	

G2005... JIC 37° FEMALE SWIVEL

G2005-06-06	3/8"	3/8"	2.80	2.60	5
G2005-12-12	3/4"	3/4"	10.60	9.40	5

G2006... FEMALE PIPE SWIVEL BALL SEAT STYLE

Part Number	Hose I.D.	Pipe Size	PRICE EACH		Pkg Qty
			Loose	Std Pkg	
G2006-02-04	1/8"	1/4"	5.20	1	
G2006-04-04	1/4"	1/4"	4.70	1	
G2006-04-06	1/4"	3/8"	5.30	1	
G2006-06-06	3/8"	3/8"	7.00	1	
G2006-08-08	1/2"	1/2"	7.80	1	

Part Number	Hose I.D.	PRICE EACH		Pkg Qty
		Loose	Std Pkg	

G2008... NPT FEMALE SOLID PUSH-ON FITTING

Part Number	Hose I.D.	Pipe Size	PRICE EACH		Pkg Qty
			Loose	Std Pkg	
G2008-02-04	1/8"	1/4"	\$3.00	1	
G2008-04-04	1/4"	1/4"	3.00	1	
G2008-06-06	3/8"	3/8"	4.10	1	
G2008-08-08	1/2"	1/2"	5.80	1	

G2012... MALE INVERTED FLARE

Part Number	Hose I.D.	Tube Size	PRICE EACH		Pkg Qty
			Loose	Std Pkg	
G2012-03-04	3/16"	1/4"	5.50	1	
G2012-04-04	1/4"	1/4"	3.80	1	
G2012-05-04	5/16"	1/4"	4.00	1	
G2012-06-06	3/8"	3/8"	4.90	1	
G2012-08-08	1/2"	1/2"	9.00	1	
G2012-10-10	5/8"	5/8"	12.30	1	

G2014... SAE 45° MALE

G2014-04-04	1/4"	1/4"	2.70	1
G2014-05-04	5/16"	1/4"	3.60	1
G2014-06-06	3/8"	3/8"	3.40	1
G2014-08-08	1/2"	1/2"	6.30	1
G2014-10-10	5/8"	5/8"	8.90	1

G2015... JIC 37° MALE

G2015-06-06	3/8"	3/8"	3.60	1
-------------	------	------	------	---

G2016... NPTF MALE

Part Number	Hose I.D.	Pipe Size	PRICE EACH		Pkg Qty
			Loose	Std Pkg	
G2016-02-04	1/8"	1/4"	1.70	1.50	5
G2016-02-06	1/8"	3/8"	2.90	1	
G2016-04-04	1/4"	1/4"	2.00	1.80	5
G2016-04-05	1/4"	5/16"	2.50	2.20	5
G2016-04-06	1/4"	3/8"	2.10	1.80	5
G2016-04-08	1/4"	1/2"	3.60	1	
G2016-06-04	3/8"	1/4"	3.00	1	
G2016-06-06	3/8"	3/8"	2.70	2.20	5
G2016-06-08	3/8"	1/2"	2.90	2.50	5
G2016-06-10	3/8"	5/8"	6.40	1	
G2016-08-06	1/2"	3/8"	3.80	3.40	5
G2016-08-08	1/2"	1/2"	3.50	3.30	5
G2016-08-10	1/2"	5/8"	5.30	4.90	5
G2016-08-12	1/2"	3/4"	7.30	1	
G2016-12-08	3/4"	1/2"	7.80	1	
G2016-12-10	3/4"	5/8"	6.90	1	
G2016-12-12	3/4"	3/4"	6.80	6.30	5

BRASS PIPE FITTINGS



For clamshell packaged parts add:
PAK to the part number.
Eg... G0808B-04-04:PAK, etc.

Note: The pipe fittings shown here are extruded, machined or forged parts. Cast brass parts are available in larger sizes and are listed at the end of this section.

Part Number	Pipe Size	PRICE EACH		Pkg Qty
		Loose	Std Pkg	
G1600B... HEX HEAD PLUG				
G1600B-02	1/8"	\$0.51	\$0.45	5
G1600B-04	1/4"	1.01	0.87	5
G1600B-06	3/8"	1.34	1.14	5
G1600B-08	1/2"	2.50	2.30	5
G1600B-12	3/4"		4.10	1
G1600B-16	1"		10.50	1



G1600HB... HOLLOW HEX HEAD PLUG

G1600HB-02	1/8"	0.73	0.60	5
G1600HB-04	1/4"	1.09	0.96	5
G1600HB-06	3/8"	1.57	1.30	5
G1600HB-08	1/2"	2.50	2.30	5
G1600HB-12	3/4"		4.10	1



G1600SB... BRASS SQUARE HEAD PIPE PLUG

G1600SB-02	1/8"	0.76	0.63	5
G1600SB-04	1/4"	1.09	0.94	5
G1600SB-06	3/8"	1.70	1.60	5
G1600SB-08	1/2"		3.30	1
G1600SB-12	3/4"		7.20	1



G1600SLB... BRASS SLOTTED HEAD PIPE PLUG

G1600SLB-02	1/8"		1.40	1
G1600SLB-04	1/4"		1.20	1
G1600SLB-06	3/8"		3.10	1



G0008B... LOCKNUT

G0008B-02	1/8"		1.29	1
G0008B-04	1/4"		1.90	1
G0008B-06	3/8"		2.20	1
G0008B-08	1/2"		2.20	1
G0008B-12	3/4"		4.40	1



G0800B... CAP

G0800B-02	1/8"		1.10	1
G0800B-04	1/4"		1.42	5
G0800B-06	3/8"	1.80	2.90	5
G0800B-08	1/2"		3.80	1
G0800B-12	3/4"		6.10	1



Part Number	Pipe Size	Pipe Size	Length	PRICE EACH		Pkg Qty
				Loose	Std Pkg	

G0808BBH... BULKHEAD COUPLING

G0808BBH-02-02	1/8"	1/8"	1.50"	13.00	11.70	5
G0808BBH-04-04	1/4"	1/4"	1.50"	10.50	9.40	5
G0808BBH-06-06	3/8"	3/8"	1.32"	13.70	11.90	5
G0808BBH-08-08	1/2"	1/2"	1.50"	16.20	14.60	5
G0808BBHS-04-04	1/4"	1/4"	1.00"		9.10	1



G0808BH... STEEL BULKHEAD COUPLING

G0808BH-04-04	1/4"	1/4"	0.95"	7.80	7.10	5
G0808BH-06-06	3/8"	3/8"	1.45"	9.10	8.20	5
G0808BHL-04-04	1/4"	1/4"	1.50"		12.10	1



G0816BH... STEEL BULKHEAD FITTING

G0816BH-08-04	1/2"	1/4"	2.13"		16.10	1
G0816BH-08-06	1/2"	3/8"	2.13"		13.30	1



G0808B... FEMALE COUPLING

G0808B-02-02	1/8"	1/8"		1.45	1.20	5
G0808B-04-02	1/4"	1/8"			2.00	1
G0808B-04-04	1/4"	1/4"		2.30	1.90	5
G0808B-06-02	3/8"	1/8"			3.90	1
G0808B-06-04	3/8"	1/4"		2.80	2.40	5
G0808B-06-06	3/8"	3/8"		2.50	2.20	5
G0808B-08-04	1/2"	1/4"			3.60	1
G0808B-08-06	1/2"	3/8"			4.10	1
G0808B-08-08	1/2"	1/2"		4.20	3.90	5
G0808B-12-08	3/4"	1/2"			8.70	1
G0808B-12-12	3/4"	3/4"			5.90	1



G0816B... BUSHING

G0816B-04-02	1/4"	1/8"		0.90	0.76	5
G0816B-06-02	3/8"	1/8"		1.27	1.17	5
G0816B-06-04	3/8"	1/4"		1.14	0.99	5
G0816B-08-02	1/2"	1/8"			1.80	1
G0816B-08-04	1/2"	1/4"		2.00	1.70	5
G0816B-08-06	1/2"	3/8"		1.70	1.60	5
G0816B-12-02	3/4"	1/8"			7.30	1
G0816B-12-04	3/4"	1/4"		3.80	3.40	5
G0816B-12-06	3/4"	3/8"		3.80	3.40	5
G0816B-12-08	3/4"	1/2"		3.30	3.10	5
G0816B-16-04	1"	1/4"			10.10	1
G0816B-16-06	1"	3/8"			9.40	1
G0816B-16-08	1"	1/2"			8.90	1
G0816B-16-12	1"	3/4"			8.60	1



BRASS PIPE FITTINGS

Note: The pipe fittings shown here are extruded, machined or forged parts. Cast brass parts are available in larger sizes and are listed at the end of this section.

Part Number	Male Pipe	Female Pipe	PRICE EACH		Pkg Qty
			Loose	Std Pkg	
G1608B... REDUCING ADAPTER					
					
G1608B-01-02	1/16"	1/8"		\$8.90	1
G1608B-02-02	1/8"	1/8"	\$0.95	0.85	5
G1608B-02-04	1/8"	1/4"	1.80	1.60	5
G1608B-02-06	3/8"	3/8"		3.80	1
G1608B-04-04	1/4"	1/4"	1.80	1.70	5
G1608B-04-06	1/4"	3/8"	2.70	2.40	5
G1608B-04-08	1/4"	1/2"	4.80	4.20	5
G1608B-06-06	3/8"	3/8"		2.30	1
G1608B-06-08	3/8"	1/2"	3.30	3.10	5
G1608B-08-08	1/2"	1/2"		3.60	1
G1608B-08-12	1/2"	3/4"		7.10	1

G1616B... HEX NIPPLE

Part Number	Pipe Size		PRICE EACH		Pkg Qty
	Male Pipe	Female Pipe	Loose	Std Pkg	
					
G1616B-02-02	1/8"	1/8"	0.83	0.71	5
G1616B-04-02	1/4"	1/8"	1.70	1.42	5
G1616B-04-04	1/4"	1/4"	1.46	1.24	5
G1616B-06-02	3/8"	1/8"	2.90	2.70	5
G1616B-06-04	3/8"	1/4"	1.90	1.70	5
G1616B-06-06	3/8"	3/8"	1.90	1.70	5
G1616B-08-04	1/2"	1/4"		4.20	1
G1616B-08-06	1/2"	3/8"	3.30	3.10	5
G1616B-08-08	1/2"	1/2"	3.70	3.40	5
G1616B-12-08	3/4"	1/2"		5.80	1
G1616B-12-12	3/4"	3/4"	5.90	5.50	5
G1616B-16-16	1"	1"		21.00	1

G1616BC... CLOSE NIPPLE

Part Number	Pipe Size	PRICE EACH		Pkg Qty
		Loose	Std Pkg	
				
G1616BC-02	1/8"	0.71	0.59	5
G1616BC-04	1/4"	0.85	0.80	5
G1616BC-06	3/8"	1.40	1.18	5
G1616BC-08	1/2"	2.20	1.90	5
G1616BC-12	3/4"		4.50	1
G1616BC-16	1"		9.10	1
G1616BC-125	1 1/4"		12.00	1
G1616BC-150	1 1/2"		15.50	1
G1616BC-200	2"		23.30	1

Part Number	Male Pipe	Female Pipe	PRICE EACH		Pkg Qty
			Loose	Std Pkg	

G1616BL... LONG NIPPLE

Part Number	Male Pipe	Female Pipe	PRICE EACH		Pkg Qty
			Loose	Std Pkg	
					
G1616BL-02X1.5	1/8"	1.5"	\$	1.42	1
G1616BL-02X2	1/8"	2.0"		1.90	1
G1616BL-02X2.5	1/8"	2.5"		2.50	1
G1616BL-02X3	1/8"	3.0"		3.70	1
G1616BL-02X4	1/8"	4.0"		5.90	1
G1616BL-04X1.5	1/4"	1.5"		1.80	1
G1616BL-04X2	1/4"	2.0"		2.00	1
G1616BL-04X2.5	1/4"	2.5"		4.10	1
G1616BL-04X3	1/4"	3.0"		4.90	1
G1616BL-04X4	1/4"	4.0"		5.70	1
G1616BL-04X6	1/4"	6.0"		7.30	1
G1616BL-06X1.5	3/8"	1.5"		2.90	1
G1616BL-06X2	3/8"	2.0"		3.60	1
G1616BL-06X2.5	3/8"	2.5"		4.60	1
G1616BL-06X3	3/8"	3.0"		5.80	1
G1616BL-06X4	3/8"	4.0"		7.10	1
G1616BL-06X4.5	3/8"	4.5"		8.10	1
G1616BL-06X6	3/8"	6.0"		10.90	1
G1616BL-08X1.5	1/2"	1.5"		3.30	1
G1616BL-08X2	1/2"	2.0"		4.80	1
G1616BL-08X2.5	1/2"	2.5"		6.20	1
G1616BL-08X3	1/2"	3.0"		7.50	1
G1616BL-08X4	1/2"	4.0"		8.10	1
G1616BL-08X6	1/2"	6.0"		9.90	1
G1616BL-12X2	3/4"	2.0"		7.50	1
G1616BL-125X2	1 1/4"	2"		15.20	1
G1616BL-150X2	1 1/2"	2"		17.70	1
G1616BL-150X3	1 1/2"	3"		28.10	1
G1616BL-150X6	1 1/2"	6"		51.70	1
G1616BL-200X2.5	2"	2.5"		33.10	1
G1616BL-200X4	2"	4"		34.80	1
G1616BL-200X6	2"	6"		56.10	1

G0848B... 45° FEMALE ELBOW

Part Number	Pipe Size		PRICE EACH	
	Male Pipe	Female Pipe	Loose	Std Pkg
				
G0848B-02-02	1/8"	1/8"	5.20	1
G0848B-04-04	1/4"	1/4"	7.30	1

G0898B... 90° FEMALE ELBOW

Part Number	Pipe Size		PRICE EACH	
	Male Pipe	Female Pipe	Loose	Std Pkg
				
G0898B-02-02	1/8"	1/8"	2.20	2.00
G0898B-04-04	1/4"	1/4"	3.40	3.20
G0898B-06-06	3/8"	3/8"	5.00	4.50
G0898B-08-08	1/2"	1/2"	8.10	7.30
G0898B-12-12	3/4"	3/4"		14.50

G1696B... 90° MALE ELBOW

Part Number	Pipe Size		PRICE EACH	
	Male Pipe	Female Pipe	Loose	Std Pkg
				
G1696B-02-02	1/8"	1/8"	3.40	1
G1696B-04-04	1/4"	1/4"	3.70	1
G1696B-06-06	3/8"	3/8"	5.10	5
G1696B-08-06	1/2"	3/8"	9.10	1
G1696B-08-08	1/2"	1/2"	8.90	1

G1648B... 45° STREET ELBOW

Part Number	Pipe Size		PRICE EACH	
	Male Pipe	Female Pipe	Loose	Std Pkg
				
G1648B-02-02	1/8"	1/8"	3.00	2.70
G1648B-04-04	1/4"	1/4"	4.00	3.60
G1648B-06-06	3/8"	3/8"	5.40	5.00
G1648B-08-08	1/2"	1/2"	10.20	9.30
G1648B-12-12	3/4"	3/4"		19.00

BRASS PIPE FITTINGS

Note: The pipe fittings shown here are extruded, machined or forged parts. Cast brass parts are available in larger sizes and are listed at the end of this section.

Part Number	Male Pipe	Female Pipe	PRICE EACH		Pkg Qty
			Loose	Std Pkg	

G1698B... 90° STREET ELBOW



Male Size Female Size

G1698B-02-02	1/8"	1/8"	\$2.10	\$1.90	5
G1698B-02-04	1/8"	1/4"		4.80	1
G1698B-04-04	1/4"	1/4"	2.80	2.50	5
G1698B-04-06	1/4"	3/8"		8.20	1
G1698B-06-06	3/8"	3/8"	3.80	3.40	5
G1698B-06-08	3/8"	1/2"		14.10	1
G1698B-08-08	1/2"	1/2"	7.20	6.30	5
G1698B-12-12	3/4"	3/4"		16.00	1

G08X88B... FEMALE PIPE CROSS



Pipe Size Pipe Size

G08X88B-02-02	1/8"	1/8"	4.60	1
G08X88B-04-04	1/4"	1/4"	7.00	1
G08X88B-06-06	3/8"	3/8"	9.40	1
G08X88B-08-08	1/2"	1/2"	18.00	1

G08T86B... MALE BRANCH TEE



G08T86B-02-02	1/8"	1/8"	3.60	1
G08T86B-04-04	1/4"	1/4"	6.30	1
G08T86B-06-06	3/8"	3/8"	8.60	1
G08T86B-08-08	1/2"	1/2"	16.10	1

G08T88B... FEMALE PIPE TEE



G08T88B-02-02	1/8"	1/8"	2.90	2.50	5
G08T88B-04-02	1/4"	1/8"		10.50	1
G08T88B-04-04	1/4"	1/4"	4.80	4.30	5
G08T88B-06-06	3/8"	3/8"	6.00	5.60	5
G08T88B-08-08	1/2"	1/2"	9.60	8.60	5
G08T88B-12-12	3/4"	3/4"		18.00	1

G16T66B... MALE TEE



G16T66B-02-02	1/8"	1/8"	6.90	6.10	5
G16T66B-04-04	1/4"	1/4"		7.50	1
G16T66B-06-06	3/8"	3/8"		11.00	1
G16T66B-08-08	1/2"	1/2"		14.10	1

Part Number	Male Pipe	Female Pipe	PRICE EACH		Pkg Qty
			Loose	Std Pkg	

G16T88B... STREET TEE

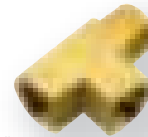

G16T88B-02-02	1/8"	1/8"	\$3.50	\$3.30	5
G16T88B-04-04	1/4"	1/4"	4.60	4.20	5
G16T88B-06-06	3/8"	3/8"	7.70	7.00	5
G16T88B-08-08	1/2"	1/2"	20.90	19.10	5

CAST BRASS PIPE FITTINGS

Note: These cast fittings are all lead free for potable water use.

Part Number	Pipe Size	Pipe Size	PRICE EACH	Pkg Qty
-------------	-----------	-----------	------------	---------

G0808B... FEMALE COUPLING



G0808B-100-100	1"	1"	12.50	1
G0808B-125-100	1 1/4"	1"	25.60	1
G0808B-125-125	1 1/4"	1 1/4"	21.20	1
G0808B-150-150	1 1/2"	1 1/2"	26.30	1
G0808B-200-200	2"	2"	43.30	1

G0816B... BUSHING

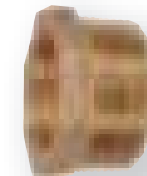

G0816B-125-050	1 1/4"	1/2"	19.10	1
G0816B-125-075	1 1/4"	3/4"	13.30	1
G0816B-125-100	1 1/4"	1"	13.30	1
G0816B-150-100	1 1/2"	1"	17.90	1
G0816B-150-125	1 1/2"	1 1/4"	17.90	1
G0816B-200-150	2"	1 1/2"	24.00	1

G0848B... 45° FEMALE ELBOW



G0848B-038-038	3/8"	3/8"	8.80	1
G0848B-050-050	1/2"	1/2"	6.90	1
G0848B-075-075	3/4"	3/4"	11.90	1
G0848B-100-100	1"	1"	21.00	1
G0848B-125-125	1 1/4"	1 1/4"	33.30	1
G0848B-150-150	1 1/2"	1 1/2"	42.00	1

G0898B... 90° FEMALE ELBOW



G0898B-075-075	3/4"	3/4"	10.00	1
G0898B-100-100	1"	1"	16.00	1
G0898B-125-125	1 1/4"	1 1/4"	25.90	1
G0898B-150-150	1 1/2"	1 1/2"	32.20	1
G0898B-200-200	2"	2"	51.90	1

CAST BRASS PIPE FITTINGS

SAE 45° FLARE FITTINGS

Part Number	Pipe Size	Pipe Size	PRICE EACH	Pkg Qty
-------------	-----------	-----------	------------	---------

G1648B... 45° STREET ELBOW

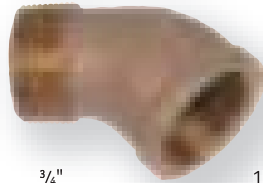

G1648B-075-075	3/4"	3/4"	17.10	1
G1648B-100-100	1"	1"	23.30	1
G1648B-125-125	1 1/4"	1 1/4"	35.40	1
G1648B-150-150	1 1/2"	1 1/2"	47.40	1

G1698B... 90° STREET ELBOW



G1698B-075-075	3/4"	3/4"	11.50	1
G1698B-100-100	1"	1"	18.90	1
G1698B-125-125	1 1/4"	1 1/4"	33.30	1
G1698B-150-150	1 1/2"	1 1/2"	41.10	1
G1698B-200-200	2"	2"	75.40	1

G08T88B... FEMALE TEE



G08T88B-075-075	3/4"	3/4"	13.70	1
G08T88B-100-100	1"	1"	21.30	1
G08T88B-125-125	1 1/4"	1 1/4"	32.60	1
G08T88B-150-150	1 1/2"	1 1/2"	43.20	1
G08T88B-200-200	2"	2"	71.60	1

SAE 45° FLARE FITTINGS

Part Number	Tube Size	PRICE EACH	Pkg Qty
		Loose Std Pkg	

G0014... MACHINED FLARE NUT



G0014-03	3/16"		0.80	1
G0014-04	1/4"	0.76	0.67	5
G0014-05	5/16"		0.96	1
G0014-06	3/8"	1.63	1.46	5
G0014-08	1/2"	2.00	1.80	5
G0014-10	5/8"		2.90	1

G0014F... FORGED FLARE NUT



G0014F-04	1/4"		1.24	1
G0014F-05	5/16"		2.70	1
G0014F-06	3/8"	1.60	1.40	5
G0014F-08	1/2"		2.00	1
G0014F-10	5/8"		3.90	1
G0014F-12	3/4"		10.60	1

Part Number	Tube Size	PRICE EACH	Pkg Qty
		Loose Std Pkg	

G0014L... LONG MACHINED FLARE NUT



G0014L-04	1/4"	\$1.20	1
G0014L-05	5/16"	1.60	1
G0014L-06	3/8"	2.10	1
G0014L-08	1/2"	4.20	1
G0014L-10	5/8"	7.00	1

G0014L-12

	3/4"	15.60	1
--	------	-------	---

G0400... SAE CAP



G0400-04	1/4"	\$0.71	0.59	5
G0400-05	5/16"		2.30	1
G0400-06	3/8"	1.42	1.14	5
G0400-08	1/2"	1.70	1.42	5
G0400-10	5/8"	2.30	2.20	5

G0400-12

	3/4"	13.20	1
--	------	-------	---

G0404... SAE FEMALE UNION



G0404-04-04	1/4"		8.00	1
G0404-06-06	3/8"		11.80	1
G0404-08-08	1/2"		31.50	1

G0404SW... SAE FEMALE SWIVEL UNION



G0404SW-04-04	1/4"		7.90	1
G0404SW-05-05	5/16"		11.10	1
G0404SW-06-06	3/8"		9.40	1
G0404SW-08-08	1/2"		10.90	1
G0404SW-10-10	5/8"		15.30	1

G0404SW-12-12

	3/4"	31.50	1
--	------	-------	---

G0414 FEMALE FLARE TO MALE FLARE

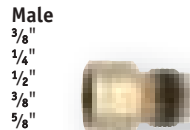

	Female	Male		
G0414-04-06	1/4"	3/8"		6.10
G0414-06-04	3/8"	1/4"		5.20
G0414-06-08	3/8"	1/2"		6.10
G0414-08-06	1/2"	3/8"		6.80
G0414-08-10	1/2"	5/8"		10.20

G0414-10-08	5/8"	1/2"		10.30
G0414-10-12	5/8"	3/4"		22.90

G0416 FEMALE FLARE TO MALE PIPE



	Pipe	Tube		
G0416-02-04	1/8"	1/4"		6.30
G0416-04-04	1/4"	1/4"		7.20
G0416-04-06	1/4"	3/8"		10.40
G0416-06-08	3/8"	1/2"		15.50
G0416-08-08	1/2"	1/2"		16.00

G1400 SAE PLUG



G1400-04	1/4"	1.29	1.07	5
G1400-05	5/16"		3.90	1
G1400-06	3/8"	1.63	1.42	5
G1400-08	1/2"	2.50	2.20	5
G1400-10	5/8"		3.40	1
G1400-12	3/4"		21.40	1

7

Brass

SAE 45° FLARE FITTINGS

Part Number	Pipe Size	Tube Size	PRICE EACH		Pkg Qty
			Loose	Std Pkg	
G1408 FEMALE CONNECTOR					
G1408-02-03	1/8"	3/16"		\$3.10	1
G1408-02-04	1/8"	1/4"		1.10	1
G1408-02-05	1/8"	5/16"		2.40	1
G1408-02-06	1/8"	3/8"		2.30	1
G1408-04-04	1/4"	1/4"		1.60	1
G1408-04-05	1/4"	5/16"		4.60	1
G1408-04-06	1/4"	3/8"		1.70	1
G1408-04-08	1/4"	1/2"		7.40	1
G1408-06-04	3/8"	1/4"		5.30	1
G1408-06-06	3/8"	3/8"		2.10	1
G1408-06-08	3/8"	1/2"		3.00	1
G1408-06-10	3/8"	5/8"		7.80	1
G1408-08-04	1/2"	1/4"		7.30	1
G1408-08-06	1/2"	3/8"		2.90	1
G1408-08-08	1/2"	1/2"		3.30	1
G1408-08-10	1/2"	5/8"		4.50	1
G1408-08-12	1/2"	3/4"		21.60	1
G1408-12-08	3/4"	1/2"		5.60	1
G1408-12-10	3/4"	5/8"		7.00	1
G1408-12-12	3/4"	3/4"		21.60	1

G1414 UNION

Part Number	Pipe Size	Tube Size	PRICE EACH		Pkg Qty
			Loose	Std Pkg	
Tube Size					
G1414-02-02	1/8"	1/8"		2.40	1
G1414-04-04	1/4"	1/4"	1.18	1.08	5
G1414-05-05	5/16"	5/16"		2.00	1
G1414-06-04	3/8"	1/4"		2.00	1
G1414-06-05	3/8"	5/16"		7.70	1
G1414-06-06	3/8"	3/8"	2.10	1.90	5
G1414-08-04	1/2"	1/4"		8.80	1
G1414-08-06	1/2"	3/8"		3.00	1
G1414-08-08	1/2"	1/2"	3.30	3.00	5
G1414-10-06	5/8"	3/8"		3.70	1
G1414-10-08	5/8"	1/2"		4.50	1
G1414-10-10	5/8"	5/8"	4.20	3.90	5
G1414-12-12	3/4"	3/4"		12.10	1

G1416... MALE CONNECTOR

Part Number	Pipe Size	Tube Size	PRICE EACH		Pkg Qty
			Loose	Std Pkg	
Pipe Size Tube Size					
G1416-02-02	1/8"	1/8"		2.40	1
G1416-02-03	1/8"	3/16"		0.96	1
G1416-02-04	1/8"	1/4"	0.89	0.83	5
G1416-02-05	1/8"	5/16"		1.12	1
G1416-02-06	1/8"	3/8"		1.80	1
G1416-04-04	1/4"	1/4"	1.14	1.02	5
G1416-04-05	1/4"	5/16"		1.80	1
G1416-04-06	1/4"	3/8"	2.00	1.80	5
G1416-04-08	1/4"	1/2"		2.40	1
G1416-06-04	3/8"	1/4"		1.70	1
G1416-06-05	3/8"	5/16"		4.90	1
G1416-06-06	3/8"	3/8"	1.90	1.70	5
G1416-06-08	3/8"	1/2"	2.50	2.30	5
G1416-06-10	3/8"	5/8"		5.20	1
G1416-08-04	1/2"	1/4"		3.20	1
G1416-08-06	1/2"	3/8"	2.40	2.20	5
G1416-08-08	1/2"	1/2"	2.80	2.50	5
G1416-08-10	1/2"	5/8"	3.90	3.50	5
G1416-08-12	1/2"	3/4"		7.70	1
G1416-12-08	3/4"	1/2"		4.60	1
G1416-12-10	3/4"	5/8"		4.50	1
G1416-12-12	3/4"	3/4"		6.90	1

G1446... 45° MALE CONNECTOR

Part Number	Pipe Size	Tube Size	PRICE EACH		Pkg Qty
			Loose	Std Pkg	
G1446-02-04	1/8"	1/4"		\$2.70	1
G1446-02-05	1/8"	5/16"		6.10	1
G1446-04-04	1/4"	1/4"		4.10	1
G1446-04-05	1/4"	5/16"		4.60	1
G1446-04-06	1/4"	3/8"	\$4.00	3.70	5
G1446-06-06	3/8"	3/8"		5.30	1
G1446-06-08	3/8"	1/2"		4.90	1
G1446-08-06	1/2"	3/8"		8.70	1
G1446-08-08	1/2"	1/2"		11.20	1
G1446-08-10	1/2"	5/8"		9.60	1
G1446-08-12	1/2"	3/4"		18.90	1
G1446-12-12	3/4"	3/4"		13.90	1

G1494... 90° UNION ELBOW

Part Number	Pipe Size	Tube Size	PRICE EACH		Pkg Qty
			Loose	Std Pkg	
Tube Size					
G1494-04-04	1/4"	1/4"		3.40	1
G1494-05-05	5/16"	5/16"		5.20	1
G1494-06-06	3/8"	3/8"		5.60	1
G1494-08-08	1/2"	1/2"		4.90	1
G1494-10-10	5/8"	5/8"		12.50	1
G1494-12-12	3/4"	3/4"		22.20	1

G1496... 90° MALE CONNECTOR

Part Number	Pipe Size	Tube Size	PRICE EACH		Pkg Qty
			Loose	Std Pkg	
G1496-02-02	1/8"	1/8"		12.80	1
G1496-02-03	1/8"	3/16"		6.00	1
G1496-02-04	1/8"	1/4"	2.50	2.20	5
G1496-02-05	1/8"	5/16"		2.70	1
G1496-02-06	1/8"	3/8"		3.20	1
G1496-04-04	1/4"	1/4"	2.70	2.30	5
G1496-04-05	1/4"	5/16"		4.60	1
G1496-04-06	1/4"	3/8"	3.70	3.20	5
G1496-04-08	1/4"	1/2"		5.90	1
G1496-06-04	3/8"	1/4"		3.60	1
G1496-06-05	3/8"	5/16"		6.50	1
G1496-06-06	3/8"	3/8"	3.40	3.20	5
G1496-06-08	3/8"	1/2"	5.20	4.80	5
G1496-06-10	3/8"	5/8"		7.10	1
G1496-08-04	1/2"	1/4"		9.00	1
G1496-08-06	1/2"	3/8"		4.20	1
G1496-08-08	1/2"	1/2"	5.50	5.00	5
G1496-08-10	1/2"	5/8"	6.80	6.30	5
G1496-08-12	1/2"	3/4"		14.30	1
G1496-12-08	3/4"	1/2"		8.90	1
G1496-12-10	3/4"	5/8"		9.60	1
G1496-12-12	3/4"	3/4"		20.20	1

7

Brass

SAE 45° FLARE FITTINGS

Part Number	Pipe Size	Tube Size	PRICE EACH		Pkg Qty
			Loose	Std Pkg	

G1498... 90° FEMALE CONNECTOR



G1498-02-04	1/8"	1/4"	\$4.10		1
G1498-02-05	1/8"	5/16"	4.80		1
G1498-02-06	1/8"	3/8"	5.10		1
G1498-04-04	1/4"	1/4"	5.00		1
G1498-04-05	1/4"	5/16"	5.60		1
G1498-04-06	1/4"	3/8"	5.10		1
G1498-04-08	1/4"	1/2"	9.00		1
G1498-06-06	3/8"	3/8"	4.00		1
G1498-06-08	3/8"	1/2"	5.50		1
G1498-06-10	3/8"	5/8"	14.70		1
G1498-08-06	1/2"	3/8"	8.10		1
G1498-08-08	1/2"	1/2"	6.80		1
G1498-08-10	1/2"	5/8"	11.60		1
G1498-08-12	1/2"	3/4"	24.90		1
G1498-12-08	3/4"	1/2"	9.30		1
G1498-12-10	3/4"	5/8"	15.00		1
G1498-12-12	3/4"	3/4"	36.70		1

G14T44... UNION TEE



Tube					
G14T44-04-04	1/4"	1/4"	4.50		1
G14T44-05-05	5/16"	5/16"	6.20		1
G14T44-06-06	3/8"	3/8"	4.30		1
G14T44-08-08	1/2"	1/2"	6.60		1
G14T44-10-10	5/8"	5/8"	15.10		1
G14T44-12-12	3/4"	3/4"	26.10		1

G14T46... MALE BRANCH TEE



Pipe					
G14T46-02-04	1/8"	1/4"	4.80		1
G14T46-02-05	1/8"	5/16"	5.10		1
G14T46-04-04	1/4"	1/4"	6.00		1
G14T46-04-05	1/4"	5/16"	8.40		1
G14T46-04-06	1/4"	3/8"	5.50		1
G14T46-06-06	3/8"	3/8"	9.30		1
G14T46-06-08	3/8"	1/2"	13.00		1
G14T46-08-06	1/2"	3/8"	11.60		1
G14T46-08-08	1/2"	1/2"	15.30		1
G14T46-08-10	1/2"	5/8"	18.90		1
G14T46-08-12	1/2"	3/4"	40.40		1
G14T46-12-12	3/4"	3/4"	39.20		1

G14T64... MALE RUN TEE



Pipe					
G14T64-02-04	1/8"	1/4"	5.30		1
G14T64-02-05	1/8"	5/16"	6.80		1
G14T64-04-04	1/4"	1/4"	6.70		1
G14T64-04-05	1/4"	5/16"	10.60		1
G14T64-04-06	1/4"	3/8"	7.80		1
G14T64-06-06	3/8"	3/8"	9.40		1
G14T64-06-08	3/8"	1/2"	12.60		1
G14T64-08-08	1/2"	1/2"	16.60		1
G14T64-08-10	1/2"	5/8"	18.00		1
G14T64-08-12	1/2"	3/4"	29.30		1

Part Number	Pipe Size	Tube Size	PRICE EACH		Pkg Qty
			Loose	Std Pkg	

G14X44... CROSS



Tube					
G14X44-04-04	1/4"	1/4"	\$14.30		1
G14X44-06-06	3/8"	3/8"	9.90		1

INVERTED FLARE FITTINGS

Part Number	Inv. Flare	Male Flare	PRICE EACH		Pkg Qty
			Loose	Std Pkg	

G1412... INVERTED FLARE CONNECTOR



G1412-03-04	3/16"	1/4"	23.50		1
G1412-04-04	1/4"	1/4"	14.10		1
G1412-04-06	1/4"	3/8"	49.10		1
G1412-05-04	5/16"	1/4"	18.50		1
G1412-05-06	5/16"	3/8"	18.50		1
G1412-06-06	3/8"	3/8"	21.50		1
G1412-07-06	7/16"	3/8"	31.50		1

G0012... INVERTED FLARE BRASS NUT



Tube					
G0012-03	3/16"		0.58		1
G0012-04	1/4"		0.77		1
G0012-05	5/16"		0.96		1
G0012-06	3/8"		1.41		1
G0012-08	1/2"		3.00		1

G0012S... INVERTED FLARE STEEL NUT



G0012S-03	3/16"		0.41	0.36	5
G0012S-04	1/4"		0.42	0.37	5
G0012S-05	5/16"			0.83	1
G0012S-06	3/8"			0.71	1
G0012S-08	1/2"			1.77	1
G0012S-10	5/8"			4.99	1

G0012SL... INVERTED FLARE LONG STEEL NUT

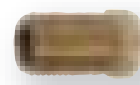

G0012SL-03	3/16"		0.83		1
G0012SL-04	1/4"		1.04		1

G1200... INVERTED FLARE BRASS PLUG



G1200-03	3/16"		1.52		1
G1200-04	1/4"		1.34		1
G1200-05	5/16"		2.10		1
G1200-06	3/8"		2.50		1

7

Brass

INVERTED FLARE FITTINGS

Part Number	Tube Size	Tube Size	PRICE EACH		Pkg Qty
			Loose	Std Pkg	

G0202... INVERTED FLARE COUPLING



G0202-02-02	1/8"	1/8"		\$4.40	1
G0202-03-03	3/16"	3/16"	\$1.90	1.80	5
G0202-04-04	1/4"	1/4"	3.00	2.80	5
G0202-05-05	5/16"	5/16"		2.10	1
G0202-06-06	3/8"	3/8"		4.10	1
G0202-08-08	1/2"	1/2"		12.70	1

G0208... INVERTED FLARE FEMALE CONNECTOR



	Pipe	Tube			
G0208-02-03	1/8"	3/16"		3.70	1
G0208-02-04	1/8"	1/4"		3.20	1
G0208-02-05	1/8"	5/16"		5.70	1
G0208-04-06	1/4"	3/8"		7.90	1
G0208-06-08	3/8"	1/2"		11.90	1

G0216... INVERTED FLARE MALE CONNECTOR



G0216-02-03	1/8"	3/16"		1.15	1
G0216-02-04	1/8"	1/4"		1.50	1
G0216-02-05	1/8"	5/16"		1.15	1
G0216-02-06	1/8"	3/8"		4.20	1
G0216-04-04	1/4"	1/4"		2.20	1
G0216-04-05	1/4"	5/16"		2.40	1
G0216-04-06	1/4"	3/8"		1.80	1
G0216-04-08	1/4"	1/2"		6.60	1
G0216-06-06	3/8"	3/8"		4.10	1
G0216-06-08	3/8"	1/2"		3.00	1
G0216-08-08	1/2"	1/2"		6.10	1
G0216-08-10	1/2"	5/8"		9.90	1
G0216-12-12	3/4"	3/4"		32.80	1

G0246... INVERTED FLARE 45° MALE CONNECTOR

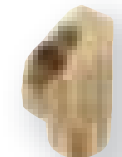

G0246-02-03	1/8"	3/16"		5.70	1
G0246-02-04	1/8"	1/4"		3.80	1
G0246-02-05	1/8"	5/16"		6.10	1
G0246-04-06	1/4"	3/8"		8.60	1
G0246-06-08	3/8"	1/2"		12.50	1

Part Number	Pipe Size	Tube Size	PRICE EACH		Pkg Qty
			Loose	Std Pkg	

G0296... INVERTED FLARE 90° MALE CONNECTOR



G0296-02-02	1/8"	1/8"		\$7.20	1
G0296-02-03	1/8"	3/16"		2.60	1
G0296-02-04	1/8"	1/4"		2.00	1
G0296-02-05	1/8"	5/16"		2.80	1
G0296-02-06	1/8"	3/8"		11.40	1
G0296-04-04	1/4"	1/4"		3.70	1
G0296-04-05	1/4"	5/16"		4.20	1
G0296-04-06	1/4"	3/8"		5.60	1
G0296-04-08	1/4"	1/2"		12.20	1
G0296-06-06	3/8"	3/8"		8.40	1
G0296-06-08	3/8"	1/2"		9.90	1
G0296-06-10	3/8"	5/8"		28.90	1
G0296-08-08	1/2"	1/2"		17.90	1
G0296-08-10	1/2"	5/8"		19.80	1
G0296-08-12	1/2"	3/4"		49.90	1

G0298... INVERTED FLARE 90° FEMALE CONNECTOR



G0298-02-04	1/8"	1/4"		8.80	1
-------------	------	------	--	------	---

G02T00... INVERTED FLARE UNION TEE



	Tube	Tube			
G02T00-03-03	3/16"	3/16"		5.90	1
G02T00-04-04	1/4"	1/4"		7.10	1
G02T00-05-05	5/16"	5/16"		9.60	1
G02T00-06-06	3/8"	3/8"		21.20	1

G02T06... INVERTED FLARE MALE BRANCH TEE



	Pipe	Tube			
G02T06-02-03	1/8"	3/16"		12.40	1
G02T06-02-04	1/8"	1/4"		12.10	1
G02T06-02-05	1/8"	5/16"		12.40	1
G02T06-04-06	1/4"	3/8"		17.00	1

7

Brass

BRASS COMPRESSION FITTINGS

Part Number	Tube Size	PRICE EACH		Pkg Qty
		Loose	Std Pkg	
G6000... BRASS COMPRESSION SLEEVE				
G6000-02	1/8"	\$0.17	\$0.12	5
G6000-03	3/16"	0.19	0.13	5
G6000-04	1/4"	0.18	0.14	5
G6000-05	5/16"	0.34	0.20	5
G6000-06	3/8"	0.37	0.21	5
G6000-08	1/2"	0.39	0.36	5
G6000-10	5/8"		0.45	1
G6000-12	3/4"		1.41	1

G6100... PLASTIC COMPRESSION SLEEVE

Part Number	Tube O.D.	PRICE EACH		Pkg Qty
		Loose	Std Pkg	
G6100-04	1/4"	0.24	0.22	5
G6100-05	5/16"		0.74	1
G6100-06	3/8"	0.27	0.24	5
G6100-08	1/2"	0.71	0.59	5
G6100-10	5/8"		0.83	1

G6001... STANDARD NUT

Part Number	Tube	PRICE EACH		Pkg Qty
		Loose	Std Pkg	
G6001-02	1/8"		0.48	1
G6001-03	3/16"		0.50	1
G6001-04	1/4"	0.51	0.46	5
G6001-05	5/16"		0.56	1
G6001-06	3/8"	0.71	0.57	5
G6001-08	1/2"		1.13	1
G6001-10	5/8"		1.42	1
G6001-12	3/4"		4.30	1

G6103... COMPRESSION INSERT

Part Number	Tube O.D.	PRICE EACH		Pkg Qty
		Loose	Std Pkg	
G6103-04	1/4"	0.24	0.22	5
G6103-05	5/16"	0.75	0.69	5
G6103-06	3/8"	0.35	0.33	5
G6103-08	1/2"	1.18	1.08	5
G6103-10	5/8"		1.60	1

G6008... FEMALE CONNECTOR

Part Number	Pipe	Tube	PRICE EACH		Pkg Qty
			Loose	Std Pkg	
G6008-02-02	1/8"	1/8"	2.30	1	
G6008-02-03	1/8"	3/16"	2.90	1	
G6008-02-04	1/8"	1/4"	1.80	1	
G6008-02-05	1/8"	5/16"	3.00	1	
G6008-02-06	1/8"	3/8"	3.40	1	
G6008-04-04	1/4"	1/4"	1.90	1	
G6008-04-05	1/4"	5/16"	4.20	1	
G6008-04-06	1/4"	3/8"	2.20	1	
G6008-06-04	3/8"	1/4"	7.10	1	
G6008-06-06	3/8"	3/8"	2.50	1	
G6008-06-08	3/8"	1/2"	4.50	1	
G6008-06-10	3/8"	5/8"	9.70	1	
G6008-08-04	1/2"	1/4"	10.20	1	
G6008-08-06	1/2"	3/8"	4.90	1	
G6008-08-08	1/2"	1/2"	5.00	1	
G6008-08-10	1/2"	5/8"	4.90	1	
G6008-08-12	1/2"	3/4"	22.80	1	
G6008-12-08	3/4"	1/2"	14.50	1	
G6008-12-10	3/4"	5/8"	16.00	1	
G6008-12-12	3/4"	3/4"	25.40	1	

G6060... UNION

Part Number	Tube Size	Tube Size	PRICE EACH		Pkg Qty
			Loose	Std Pkg	
G6060-02-02	1/8"	1/8"	\$2.90	1	
G6060-03-03	3/16"	3/16"	1.80	1	
G6060-04-04	1/4"	1/4"	\$2.00	1.80	5
G6060-05-05	5/16"	5/16"	2.30	2.10	5
G6060-06-06	3/8"	3/8"	2.70	2.50	5
G6060-08-08	1/2"	1/2"	4.30	1	
G6060-10-10	5/8"	5/8"	5.70	1	
G6060-12-12	3/4"	3/4"	24.10	1	

G6016... MALE CONNECTOR

Part Number	Pipe	Tube	PRICE EACH		Pkg Qty
			Loose	Std Pkg	
G6016-02-02	1/8"	1/8"	1.80	1.70	5
G6016-02-03	1/8"	3/16"		1.42	1
G6016-02-04	1/8"	1/4"	1.57	1.30	5
G6016-02-05	1/8"	5/16"	2.10	1.90	5
G6016-02-06	1/8"	3/8"		1.90	1
G6016-04-04	1/4"	1/4"	2.00	1.80	5
G6016-04-05	1/4"	5/16"		2.00	1
G6016-04-06	1/4"	3/8"	2.10	1.90	5
G6016-04-08	1/4"	1/2"		5.30	1
G6016-06-04	3/8"	1/4"		4.60	1
G6016-06-05	3/8"	5/16"		6.30	1
G6016-06-06	3/8"	3/8"	2.30	2.10	5
G6016-06-08	3/8"	1/2"		3.00	1
G6016-06-10	3/8"	5/8"		7.30	1
G6016-08-04	1/2"	1/4"		6.70	1
G6016-08-06	1/2"	3/8"		3.10	1
G6016-08-08	1/2"	1/2"		3.80	1
G6016-08-10	1/2"	5/8"		4.30	1
G6016-08-12	1/2"	3/4"		12.40	1
G6016-12-08	3/4"	1/2"		11.70	1
G6016-12-10	3/4"	5/8"		10.90	1
G6016-12-12	3/4"	3/4"		15.40	1

G6090... 90° UNION

Part Number	Pipe	Tube	PRICE EACH		Pkg Qty
			Loose	Std Pkg	
G6090-02-02	1/8"	1/8"	10.90	1	
G6090-03-03	3/16"	3/16"	8.00	1	
G6090-04-04	1/4"	1/4"	5.10	1	
G6090-05-05	5/16"	5/16"	5.70	1	
G6090-06-06	3/8"	3/8"	4.50	4.10	5
G6090-08-08	1/2"	1/2"	6.50	1	
G6090-10-10	5/8"	5/8"	9.50	1	
G6090-12-12	3/4"	3/4"	28.00	1	

7

Brass

BRASS COMPRESSION FITTINGS

Part Number	Pipe Size	Tube Size	PRICE EACH		Pkg Qty
			Loose	Std Pkg	
G6046... 45° MALE CONNECTOR					
					
G6046-02-03	1/8"	3/16"		\$9.00	1
G6046-02-04	1/8"	1/4"		7.10	1
G6046-02-05	1/8"	5/16"		8.60	1
G6046-04-04	1/4"	1/4"		7.10	1
G6046-04-06	1/4"	3/8"		7.80	1
G6046-06-08	3/8"	1/2"		10.80	1
G6046-08-08	1/2"	1/2"		18.90	1
G6046-08-10	1/2"	5/8"		20.50	1

G6098... 90° FEMALE CONNECTOR					
					
G6098-02-04	1/8"	1/4"		5.30	1
G6098-02-05	1/8"	5/16"		7.30	1
G6098-04-06	1/4"	3/8"		6.60	1
G6098-04-08	1/4"	1/2"		13.90	1
G6098-06-04	3/8"	1/4"		8.40	1
G6098-06-06	3/8"	3/8"		8.40	1
G6098-06-08	3/8"	1/2"		11.30	1
G6098-08-06	1/2"	3/8"		9.90	1
G6098-08-08	1/2"	1/2"		14.70	1
G6098-08-10	1/2"	5/8"		15.50	1

G6096... 90° MALE CONNECTOR					
					
G6096-02-02	1/8"	1/8"		3.40	1
G6096-02-03	1/8"	3/16"		3.70	1
G6096-02-04	1/8"	1/4"	2.30	2.00	5
G6096-02-05	1/8"	5/16"		4.50	1
G6096-02-06	1/8"	3/8"		3.10	1
G6096-04-03	1/4"	3/16"		5.90	1
G6096-04-04	1/4"	1/4"	3.10	2.90	5
G6096-04-05	1/4"	5/16"		4.60	1
G6096-04-06	1/4"	3/8"		3.20	1
G6096-04-08	1/4"	1/2"		7.00	1
G6096-06-04	3/8"	1/4"		7.00	1
G6096-06-05	3/8"	5/16"		8.10	1
G6096-06-06	3/8"	3/8"	3.90	3.60	5
G6096-06-08	3/8"	1/2"		7.30	1
G6096-06-10	3/8"	5/8"	9.00	7.80	5
G6096-08-04	1/2"	1/4"		10.10	1
G6096-08-06	1/2"	3/8"		8.30	1
G6096-08-08	1/2"	1/2"		5.70	1
G6096-08-10	1/2"	5/8"		8.00	1
G6096-08-12	1/2"	3/4"		26.10	1
G6096-12-08	3/4"	1/2"		18.40	1
G6096-12-12	3/4"	3/4"		26.70	1

G60T00... UNION TEE					
					
Tube Size					
G60T00-02-02	1/8"	1/8"		7.10	1
G60T00-03-03	3/16"	3/16"		7.00	1
G60T00-04-04	1/4"	1/4"		3.80	1
G60T00-05-05	5/16"	5/16"		7.00	1
G60T00-06-06	3/8"	3/8"		5.20	1
G60T00-08-08	1/2"	1/2"		12.60	1
G60T00-10-10	5/8"	5/8"		14.40	1
G60T00-12-12	3/4"	3/4"		59.30	1

Part Number	Pipe Size	Tube Size	PRICE EACH		Pkg Qty
			Loose	Std Pkg	
G60T06... MALE BRANCH TEE					
					
G60T06-02-02	1/8"	1/8"		9.50	1
G60T06-02-03	1/8"	3/16"		6.30	1
G60T06-02-04	1/8"	1/4"		5.90	1
G60T06-02-05	1/8"	5/16"		9.40	1
G60T06-04-04	1/4"	1/4"		7.40	1
G60T06-04-05	1/4"	5/16"		9.50	1
G60T06-04-06	1/4"	3/8"		7.80	1
G60T06-06-06	3/8"	3/8"		11.30	1
G60T06-06-08	3/8"	1/2"		15.30	1
G60T06-08-08	1/2"	1/2"		18.80	1
G60T06-08-10	1/2"	5/8"		24.60	1
G60T06-08-12	1/2"	3/4"		51.70	1
G60T06-12-12	3/4"	3/4"		54.10	1

G60T60... MALE RUN TEE					
					
G60T60-02-04	1/8"	1/4"		5.90	1
G60T60-02-05	1/8"	5/16"		9.50	1
G60T60-04-04	1/4"	1/4"		8.60	1
G60T60-04-05	1/4"	5/16"		9.60	1
G60T60-04-06	1/4"	3/8"		8.60	1
G60T60-06-06	3/8"	3/8"		13.00	1
G60T60-06-08	3/8"	1/2"		16.20	1
G60T60-08-08	1/2"	1/2"		20.10	1
G60T60-08-10	1/2"	5/8"		21.20	1
G60T60-08-12	1/2"	3/4"		51.30	1
G60T60-12-12	3/4"	3/4"		46.10	1

AIR BRAKE HOSE FITTINGS

Part Number	Pipe Size	Hose I.D.	PRICE EACH		Pkg Qty
			Loose	Std Pkg	

G4316... MALE NPT FITTING WITHOUT SPRING

					
G4316-04-06	1/4"	3/8"	\$7.20	\$6.50	5
G4316-06-06	3/8"	3/8"	7.80	7.10	5
G4316-06-08	3/8"	1/2"	13.10	11.80	2
G4316-08-06	1/2"	3/8"	8.50	7.50	5
G4316-08-08	1/2"	1/2"	16.00	14.40	2

G4316G... MALE NPT FITTING WITH SPRING

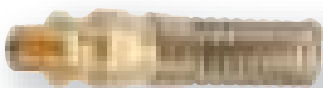
					
G4316G-04-06	1/4"	3/8"	8.30	7.40	2
G4316G-06-06	3/8"	3/8"	8.70	7.70	2
G4316G-06-08	3/8"	1/2"	14.40	12.90	2
G4316G-08-06	1/2"	3/8"	9.30	8.20	2
G4316G-08-08	1/2"	1/2"	14.40	12.90	2

G4331 PLAIN NUT

					
G4331-06		3/8"	2.50	2.30	10
G4331-08		1/2"	4.50	4.00	10

G4331G... SPRING GUARD NUT

					
G4331G-06		3/8"	2.50	2.30	5
G4331G-08		1/2"	5.60	5.10	5

G4332... SPRING

					
G4332-06		3/8"	1.10	0.80	5
G4332-08		1/2"	1.20	1.10	5

G4334... AIR BRAKE NUT WITH SPRING

					
G4334-06		3/8"	3.50	3.20	5
G4334-08		1/2"	7.10	6.40	5

G1619AB... AIR BRAKE ASSEMBLY ADAPTER

					
G1619AB-04-06	1/4"	3/8"		2.70	1
G1619AB-06-06	3/8"	3/8"		3.20	1
G1619AB-06-08	3/8"	1/2"		3.10	1

G4300... AIR BRAKE HOSE MENDER

					
G4300-06		3/8"	15.30	13.70	5
G4300-08		1/2"	31.50	28.30	2

Part Number	Pipe Size	Hose I.D.	PRICE EACH		Pkg Qty
			Loose	Std Pkg	

G4330... SLEEVE

					
G4330-06		3/8"	\$1.40	\$1.30	10
G4330-08		1/2"	2.20	2.00	5

G4333... MALE INSERT

					
G4333-04-06	1/4"	3/8"	3.20	3.00	10
G4333-06-06	3/8"	3/8"	3.50	3.20	10
G4333-06-08	3/8"	1/2"	8.30	7.40	5
G4333-08-06	1/2"	3/8"	3.70	3.40	10
G4333-08-08	1/2"	1/2"	8.80	7.80	5

8

Truck

AIR BRAKE PUSH-TO-CONNECT FITTINGS

Push-to-connect fittings have several advantages over conventional compression style fittings. They are much faster to install, there are no loose nuts and sleeves to fiddle with during installation, and in tight spaces, no wrench is required when the tubing is attached. In addition, male NPT parts have thread sealant pre-applied for convenience and further time savings.

Users should be aware that many push-to-connect fitting styles are available in the market, but only D.O.T. branded fittings should be used in air brake applications.

G7000P series are D.O.T. accepted for all air brake applications EXCEPT:

- lines from the frame to the axle
- between towing and towed vehicles

For these applications, use G7000 series or use G4300 series with rubber hose.

Part Number	Pipe Size	Tube Size	PRICE EACH
-------------	-----------	-----------	------------

G7008P... FEMALE CONNECTOR

G7008P-02-04	1/8"	1/4"	\$6.30
G7008P-04-04	1/4"	1/4"	8.50
G7008P-04-06	1/4"	3/8"	8.60
G7008P-06-06	3/8"	3/8"	15.30



G7016P... MALE CONNECTOR

G7016P-01-02.5	1/16"	5/32"	5.90
G7016P-02-02.5	1/8"	5/32"	5.90
G7016P-02-04	1/8"	1/4"	4.20
G7016P-02-06	1/8"	3/8"	5.70
G7016P-04-04	1/4"	1/4"	5.30
G7016P-04-06	1/4"	3/8"	6.00
G7016P-04-08	1/4"	1/2"	8.70
G7016P-06-04	3/8"	1/4"	6.00
G7016P-06-06	3/8"	3/8"	6.50
G7016P-06-08	3/8"	1/2"	8.70
G7016P-08-06	1/2"	3/8"	8.60
G7016P-08-08	1/2"	1/2"	10.00



G7046P... 45° MALE CONNECTOR

G7046P-02-04	1/8"	1/4"	7.70
G7046P-04-04	1/4"	1/4"	8.20
G7046P-04-06	1/4"	3/8"	9.60
G7046P-06-08	3/8"	1/2"	13.90



G7096P... 90° MALE CONNECTOR

G7096P-02-02.5	1/8"	5/32"	7.50
G7096P-02-04	1/8"	1/4"	6.10
G7096P-04-04	1/4"	1/4"	6.10
G7096P-04-06	1/4"	3/8"	7.80
G7096P-06-04	3/8"	1/4"	12.10
G7096P-06-06	3/8"	3/8"	8.70
G7096P-06-08	3/8"	1/2"	10.60
G7096P-08-08	1/2"	1/2"	15.40



Part Number	Pipe Size	Tube Size	PRICE EACH
-------------	-----------	-----------	------------

G7096PX... 90° SWIVEL MALE CONNECTOR

G7096PX-02-02.5	1/8"	5/32"	\$13.90
G7096PX-02-04	1/8"	1/4"	8.00
G7096PX-02-06	1/8"	3/8"	14.20
G7096PX-04-04	1/4"	1/4"	8.60
G7096PX-04-06	1/4"	3/8"	11.40
G7096PX-04-08	1/4"	1/2"	14.90
G7096PX-06-04	3/8"	1/4"	12.80
G7096PX-06-06	3/8"	3/8"	12.40
G7096PX-06-08	3/8"	1/2"	14.90
G7096PX-08-06	1/2"	3/8"	14.90
G7096PX-08-08	1/2"	1/2"	17.50



G7098P... 90° FEMALE CONNECTOR

G7098P-02-04	1/8"	1/4"	6.90
G7098P-04-04	1/4"	1/4"	8.10
G7098P-04-06	1/4"	3/8"	15.80



G7070P... UNION

Part Number	Pipe Size	Tube Size	PRICE EACH
G7070P-02.5-02.5	5/32"	5/32"	7.20
G7070P-04-04	1/4"	1/4"	6.10
G7070P-06-06	3/8"	3/8"	8.80
G7070P-08-08	1/2"	1/2"	12.10

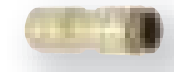

G7070PBH... BULKHEAD UNION

G7070PBH-04-04	1/4"	1/4"	16.40
G7070PBH-06-06	3/8"	3/8"	18.70
G7070PBH-08-08	1/2"	1/2"	27.00



G7090P... 90° UNION

G7090P-04-04	1/4"	1/4"	8.30
G7090P-06-06	3/8"	3/8"	12.50
G7090P-08-08	1/2"	1/2"	16.60



G70T00P... UNION TEE

G70T00P-04-04	1/4"	1/4"	11.30
G70T00P-06-06	3/8"	3/8"	14.50
G70T00P-08-08	1/2"	1/2"	19.20



G70T06PX... SWIVEL MALE BRANCH TEE

Part Number	Pipe Size	Tube Size	PRICE EACH
G70T06PX-02-04	1/8"	1/4"	12.10
G70T06PX-04-04	1/4"	1/4"	12.10
G70T06PX-04-06	1/4"	3/8"	15.70
G70T06PX-04-08	1/4"	1/2"	27.80
G70T06PX-06-06	3/8"	3/8"	16.70
G70T06PX-06-08	3/8"	1/2"	16.50
G70T06PX-08-08	1/2"	1/2"	32.00



G70T60PX... SWIVEL MALE RUN TEE

G70T60PX-02-04	1/8"	1/4"	11.60
G70T60PX-04-04	1/4"	1/4"	12.30
G70T60PX-04-06	1/4"	3/8"	15.70
G70T60PX-06-06	3/8"	3/8"	17.00
G70T60PX-06-08	3/8"	1/2"	23.00
G70T60PX-08-08	1/2"	1/2"	32.00



8

Truck

AIR BRAKE COMPRESSION FITTINGS

Part Number Tube Size Tube Size PRICE EACH Loose Std Pkg Pkg Qty

G7000... AIR BRAKE SLEEVE

G7000-04	1/4"		\$0.26	\$0.24	5
G7000-06	3/8"		0.35	0.33	5
G7000-08	1/2"		0.50	0.40	5
G7000-10	5/8"		1.20	1.10	5
G7000-12	3/4"			1.80	1

G7001... AIR BRAKE NUT

G7001-04	1/4"		0.75	0.60	5
G7001-06	3/8"		0.85	0.74	5
G7001-08	1/2"		1.90	1.70	5
G7001-10	5/8"		3.00	2.70	5
G7001-12	3/4"		4.50	4.00	5

G7103... COMPRESSION INSERT

G7103-02	1/8"			1.50	1
G7103-04	1/4"		0.30	0.30	5
G7103-05	5/16"			1.90	1
G7103-06	3/8"		0.52	0.43	5
G7103-08	1/2"		0.75	0.67	5
G7103-10	5/8"		1.40	1.30	5
G7103-12	3/4"		2.00	2.00	1

G7008... AIR BRAKE FEMALE CONNECTOR

					
Pipe Size					
G7008-02-04	1/8"	1/8"	2.90	2.50	10
G7008-02-06	1/8"	3/8"	6.90	6.10	10
G7008-04-04	1/4"	1/4"	5.00	4.60	10
G7008-04-06	1/4"	3/8"	6.30	5.60	10
G7008-06-06	3/8"	3/8"	5.90	5.40	10
G7008-06-08	3/8"	1/2"	14.30	12.80	5

G7016... AIR BRAKE MALE CONNECTOR

					
G7016-02-04	1/8"	1/8"	2.00	1.90	10
G7016-02-06	1/8"	3/8"	3.30	3.00	10
G7016-04-04	1/4"	1/4"	3.10	2.70	10
G7016-04-06	1/4"	3/8"	2.50	2.30	10
G7016-04-08	1/4"	1/2"	5.50	5.00	10
G7016-06-04	3/8"	1/4"	3.60	3.30	10
G7016-06-06	3/8"	3/8"	3.90	3.60	10
G7016-06-08	3/8"	1/2"	5.30	4.90	10
G7016-06-10	3/8"	5/8"	9.10	8.20	5
G7016-08-06	1/2"	3/8"	5.10	4.60	10
G7016-08-08	1/2"	1/2"	7.20	6.50	10
G7016-08-10	1/2"	5/8"	10.40	9.30	5
G7016-08-12	1/2"	3/4"	20.40	18.30	2
G7016-12-12	3/4"	3/4"	16.30	14.70	2

Part Number Pipe Size Tube Size PRICE EACH Loose Std Pkg Pkg Qty

G7046... AIR BRAKE 45° MALE CONNECTOR

					
G7046-02-04	1/8"	1/8"	\$5.80	\$5.30	10
G7046-02-06	1/8"	3/8"	7.30	6.70	10
G7046-04-04	1/4"	1/4"	6.70	6.00	10
G7046-04-06	1/4"	3/8"	6.40	5.80	10
G7046-06-06	3/8"	3/8"	9.20	8.30	10
G7046-06-08	3/8"	1/2"	8.90	8.00	10
G7046-08-06	1/2"	3/8"	12.80	11.60	10
G7046-08-08	1/2"	1/2"	13.50	12.10	10
G7046-08-10	1/2"	5/8"	19.50	17.60	5

G7096... AIR BRAKE 90° MALE CONNECTOR

					
G7096-02-04	1/8"	1/4"	3.60	3.20	10
G7096-02-06	1/8"	3/8"	5.60	5.10	10
G7096-04-04	1/4"	1/4"	3.90	3.60	10
G7096-04-06	1/4"	3/8"	4.10	3.70	10
G7096-04-08	1/4"	1/2"	7.20	6.70	10
G7096-06-04	3/8"	1/4"	5.80	5.40	10
G7096-06-06	3/8"	3/8"	4.60	4.10	10
G7096-06-08	3/8"	1/2"	6.50	5.90	10
G7096-06-10	3/8"	5/8"	13.90	12.60	2
G7096-08-04	1/2"	1/4"		10.70	1
G7096-08-06	1/2"	3/8"	7.20	6.50	10
G7096-08-08	1/2"	1/2"	8.50	7.60	5
G7096-08-10	1/2"	5/8"	14.30	12.80	2
G7096-08-12	1/2"	3/4"		25.70	1
G7096-12-10	3/4"	5/8"	21.70	19.50	5
G7096-12-12	3/4"	3/4"		28.10	1

G7070... AIR BRAKE UNION

					
Tube Size					
G7070-04-04	1/4"	1/4"	3.20	2.90	10
G7070-06-06	3/8"	3/8"	4.80	4.20	10
G7070-08-08	1/2"	1/2"	8.50	7.50	10
G7070-10-10	5/8"	5/8"	16.50	14.80	5
G7070-12-12	3/4"	3/4"	23.40	21.10	5

G7098... AIR BRAKE 90° FEMALE CONNECTOR

					
Pipe Size					
G7098-02-04	1/8"	1/8"	5.50	5.00	10
G7098-02-06	1/8"	3/8"	8.00	7.40	10
G7098-04-04	1/4"	1/4"	8.30	7.50	10
G7098-04-06	1/4"	3/8"	6.90	6.30	10
G7098-06-06	3/8"	3/8"	9.30	8.50	10
G7098-06-08	3/8"	1/2"	13.90	1	
G7098-08-08	1/2"	1/2"	13.90	1	

8

Truck

AIR BRAKE COMPRESSION FITTINGS

Part Number	Tube Size	Tube Size	PRICE EACH		Pkg Qty
			Loose	Std Pkg	

G7090... AIR BRAKE UNION ELBOW



G7090-04-04	1/4"	1/4"	\$5.90	\$5.40	10
G7090-06-06	3/8"	3/8"	7.10	6.30	10
G7090-08-08	1/2"	1/2"	13.70	12.40	5
G7090-10-10	5/8"	5/8"		21.10	1
G7090-12-12	3/4"	3/4"		42.40	1

G70T00... AIR BRAKE TEE UNION

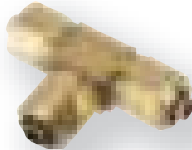

G70T00-04-04	1/4"	1/4"	8.30	7.60	10
G70T00-06-06	3/8"	3/8"	10.70	9.60	10
G70T00-08-08	1/2"	1/2"	14.70	13.30	5
G70T00-10-10	5/8"	5/8"	25.50	22.90	2
G70T00-12-12	3/4"	3/4"		66.00	1

G70T06... AIR BRAKE MALE BRANCH TEE



Pipe Size

G70T06-02-04	1/8"	1/4"	7.80	7.10	10
G70T06-02-06	1/8"	3/8"	7.50	6.90	10
G70T06-04-04	1/4"	1/4"	6.70	5.90	10
G70T06-04-06	1/4"	3/8"	8.20	7.40	10
G70T06-06-06	3/8"	3/8"	7.70	7.00	10
G70T06-06-08	3/8"	1/2"	12.00	10.80	5
G70T06-08-08	1/2"	1/2"	15.30	13.70	5
G70T06-08-10	1/2"	5/8"	31.40	28.20	5
G70T06-08-12	1/2"	3/4"	50.00	44.90	2
G70T06-12-12	3/4"	3/4"		51.10	1

G70T60... AIR BRAKE MALE RUN TEE



Pipe Size

G70T60-02-04	1/8"	1/4"	6.80	6.00	10
G70T60-04-04	1/4"	1/4"	9.20	8.30	10
G70T60-04-06	1/4"	3/8"	7.70	7.00	10
G70T60-06-06	3/8"	3/8"	9.50	8.70	10
G70T60-06-08	3/8"	1/2"	12.50	11.20	5
G70T60-08-08	1/2"	1/2"	19.10	17.30	5
G70T60-08-10	1/2"	5/8"		26.30	1

G6300 JOHN GUEST SPEEDFIT® FITTINGS

Grey acetyl copolymer construction with nitrile o-rings. FDA approved materials on all wetted surfaces.
Meet NSF International Standards 51 and 61.

Recommended for use with:

- polyethylene, nylon, polyurethane tubing and other plastic tubing*
- soft metals such as brass and copper.

*Note: When using with soft durometer tubing such as PVC, we recommend using tube inserts.

Not recommended for:

- hard or chrome plated metal tubing
- explosive gases
- fuels
- central heating or in-floor radiant heating.

G6400 series white polypropylene with EPDM o-rings are also available

Temperature range: -20°C (-4°F) to 70°C (158°F).

Pressure ratings*:

- Up to 5/16" tubing... 230 psi at 20°C (68°F)
150 psi at 70°C (158°F)
- 3/8" & 1/2" tubing... 150 psi at 20°C (68°F)
100 psi at 70°C (158°F)

*Note: Pressure ratings of tubing may be less. The lower of the two will determine the rated pressure of the system.

Maximum tightening torque:

- 1/8" - 1/4" 1.0 ft lbs (1.5Nm)
- 3/8" - 1/2" 2.2 ft lbs (3.0Nm)

To attach fittings:

- cut the tubing square and remove burrs and sharp edges that may damage o-ring
- make sure end of tube is free of score marks that may cause leak paths
- for very soft tubing or hot water systems, use a tube insert
- push the tube into and up to the stop
- pull the fitting back to make sure it is secure
- test the system

To release fittings:

- release system pressure
- push collet back squarely against the fitting body
- remove tubing

Part Number	Cross Reference	Pipe Size	Tube Size	PRICE EACH		Pkg Qty
				Loose	Std Pkg	

G6316... MALE NPT CONNECTOR



G6316-02-04	PI01-0821S	1/8"	1/4"	\$3.20	\$2.70	10
G6316-04-04	PI01-0822S	1/4"	1/4"	3.80	3.10	10
G6316-04-05	PM01-0822S	1/4"	5/16"	3.90	3.20	10
G6316-04-06	PI01-1222S	1/4"	3/8"	5.60	4.60	10
G6316-06-04	PI01-0823S	3/8"	1/4"	5.10	4.20	10
G6316-06-06	PI01-1223S	3/8"	3/8"	6.50	5.40	10
G6316-06-08	PI01-1623S	3/8"	1/2"	8.70	7.20	10
G6316-08-06	PI01-1224S	1/2"	3/8"	10.00	8.30	10
G6316-08-08	PI01-1624S	1/2"	1/2"	9.30	7.80	10

G6396... 90° SOLID MALE CONNECTOR



G6396-02-04	PI48-0821S	1/8"	1/4"	5.10	4.20	10
G6396-04-04	PI48-0822S	1/4"	1/4"	5.70	4.70	10
G6396-04-06	PI48-1222S	1/4"	3/8"	8.70	7.20	10
G6396-06-06	PI48-1223S	3/8"	3/8"	9.50	8.00	10

G6616... MALE NPT STEM ADAPTER



G6616-02-04	PI05-0821S	1/8"	1/4"	1.70	1.40	10
G6616-04-04	PI05-0822S	1/4"	1/4"	1.70	1.40	10
G6616-04-05	PM05-0822S	1/4"	5/16"	1.70	1.40	10
G6616-04-06	PI05-1222S	1/4"	3/8"	2.20	1.90	10
G6616-06-06	PI05-1223S	3/8"	3/8"	2.70	2.20	10
G6616-06-08	PI05-1623S	3/8"	1/2"	4.50	3.80	10
G6616-08-08	PI05-1624S	1/2"	1/2"	4.50	3.80	10

G6396X... 90° MALE SWIVEL CONNECTOR

A swivel elbow is created by inserting a G6616 male stem adapter into a G6393 union elbow.



G63T16X... MALE SWIVEL BRANCH TEE

A swivel branch tee is created by inserting a G6616 male stem adapter into a G63T33 union tee.

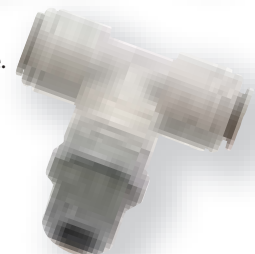

G63T63X... MALE SWIVEL RUN TEE

A swivel run tee is created by inserting a G6616 male stem adapter into a G63T33 union tee.



Part Number	Cross Reference	Pipe Size	Tube Size	PRICE EACH		Pkg Qty
				Loose	Std Pkg	

G6363... UNION



		Tube Size	Tube Size			
G6363-04-04	PI-0408S	1/4"	1/4"	\$5.10	\$4.20	10
G6363-06-04	PI20-1208S	3/8"	1/4"	6.90	5.80	10
G6363-06-06	PI-0412S	3/8"	3/8"	6.80	5.70	10
G6363-08-08	PI-0416S	1/2"	1/2"	8.00	6.60	10

G6393... 90° UNION



G6393-04-04	PI03-08S	1/4"	1/4"	5.70	4.70	10
G6393-05-05	PM03-08S	5/16"	5/16"	6.60	5.60	10
G6393-06-06	PI03-12S	3/8"	3/8"	8.70	7.20	10
G6393-08-08	PI03-16S	1/2"	1/2"	10.20	8.50	10

G63T33... UNION TEE



G63T33-04-04	PI02-08S	1/4"	1/4"	7.40	6.10	10
G63T33-05-05	PM02-08S	5/16"	5/16"	7.50	6.30	10
G63T33-06-04	PI30-1208S	3/8"	1/4"	11.70	9.80	10
G63T33-06-06	PI02-12S	3/8"	3/8"	9.00	7.50	10
G63T33-08-06	PI30-1612S	1/2"	3/8"	12.30	10.30	10
G63T33-08-08	PI02-16S	1/2"	1/2"	10.90	9.10	10

G6363BH... BULKHEAD UNION



		Tube Size	Mounting Hole			
G6363BH-04-04	PI12-08S	1/4"	0.67"	9.60	8.10	10
G6363BH-05-05	PM12-08S	5/16"	0.67"	12.20	10.20	10
G6363BH-06-06	PI12-12S	3/8"	0.83"	12.60	10.50	10
G6363BH-08-08	PI12-16S	1/2"	1.06"	20.60	17.20	10

G6300... PLUG



G6300-04	PI08-08S	1/4"	1.30	1.10	10
G6300-05	PM08-08S	5/16"	1.70	1.40	10
G6300-06	PI08-12S	3/8"	2.20	1.90	10
G6300-08	PI08-16S	1/2"	3.40	2.80	10

G6304... FEMALE SAE FLARE CONNECTOR



	SAE Size	Tube Size			
G6304-04-06	1/4"	3/8"	7.60	6.40	10

G6308... FEMALE NPT CONNECTOR



G6308-04-06	1/4"	3/8"	\$9.80	\$8.20	10
-------------	------	------	--------	--------	----

G6361... FEMALE COMPRESSION CONNECTOR

Allows attachment to G6000 series compression fittings and to V19-1690A-04 self tapping needle valves.



		Female Thread	Tube Size			
G6361-04-04	CI32-08U7S	-04 (7/16-24)	1/4"	6.50	5.40	10
G6361-04-06	CI32-12U7S	-04 (7/16-24)	3/8"	7.20	6.00	10

G6621... HOSE BARB STEM ADAPTER



		Tube Size	Hose Size			
G6621-04-04	PI25-0808S	1/4"	1/4"	3.20	2.70	10
G6621-06-04	PI25-1208S	3/8"	1/4"	4.60	3.80	10
G6621-06-06	PI25-1212S	3/8"	3/8"	5.10	4.20	10
G6621-08-08	PI25-1616S	1/2"	1/2"	6.70	5.70	10

G6603... SOFT TUBE INSERT



		Tube O.D.	Tube I.D.			
G6603-05-04	TSI-250S	5/16"	1/4"	0.50	0.40	100
G6603-06-05	TSI-312S	3/8"	5/16"	0.60	0.50	100
G6603-08-06	TSI-375S	1/2"	3/8"	0.60	0.50	100

G6363CV... CHECK VALVE



		Tube Size	Tube Size			
G6363CV-04-04	1/4SCV	1/4"	1/4"	23.60	1	
G6363CV-06-06	3/8SCV	3/8"	3/8"	24.30	1	



Push To Connect

Part Number	Cross Reference	Pipe Size	Tube Size	PRICE EACH		Pkg Qty
				Loose	Std Pkg	

V63AW... VALVE FOR AIR OR WATER*



V63AW-06-06	PISV04-12S	3/8"	3/8"	\$18.30	1
V63AW-08-08	PISV04-16S	1/2"	1/2"	18.60	1

V64W... POLYPROPYLENE VALVE FOR WATER ONLY*



V64W-04-04	PPSV04-0808W	1/4"	1/4"	12.70	1
V64W-06-06	PPSV04-1212W	3/8"	3/8"	13.50	1

* Pressure ratings: 150 psi at 20°C (68°F) • 100 psi at 60°C (140°F)

V6416W... POLYPROPYLENE MALE NPT VALVE FOR WATER ONLY*



V6416W-04-04	PPSV01-0822W	1/4"	1/4"	12.70	1
V6416W-06-06	PPSV01-1223W	3/8"	3/8"	13.50	1

V6498W... POLYPROPYLENE FEMALE NPT 90° VALVE FOR WATER ONLY*



V6498W-04-04	PPSV50-0822W	1/4"	1/4"	14.00	1
V6498W-04-06	PPSV50-1222W	1/4"	3/8"	14.60	1

* Pressure ratings: 150 psi at 20°C (68°F)
100 psi at 65°C (150°F)

Part Number	Cross Reference	Pipe Size	Tube Size	PRICE EACH		Pkg Qty
				Loose	Std Pkg	

V6406... POLYPROPYLENE ANGLE STOP ADAPTER TEE VALVE

For use on cold water lines between the angle stop valve and 3/8" riser to sink.

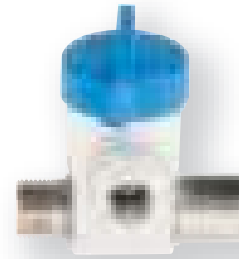

Part Number	Cross Reference	Riser Size	Tube Size	PRICE EACH	Pkg Qty
		3/8" (9/16"-24)	1/4" (3/8")		
V6406-06-04	ASVPP1	3/8" (9/16"-24)	1/4" (3/8")	\$24.90	1
V6406-06-06	ASVPP2	3/8" (9/16"-24)	3/8"	25.80	1

G6300LC... LOCKING CLIP



G6300LC-04	PIC18-08R	1/4"	\$0.50	0.40	100
G6300LC-06	PIC18-12R	3/8"	0.50	0.40	100

G6300MC... VALVE MOUNTING CLIP

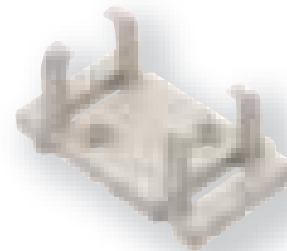

G6300MC-06	SVMC-10	3/8"	4.00	3.50	10
------------	---------	------	------	------	----

PUSH-TO-CONNECT TUBE FITTINGS

Pressure rating: 265 psi at 20°C (68°F) except 1/8" and 3/16" body sizes which are rated to 145 psi

Temperature range: -30°C (-22°F) to 80°C (176°F) with standard nitrile o-ring. Up to 110°C (230°F) with viton o-ring.

Nickel plated brass construction except 18" and 3/16" body sizes which are thermoplastic.

Teflon® thread sealant pre-applied for fast installation.

The fittings shown in this section are not for use with G1212 Air Brake tubing. For truck and trailer applications please see G7000P in the Truck section

Recommended for use with: polyethylene, nylon and polyurethane tubing.

Part Number	Pipe Size	Tube Size	PRICE EACH
-------------	-----------	-----------	------------

G6016P... MALE CONNECTOR

G6016P-01-02	1/16"	1/8"	\$5.00
G6016P-01-02.5	1/16"	5/32"	6.50
G6016P-02-02	1/8"	1/8"	4.00
G6016P-02-02.5	1/8"	5/32"	3.80
G6016P-02-03	1/8"	3/16"	7.00
G6016P-02-04	1/8"	1/4"	4.30
G6016P-02-05	1/8"	5/16"	4.80
G6016P-02-06	1/8"	3/8"	6.00
G6016P-04-02	1/4"	1/8"	4.20
G6016P-04-02.5	1/4"	5/32"	4.70
G6016P-04-03	1/4"	3/16"	7.10
G6016P-04-04	1/4"	1/4"	4.00
G6016P-04-05	1/4"	5/16"	5.40
G6016P-04-06	1/4"	3/8"	6.00
G6016P-04-08	1/4"	1/2"	9.70
G6016P-06-04	3/8"	1/4"	4.70
G6016P-06-05	3/8"	5/16"	6.60
G6016P-06-06	3/8"	3/8"	6.20
G6016P-06-08	3/8"	1/2"	9.60
G6016P-08-06	1/2"	3/8"	8.80
G6016P-08-08	1/2"	1/2"	9.70

G6016P-UNF... UNF MALE CONNECTOR

	Thread		
G6016P-UNF-02	10-32	1/8"	3.60
G6016P-UNF-02.5	10-32	5/32"	3.60
G6016P-UNF-04	10-32	1/4"	4.40

G6008P... FEMALE CONNECTOR

G6008P-02-04	1/8"	1/4"	5.70
--------------	------	------	------

G6060P... UNION

	Tube Size		
G6060P-02-02	1/8"	1/8"	7.90
G6060P-02.5-02.5	5/32"	5/32"	6.20
G6060P-03-03	3/16"	3/16"	12.10
G6060P-04-04	1/4"	1/4"	7.00
G6060P-05-05	5/16"	5/16"	6.80
G6060P-06-06	3/8"	3/8"	9.50
G6060P-08-08	1/2"	1/2"	12.70

Part Number	Pipe Size	Tube Size	PRICE EACH
-------------	-----------	-----------	------------

G6090P... 90° UNION

G6090P-02-02	1/8"	1/8"	\$7.80
G6090P-02.5-02.5	5/32"	5/32"	6.40
G6090P-04-04	1/4"	1/4"	7.10
G6090P-05-05	5/16"	5/16"	7.90
G6090P-06-06	3/8"	3/8"	11.20
G6090P-08-08	1/2"	1/2"	14.00

G6096P... 90° MALE CONNECTOR

G6096P-01-02	1/16"	1/8"	8.00
G6096P-01-02.5	1/16"	5/32"	6.80
G6096P-02-02	1/8"	1/8"	6.00
G6096P-02-02.5	1/8"	5/32"	5.80
G6096P-02-03	1/8"	3/16"	8.70
G6096P-02-04	1/8"	1/4"	5.60
G6096P-02-05	1/8"	5/16"	8.00
G6096P-02-06	1/8"	3/8"	9.00
G6096P-04-02	1/4"	1/8"	6.90
G6096P-04-02.5	1/4"	5/32"	6.70
G6096P-04-04	1/4"	1/4"	6.50
G6096P-04-05	1/4"	5/16"	7.90
G6096P-04-06	1/4"	3/8"	10.10
G6096P-04-08	1/4"	1/2"	11.80
G6096P-06-04	3/8"	1/4"	8.30
G6096P-06-05	3/8"	5/16"	9.50
G6096P-06-06	3/8"	3/8"	10.10
G6096P-06-08	3/8"	1/2"	12.30
G6096P-08-06	1/2"	3/8"	11.20
G6096P-08-08	1/2"	1/2"	12.90

G6096P-UNF... 90° UNF MALE CONNECTOR

	Thread Size		
G6096P-UNF-02	10-32	1/8"	8.20
G6096P-UNF-02.5	10-32	5/32"	5.80
G6096P-UNF-04	10-32	1/4"	7.20

Note: Male pipe ends on tees and elbows are swivel style to allow easy orientation during installation

PUSH-TO-CONNECT TUBE FITTINGS

Part Number	Pipe Size	Tube Size	PRICE EACH
-------------	-----------	-----------	------------

G60T00P... UNION TEE



	Tube Size		
G60T00P-02-02	1/8"	1/8"	\$9.60
G60T00P-02.5-02.5	5/32"	5/32"	8.20
G60T00P-03-03	3/16"	3/16"	13.70
G60T00P-04-04	1/4"	1/4"	8.70
G60T00P-05-05	5/16"	5/16"	10.20
G60T00P-06-06	3/8"	3/8"	14.00
G60T00P-08-08	1/2"	1/2"	16.70

G60T06P... MALE BRANCH TEE

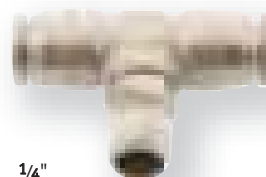

	Pipe Size		
G60T06P-02-04	1/8"	1/4"	9.30
G60T06P-04-04	1/4"	1/4"	11.00
G60T06P-04-06	1/4"	3/8"	16.60

G60T60P... MALE RUN TEE



G60T60P-02-04	1/8"	1/4"	9.30
G60T60P-02-06	1/8"	3/8"	16.20
G60T60P-04-04	1/4"	1/4"	10.90
G60T60P-04-06	1/4"	3/8"	15.30

G6100P... PLUG

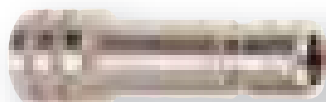

G6100P-02	1/8"	2.00
G6100P-02.5	5/32"	2.00
G6100P-04	1/4"	2.40
G6100P-05	5/16"	4.00
G6100P-06	3/8"	4.40

NYLON HOSE BARBS

The white nylon fittings shown here are made with FDA approved type 6/6 nylon. They are rated to a maximum working pressure of 75 psi and will withstand temperatures to 60°C (140°F).

Part Number	Hose Size	Hose Size	PRICE EACH		Pkg Qty
			Loose	Std Pkg	
G20N... NYLON HOSE MENDER					
G20N-013	1/8"		\$0.95	\$0.81	10
G20N-019	3/16"		1.05	0.83	10
G20N-025	1/4"		0.83	0.72	10
G20N-031	5/16"		1.15	0.92	10
G20N-038	3/8"		1.05	0.83	10
G20N-038-025	3/8"	1/4"	1.15	0.98	10
G20N-050	1/2"		1.15	0.99	10
G20N-050-025	1/2"	1/4"	1.35	1.10	10
G20N-050-038	1/2"	3/8"	1.05	0.83	10
G20N-063	5/8"		1.35	1.10	10
G20N-063-038	5/8"	3/8"	1.46	1.20	10
G20N-063-050	5/8"	1/2"	1.75	1.45	10
G20N-075	3/4"		1.45	1.20	10
G20N-100	1"		1.66	1.40	10
G20N-125	1 1/4"		2.90	2.40	10
G20N-150	1 1/2"		4.60	3.90	10
G20N-200	2"		11.10	9.30	10



G20N90... NYLON 90° HOSE MENDER

G20N90-025	1/4"		1.98	1.65	10
G20N90-038	3/8"		1.77	1.50	10
G20N90-050	1/2"		1.51	1.25	10
G20N90-050-025	1/2"	1/4"	2.08	1.77	10
G20N90-050-038	1/2"	3/8"	1.98	1.66	10
G20N90-063	5/8"		2.08	1.72	10
G20N90-075	3/4"		1.77	1.45	10
G20N90-100	1"		4.50	3.70	10
G20N90-125	1 1/4"		7.40	6.10	10
G20N90-150	1 1/2"		8.00	6.70	10
G20N90-200	2"		15.80	13.20	10



Part Number	Hose Size	Hose Size	PRICE EACH		Pkg Qty
			Loose	Std Pkg	

G21N... NYLON MALE NPT HOSE BARB

Part Number	Hose Size	Pipe Size	Hose Size	PRICE EACH		Pkg Qty
				Loose	Std Pkg	
G21N-013-019	1/8"	1/8"	3/16"	1.14	0.97	10
G21N-013-025	1/8"	1/8"	1/4"	0.94	0.75	10
G21N-013-031	1/8"	1/8"	5/16"	1.14	0.99	10
G21N-013-038	1/8"	1/8"	3/8"	0.94	0.76	10
G21N-025-025	1/4"	1/4"	1/4"	0.94	0.76	10
G21N-025-031	1/4"	1/4"	5/16"	1.35	1.15	10
G21N-025-038	1/4"	1/4"	3/8"	0.94	0.78	10
G21N-025-050	1/4"	1/4"	1/2"	0.94	0.80	10
G21N-038-025	3/8"	3/8"	1/4"	0.94	0.79	10
G21N-038-031	3/8"	3/8"	5/16"	1.66	1.35	10
G21N-038-038	3/8"	3/8"	3/8"	0.94	0.80	10
G21N-038-050	3/8"	3/8"	1/2"	0.94	0.80	10
G21N-038-063	3/8"	3/8"	5/8"	0.94	0.80	10
G21N-050-025	1/2"	1/2"	1/4"	1.04	0.84	10
G21N-050-038	1/2"	1/2"	3/8"	1.04	0.85	10
G21N-050-050	1/2"	1/2"	1/2"	1.04	0.87	10
G21N-050-063	1/2"	1/2"	5/8"	1.14	0.93	10
G21N-050-075	1/2"	1/2"	3/4"	1.25	1.07	10
G21N-075-038	3/4"	3/4"	3/8"	1.14	0.97	10
G21N-075-050	3/4"	3/4"	1/2"	1.14	0.99	10
G21N-075-063	3/4"	3/4"	5/8"	1.87	1.52	10
G21N-075-075	3/4"	3/4"	3/4"	1.25	1.07	10
G21N-075-100	3/4"	3/4"	1"	1.56	1.30	10
G21N-100-050	1"	1"	1/2"	2.08	1.77	10
G21N-100-075	1"	1"	3/4"	1.66	1.35	10
G21N-100-100	1"	1"	1"	1.77	1.45	10
G21N-100-125	1"	1"	1 1/4"	4.30	3.50	10
G21N-125-100	1 1/4"	1 1/4"	1"	4.20	3.40	10
G21N-125-125	1 1/4"	1 1/4"	1 1/4"	3.50	2.90	10
G21N-125-150	1 1/4"	1 1/4"	1 1/2"	3.80	3.20	10
G21N-150-125	1 1/2"	1 1/2"	1 1/4"	4.00	3.30	10
G21N-150-150	1 1/2"	1 1/2"	1 1/2"	3.80	3.20	10
G21N-200-150	2"	2"	1 1/2"	10.70	8.90	10
G21N-200-200	2"	2"	2"	5.20	4.40	10



G22N... NYLON FEMALE NPT HOSE BARB

G22N-050-050	1/2"	1/2"	3.12	2.29	10
--------------	------	------	------	------	----

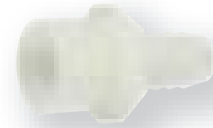

10

Nylon & Polypropylene

NYLON HOSE BARBS

Part Number Pipe Size Hose Size PRICE EACH Pkg Qty
Loose Std Pkg

G21N90... NYLON 90° MALE NPT HOSE BARB

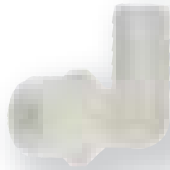

G21N90-013-025	1/8"	1/4"	\$1.35	\$1.09	10
G21N90-013-038	1/8"	3/8"	2.39	1.98	10
G21N90-025-025	1/4"	1/4"	1.35	1.09	10
G21N90-025-038	1/4"	3/8"	1.35	1.14	10
G21N90-025-050	1/4"	1/2"	1.35	1.09	10
G21N90-038-025	3/8"	1/4"	1.35	1.14	10
G21N90-038-038	3/8"	3/8"	1.46	1.20	10
G21N90-038-050	3/8"	1/2"	1.46	1.25	10
G21N90-038-063	3/8"	5/8"	1.50	1.25	10
G21N90-050-025	1/2"	1/4"	2.60	2.18	10
G21N90-050-038	1/2"	3/8"	1.50	1.25	10
G21N90-050-050	1/2"	1/2"	1.50	1.25	10
G21N90-050-063	1/2"	5/8"	1.87	1.50	10
G21N90-050-075	1/2"	3/4"	1.98	1.60	10
G21N90-075-038	3/4"	3/8"	2.10	1.72	10
G21N90-075-050	3/4"	1/2"	1.98	1.60	10
G21N90-075-063	3/4"	5/8"	1.87	1.50	10
G21N90-075-075	3/4"	3/4"	2.08	1.72	10
G21N90-075-100	3/4"	1"	2.20	1.82	10
G21N90-100-075	1"	3/4"	2.39	1.98	10
G21N90-100-100	1"	1"	2.39	1.98	10
G21N90-125-125	1 1/4"	1 1/4"	4.30	3.50	10
G21N90-150-150	1 1/2"	1 1/2"	6.10	5.00	10
G21N90-200-200	2"	2"	7.00	5.80	10

G20NT... NYLON HOSE TEE



Part Number	Run Size	Branch Size	PRICE EACH	Pkg Qty	
G20NT-013	1/8"		2.08	1.77	10
G20NT-019	3/16"		2.29	1.94	10
G20NT-025	1/4"		1.65	1.35	10
G20NT-031	5/16"		2.50	2.08	10
G20NT-038	3/8"		1.66	1.40	10
G20NT-038-025	3/8"	1/4"	2.08	1.77	10
G20NT-038-050	3/8"	1/2"	2.60	2.18	10
G20NT-050	1/2"		1.77	1.46	10
G20NT-050-038	1/2"	3/8"	1.98	1.66	10
G20NT-063	5/8"		1.87	1.56	10
G20NT-075	3/4"		2.08	1.77	10
G20NT-100	1"		3.60	3.10	10
G20NT-125	1 1/4"		5.40	4.50	10
G20NT-150	1 1/2"		6.40	5.40	10
G20NT-200	2"		18.30	15.30	10

Part Number Pipe Size Hose Size PRICE EACH Pkg Qty
Loose Std Pkg

G20NTM... NYLON MALE BRANCH TEE



Part Number	Pipe Size	Hose Size	PRICE EACH	Pkg Qty	
G20NTM-013-025	1/8"	1/4"	\$3.95	\$3.30	10
G20NTM-025	1/4"	1/4"	2.70	2.30	10
G20NTM-025-038	1/4"	3/8"	2.65	2.15	10
G20NTM-038	3/8"	3/8"	3.00	2.50	10
G20NTM-050	1/2"	1/2"	4.40	3.60	10
G20NTM-075	3/4"	3/4"	2.60	2.10	10

G36NF... NYLON FEMALE GARDEN HOSE COUPLING



G36NF-038	3/8"	2.10	1.75	10
G36NF-050	1/2"	2.10	1.75	10
G36NF-063	5/8"	2.10	1.75	10
G36NF-075	3/4"	2.10	1.75	10

G36NM... NYLON MALE GARDEN HOSE COUPLING



G36NM-038	3/8"	1.35	1.15	10
G36NM-050	1/2"	1.35	1.15	10
G36NM-063	5/8"	1.35	1.15	10
G36NM-075	3/4"	1.35	1.15	10

G33N... NYLON COMBINATION NIPPLE



G33N-075	3/4"	2.30	2.10	5
G33N-100	1"	2.80	2.40	5
G33N-125	1 1/4"	3.90	3.60	5
G33N-150	1 1/2"	5.30	4.80	5
G33N-200	2"	8.10	7.30	5
G33N-300	3"		15.70	1
G33N-400	4"		22.80	1

10

Nylon & Polypropylene

NYLON & POLYPROPYLENE FITTINGS

Part Number	PRICE EACH		Pkg Qty
	Loose	Std Pkg	
G0816N... NYLON BUSHING			
	Male Pipe	Female Pipe	
G0816N-050-025	1/2"	1/4"	\$2.30 \$1.87 10
G0816N-050-038	1/2"	3/8"	2.30 1.87 10
G0816N-075-025	3/4"	1/4"	2.60 2.08 10
G0816N-075-038	3/4"	3/8"	2.60 2.08 10
G0816N-075-050	3/4"	1/2"	2.30 1.87 10
G0816N-100-050	1"	1/2"	3.40 2.60 10
G0816N-100-075	1"	3/4"	2.90 2.20 10
G0816N-125-100	1 1/4"	1"	4.20 3.30 10
G0816N-150-100	1 1/2"	1"	4.80 3.80 10
G0816N-150-125	1 1/2"	1 1/4"	4.80 3.80 10
G0816N-200-100	2"	1"	9.70 7.70 10
G0816N-200-150	2"	1 1/2"	8.60 7.00 10



G1600N... NYLON HEX HEAD PLUG

Part Number	Pipe Size	PRICE EACH	Pkg Qty
G1600N-013	1/8"	0.94	0.73 10
G1600N-025	1/4"	0.94	0.73 10
G1600N-038	3/8"	1.14	0.95 10
G1600N-050	1/2"	1.15	0.95 10
G1600N-075	3/4"	1.45	1.25 10
G1600N-100	1"	1.55	1.25 10



G6016N... NYLON COMPRESSION FITTING

Part Number	Pipe Size	Tube O.D.	PRICE EACH	Pkg Qty
G6016N-04-04	1/4"	1/4"	2.60	2.18 10
G6016N-04-06	1/4"	3/8"	3.22	2.60 10
G6016N-06-06	3/8"	3/8"	3.55	2.90 10
G6016N-08-08	1/2"	1/2"	6.97	5.60 10



G6096N... NYLON 90° COMPRESSION MALE NPT FITTING

Part Number	Pipe Size	Tube O.D.	PRICE EACH	Pkg Qty
G6096N-04-04	1/4"	1/4"	5.40	4.30 10
G6096N-04-06	1/4"	3/8"	4.80	4.00 10
G6096N-06-06	3/8"	3/8"	7.50	5.90 10



G0808PBH... POLYPROPYLENE BULKHEAD COUPLING

Part Number	Pipe Size	PRICE EACH		Pkg Qty
		Loose	Std Pkg	
G0808PBH-050-050	1/2"	\$12.00	\$10.00	10
G0808PBH-075-075	3/4"	11.10	9.30	10
G0808PBH-100-100	1"	14.40	12.00	10
G0808PBH-125-125	1 1/4"	13.50	11.20	10
G0808PBH-150-150	1 1/2"	16.70	13.90	10
G0808PBH-200-200	2"	16.70	13.90	10
G0808PBH-300-300	3"	61.50	52.10	10



Green Line now offers a solution for adapting to buttress threads commonly found on water totes, intermediate bulk containers, and pallet tanks.

G16008PB... POLYPROPYLENE MALE NPT 60 MM DIN BUTTRESS ADAPTER

Part Number	Pipe Size	PRICE EACH	Pkg Qty
G16008PB-200	2"	44.40	1



G65PAB... POLYPROPYLENE MALE CAM-LOCK 60 MM DIN BUTTRESS ADAPTER

Part Number	Size	PRICE EACH	Pkg Qty
G65PAB-200	2"	34.60	1



10

Nylon & Polypropylene

DOUBLE BOLT CLAMPS

These double-bolt clamps are made from plated ductile iron. In the smaller sizes (3/4" to 2") they are popular for hydraulic suction lines, while larger clamps are often used for irrigation and general suction and discharge service.

Spiral double-bolt clamps are designed to provide superior sealing on corrugated PVC suction hoses such as G941W, G941WT, and G1741. Note: different manufacturers may use either a clockwise or counter-clockwise spiral in their hose. Our standard corrugated hoses spiral in the counter-clockwise direction (similar to a left hand thread), and these clamps are designed for that spiral only. For clockwise spiral clamps, specify G38WR.

Part Number	Minimum Size	Maximum Size	PRICE EACH
-------------	--------------	--------------	------------

G38... DOUBLE BOLT CLAMPS (3/4" - 2")

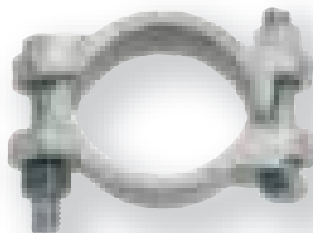

G38-075	1.13"	1.19"	\$5.40
G38-100	1.30"	1.50"	8.60
G38-125	1.75"	2.05"	9.10
G38-150	2.11"	2.30"	9.20
G38-200	2.31"	2.63"	11.10

G38... DOUBLE BOLT CLAMPS (2 1/2" - 17")

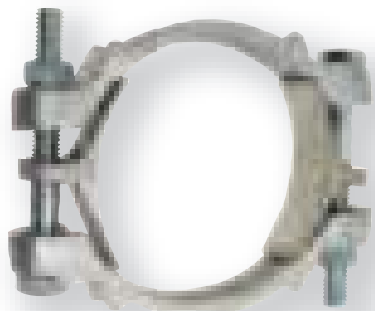

G38-250	2.38"	3.06"	11.80
G38-300	3.03"	3.69"	12.70
G38-400	3.50"	4.00"	13.40
G38-463	4.06"	4.56"	14.10
G38-525	4.19"	5.00"	17.70
G38-550	5.00"	5.50"	18.90
G38-600	5.50"	6.06"	21.40
G38-639	5.69"	5.94"	23.10
G38-675	6.13"	6.88"	23.10
G38-769	6.94"	7.63"	26.90
G38-818	7.69"	8.19"	38.10
G38-875	8.25"	8.88"	38.10
G38-988	8.94"	9.88"	43.00
G38-1125	9.94"	11.38"	72.20
G38-1275	11.19"	13.00"	85.60
G38-1360	12.19"	14.00"	109.20
G38-1450	13.19"	15.00"	116.10
G38-1700	15.06"	17.50"	161.10

Part Number	Minimum Size	Maximum Size	PRICE EACH
-------------	--------------	--------------	------------

G38W... SPIRAL DOUBLE-BOLT CLAMP



G38W-200	2"		\$10.70
G38W-250	2 1/2"		11.90
G38W-300	3"		12.80
G38W-400	4"		14.40
G38W-500	5"		20.10
G38W-600	6"		22.50
G38W-800	8"		27.20
G38W-1000	10"		37.80
G38W-1200	12"		41.70

G29C BOLT CLAMPS

G29C clamps are designed to lock into the collars provided on G23S and G29S hose stems. This feature prevents fitting pull-out. G29C clamps are plated ductile iron. Clamps have two, four, or even six bolts depending on size.

G29C... BOLT CLAMPS

Part Number	Nominal Size	Hose Minimum	O.D. Max	Cross Reference	Tightening Torque*	PRICE Loose	EACH Std Pkg	Pkg Qty
G29C-038	3/8"	0.69"	0.88"	CD	6 ft lb	\$5.70	\$5.30	5
G29C-050AA	1/2"	0.81"	0.94"	DD	6	6.00	5.60	5
G29C-050A	1/2"	0.94"	1.06"	B4	12	6.00	5.60	5
G29C-050B	1/2"	1.06"	1.19"	B5	12	6.70	5.90	5
G29C-075AA	3/4"	1.16"	1.28"	BU9S	21	7.40	6.80	5
G29C-075A	3/4"	1.19"	1.31"	BU9	21	7.40	6.80	5
G29C-075B	3/4"	1.31"	1.50"	B9	21	8.80	8.10	5
G29C-075C	3/4"	1.50"	1.69"	B10	21	10.20	9.10	5
G29C-100AA	1"	1.41"	1.56"	156	21	13.00	11.80	5
G29C-100A	1"	1.53"	1.72"	BU14	21	13.00	11.80	5
G29C-100B	1"	1.63"	1.84"	B14	21	13.60	12.20	5
G29C-100C	1"	1.88"	2.06"	B15	21	17.40	15.60	5
G29C-125	1 1/4"	2.06"	2.25"	B19	40	19.80	17.60	5
G29C-150AAA	1 1/2"	1.81"	2.00"	BU22	40	21.60	19.40	5
G29C-150AA	1 1/2"	2.00"	2.22"	B22	40	21.60	19.40	5
G29C-150A	1 1/2"	2.09"	2.28"	BU24	40	23.10	20.80	5
G29C-150B	1 1/2"	2.25"	2.44"	B24	40	23.10	20.80	5
G29C-150C	1 1/2"	2.47"	2.72"	B25	40	27.20	24.50	5
G29C-200AA	2"	2.34"	2.53"	BU28	60	28.20	25.30	5
G29C-200A	2"	2.50"	2.78"	BU29	60	28.20	25.30	5
G29C-200B	2"	2.75"	3.06"	B29	60	34.10	30.60	5
G29C-200C	2"	3.09"	3.44"	B30	60	57.20	51.40	5
G29C-250	2 1/2"	3.50"	3.94"	B34	150		57.80	1
G29C-300AA	3"	3.50"	3.94"	BU35	150		57.20	1
G29C-300A	3"	3.81"	4.19"	B35	150		59.60	1
G29C-400AA	4"	4.25"	4.81"	BS39	200		189.30	1

* Recommended tightening torque for dry (un-lubricated) bolts.



G29C

G29CR crimp ferrules are designed to interlock with our G29SC ground joint hose stems and allow for a crimpable ground joint steam hose option. G29CR crimp ferrules are all plated steel.

G29CR... STEAM HOSE CRIMP FERRULES



Part Number	Nom. Size	Ferrule I.D.	Ferrule Length	PRICE Loose	EACH Std Pkg	Pkg Qty
G29CR-075	3/4"	1.252"	2.465"		10.20	1
G29CR-100	1"	1.562"	2.618"		17.40	1
G29CR-200	2"	2.689"	4.000"		34.10	1

Safety Note: G29CR Crimp Ferrules are to be used with G29SC Crimpable Ground Joint Stems only. For pipe thread, please use Pulsar 9600 Series Crimp Fittings.

GEAR CLAMPS

G7/G7M... CARBON STEEL GEAR CLAMP

Our Green Line G7 series clamps are popular in the automotive industry, and feature a stainless band and screw housing with a plated carbon steel screw. G7M bands are 5/16" wide, and G7 bands are 1/2" wide. G7 clamps are not recommended for underground applications or corrosive environments.

G8/G8M... ALL STAINLESS STEEL GEAR CLAMP

Our Green Line G8 series clamps are completely stainless steel. The G8M clamps have a 5/16" wide type 301 stainless band with a type 410 stainless screw. G8 clamps have a 1/2" wide, 300 series stainless band and screw.

Part Number	Nom. Size	Min. Size	Max. Size	PRICE EACH		Pkg Qty
				Loose	Std Pkg	

G7M... MICRO CARBON STEEL GEAR CLAMP



G7M-04	1/4"	0.22"	0.63"	\$0.80	\$0.67	10
G7M-06	3/8"	0.31"	0.88"	0.80	0.67	10
G7M-08	1/2"	0.44"	1.00"	0.80	0.67	10
G7M-12	3/4"	0.56"	1.25"	0.80	0.67	10
G7M-24	1 1/2"	1.31"	2.00"	0.80	0.68	10
G7M-32	2 1/8"	1.81"	2.50"	1.20	1.00	10
G7M-36	2 1/4"	2.06"	2.75"	1.60	1.34	10

Part Number	Nom. Size	Min. Size	Max. Size	PRICE EACH		Pkg Qty
				Loose	Std Pkg	

G8M... ALL STAINLESS MICRO GEAR CLAMP



G8M-04	1/4"	0.22"	0.63"	\$1.10	\$0.93	10
G8M-05	5/16"	0.43"	0.71"	1.20	0.98	10
G8M-06	3/8"	0.31"	0.88"	1.20	1.03	10
G8M-08	1/2"	0.44"	1.00"	1.20	1.03	10
G8M-10	5/8"	0.50"	1.06"	1.20	1.03	10
G8M-12	3/4"	0.56"	1.25"	1.20	1.03	10

G7... CARBON STEEL GEAR CLAMPS



G7-06	3/8"	0.38"	0.88"	1.05	0.85	10
G7-08	1/2"	0.44"	1.00"	1.05	0.88	10
G7-10	5/8"	0.56"	1.06"	1.10	0.89	10
G7-12	3/4"	0.56"	1.25"	1.15	0.94	10
G7-16	1"	0.69"	1.50"	1.15	0.94	10
G7-20	1 1/4"	0.75"	1.75"	1.15	0.94	10
G7-24	1 1/2"	1.06"	2.00"	1.20	0.98	10
G7-28	1 3/4"	1.31"	2.25"	1.20	0.98	10
G7-32	2"	1.56"	2.50"	1.25	1.03	10
G7-36	2 1/4"	1.81"	2.75"	1.30	1.08	10
G7-40	2 1/2"	2.06"	3.00"	1.40	1.18	10
G7-44	2 3/4"	2.31"	3.25"	1.60	1.34	10
G7-48	3"	2.56"	3.50"	1.60	1.34	10
G7-52	3 1/4"	2.81"	3.75"	1.70	1.40	10
G7-56	3 1/2"	3.06"	4.00"	1.70	1.40	10
G7-60	3 3/4"	3.31"	4.25"	1.80	1.50	10
G7-64	4"	2.50"	4.50"	1.80	1.50	10
G7-72	4 1/2"	3.00"	5.00"	1.80	1.50	10
G7-80	5"	3.50"	5.50"	1.90	1.60	10
G7-84	5 1/4"	3.75"	5.75"	1.90	1.60	10
G7-88	5 1/2"	4.00"	6.00"	1.90	1.65	10
G7-96	6"	4.50"	6.50"	2.10	1.80	10
G7-104	6 1/2"	5.00"	7.00"	2.60	2.20	10
G7-116	7"	5.75"	7.75"	3.00	2.50	10
G7-128	8"	6.50"	8.50"	3.20	2.70	10
G7-152	9 1/2"	2.00"	10.00"	3.70	3.10	10
G7-188	11 3/4"	10.25"	12.25"	5.30	4.50	10
G7-200	12 1/2"	11.00"	13.00"	5.50	4.70	10
G7-212	13 1/4"	11.75"	13.75"	5.70	4.80	10
G7-224	14"	12.50"	14.50"	5.80	4.90	10
G7-390	24 3/8"	22.88"	24.88"	8.40	7.10	10

G8... ALL STAINLESS STEEL GEAR CLAMP



G8-06	3/8"	0.44"	0.88"	1.30	1.08	10
G8-08	1/2"	0.44"	1.00"	1.30	1.10	10
G8-10	5/8"	0.56"	1.06"	1.35	1.13	10
G8-12	3/4"	0.56"	1.25"	1.35	1.13	10
G8-16	1"	0.69"	1.50"	1.35	1.13	10
G8-20	1 1/4"	0.75"	1.75"	1.35	1.13	10
G8-24	1 1/2"	1.06"	2.00"	1.35	1.13	10
G8-28	1 3/4"	1.31"	2.25"	1.40	1.18	10
G8-32	2"	1.56"	2.50"	1.40	1.18	10
G8-36	2 1/4"	1.81"	2.75"	1.50	1.25	10
G8-40	2 1/2"	2.06"	3.00"	1.50	1.29	10
G8-44	2 3/4"	2.31"	3.25"	1.70	1.45	10
G8-48	3"	2.56"	3.50"	1.70	1.45	10
G8-52	3 1/4"	2.81"	3.75"	1.80	1.50	10
G8-56	3 1/2"	3.06"	4.00"	1.80	1.50	10
G8-60	3 3/4"	3.31"	4.25"	1.90	1.65	10
G8-64	4"	2.50"	4.50"	1.90	1.65	10
G8-72	4 1/2"	3.00"	5.00"	2.00	1.70	10
G8-80	5"	3.50"	5.50"	2.20	1.85	10
G8-84	5 1/4"	3.75"	5.75"	2.20	1.85	10
G8-88	5 1/2"	4.00"	6.00"	2.20	1.90	10
G8-96	6"	4.50"	6.50"	2.35	2.00	10
G8-104	6 1/2"	5.00"	7.00"	2.90	2.50	10
G8-116	7"	5.75"	7.75"	3.20	2.70	10
G8-128	8"	6.50"	8.50"	3.30	2.80	10
G8-152	9 1/2"	2.00"	10.00"	3.70	3.10	10
G8-164	10 1/4"	1.75"	10.75"	3.80	3.20	10
G8-188	11 3/4"	2.25"	12.25"	4.60	3.90	10
G8-200	12 1/2"	11.00"	13.00"	4.80	4.10	10
G8-212	13 1/4"	11.75"	13.75"	5.10	4.30	10
G8-248	15 1/2"	14.06"	16.00"	5.50	4.70	10
G8-270	16 7/8"	15.38"	17.38"	5.80	4.90	10
G8-312	19 1/2"	18.00"	20.00"	7.10	6.00	10
G8-390	24 3/8"	22.88"	24.88"	7.70	6.50	10

GEAR CLAMP RACKS



G7RACK-130



G7RACK-250

Display your stainless gear clamps on this attractive point of sale rack. It holds ten of the most popular sizes of gear clamps from -03 to -28 in the back row, and ten mini bolt clamp sizes -08 to -17 in the front.



Part No.	Description	PRICE EACH
G7RACK-130	Holds 130 clamps 16" W x 17 3/8" H x 67/8" D	\$111.90
G7RACK-250	Holds 250 clamps 21 1/8" W x 24 1/8" H x 67/8" D	159.50

Part No.	Description	PRICE EACH
G5A-RACK	Wire rack (clamps not included) 24 1/4" w x 15 1/2" h x 5 5/8" d	\$143.40

FREE
WITH ORDER OF 100+
G92 OR G94 CLAMPS

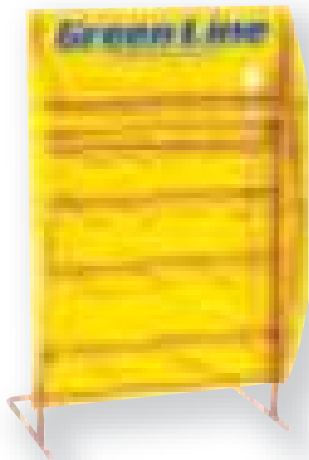

Our G92 clamp rack has been modified to hold more clamps. The 26 pegs have been lengthened to hold 10 smaller sized clamps, 9 of intermediate sizes, and 7 of the larger sizes.

Part Number	Description	PRICE EACH
G92-RACK	19 1/2" W x 32" H x 10 1/2" D	\$175.80

SPECIALTY GEAR CLAMPS

G5 series gear clamps are manufactured entirely with grade 316 stainless steel for extra corrosion resistance. They were designed for use in marine applications where 201 and 301 stainless materials show signs of corrosion. G5 all 316 stainless clamps are ideal for use in shipbuilding, marine engine repair, water treatment plants, pulp and paper manufacturing, and chemical plants. They provide extra reliability in underground installations such as sprinkler and swimming pool piping. G5M micro series have a 1/4" wide band, and G5 are made from 1/2" wide band.

Part No.	Nom.	Min.	Max.	PRICE EACH		Pkg Qty
	Size	Size	Size	Loose	Std Pkg	

G5M... TYPE 316 STAINLESS MICRO GEAR CLAMP



G5M-04	1/4"	0.31"	0.63"	\$1.30	\$1.10	10
G5M-06	3/8"	0.44"	0.88"	1.30	1.10	10

G5... TYPE 316 STAINLESS GEAR CLAMPS



G5-10	5/8"	0.56"	1.06"	2.10	1.75	10
G5-12	3/4"	0.56"	1.25"	2.10	1.75	10
G5-16	1"	0.69"	1.50"	2.10	1.75	10
G5-20	1 1/4"	0.75"	1.75"	2.10	1.75	10
G5-24	1 1/2"	1.06"	2.00"	2.20	1.85	10
G5-28	1 3/4"	1.31"	2.25"	2.40	2.00	10
G5-32	2"	1.56"	2.50"	2.40	2.00	10
G5-36	2 1/4"	1.81"	2.75"	2.40	2.00	10
G5-44	2 3/4"	2.31"	3.25"	2.70	2.30	10
G5-52	3 1/4"	2.81"	3.75"	2.70	2.30	10
G5-60	3 3/4"	3.31"	4.25"	2.80	2.40	10
G5-72	4 1/2"	3.00"	5.00"	3.00	2.50	10

G8L... QUICK RELEASE GEAR CLAMP



G8L-72	4 1/2"	2.00"	5.00"	3.40	2.90	10
G8L-88	5 1/2"	2.16"	6.00"	3.80	3.20	10
G8L-128	8"	1.75"	8.56"	5.70	4.80	10
G8L-152	9 1/2"	2.00"	10.00"	6.40	5.40	10
G8L-248	15 1/2"	1.75"	16.00"	10.40	8.80	10

Quick release clamps employ a hinged housing on the clamp screw to allow instant release and fast installation. They are useful in applications where the clamp is often disconnected, such as in filter bag systems. G8L clamps are all stainless and have a very wide range of adjustment.

G7ET/G7ETM... EXTENDED TANG GEAR CLAMP

A continuous smooth shield underneath the serrated portion of the gear clamp prevents soft silicone hose from extruding out at high temperatures. The use of regular gear clamps on silicone hose may result in leaks and possible hose blow-off.

Part No.	Nom.	Min.	Max.	PRICE EACH		Pkg Qty
	Size	Size	Size	Loose	Std Pkg	

G7ETM... MICRO EXTENDED TANG (SILICONE HOSE) GEAR CLAMP



G7ETM-04	1/4"	0.31"	0.56"	\$1.55	\$1.35	10
G7ETM-06	3/8"	0.56"	0.88"	1.70	1.45	10

G7ET... EXTENDED TANG (SILICONE HOSE) GEAR CLAMP



G7ET-08	1/2"	0.63"	0.81"	2.10	1.75	10
G7ET-10	5/8"	0.75"	0.94"	2.10	1.75	10
G7ET-12	3/4"	0.75"	1.13"	2.10	1.75	10
G7ET-16	1"	0.81"	1.38"	2.10	1.75	10
G7ET-20	1 1/4"	1.13"	1.63"	2.10	1.75	10
G7ET-24	1 1/2"	1.19"	1.94"	2.10	1.75	10
G7ET-28	1 3/4"	1.31"	2.25"	2.40	2.05	10
G7ET-32	2"	1.56"	2.50"	2.30	1.95	10
G7ET-36	2 1/4"	1.81"	2.75"	2.40	2.05	10
G7ET-40	2 1/2"	2.06"	3.00"	2.50	2.15	10
G7ET-44	2 3/4"	2.31"	3.25"	2.70	2.30	10
G7ET-48	3"	2.56"	3.50"	2.70	2.30	10
G7ET-56	3 1/2"	3.06"	4.00"	2.80	2.40	10
G7ET-60	3 3/4"	3.31"	4.25"	2.80	2.40	10
G7ET-64	4"	2.50"	4.50"	3.30	2.80	10

Featuring a stainless steel band and housing with a zinc-plated, steel screw, our G7A Gear Clamps combine a stamped band thread, beveled band edge, and a smooth underside to protect any hose from damage. G7A clamps have a 9mm wide band and are ideal for general industrial applications.

G7A... ZINC-PLATED STEEL GEAR CLAMP



Part No.	Cross Reference	RANGE		PRICE EACH
		mm	inches	
G7A-0816	03016516	8 - 16	0.31 - 0.62	\$0.78
G7A-1222	03016524	12 - 22	0.46 - 0.87	0.82
G7A-1627	03016532	16 - 27	0.62 - 1.06	0.85
G7A-2032	03016540	20 - 32	0.78 - 1.25	0.89
G7A-2540	03016559	25 - 40	1.00 - 1.56	1.00
G7A-3045	03016567	30 - 45	1.18 - 1.75	1.10
G7A-3250	03016575	32 - 50	1.25 - 1.96	1.20
G7A-4060	03016583	40 - 60	1.56 - 2.37	1.60
G7A-5070	03016591	50 - 70	1.96 - 2.75	1.90

TYPE 316 STAINLESS GEAR CLAMPS

These European style clamps (originally manufactured in Sweden and sold in the marine market under the brand names ABA and AWAB) are now manufactured in America. They feature a non-perforated band with rolled edges that provides superior sealing and prevents hose damage. In addition, the fine pitch threads and riveted housing create a clamp with a very high sealing force. In marine and corrosive applications where safety and reliability are top considerations, these premium stainless clamps are an excellent choice.

Mini bolt clamps provide a sure seal on small diameter tubing and thin walled hoses. The clamp edges are rolled to prevent hose damage. These tiny clamps are made entirely with type 304 stainless material.

Part No.	Cross Reference	Range mm	inches	PRICE EACH
----------	-----------------	----------	--------	------------

G5A/G5AM... TYPE 316 STAINLESS GEAR CLAMP

3/8" Band Width



G5AM-03	319014	8 - 14	0.31 - 0.55	\$4.00
G5AM-04	319017	11 - 17	0.43 - 0.67	4.00
G5AM-06	319020	13 - 20	0.51 - 0.79	4.00

1/2" Band Width



G5A-08	316024	15 - 24	0.59 - 0.94	4.80
G5A-10	316028	19 - 28	0.75 - 1.10	4.80
G5A-12	316032	22 - 32	0.87 - 1.26	4.90
G5A-16	316038	26 - 38	1.02 - 1.50	4.90
G5A-20	316044	32 - 44	1.26 - 1.73	5.00
G5A-24	316050	38 - 50	1.50 - 1.97	5.20
G5A-28	316057	32 - 57	1.26 - 2.24	6.10
G5A-32	316064	38 - 64	1.50 - 2.52	6.10
G5A-36	316070	44 - 70	1.73 - 2.75	6.10

Part No.	Cross Reference	Range mm	inches	PRICE EACH
----------	-----------------	----------	--------	------------

G5AB... TYPE 304 STAINLESS MINI BOLT CLAMP



G5AB-08	306008	7.5 - 8.5	0.30 - 0.33	\$2.50
G5AB-09	306009	8.5 - 9.5	0.33 - 0.37	2.50
G5AB-10	306010	9.5 - 11	0.37 - 0.43	2.50
G5AB-11	306011	10.5 - 12	0.41 - 0.47	2.50
G5AB-12	306012	11.5 - 13	0.45 - 0.51	2.50
G5AB-13	306013	12.5 - 14	0.49 - 0.55	2.50
G5AB-14	306014	13.5 - 15	0.53 - 0.59	2.50
G5AB-15	306015	14.5 - 16	0.57 - 0.63	2.50
G5AB-16	306016	15 - 17	0.59 - 0.67	2.50
G5AB-17	306017	16 - 18	0.63 - 0.71	2.50

HEAVY DUTY BOLT CLAMPS

Where most T-Bolt clamps feature a plated steel fastener, ours is all stainless. This makes the KODIAK® ideal for many marine clamping applications, especially where gear clamps do not provide adequate holding or tightening strength. In addition, KODIAK® clamps fulfill a wide range of industrial applications such as engine coolant, water suction & discharge, and hydraulic suction. G89 clamps feature a 3/4" wide by 0.025" thick type 301 stainless band. The type 302 stainless bolt is fastened by a type 304 nylon inserted locknut. The locknut is rated to 120° C (248° F) and may be tightened to 50 inch lbs.

G39 T-bolt clamps are designed specifically for use with silicone coolant and turbo-charger hoses. Silicone is excellent for very high temperature service, however, it tends to soften and extrude easily when hot. Conventional clamps will seal adequately when cold, but may allow leakage or hose blow-off when hot. G39 clamps feature a spring that maintains a constant tension regardless of temperature. These clamps feature a stainless band and plated steel fastener and spring.

Part Number	Minimum Size	Maximum Size	PRICE EACH
-------------	--------------	--------------	------------

G89... KODIAK® ALL STAINLESS T-BOLT CLAMP



G89-022	1.38"	1.52"	\$7.80
G89-024	1.50"	1.64"	7.80
G89-026	1.63"	1.88"	7.80
G89-028	1.75"	2.00"	8.10
G89-030	1.88"	2.13"	8.10
G89-032	2.00"	2.25"	8.10
G89-034	2.13"	2.38"	8.10
G89-036	2.25"	2.56"	8.20
G89-038	2.38"	2.69"	8.20
G89-040	2.50"	2.81"	8.30
G89-042	2.63"	2.94"	8.50
G89-044	2.75"	3.06"	8.50
G89-046	2.88"	3.19"	8.50
G89-049	3.06"	3.38"	8.50
G89-052	3.25"	3.56"	8.50
G89-054	3.38"	3.69"	8.50
G89-057	3.56"	3.88"	8.50
G89-061	3.81"	4.13"	8.50
G89-065	4.06"	4.38"	8.60
G89-069	4.31"	4.63"	8.60
G89-073	4.56"	4.88"	8.60
G89-077	4.81"	5.13"	8.80
G89-081	5.06"	5.38"	9.00
G89-085	5.31"	5.63"	9.00
G89-089	5.56"	5.88"	9.20
G89-096	6.00"	6.31"	9.20
G89-100	6.25"	6.56"	9.20
G89-104	6.50"	6.81"	9.20
G89-108	6.75"	7.06"	10.10
G89-116	7.25"	7.56"	10.20
G89-124	7.75"	8.06"	10.40
G89-132	8.25"	8.56"	11.00
G89-135	8.44"	8.75"	11.10
G89-148	9.25"	9.56"	11.20
G89-164	10.25"	10.56"	11.40

Part Number	Minimum Size	Maximum Size	PRICE EACH
-------------	--------------	--------------	------------

G39... SPRING LOADED (SILICONE HOSE) CLAMP



G39-036	2.25"	2.56"	\$8.20
G39-038	2.38"	2.69"	8.20
G39-042	2.63"	2.94"	8.20
G39-046	2.88"	3.19"	8.30
G39-050	3.13"	3.44"	8.30
G39-054	3.38"	3.69"	8.30
G39-058	3.63"	3.94"	8.50
G39-062	3.88"	4.19"	8.50
G39-066	4.13"	4.44"	8.50
G39-070	4.38"	4.69"	8.50
G39-074	4.63"	4.94"	8.50
G39-082	5.13"	5.44"	8.70
G39-090	5.63"	5.94"	8.70
G39-100	6.25"	6.56"	9.20

HEAVY DUTY BOLT CLAMPS

The G92 bolt clamp is constructed of grade 430 stainless steel band, with a zinc plated, steel bolt. It is ideal for a variety of applications including hydraulic suction lines, truck and bus radiator hoses, and water suction and discharge service. The unique design creates several advantages over conventional T-bolt clamps:

- Greater size range - these clamps are available as small as 3/4".
- Wider band width - in the larger sizes, the band is wider than the 3/4" band used on conventional T-bolt clamps.
- Easy & fast tightening - a standard socket wrench can be used. A conventional T-bolt clamp requires a deep socket as the nut is tightened on the bolt, but for these clamps, the wrench is used on the bolt head itself, so a deep socket is not required.
- Bevelled band edges - the bevelled edge prevents damage to the hose cover.

For customers who like the special characteristics of our heavy duty bolt clamps, but need an all stainless construction, we have the G94 clamp. G94 clamps share the same features of the G92 standard clamps but are constructed entirely of grade 304 stainless components.

Part Number	Range	Range	Band Width	PRICE EACH	Loose	Std Pkg	Pkg Qty
-------------	-------	-------	------------	------------	-------	---------	---------

G92... HEAVY DUTY BOLT CLAMPS



G92-1719	17 - 19mm	0.67 - 0.75"	0.708"	\$3.90	\$3.50	10	
G92-1921	19 - 21	0.75 - 0.83"	0.708"	3.90	3.50	10	
G92-2123	21 - 23	0.83 - 0.91"	0.708"	3.90	3.50	10	
G92-2325	23 - 25	0.91 - 0.98"	0.708"	4.00	3.60	10	
G92-2527	25 - 27	0.98 - 1.06"	0.708"	4.00	3.60	10	
G92-2729	27 - 29	1.06 - 1.14"	0.708"	4.10	3.70	10	
G92-2931	29 - 31	1.14 - 1.22"	0.787"	5.00	4.50	10	
G92-3134	31 - 34	1.22 - 1.34"	0.787"	5.10	4.60	10	
G92-3437	34 - 37	1.34 - 1.46"	0.787"	5.30	4.80	10	
G92-3740	37 - 40	1.46 - 1.57"	0.787"	5.30	4.80	10	
G92-4043	40 - 43	1.57 - 1.69"	0.787"	5.30	4.80	10	
G92-4347	43 - 47	1.69 - 1.85"	0.787"	6.30	5.60	10	
G92-4751	47 - 51	1.85 - 2.01"	0.787"	6.50	5.80	10	
G92-5155	51 - 55	2.01 - 2.17"	0.787"	6.60	5.90	10	
G92-5559	55 - 59	2.17 - 2.32"	0.787"	6.90	6.10	10	
G92-5963	59 - 63	2.32 - 2.48"	0.787"	7.10	6.40	10	
G92-6368	63 - 68	2.48 - 2.68"	0.787"	7.60	6.90	10	
G92-6873	68 - 73	2.68 - 2.87"	0.984"	9.50	8.60	10	
G92-7379	73 - 79	2.87 - 3.11"	0.984"	9.60	8.70	10	
G92-7985	79 - 85	3.11 - 3.35"	0.984"	10.10	9.00	10	
G92-8591	85 - 91	3.35 - 3.58"	0.984"	10.20	9.20	10	
G92-9197	91 - 97	3.58 - 3.82"	0.984"	10.40	9.40	10	
G92-97104	97 - 104	3.82 - 4.09"	0.984"	10.60	9.50	10	
G92-104112	104 - 112	4.09 - 4.41"	0.984"	11.10	10.10	10	
G92-112121	112 - 121	4.41 - 4.76"	0.984"	11.40	10.40	10	
G92-121130	121 - 130	4.76 - 5.12"	0.984"	11.80	10.60	10	
G92-130140	130 - 140	5.16 - 5.51"	1.024"	16.50	14.90	10	
G92-140150	140 - 150	5.51 - 5.91"	1.024"	17.10	15.40	10	
G92-150162	150 - 162	5.91 - 6.38"	1.024"	17.40	15.70	10	
G92-162174	162 - 174	6.38 - 6.85"	1.024"	17.80	16.10	10	
G92-174187	174 - 187	6.85 - 7.36"	1.024"	18.40	16.50	10	
G92-187200	187 - 200	7.36 - 7.87"	1.024"	18.90	17.00	10	
G92-200213	200 - 213	7.87 - 8.39"	1.024"	19.30	17.40	10	
G92-213226	213 - 226	8.39 - 8.90"	1.024"	19.70	17.70	10	
G92-226239	226 - 239	8.90 - 9.41"	1.024"	20.10	18.10	10	
G92-239252	239 - 252	9.41 - 9.92"	1.024"	20.70	18.60	10	
G92-252265	252 - 265	9.92 - 10.43"	1.024"	36.90	33.30	10	

Part Number	Range	Range	Band Width	PRICE EACH
-------------	-------	-------	------------	------------

G94... TYPE 304 ALL STAINLESS BOLT CLAMPS



G94-1719	17 - 19mm	0.67 - 0.75"	0.708"	\$10.20
G94-1921	19 - 21	0.75 - 0.83"	0.708"	10.30
G94-2123	21 - 23	0.83 - 0.91"	0.708"	10.50
G94-2325	23 - 25	0.91 - 0.98"	0.708"	10.60
G94-2527	25 - 27	0.98 - 1.06"	0.708"	10.80
G94-2729	27 - 29	1.06 - 1.14"	0.708"	11.00
G94-2931	29 - 31	1.14 - 1.22"	0.787"	11.30
G94-3134	31 - 34	1.22 - 1.34"	0.787"	11.40
G94-3437	34 - 37	1.34 - 1.46"	0.787"	11.80
G94-3740	37 - 40	1.46 - 1.57"	0.787"	11.90
G94-4043	40 - 43	1.57 - 1.69"	0.787"	12.10
G94-4347	43 - 47	1.69 - 1.85"	0.787"	12.90
G94-4751	47 - 51	1.85 - 2.01"	0.787"	13.00
G94-5155	51 - 55	2.01 - 2.17"	0.787"	13.40
G94-5559	55 - 59	2.17 - 2.32"	0.787"	13.60
G94-5963	59 - 63	2.32 - 2.48"	0.787"	13.70
G94-6368	63 - 68	2.48 - 2.68"	0.787"	14.10
G94-6873	68 - 73	2.68 - 2.87"	0.984"	19.20
G94-7379	73 - 79	2.87 - 3.11"	0.984"	19.80
G94-7985	79 - 85	3.11 - 3.35"	0.984"	20.20
G94-8591	85 - 91	3.35 - 3.58"	0.984"	20.70
G94-9197	91 - 97	3.58 - 3.82"	0.984"	21.20
G94-97104	97 - 104	3.82 - 4.09"	0.984"	21.60
G94-104112	104 - 112	4.09 - 4.41"	0.984"	22.20
G94-112121	112 - 121	4.41 - 4.76"	0.984"	22.60
G94-121130	121 - 130	4.76 - 5.12"	0.984"	22.90

PINCH CLAMPS

Our standard pinch clamps are zinc plated double-ear style. The double-ear clamps have a wider clamping range than single ear types. Please note that the dash size given is stamped on the clamp and refers to the closed and open size of the clamp. For example, a G2-1518 will fit over an 18mm diameter tube and will clamp down to 15mm if fully crimped.

Type 304 stainless clamps are available on special order under part number G2SS.

Part No.	Nom. Size	Closed Size	Open Size	PRICE EACH		Pkg Qty
				Loose	Std Pkg	

G2... DOUBLE-EAR PINCH CLAMPS



G2-0041	5/32"	0.122"	0.161"	\$0.66	\$0.49	100
G2-0045	11/64"	0.138"	0.177"	0.66	0.49	100
G2-0305	3/16"	0.118"	0.197"	0.66	0.49	100
G2-0507	1/4"	0.197"	0.276"	0.70	0.52	100
G2-0709	5/16"	0.276"	0.354"	0.70	0.52	100
G2-0811	3/8"	0.315"	0.433"	0.70	0.52	100
G2-1113	1/2"	0.433"	0.512"	0.71	0.53	100
G2-1315	9/16"	0.512"	0.591"	0.76	0.57	100
G2-1517	19/32"	0.551"	0.669"	0.76	0.57	100
G2-1518	5/8"	0.591"	0.708"	0.83	0.62	100
G2-1720	3/4"	0.669"	0.787"	0.83	0.62	100
G2-1922	13/16"	0.748"	0.866"	1.51	1.14	100
G2-2023	7/8"	0.787"	0.905"	0.88	0.73	100
G2-2225	15/16"	0.866"	0.984"	1.77	1.30	100
G2-2327	1"	0.905"	1.063"	1.14	0.83	100
G2-2528	1 1/16"	0.984"	1.102"	1.20	0.88	100
G2-2731	1 1/8"	1.063"	1.220"	1.25	0.94	100
G2-3134	1 5/16"	1.220"	1.339"	1.98	1.51	100
G2-3437	1 7/16"	1.339"	1.457"	1.40	1.04	100
G2-3740	1 1/2"	1.457"	1.575"	2.39	1.77	100
G2-4043	1 5/8"	1.575"	1.693"	3.00	2.30	100
G2-4346	1 3/4"	1.693"	1.811"	2.80	2.10	100

Single ear pinch clamps are an economical clamp for light duty low pressure applications. The band is 1/4" wide and 0.030" thick. Please note that the dash size given represents the size of the open clamp in millimeters. Other sizes are available on special order.

G1SS... ONE-EAR STAINLESS STEEL PINCH CLAMPS



G1SS-10.5	3/8"	0.350"	0.413"	0.49	0.32	100
G1SS-11.3	7/16"	0.382"	0.445"	0.49	0.32	100
G1SS-12.3	15/32"	0.409"	0.484"	0.49	0.32	100
G1SS-13.3	1/2"	0.449"	0.524"	0.49	0.33	100
G1SS-14.0	35/64"	0.469"	0.551"	0.49	0.33	100
G1SS-14.5	9/16"	0.496"	0.571"	0.49	0.33	100
G1SS-15.7	5/8"	0.543"	0.618"	0.49	0.34	100
G1SS-17.0	11/16"	0.595"	0.669"	0.49	0.34	100
G1SS-18.5	23/32"	0.618"	0.728"	0.49	0.35	100
G1SS-19.8	3/4"	0.669"	0.780"	0.50	0.36	100
G1SS-21.0	13/16"	0.717"	0.827"	0.50	0.37	100
G1SS-22.6	7/8"	0.780"	0.890"	0.51	0.38	100
G1SS-24.1	15/16"	0.823"	0.949"	0.52	0.40	100
G1SS-25.6	1"	0.882"	1.008"	0.53	0.41	100
G1SS-27.1	1 1/16"	0.945"	1.067"	0.54	0.42	100
G1SS-28.6	1 1/8"	1.004"	1.126"	0.54	0.42	100
G1SS-30.1	1 3/16"	1.063"	1.185"	0.68	0.44	100
G1SS-31.6	1 1/4"	1.122"	1.244"	0.68	0.44	100
G1SS-33.1	1 5/16"	1.181"	1.303"	0.68	0.45	100
G1SS-34.6	1 3/8"	1.240"	1.362"	0.68	0.47	100
G1SS-36.1	1 7/16"	1.299"	1.421"	0.68	0.48	100
G1SS-42.5	1 11/16"	1.551"	1.673"	0.68	0.52	100

G2-1098 and G2-1099 are both forged tools with insulated grip handles for general service, however the 1099 features side pincers as well as the standard front pincer for crimping in tight areas.

Part Number	Description	PRICE EACH
-------------	-------------	------------

PINCH CLAMP TOOLS

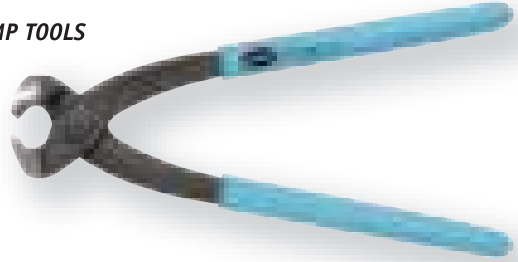

G2-1098	Standard Pinchers	\$35.90
---------	-------------------	---------

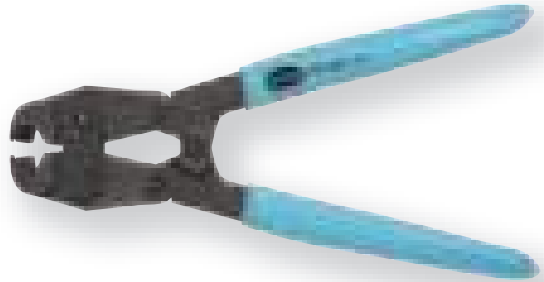

G2-1099	Side Jaw Pinchers	66.20
---------	-------------------	-------

PINCH CLAMP KITS



G2-SK1098



G2-SK1099

G2-SK1098	Service kit (2-ear clamps)	150.90
G2-SK1099	Service kit (2-ear clamps)	160.50

Service kits offer clamps over a size range of 5/16" to 1", and include either the 1098 or 1099 tool, as specified in the kit part number.

PUNCH CLAMPS

PUNCH CLAMP TOOLS

Part Number	Clamp I.D.	Band Width	PRICE Loose	EACH Std Pkg	Pkg Qty
-------------	------------	------------	-------------	--------------	---------

PC... PLATED CARBON STEEL PUNCH CLAMPS



PC-3	3/8"	3/8"	\$0.85	\$0.59	100
PC-311	1 1/4"	3/8"	1.00	0.64	100
PC-4	1"	5/8"	1.05	0.76	100
PC-5	1 1/4"	5/8"	1.10	0.80	100
PC-6	1 1/2"	5/8"	1.10	0.83	100
PC-7	1 3/4"	5/8"	1.22	0.91	100
PC-8	2"	5/8"	1.27	0.93	100
PC-9	2 1/4"	5/8"	1.40	0.99	100
PC-10	2 1/2"	5/8"	1.40	1.17	50
PC-11	2 3/4"	5/8"	1.50	1.19	50
PC-12	3"	5/8"	1.70	1.25	50
PC-14	3 1/2"	5/8"	1.70	1.25	50
PC-16	4"	5/8"	2.10	1.48	25
PC-18	4 1/2"	5/8"	2.10	1.64	25
PC-20	5"	5/8"	2.30	1.75	25
PC-24	6"	5/8"	2.70	1.91	25
PC-28	7"	5/8"	3.40	2.54	25
PC-32	8"	5/8"	3.70	2.76	25

PC-S... TYPE 201 STAINLESS STEEL PUNCH CLAMPS

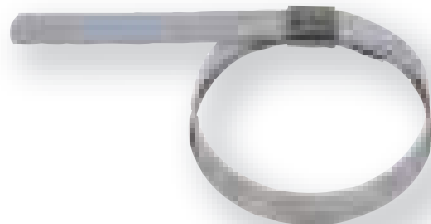

PC-3S	3/8"	3/8"	1.30	1.05	100
PC-311S	1 1/4"	3/8"	1.50	1.19	100
PC-4S	1"	5/8"	2.10	1.48	100
PC-5S	1 1/4"	5/8"	2.20	1.54	100
PC-6S	1 1/2"	5/8"	2.40	1.80	100
PC-7S	1 3/4"	5/8"	2.40	1.80	100
PC-8S	2"	5/8"	2.80	2.01	100
PC-9S	2 1/4"	5/8"	2.80	2.01	100
PC-10S	2 1/2"	5/8"	3.00	2.23	50
PC-11S	2 3/4"	5/8"	3.20	2.39	50
PC-12S	3"	5/8"	3.50	2.54	50
PC-14S	3 1/2"	5/8"	3.70	2.76	50
PC-16S	4"	5/8"	4.00	2.97	25
PC-18S	4 1/2"	5/8"	4.30	3.39	25
PC-20S	5"	5/8"	4.60	3.71	25
PC-24S	6"	5/8"	5.60	4.13	25
PC-28S	7"	5/8"	6.90	5.72	25
PC-32S	8"	5/8"	7.30	5.94	25

Part Number	Description	PRICE EACH
-------------	-------------	------------

PUNCH CLAMP TOOLS



P-38	Economy Tool	\$91.70
------	--------------	---------

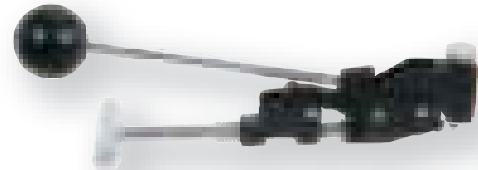

P-1	Service Tool	188.00
-----	--------------	--------

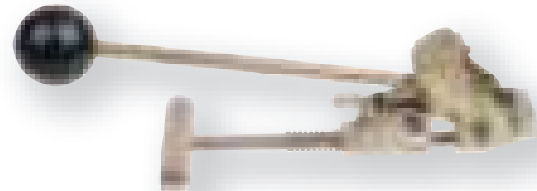

P-1000	Service Tool	208.30
--------	--------------	--------

OPEN END PUNCH CLAMPS

J-LOCK CLAMPS

Part Number	Clamp I.D.	Band Width	PRICE EACH		Pkg Qty
			Loose	Std Pkg	

PCO... OPEN END CARBON STEEL PUNCH CLAMPS

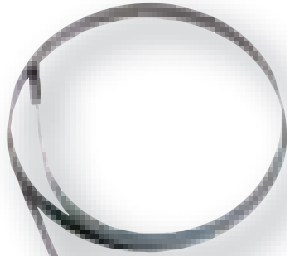

PCO-3	1 3/8"	3/8"	\$4.10	\$3.20	100
PCO-311	1 3/8"	3/8"	4.60	3.50	100
PCO-316	1 3/8"	3/8"	4.90	3.60	100
PCO-325	3 1/8"	3/8"	5.00	3.70	100
PCO-8	2"	5/8"	4.10	3.10	100
PCO-10	2 1/2"	5/8"	4.30	3.20	50
PCO-12	3"	5/8"	4.50	3.60	50
PCO-14	3 1/2"	5/8"	4.50	3.60	50
PCO-16	4"	5/8"	4.60	3.70	25
PCO-18	4 1/2"	5/8"	4.60	3.70	25
PCO-20	5"	5/8"	5.10	3.90	25
PCO-24	6"	5/8"	5.70	4.20	25
PCO-28	7"	5/8"	5.90	4.40	25
PCO-32	8"	5/8"	6.40	4.90	25
PCO-36	9"	5/8"	6.90	5.30	25
PCO-40	10"	5/8"	7.50	5.60	25
PCO-48	12"	5/8"	8.60	6.40	25

PCO-S... OPEN END STAINLESS STEEL PUNCH CLAMPS



PCO-311S	1 3/8"	3/8"	5.50	4.00	100
PCO-316S	2"	3/8"	5.70	4.20	100
PCO-325S	3 1/8"	3/8"	6.40	4.90	100
PCO-8S	2"	5/8"	5.90	4.40	100
PCO-10S	2 1/2"	5/8"	6.80	5.20	50
PCO-12S	3"	5/8"	7.30	5.50	50
PCO-14S	3 1/2"	5/8"	8.10	6.00	50
PCO-16S	4"	5/8"	8.40	6.30	25
PCO-18S	4 1/2"	5/8"	9.00	6.60	25
PCO-20S	5"	5/8"	9.60	7.20	25
PCO-24S	6"	5/8"	10.60	8.00	25
PCO-28S	7"	5/8"	12.50	9.40	25
PCO-32S	8"	5/8"	14.40	10.80	25
PCO-36S	9"	5/8"	16.10	12.10	25
PCO-40S	10"	5/8"	18.50	13.80	25
PCO-48S	12"	5/8"	21.40	16.00	25

Part Number	Clamp I.D.	Band Width	PRICE EACH		Pkg Qty
			Loose	Std Pkg	

J-LOCK CLAMPS



J201	1 3/16"	3/8"	\$2.20	\$1.60	100
J202	1 3/8"	3/8"	2.20	1.60	100
J203	1"	1/2"	2.50	2.00	100
J204	1 1/4"	1/2"	2.80	2.10	100
J205	1 1/2"	5/8"	3.50	2.50	100
J206	1 3/4"	5/8"	3.80	2.80	100
J207	2"	5/8"	4.10	3.20	100
J208	2 1/4"	5/8"	4.30	3.50	100
J209	2 1/2"	5/8"	4.80	3.70	100
J210	2 3/4"	3/4"	5.70	4.10	50
J211	3"	3/4"	6.10	4.60	50
J212	3 1/2"	3/4"	6.70	4.90	50
J213	4"	3/4"	7.30	5.70	25
J214	4 1/2"	3/4"	8.10	6.00	25
J215	5"	3/4"	8.60	6.40	25
J216	6"	3/4"	10.20	7.60	25
J245	2"	3/8"	2.50	2.00	25

Part Number	Description	PRICE EACH
-------------	-------------	------------

J-LOCK BANDING TOOL



J-001	J-Clamp adapter	204.80
-------	-----------------	--------

BAND & BUCKLE

Part Number	Band Width	Band Thickness	Cross Reference	Length (Feet)	PRICE Per ft
-------------	------------	----------------	-----------------	---------------	--------------

SC... TYPE 201 STAINLESS STEEL BAND

SC Band shown formed into double layer clamp with SB buckle attached ready for tightening.



SC-4	1/4"	0.020"	C-202	100	\$0.93
SC-6A	3/8"	0.025"	C-203	100	0.83
SC-8	1/2"	0.030"	C-204	100	1.07
SC-10	5/8"	0.030"	C-205	100	1.25
SC-12	3/4"	0.030"	C-206	100	1.66

Part Number	Band Width	Cross Reference	PRICE EACH Loose	Std Pkg	Pkg Qty
-------------	------------	-----------------	------------------	---------	---------

SB... TYPE 201 STAINLESS STEEL BUCKLES



SB-4	1/4"	C-252	\$0.70	\$0.53	100
SB-6	3/8"	C-253	0.75	0.56	100
SB-8	1/2"	C-254	0.95	0.76	100
SB-10	5/8"	C-255	1.15	0.95	100
SB-12	3/4"	C-256	1.50	1.18	100

Part Number	Description	PRICE EACH
-------------	-------------	------------

STANDARD BANDING TOOL



C-001 Standard tool (for 1/4"-3/4" wide band) \$213.20

FERRULE CRIMPERS

for Ferrule Crimping machinery refer to our

EQUIPMENT CATALOG

BRASS FERRULES

Our standard G3 ferrules are made from brass and, when installed using the crimpers shown in our Equipment Catalog, create a neat and secure means of attaching a variety of couplings.

Part Number	Ferrule I.D.	Ferrule Length	Hole Dia.	PRICE EACH Loose	Std Pkg	Pkg Qty
-------------	--------------	----------------	-----------	------------------	---------	---------

G3... BRASS HOSE FERRULE

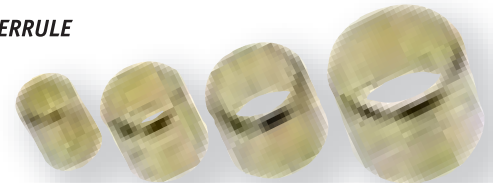

G3-375	0.375"	0.718"	0.265"	\$0.73	\$0.55	100
G3-400	0.400"	0.718"	0.265"	0.73	0.55	100
G3-425	0.425"	0.718"	0.265"	0.73	0.55	100
G3-450	0.450"	0.718"	0.328"	0.73	0.55	100
G3-475	0.475"	0.718"	0.328"	0.73	0.55	100
G3L-475	0.475"	1.000"	0.328"	0.73	0.55	100
G3-500	0.500"	0.718"	0.328"	0.73	0.55	100
G3-525	0.525"	0.718"	0.375"	0.85	0.60	100
G3-550	0.550"	0.968"	0.375"	0.85	0.60	100
G3-575	0.575"	0.968"	0.406"	1.00	0.73	100
G3-600	0.600"	0.968"	0.453"	1.00	0.73	100
G3-625	0.625"	0.968"	0.453"	1.00	0.73	100
G3-650	0.650"	0.968"	0.453"	1.00	0.73	100
G3-675	0.675"	0.968"	0.500"	1.00	0.73	100
G3-700	0.700"	0.968"	0.500"	1.20	0.85	100
G3-725	0.725"	0.968"	0.500"	1.20	0.85	100
G3-750	0.750"	0.968"	0.500"	1.20	0.85	100
G3-775	0.775"	0.968"	0.593"	1.20	0.85	100
G3-800	0.800"	0.968"	0.593"	1.45	0.95	100
G3-825	0.825"	0.968"	0.687"	1.45	0.95	100
G3-850	0.850"	0.968"	0.687"	1.45	0.95	100
G3-875	0.875"	0.968"	0.750"	1.45	0.95	100
G3-900	0.900"	0.968"	0.750"	1.50	1.06	100
G3-925	0.925"	0.968"	0.750"	1.50	1.06	100
G3-950	0.950"	0.968"	0.750"	1.50	1.06	100
G3-975	0.975"	0.968"	0.875"	1.90	1.38	100
G3-1000	1.000"	0.968"	0.875"	2.10	1.52	25
G3-1025	1.025"	0.968"	0.875"	2.90	2.10	25
G3-1050	1.050"	0.968"	0.875"	2.90	2.10	25
G3-1075	1.075"	0.968"	0.875"	2.90	2.10	25
G3-1100	1.100"	0.968"	0.875"	2.90	2.10	25
G3-1125	1.125"	0.968"	0.875"	3.00	2.10	25
G3-1150	1.150"	0.968"	0.875"	3.00	2.10	25
G3-1175	1.175"	0.968"	0.875"	3.00	2.10	25
G3-1200	1.200"	0.968"	1.000"	3.10	2.20	25
G3-1250	1.250"	0.968"	1.000"	3.10	2.20	25
G3-1350	1.350"	0.968"	1.125"	3.40	2.40	25
G3-1500	1.500"	0.968"	1.125"	3.50	2.50	25

G3A... ALUMINUM HOSE FERRULES

G3A-550	0.550"	0.718"	0.406"	0.51	0.39	100
G3A-650	0.650"	0.968"	0.453"	0.56	0.45	100
G3A-1100	1.100"	0.968"	0.875"	1.50	1.06	25
G3A-1150	1.150"	0.968"	0.875"	1.50	1.06	25
G3A-1437	1.437"	0.968"	1.047"	3.20	2.30	25

G3LS... LIGHT-DUTY PLATED STEEL FERRULES

These light-duty steel ferrules are commonly used with G15 Double-Lock, G45 Twist-Lock, G25 Universal fittings or G23S stems.

For 1/2" hoses

G3LS-091	0.910"	1.250"	0.625"	2.40	1.80	10
G3LS-094	0.940"	1.250"	0.625"	2.40	1.80	10

For 3/4" hoses

G3LS-119	1.188"	1.50"	0.875"	3.50	2.70	10
G3LS-125	1.250"	1.50"	0.875"	3.50	2.70	10



CRIMP SLEEVES

Steel hose ferrules are used with barbed hose fittings and are crimped on large-diameter hydraulic hose presses to create a strong, permanent and tamper-resistant hose connection. Sleeves will work with most barbed inserts, while G3F ferrules are designed to interlock with G64 and G33C hose stems. Sizes refer to the inside diameter of the ferrule before crimping. Maximum retention strength is achieved using G3F ferrules with G64 and G33C stems. Short sleeves are generally suitable for attaching G33 style combination nipples. Longer sleeves are preferred for G65 cam-locks.

CHOOSING A STEEL SLEEVE:

In general, sleeves should be to at least 1/4" shorter than the hose barb, and placed just ahead of the end barb on the fitting. Approximate barb lengths for popular fittings are given in the table below. For steam and for high pressure air service in larger sizes, G29C interlocking clamps should be used instead of steel sleeves.

Hose Size	Fitting style and barb length			
	G23S	G25	G33	G65
3/4"	2 3/8"	2 1/8"	1 3/8"	1 7/8"
1"	2 3/4"	2 3/4"	1 1/2"	2 1/4"
1 1/4"	3 1/2"		1 1/2"	2 1/4"
1 1/2"	3 1/2"		1 3/4"	2 1/2"
2"	4"		2 1/8"	2 3/4"
2 1/2"			2 3/4"	3 1/4"
3"			3"	4"
4"			3 7/8"	4 3/4"
5"			4 5/8"	4 3/4"
6"			5 1/8"	5 7/8"

Part Number	Nominal Hose Size	Sleeve I.D.	Sleeve Length	PRICE EACH
-------------	-------------------	-------------	---------------	------------

G3F... PLATED STEEL INTERLOCKING FERRULES



G3F-150	1"	1.50"	2.29"	\$8.00
G3F-163	1"	1.63"	2.29"	8.00
G3F-206	1 1/2"	2.06"	2.36"	9.00
G3F-213	1 1/2"	2.13"	2.36"	9.00
G3F-263	2"	2.63"	2.79"	10.60
G3F-275	2"	2.75"	2.79"	10.60
G3F-363	3"	3.63"	3.94"	14.50
G3F-375	3"	3.75"	3.94"	14.50
G3F-388	3"	3.88"	3.94"	18.30
G3F-463	4"	4.63"	4.19"	19.20
G3F-475	4"	4.75"	4.19"	19.20
G3F-481	4"	4.81"	4.19"	19.20
G3F-494	4"	4.94"	4.19"	19.20
G3F-663	6"	6.63"	5.67"	42.00
G3F-688	6"	6.88"	5.67"	42.00

G3SSF... STAINLESS STEEL INTERLOCKING FERRULES



G3SSF-206	1 1/2"	2.06"	2.36"	13.50
G3SSF-213	1 1/2"	2.13"	2.36"	13.50
G3SSF-263	2"	2.63"	2.79"	16.20
G3SSF-275	2"	2.75"	2.79"	16.20
G3SSF-363	3"	3.63"	3.94"	27.90
G3SSF-375	3"	3.75"	3.94"	27.90
G3SSF-463	4"	4.63"	4.19"	62.00
G3SSF-481	4"	4.81"	4.19"	62.00

G3S... PLATED STEEL HOSE SLEEVES

Long Sleeves

G3S-113	3/4"	1.13"	2.13"	\$5.60
G3S-138	3/4"	1.38"	2.13"	5.60
G3S-150	1"	1.50"	2.31"	5.80
G3S-163	1"	1.63"	2.31"	5.80
G3S-175	1"	1.75"	2.31"	5.80
G3S-213	1 1/2"	2.13"	2.38"	6.10
G3S-263	2"	2.63"	2.75"	6.10
G3S-275	2"	2.75"	2.75"	6.40
G3S-288	2"	2.88"	2.75"	6.40
G3S-313	2 1/2"	3.13"	3.13"	12.60
G3S-338	2 1/2"	3.38"	3.13"	12.60
G3S-363	3"	3.63"	3.94"	12.60
G3S-369	3"	3.61"	3.94"	12.60
G3S-375	3"	3.75"	3.94"	12.60
G3S-388	3"	3.88"	3.94"	12.60
G3S-400	3"	4.00"	3.94"	15.70
G3S-438	4"	4.38"	4.19"	15.70
G3S-463	4"	4.63"	4.19"	15.70
G3S-475	4"	4.75"	4.19"	15.70
G3S-483	4"	4.83"	4.19"	15.70
G3S-494	4"	4.94"	4.19"	15.70
G3S-650	6"	6.50"	5.67"	51.40
G3S-688	6"	6.88"	5.67"	51.40
G3S-713	6"	7.13"	5.67"	51.40
G3S-850	8"	8.50"	6.50"	78.10
G3S-900	9"	9.00"	6.50"	78.10
G3S-1075	10"	8.50"	6.50"	84.30
G3S-1125	10"	11.25"	6.50"	107.00



Short Sleeves

G3S-113S	3/4"	1.13"	1.19"	5.60
G3S-138S	1"	1.38"	1.19"	5.70
G3S-163S	1"	1.63"	1.19"	5.80
G3S-175S	1 1/4"	1.75"	1.50"	5.80
G3S-188S	1 1/4"	1.88"	1.50"	6.00
G3S-200S	1 1/2"	2.00"	1.50"	6.00
G3S-213S	2"	2.13"	2.00"	6.10
G3S-263S	2"	2.63"	2.00"	6.10
G3S-275S	2"	2.75"	2.00"	6.40
G3S-363S	3"	3.63"	2.63"	12.60
G3S-375S	3"	3.75"	2.63"	12.60
G3S-388S	3"	3.88"	2.63"	12.60
G3S-463S	4"	4.63"	3.44"	15.70
G3S-475S	4"	4.75"	3.44"	15.70
G3S-483S	4"	4.83"	3.44"	15.70

G3SS... TYPE 304 STAINLESS STEEL SLEEVES

Long Sleeves

G3SS-125	3/4"	1.25"	2.13"	10.60
G3SS-138	1"	1.38"	2.13"	10.60
G3SS-150	1"	1.50"	2.31"	10.60
G3SS-163	1"	1.63"	2.31"	10.60
G3SS-175	1"	1.75"	2.31"	11.90
G3SS-188	1 1/4"	1.88"	2.38"	12.40
G3SS-213	1 1/2"	2.13"	2.38"	13.10
G3SS-225	1 1/2"	2.25"	2.36"	13.10
G3SS-263	2"	2.63"	2.75"	14.10
G3SS-275	2"	2.75"	2.75"	14.10
G3SS-313	2 1/2"	3.13"	3.13"	26.00
G3SS-369	3"	3.69"	3.94"	28.10
G3SS-375	3"	3.75"	3.94"	28.10
G3SS-388	3"	3.88"	3.94"	28.10
G3SS-483	4"	4.83"	4.19"	45.50
G3SS-494	4"	4.94"	4.19"	45.50
G3SS-150S	1"	1.50"	1.25"	10.60



SUPPORT CLAMPS

G6 Support Clamps are galvanized steel dipped in vinyl to prevent chafing. They feature a 3/4" wide strap and 13/32" bolt hole.

G6N clamps have a 1/2" wide galvanized steel strap fitted with a rubber liner. The bolt hole measures 0.256".

Part Number	Inside Diameter	PRICE EACH		Pkg Qty
		Loose	Std Pkg	
G6... SUPPORT CLAMP				
G6-04	1/4"	\$2.10	\$1.70	10
G6-06	3/8"	1.70	1.30	10
G6-07	7/16"	0.85	0.64	10
G6-08	1/2"	0.90	0.67	10
G6-09	9/16"	0.95	0.74	10
G6-10	5/8"	0.95	0.74	10
G6-11	11/16"	0.95	0.80	10
G6-12	3/4"	1.05	0.85	10
G6-13	13/16"	1.20	0.95	10
G6-15	15/16"	1.40	1.06	10
G6-16	1"	1.45	1.11	10
G6-17	1 1/16"	1.50	1.20	10
G6-18	1 1/8"	1.50	1.20	10
G6-19	1 3/16"	1.50	1.20	10
G6-20	1 1/4"	1.50	1.20	10
G6-21	1 5/16"	1.60	1.30	10
G6-24	1 1/2"	1.70	1.40	10
G6-25	1 9/16"	1.90	1.50	10
G6-28	1 3/4"	2.00	1.60	10
G6-29	1 13/16"	7.00	5.60	10
G6-32	2"	2.20	1.80	10
G6-33	2 1/16"	7.10	5.70	10
G6-36	2 1/4"	2.50	2.00	10
G6-44	2 3/4"	3.10	2.40	10
G6-46	2 7/8"	3.20	2.50	10



Part Number	Inside Diameter	PRICE EACH		Pkg Qty
		Loose	Std Pkg	
G6N... RUBBER CUSHIONED SUPPORT CLAMPS				
G6N-04	1/4"	\$0.37	\$0.31	10
G6N-06	3/8"	0.41	0.35	10
G6N-08	1/2"	0.45	0.37	10
G6N-10	5/8"	0.51	0.39	10
G6N-12	3/4"	0.56	0.45	10
G6N-14	7/8"	0.59	0.48	10
G6N-16	1"	0.65	0.51	10
G6N-18	1 1/8"	0.90	0.74	10
G6N-20	1 1/4"	1.00	0.85	10
G6N-24	1 1/2"	1.20	0.95	10
G6N-28	1 3/4"	1.30	1.05	10
G6N-32	2"	1.80	1.50	10



G6T & G6HD... SUPPORT CLAMPS

Pipe and tube support clamps consist of a steel weld plate, two clamp halves of green polypropylene or black nylon, and a plated steel cover plate, bolted together with hex bolts. These parts conform to DIN 3015, parts 1 (standard duty single clamps), part 2 (standard duty twin clamps), and part 3 (heavy duty single clamps). The green heavy duty series are mostly used in industrial applications, while the black standard series are more popular on agricultural machinery.

A wide variety of special configurations and materials are available on special order. Aluminum clamp halves are available for high heat applications.

Mounting Guidelines

The recommended distance between supports in a piping system is given below and can be used to calculate the total clamps required. At bends, clamps should be installed on both sides as close as possible to the bend. The first clamp should be mounted directly adjacent to the threaded connection or coupling to protect the connection from vibration.

Temperature Range for Continuous Service:

Green Polypropylene -30°C to 90°C (-22°F to 194°F)
 Black Nylon (polyamide) -40°C to 140°C (-40°F to 284°F)
 Aluminum -55°C to 260°C (-67°F to 500°F)

G6HD... HEAVY-DUTY POLYPROPYLENE CLAMPS

Hole inches	Size mm	Part Number	Size Notes	PRICE EACH
0.25	6.4	G6HD-3-025		\$10.40
0.38	10.0	G6HD-3-038		10.40
0.50	12.7	G6HD-3-050		10.40
0.53	13.5	G6HD-3-053	Fits 1/4" steel pipe	10.40
0.63	16.0	G6HD-3-063		10.40
0.67	17.2	G6HD-3-067	Fits 3/8" steel pipe	10.40
0.75	19.0	G6HD-4-075		11.60
0.84	21.3	G6HD-4-084	Fits 1/2" steel pipe	11.60
0.88	22.0	G6HD-4-088		11.60
1.00	25.4	G6HD-4-100		11.60
1.06	26.9	G6HD-4-106	Fits 3/4" steel pipe	11.60
1.10	28.0	G6HD-4-110		11.60
1.25	32.0	G6HD-5-125		12.50
1.31	33.7	G6HD-5-131	Fits 1" steel pipe	12.50
1.50	38.0	G6HD-5-150		12.50
1.66	42.0	G6HD-5-166	Fits 1 1/4" steel pipe	12.50
1.90	48.3	G6HD-6-190	Fits 1 1/2" steel pipe	27.80
2.00	50.8	G6HD-6-200		27.80
2.13	54.0	G6HD-6-213		27.80
2.25	57.2	G6HD-6-225		27.80
2.38	60.5	G6HD-6-238	Fits 2" steel pipe	27.80
2.50	63.5	G6HD-6-250		27.80
2.75	70.0	G6HD-6-275		27.80
2.88	73.0	G6HD-7-288	Fits 2 1/2" steel pipe	65.50
3.00	76.0	G6HD-7-300		65.50
3.50	88.9	G6HD-7-350	Fits 3" steel pipe	65.50
4.50	114.0	G6HD-8-450	Fits 4" steel pipe	132.00
5.63	140.0	G6HD-9-563	Fits 5" steel pipe	231.00
6.63	168.0	G6HD-9-663	Fits 6" steel pipe	231.00

CLAMP SPACING

Clamp Hole Size	Support Spacing
0.23" - 0.50"	3.3 ft
0.51 - 0.86	4.0
0.87 - 1.25	5.0
1.25 - 1.50	6.5
1.51 - 2.25	8.8

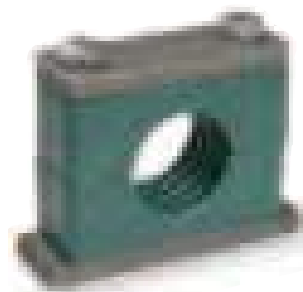

SUPPORT CLAMPS

G6S & G6T... STANDARD SERIES SINGLE AND TWIN CLAMPS

Hole Size		Single Nylon	PRICE EACH	Twin Nylon	PRICE EACH	Twin Polypropylene	PRICE EACH
inches	mm						
0.25	6.4	G6SN-1-025	\$3.30			G6T-1-025	\$4.70
0.38	10.0	G6SN-1-038	3.30			G6T-1-038	4.70
0.47	12.0	G6SN-1-047	3.30				
0.50	12.7	G6SN-2-050	3.90	G6TN-2-050	\$6.20	G6T-2-050	4.80
0.53	13.5	G6SN-2-053	3.90	G6TN-2-053	6.20	G6T-2-053	4.80
0.59	15.0	G6SN-2-059	3.90	G6TN-2-059	6.20		
0.63	16.0	G6SN-2-063	3.90	G6TN-2-063	6.20	G6T-2-063	4.80
0.67	17.2	G6SN-2-067	3.90	G6TN-2-067	6.20	G6T-2-067	4.80
0.71	18.0	G6SN-3-071	4.70	G6TN-3-071	8.10		
0.75	19.0	G6SN-3-075	4.70	G6TN-3-075	8.10	G6T-3-075	5.90
0.79	20.0	G6SN-3-079	4.70	G6TN-3-079	8.10		
0.84	21.3	G6SN-3-084	4.70	G6TN-3-084	8.10	G6T-3-084	5.90
0.98	25.0	G6SN-3-098	4.70	G6TN-3-098	8.10		
1.00	25.4	G6SN-3-100	4.70	G6TN-3-100	8.10	G6T-3-100	5.90
1.06	26.9	G6SN-4-106	5.70	G6TN-4-106	10.30	G6T-4-106	7.20
1.10	28.0	G6SN-4-110	5.70	G6TN-4-110	10.30	G6T-4-110	7.20
1.18	30.0	G6SN-4-118	5.70	G6TN-4-118	10.30		
1.25	32.0	G6SN-5-125	8.30	G6TN-5-125	11.60	G6T-5-125	9.00
1.31	33.7					G6T-5-131	9.00
1.50	38.0	G6SN-5-150	8.30	G6TN-5-150	11.60	G6T-5-150	9.00
1.66	42.0					G6T-5-166	9.00
1.75	44.5	G6SN-6-175	10.10				
1.90	48.3	G6SN-6-190	10.10				
2.00	50.8	G6SN-6-200	10.10				
2.25	57.2	G6SN-7-225	22.30				
2.75	70.0	G6SN-7-275	22.30				
2.88	73.0	G6SN-7-288	22.30				



BRASS & BRONZE VALVES

V200 series Cast Brass Valves are economical general service valves. Ball valves feature chrome plated balls with teflon seats, adjustable packing glands and blowout-proof stems. V205 gate valves have fully opening wedge discs and non-rising stems. V300 series are premium quality valves. In general they are heavier patterns than series V200.

Part No.	Pipe Size	IMPA Code	PRICE EACH
----------	-----------	-----------	------------

V201... STANDARD BRASS BALL VALVE

600 psi water, oil, gas. 150 psi steam. Sizes 1/2" to 2" are CSA approved under classes 3371-92, 3371-12, 3371-88, and 3371-08 for 1/2 psi natural gas.

V201-025	1/4"		\$6.60
V201-038	3/8"		6.60
V201-050	1/2"		7.10
V201-075	3/4"		9.70
V201-100	1"		17.70
V201-125	1 1/4"		23.90
V201-150	1 1/2"		34.90
V201-200	2"		48.80
V201-300	3"		159.80

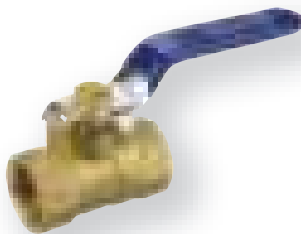

V201LM-025	1/4" mini-body & handle		6.30
------------	-------------------------	--	------

V202... FULL PORT BRASS BALL VALVE

600 psi water, oil, gas. 150 psi steam. Sizes 1/2" to 2" are CSA approved under classes 3371-92, 3371-12, 3371-88, and 3371-08 for 1/2 psi natural gas. Temperature Range -20°C (-4°F) to 110°C (230°F).

V202-013	1/8"		6.60
V202-025	1/4"		6.70
V202-038	3/8"	75-24-01	6.80
V202-050	1/2"	75-24-02	8.60
V202-075	3/4"	75-24-03	13.80
V202-100	1"	75-24-04	21.90
V202-125	1 1/4"	75-24-05	29.00
V202-150	1 1/2"	75-24-06	41.50
V202-200	2"	75-24-07	64.70
V202-250	2 1/2"		140.90
V202-300	3"		213.80
V202-400	4"		327.00



V202H... REPLACEMENT HANDLES

V202H-038	1/4" to 3/8"		1.10
V202H-050	1/2"		1.10
V202H-075	3/4"		1.70
V202H-100	1"		1.70
V202H-125	1 1/4"		1.90
V202H-200	1 1/2" to 2"		3.30
V202H-300	2 1/2" to 3"		4.90
V202H-400	4"		9.50

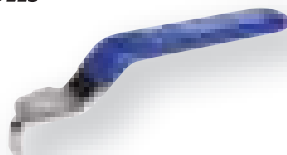

Part No.	Pipe Size	PRICE EACH
----------	-----------	------------

V202L... BRASS BALL VALVE WITH LOCKING HANDLE

600 psi water, oil, gas. 150 psi steam. Sizes 1/2" to 2" are CSA approved under classes 3371-92, 3371-12, 3371-88, and 3371-08 for 1/2 psi natural gas.

V202L-025	1/4"	\$7.40
V202L-038	3/8"	7.40
V202L-050	1/2"	9.60
V202L-075	3/4"	15.10
V202L-100	1"	23.70
V202L-125	1 1/4"	30.20
V202L-150	1 1/2"	43.40
V202L-200	2"	70.80

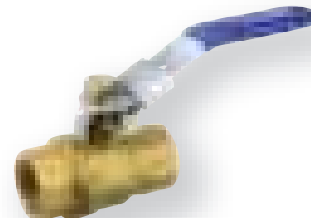

V202LB... BRASS BALL VALVE WITH LOCKING HANDLE & BLEED

600 psi air. V202LB valves have locking handles and a special port that vents the downstream side of the system when the valve is closed. This provides extra safety in air systems. Temperature Range -20°C (-4°F) to 110°C (230°F).

V202LB-025	1/4"	10.90
V202LB-038	3/8"	10.90
V202LB-050	1/2"	15.80
V202LB-075	3/4"	23.70
V202LB-100	1"	34.30
V202LB-125	1 1/4"	52.70
V202LB-150	1 1/2"	79.00
V202LB-200	2"	118.60



V302... PREMIUM FULL PORT BRASS BALL VALVE

600 psi water, oil, gas. 150 psi steam. Sizes 1/2" to 2" of V302, V302L & V302W are CSA approved for 1/2 psi natural gas, and meet CGA-CR91-002 (2-5 psi) and CGA-3.16 (125 psi) Temperature Range -40°C (-40°F) to 120°C (248°F).

V302-025	1/4"	14.90
V302-038	3/8"	14.40
V302-050	1/2"	14.90
V302-075	3/4"	21.70
V302-100	1"	30.80
V302-125	1 1/4"	50.80
V302-150	1 1/2"	71.60
V302-200	2"	107.40
V302-300	3"	481.20



V302W... PREMIUM BRASS BALL VALVE WITH WING HANDLE

V302W-025	1/4"	14.80
V302W-038	3/8"	14.80
V302W-050	1/2"	14.80
V302W-075	3/4"	21.50
V302W-100	1"	30.80
V302W-125	1 1/4"	52.30
V302W-150	1 1/2"	73.60
V302W-200	2"	107.40



BRASS & BRONZE VALVES

Part No. Pipe Size IMPA Code PRICE EACH

V203... THREE WAY BRASS BALL VALVE - VALUE PRICED

400 psi water, oil, gas. 150 psi steam. Flow can be directed from centre port to either side port.

		
V203-050	1/2"	\$15.90
V203-075	3/4"	23.60
V203-100	1"	38.70
V203-125	1 1/4"	53.50
V203-150	1 1/2"	86.90

V205... BRASS GATE VALVE

200 psi water, oil, gas. 125 psi steam. Temperature Range -20°C (-4°F) to 120°C (248°F).

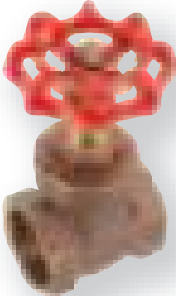
		
V205-025	1/4"	9.50
V205-038	3/8"	9.50
V205-050	1/2"	9.20
V205-075	3/4"	12.50
V205-100	1"	16.40
V205-125	1 1/4"	28.90
V205-150	1 1/2"	36.20
V205-200	2"	48.60
V205-250	2 1/2"	90.70
V205-300	3"	126.90
V205-400	4"	206.60

V207... BRASS SWING CHECK VALVE

200 psi water, oil, gas. 125 psi steam.

		
V207-038	3/8"	10.20
V207-050	1/2"	10.90
V207-075	3/4"	13.30
V207-100	1"	18.30
V207-125	1 1/4"	29.30
V207-150	1 1/2"	39.10
V207-200	2"	60.40
V207-300	3"	158.30

V208... SPRING LOADED CHECK VALVE

An economically priced check valve rated to 200 psi water, oil, gas with a 2 psi cracking pressure. Not for steam use. Temperature Range -20°C (-4°F) to 100°C (212°F).

		
V208-038	3/8"	11.20
V208-050	1/2"	13.10
V208-075	3/4"	16.70
V208-100	1"	23.90
V208-125	1 1/4"	34.70
V208-150	1 1/2"	44.40
V208-200	2"	80.10

Part No. Pipe Size IMPA Code PRICE EACH

V303... THREE WAY BRASS BALL VALVE

400 psi water, oil, gas. 150 psi steam. Flow can be directed from centre port to either side port.

		
V303-025	1/4"	\$98.40
V303-038	3/8"	38.20
V303-050	1/2"	38.20
V303-075	3/4"	57.10
V303-100	1"	79.40
V303-125	1 1/4"	106.80
V303-150	1 1/2"	143.60
V303-200	2"	234.40

V305... BRONZE GATE VALVE

200 psi water, oil, gas. 125 psi steam.

		
V305-025	1/4"	44.50
V305-038	3/8"	44.50
V305-050	1/2"	44.50
V305-075	3/4"	52.70
V305-100	1"	72.80
V305-125	1 1/4"	93.40
V305-150	1 1/2"	125.70
V305-200	2"	210.20
V305-250	2 1/2"	373.60
V305-300	3"	511.40
V305-400	4"	1373.80

V307... BRONZE SWING CHECK VALVE

200 psi water, oil, gas. 125 psi steam.

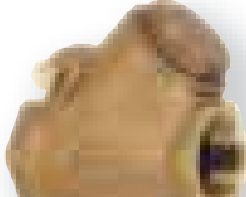
		
V307-038	3/8"	52.70
V307-050	1/2"	52.70
V307-075	3/4"	75.10
V307-100	1"	97.00
V307-125	1 1/4"	140.30
V307-150	1 1/2"	196.80
V307-200	2"	325.20
V307-250	2 1/2"	643.80
V307-300	3"	914.50

V308... SPRING LOADED CHECK VALVE

200 psi water, oil, gas. Not for steam use.

1 psi cracking pressure 1/4". 2 psi cracking pressure 3/8" to 2".

		
V308-025	1/4"	21.90
V308-038	3/8"	21.90
V308-050	1/2"	21.90
V308-075	3/4"	26.70
V308-100	1"	37.00
V308-125	1 1/4"	48.00
V308-150	1 1/2"	74.20
V308-200	2"	113.90

V306... BRONZE GLOBE VALVE

200 psi water, oil, gas. 125 psi steam.

			
V306-025	1/4"	75-18-01	60.70
V306-038	3/8"	75-18-02	60.50
V306-050	1/2"	75-18-03	72.80
V306-075	3/4"	75-18-04	99.80
V306-100	1"	75-18-05	150.60
V306-125	1 1/4"	75-18-06	208.00
V306-150	1 1/2"	75-18-07	325.10
V306-200	2"	75-18-08	447.80

STAINLESS & CARBON STEEL VALVES

V400 series valves feature blowout-proof stems and lockable handles. The bodies and balls are investment cast type 316 stainless steel, and the handles and stems are type 304. Seals are teflon, reinforced with glass fibre.

Part No. Pipe Size IMPA Code PRICE EACH

V401... STAINLESS STEEL BALL VALVE

1000 psi water, oil, gas up to 1".
800 psi water, oil, gas 1 1/4" - 2".
150 psi steam.

Temperature Range -28°C (-20°F) to 232°C (450°F)

V401-025	1/4"	75-18-01	\$18.20
V401-038	3/8"	75-18-02	19.20
V401-050	1/2"	75-18-03	21.40
V401-075	3/4"	75-18-04	28.70
V401-100	1"	75-18-05	39.10



V401-125	1 1/4"	75-18-06	60.60
V401-150	1 1/2"	75-18-07	67.30
V401-200	2"	75-18-08	102.80

V402... FULL PORT STAINLESS BALL VALVE

Two piece body with mounting pad.
2000 psi water, oil, gas to 1".
1500 psi 1 1/4" - 2".
150 psi steam.

Temperature Range -28°C (-20°F) to 232°C (450°F)

V402-025	1/4"	37.90
V402-038	3/8"	37.90
V402-050	1/2"	44.50
V402-075	3/4"	57.70
V402-100	1"	81.20



V402-125	1 1/4"	114.50
V402-150	1 1/2"	160.80
V402-200	2"	224.40

V412... 1000psi FULL PORT STAINLESS BALL VALVE

Two piece body.
1000 psi water, oil, gas to 2".
150 psi steam.

Temperature Range -28°C (-20°F) to 232°C (450°F)

V412-025	1/4"	22.60
V412-038	3/8"	22.60
V412-050	1/2"	23.90
V412-075	3/4"	34.60
V412-100	1"	46.70

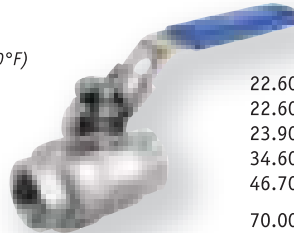

V412-125	1 1/4"	70.00
V412-150	1 1/2"	99.70
V412-200	2"	135.70
V412-300	3"	481.30

V432... THREE-PIECE FULL PORT STAINLESS BALL VALVE

1000 psi water, oil, gas. 150 psi steam.

V432-300	3"	743.00
----------	----	--------

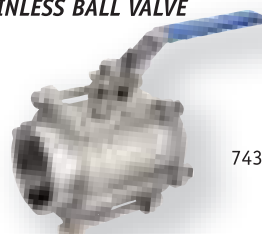

V601... CARBON STEEL BALL VALVE

2000 psi water, oil, gas. 3000 psi in 3/8" size. 150 psi steam
3/4" size is now plated for extra corrosion resistance. Reduced port, one piece carbon steel body. Type 304 Stainless Steel ball & trim. NACE trim.

Type 316 stainless steel blow-out proof stem. PTFE Teflon® seats & seals.
NPTF female threads.

Temperature Range -28°C (-20°F) to 232°C (450°F)

V601-025	1/4"	17.60
V601-038	3/8"	19.80
V601-050	1/2"	22.60
V601-075	3/4"	27.60
V601-100	1"	37.00

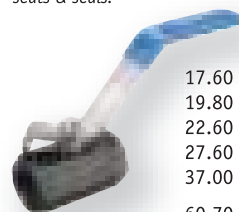

V601-125	1 1/4"	60.70
V601-150	1 1/2"	77.90
V601-200	2"	86.80
V601ORB-050	1/2" ORB (3/4-16)	22.60

Part No. Pipe Size Working Pressure PRICE EACH

V605... HIGH-PRESSURE STEEL BALL VALVE

Plated steel body
POM - poly-oxy-methylene seals (Delrin®)
Temperature range -20°C (-4°F) to 100°C (212°F)
NPTF female threads except where shown

V605-025	1/4"	7250 psi	\$23.30
V605-038	3/8"	7250 psi	25.70
V605-050	1/2"	7250 psi	29.80
V605-075	3/4"	5800 psi	49.30
V605-100	1"	5075 psi	65.70



V605-125	1 1/4"	5075 psi	124.40
V605-150	1 1/2"	5075 psi	180.10
V605-200	2"	5075 psi	245.30
V605SAE-100	1" ORB (1 5/16"-12)	5075 psi	119.60

V605H... REPLACEMENT HANDLES

V605H-025-050	1/4" to 1/2"	6.90
V605H-075-100	3/4" & 1"	9.80
V605H-125-200	1 1/4" to 2"	12.10

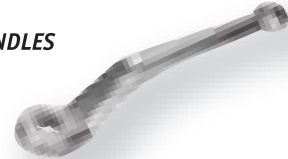

STAINLESS BUTTERFLY VALVES

Manufactured from Type 304 Stainless Steel and featuring silicone gaskets, Green Line carries both Three-Position and Multi-Position valves. With a working pressure up to 145 psi, our butterfly valves have a temperature range of -20°C (-4°F) to 135°C (275°F) and come complete with clamp style connections.

Part Number Fitting Size PRICE EACH

V53PH... THREE-POSITION PULL HANDLE VALVE

145 psi
Temperature Range -20°C (-4°F) to 135°C (275°F)

V53PH-150	1 1/2"	135.70
V53PH-200	2"	165.90



V53TH... MULTI-POSITION TRIGGER HANDLE VALVE

145 psi
Temperature Range -20°C (-4°F) to 135°C (275°F)

V53TH-150	1 1/2"	135.70
V53TH-200	2"	165.90

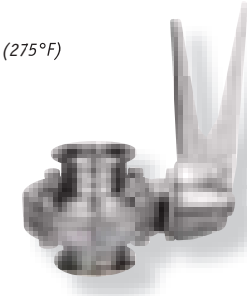

MINI VALVES

Carbon steel body with type 316 stainless steel stem.
Rated for -40°C to 260°C (-40°F to 500°F).

Part No.	Pipe Size	Pressure Rating	PRICE EACH
----------	-----------	-----------------	------------

V610... FEMALE NPT NEEDLE VALVE

V610 and V611 needle valves have a carbon steel body with a type 316 stainless steel stem and PTFE (Teflon®) packing. The regular valves are rated for use from -40°C to 260°C (-40°F to 500°F). The V611M mini valve has a soft seat and is rated from -40°C to 40°C (-40°F to 104°F).

V610-025	1/4"	10,000 psi	\$53.80
V610-038	3/8"	10,000 psi	62.20
V610-050	1/2"	10,000 psi	54.30



V611... MALE BY FEMALE NPT NEEDLE VALVE

V611-025	1/4"	10,000 psi	54.00
V611-050	1/2"	10,000 psi	62.00



V611M-025	1/4" mini body	6,000 psi	42.90
-----------	----------------	-----------	-------



Brass CSA approved valves for LP gas. Commonly used for gas torch applications. Also popular for air, water and other liquids where flow control is important. Knurled handle, stainless steel stem with o-ring packing. Temperature Range: -40°C (-40°F) to 54°C (130°F) for propane, 82°C (180°F) for air or water.

Part No.	Pipe Size	Thread size	PRICE EACH
----------	-----------	-------------	------------

FEMALE NPT NEEDLE VALVE

V18-0808-04-04	1/4"		27.20
----------------	------	--	-------



WELDING THREAD TO MALE NPT NEEDLE VALVE

Note: Flow direction is from left hand thread to NPT

V18-1640L-04-04	1/4"	9/16-18 LH	35.80
-----------------	------	------------	-------



V10 series pipe thread valves are rated to 500 psi at a maximum temperature of 180°F. The ball is plated brass with a teflon seat and buna-N (nitrile) rubber seals for resistance to petroleum products. Handles are plated metal. These valves are designed for flow in one direction only (marked by an arrow on the valve body).

V10-0808... FEMALE PIPE THREAD BALL VALVE

	Thread Size	
V10-0808-02	1/8"	\$20.60
V10-0808-04	1/4"	13.40
V10-0808-06	3/8"	20.90



V10-1608... FEMALE PIPE INLET/MALE PIPE OUTLET BALL VALVE

V10-1608-04	1/4"	\$12.80
V10-1608-06	3/8"	20.90



MINI VALVES

V12 ground plug valves are an economical shut-off valve for air or water lines. The spring maintains pressure on the ground surfaces to assist sealing. These valves are rated to 30 psi and are not suitable for petroleum based products.

Part No.	Pipe Size	Tube Size	PRICE EACH
----------	-----------	-----------	------------

V12-1600... GROUND PLUG DRAIN COCK

V12-1600-02	1/8"		\$15.10
V12-1600-04	1/4"		14.80
V12-1600-06	3/8"		18.80



V12-1600T... HEAVY DUTY GROUND PLUG DRAIN COCK

V12-1600T-04	1/4"		16.60
--------------	------	--	-------



V12-1608... FEMALE/MALE NPT GROUND PLUG VALVE

V12-1608-02	1/8"		16.10
V12-1608-04	1/4"		17.30
V12-1608-06	3/8"		27.10



V14-1600... BACK SEATING DRAIN COCK

150 psi maximum. Not intended for use with LP or natural gas

V14-1600-02	1/8"		2.40
V14-1600-04	1/4"		2.30
V14-1600-06	3/8"		7.70
V14-1600-08	1/2"		19.30



V14-1690... NEEDLE SEAT WITH HOSE BARB

150 psi maximum

V14-1690-04	1/4"	Hose Size 3/8"	14.90
-------------	------	-------------------	-------

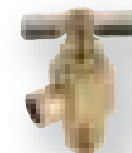

Part No.	Male Pipe	PRICE EACH
----------	-----------	------------

V16-1496... SAE FLARE TO MALE PIPE VALVE

200 psi maximum

Part No.	Pipe Size	Tube Size	PRICE EACH
V16-1496-08-10	1/2"	5/8"	\$42.20



V16-1690... HOSE BARB TO MALE PIPE VALVE

200 psi maximum

Part No.	Pipe Size	Hose Size	PRICE EACH
V16-1690-06-06	3/8"	3/8"	21.50
V16-1690-06-10	3/8"	5/8"	23.40
V16-1690-08-10	1/2"	5/8"	46.80
V16-1690-08-12	1/2"	3/4"	53.70



V16-1746... GARDEN HOSE TO MALE PIPE VALVE

150 psi maximum

V16-1746-08	1/2"		11.90
V16-1746-12	3/4"		14.50



V201PVC valves are suitable for cold water distribution in light industrial and agricultural applications. They have Teflon and EPDM rubber seals and are rated for 150 psi at 20°C (68°F).

Part No.	Pipe Size	PRICE EACH
----------	-----------	------------

V201PVC... PVC BALL VALVE

V201PVC-050	1/2"	\$2.90
V201PVC-075	3/4"	4.10
V201PVC-100	1"	6.00
V201PVC-125	1 1/4"	8.40
V201PVC-150	1 1/2"	11.80
V201PVC-200	2"	17.10
V201PVC-300	3"	61.00
V201PVC-400	4"	115.20



MISCELLANEOUS VALVES

Part No.	Pipe Size	PRICE EACH
----------	-----------	------------

V16-1600-12... DRUM FAUCET

Self-closing and lockable. Nylon seat. Suitable for petroleum products, solvents, alcohol and anti-freeze. Not suitable for chlorinated chemicals, detergents or drinking water.



V16-1600-12	3/4"	\$52.70
-------------	------	---------

PRV... SAFETY RELIEF VALVES

For air and steam applications
Factory set and tested
Pull ring for manual testing
Precision machined hard seat and stainless steel ball
ASME Certified – stamped UV and NB
Registered in Canada under CRN #0G3144.1C
Maximum temperature 204°C (400°F)
Other pressure ranges and styles available



Part No.	Male Pipe	Set Pressure	Height	Hex Size	PRICE EACH
PRV-025-065	1/4"	65 psi	3 1/8"	3/4"	50.10
PRV-025-120	1/4"	120	3 1/8"	3/4"	50.10
PRV-025-150	1/4"	150	3 1/8"	3/4"	50.10
PRV-025-180	1/4"	180	3 1/8"	3/4"	50.10
PRV-025-250	1/4"	250	3 1/8"	3/4"	50.10

Part No.	Female Thread	Male Thread	PRICE EACH
----------	---------------	-------------	------------

V825... HYDRANT GATE VALVE

Hydrant gate valves feature full flow design and non-rising stems. The body is anodized aluminum with bronze seats, stems, gland, gate and male nipple



V825-250	2 1/2" BAT	2 1/2" BAT	463.30
V825CSA-250	2 1/2" CSA	2 1/2" CSA	463.30

V803... HYDRANT 'Y' VALVE

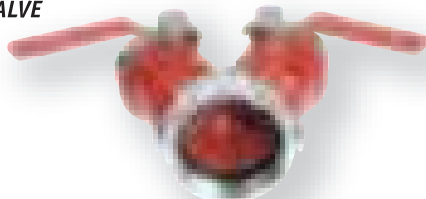

V803-250-150	2 1/2" BAT	1 1/2" NPSH	236.00
--------------	------------	-------------	--------

Part No.	Female Thread	Male Thread	PRICE EACH
----------	---------------	-------------	------------

V853... FORESTRY 'Y' VALVE

This valve is designed to turn easily while under pressure



V853-150	Instantaneous		\$251.20
----------	---------------	--	----------

V215L & V215P... LEVER & PISTON GATE VALVES

Lever and piston style gate valves are used on tanker trucks for fast manual release of fluids.



V215L



V215P

	Pipe Size	Type	
V215L-200	2"	Lever Gate	153.90
V215L-300	3"	Lever Gate	284.30
V215L-400	4"	Lever Gate	412.10
V215L-600	6"	Lever Gate	834.50
V215P-400	4"	Piston Gate	279.10
V215P-600	6"	Piston Gate	477.20
V215LH-200	2"	Replacement lever handle	29.20
V215LH	3" to 6"	Replacement lever handle	153.70

STEEL PIPE NIPPLES

Part No.	Pipe Size	Length	PRICE EACH	Part No.	Pipe Size	Length	PRICE EACH
G1616... STANDARD BLACK STEEL NIPPLES							
G1616-013XC	1/8"	Close	\$2.00	G1616-150XC	1 1/2"	Close	\$2.90
G1616-013X1.5	1/8"	1 1/2"	2.20	G1616-150X2	1 1/2"	2"	3.20
G1616-013X2	1/8"	2"	2.30	G1616-150X2.5	1 1/2"	2 1/2"	3.40
G1616-013X2.5	1/8"	2 1/2"	2.50	G1616-150X3	1 1/2"	3"	3.60
G1616-013X3	1/8"	3"	2.60	G1616-150X4	1 1/2"	4"	4.60
G1616-013X4	1/8"	4"	2.90	G1616-150X5	1 1/2"	5"	5.00
G1616-013X5	1/8"	5"	3.40	G1616-150X6	1 1/2"	6"	5.60
G1616-013X6	1/8"	6"	3.50	G1616-150X8	1 1/2"	8"	9.90
G1616-025XC	1/4"	Close	1.80	G1616-150X10	1 1/2"	10"	11.40
G1616-025X1.5	1/4"	1 1/2"	1.90	G1616-150X12	1 1/2"	12"	12.70
G1616-025X2	1/4"	2"	2.00	G1616-150X18	1 1/2"	18"	29.80
G1616-025X2.5	1/4"	2 1/2"	2.30	G1616-150X24	1 1/2"	24"	38.90
G1616-025X3	1/4"	3"	2.40	G1616-150X36	1 1/2"	36"	53.50
G1616-025X4	1/4"	4"	2.70	G1616-150X48	1 1/2"	48"	65.30
G1616-025X5	1/4"	5"	3.60	G1616-200XC	2"	Close	3.70
G1616-025X6	1/4"	6"	3.80	G1616-200X2.5	2"	2 1/2"	4.10
G1616-038XC	3/8"	Close	1.80	G1616-200X3	2"	3"	4.70
G1616-038X1.5	3/8"	1 1/2"	1.90	G1616-200X4	2"	4"	5.70
G1616-038X2	3/8"	2"	2.00	G1616-200X5	2"	5"	6.40
G1616-038X2.5	3/8"	2 1/2"	2.30	G1616-200X6	2"	6"	7.50
G1616-038X3	3/8"	3"	2.50	G1616-200X8	2"	8"	12.80
G1616-038X4	3/8"	4"	2.90	G1616-200X10	2"	10"	14.80
G1616-038X5	3/8"	5"	3.70	G1616-200X12	2"	12"	17.50
G1616-038X6	3/8"	6"	4.10	G1616-200X18	2"	18"	40.00
G1616-050XC	1/2"	Close	1.00	G1616-200X24	2"	24"	55.00
G1616-050X1.5	1/2"	1 1/2"	1.10	G1616-200X36	2"	36"	84.50
G1616-050X2	1/2"	2"	1.10	G1616-200X48	2"	48"	90.20
G1616-050X2.5	1/2"	2 1/2"	1.30	G1616-250XC	2 1/2"	Close	14.80
G1616-050X3	1/2"	3"	1.30	G1616-250X3	2 1/2"	3"	15.40
G1616-050X4	1/2"	4"	1.80	G1616-250X4	2 1/2"	4"	17.70
G1616-050X5	1/2"	5"	2.00	G1616-250X5	2 1/2"	5"	20.10
G1616-050X6	1/2"	6"	2.30	G1616-250X6	2 1/2"	6"	22.60
G1616-050X8	1/2"	8"	5.00	G1616-250X12	2 1/2"	12"	29.00
G1616-050X10	1/2"	10"	5.60	G1616-300XC	3"	Close	16.00
G1616-050X12	1/2"	12"	6.40	G1616-300X3	3"	3"	16.60
G1616-050X18	1/2"	18"	9.90	G1616-300X4	3"	4"	18.90
G1616-050X24	1/2"	24"	10.80	G1616-300X5	3"	5"	21.00
G1616-050X36	1/2"	36"	19.80	G1616-300X6	3"	6"	23.90
G1616-050X48	1/2"	48"	26.40	G1616-300X8	3"	8"	28.90
G1616-075XC	3/4"	Close	1.40	G1616-300X10	3"	10"	34.30
G1616-075X1.5	3/4"	1 1/2"	1.40	G1616-300X12	3"	12"	38.60
G1616-075X2	3/4"	2"	1.40	G1616-300X24	3"	24"	98.80
G1616-075X2.5	3/4"	2 1/2"	1.60	G1616-300X36	3"	36"	138.40
G1616-075X3	3/4"	3"	1.70	G1616-300X48	3"	48"	188.00
G1616-075X4	3/4"	4"	1.90	G1616-400XC	4"	Close	24.00
G1616-075X5	3/4"	5"	2.30	G1616-400X4	4"	4"	27.40
G1616-075X6	3/4"	6"	2.70	G1616-400X5	4"	5"	31.30
G1616-075X8	3/4"	8"	5.80	G1616-400X6	4"	6"	36.20
G1616-075X10	3/4"	10"	6.30	G1616-400X8	4"	8"	49.90
G1616-075X12	3/4"	12"	7.20	G1616-400X12	4"	12"	75.00
G1616-075X18	3/4"	18"	10.80	G1616-400X24	4"	24"	132.80
G1616-075X24	3/4"	24"	14.80	G1616-500XC	5"	Close	88.60
G1616-075X36	3/4"	36"	21.60	G1616-500X6	5"	6"	111.90
G1616-075X48	3/4"	48"	28.80	G1616-600XC	6"	Close	103.20
G1616-100XC	1"	Close	1.90	G1616-600X6	6"	6"	141.00
G1616-100X2	1"	2"	2.20				
G1616-100X2.5	1"	2 1/2"	2.30				
G1616-100X3	1"	3"	2.40				
G1616-100X4	1"	4"	2.80				
G1616-100X5	1"	5"	3.30				
G1616-100X6	1"	6"	3.60				
G1616-100X8	1"	8"	7.20				
G1616-100X10	1"	10"	8.50				
G1616-100X12	1"	12"	9.20				
G1616-100X18	1"	18"	16.90				
G1616-100X24	1"	24"	27.40				
G1616-100X36	1"	36"	29.90				
G1616-100X48	1"	48"	39.40				
G1616-125XC	1 1/4"	Close	2.50				
G1616-125X2	1 1/4"	2"	2.70				
G1616-125X2.5	1 1/4"	2 1/2"	2.70				
G1616-125X3	1 1/4"	3"	3.10				
G1616-125X4	1 1/4"	4"	3.50				
G1616-125X5	1 1/4"	5"	4.00				
G1616-125X6	1 1/4"	6"	4.70				
G1616-125X8	1 1/4"	8"	8.80				
G1616-125X10	1 1/4"	10"	10.10				
G1616-125X12	1 1/4"	12"	11.60				
G1616-125X18	1 1/4"	18"	21.80				
G1616-125X24	1 1/4"	24"	34.10				
G1616-125X36	1 1/4"	36"	45.50				
G1616-125X48	1 1/4"	48"	57.20				



ITEMS HIGHLIGHTED

Standard black steel pipe nipples are Schedule 40 welded parts with steel material according to ASTM A53 Type F CW. Longer pipe nipples are available on special order.



Iron & Steel Pipe Fittings

STEEL PIPE NIPPLES

Part No.	Pipe Size	Length	PRICE EACH
G1616G... STANDARD GALVANIZED STEEL NIPPLES			
G1616G-013XC	1/8"	Close	\$2.50
G1616G-013X1.5	1/8"	1 1/2"	2.60
G1616G-013X2	1/8"	2"	2.80
G1616G-013X2.5	1/8"	2 1/2"	3.30
G1616G-013X3	1/8"	3"	3.50
G1616G-013X4	1/8"	4"	4.00
G1616G-013X5	1/8"	5"	4.60
G1616G-013X6	1/8"	6"	5.00
G1616G-025XC	1/4"	Close	2.00
G1616G-025X1.5	1/4"	1 1/2"	2.20
G1616G-025X2	1/4"	2"	2.40
G1616G-025X2.5	1/4"	2 1/2"	2.60
G1616G-025X3	1/4"	3"	2.80
G1616G-025X4	1/4"	4"	3.50
G1616G-025X5	1/4"	5"	4.20
G1616G-025X6	1/4"	6"	4.90
G1616G-038XC	3/8"	Close	2.20
G1616G-038X1.5	3/8"	1 1/2"	2.30
G1616G-038X2	3/8"	2"	2.40
G1616G-038X2.5	3/8"	2 1/2"	2.70
G1616G-038X3	3/8"	3"	2.80
G1616G-038X4	3/8"	4"	3.60
G1616G-038X5	3/8"	5"	4.60
G1616G-038X6	3/8"	6"	5.10
G1616G-050XC	1/2"	Close	1.40
G1616G-050X1.5	1/2"	1 1/2"	1.40
G1616G-050X2	1/2"	2"	1.60
G1616G-050X2.5	1/2"	2 1/2"	1.70
G1616G-050X3	1/2"	3"	1.80
G1616G-050X4	1/2"	4"	2.30
G1616G-050X5	1/2"	5"	2.60
G1616G-050X6	1/2"	6"	2.90
G1616G-050X12	1/2"	12"	9.50
G1616G-050X18	1/2"	18"	11.40
G1616G-050X24	1/2"	24"	12.40
G1616G-050X36	1/2"	36"	19.80
G1616G-050X48	1/2"	48"	29.90
G1616G-075XC	3/4"	Close	1.70
G1616G-075X1.5	3/4"	1 1/2"	1.70
G1616G-075X2	3/4"	2"	1.80
G1616G-075X2.5	3/4"	2 1/2"	1.90
G1616G-075X3	3/4"	3"	2.20
G1616G-075X4	3/4"	4"	2.70
G1616G-075X5	3/4"	5"	3.10
G1616G-075X6	3/4"	6"	3.60
G1616G-075X12	3/4"	12"	11.80
G1616G-075X18	3/4"	18"	14.50
G1616G-075X24	3/4"	24"	16.40
G1616G-075X36	3/4"	36"	26.50
G1616G-075X48	3/4"	48"	40.00
G1616G-100XC	1"	Close	2.40
G1616G-100X2	1"	2"	2.60
G1616G-100X2.5	1"	2 1/2"	2.80
G1616G-100X3	1"	3"	3.10
G1616G-100X4	1"	4"	3.70
G1616G-100X5	1"	5"	4.40
G1616G-100X6	1"	6"	4.90
G1616G-100X12	1"	12"	14.80
G1616G-100X18	1"	18"	22.50
G1616G-100X24	1"	24"	30.80
G1616G-100X36	1"	36"	46.50
G1616G-100X48	1"	48"	59.80
G1616G-125XC	1 1/4"	Close	3.10
G1616G-125X2	1 1/4"	2"	3.40
G1616G-125X2.5	1 1/4"	2 1/2"	3.50
G1616G-125X3	1 1/4"	3"	3.80
G1616G-125X4	1 1/4"	4"	4.80
G1616G-125X5	1 1/4"	5"	5.50
G1616G-125X6	1 1/4"	6"	6.10
G1616G-125X12	1 1/4"	12"	18.60
G1616G-125X18	1 1/4"	18"	23.50
G1616G-125X24	1 1/4"	24"	42.90
G1616G-125X36	1 1/4"	36"	57.80
G1616G-125X48	1 1/4"	48"	76.50

Part No.	Pipe Size	Length	PRICE EACH
G1616G-150XC	1 1/2"	Close	\$ 3.70
G1616G-150X2	1 1/2"	2"	3.90
G1616G-150X2.5	1 1/2"	2 1/2"	4.40
G1616G-150X3	1 1/2"	3"	4.80
G1616G-150X4	1 1/2"	4"	5.70
G1616G-150X5	1 1/2"	5"	6.50
G1616G-150X6	1 1/2"	6"	7.30
G1616G-150X12	1 1/2"	12"	20.50
G1616G-150X18	1 1/2"	18"	42.80
G1616G-150X24	1 1/2"	24"	54.50
G1616G-150X36	1 1/2"	36"	72.20
G1616G-150X48	1 1/2"	48"	93.20
G1616G-200XC	2"	Close	4.90
G1616G-200X2.5	2"	2 1/2"	5.50
G1616G-200X3	2"	3"	5.90
G1616G-200X4	2"	4"	7.30
G1616G-200X5	2"	5"	8.40
G1616G-200X6	2"	6"	9.50
G1616G-200X12	2"	12"	26.10
G1616G-200X18	2"	18"	43.80
G1616G-200X24	2"	24"	59.00
G1616G-200X36	2"	36"	80.50
G1616G-200X48	2"	48"	114.40
G1616G-250XC	2 1/2"	Close	19.40
G1616G-250X3	2 1/2"	3"	20.10
G1616G-250X4	2 1/2"	4"	23.10
G1616G-250X5	2 1/2"	5"	26.70
G1616G-250X6	2 1/2"	6"	30.10
G1616G-250X12	2 1/2"	12"	38.00
G1616G-300XC	3"	Close	21.90
G1616G-300X3	3"	3"	22.60
G1616G-300X4	3"	4"	25.80
G1616G-300X5	3"	5"	29.30
G1616G-300X6	3"	6"	33.00
G1616G-300X12	3"	12"	52.40
G1616G-300X24	3"	24"	108.80
G1616G-300X36	3"	36"	145.40
G1616G-300X48	3"	48"	195.00
G1616G-400XC	4"	Close	32.70
G1616G-400X4	4"	4"	36.40
G1616G-400X5	4"	5"	44.60
G1616G-400X6	4"	6"	49.40
G1616G-400X12	4"	12"	82.80
G1616G-400X24	4"	24"	140.00
G1616G-500XC	5"	Close	118.30
G1616G-500X6	5"	6"	159.00
G1616G-600XC	6"	Close	147.40
G1616G-600X6	6"	6"	208.40

Iron & Steel Pipe Fittings

13



ITEMS HIGHLIGHTED

Standard galvanized steel pipe nipples are Schedule 40 welded parts with steel material according to ASTM A53 Type F CW.

Longer pipe nipples are available on special order.



STEEL PIPE NIPPLES

Part No.	Pipe Size	Length	PRICE EACH
----------	-----------	--------	------------

G1616S80... SCHEDULE 80 BLACK STEEL NIPPLES

Schedule 80 extra strong black steel nipples are welded parts with steel material according to ASTM A53 Type F CW. Longer pipe nipples are available on special order.

G1616S80-013XC	1/8"	Close	\$4.10
G1616S80-013X1.5	1/8"	1 1/2"	4.30
G1616S80-013X2	1/8"	2"	4.40
G1616S80-013X2.5	1/8"	2 1/2"	4.90
G1616S80-013X3	1/8"	3"	5.00
G1616S80-013X4	1/8"	4"	6.20
G1616S80-013X5	1/8"	5"	6.60
G1616S80-013X6	1/8"	6"	7.70
G1616S80-025XC	1/4"	Close	2.40
G1616S80-025X1.5	1/4"	1 1/2"	2.40
G1616S80-025X2	1/4"	2"	2.50
G1616S80-025X2.5	1/4"	2 1/2"	2.70
G1616S80-025X3	1/4"	3"	2.80
G1616S80-025X4	1/4"	4"	3.40
G1616S80-025X5	1/4"	5"	3.90
G1616S80-025X6	1/4"	6"	4.60
G1616S80-038XC	3/8"	Close	2.50
G1616S80-038X1.5	3/8"	1 1/2"	2.70
G1616S80-038X2	3/8"	2"	2.70
G1616S80-038X2.5	3/8"	2 1/2"	2.80
G1616S80-038X3	3/8"	3"	3.00
G1616S80-038X4	3/8"	4"	3.70
G1616S80-038X5	3/8"	5"	4.30
G1616S80-038X6	3/8"	6"	4.90
G1616S80-050XC	1/2"	Close	2.40
G1616S80-050X1.5	1/2"	1 1/2"	2.50
G1616S80-050X2	1/2"	2"	2.70
G1616S80-050X2.5	1/2"	2 1/2"	2.80
G1616S80-050X3	1/2"	3"	3.00
G1616S80-050X4	1/2"	4"	3.90
G1616S80-050X5	1/2"	5"	4.30
G1616S80-050X6	1/2"	6"	5.00
G1616S80-075XC	3/4"	Close	2.80
G1616S80-075X1.5	3/4"	1 1/2"	3.00
G1616S80-075X2	3/4"	2"	3.00
G1616S80-075X2.5	3/4"	2 1/2"	3.90
G1616S80-075X3	3/4"	3"	3.70
G1616S80-075X4	3/4"	4"	4.20
G1616S80-075X5	3/4"	5"	5.00
G1616S80-075X6	3/4"	6"	5.90
G1616S80-100XC	1"	Close	4.10
G1616S80-100X2	1"	2"	4.60
G1616S80-100X2.5	1"	2 1/2"	5.00
G1616S80-100X3	1"	3"	5.30
G1616S80-100X4	1"	4"	6.10
G1616S80-100X5	1"	5"	6.70
G1616S80-100X6	1"	6"	7.60
G1616S80-125XC	1 1/4"	Close	5.40
G1616S80-125X2	1 1/4"	2"	5.90
G1616S80-125X2.5	1 1/4"	2 1/2"	6.10
G1616S80-125X3	1 1/4"	3"	6.40
G1616S80-125X4	1 1/4"	4"	7.60
G1616S80-125X5	1 1/4"	5"	8.70
G1616S80-125X6	1 1/4"	6"	9.50
G1616S80-150XC	1 1/2"	Close	6.20
G1616S80-150X2	1 1/2"	2"	6.50
G1616S80-150X2.5	1 1/2"	2 1/2"	7.10
G1616S80-150X3	1 1/2"	3"	7.60
G1616S80-150X4	1 1/2"	4"	9.10
G1616S80-150X5	1 1/2"	5"	10.20
G1616S80-150X6	1 1/2"	6"	11.70
G1616S80-200XC	2"	Close	8.40
G1616S80-200X2.5	2"	2 1/2"	9.00
G1616S80-200X3	2"	3"	9.90
G1616S80-200X4	2"	4"	11.90
G1616S80-200X6	2"	6"	15.40
G1616S80-300XC	3"	Close	22.40
G1616S80-300X4	3"	4"	27.10



Part Number	Pipe Size	Pipe Size	Length	PRICE EACH
-------------	-----------	-----------	--------	------------

These jump size pipe nipples are made from seamless Schedule 40 pipe that has been swaged to a smaller diameter on one end. Stock swaged nipples are concentric. Other sizes, as well as eccentric (offset) fittings and heavier fittings (schedule 80, 160, and XXS) are available on special order.

G1616SW... SWAGED (REDUCING) PIPE NIPPLES

G1616SW-200-100	2"	1"	6 1/2"	\$44.10
G1616SW-200-150	2"	1 1/2"	6 1/2"	44.10
G1616SW-300-100	3"	1"	8"	61.00
G1616SW-300-200	3"	2"	8"	66.40
G1616SW-400-200	4"	2"	9"	63.00
G1616SW-400-300	4"	3"	9"	87.80



Part Number	Pipe Size	Length	PRICE EACH
-------------	-----------	--------	------------

Polycarbonate sight gauges allow users to see what is flowing through heat-treaters, separators, and storage tank drain lines at all times. This tough, shatter-resistant polycarbonate plastic has more than 30 times the impact resistance of safety glass, withstands prolonged exposure to ultraviolet rays, and can be used in temperatures ranging from -100°C (-165°F) to 75°C (167°F). Please consult us for fluid compatibility.

G1616PC... POLYCARBONATE SIGHT GAUGE NIPPLES

G1616PC-200X8	2"	8"	\$152.80
G1616PC-300X8	3"	8"	215.00
G1616PC-400X8	4"	8"	300.10

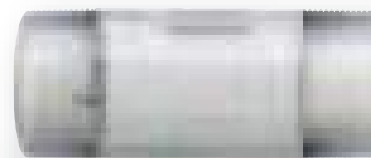

MALLEABLE IRON COUPLINGS

Part No.	Pipe Size	Pipe Size	Box Qty	PRICE EACH
G0808M... BLACK COUPLING				
G0808M-013-013	1/8"	1/8"	70	\$1.40
G0808M-025-025	1/4"	1/4"	40	1.30
G0808M-038-038	3/8"	3/8"	50	1.30
G0808M-050-050	1/2"	1/2"	40	0.90
G0808M-075-075	3/4"	3/4"	50	1.20
G0808M-100-100	1"	1"	25	1.90
G0808M-125-125	1 1/4"	1 1/4"	16	2.80
G0808M-150-150	1 1/2"	1 1/2"	18	3.50
G0808M-200-200	2"	2"	12	5.10
G0808M-250-250	2 1/2"	2 1/2"	8	10.50
G0808M-300-300	3"	3"	6	15.80
G0808M-400-400	4"	4"	6	25.80
G0808M-500-500	5"	5"	2	125.00
G0808M-600-600	6"	6"	2	187.20



G0808G... GALVANIZED COUPLING

G0808G-013-013	1/8"	1/8"	70	1.50
G0808G-025-025	1/4"	1/4"	40	1.50
G0808G-038-038	3/8"	3/8"	50	1.50
G0808G-050-050	1/2"	1/2"	40	1.10
G0808G-075-075	3/4"	3/4"	50	1.30
G0808G-100-100	1"	1"	25	2.30
G0808G-125-125	1 1/4"	1 1/4"	16	3.50
G0808G-150-150	1 1/2"	1 1/2"	18	4.00
G0808G-200-200	2"	2"	12	6.10
G0808G-250-250	2 1/2"	2 1/2"	8	12.00
G0808G-300-300	3"	3"	6	17.50
G0808G-400-400	4"	4"	6	41.00



G0808M... BLACK REDUCING COUPLING

	Largest End		
G0808M-025-*	1/4"		2.80
G0808M-038-*	3/8"		2.10
G0808M-050-*	1/2"		1.90
G0808M-075-*	3/4"		1.70
G0808M-100-*	1"		2.00
G0808M-125-*	1 1/4"		3.50
G0808M-150-*	1 1/2"		4.00
G0808M-200-*	2"		5.90
G0808M-250-*	2 1/2"		11.00
G0808M-300-*	3"		17.20
G0808M-400-*	4"		31.70
G0808M-500-*	5"		127.30
G0808M-600-*	6"		208.10



G0808G... GALVANIZED REDUCING COUPLING

G0808G-025-*	1/4"		2.30
G0808G-038-*	3/8"		2.30
G0808G-050-*	1/2"		1.80
G0808G-075-*	3/4"		1.90
G0808G-100-*	1"		2.50
G0808G-125-*	1 1/4"		3.70
G0808G-150-*	1 1/2"		4.20
G0808G-200-*	2"		6.50
G0808G-250-*	2 1/2"		12.40
G0808G-300-*	3"		18.80
G0808G-400-*	4"		34.90



* Specify small end pipe size when ordering.

Part No.	Pipe Size	Pipe Size	Box Qty	PRICE EACH
G0898M... BLACK ELBOW				
G0898M-013-013	1/8"	1/8"	50	\$1.70
G0898M-025-025	1/4"	1/4"	35	1.60
G0898M-038-038	3/8"	3/8"	45	1.60
G0898M-050-050	1/2"	1/2"	50	1.00
G0898M-075-075	3/4"	3/4"	35	1.50
G0898M-100-100	1"	1"	20	2.40
G0898M-125-125	1 1/4"	1 1/4"	20	3.60
G0898M-150-150	1 1/2"	1 1/2"	10	4.60
G0898M-200-200	2"	2"	8	7.20
G0898M-250-250	2 1/2"	2 1/2"	6	14.50
G0898M-300-300	3"	3"	14	22.20
G0898M-400-400	4"	4"	6	40.10
G0898M-500-500	5"	5"	6	135.30
G0898M-600-600	6"	6"	6	208.20



G0898G... GALVANIZED ELBOW

G0898G-013-013	1/8"	1/8"	50	2.00
G0898G-025-025	1/4"	1/4"	35	2.00
G0898G-038-038	3/8"	3/8"	45	2.00
G0898G-050-050	1/2"	1/2"	50	1.20
G0898G-075-075	3/4"	3/4"	35	1.60
G0898G-100-100	1"	1"	20	2.70
G0898G-125-125	1 1/4"	1 1/4"	20	4.30
G0898G-150-150	1 1/2"	1 1/2"	10	5.50
G0898G-200-200	2"	2"	8	8.10
G0898G-250-250	2 1/2"	2 1/2"	6	17.70
G0898G-300-300	3"	3"	14	25.50
G0898G-400-400	4"	4"	6	46.00



G0898M... BLACK REDUCING ELBOW

	Largest End		
G0898M-025-*	1/4"		2.90
G0898M-038-*	3/8"		2.90
G0898M-050-*	1/2"		1.60
G0898M-075-*	3/4"		2.10
G0898M-100-*	1"		2.90
G0898M-125-*	1 1/4"		4.90
G0898M-150-*	1 1/2"		6.00
G0898M-200-*	2"		9.20
G0898M-250-*	2 1/2"		19.70
G0898M-300-*	3"		32.40
G0898M-400-*	4"		65.20



G0898G... GALVANIZED REDUCING ELBOW

G0898G-025-*	1/4"		3.90
G0898G-038-*	3/8"		3.90
G0898G-050-*	1/2"		2.50
G0898G-075-*	3/4"		2.50
G0898G-100-*	1"		3.60
G0898G-125-*	1 1/4"		5.80
G0898G-150-*	1 1/2"		7.20
G0898G-200-*	2"		10.60
G0898G-250-*	2 1/2"		31.80
G0898G-300-*	3"		51.90



* Specify small end pipe size when ordering.

MALLEABLE IRON COUPLINGS

Part No.	Pipe Size	Pipe Size	Box Qty	PRICE EACH
G1698M... BLACK STREET ELBOW				
G1698M-013-013	1/8"	1/8"	60	\$1.90
G1698M-025-025	1/4"	1/4"	35	1.90
G1698M-038-038	3/8"	3/8"	40	1.90
G1698M-050-050	1/2"	1/2"	60	1.30
G1698M-075-075	3/4"	3/4"	35	1.90
G1698M-100-100	1"	1"	30	2.80
G1698M-125-125	1 1/4"	1 1/4"	25	5.00
G1698M-150-150	1 1/2"	1 1/2"	9	6.30
G1698M-200-200	2"	2"	10	9.00
G1698M-250-250	2 1/2"	2 1/2"	9	20.00
G1698M-300-300	3"	3"	14	31.30
G1698M-400-400	4"	4"	6	51.70



G1698G... GALVANIZED STREET ELBOW

G1698G-013-013	1/8"	1/8"	60	2.40
G1698G-025-025	1/4"	1/4"	35	2.40
G1698G-038-038	3/8"	3/8"	40	2.40
G1698G-050-050	1/2"	1/2"	60	1.40
G1698G-075-075	3/4"	3/4"	35	2.10
G1698G-100-100	1"	1"	30	3.50
G1698G-125-125	1 1/4"	1 1/4"	25	5.80
G1698G-150-150	1 1/2"	1 1/2"	9	7.10
G1698G-200-200	2"	2"	10	10.60
G1698G-250-250	2 1/2"	2 1/2"	9	38.20
G1698G-300-300	3"	3"	14	40.60
G1698G-400-400	4"	4"	6	56.90



G1648M... BLACK 45° STREET ELBOW

G1648M-013-013	1/8"	1/8"	35	2.70
G1648M-025-025	1/4"	1/4"	75	2.70
G1648M-038-038	3/8"	3/8"	75	2.70
G1648M-050-050	1/2"	1/2"	75	2.00
G1648M-075-075	3/4"	3/4"	40	3.20
G1648M-100-100	1"	1"	25	4.20
G1648M-125-125	1 1/4"	1 1/4"	10	7.00
G1648M-150-150	1 1/2"	1 1/2"	10	8.50
G1648M-200-200	2"	2"	12	13.60
G1648M-250-250	2 1/2"	2 1/2"	12	34.70
G1648M-300-300	3"	3"	9	50.20
G1648M-400-400	4"	4"	6	76.40



G1648G... GALVANIZED 45° STREET ELBOW

G1648G-050-050	1/2"	1/2"	75	2.40
G1648G-075-075	3/4"	3/4"	40	3.70
G1648G-100-100	1"	1"	25	4.90
G1648G-125-125	1 1/4"	1 1/4"	10	7.60
G1648G-150-150	1 1/2"	1 1/2"	10	9.10
G1648G-200-200	2"	2"	12	15.20



Part No.	Pipe Size	Pipe Size	Box Qty	PRICE EACH
G0848M... BLACK 45° ELBOW				
G0848M-013-013	1/8"	1/8"	50	\$2.00
G0848M-025-025	1/4"	1/4"	30	2.00
G0848M-038-038	3/8"	3/8"	50	2.00
G0848M-050-050	1/2"	1/2"	50	1.20
G0848M-075-075	3/4"	3/4"	40	1.60
G0848M-100-100	1"	1"	20	2.40
G0848M-125-125	1 1/4"	1 1/4"	20	4.10
G0848M-150-150	1 1/2"	1 1/2"	10	4.90
G0848M-200-200	2"	2"	12	7.40
G0848M-250-250	2 1/2"	2 1/2"	6	17.20
G0848M-300-300	3"	3"	8	26.20
G0848M-400-400	4"	4"	6	44.80
G0848M-500-500	5"	5"	6	201.60
G0848M-600-600	6"	6"	6	260.00



G0848G... GALVANIZED 45° ELBOW

G0848G-013-013	1/8"	1/8"	50	2.50
G0848G-025-025	1/4"	1/4"	30	2.50
G0848G-038-038	3/8"	3/8"	50	2.50
G0848G-050-050	1/2"	1/2"	50	1.90
G0848G-075-075	3/4"	3/4"	40	2.80
G0848G-100-100	1"	1"	20	3.50
G0848G-125-125	1 1/4"	1 1/4"	20	6.60
G0848G-150-150	1 1/2"	1 1/2"	10	7.00
G0848G-200-200	2"	2"	12	10.70
G0848G-250-250	2 1/2"	2 1/2"	6	28.30
G0848G-300-300	3"	3"	8	44.50
G0848G-400-400	4"	4"	6	73.20



G0816M... BLACK BUSHING

Part No.	Pipe Size	Pipe Size	Box Qty	PRICE EACH
G0816M... BLACK BUSHING				
G0816M-025-*	1/4"	1/4"	120	1.80
G0816M-038-*	3/8"	3/8"	75	1.80
G0816M-050-*	1/2"	1/2"	75	1.30
G0816M-075-*	3/4"	3/4"	50	1.30
G0816M-100-*	1"	1"	50	1.60
G0816M-125-*	1 1/4"	1 1/4"	30	2.70
G0816M-150-*	1 1/2"	1 1/2"	25	3.30
G0816M-200-*	2"	2"	20	4.20
G0816M-250-*	2 1/2"	2 1/2"	15	8.10
G0816M-300-*	3"	3"	12	10.50
G0816M-400-*	4"	4"	10	19.40
G0816M-500-*	5"	5"	5	62.90
G0816M-600-*	6"	6"	5	84.60
G0816M-800-*	8"	8"	1	296.60

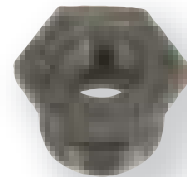

G0816G... GALVANIZED BUSHING

G0816G-025-*	1/4"	1/4"	120	2.10
G0816G-038-*	3/8"	3/8"	75	2.10
G0816G-050-*	1/2"	1/2"	75	2.00
G0816G-075-*	3/4"	3/4"	50	1.70
G0816G-100-*	1"	1"	50	2.10
G0816G-125-*	1 1/4"	1 1/4"	30	3.60
G0816G-150-*	1 1/2"	1 1/2"	25	4.80
G0816G-200-*	2"	2"	20	5.10
G0816G-250-*	2 1/2"	2 1/2"	15	8.00
G0816G-300-*	3"	3"	12	11.60
G0816G-400-*	4"	4"	5	21.40
G0816G-600-*	6"	6"	5	92.90



MALLEABLE IRON COUPLINGS

Part No.	Pipe Size	Pipe Size	Box Qty	PRICE EACH
G08T88M... BLACK TEE				
G08T88M-013-013	1/8"	1/8"	80	\$2.30
G08T88M-025-025	1/4"	1/4"	50	2.30
G08T88M-038-038	3/8"	3/8"	30	2.30
G08T88M-050-050	1/2"	1/2"	40	1.20
G08T88M-075-075	3/4"	3/4"	35	1.90
G08T88M-100-100	1"	1"	20	3.10
G08T88M-125-125	1 1/4"	1 1/4"	14	4.60
G08T88M-150-150	1 1/2"	1 1/2"	15	6.30
G08T88M-200-200	2"	2"	10	9.20
G08T88M-250-250	2 1/2"	2 1/2"	8	22.30
G08T88M-300-300	3"	3"	12	30.10
G08T88M-400-400	4"	4"	6	54.90
G08T88M-500-500	5"	5"	6	200.20
G08T88M-600-600	6"	6"	2	289.90



Part No.	Pipe Size	Pipe Size	Box Qty	PRICE EACH
G08X88M... BLACK CROSS				
G08X88M-025-025	1/4"	1/4"	30	\$6.60
G08X88M-038-038	3/8"	3/8"	25	5.60
G08X88M-050-050	1/2"	1/2"	30	4.50
G08X88M-075-075	3/4"	3/4"	20	6.50
G08X88M-100-100	1"	1"	15	8.50
G08X88M-125-125	1 1/4"	1 1/4"	20	12.40
G08X88M-150-150	1 1/2"	1 1/2"	18	16.20
G08X88M-200-200	2"	2"	10	23.00
G08X88M-250-250	2 1/2"	2 1/2"	6	46.70
G08X88M-300-300	3"	3"	4	65.80
G08X88M-400-400	4"	4"	2	123.70

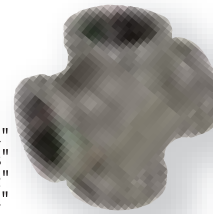

G08T88G... GALVANIZED TEE

G08T88G-013-013	1/8"	1/8"	80	2.50
G08T88G-025-025	1/4"	1/4"	50	2.50
G08T88G-038-038	3/8"	3/8"	30	2.50
G08T88G-050-050	1/2"	1/2"	40	1.50
G08T88G-075-075	3/4"	3/4"	35	2.10
G08T88G-100-100	1"	1"	20	3.90
G08T88G-125-125	1 1/4"	1 1/4"	14	5.80
G08T88G-150-150	1 1/2"	1 1/2"	15	7.30
G08T88G-200-200	2"	2"	10	10.80
G08T88G-250-250	2 1/2"	2 1/2"	8	42.80
G08T88G-300-300	3"	3"	12	48.00
G08T88G-400-400	4"	4"	6	92.80



G08X88G... GALVANIZED CROSS

G08X88G-025-025	1/4"	1/4"	30	6.80
G08X88G-038-038	3/8"	3/8"	25	5.80
G08X88G-050-050	1/2"	1/2"	30	5.50
G08X88G-075-075	3/4"	3/4"	20	7.60
G08X88G-100-100	1"	1"	15	10.50
G08X88G-125-125	1 1/4"	1 1/4"	20	14.60
G08X88G-150-150	1 1/2"	1 1/2"	18	18.40
G08X88G-200-200	2"	2"	10	27.20
G08X88G-250-250	2 1/2"	2 1/2"	6	49.90
G08X88G-300-300	3"	3"	4	71.10

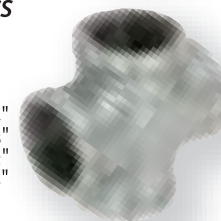

G08T88M... BLACK REDUCING TEE

	Largest End		
G08T88M-038-*	3/8"		3.70
G08T88M-050-*	1/2"		3.90
G08T88M-075-*	3/4"		4.60
G08T88M-100-*	1"		6.70
G08T88M-125-*	1 1/4"		10.70
G08T88M-150-*	1 1/2"		12.50
G08T88M-200-*	2"		19.30
G08T88M-250-*	2 1/2"		30.20
G08T88M-300-*	3"		43.70
G08T88M-400-*	4"		87.60



G0808MU... BLACK UNION

G0808MU-013-013	1/8"	1/8"	20	7.80
G0808MU-025-025	1/4"	1/4"	20	7.80
G0808MU-038-038	3/8"	3/8"	20	7.80
G0808MU-050-050	1/2"	1/2"	50	5.20
G0808MU-075-075	3/4"	3/4"	35	6.80
G0808MU-100-100	1"	1"	20	8.10
G0808MU-125-125	1 1/4"	1 1/4"	15	10.60
G0808MU-150-150	1 1/2"	1 1/2"	10	14.20
G0808MU-200-200	2"	2"	6	21.10
G0808MU-250-250	2 1/2"	2 1/2"	8	39.00
G0808MU-300-300	3"	3"	7	65.00
G0808MU-400-400	4"	4"	7	128.80



G0808GU... GALVANIZED UNION

G0808GU-013-013	1/8"	1/8"	20	8.90
G0808GU-025-025	1/4"	1/4"	20	8.90
G0808GU-038-038	3/8"	3/8"	20	8.90
G0808GU-050-050	1/2"	1/2"	50	5.90
G0808GU-075-075	3/4"	3/4"	35	7.40
G0808GU-100-100	1"	1"	20	8.80
G0808GU-125-125	1 1/4"	1 1/4"	15	11.70
G0808GU-150-150	1 1/2"	1 1/2"	10	15.40
G0808GU-200-200	2"	2"	6	23.20
G0808GU-250-250	2 1/2"	2 1/2"	8	42.80
G0808GU-300-300	3"	3"	7	71.20
G0808GU-400-400	4"	4"	7	142.70



G08T88G... GALVANIZED REDUCING TEE

G08T88G-038-*	3/8"		4.10
G08T88G-050-*	1/2"		4.50
G08T88G-075-*	3/4"		5.20
G08T88G-100-*	1"		8.00
G08T88G-125-*	1 1/4"		11.10
G08T88G-150-*	1 1/2"		15.50
G08T88G-200-*	2"		21.20
G08T88G-250-*	2 1/2"		42.30
G08T88G-300-*	3"		57.50
G08T88G-400-*	4"		120.60



* Specify small end pipe size when ordering.

MALLEABLE IRON FLANGES, CAPS & PLUGS

Part No.	Pipe Size	Box Qty	PRICE EACH
G0800M...BLACK CAP			
G0800M-013	1/8"	120	\$1.30
G0800M-025	1/4"	80	1.30
G0800M-038	3/8"	60	1.30
G0800M-050	1/2"	75	0.80
G0800M-075	3/4"	40	1.00
G0800M-100	1"	35	1.40
G0800M-125	1 1/4"	25	2.00
G0800M-150	1 1/2"	25	2.80
G0800M-200	2"	18	3.90
G0800M-250	2 1/2"	28	10.50
G0800M-300	3"	21	11.70
G0800M-400	4"	7	19.40
G0800M-500	5"	7	68.20
G0800M-600	6"	2	126.10



Part No.	Pipe Size	Box Qty	PRICE EACH
G1600M...BLACK PLUG			
G1600M-013	1/8"	300	\$1.20
G1600M-025	1/4"	150	1.20
G1600M-038	3/8"	100	1.20
G1600M-050	1/2"	50	0.90
G1600M-075	3/4"	30	1.10
G1600M-100	1"	20	1.20
G1600M-125	1 1/4"	40	1.80
G1600M-150	1 1/2"	30	2.30
G1600M-200	2"	20	3.20
G1600M-250	2 1/2"	16	9.20
G1600M-300	3"	16	9.10
G1600M-400	4"	8	16.30
G1600M-500	5"	4	68.70
G1600M-600	6"	4	78.80



G0800G...GALVANIZED CAP

G0800G-013	1/8"	120	1.60
G0800G-025	1/4"	80	1.60
G0800G-038	3/8"	60	1.60
G0800G-050	1/2"	75	1.00
G0800G-075	3/4"	40	1.20
G0800G-100	1"	35	1.60
G0800G-125	1 1/4"	25	2.30
G0800G-150	1 1/2"	25	3.50
G0800G-200	2"	18	4.80
G0800G-250	2 1/2"	28	10.00
G0800G-300	3"	21	14.30
G0800G-400	4"	7	22.80



G1600G...GALVANIZED PLUG

G1600G-013	1/8"	300	1.20
G1600G-025	1/4"	150	1.20
G1600G-038	3/8"	100	1.20
G1600G-050	1/2"	50	1.10
G1600G-075	3/4"	30	1.50
G1600G-100	1"	20	1.20
G1600G-125	1 1/4"	40	2.10
G1600G-150	1 1/2"	30	2.40
G1600G-200	2"	20	3.60
G1600G-250	2 1/2"	16	9.00
G1600G-300	3"	16	11.20
G1600G-400	4"	8	19.80



These forged weld-in flanges meet ASTM A105 and A181-60 specifications for welding in carbon steel piping applications.

G0819M... PIPE SCULLY FLANGE

Part No.	Pipe Size	Dimensions						PRICE EACH
		A	B	C	D	E	F	
G0819M-025	1/4"	1 1/2"	1"	1/2"	3/32"	2 1/32"	1/8"	\$2.70
G0819M-038	3/8"	1 5/8"	1 1/16"	1/2"	3/32"	3 1/32"	1/8"	3.20
G0819M-050	1/2"	1 13/16"	1 3/16"	19/32"	3/32"	1 5/32"	5/32"	3.30
G0819M-075	3/4"	2 1/16"	1 7/16"	2 1/32"	3/32"	1 11/32"	5/32"	3.80
G0819M-100	1"	2 5/16"	1 3/4"	3/4"	3/32"	1 23/32"	3/16"	4.60
G0819M-125	1 1/4"	2 11/16"	2 1/8"	3/4"	3/32"	1 15/16"	3/16"	5.40
G0819M-150	1 1/2"	3 1/32"	2 3/8"	3/4"	3/32"	2 5/16"	3/16"	7.10
G0819M-200	2"	3 1/2"	2 7/8"	13/16"	3/32"	2 11/16"	3/16"	9.20
G0819M-250	2 1/2"	4 1/16"	3 5/16"	1"	3/32"	3 3/16"	3/16"	14.50
G0819M-300	3"	4 5/8"	3 15/16"	1"	3/32"	3 11/16"	3/16"	20.00
G0819M-400	4"	5 13/16"	4 15/16"	1 1/8"	1/8"	4 3/4"	3/16"	25.10



G0819M

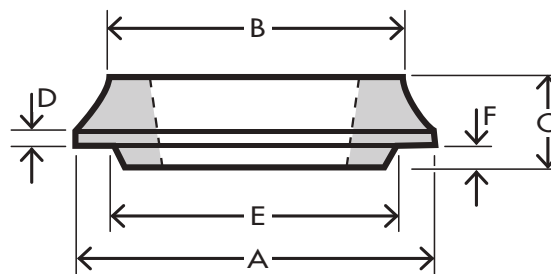

GROOVED PIPE COUPLINGS

Grooved pipe couplings are used to join pipes after grooves have been applied with a roll-grooving machine such as a RIDGID 918. When installing couplings always lubricate the gasket exterior and lip as well as the inside of the coupling to avoid pinching the gasket. Stretch the gasket over the pipe ends then place the coupling segments over the gasket and fasten the nuts and bolts. Tighten until there is metal to metal contact on the bolt pads, then tighten another 1/4 to 1/2 turn.

CRN numbers for grooved fittings are available on request. Maximum working pressures are based on a 3:1 safety factor, but may be affected by pipe wall thickness, material, and type of groove. Grooved couplings are suitable for vacuum service up to 10" Hg

Always lubricate the gasket exterior and lip as well as the inside of the coupling to avoid pinching the gasket. When tightening, once there is metal to metal contact on the bolt pads, tighten another 1/4 to 1/2 turn.

Other gasket materials are available.

For grooved pipe assembly lubricant see G38-GL Groove Lube in the accessories section at the end of this catalog.

Part No.	Pipe Size	Max. Working Pressure	PRICE EACH
----------	-----------	-----------------------	------------

G38V... HEAVY DUTY RIGID GROOVED COUPLING

For general piping applications where rigidity is required. Commonly referred to as a Style 07 coupling.

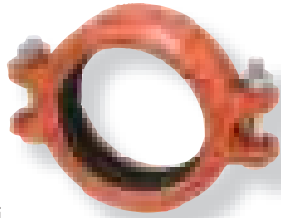

With EPDM gasket			
G38V-200	2"	750 psi	\$30.10
G38V-300	3"	750	39.90
G38V-400	4"	750	57.70
G38V-600	6"	700	99.00
G38V-800	8"	400	146.90
G38V-1000	10"	400	261.60

With Grade T Nitrile gasket			
G38VT-200	2"	750 psi	30.10
G38VT-300	3"	750	39.90
G38VT-400	4"	750	57.70
G38VT-600	6"	700	99.00

G38VF... HEAVY DUTY FLEXIBLE GROOVED COUPLING

For general piping applications where flexibility is required to deal with misalignment, distortion, thermal stress, and vibration. Also called Style 77 coupling.



With EPDM gasket			
G38VF-200	2"	1000 psi	39.30
G38VF-300	3"	1000	52.00
G38VF-400	4"	1000	75.90
G38VF-600	6"	1000	132.80

With Grade T Nitrile gasket			
G38VFT-200	2"	1000 psi	39.30
G38VFT-300	3"	1000	52.00
G38VFT-400	4"	1000	75.90
G38VFT-600	6"	1000	132.80

Part No.	Pipe Size	Max. Working Pressure	PRICE EACH
----------	-----------	-----------------------	------------

G38VQ... HINGED LEVER COUPLING

For moderate pressure piping systems where quick connection and disconnection are required. Use of the split pin prevents accidental opening. Also referred to as a Style 78 coupling.



With EPDM gasket			
G38VQ-200	2"	300 psi	\$97.80
G38VQ-300	3"	300	128.40
G38VQ-400	4"	300	165.70
G38VQ-600	6"	300	356.90

With Grade T Nitrile gasket			
G38VQT-200	2"	300 psi	97.80
G38VQT-300	3"	300	128.40
G38VQT-400	4"	300	165.70
G38VQT-600	6"	300	356.90

G38VX... EPDM GASKET FOR GROOVED COUPLINGS

Green stripe for water service
Temperature range: -34°C (-29°F) to 110°C (230°F)



G38VX-200	2"	12.80
G38VX-300	3"	15.10
G38VX-400	4"	22.00
G38VX-600	6"	30.10

G38VXT... NITRILE GASKET FOR GROOVED COUPLINGS

Orange stripe for petroleum service
Temperature range: -29°C (-20°F) to 82°C (180°F)
(water service maximum 65°C (150°F))



G38VXT-200	2"	12.80
G38VXT-300	3"	15.10
G38VXT-400	4"	22.00
G38VXT-600	6"	30.10

G0819V 150# ANSI FLANGE ADAPTER FOR GROOVED PIPE

Allows for direct connection to grooved pipe end. Cross referenced as a Style 741 adapter.



G0819V-200	2"	300 psi	90.80
G0819V-300	3"	300	148.50
G0819V-400	4"	300	194.00
G0819V-600	6"	300	254.20

GROOVED PIPE COUPLINGS

Part No.	Pipe Size	PRICE EACH
G0898V... GROOVED 90' ELBOW		
This short radius elbow is also called a No. 10 style elbow.		
G0898V-200-200	2"	\$22.60
G0898V-300-300	3"	40.30
G0898V-400-400	4"	59.50
G0898V-600-600	6"	167.20



Part No.	Pipe Size	PRICE EACH
G0898VL... GROOVED LONG RADIUS 90' ELBOW		
The long radius elbow is often referred to as a No. 100 style elbow		
G0898VL-200-200	2"	116.70
G0898VL-300-300	3"	116.70
G0898VL-400-400	4"	174.60
G0898VL-600-600	6"	510.30

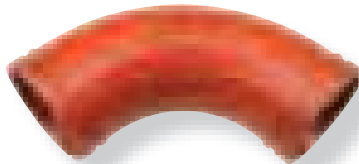

Part No.	Pipe Size	PRICE EACH
G0848V... GROOVED 45' ELBOW		
Short radius elbow also referred to as a No. 11 elbow		
G0848V-200-200	2"	20.10
G0848V-300-300	3"	37.00
G0848V-400-400	4"	56.60
G0848V-600-600	6"	151.40



Part No.	Pipe Size	PRICE EACH
G0848VL... GROOVED LONG RADIUS 45' ELBOW		
Also known as a No. 11 elbow		
G0848VL-200-200	2"	\$99.00
G0848VL-300-300	3"	99.00
G0848VL-400-400	4"	120.50
G0848VL-600-600	6"	365.00

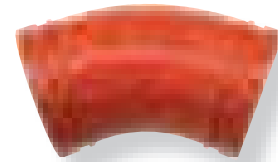

Part No.	Pipe Size	PRICE EACH
G08T88V... GROOVED TEE		
Also known as a No. 20 tee.		
G08T88V-200-200	2"	44.70
G08T88V-300-300	3"	94.00
G08T88V-400-400	4"	144.60
G08T88V-600-600	6"	386.40



Part No.	Pipe Size	Length	PRICE EACH
G1616V... SCHEDULE 40 NPT THREADED NIPPLE ADAPTER FOR GROOVED PIPE			
Also known as a No. 40 nipple.			
G1616V-200X4	2"	4"	9.40
G1616V-300X4	3"	4"	17.40
G1616V-400X6	4"	6"	34.20
G1616V-600X6	6"	6"	139.20
G1616V-800X6	8"	6"	143.50



STEEL FLANGES

Part No.	Flange Size	Flange Diameter	Pipe Size	Bolt Holes	PRICE EACH
G0819RF... RAISED FACE THREADED FLANGE					
G0819RF-200	2"	6"	2"	4	\$27.30
G0819RF-250	2½"	7"	2½"	4	40.90
G0819RF-300	3"	7½"	3"	4	51.10
G0819RF-400	4"	9"	4"	8	70.60
G0819RF-600	6"	11"	6"	8	99.40
G0819RF-800	8"	13½"	8"	8	145.80
G0819RF-1000	10"	16"	10"	12	212.50



Part No.	Pipe Size	PRICE EACH
G0019FG... FIBRE RING GASKET (Asbestos Free)		
G0019FG-200	2"	5.80
G0019FG-250	2½"	8.00
G0019FG-300	3"	9.50
G0019FG-400	4"	14.90
G0019FG-600	6"	21.40
G0019FG-800	8"	34.90

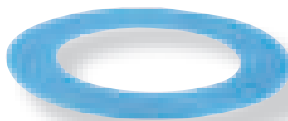

These flanges are made from forged steel and meet 150lb ANSI specifications. They feature NPT female pipe threads for easy attachment, but can be welded to the pipe for critical and leak-proof sealing. Welding is preferred, especially in larger sizes.

Part No.	Flange Size	Flange Diameter	PRICE EACH
G0019MG... METAL RING GASKET			
G0019MG-200	2"		\$4.60
G0019MG-250	2½"		6.70
G0019MG-300	3"		8.00
G0019MG-400	4"		10.60
G0019MG-600	6"		13.70
G0019MG-800	8"		31.00



Part No.	Pipe Size	PRICE EACH
G0019RG... RED RUBBER FLANGE GASKET		
G0019RG-300	3"	5.60
G0019RG-400	4"	8.60
G0019RG-600	6"	11.80
G0019RG-800	8"	18.10
G0019RG-1000	10"	25.00
G0019RG-1200	12"	29.90



HAMMER UNIONS

Hammer lock unions are available in a variety of working pressures, and with metal seals or with various elastomeric seals. Only the most commonly stocked hammer unions are listed here. Please contact us for other configurations and working pressures.



Part No.	Pipe Size	Length	Nut Radius	PRICE EACH
----------	-----------	--------	------------	------------

G0808HLU-F200

Figure 200 unions are recommended where working pressures* do not exceed 2000 psi. They are popular for low pressure rig piping. Nuts are ductile iron up to 2½" and steel in larger sizes. Bodies are forged steel to 4" and cast steel above 4".

G0808HLU-F200-100	1"	2 ¹⁹ / ₃₂ "	1 ¹⁵ / ₁₆ "	\$28.90
G0808HLU-F200-150	1½"	2 ²⁹ / ₃₂ "	2 ¹³ / ₃₂ "	77.50
G0808HLU-F200-200	2"	3 ¹ / ₄ "	2 ²⁹ / ₃₂ "	45.60
G0808HLU-F200-300	3"	4 ¹⁷ / ₃₂ "	4 ¹ / ₄ "	140.10
G0808HLU-F200-400	4"	4 ¹⁵ / ₁₆ "	5"	193.90

G0808HLU-F602

Figure 602 units are rated to 6000 psi and have a nitrile seal ring to improve the steel to steel seating. The nuts and bodies are all forged steel except 4" bodies are alloy steel.

G0808HLU-F602-100	1"	3 ¹⁷ / ₃₂ "	2 ⁵ / ₃₂ "	103.20
G0808HLU-F602-200	2"	5 ¹ / ₄ "	3 ³ / ₄ "	180.00
G0808HLU-F602-300	3"	6 ¹ / ₄ "	4 ¹ / ₂ "	424.10
G0808HLU-F602-400	4"	8 ¹ / ₄ "	5 ¹ / ₄ "	638.00

G0808HLU-F1502

Figure 1502 units are typically used in extreme applications such as Kelly Hose service

G0808HLU-F1502-200	2"	7"	4"	254.50
--------------------	----	----	----	--------

Replacement Parts

G0800HLU-F1502-200	Hammer nut	147.70
G0008HLU-F1502-200	Elastomeric seal	10.40

*All pressures are based on non-shock cold working pressure

The following chart may assist users in determining the correct hammer union for their application:

Figure Number	Pressure Rating (psi)				Colour		
	Standard Service		Sour Gas Service		Nut	Sub ends	Notes
	Cold Working	Test	Cold Working	Test			
100	1000	1500	N/A	N/A	black	yellow	Low pressure for manifold and general service
200	2000	3000	N/A	N/A	blue	gray	General purpose union
206	2000	3000	N/A	N/A	blue	gray	O-ring in seat for improved sealing and extended life
207	2000	3000	N/A	N/A	blue	gray	Blanking end with o-ring seal
400 up to 4"	4000	6000	4000	6000	black	red	4000 psi up to 4" mainly for manifold pumping and mud
400 above 4"	2500	3750	2500	3750	black	red	2500 psi in larger sizes
602	6000	6000	6000	9000	black	orange	Elastomer seal, for higher pressure manifold and mud
1002	10000	15000	7500	11250	red	blue	Elastomer seal, often used in fracturing & cementing
1003	10000	15000	7500	11250	black	green	Ball seat & o-ring allows up to 7½° misalignment
1502	15000	22500	10000	15000	blue	red	Elastomer seal for extreme pressure applications

WARNING

Never assemble any combination of male sub, wing nut, or segments that are not absolutely positively identified and assured to be all parts are identical in figure number, size, and pressure rating. Mismatched components will result in hazardous connections that can result in catastrophic failure. Hammer lock union components that cannot be positively identified must never be used.

Never expose standard service products to sour gas fluids.

FORGED ALUMINUM & STEEL FITTINGS

Note: Aluminum threads are particularly susceptible to galling (cold welding) during assembly. Galling occurs as a result of heat from friction and pressure during assembly. To minimize galling, use a Teflon based thread tape or sealant.

G0808A... ALUMINUM PIPE COUPLING

These pipe couplings are machined from 6061-T6 aluminum alloy.

Part No.	Pipe Size	PRICE EACH
G0808A-025-025	1/4"	\$8.10
G0808A-038-038	3/8"	8.40
G0808A-050-050	1/2"	8.80
G0808A-075-075	3/4"	9.30
G0808A-100-100	1"	10.80
G0808A-125-125	1 1/4"	14.40
G0808A-150-150	1 1/2"	20.70
G0808A-200-200	2"	29.20
G0808A-250-250	2 1/2"	53.10
G0808A-300-300	3"	61.00



FORGED STEEL FITTINGS

Forged carbon steel fittings conform to ASME B16.11 and ASTM A 105 for chemical and mechanical properties. Dimensions are to ASME B16.11 except 1/8" are larger than the ASME specification. For ratings purposes, 3000 psi threaded fittings compare to Schedule 160 pipe. The fittings shown here are all threaded 3000 psi series. Tees, elbows, and shapes are available on special order, as are socket weld fittings and 6000 psi patterns.

Merchant couplings are also known as wrought iron couplings, but are actually made from merchant steel according to ASTM A865. The female threads are NPS straight tapped to 2" and taper tapped in larger sizes. Standard couplings are black steel dipped in rust preventative up to 2" and phosphate coated in larger sizes. Deep chamfers allow for easy assembly. Half couplings are chamfered at one end only.

Part No.	Pipe Size	Outside Diameter	Length	PRICE EACH
G0808XH... 3000psi FORGED STEEL COUPLINGS				
G0808XH-013	1/8"	0.750"	1 1/4"	\$5.50
G0808XH-025	1/4"	0.750"	1 3/8"	5.50
G0808XH-038	3/8"	0.875"	1 1/2"	5.50
G0808XH-050	1/2"	1.125"	1 7/8"	5.20
G0808XH-075	3/4"	1.375"	2"	7.00
G0808XH-100	1"	1.750"	2 3/8"	10.50
G0808XH-125	1 1/4"	2.250"	2 1/2"	20.50
G0808XH-150	1 1/2"	2.500"	2 3/4"	28.70
G0808XH-200	2"	3.000"	3 1/4"	35.50
G0808XH-250	2 1/2"	3.625"	3 5/8"	65.00
G0808XH-300	3"	4.250"	4 1/4"	146.80



G0008XH... 3000 psi FORGED HALF-COUPLINGS

G0008XH-013	1/8"	0.750"	1 1/4"	3.60
G0008XH-025	1/4"	0.750"	1 3/8"	3.60
G0008XH-038	3/8"	0.875"	1 1/2"	3.60
G0008XH-050	1/2"	1.125"	1 7/8"	3.80
G0008XH-075	3/4"	1.375"	2"	4.20
G0008XH-100	1"	1.750"	2 3/8"	7.60
G0008XH-125	1 1/4"	2.250"	2 1/2"	13.10
G0008XH-150	1 1/2"	2.500"	19/16"	14.00
G0008XH-200	2"	3.000"	11 1/16"	19.20
G0008XH-300	3"	4.250"	2 1/8"	103.10
G0008XH-400	4"	5.500"	2 3/8"	170.20



Part No.	Pipe Size	Outside Diameter	Length	PRICE EACH
G0808MC... MERCHANT COUPLINGS				
G0808MC-013	1/8"	0.563"	13/16"	\$1.60
G0808MC-025	1/4"	0.719"	13/16"	1.60
G0808MC-038	3/8"	0.875"	1 3/8"	2.20
G0808MC-050	1/2"	1.063"	1 9/16"	2.40
G0808MC-075	3/4"	1.313"	1 5/8"	2.90
G0808MC-100	1"	1.576"	2"	4.30
G0808MC-125	1 1/4"	1.900"	2 1/16"	5.50
G0808MC-150	1 1/2"	2.200"	2 1/16"	5.60
G0808MC-200	2"	2.750"	2 1/8"	9.90
G0808MC-250	2 1/2"	3.250"	3 1/8"	24.80
G0808MC-300	3"	4.000"	3 1/4"	30.50
G0808MC-400	4"	5.000"	3 1/2"	45.20
G0808MC-600	6"	7.390"	4"	112.10



G0008MC... MERCHANT HALF-COUPLINGS

G0008MC-025	1/4"	0.719"	17/16"	1.00
G0008MC-038	3/8"	0.875"	17/16"	1.10
G0008MC-050	1/2"	1.063"	22/16"	1.40
G0008MC-075	3/4"	1.313"	3/4"	1.90
G0008MC-100	1"	1.576"	15/16"	3.40
G0008MC-125	1 1/4"	1.900"	31/32"	3.90
G0008MC-150	1 1/2"	2.200"	31/32"	4.80
G0008MC-200	2"	2.750"	1"	6.10
G0008MC-300	3"	4.000"	19/16"	15.30
G0008MC-400	4"	5.000"	11 1/16"	28.60

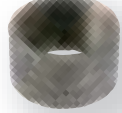

STAINLESS STEEL PIPE FITTINGS

Virtually all of the carbon steel pipe nipples and malleable iron pipe fittings that we sell are also available in Type 316 stainless steel. Some of our more popular items are listed here. These items are all 150lb class Type 316 stainless for Schedule 40 pipe.

Part No.	Pipe Size	Pipe Size	PRICE EACH
G0808SS... STAINLESS COUPLING			
G0808SS-013-013	1/8"	1/8"	\$2.20
G0808SS-025-025	1/4"	1/4"	2.50
G0808SS-038-038	3/8"	3/8"	2.90
G0808SS-050-050	1/2"	1/2"	4.00
G0808SS-075-075	3/4"	3/4"	5.20
G0808SS-100-100	1"	1"	9.30
G0808SS-125-125	1 1/4"	1 1/4"	13.60
G0808SS-150-150	1 1/2"	1 1/2"	14.70
G0808SS-200-200	2"	2"	23.30
G0808SS... STAINLESS REDUCING COUPLING			
G0808SS-038-025	3/8"	1/4"	3.30
G0808SS-050-025	1/2"	1/4"	3.70
G0808SS-050-038	1/2"	3/8"	3.70
G0808SS-075-050	3/4"	1/2"	4.60
G0808SS-100-075	1"	3/4"	7.50
G0808SS-125-100	1 1/4"	1"	10.50
G0808SS-150-100	1 1/2"	1"	16.20
G0808SS-150-125	1 1/2"	1 1/4"	16.20
G0808SS-200-100	2"	1"	20.40
G0808SS-200-150	2"	1 1/2"	19.30
G0808SS-300-200	3"	2"	59.80
G0808SSU... STAINLESS UNION			
G0808SSU-050-050	1/2"	1/2"	9.60
G0808SSU-075-075	3/4"	3/4"	11.60
G0808SSU-100-100	1"	1"	18.70
G0808SSU-125-125	1 1/4"	1 1/4"	27.10
G0808SSU-150-150	1 1/2"	1 1/2"	30.40
G0808SSU-200-200	2"	2"	43.40
G0816SS... STAINLESS BUSHING			
G0816SS-025-013	1/4"	1/8"	1.90
G0816SS-038-025	3/8"	1/4"	2.20
G0816SS-050-025	1/2"	1/4"	2.80
G0816SS-050-038	1/2"	3/8"	2.80
G0816SS-075-025	3/4"	1/4"	4.30
G0816SS-075-038	3/4"	3/8"	4.30
G0816SS-075-050	3/4"	1/2"	4.30
G0816SS-100-025	1"	1/4"	7.80
G0816SS-100-038	1"	3/8"	7.10
G0816SS-100-050	1"	1/2"	7.10
G0816SS-100-075	1"	3/4"	6.10
G0816SS-125-025	1 1/4"	1/4"	12.40
G0816SS-125-050	1 1/4"	1/2"	12.40
G0816SS-125-075	1 1/4"	3/4"	11.40
G0816SS-125-100	1 1/4"	1"	10.40
G0816SS-150-050			12.90
G0816SS-150-100	1 1/2"	1"	12.40
G0816SS-150-125	1 1/2"	1 1/4"	12.40
G0816SS-200-075	2"	3/4"	22.00
G0816SS-200-100	2"	1"	20.40
G0816SS-200-125	2"	1 1/4"	19.60
G0816SS-200-150	2"	1 1/2"	19.00
G0816SS-250-150	2 1/2"	1 1/2"	31.30
G0816SS-250-200	2 1/2"	2"	31.30
G0816SS-300-200	3"	2"	41.30
G0816SS-300-250	3"	2 1/2"	41.30
G0816SS-400-200	4"	2"	79.60
G0816SS-400-300	4"	3"	104.10
G0848SS... STAINLESS 45° ELBOW			
G0848SS-050-050	1/2"	1/2"	3.80
G0848SS-075-075	3/4"	3/4"	5.40
G0848SS-100-100	1"	1"	6.80
G0848SS-125-125	1 1/4"	1 1/4"	13.60
G0848SS-150-150	1 1/2"	1 1/2"	15.70
G0848SS-200-200	2"	2"	22.80

Part No.	Pipe Size	Pipe Size	PRICE EACH
G0898SS... STAINLESS 90° ELBOW			
G0898SS-013-013	1/8"	1/8"	\$2.30
G0898SS-025-025	1/4"	1/4"	2.50
G0898SS-038-038	3/8"	3/8"	3.50
G0898SS-050-050	1/2"	1/2"	4.00
G0898SS-075-075	3/4"	3/4"	6.80
G0898SS-100-100	1"	1"	10.00
G0898SS-125-125	1 1/4"	1 1/4"	15.30
G0898SS-150-150	1 1/2"	1 1/2"	18.80
G0898SS-200-200	2"	2"	29.90
G0898SS-300-300	3"	3"	77.20
G0898SS-400-400	4"	4"	130.20
G1698SS... STAINLESS 90° STREET ELBOW			
G1698SS-013-013	1/8"	1/8"	2.80
G1698SS-025-025	1/4"	1/4"	3.10
G1698SS-038-038	3/8"	3/8"	3.50
G1698SS-050-050	1/2"	1/2"	4.20
G1698SS-075-075	3/4"	3/4"	6.60
G1698SS-100-100	1"	1"	10.10
G1698SS-125-125	1 1/4"	1 1/4"	17.70
G1698SS-150-150	1 1/2"	1 1/2"	22.00
G1698SS-200-200	2"	2"	31.80
G1698SS-300-300	3"	3"	110.90
G08T88SS... STAINLESS TEE			
G08T88SS-013-013	1/8"	1/8"	2.90
G08T88SS-025-025	1/4"	1/4"	3.90
G08T88SS-038-038	3/8"	3/8"	4.80
G08T88SS-050-050	1/2"	1/2"	5.80
G08T88SS-075-075	3/4"	3/4"	8.00
G08T88SS-100-100	1"	1"	13.40
G08T88SS-125-125	1 1/4"	1 1/4"	22.50
G08T88SS-150-150	1 1/2"	1 1/2"	25.50
G08T88SS-200-200	2"	2"	38.40
G08T88SS-300-300	3"	3"	103.20
G08X88SS... STAINLESS CROSS			
G08X88SS-050-050	1/2"	1/2"	7.80
G08X88SS-075-075	3/4"	3/4"	17.50
G08X88SS-100-100	1"	1"	26.20
G0800SS... STAINLESS CAP			
G0800SS-013	1/8"		1.50
G0800SS-025	1/4"		1.60
G0800SS-038	3/8"		2.00
G0800SS-050	1/2"		2.20
G0800SS-075	3/4"		3.00
G0800SS-100	1"		4.90
G0800SS-125	1 1/4"		7.30
G0800SS-150	1 1/2"		9.80
G0800SS-200	2"		14.60
G1600SS... STAINLESS PLUG			
G1600SS-013	1/8"		1.50
G1600SS-025	1/4"		1.40
G1600SS-038	3/8"		1.50
G1600SS-050	1/2"		2.30
G1600SS-075	3/4"		3.30
G1600SS-100	1"		4.20
G1600SS-125	1 1/4"		6.30
G1600SS-150	1 1/2"		9.30
G1600SS-200	2"		12.20
G1600SS-300	3"		32.10
G1600HSS... STAINLESS HOLLOW HEX PLUG			
G1600HSS-013	1/8"		1.80
G1600HSS-025	1/4"		2.00
G1600HSS-038	3/8"		2.50
G1600HSS-050	1/2"		3.70
G1600HSS-075	3/4"		5.70
G1600HSS-100	1"		8.30
G1600HSS-125	1 1/4"		12.60
G0008SS... STAINLESS HALF COUPLING			
G0008SS-025	1/4"		1.50
G0008SS-038	3/8"		2.00
G0008SS-050	1/2"		2.40
G0008SS-075	3/4"		3.80
G0008SS-100	1"		6.40
G0008SS-200	2"		15.50

STAINLESS STEEL PIPE NIPPLES

These Type 316 stainless steel pipe nipples are Schedule 40. Other sizes and types are available on special order.



Part No.	Pipe Size	Length	PRICE EACH
G1616SS-013XC	1/8"	Close	\$1.80
G1616SS-025XC	1/4"	Close	1.70
G1616SS-025X1.5	1/4"	1 1/2"	2.20
G1616SS-025X2	1/4"	2"	2.50
G1616SS-025X3	1/4"	3"	3.60
G1616SS-025X4	1/4"	4"	4.30
G1616SS-025X6	1/4"	6"	5.50
G1616SS-038XC	3/8"	Close	1.90
G1616SS-038X1.5	3/8"	1 1/2"	2.30
G1616SS-038X2	3/8"	2"	2.70
G1616SS-038X3	3/8"	3"	3.70
G1616SS-038X6	3/8"	6"	5.70
G1616SS-050XC	1/2"	Close	2.50
G1616SS-050X1.5	1/2"	1 1/2"	3.10
G1616SS-050X2	1/2"	2"	3.60
G1616SS-050X3	1/2"	3"	5.00
G1616SS-050X4	1/2"	4"	6.30
G1616SS-050X6	1/2"	6"	8.70
G1616SS-075XC	3/4"	Close	3.70
G1616SS-075X2	3/4"	2"	4.00
G1616SS-075X3	3/4"	3"	5.70
G1616SS-075X4	3/4"	4"	7.40
G1616SS-075X6	3/4"	6"	12.10
G1616SS-075X8	3/4"	8"	17.30
G1616SS-100XC	1"	Close	4.60
G1616SS-100X2	1"	2"	5.70
G1616SS-100X3	1"	3"	7.50
G1616SS-100X4	1"	4"	8.90
G1616SS-100X5	1"	5"	13.30
G1616SS-100X6	1"	6"	15.50
G1616SS-100X8	1"	8"	26.00
G1616SS-125XC	1 1/4"	Close	7.00
G1616SS-125X2	1 1/4"	2"	7.20
G1616SS-125X3	1 1/4"	3"	10.10
G1616SS-125X6	1 1/4"	6"	18.00
G1616SS-125X8	1 1/4"	8"	23.30
G1616SS-150XC	1 1/2"	Close	8.70
G1616SS-150X2	1 1/2"	2"	9.60
G1616SS-150X3	1 1/2"	3"	12.90
G1616SS-150X4	1 1/2"	4"	21.30
G1616SS-150X5	1 1/2"	5"	22.50
G1616SS-150X6	1 1/2"	6"	24.20
G1616SS-200XC	2"	Close	12.40
G1616SS-200X2.5	2"	2 1/2"	14.90
G1616SS-200X3	2"	3"	17.30
G1616SS-200X4	2"	4"	19.50
G1616SS-200X5	2"	5"	27.00
G1616SS-200X6	2"	6"	32.00
G1616SS-200X8	2"	8"	34.90
G1616SS-250XC	2 1/2"	Close	28.30
G1616SS-300XC	3"	Close	40.40
G1616SS-300X4	3"	4"	46.10
G1616SS-400XC	4"	Close	58.30
G1616SS-400X6	4"	6"	95.10

STAINLESS STEEL HEX NIPPLES

Part No.	Pipe Size	PRICE EACH
G1616SSH... LOW PRESSURE STAINLESS STEEL HEX NIPPLE		
G1616SSH-013-013	1/8"	\$1.90
G1616SSH-025-025	1/4"	2.10
G1616SSH-038-038	3/8"	2.50
G1616SSH-050-050	1/2"	4.00
G1616SSH-075-075	3/4"	5.40
G1616SSH-100-100	1"	7.60
G1616SSH-125-125	1 1/4"	11.60
G1616SSH-150-150	1 1/2"	13.30
G1616SSH-200-200	2"	22.00



STAINLESS STEEL HOSE & SANITARY FITTINGS

For some marine fuel line and chemical applications, stainless hose fittings are preferred over brass or nylon. These parts are machined from Type 316 stainless.

Part No.	Pipe Size	Hose Size	PRICE EACH	Pkg
			Loose	Std Pkg Qty
G21SS... STAINLESS HOSE BARBS				
G21SS-013-025	1/8"	1/4"	\$3.40	1
G21SS-025-025	1/4"	1/4"	3.40	1
G21SS-025-038	1/4"	3/8"	3.40	1
G21SS-025-050	1/4"	1/2"	3.90	1
G21SS-038-025	3/8"	1/4"	4.00	1
G21SS-038-038	3/8"	3/8"	4.10	1
G21SS-038-050	3/8"	1/2"	4.80	1
G21SS-050-038	1/2"	3/8"	5.30	1
G21SS-050-050	1/2"	1/2"	5.80	1
G21SS-050-063	1/2"	5/8"	6.30	1
G21SS-075-075	3/4"	3/4"	7.80	1
G21SS-100-100	1"	1"	12.60	1



For Stainless Steel Combination Nipples and Stainless Steel Hose Menders, please see section 2 of this catalog.

We stock G65SS stainless steel cam-locks and various stainless steel valves listed in other sections of this catalog. The following section covers fittings used primarily in the food processing industry.

There are a dozen or more designs of sanitary fittings that have been developed independently around the world. The two most common in our market area seem to be:

-Clamp Fittings, also referred to as Tri-Clamp or Tri-Clover fittings which use a clamp and a gasket to join two identical flange fittings

-Threaded Bevel Seat Fittings, which use an Acme threaded nut to make a metal to metal joint between a plain connector and a threaded connector

Note: users may run into unusual sanitary fitting designs, especially on imported machinery. Listed here are the more common configurations of the two most common styles; Clamp Style and Threaded Bevel Seat Style.

Other types that appear less commonly include:

-I-Line Fittings, which use a clamp and a gasket to join a male face flange to a female face flange

-Q-Line Fittings, which use an I-Line clamp but to join two matching flanges

-John Perry Fittings, which are similar to Bevel Seat, but have a different sealing profile

-APC Fittings, which use standard clamps that can couple two matching flanges with a gasket but can couple a flange to a threaded male using an Acme nut

-DIN11851 Imperial Fittings, a European style bevel seat fitting with a rounded thread form

-RJT Ring Joint Type Fittings, another European style with a British Witworth thread

-SMS Couplings with a six slotted nut and rounded thread form.

Part Number	Fitting Size	Hose Size	Length	PRICE EACH
G53... CRIMP STYLE HOSE SHANK T316SS				
G53-100	1½"	1"		\$111.60
G53-150	1½"	1½"		111.60
G53-200	2"	2"		196.00
G53-300	3"	3"		452.00



G53L... LONG BREWERY HOSE SHANK T304SS				
G53L-100	1½"	1"	3.50"	51.20
G53L-150	1½"	1½"	5.00"	63.50
G53L-200	2"	2"	5.00"	74.30

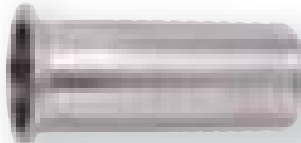

G53S... SHORT HOSE SHANK T304SS				
<i>For gravity or suction service only</i>				
G53S-100	1½"	1"	1.69"	42.10
G53S-150	1½"	1½"	1.69"	46.50
G53S-200	2"	2"	2.31"	66.50



G53C... SINGLE PIN CLAMP WITH CROSS HOLE NUT T304SS				
G53C-150	1" & 1½"			15.20
G53C-200	2"			17.20
G53C-250	2½"			21.50
G53C-300	3"			26.40
G53C-400	4"			34.30

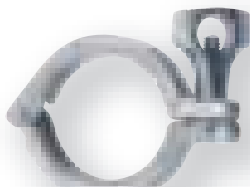

Part Number	Fitting Size	Hose Size	Length	PRICE EACH
-------------	--------------	-----------	--------	------------

G53CSN... SINGLE PIN CLAMP WITH SERRATED NUT T304SS

G53CSN-150	1" & 1½"			\$15.20
G53CSN-200	2"			18.20



G53CB... BOLT CLAMP FOR HIGH TEMPERATURES T304SS

G53CB-150	1" & 1½"			29.90
G53CB-200	2"			37.80

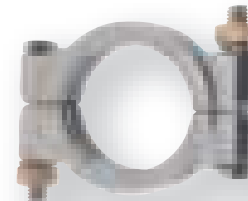

G53G... BLACK FOOD GRADE NITRILE (BUNA-N) GASKET

G53G-150	1" & 1½"			0.60
G53G-200	2"			0.70
G53G-250	2½"			1.00
G53G-300	3"			1.20
G53G-400	4"			1.80

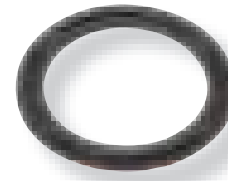

G53GS... WHITE SILICONE GASKET

G53GS-150	1" & 1½"			2.90
G53GS-200	2"			3.40
G53GS-300	3"			5.20

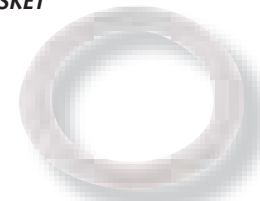

Note: For higher temperatures we prefer a silicone gasket. Teflon gaskets are also available, but do not seal as well and should not be used with bolt clamps.

STAINLESS STEEL HOSE & SANITARY FITTINGS

STAINLESS STEEL & SANITARY WELD ADAPTERS

Part Number	Fitting Size	Hose Size	Length	PRICE EACH
-------------	--------------	-----------	--------	------------

G54... BEVEL SEAT HOSE SHANK T316SS

G54-150	1½"	1½"		\$116.30
G54-200	2"	2"		202.40

G54N... ACME THREAD NUT T304SS

G54N-150	1½"		55.40
G54N-200	2"		73.20

G54G... BLACK FOOD GRADE NITRILE (BUNA-N) GASKET

G54G-150	1½"		1.20
G54G-200	2"		1.30

G54GT... WHITE TEFLON® GASKET

G54GT-150	1½"		3.10
G54GT-200	2"		3.40

Note: Gaskets are not required for G54 series fittings, but can be used to aid sealing.

G59... STAINLESS CRIMP FERRULES

Note: For use with G53 & G54 fittings only. Not for use with G53L or G53S.

		Hose O.D.		
		min.	max.	
G59-100-144	1"	1.14"	1.44"	72.60
G59-100-153	1"	1.50"	1.53"	72.60
G59-150-208	1½"	2.03"	2.08"	83.80
G59-150-214	1½"	2.09"	2.14"	83.80
G59-150-227	1½"	2.22"	2.27"	109.60
G59-200-252	2"	2.47"	2.52"	109.60
G59-200-258	2"	2.53"	2.58"	109.60
G59-200-264	2"	2.59"	2.64"	109.60
G59-200-270	2"	2.66"	2.70"	109.60
G59-300-373	3"	3.68"	3.73"	293.10



Our weld adapters are manufactured from Type 304 stainless steel and comply with 3-A Sanitary Standards allowing you to customize these fittings to meet your needs.



Part Number	Fitting Size	PRICE EACH
-------------	--------------	------------

G5090BW... 90° WELD ELBOW

G5090BW-100-100	1"		\$9.50
G5090BW-150-150	1½"		13.50
G5090BW-200-200	2"		17.30
G5090BW-300-300	3"		32.60

G50TBW... WELD TEE

G50TBW-100-100	1"		21.40
G50TBW-150-150	1½"		21.40
G50TBW-200-200	2"		27.90
G50TBW-300-300	3"		50.80

G53WL... LONG WELD CLAMP END

G53WL-100	1"		5.70
G53WL-150	1½"		6.70
G53WL-200	2"		7.30
G53WL-300	3"		12.40

G53WS... SHORT WELD CLAMP END

G53WS-100	1"		5.30
G53WS-150	1½"		5.10
G53WS-200	2"		5.30
G53WS-300	3"		9.50



STAINLESS STEEL & SANITARY CLAMP ADAPTERS

Our sanitary clamp adapters are manufactured from Type 304 stainless steel and comply with 3-A Sanitary Standards*. Primarily found in breweries, wineries, and dairies, the easy-to-clean nature of these fittings makes them perfect for any sanitary application.



*Note: G53M and G53F NPT Adapters do not comply with 3-A Sanitary Standards.

Part Number	Fitting Size	Reduced Size	PRICE EACH
-------------	--------------	--------------	------------

G5353C... CONCENTRIC REDUCER

			
G5353C-200-150	2"	1½"	\$46.20
G5353C-250-200	2½"	2"	56.20
G5353C-300-200	3"	2"	75.00

G5353E... ECCENTRIC REDUCER

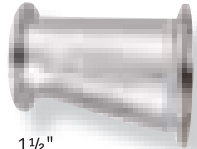
			
G5353E-200-150	2"	1½"	55.10
G5353E-250-200	2½"	2"	64.10
G5353E-300-200	3"	2"	85.30

G5343... 45° ELBOW

			
G5343-150-150	1½"		26.50
G5343-200-200	2"		34.50
G5343-300-300	3"		62.10

G5393... 90° ELBOW

			
G5393-150-150	1½"		26.50
G5393-200-200	2"		35.80
G5393-300-300	3"		57.20

G53F... FEMALE NPT ADAPTER

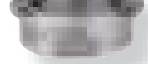
			
		Pipe Size	
G53F-150-075	1½"	¾"	60.10
G53F-150-100	1½"	1"	84.90
G53F-150-150	1½"	1½"	51.60
G53F-200-100	2"	1"	62.80
G53F-200-150	2"	1½"	61.90
G53F-200-200	2"	2"	58.60

Part Number	Fitting Size	Pipe Size	PRICE EACH
-------------	--------------	-----------	------------

G53M... MALE NPT ADAPTER

			
G53M-150-075	1½"	¾"	\$81.10
G53M-150-100	1½"	1"	56.00
G53M-150-150	1½"	1½"	48.00
G53M-200-100	2"	1"	102.10
G53M-200-150	2"	1½"	64.40
G53M-200-200	2"	2"	64.00

G53T... TEE

			
G53T-150-150	1½"		49.60
G53T-200-200	2"		55.40
G53T-300-300	3"		103.80

G53X... CROSS

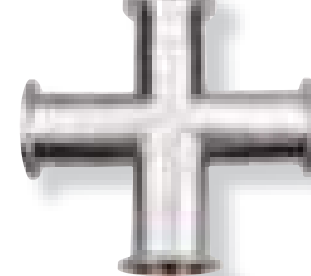
			
G53X-150	1½"		123.20
G53X-200	2"		147.90

G53CAP... CAP

			
G53CAP-150	1½"		4.20
G53CAP-200	2"		5.40
G53CAP-300	3"		11.10



SANDBLAST COUPLINGS

Sandblast couplings fit snugly over the cover of G722 sandblast hose and are fastened with screws into the hose carcass. The over-the-cover design allows unimpeded flow of the sand or glass beads, and minimizes coupling wear. Nozzle holders are threaded to accept sand nozzles, and female NPT adapters allow attachment to the machine. Couplings are aluminum or brass and come complete with natural rubber gaskets and screws.

Part Number	Hose I.D.	Hose O.D.	PRICE EACH	Pkg Qty
-------------	-----------	-----------	------------	---------

G72... NOZZLE HOLDER



G72-075	3/4"	1.50"	\$7.40	1
G72-100	1"	1.88"	8.30	1
G72-125	1 1/4"	2.16"	10.80	1
G72-150	1 1/2"	2.38"	16.60	1

G72B... BRASS NOZZLE HOLDER



G72B-075	3/4"	1.50"	17.60	1
G72B-100	1"	1.88"	24.00	1
G72B-125	1 1/4"	2.16"	31.10	1
G72B-150	1 1/2"	2.38"	54.50	1

G72M... MALE NPT HOSE END

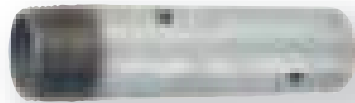

G72M-050	1/2"	1.06"	7.10	1
----------	------	-------	------	---

Part Number	Hose I.D.	Hose O.D.	PRICE EACH	Pkg Qty
-------------	-----------	-----------	------------	---------

G75... SANDBLAST COUPLING

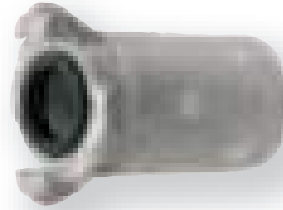

G75-075	3/4"	1.50"	\$7.60	1
G75-100	1"	1.88"	8.00	1
G75-125	1 1/4"	2.16"	11.90	1
G75-150	1 1/2"	2.38"	16.50	1

G75B... BRASS SANDBLAST COUPLING



G75B-075	3/4"	1.50"	23.90	1
G75B-100	1"	1.88"	24.70	1
G75B-125	1 1/4"	2.16"	39.20	1
G75B-150	1 1/2"	2.38"	55.90	1

G77... FEMALE NPT ADAPTER



	Pipe Size			
G77-125	1 1/4"	10.00	1	
G77-150	1 1/2"	10.00	1	

G77B... BRASS FEMALE NPT ADAPTER



G77B-125	1 1/4"	26.20	1
G77B-150	1 1/2"	26.20	1

G78... GASKET



Part No.	Hose Size	Loose	Std Pkg	Std Pkg
G78	1 1/4"	\$1.30	\$1.20	10

ABRASIVE MATERIAL FITTINGS

RHINO EXTERNAL SPLIT FLANGE COUPLINGS

Rhino flanges are sold as sets since the two halves are not identical or interchangeable. They are designed specifically for G743 Rhino Material Transfer Hose and fit tightly over the corrugated cover when the two halves are bolted together. This feature provides secure attachment while allowing full flow. Coupling sets come complete with bolts. Gaskets are purchased separately.

Part Number	Hose I.D.	Hose O.D.	PRICE EACH
G79... ALUMINUM COUPLING SET			
			
G79-300	3"	4.50"	\$200.30
G79-400	4"	5.25"	132.50
G79-600	6"	7.50"	191.90
G79-800	8"	9.50"	365.70
G79-1000	10"	11.50"	556.50
G79-1200	12"	13.75"	921.10

G79M... MALLEABLE IRON COUPLING SET



G79M-400	4"	5.25"	260.00
G79M-600	6"	7.50"	402.10

G79G... GASKET



G79G-300	3"	4.50"	29.40
G79G-400	4"	5.25"	31.00
G79G-600	6"	7.50"	37.90
G79G-800	8"	8.50"	58.60
G79G-1000	10"	11.50"	83.80
G79G-1200	12"	13.75"	125.30

CONCRETE HOSE FITTINGS

Designed similar to a hydraulic fitting, Green Line's concrete crimp fittings are zinc-plated, case hardened, and machined from stock. The two-piece, full flow design ensures proper depth insertion and fitting retention when attached to our Concrete Placement hose. In 5" sizes, our concrete fittings come as pre-crimped one-piece fittings. A hose pusher is required for installation as well as a crimper or swager for permanently attaching these fittings.

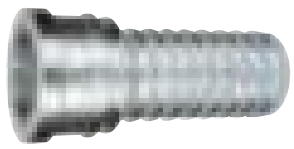
Part Number	Pipe Size	Hose Size	Flange O.D.	PRICE EACH
G73HI... HEAVY DUTY FLANGE STYLE				
				
G73HI-200-200	2"	2"	3"	\$69.30
G73HI-250-250	2½"	2½"	3½"	72.40
G73HI-300-300	3"	3"	4"	74.80
G73HI-400-350	4"	3½"	5"	139.00
G73HTI-400-350*	4"	3½"	5"	139.00
G73HI-400-400	4"	4"	5"	113.30
G73H-500-500	5"	5"	6.2"	264.60
G73M-582-500	Metric	5"	5.8"	264.60



*Note: The G73HTI fitting features a tapered bore to reduce turbulence when connecting 4" hoses to 3 1/2" hoses.

G73HF... CONCRETE HOSE FERRULE



Part Number	Hose Size	PRICE EACH
G73HF-200	2"	34.60
G73HF-250	2½"	49.80
G73HF-300	3"	55.40
G73HF-350	3½"	62.50
G73HF-400	4"	61.50



Note: These ferrules are designed for use with G73HI, G73VI, and G73NPTI Concrete Hose Inserts only.

G73VI... GROOVED STYLE INSERT



G73VI-200-200	2"	2"	66.10
---------------	----	----	-------



G73NPTI... MALE NPT STYLE INSERT



G73NPTI-200-200	2"	2"	66.10
-----------------	----	----	-------



GAUGES

Dry pressure gauges are for general service in fluid and pneumatic systems where an economical measurement device is needed. They are popular on air compressors and for general contractors use.

Note: Center back mount gauges can be ordered with a U-clamp mounting option.

Liquid filled gauges are well suited for hydraulic, oil and gas, pressure wash, and process systems. The liquid provides significant cushioning to reduce pointer flutter and internal damage. Center back mount gauges are available by specifying "-CBM" after PG in the part number. Center back mount gauges can be ordered with a U-clamp or front flange mounting option.

Part No.	Description	PRICE EACH
----------	-------------	------------

PGD... DRY PRESSURE GAUGES



PGD



PGD-CBM

PGD15	1.5" face with 1/8" bottom mount	\$7.80
PGD15-CBM	1.5" face with 1/8" center back mount	7.80
PGD20	2.0" face with 1/4" bottom mount	8.60
PGD20-CBM	2.0" face with 1/4" center back mount	8.60

Accuracy...	±3% B40.1 Grade B
Socket material...	Brass
Bourdon tube...	Bronze
Case...	Steel
Window...	Glass
Filling...	None
Temperature range...	-40°C (-40°F) to 60°C (140°F)

PRESSURE RANGES AVAILABLE...

Dash Size	Pressure Range	
	psi	kPa
-0015	0-15	0-100
-0030	0-30	0-200
-0060	0-60	0-400
-0100	0-100	0-600
-0160	0-160	0-1100
-0200	0-200	0-1200

PGB-FF... FRONT FLANGE



PGB-FF	Fits 2.5" center back mount	11.70
--------	-----------------------------	-------

PG-UC... U CLAMP



PG-UC	Fits 2.5" gauge	9.40
-------	-----------------	------

Part No.	Description	PRICE EACH
----------	-------------	------------

PG... LIQUID FILLED PRESSURE GAUGES

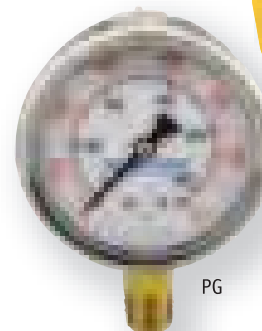

PG

MOST POPULAR

PG	2.5" face with 1/4" bottom mount	\$21.10
PG-CBM	2.5" face with 1/4" centre back mount	21.10
PG-CBM-10000	10,000 psi	35.90

Accuracy...	±3% B40.1 Grade B
Socket material...	Brass
Bourdon tube...	Bronze
Case...	Type 304 Stainless Steel
Window...	Plexiglas
Filling...	Silicone
Thread...	1/4" NPT
Mount...	Bottom
Temperature range	-40°C (-40°F) to 65°C (149°F)

PRESSURE RANGES AVAILABLE...

Dash Size	Pressure Range	
	psi	kPa
-VA00	-30"Hg-0	-100-0
-VA30	-30"Hg-30	-100-200
-0015	0-15	0-100
-0030	0-30	0-200
-0060	0-60	0-400
-0100	0-100	0-600
-0160	0-160	0-1100
-0200	0-200	0-1200
-0300	0-300	0-2000
-0400	0-400	0-2500
-0600	0-600	0-4000
-1000	0-1000	0-6000
-1500	0-1500	0-10000
-2000	0-2000	0-12000
-3000	0-3000	0-20000
-5000	0-5000	0-30000
-6000	0-6000	0-40000
-10000	0-10000	0-60000

For best results, please adhere to the following recommendations:

-When calibrating gauges, choose a calibration pressure that is in the middle range of the gauge (between the ten o'clock and two o'clock position of the dial).

-Remember to prick a hole or cut the tip off of the vent plug to bring the internal pressure back to atmospheric pressure.

-In high pressure applications, insert the included restrictor screw for all liquid filled pressure gauges.

-Ensure all gauges are mounted upright to avoid fluid leakage.

ALL STAINLESS GAUGES

PGSS gauges are made with Type 316 internal surfaces, for maximum corrosion resistance. Both PGSS center back mount gauges and PGSS40 lower back mount gauges can be ordered with a U-clamp or front flange mounting option. Back mount gauges are available by specifying "-CBM" after PGSS in the part number.

Process gauges feature a higher level of accuracy throughout their pressure range, and a micrometer pointer adjustment. As an additional safety feature process gauges are designed to blow out at the back if pressures are exceeded.

Part No.	Description	PRICE EACH
----------	-------------	------------

PGSS... STAINLESS LIQUID FILLED PRESSURE GAUGES



Note: PGSS-CBM back mount gauges are also available

PGSS	2.5" face with 1/4" bottom mount	\$58.20
PGSS-CBM	2.5" face with 1/4" centre back mount	58.20
PGSS40	4.0" face with 1/2" bottom mount	133.30
PGSS40-15000	15,000 psi	286.20
PGSS40-CBM	4.0" face with 1/4" lower back mount	228.50
PGSS40-CBM-10000	10,000 psi	254.00
PGSS40-CBM-15000	15,000 psi	286.20
Accuracy...	2 1/2" ±3% ASME B40.1 Grade B 4" ±1% ASME B40.1 Grade 1A	
Stainless Steel Bourdon tube...	Type 316 Stainless Steel	
Case...	Type 304 Stainless Steel	
Window...	Plexiglas	
Filling...	2 1/2" Silicone 4" Glycerin	
Thread...	2 1/2" face 1/4" NPT 4" face 1/2" NPT bottom mount 1/4" NPT lower back mount	
Mount...	Bottom	
Temperature range	-40°C (-40°F) to 65°C (149°F)	

PRESSURE RANGES AVAILABLE...

Dash Size	Pressure Range psi	kPa
-VA00	-30" Hg-0	-100-0
-VA30	-30" Hg-30	-100-200
-VA150	-30" Hg-150	-100-1000
-VA300	-30" Hg-300	-100-2000
-0015	0-15	0-100
-0030	0-30	0-200
-0060	0-60	0-400
-0100	0-100	0-600
-0160	0-160	0-1100
-0200	0-200	0-1200
-0300	0-300	0-2000
-0400	0-400	0-2500
-0600	0-600	0-4000
-1000	0-1000	0-6000
-1500	0-1500	0-10000
-2000	0-2000	0-12000
-3000	0-3000	0-20000
-5000	0-5000	0-30000
-6000	0-6000	0-40000
-10000	0-10000	0-60000
-15000	0-15000	0-100000

Part No.	Description	PRICE EACH
----------	-------------	------------

PGP... PROCESS GAUGES



PGP	4.0" face with 1/2" bottom mount	\$159.80
Accuracy...	0.5% ASME B40.1 Grade 2A	
Socket material...	Type 316 Stainless Steel	
Bourdon tube...	Type 316 Stainless Steel	
Case...	Black phenolic solid front, blow out back	
Window...	Plexiglas	
Filling...	Glycerin	
Thread...	1/2" NPT	
Mount...	Bottom	
Temperature range	-40°C (-40°F) to 100°C (212°F)	

PRESSURE RANGES AVAILABLE...

Dash Size	Pressure Range psi	kPa
-VA00	-30" Hg-0	-100-0
-VA15	-30" Hg-15	-100-100
-VA30	-30" Hg-30	-100-200
-0015	0-15	0-100
-0030	0-30	0-200
-0060	0-60	0-400
-0160	0-160	0-1100
-0200	0-200	0-1200
-0400	0-400	0-2500
-0600	0-600	0-4000
-1000	0-1000	0-6000
-1500	0-1500	0-10000
-2000	0-2000	0-12000
-3000	0-3000	0-20000
-5000	0-5000	0-30000

TG... TEMPERATURE GAUGES

This temperature gauge is commonly used to monitor water temperature in winter where freezing will cause problems. The 2.5" long rod is back mounted and can be inserted into the water flow via a tee junction or 1/2" NPT pipe plug. The face is 3" diameter.



Part No.	Temperature Range °C	°F	Thread	Rod Length	PRICE EACH
TG-4070	-40°-70°	-40°-160°	1/2"NPT	2.5"	\$76.90

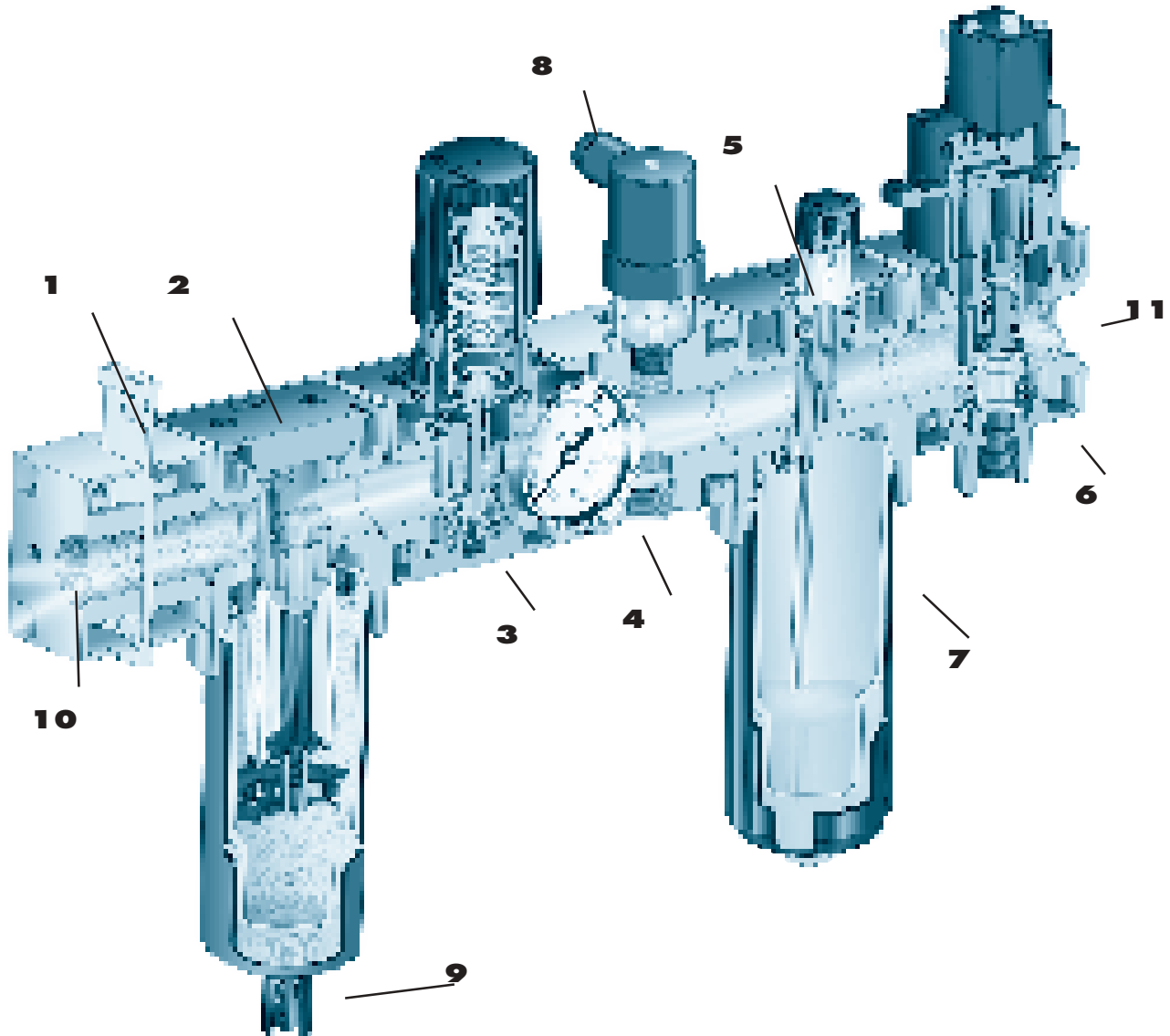

1 - SHUT OFF VALVE

Manual shut off used to relieve down stream pressure for servicing or maintenance. Security hole provided for lockout capabilities. Also may be used as a stand-alone unit.

2 - FILTER

Two types available - Particulate filter with 5 Micron filtration (shown), used as a primary filter to remove water, dust, and debris from air line. Water removal efficiency at 90% or better at rated flow. Coalescing filter - used as a secondary filter to remove up to 99.99% of oil and particles. Available with four different type elements: 0.1, 0.3, 0.7 micron filtration, and a vapor adsorbing element that utilizes activated carbon to deodorize compressed air.

3 - REGULATOR

Reduces supply pressure to a required working pressure, available in relieving or non-relieving styles, and in four different pressure ranges.

4 - DIVERTER BLOCK

Provides total versatility, mounts directly in-line to allow additional components to be manifolded without excessive pressure drop.

5 - LUBRICATOR

Designed to meter oil aerosols into the air stream where lubrication is required. Tamper resistant adjustment knob eliminates unauthor-

ized adjustments.

6 - SOLENOID SOFT START QUICK EXHAUST VALVE

When solenoid air pilot is energized, adjustable flow control allows system to be pressurized slowly. At 60psi of down stream pressure, slow start shifts to full flow condition. When solenoid air pilot is de-energized down stream pressure exhausts to atmosphere. Equipped with manual override and lockout.

7 - BOWLS

Three types available: Polycarbonate bowl with guard, metal bowl with sight glass, and Circle Vision. Circle Vision is a metal bowl wrapped in polycarbonate which allows for a 360 degree visual liquid level.

8 - PRESSURE SWITCH

Allows for remote monitoring of system pressure. An adjustable, tamper resistant knob resists unauthorized changes.

9 - DRAINS

3 types available - manual drain with internal barb fitting for drain tube(standard), flexible drain, and automatic drain.

10 - PRODUCT CONNECTION

Each component is engineered to connect directly together without inserts or special tools, this ensures optimum stability and strength.

11 - HIGH FLOW

Designed for high flows with minimal pressure drop.

Note: SCFM is Standard Cubic Feet per Minute
 *Suffix M indicates metal bowl with site glass.
 1" size is high flow, non-modular design.
 Filters with polycarbonate bowls are rated to 150 psi.
 Metal bowl filters and all other components are rated to 200 psi.
 Regulators can be adjusted from 0 to 200 psi.
 Gauge ports are 1/8" for 12 & 22 series. Larger sizes have 1/4" gauge ports.
 Particulate filters have 5 micron elements.
 Coalescing filters come standard with 0.3 micron elements.
 Stock filters have manual drains fitted with a barb for drain tubing attachment. Automatic drains are available on special order.

Part No.	Pipe Size	Flow Capacity	PRICE EACH
R_R... REGULATOR			
R12R-01	1/8"	10 SCFM	\$44.30
R12R-02	1/4"	10 SCFM	45.80
R22R-02	1/4"	65 SCFM	82.40
R22R-03	3/8"	75 SCFM	82.40
R22R-04	1/2"	75 SCFM	82.40
R32R-04	1/2"	155 SCFM	110.80
R32R-06	3/4"	155 SCFM	110.80
R50R-08	1"	395 SCFM	307.30



Part No.	Pipe Size	Flow Capacity	PRICE EACH
----------	-----------	---------------	------------

F_B... PARTICULATE FILTER

F12B-02	1/4"	30 SCFM	\$59.00
F22B-02	1/4"	45 SCFM	103.10
F22B-02M*	1/4"	45 SCFM	108.90
F22B-03	3/8"	60 SCFM	103.10
F22B-03M*	3/8"	60 SCFM	108.90
F22B-04	1/2"	70 SCFM	103.10
F22B-04M*	1/2"	70 SCFM	108.90
F32B-04	1/2"	105 SCFM	141.60
F32B-04M*	1/2"	105 SCFM	147.10
F32B-06	3/4"	110 SCFM	141.60
F32B-06M*	3/4"	110 SCFM	147.10
F50B-08	1"	260 SCFM	393.00

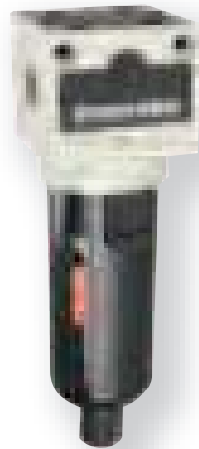

P_B... COMBINED PARTICULATE FILTER & REGULATOR

P12B-01	1/8"	10 SCFM	104.80
P12B-02	1/4"	10 SCFM	104.80
P22B-02	1/4"	65 SCFM	164.40
P22B-02M	1/4"	65 SCFM	169.90
P22B-03	3/8"	75 SCFM	164.40
P22B-03M	3/8"	75 SCFM	169.90
P22B-04	1/2"	75 SCFM	164.40
P22B-04M	1/2"	75 SCFM	169.90
P32B-04	1/2"	130 SCFM	209.90
P32B-04M	1/2"	130 SCFM	215.40
P32B-06	3/4"	130 SCFM	209.90
P32B-06M*	3/4"	130 SCFM	215.40



F_D... COALESCING FILTER - 0.3 MICRON ELEMENT

F12D-02	1/4"	9 SCFM	112.90
F22D-02	1/4"	15 SCFM	166.70
F22D-02M*	1/4"	15 SCFM	172.50
F22D-03	3/8"	15 SCFM	166.70
F22D-03M*	3/8"	15 SCFM	172.50
F32D-04	1/2"	15 SCFM	233.40
F32D-04M*	1/2"	15 SCFM	239.20
F32D-06	3/4"	48 SCFM	233.40
F32D-06M*	3/4"	48 SCFM	239.20



C_D... COMBINED COALESCING FILTER & REGULATOR

C12D-02	1/4"	8 SCFM	329.70
C22D-04	1/2"	13 SCFM	233.50
C22D-04M*	1/2"	13 SCFM	260.00
C32D-04	1/2"	47 SCFM	273.90
C32D-04M*	1/2"	47 SCFM	265.10
C32D-06	3/4"	47 SCFM	273.90
C32D-06M*	3/4"	47 SCFM	267.50



Note: For 0.7 micron, specify F_C and for 0.1 micron, specify F_E.

Note: SCFM is Standard Cubic Feet per Minute
 *Suffix M indicates metal bowl with site glass.
 1" size is high flow, non-modular design.
 Filters with polycarbonate bowls are rated to 150 psi.
 Metal bowl filters and all other components are rated to 200 psi.
 Regulators can be adjusted from 0 to 200 psi.
 Gauge ports are 1/8" for 12 and 22 series. Larger sizes have 1/4" ports.

Part No.	Pipe Size	Flow Capacity	PRICE EACH
----------	-----------	---------------	------------

L... LUBRICATORS

L12L-02	1/4"	35 SCFM	\$89.00
L22L-02	1/4"	40 SCFM	120.90
L22L-02M*	1/4"	40 SCFM	127.00
L22L-03	3/8"	70 SCFM	120.90
L22L-03M*	3/8"	70 SCFM	127.00
L22L-04	1/2"	100 SCFM	120.90
L22L-04M*	1/2"	100 SCFM	127.00
L32L-04	1/2"	100 SCFM	150.50
L32L-04M*	1/2"	110 SCFM	154.90
L32L-06	3/4"	150 SCFM	149.40
L32L-06M*	3/4"	150 SCFM	154.90
L50L-08	1"	325 SCFM	393.60



FRL ACCESSORIES



Part No.	Description	PRICE EACH
AKF02	Auto Drain	\$76.70
DKF02	Plastic Manual Drain	5.90
QKF02	Metal Manual Drain	19.50

REPLACEMENT FILTERS

Fits

Particulate filters, 5 micron element

EKF12B	F12B and P12B Series	22.50
EKF22B	F22B and P22B Series	24.30
EKF32B	F32B and P32B Series	24.30
EKF50B	F50B Series	185.50

Coalescing filters, 0.3 micron element

EKF12D	F12D and C12D Series	52.90
EKF22D	F22D and C22D Series	64.30
EKF32D	F32D and C32D Series	83.30



IN-LINE LUBRICATORS...

These lubricators are designed to provide an oil mist to lubricate reciprocating tools. Oil flow is regulated by screw adjustment, and a transparent viewing port allows oil level checks. Please install within 25 ft of tool and refer to arrow for air flow direction. Recommended for reciprocating tools only, and not recommended for constant flow applications.

Use any non-detergent, petroleum based light oil such as SAE 10/150SSU. Do not use synthetic oils or oils containing additives or solvents.



Part No.	Pipe Size	Oil Capacity	Maximum Pressure	Flow Capacity (at 70 psi)	PRICE EACH
PL-300	1/2"	41ml (1.4 US fl oz)	500 psi	30 scfm	\$164.00
PL-400	3/4"	109 ml (3.7 US fl oz)	200	70 scfm	171.30

SERVICE STATION ACCESSORIES

Part No. Description PRICE EACH

RUBBER SPOUT RADIATOR FAUCETS



40R 1/4" NPT Inlet with Rubber Spout \$33.30

ALUMINUM MANIFOLD CONNECTIONS



3404
3406
3408

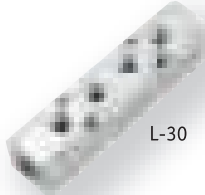

L-30

3404 1/4" NPT Three-Way Manifold 18.80
3406 3/8" NPT to 1/4" NPT Three-Way Manifold 19.30
3408 1/2" NPT to 1/4" NPT Three-Way Manifold 19.60
L-30 1/2" NPT to 1/4" NPT, Four Outlet Block Manifold 39.00

PRESSURE GAUGES



902 Heavy-Duty 10-150 psi Dual Foot Service Gauge 33.80
11 1/2" long for trucks and buses



908 Heavy-Duty 20-120 psi Dual Foot Pocket Gauge 15.80

INFLATOR CHUCKS



104 1/4" Ball Foot Chuck with 1/4" NPT Inlet 6.40

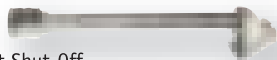

107 Dual Foot Chuck without Shut-Off 19.20

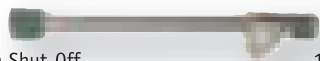

108 Dual Foot Chuck with Shut-Off 19.60



119 Lock-On Chuck 21.30

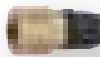

126 Straight Chuck with Shut-Off 7.00
127 Straight Chuck without Shut-Off 9.00

Part No. Description PRICE EACH



150 Tire Inflator Gauge with 12" Whip Hose \$62.30

Straight chuck with 12" whip hose and inflator gauge with brass bar calibrated in 2 psi increments from 10-90 psi. Standard unit for commercial applications

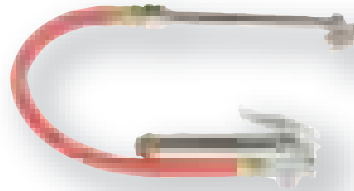

151 Tire Inflator Gauge with 12" Whip Hose 91.10

Swivel dual foot chuck with 12" whip hose and inflator gauge with brass bar calibrated in 2 psi increments from 10-90 psi.

HEAVY DUTY INFLATOR CHUCKS

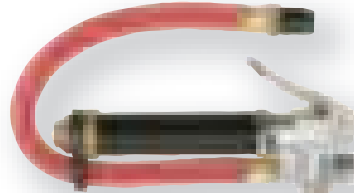

100 Heavy-duty Tire Inflator Gauge with 12" Whip Hose 75.80

Straight chuck with 12" whip hose and inflator gauge with brass bar calibrated in 2 psi increments from 10-120 psi. Heavy casting with protective cover over gauge tube.



101 Heavy-duty Tire Inflator Gauge with 12" Whip Hose 82.90

Swivel dual foot chuck with 12" whip hose and inflator gauge with brass bar calibrated in 2 psi increments from 10-120 psi. Heavy casting with protective cover over gauge tube.

TIRE VALVES

Tire valves were invented by August Schrader and his son George, and they patented the design in 1898. Tire valves are standardized around the world and all are basically this same design, which hasn't changed in over 100 years. The male thread dimension is 0.305" O.D. x 32 threads per inch.

Part No.	Description	PRICE EACH
----------	-------------	------------

NPT TANK VALVES



G1601TV-02 (old#700)	1/8" NPT Tank Valve, 3/8" Long Stem	\$4.00
G1601TVL-02 (old#701)	1/8" NPT Tank Valve, 3/4" Long Stem	4.00
G1601TVL-04 (old#701-2)	1/4" NPT Tank Valve, 5/8" Long Stem	5.00
G21TVB-030-025 (old#701-42)	1/4" Barb Tank Valve	12.20

SCREW ON BICYCLE PUMP CHUCK VALVES

G22TVB-030-019 (old#705)	3/16" Barb	3.60
G22TVB-030-025 (old#706)	1/4" Barb	4.30



TORCH KITS

Torch kits are popular for asphalt repair, weed burning, and preheating for welding. Our units are rated to 220,000 BTU at 30 psi and feature a comfort hand grip and a cast iron head. Our standard hose is 15 ft but other lengths are available. The kit includes the torch, regulator, 15 ft hose, adapters and Teflon tape for assembly.



Conveniently packaged for retail display

TK-M15

Part Number	Description	PRICE EACH
TK-M15	Propane Torch Kit	\$238.50
MODEL-80	Model 80 propane torch only	105.80
2002-H-HN	Propane tailpiece assembly with hex head	17.50
MEGR-6120-30	1/4" propane regulator 1-30 psi	95.20

SWIVEL JOINTS

Part No.	Description	PRICE EACH
----------	-------------	------------

LOW PRESSURE SWIVEL JOINTS FOR AIR AND WATER



G1608XB-04-04	1/4" NPT 150 psi Brass Straight Swivel	\$7.80
G1608XB-06-06	3/8" NPT 150 psi Brass Straight Swivel	15.80



G1698XA-04-04 (old #344U)	1/4" NPT 150 psi Alum/steel 360° Swivel	23.30
---------------------------	---	-------



G21XS-025-025 (old #444S)	1/4" NPT 1/4" Hose Barb Ball Swivel	19.10
---------------------------	-------------------------------------	-------

HIGH PRESSURE SWIVEL JOINTS FOR PRESSURE WASH



G1608XB-3000-04-04	1/4" NPT 3000 psi Brass Straight Swivel	16.00
G1608XB-3000-06-06	3/8" NPT 3000 psi Brass Straight Swivel	18.60



G1608XB-1000-08-08	1/2" NPT 1000 psi Brass Straight Swivel	50.80
--------------------	---	-------



G1608XSS-04-04	1/4" NPT 5000 psi Stainless Steel Straight Swivel	24.30
G1608XSS-06-06	3/8" NPT 3000 psi Stainless Steel Straight Swivel	29.80



0898XHD-08-08	1/2" NPT 5000 psi Heavy Duty 90° Swivel	189.00
0898XHD-12-12	3/4" NPT 4500 psi Heavy Duty 90° Swivel	266.10
0898XHD-16-16	1" NPT 4000 psi Heavy Duty 90° Swivel	330.20

Note: Pressure wash swivels are not suitable for oil or hydraulic service. For fuel hose swivels, see section 1. For hydraulic swivels, please refer to the PULSAR product line.

BLOW GUNS & ACCESSORIES

All the blow guns on this page are supplied with 1/4" female NPT thread.

Blow Gun Safety: Standard blow guns must only be used where air pressure is strictly regulated to 30 psi or less. For higher pressure air lines, safety blow guns must be specified. Safety blow guns feature a vented tip that allows air to escape if the tip is held against a solid surface, so that pressure at the tip will not exceed 30 psi, even if inlet pressure is higher. Even for safety blow guns, inlet pressure should not exceed 110 psi.

Part No. Description PRICE EACH

STANDARD BLOW GUNS

200	Full-Flow Blow Gun		\$17.50
201	Rubber Tipped Blow Gun		19.20
211	Rubber Kink-Operated Blow Gun		10.10

PREMIUM ERGONOMIC ANGLED BLOW GUN

11-208-0150	Premium Angled Blow Gun		54.60
-------------	-------------------------	---	-------

PREMIUM ERGONOMIC SAFETY BLOW GUN

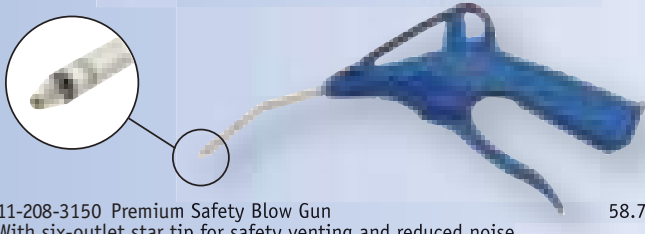
11-208-3150	Premium Safety Blow Gun With six-outlet star tip for safety venting and reduced noise		58.70
-------------	--	--	-------

SAFETY BLOW GUNS

204-30A	Lever-Operated Safety Blow Gun C/W Tamper-Proof Tip		22.40
208	Side Vented Safety Blow Gun		23.00

Part No. Description PRICE EACH

BLOW GUN REPLACEMENT TIPS

209	202	203VST	
			
202	Rubber Blow Gun Tip		\$6.70
209	Safety Blow Gun Tip		13.10
203VST	Vapour Spray Tip		22.40

SIPHON SPRAY TIP

221	Siphon Spray Tip		11.90
-----	------------------	---	-------

LEVER HANDLE VALVES

240	1/4" Lever Handle Valve		19.10
-----	-------------------------	---	-------

Do not confuse these premium blowguns with cheap look-a-likes. This product is designed for industrial use, with:

- high blowing force (18 CFM flow for full flow model, 7 CFM for safety design).
- ergonomic lightweight (112 gram) design.
- easy hanging design for quick retrieval and convenient storage.
- comfortable acetal handle insulates against cold air flow.
- available in full flow and safety designs (see 11-208-3150).

RG... RADIATOR GENIE

Packaged together for cleaning dust and mud out of your radiator. Excellent for farm or off-road equipment

RG-1002-BK	One air wand and one water wand		99.20
------------	---------------------------------	--	-------

Part No.	Description	PRICE EACH
----------	-------------	------------

NPT BUTTON STYLE BLEEDER VALVES

711	1/8" NPT Button Style Bleeder Valve	\$6.10
-----	-------------------------------------	--------

HIGH VOLUME AIR/WATER VALVE

XP100-050	1/2" NPT valve (old #D204-50)	213.60
-----------	-------------------------------	--------

G1600VB... BREATHER VENT SILENCER - NICKEL PLATED STEEL

G1600VB-02	1/8"	3.80
G1600VB-04	1/4"	4.80
G1600VB-06	3/8"	6.70
G1600VB-08	1/2"	9.20

Note: Screen is 40 micron mesh sintered bronze

EXHAUST MUFFLER WITH BRONZE FILTER

G1600EM-02	1/8"	5.00
G1600EM-04	1/4"	6.40
G1600EM-06	3/8"	7.60
G1600EM-08	1/2"	13.50

TAPERED SPRING GUARDS

TSG-063	5/8" I.D. Hose Tapered Spring Guard	3.60
---------	-------------------------------------	------

INTERNAL SPRINGS

These springs are typically placed inside softwall fuel hoses such as G603 to prevent kinking near the end fittings.



SGI-075	Internal spring guard for 3/4" I.D. hose	1.90
SGI-100	Internal spring guard for 1" I.D. hose	2.00

Part No.	Description	PRICE EACH	Pkg Qty
----------	-------------	------------	---------

PLASTIC STRAIN RELIEVER

MBR	TPG		
MBR-635	0.635" I.D. molded plastic guard	\$1.50	\$1.30 10
TPG-530	0.530" I.D. tapered plastic guard	6.30	4.30 10
TPG-625	0.625" I.D. tapered plastic guard	6.30	4.30 10
TPG-725	0.725" I.D. tapered plastic guard	6.30	4.30 10

Part No.	Description	PRICE EACH
----------	-------------	------------

HOSEBUN® HOSE SUPPORTS

HB-200SRD	2" hose support with D-ring	\$191.90
HB-300D	3" hose support with D-ring	190.80
HB-400D	4" hose support with D-ring	198.20
HB-600H	6" hose support with eye hook	737.50

HH... STAINLESS HOSE HANGERS

These attractive and functional hose hangers are made from Type 304 stainless steel and come complete with stainless mounting screws. Their stainless heavy duty construction make them perfect for sanitary and marine applications. They also look great in residential use.

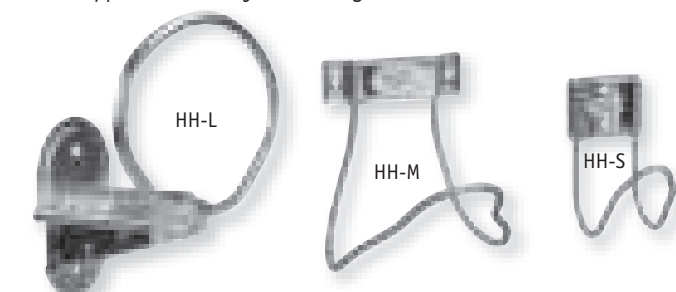

Part Number	Approximate Capacity	Height	Width	Depth	Weight	PRICE EACH
HH-S	100 ft of 1/2" I.D. hose	6.5"	3.0"	5.8"	0.8 lb	\$62.50
HH-M	100 ft of 3/4" I.D. hose	8.5	8.0	8.0	1.5	85.30
HH-L	100 ft of 1 1/4" O.D. hose	11.0	11.5	7.0	2.5	200.30

Part No.	Description	PRICE EACH
----------	-------------	------------

HOSE CUTTERS & BLADES



G99	Hose Cutters	\$17.90
G99B	Replacement Blades	7.30
G99TSNIP	Mini Tube Cutter	31.70

GREEN LINE BIN BOXES

GBIN-4	Green Line 4" Bin Box with Dividers	1.40
GBIN-6	Green Line 6" Bin Box with Dividers	1.90

OILPAD... OIL ABSORBENT PADS

These oil cleanup pads measure 15" x 18" and are made from polypropylene. They reject water, and so are ideal for land and water use, and typically absorb 15 to 25 times their weight in spilled oil (up to 1.36 litres per pad).

Part No.	PRICE EACH Loose	Std Pkg	Pkg Qty
OILPAD-1518	\$1.70	\$1.50	100



We can provide these tags embossed and attached to hose assemblies according to your instructions.

Part No.	Description	PRICE EACH
----------	-------------	------------

TAGS & TIES

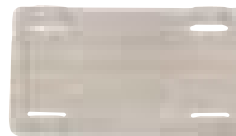

ID101	1.5" x 2.5" Type 304 Stainless Tag	\$3.40
-------	------------------------------------	--------



AS211	1/4" x 10" Type 304 Stainless Tie	3.10
AS212	1/4" x 16.5" Type 304 Stainless Tie	4.60
AS213	1/4" x 22.5" Type 304 Stainless Tie	5.20

G9 PROTECTIVE CAP PLUGS

Part No.	Industry Ref.	Dimensions (inches)				PRICE EACH		Std Pkg
		A-B	C-D	E	F	Loose	Std Pkg	
G9-01	5	0.236 - 0.302	0.174 - 0.240	0.380	0.440	0.27	0.18	100
G9-02	7	0.299 - 0.365	0.235 - 0.302	0.380	0.500	0.27	0.18	100
G9-03	9	0.361 - 0.427	0.298 - 0.365	0.380	0.560	0.27	0.18	100
G9-04	11	0.419 - 0.485	0.356 - 0.422	0.380	0.630	0.27	0.18	100
G9-04X	12	0.447 - 0.513	0.385 - 0.451	0.380	0.660	0.30	0.20	100
G9-05	13	0.471 - 0.547	0.409 - 0.485	0.440	0.690	0.30	0.20	100
G9-05X	14	0.500 - 0.576	0.440 - 0.516	0.440	0.720	0.30	0.20	100
G9-06	15	0.532 - 0.608	0.468 - 0.545	0.440	0.750	0.30	0.20	100
G9-06X	17	0.550 - 0.631	0.487 - 0.568	0.470	0.750	0.30	0.20	100
G9-07	16	0.531 - 0.620	0.468 - 0.555	0.500	0.750	0.34	0.22	100
G9-07X	20	0.610 - 0.695	0.549 - 0.634	0.500	0.813	0.34	0.22	100
G9-08	21	0.640 - 0.727	0.578 - 0.664	0.500	0.880	0.34	0.22	100
G9-08X	22	0.675 - 0.754	0.615 - 0.690	0.630	0.880	0.34	0.22	100
G9-09	23	0.690 - 0.788	0.628 - 0.726	0.560	0.940	0.34	0.22	100
G9-09X	26	0.725 - 0.823	0.663 - 0.761	0.560	0.970	0.34	0.22	100
G9-10	27	0.750 - 0.848	0.687 - 0.785	0.560	1.000	0.40	0.25	100
G9-11	28	0.802 - 0.911	0.740 - 0.849	0.630	1.060	0.40	0.25	100
G9-11X	29	0.815 - 0.930	0.753 - 0.868	0.630	1.090	0.42	0.29	100
G9-12	31	0.870 - 0.975	0.804 - 0.920	0.630	1.310	0.45	0.31	100
G9-12X	35	0.915 - 1.040	0.855 - 0.980	0.690	1.160	0.45	0.31	100
G9-13X	41	0.995 - 1.145	0.933 - 1.083	0.750	1.310	0.53	0.36	100
G9-14	42	1.110 - 1.225	1.038 - 1.180	0.750	1.500	0.56	0.38	100
G9-14X	44	1.175 - 1.284	1.113 - 1.222	0.630	1.440	0.56	0.38	100
G9-15X	45	1.235 - 1.360	1.173 - 1.298	0.810	1.500	0.56	0.38	100
G9-16	49	1.311 - 1.470	1.249 - 1.400	0.750	1.630	0.70	0.48	100
G9-17X	54	1.513 - 1.600	1.451 - 1.537	0.500	1.750	0.70	0.48	100
G9-18	55	1.560 - 1.682	1.498 - 1.620	0.750	1.880	0.75	0.51	100
G9-19	57	1.750 - 1.880	1.688 - 1.818	0.750	2.000	0.85	0.55	100
G9-20	58	1.807 - 1.938	1.743 - 1.874	1.000	2.160	0.95	0.64	100
G9-21	62	1.902 - 2.085	1.839 - 2.015	1.000	2.310	0.95	0.64	100
G9-240	72	2.298 - 2.464	2.235 - 2.401	1.000	2.630	1.70	1.11	10
G9-250	75	2.395 - 2.602	2.333 - 2.540	1.130	2.810	1.70	1.11	10
G9-300	88	3.270 - 3.862	3.200 - 3.492	1.120	3.690	1.80	1.33	10
G9-400	95	4.368 - 4.622	4.288 - 4.542	1.000	5.000	3.00	2.35	10

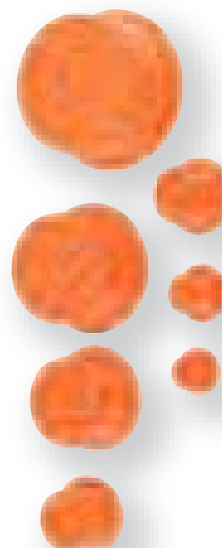
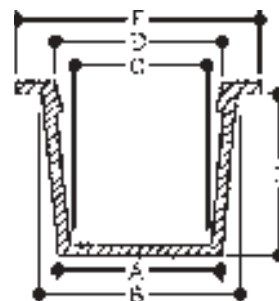

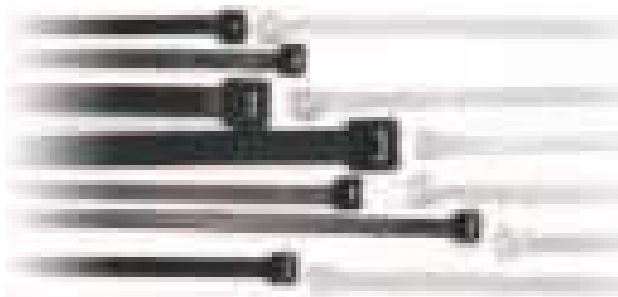

Part No.	Length	Bundle Diameter	Width	Tensile Strength	PRICE EACH		Std Pkg
					Loose	Std Pkg	
NYLON CABLE TIES							
CT... WHITE NYLON FOR INDOOR USE							
Miniature							
CT-0475	4 ³ / ₄ "	1.18"	0.098"	18 lb	\$0.09	\$0.06	100
Standard							
CT-0750	7 ¹ / ₂	2.05	0.189	50	0.14	0.10	100
CT-1100	11	3.19	0.189	50	0.22	0.16	100
CT-1450	14 ¹ / ₂	4.02	0.189	50	0.24	0.17	100
CT-1700	17	4.92	0.189	50	0.37	0.27	100

CTB... BLACK UV STABILIZED FOR OUTDOOR USE

Miniature							
CTB-0475	4 ³ / ₄ "	1.18"	0.098"	18 lb	0.09	0.06	100
Standard							
CTB-0750	7 ¹ / ₂	2.05	0.189	50	0.14	0.10	100
CTB-1100	11	3.19	0.189	50	0.22	0.16	100
CTB-1450	14 ¹ / ₂	4.02	0.189	50	0.24	0.17	100
CTB-1700	17	4.92	0.189	50	0.37	0.27	100
Heavy Duty							
CTB-1775	17 ³ / ₄	5.24	0.354	175	0.86	0.59	100
CTB-2400	24	7.28	0.354	175	1.00	0.70	100

Petrowrap is a tape system designed to repel water, salt, alkalis and acids to protect surfaces from corrosion. Composed mainly of petrolatum and anti-corrosion agents, Petrowrap will not harden or peel, and requires no maintenance. Protect your flanges, steel pipes, marine deck equipment by following these simple steps

1. Start with a dry surface
2. Eliminate air pockets by using petrowrap filler
3. Wrap petrowrap tape spirally with a 50% overlap to assure total protection.

Part No.	Description	PRICE EACH
----------	-------------	------------

G12... PETROWRAP ANTI-CORROSION TAPE

	G12PT	
	G12PTOW	
G12PT-200	Tape, 2" wide x 394" long	\$19.40
G12PT-400	Tape, 4" wide x 394" long	38.90
G12PTF	Filler, 500g (1.1 lb) block	11.00
G12PTOW	Overwrap Tape	20.70

THREAD SEALANT

Part No.	Description	PRICE EACH		Pkg Qty
		Loose	Std Pkg	

G10P... TEFLON® TAPE (Teflon is a registered trademark of Dupont Corporation)

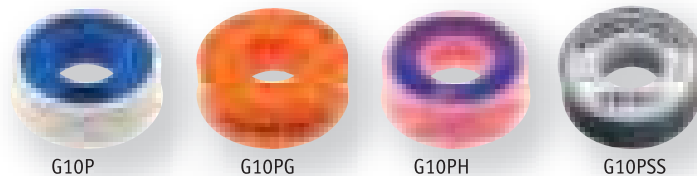

Our standard white Teflon® tape measures 0.003" thick				
G10P	1/2" wide, 520" long	\$1.00	\$0.80	10
G10PW	3/4" wide, 520" long	2.20	1.60	10

Petro Tape is light green and is ULC listed for natural gas				
G10PG	1/2" wide, 540" long	6.50	6.00	10
G10PGW	3/4" wide, 540" long	8.40	7.70	10

Our Heavy Duty pink tape is 33% thicker (0.004") and is UL listed for natural gas				
G10PH	1/2" wide, 260" long	3.70	3.10	10
G10PHW	3/4" wide, 520" long	4.10	3.60	10
For Stainless steel threads we offer a thick, high density tape with nickel pigment:				
G10PSS	1/2" wide, 260" long	7.10	6.60	10

G10L... LIQUID THREAD SEALANT

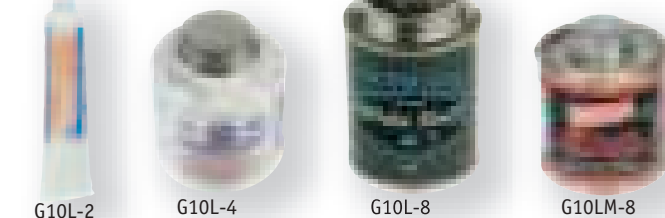

G10L-2	59ml (2 US fl.oz) tube of thread sealant	8.70
G10L-4	118ml (4 US fl.oz) liquid thread sealant	18.40
G10L-8	237ml (8 US fl.oz) liquid thread sealant	31.30
G10LM-8	250ml metallic paste compound with lead	39.30

G38-GL... LUBRICANT FOR INSTALLING GROOVED FITTINGS

This lubricant is water soluble and non-toxic, contains no petroleum and will not support bacterial growth. Designed to prevent accidental pinching of gasket when installing grooved couplings.

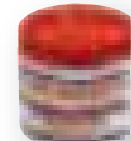
		
G38-GL	450 gram container	38.10

AEROSOL LUBRICANT & PENETRANT

		
G12-12/34	340g (15 US fl.oz) aerosol can	17.40

We stock 90 durometer nitrile o-rings that are suitable for high pressure hydraulic service. Softer 70 durometer seals are sometimes preferred for general industrial and automotive use. Where these are preferred for quick coupling repair seals, we stock these as well. Specify G11-N90 for hydraulic service and G11-N70 for low pressure use. Our part number includes the AS568 size reference. This list is limited to popular inch sized parts, since the AS568 specification lists about 350 sizes up to 26" diameter. Please call us for other sizes and materials. To view a complete listing of AS568 sizes visit the resources section on our website.

For convenience, we offer the following kits:

G11 INDUSTRIAL O-RING KITS



G11 O-RINGS

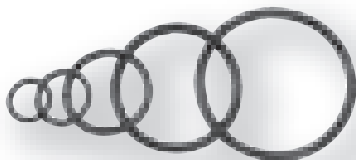

Part Number	Cross Section*	Nominal Size I.D.	PRICE EACH		Pkg Qty
			Loose	Std Pkg	
G11-N90-006	1/16"	1/8"	\$0.30	\$0.18	100
G11-N90-007	1/16"	5/32"	0.30	0.18	100
G11-N90-008	1/16"	3/16"	0.30	0.18	100
G11-N90-009	1/16"	7/32"	0.30	0.18	100
G11-N90-010	1/16"	1/4"	0.30	0.18	100
G11-N90-011	1/16"	5/16"	0.30	0.18	100
G11-N90-012	1/16"	3/8"	0.30	0.18	100
G11-N90-110*	3/32"	3/8"	0.30	0.18	100
G11-N90-111	3/32"	7/16"	0.30	0.18	100
G11-N90-112*	3/32"	1/2"	0.30	0.18	100
G11-N90-113	3/32"	9/16"	0.37	0.23	100
G11-N90-114*	3/32"	5/8"	0.37	0.23	100
G11-N90-115	3/32"	11/16"	0.53	0.37	100
G11-N90-116	3/32"	3/4"	0.53	0.37	100
G11-N90-210	1/8"	3/4"	0.74	0.45	100
G11-N90-211	1/8"	13/16"	0.74	0.48	100
G11-N90-212	1/8"	7/8"	0.80	0.53	100
G11-N90-213	1/8"	15/16"	0.80	0.53	100
G11-N90-214	1/8"	1"	0.74	0.45	100
G11-N90-215	1/8"	1 1/16"	0.95	0.55	100
G11-N90-216	1/8"	1 1/8"	1.01	0.58	100
G11-N90-217	1/8"	1 3/16"	1.01	0.64	100
G11-N90-218	1/8"	1 1/4"	1.05	0.69	100
G11-N90-219	1/8"	1 5/16"	0.95	0.58	100
G11-N90-220	1/8"	1 3/8"	1.01	0.67	100
G11-N90-221	1/8"	1 7/16"	0.95	0.66	100
G11-N90-222	1/8"	1 1/2"	1.17	0.74	100
G11-N90-225	1/8"	1 7/8"	1.38	0.90	100
G11-N90-228	1/8"	2 1/4"	1.70	1.04	100
G11-N90-232	1/8"	2 3/4"	2.12	1.27	100
G11-N90-237	1/8"	3 3/8"	3.90	2.40	100
G11-N90-325	3/16"	1 1/2"	1.70	1.20	100
G11-N90-326	3/16"	1 5/8"	1.90	1.30	100
G11-N90-327	3/16"	1 3/4"	2.00	1.30	100

G11KIT-N70

\$45.60

G11KIT-N90

79.00

Both kits contain 382 assorted o-rings made from 70 durometer nitrile in 30 different sizes. The N70 o-rings are suitable for general automotive and industrial applications. For high pressure hydraulic service, harder (N90 durometer) seals are used.

NOTE: Actual cross sections are larger than nominal size to allow for compression sealing. Cross sectional compression should be 10-30%. In addition, o-rings should be specified that are slightly smaller than the actual diameter of the rod or tube, so that they fit snugly. Ideally, they should be stretched 2% to 3% on installation.

* Sizes marked with an asterisk are also stocked in 70 durometer for quick coupling use.

ACCESSORIES

Part Number	Thread Type	Thread & Description	PRICE EACH		
			Loose	Std	Pkg

GREASE GUN COUPLER

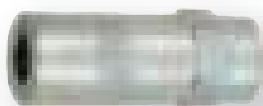

G13C-02	1/8" NPT	Standard duty narrow model	\$3.90	\$3.60	5
G13CHD-02	1/8" NPT	Heavy duty model	13.10	12.00	5
G14C-02	1/8" NPT	Fits 5/8" button head fittings	88.40	87.00	5

GREASE FITTINGS

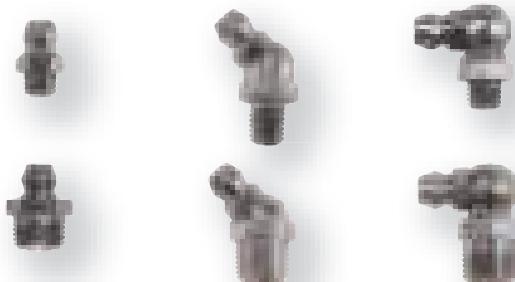

G13UNF-00	10/32-28	Straight	0.50	0.30	100
G13UNF-45	10/32-28	45°	0.90	0.60	100
G13UNF-90	10/32-28	90°	0.90	0.60	100
G13NPT-02-00	1/8" NPT	Straight	0.60	0.40	100
G13NPT-02-45	1/8" NPT	45°	0.90	0.60	100
G13NPT-02-90	1/8" NPT	90°	0.90	0.60	100
G13NPT-04	1/4" NPT	Straight	1.10	0.80	100
G13M-06-00	6mm Metric	Straight	0.50	0.30	100
G13M-06-45	6mm Metric	45°	0.90	0.60	100
G13M-06-90	6mm Metric	90°	0.90	0.60	100
G13M-08-00	8mm Metric	Straight	0.60	0.40	100
G13M-08-45	8mm Metric	45°	0.90	0.60	100
G13M-08-90	8mm Metric	90°	0.90	0.60	100
G13M-10-00	10mm Metric	Straight	0.60	0.40	100
G13M-10-45	10mm Metric	45°	0.90	0.60	100
G13M-10-90	10mm Metric	90°	0.90	0.60	100
G13BSPT-02-00	1/8" BSPT	Straight	0.90	0.70	100
G13BSPT-02-45	1/8" BSPT	45°	1.50	1.20	100
G13BSPT-02-90	1/8" BSPT	90°	1.50	1.20	100

GREASE FITTING ASSORTMENTS

G13KIT-SAE	100 pieces assorted SAE	32.90
G13KIT-METRIC	110 pieces assorted metric	36.60
G13KIT-COMBO	70 pieces SAE & metric	25.40



Part Number	Thread Type	Thread & Description	PRICE EACH		
			Loose	Std	Pkg

BUTTON HEAD GREASE FITTING



G14NPT-02	1/8" NPT	5/8" Button head straight	\$5.60	\$5.10	10
-----------	----------	---------------------------	--------	--------	----

Note: Button head fittings are typically used on large machinery where a greater flow of grease is required.

Part Number	Thread Type	Thread & Description	PRICE EACH		
			Loose	Std	Pkg

GREASE ADAPTERS



1608GR					
1648GR					
1698GR					
1608GR-01-02	1/4-28	Female 1/8" NPT Adapter	9.40	10	
1648GR-01-02	1/4-28	Female 1/8" NPT 45° Adapter	12.40	10	
1698GR-01-02	1/4-28	Female 1/8" NPT 90° Adapter	12.80	10	

GREASE FITTING CAPS



G13PC		Fits standard grease fittings	0.30	0.20	100
-------	--	-------------------------------	------	------	-----

METAL CHARACTERISTICS

Aluminum

This silver white metal is very malleable and quite corrosion resistant, since the surface reacts with oxygen to form a protective aluminum oxide coating. This coating is quite resistant to many chemicals—even acids, but can be penetrated by alkaline substances. It is lightweight and easy to machine, forge and cast. Alloys of aluminum are formed by adding a variety of other elements such as copper, manganese, zinc to produce products that can vary in strength, corrosion resistance, weight, and ease of forging.

Brass

Brass is an alloy primarily of copper and zinc with trace elements typically including silicon and iron. Brass is a golden yellow and weathers to a green color but is relatively corrosion resistant.

Bronze

An alloy of primarily copper and tin with traces typically including silicon and iron. Bronze was the first widely used metal strong enough for weapons and tools (hence the Bronze Age). Bronze is a reddish color and weathers to green but is relatively corrosion resistant. Adding beryllium produces an alloy hard enough for production of springs and hand tools.

Cast Iron

Also called pig iron, cast iron describes a wide range of irons with 2% or more carbon. The high carbon content makes cast iron somewhat brittle. Cast iron cannot be forged, but must be formed by casting or machining.

Copper

Copper is element #29, a reddish metal that is the primary metal in alloys of brass, bronze, and monel. Small amounts of copper added to aluminum, silver, and gold make those metals harder, and added to steel copper gives corrosion resistance. Copper pennies were actually bronze, not copper, since copper is too soft. Many modern copper coins are now zinc with a copper coating.

Ductile Iron

Also known as malleable iron, this product is made from cast iron by adding magnesium during the casting process. The magnesium causes the carbon to collect as graphite specks, so that the surrounding iron is low enough to be ductile to some extent. (Ductile means capable of being hammered out thin without cracking). Many items identified as cast iron are actually ductile iron. Ductile iron can be arc welded.

Iron

Pure iron is a soft ductile metal that rusts rapidly. Adding up to 1.5% carbon creates steel which can be hardened. Adding more carbon gives cast iron which is hard but brittle.

Stainless Steel

Stainless steel is a generic name for a class of steels that are used primarily because of their corrosion resistance. All stainless steel alloys contain a minimum of 10.5% chromium. Other elements, particularly nickel and manganese, are added to produce different physical and mechanical properties such as hardness, ease of machining, and ease of welding. Molybdenum may be added to further increase corrosion resistance. While there are many grades of stainless, 70% of production is Type 304 (also known as 18/8, since it is 18% chromium and 8% nickel). The amounts of various elements affect other characteristics. Basically, alloys of principally chromium and iron are known as 400 series and are all magnetic. Alloys with both chromium and nickel are 300 series, and chromium, nickel, manganese alloys are known as 200 series. These two series are generally non-magnetic. For hose fittings and clamps, the major types are:

Type 201 and 202

Uses manganese in place of some of the nickel. Similar to 301 and 302 in corrosion resistance. Commonly found as band material for clamps.

Type 301, 302, and 304

General use stainless steel.

Type 316

For most chemicals — has a very high corrosion resistance. Used where harsh cleaning chemicals are used, or where chemical concentrations are high.

Type 410 and 420

Easily hardened by heat treatment. Used in machine parts and cutters as well as clamps.

Steel

Iron with a small percentage of carbon is steel. The more carbon, the harder the steel can be made by heat treatment. Mild steel is 0.18 to 0.20% carbon. High carbon steels start at roughly 0.75% carbon and go up to around 1.5%. Alloy steels contain other ingredients for special purposes such as corrosion resistance.

Wrought Iron

True wrought iron is pure iron with thin layers of silica slag that gives a grainy appearance. Wrought iron was the primary ductile form of iron for thousands of years, but it is no longer in common use. Today the term wrought iron is used to describe low carbon steel pipe and also decorative ironwork made of any metal.

Zinc

Element #30 is a bluish white ductile metal that is the secondary alloy in brass. Zinc is used to harden aluminum alloys, and aluminum is used to make light strong zinc alloys.

THREAD DIMENSIONS

The following tables give the actual outside dimension of male threads in inches as well as the pitch given in threads per inch. For fire hose thread dimensions, see detail listings next to G81 in our Fire Section.

PIPE, STRAIGHT PIPE, & GARDEN HOSE THREADS

Pipe Size	Tapered Pipe		Straight Iron Pipe		Garden Hose	
	(NPT) O.D.	(NPSH) Pitch	O.D.	(GHT) Pitch	O.D.	Pitch
1/16	0.312	27				
1/8	0.405	27				
1/4	0.540	18				
3/8	0.675	18				
1/2	0.840	14				
3/4	1.050	14	1.035	14	1.062	11 1/2
1	1.315	11 1/2	1.295	11 1/2		
1 1/4	1.660	11 1/2	1.639	11 1/2		
1 1/2	1.900	11 1/2	1.878	11 1/2		
2	2.375	11 1/2	2.352	11 1/2		
2 1/2	2.875	8	2.841	8		
3	3.500	8	3.470	8		
3 1/2	4.000	8	3.970	8		
4	4.500	8	4.470	8		
5	5.563	8				
6	6.625	8				
8	8.625	8				
10	10.750	8				
12	12.750	8				

TUBE FITTING THREADS

Tube O.D.	Brass Compression		SAE 45° Flare		Inverted Flare	
	O.D.	Pitch	O.D.	Pitch	O.D.	Pitch
1/8	5/16	24	5/16	24	5/16	28
3/16	3/8	24	3/8	24	3/8	24
1/4	7/16	24	7/16	20	7/16	24
5/16	1/2	24	1/2	20	1/2	20
3/8	9/16	24	5/8	18	5/8	18
7/16	5/8	24	11/16	16	11/16	18
1/2	11/16	20	3/4	16	3/4	18
5/8	13/16	18	7/8	14	7/8	18
3/4	1	18	11/16	14	11/16	16
7/8	11/8	18	1 1/4	12	13/16	16
1	1 1/4	16	1 3/8	12		

DIMENSIONS OF 150lb ANSI FLANGES

Nominal Size	Flange O.D.	Flange Thickness	No. of Bolts	Bolt Size	Dia. of Bolt Holes	Dia. of Bolt Circle
1 1/4	4.25	9/16	4	1/2	5/8	3 1/8
1 1/2	5	11/16	4	1/2	5/8	3 7/8
2	6	3/4	4	5/8	3/4	4 3/4
2 1/2	7	7/8	4	5/8	3/4	5 3/4
3	7.5	15/16	4	5/8	3/4	6
4	9	15/16	8	5/8	3/4	7 1/2
5	10	15/16	8	3/4	7/8	8 1/2
6	11	1	8	3/4	7/8	9 1/2
8	13.5	1 1/8	8	3/4	7/8	11 3/4
10	16	1 3/16	12	7/8	1	14 1/4
12	19	1 1/4	12	7/8	1	17

HOW TO MEASURE A MALE FIRE HOSE THREAD

Take a strip of paper about 1 wide and wrap it around the male thread snugly so that it overlaps. Where the two ends overlap, use a pin to pierce the paper so that there is a hole in both ends. Press your thumb against the paper so that the threads leave an impression. Remove the paper and measure the distance between the pinholes. This distance, divided by 3.1416, equals the thread o.d. Count the number of thread impressions showing on the paper and divide by the total width of the impressions (in inches). This figure is the pitch in threads per inch.

PRESSURE/TEMPERATURE RATINGS FOR MALLEABLE IRON FITTINGS

The standard malleable fittings shown in this catalog are Class 150 and meet the working pressures shown here for that class. Heavier Class 300 parts are available on special order.

°C	°F	Class 150	Class 300		
		Working Pressure	Working Pressure		
		All sizes	1/4-1	1 1/4-2	2 1/2-3
		300 psi	2000	1500	1000
93	200	265	1785	1350	910
121	250	225	1575	1200	825
149	300	185	1360	1050	735
185	366	150	1150	900	650
204	400	N/A	935	750	560
232	450	N/A	725	600	475
260	500	N/A	510	450	385
288	550	N/A	300	300	300

ACTUAL MALE PIPE THREAD OUTSIDE DIAMETERS:

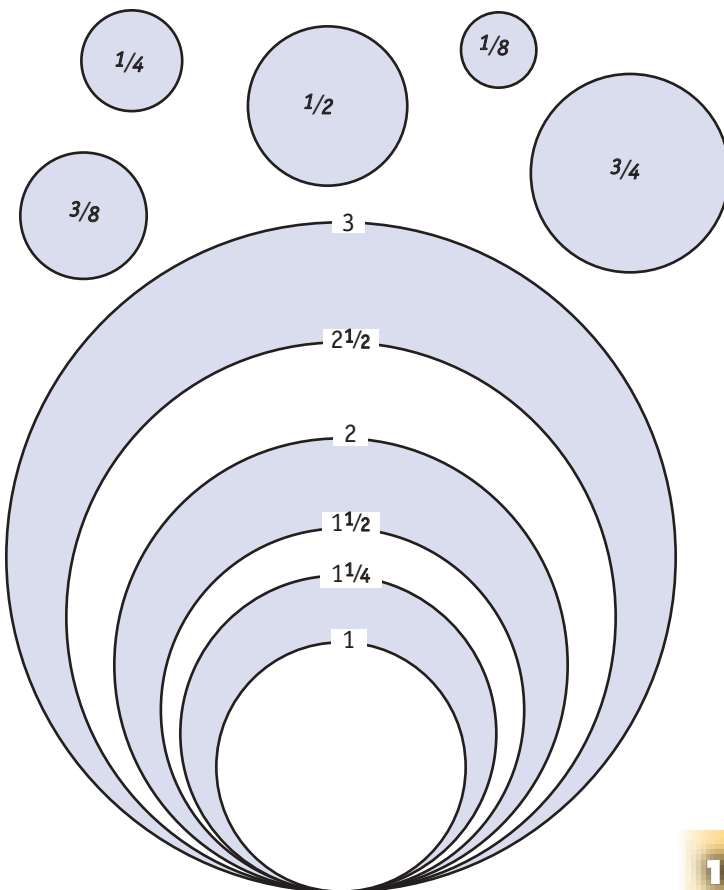

PNEUMATIC QUICK COUPLINGS INTERCHANGE

For easy identification of popular pneumatic quick couplings use these actual size silhouettes

Industrial Interchange

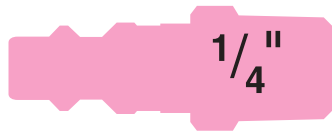

European Interchange



Lincoln Interchange



Automotive Interchange



Aro Interchange



C100 ISO-B series

The three most popular hydraulic quick coupling styles can look confusingly similar. If no part number is visible on the male coupling, use these actual size drawings to assist with identification

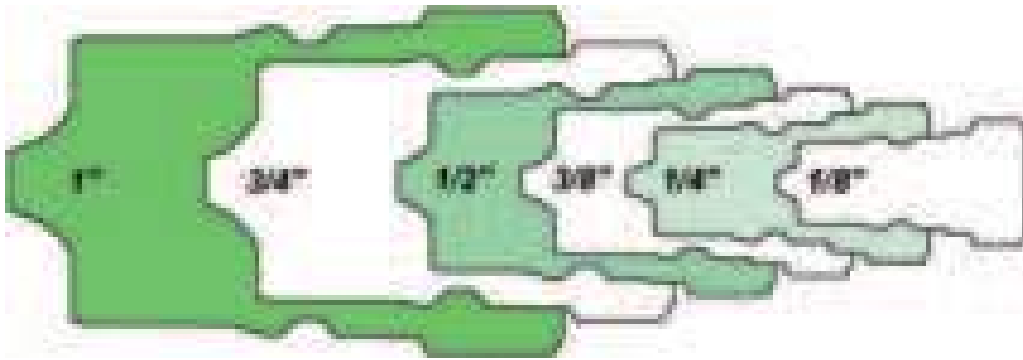

C200 ISO-A series

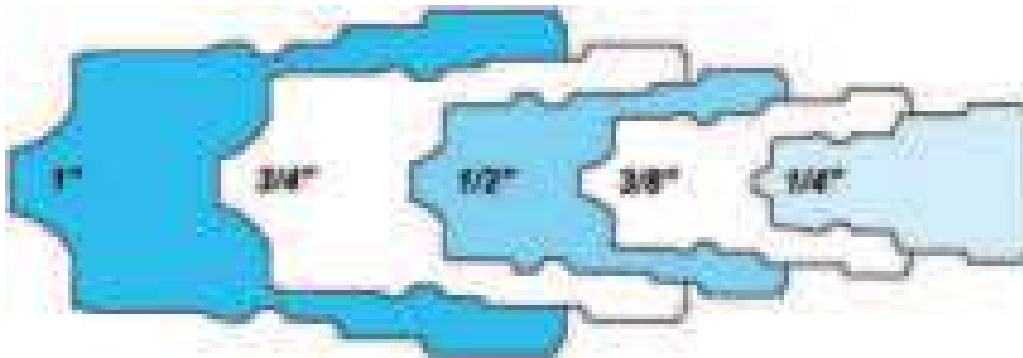

C400 Agricultural series

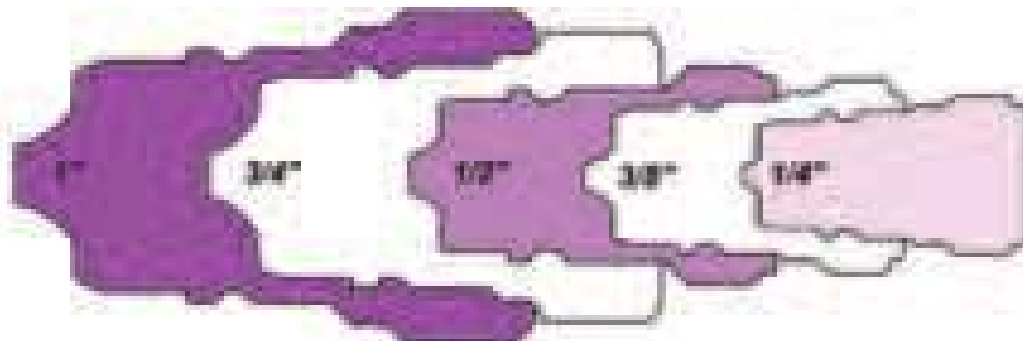

Quick Coupling Safety and Product Life

It is common to see quick couplings attached directly to air tools so that users can quickly and easily change tools. This is of course, the whole point of quick couplings in the first place! However if the tool vibrates (impact guns and chipping hammers for example), the quick coupling nipple will “chatter” against the retaining balls in the coupler. The hardened ball bearings will deform (dent) the ridge in the nipple—a process called brinnelling. Eventually the ridge will become high enough that it will prevent the coupling from disconnecting. A better practice is to attach a short whip hose to the tool and use the quick coupling between the whip hose and the main supply hose (see photo below). This isolates the tool vibration from the quick coupling.

Also shown in the picture is a G29R hose restraint (also known as a whip check or safety cable), which is used to prevent the supply hose whipping dangerously if the coupling breaks or disconnects accidentally.



Working Pressures – Coupler series and body material

Body Size"	CST Brass	CST Steel	C100 Steel	C100 303SS	C100 Brass	C100BOP	C200	C300	C400	C500	C500BOP	C500H	C600	C700	C700BOP	C700H	C700VEP	C710 Steel	C790	C800
1/8"	2800*	7400	4000	3000	3000														6000	
1/4"	2800*	5500	5000	3500	3000		5000	10000	3000				6000	5000					6000	6500
3/8"	2800*	4200	4000	3500	2500		4000	10000	3000					5000	5500	10000	5500			4500
1/2"	2200*	3500	4000	3500	2500	5000	4000		3000					5000		10000	5500			4000
3/4"	1700*	2100	4000	3000	2000	5000	4000		3000	3000	5000	5000		5000		6000	5500	7500		3500
1"	1700*	2000	4000	2000	1500	5000	4000		3000	4000	5000	5000		5000		6000	5500	7500		2000
1 1/4"	1400*	2700	2000	1000	1000		3000			3000		5000								
1 1/2"	1400*	2200	2000	1000	1000					2500		5000								

Note... *CST Brass Couplers can operate at steel working pressures when connected to steel male nipples.

Rated Flow - USGPM

Body Size	C100	C200	C300	C400	C500	C500H	C600	C700	C700VEP	C700H	C710	C800 Valved	C800 One or no valves
1/8"	1												
1/4"	3	3		3			3		3			4.5	4.5
3/8"	6	6		6				6	6	6		6.5	6.5
1/2"	12	12		12				12	12	12		17	20
3/4"	28	28		28	28	28		28	28	28	28	35	40
1"	50	50		50	50	50			50		50	43	55
1 1/4"					76	76							
1 1/2"	100				100	100							

CHEMICAL RESISTANCE CHART

Recommendations in this chart are based upon careful examination of published data. However please remember that chemical resistance is affected by temperature, concentration, environment, exposure to multiple chemicals, and other conditions. Other requirements, such as agency standards (CSA, FDA, etc) may also dictate selection. Therefore this table must only be used as a general guide.

Chart key:

- E... excellent, no effect
- G... good, minor effect only
- C... conditional, moderate effect, may be suitable in limited applications
- X... severe effect, not recommended
- I... no data available

	302SS	304SS	316SS	440SS	Acetyl	Aluminum	Cast Bronze	Brass	Cast iron	Carbon Steel	Teflon	Nylon	Polyethylene	Polypropylene	Buna N Seal *	Viton Seal *
acetaldehyde	E	E	E	I	X	G	X	I	I	C	E	E	C	G	G	X
acetamide	I	G	E	I	I	I	I	I	I	C	I	I	I	I	E	E
acetate solvent	E	G	E	G	I	G	E	C	G	E	E	E	G	X	X	X
acetic acid	I	G	E	G	G	G	C	C	X	C	E	X	G	E	C	C
acetic acid 20%	I	G	E	I	G	I	I	C	I	I	E	X	I	E	C	E
acetic acid 80%	I	G	E	I	G	I	I	C	I	I	E	X	I	G	C	E
acetic acid, glacial	I	G	E	E	I	G	C	C	X	E	E	X	G	G	X	X
acetic anhydride	G	E	E	G	I	G	C	X	G	X	E	X	E	E	E	X
acetone	E	E	E	G	X	E	E	E	E	E	E	E	C	G	X	X
acetyl chloride	I	C	E	I	I	I	X	I	I	I	E	I	I	I	I	E
acetylene	E	E	E	E	X	E	G	I	E	E	I	E	I	X	E	E
acrylonitrile	E	E	C	I	I	G	E	I	C	I	I	I	I	G	X	C
alum potassium sulfate (alum), 10%	I	E	I	I	I	E	I	I	X	E	E	E	E	I	I	E
alum potassium sulfate (alum), 100%	I	X	E	G	I	G	C	I	I	E	E	X	G	E	E	E
aluminum chloride	C	X	C	I	X	X	C	I	X	G	E	X	I	E	E	E
aluminum chloride 20%	I	X	C	X	I	G	X	I	X	E	I	E	G	E	E	E
aluminum fluoride	I	X	C	X	I	I	I	I	I	E	E	X	G	E	E	E
aluminum hydroxide	I	E	E	E	I	E	E	I	X	E	E	E	I	E	E	E
aluminum sulfate	I	C	C	E	G	E	C	C	X	E	E	E	G	E	E	E
amines	E	E	E	I	I	E	G	I	E	G	E	E	I	I	X	X
ammonia 10%	I	I	E	I	I	I	I	I	I	I	E	E	I	E	X	E
ammonia, anhydrous	E	G	E	E	I	G	X	I	X	G	E	E	G	E	G	X
ammonia, liquids	I	E	E	E	I	X	X	I	E	E	E	I	X	E	G	X
ammonia, nitrate	I	E	E	E	I	C	X	I	I	E	I	I	I	E	E	I
ammonium bifluoride	I	C	E	I	I	X	I	I	I	I	I	I	I	E	E	E
ammonium carbonate	G	E	E	E	X	C	G	I	C	G	E	E	I	E	X	G
ammonium casenite	I	I	E	I	I	I	I	I	I	I	I	I	I	I	I	I
ammonium chloride	C	E	C	E	X	C	X	C	X	X	E	E	G	E	E	E
ammonium hydroxide	E	E	E	E	X	C	X	X	E	C	E	E	G	E	G	G
ammonium nitrate	E	E	E	E	G	G	X	X	E	X	E	X	G	E	E	X
ammonium oxalate	I	E	E	E	I	I	I	I	I	E	I	I	I	I	E	I
ammonium persulfate	I	E	E	E	I	C	E	I	X	E	E	X	I	E	E	C
ammonium phosphate, dibasic	G	E	E	E	I	G	C	I	I	X	E	E	G	E	E	E
ammonium phosphate, monobasic	I	E	E	E	I	G	X	I	I	E	E	E	G	E	E	E
ammonium phosphate, tribasic	G	E	E	E	I	G	C	I	C	X	E	E	G	E	E	E
ammonium sulfate	C	X	G	E	I	G	G	C	C	C	E	X	G	E	E	X
ammonium thio-sulfate	I	I	E	I	I	I	I	I	X	E	I	I	I	I	E	I
amyl alcohol	E	E	E	I	G	C	E	G	C	C	E	E	G	G	G	G
amyl chloride	I	C	G	I	I	X	E	I	I	E	E	C	X	X	X	E
amyl-acetate	G	E	E	C	X	G	C	I	I	C	E	G	X	X	X	X
aniline	G	E	E	E	X	C	C	I	I	C	E	C	C	G	X	C
aniline oil	I	E	E	I	I	C	E	I	E	I	E	C	I	E	X	E
anise oil	I	E	E	I	I	I	I	I	I	I	I	I	I	I	I	I
anti-freeze	I	E	E	I	I	E	G	G	G	C	E	E	G	E	E	E
antimony trichloride	I	X	X	I	I	X	I	I	I	I	E	X	E	I	I	E
aqua regia (80%, hcl, 20%, hno)	I	X	X	I	I	X	X	I	I	I	E	X	X	C	X	C
aromatic hydrocarbons	I	I	E	I	I	E	E	I	E	E	I	I	C	I	X	E
arsenic acid	G	E	E	I	I	X	X	G	X	X	E	E	G	E	E	E
asphalt	I	G	E	I	C	C	E	I	C	I	I	E	I	E	G	E
barium carbonate	G	E	E	E	I	G	G	I	G	G	E	E	G	E	E	E
barium chloride	C	X	E	E	I	X	G	I	I	C	E	G	G	E	E	E
barium cyanide	I	I	E	I	I	I	C	I	I	E	I	I	G	I	C	E
barium hydroxide	G	C	E	E	I	X	G	I	C	C	E	E	G	E	E	E
barium nitrate	I	E	E	I	I	I	X	I	E	E	I	I	I	E	E	E
barium sulfate	G	E	E	E	I	X	C	I	C	C	E	E	G	E	E	E
beet sugar liquids	E	E	E	I	I	E	E	G	E	I	E	E	I	E	E	E
benzaldehyde	E	E	E	I	X	G	E	I	G	E	E	C	X	X	X	X
benzene	G	E	E	E	X	G	G	E	G	C	E	E	X	X	X	E

* NOTE: The ratings given for BUNA N and VITON rubber are based on their use as seals in couplings. For Chemical Resistance of Hose components refer to the tables in our Hose Catalog.

CHEMICAL RESISTANCE CHART

	302SS	304SS	316SS	440SS	Acetyl	Aluminum	Cast Bronze	Brass	Cast iron	Carbon Steel	Teflon	Nylon	Polyethylene	Polypropylene	Buna N Seal *	Viton Seal *
benzoic acid	G	E	E	E	X	G	G	I	X	I	E	X	G	X	X	E
benzol	I	E	E	I	I	G	G	E	I	I	E	E	I	E	X	X
benzyl alcohol	I	E	E	I	I	G	E	C	I	I	I	E	X	E	X	E
bone oil	I	E	E	I	I	I	E	I	I	I	I	I	I	I	E	E
borax (sodium borate)	I	E	E	E	G	C	E	G	E	C	E	E	G	E	G	E
boric acid	G	E	E	E	E	G	G	C	X	I	E	E	G	E	E	E
brewery slop	I	I	E	I	I	I	E	I	E	I	I	I	I	I	E	E
bromine (wet)	X	X	X	X	X	X	C	I	X	X	E	X	X	X	X	E
butadiene	E	E	E	I	I	E	C	E	C	C	E	E	I	I	E	E
butane	E	E	E	I	X	E	E	E	C	C	E	E	C	X	E	E
butanol	I	E	E	I	I	G	G	C	C	C	E	E	G	G	E	E
butter	I	G	E	I	E	E	X	I	X	I	I	I	I	I	E	E
buttermilk	E	E	E	E	I	E	X	I	X	I	E	E	I	I	E	E
butyl acetate	I	I	C	I	X	E	E	I	I	E	E	I	C	X	G	X
butyl alcohol	E	E	E	I	I	G	G	C	C	C	E	E	G	G	E	E
butylene	E	G	E	I	I	E	E	E	E	E	E	I	I	I	G	E
butyric acid	G	G	E	E	I	G	C	I	X	I	E	X	I	E	X	X
calcium bisulfate	C	X	E	I	I	X	X	X	X	I	E	E	I	I	E	E
calcium bisulfide	I	I	G	I	I	C	C	I	I	I	E	E	G	E	E	E
calcium bisulfite	I	G	E	I	I	C	C	I	I	I	E	E	I	E	E	E
calcium carbonate	G	E	E	E	I	C	C	I	X	I	E	E	G	E	E	E
calcium chlorate	I	G	E	I	I	I	C	I	I	I	E	E	E	I	I	E
calcium chloride	C	E	X	C	G	C	G	I	C	I	E	E	G	E	E	E
calcium hydroxide	G	E	E	I	I	C	G	I	I	I	E	E	G	E	E	E
calcium hypochlorite	X	X	C	C	X	C	X	I	X	I	E	X	G	E	G	E
calcium sulfate	G	E	E	E	I	G	G	I	I	I	E	E	G	E	E	E
calgon	I	E	E	I	I	I	C	I	X	I	I	I	I	E	E	E
cane juice	I	E	E	I	I	G	G	C	E	I	I	E	I	X	E	I
carbolic acid (see phenol)	I	I	I	I	I	I	I	I	I	I	I	I	I	I	I	I
carbon bisulfide	G	E	E	E	I	E	C	I	G	I	I	E	I	X	X	E
carbon dioxide (wet)	I	E	E	I	G	C	C	C	C	I	E	I	I	I	I	I
carbon monoxide	I	E	E	I	I	E	I	I	I	I	I	E	G	E	E	E
carbon tetrachloride	G	G	G	E	X	C	C	E	C	X	E	E	X	X	C	E
carbonated water	G	E	E	E	I	E	G	I	X	I	I	E	I	E	E	E
carbon disulfide	I	G	E	I	I	C	C	C	G	C	E	E	X	X	X	E
carbonic acid	G	E	G	E	I	E	G	I	X	I	E	E	G	E	G	E
castor oil	I	E	E	I	I	E	E	I	E	I	I	I	I	I	E	E
chloroacetic acid	X	X	X	X	I	C	X	I	X	I	E	X	X	X	X	X
chloric acid	I	X	X	I	I	I	I	I	I	I	E	I	I	I	X	I
chlorinated glue	I	E	E	I	I	X	C	I	X	I	I	C	I	I	C	E
chlorine (dry)	G	E	E	I	X	X	E	G	E	I	E	I	I	I	I	X
chlorine water	X	I	X	I	X	X	X	X	X	I	E	X	I	X	X	E
chlorine, anhydrous liquid	I	X	X	X	I	X	X	I	C	I	E	X	X	X	X	E
chlorobenzene (mono)	E	E	E	I	I	G	G	I	G	C	E	E	X	X	X	E
chloroform	E	E	E	E	X	X	G	I	X	C	E	C	X	X	X	E
chlorosulfonic acid	X	X	I	X	I	X	X	I	I	X	E	X	X	X	X	X
chlorox (bleach)	I	E	E	I	I	C	E	I	X	C	E	X	I	X	C	E
chocolate syrup	I	E	E	I	I	E	I	I	X	I	I	E	I	E	E	E
chromic acid 5%	I	E	E	G	X	C	X	X	X	I	I	X	G	E	X	E
chromic acid 10%	I	G	I	I	X	I	I	X	I	I	E	X	I	E	X	E
chromic acid 30%	I	G	I	I	X	I	I	X	I	I	E	X	I	E	X	E
chromic acid 50%	C	G	G	I	X	C	X	X	X	I	E	X	C	G	X	E
cider	I	E	E	E	I	G	E	I	X	I	I	I	G	I	E	E
citric acid	I	E	E	E	C	C	X	C	X	I	E	C	G	G	X	E
citric oils	I	E	E	I	I	C	G	I	I	I	I	I	I	E	E	E
cod liver oil	I	E	E	I	I	G	I	I	I	I	I	E	I	E	E	E
coffee	E	E	E	E	I	E	G	I	C	I	E	E	I	E	E	E
copper chloride	C	X	X	G	I	X	X	I	X	I	E	X	G	E	E	E
copper cyanide	I	E	E	E	I	X	C	I	X	I	E	E	G	E	G	G
copper floroborate	I	X	X	I	I	X	X	I	X	I	E	I	E	I	G	E
copper nitrate	G	E	E	G	I	X	X	I	I	I	E	X	G	E	E	E
copper sulfate	G	G	I	I	I	I	C	X	I	I	E	C	I	E	G	G
copper sulfate (5% sol)	I	E	E	E	E	X	X	X	X	I	E	X	G	E	E	E
corn oil	I	E	E	E	I	G	G	I	E	I	I	E	I	E	E	E
cotton seed oil	G	E	E	E	E	G	G	I	E	C	E	E	I	E	E	E
cream	I	E	E	I	I	E	C	I	X	I	I	E	I	E	E	E

* NOTE: The ratings given for BUNA N and VITON rubber are based on their use as seals in couplings. For Chemical Resistance of Hose components refer to the tables in our Hose Catalog.

CHEMICAL RESISTANCE CHART

	302SS	304SS	316SS	440SS	Acrytel	Aluminum	Cast Bronze	Brass	Cast iron	Carbon Steel	Teflon	Nylon	Polyethylene	Polypropylene	Buna N Seal*	Viton Seal*
creosote	I	E	E	I	G	E	I	I	I	I	I	I	I	X	E	E
cresols	I	E	E	I	I	G	X	C	I	I	I	I	X	C	X	X
cresylic acid	G	E	E	I	I	C	C	I	I	I	E	X	C	I	X	E
cyanic acid	I	E	I	I	I	I	I	I	I	I	I	I	I	I	C	I
cyclohexane	I	E	I	I	I	E	E	I	I	E	I	I	I	X	E	E
detergents	I	E	E	I	G	E	E	I	I	E	I	E	G	E	E	E
diacetone alcohol	I	E	E	I	I	E	E	C	I	E	I	E	I	X	X	X
dichlorethane	I	E	E	I	I	I	I	I	I	I	E	E	X	I	I	G
diesel fuel	E	E	E	I	I	E	E	I	E	E	I	I	I	X	E	E
diesel fuel (2d, 3d, 4d, 5d)	I	E	E	I	I	E	E	I	I	I	I	E	I	E	E	E
diethylamine	E	E	I	I	I	E	E	I	I	I	E	I	I	C	G	X
diethylene glycol	I	E	I	I	I	I	E	I	I	I	I	E	G	I	E	E
diphenyl oxide	I	E	I	I	I	I	E	I	I	I	I	I	I	I	X	E
dyes	I	E	E	I	I	G	C	I	I	I	I	I	I	I	I	E
epsom salts (magnesium sulfate)	G	E	E	E	I	E	G	I	I	I	I	I	I	E	E	E
ethane	E	E	I	I	I	E	E	I	I	I	I	I	I	I	E	E
ethanol	I	E	E	E	E	G	E	C	E	E	I	E	G	E	E	E
ethanolamine	I	E	E	I	I	I	I	I	I	C	I	I	I	I	G	X
ether	E	E	E	E	I	E	G	E	I	G	I	C	I	I	X	C
ethyl acetate	I	E	E	I	X	G	G	I	I	C	E	E	C	C	X	X
ethyl chloride	I	E	E	E	I	G	G	I	C	X	E	E	X	X	X	E
ethyl sulfate	I	X	I	I	I	I	I	I	I	I	I	I	I	I	E	E
ethylene chloride	I	E	E	I	I	C	E	I	C	C	E	I	I	X	X	E
ethylene dichloride	I	E	E	I	I	X	C	I	I	C	E	E	X	E	X	E
ethylene glycol	I	E	E	I	E	E	G	G	G	C	E	E	G	E	E	E
ethylene oxide	I	I	E	I	I	E	E	I	I	I	E	E	I	I	X	X
fatty acids	I	E	E	I	I	G	C	I	X	I	E	E	G	E	C	E
ferric acid	I	X	X	X	I	X	X	X	X	I	E	X	G	E	X	E
ferric nitrate	I	E	E	E	I	X	X	I	I	E	X	G	E	E	E	E
ferric sulfate	I	E	C	E	I	X	X	X	X	I	E	E	I	E	G	E
ferrous chloride	I	X	X	I	X	X	C	I	X	I	E	X	G	E	G	E
ferrous sulfate	G	E	C	I	G	X	C	I	X	X	E	X	G	E	G	E
fluoboric acid	I	X	G	I	I	I	I	I	X	I	E	C	G	E	G	E
fluorine	X	X	X	I	I	X	X	I	X	X	C	X	C	I	I	I
fluosilicic acid	I	I	G	I	I	X	I	I	X	I	E	X	G	E	E	G
formaldehyde	E	E	E	I	I	E	E	G	X	E	E	E	G	E	C	X
formaldehyde 40%	I	I	E	I	X	I	I	I	I	E	X	I	E	G	X	X
formic acid	C	E	G	G	X	X	C	C	X	X	E	X	G	E	X	G
freon 11	E	I	E	I	I	G	G	I	C	G	E	E	C	I	C	G
freon 113	I	I	E	I	I	G	G	I	I	I	I	E	I	I	E	C
freon 12 (wet)	I	I	X	I	I	G	G	I	I	I	E	E	C	E	E	E
freon 22	I	I	E	I	I	G	G	I	I	I	I	E	I	I	X	X
freon t.f.	I	I	E	I	I	G	G	I	I	I	I	E	I	X	E	G
fruit juice	E	E	E	E	I	G	G	I	X	X	X	E	G	E	E	E
fuel (1,2,3,5a, 5b, 6)	I	E	E	I	I	E	E	I	I	I	E	I	I	G	G	E
fuel oils	E	E	E	I	I	E	G	I	C	G	E	E	X	G	E	E
furan resin	I	E	E	I	I	E	E	I	E	E	E	I	I	I	X	E
furfural	E	E	E	I	I	E	E	I	I	E	E	E	X	X	X	X
gallic acid	G	E	E	E	I	E	E	I	X	X	E	E	I	I	E	G
gasoline	E	E	E	E	I	E	E	I	E	E	E	E	X	C	E	E
gelatin	E	E	E	E	I	E	E	C	X	X	E	E	I	E	E	E
glucose	E	I	E	I	E	E	E	E	G	G	E	E	G	E	E	E
glue p.v.a.	G	G	E	I	I	G	E	I	I	E	E	E	I	I	E	E
glycerine	E	E	E	E	E	E	E	G	G	G	E	E	I	E	E	E
glycolic acid	I	I	I	I	I	I	I	I	I	I	I	I	G	E	E	E
gold monocyaniide	I	I	E	I	I	I	E	I	X	I	I	I	I	I	E	E
grape juice	I	E	E	I	I	G	G	I	X	I	I	I	G	I	E	E
grease	E	E	E	I	I	E	G	I	E	E	E	E	I	I	E	E
heptane	E	I	E	I	I	E	E	I	I	G	E	E	X	X	E	E
hexane	E	E	E	I	I	E	G	I	I	G	E	E	I	C	E	E
hexyl alcohol	I	E	E	I	I	E	E	C	I	E	I	E	I	E	E	E
honey	I	E	E	I	I	E	E	I	E	I	I	E	I	E	E	E
hydraulic oils (petroleum)	E	E	E	I	I	E	G	I	E	E	E	E	I	X	E	E
hydraulic oils (synthetic)	I	E	E	I	I	E	E	I	E	I	I	E	I	X	C	E
hydrazine	I	E	E	I	I	I	I	I	C	I	I	I	I	I	G	E
hydrobromic acid	X	X	X	X	X	X	X	I	X	X	E	X	G	G	X	E

* NOTE: The ratings given for BUNA N and VITON rubber are based on their use as seals in couplings. For Chemical Resistance of Hose components refer to the tables in our Hose Catalog.

CHEMICAL RESISTANCE CHART

	302SS	304SS	316SS	440SS	Acetyl	Aluminum	Cast Bronze	Brass	Cast iron	Carbon Steel	Teflon	Nylon	Polyethylene	Polypropylene	Buna N Seal *	Viton Seal *
hydrobromic acid 20%	I	I	X	I	I	I	I	I	I	I	E	X	I	E	X	E
hydrochloric acid (dry gas)	X	C	E	I	I	X	I	I	I	X	E	I	I	I	I	I
hydrochloric acid 100%	I	X	X	I	I	X	X	I	X	I	E	X	E	I	X	C
hydrochloric acid 20%	I	X	X	X	X	X	X	I	X	I	E	X	E	E	C	E
hydrochloric acid 37%	I	X	X	X	X	X	X	I	X	I	E	X	E	E	C	E
hydrocyanic acid	E	E	E	C	I	E	X	X	I	C	E	E	G	E	C	E
hydrocyanic acid (gas 10%)	I	X	X	I	I	I	I	I	I	I	E	I	I	I	I	I
hydrofluoric acid 100%	X	X	X	I	X	X	X	I	X	X	E	I	X	I	X	I
hydrofluoric acid 20%	I	X	X	X	X	X	X	I	X	I	E	X	C	E	X	E
hydrofluoric acid 75%	I	C	X	I	X	X	X	I	X	I	E	X	C	G	X	E
hydrofluosilicic acid	I	X	X	I	I	C	X	I	I	I	E	I	I	I	I	I
hydrofluosilicic acid 20%	I	X	X	I	I	X	E	I	X	I	E	X	I	E	G	E
hydrogen gas	E	E	E	I	X	E	E	I	G	G	E	I	I	I	I	E
hydrogen peroxide	I	E	G	E	I	E	X	X	X	X	E	X	G	E	X	E
hydrogen peroxide 10%	I	C	C	I	I	E	X	X	X	I	E	X	E	I	E	I
hydrogen peroxide 30%	I	I	G	I	I	I	I	X	I	I	E	X	I	E	X	E
hydrogen sulfide (dry)	E	C	E	I	X	X	X	C	G	G	E	X	I	I	I	X
hydrogen sulfide, aqueous solution	I	X	E	C	X	C	X	C	X	I	E	X	G	E	C	X
hydroxyacetic acid (70%)	I	I	I	I	I	X	I	I	I	I	I	I	I	I	E	E
indium sulfamate plating r.t.	I	I	C	I	I	I	I	I	I	I	E	X	I	E	E	E
ink	E	E	E	I	I	C	C	I	X	X	I	E	G	I	E	E
iodine	I	X	X	X	X	X	X	I	X	I	E	X	X	X	G	E
iodine (in alcohol)	I	I	G	I	I	I	I	I	I	I	E	X	I	G	X	E
iodoform	G	C	E	I	I	E	C	I	C	G	E	E	I	I	I	E
isobutyl alcohol	I	E	E	I	I	G	E	C	I	E	I	E	I	E	C	E
isopropyl acetate	I	I	G	I	I	C	I	I	I	I	I	I	I	I	X	X
isopropyl alcohol	I	E	E	I	G	G	E	C	C	E	I	E	I	E	C	E
isopropyl ether	E	I	E	I	I	E	E	I	I	E	E	I	I	X	G	X
isotane	I	I	I	I	I	E	I	I	I	I	I	I	I	X	E	E
jet fuel (jp#, jp4, jp5)	E	E	E	I	I	E	E	I	E	E	E	E	I	X	E	E
kerosene	E	E	E	E	E	E	E	E	E	G	E	E	X	X	E	E
ketones	E	E	E	I	I	G	E	I	E	E	E	E	X	X	X	X
lacquer thinners	I	I	E	I	I	I	I	C	I	I	E	E	I	G	X	I
lacquers	E	E	E	I	I	E	E	C	C	C	I	E	I	E	X	X
lactic acid	E	E	G	C	C	C	X	I	X	X	E	C	G	E	G	G
lard	G	E	E	E	I	E	E	I	E	C	I	E	I	E	E	E
latex	I	E	E	I	I	E	E	I	I	I	I	E	G	I	E	E
lead acetate	G	E	E	I	G	X	C	I	I	X	E	E	G	E	G	X
lead sulfamate	I	I	I	I	I	I	I	I	I	I	I	I	I	E	G	E
lime	I	E	E	I	I	C	E	I	E	I	I	I	I	I	E	E
linseed oil	I	E	E	E	E	E	E	I	E	I	I	E	I	E	E	E
lubricants	I	E	E	I	I	E	G	I	I	I	E	E	I	E	E	E
magnesium carbonate	I	E	E	E	I	I	I	I	I	I	I	I	G	E	E	I
magnesium chloride	G	G	G	E	G	X	G	C	X	C	E	E	G	E	E	E
magnesium hydroxide	E	E	E	I	G	X	C	G	G	G	E	E	G	E	G	E
magnesium nitrate	I	E	E	E	I	I	I	I	I	I	E	E	G	E	E	E
magnesium oxide	I	E	E	I	I	I	I	I	I	I	I	I	I	I	E	I
magnesium sulfate	G	G	E	I	I	G	G	G	C	G	E	E	G	E	E	E
maleic acid	C	E	E	E	I	G	C	I	I	G	E	E	I	C	X	E
maleic anhydride	I	I	I	I	I	I	I	I	I	I	I	I	I	I	X	E
malic acid	G	E	E	I	X	C	X	I	I	X	E	E	I	I	I	G
melamine	I	X	X	I	I	I	X	I	I	I	I	I	I	I	C	I
mercuric cyanide	E	E	E	I	I	X	X	I	I	X	E	I	G	E	E	I
mercuric chloride (dilute solution)	X	X	X	X	X	X	X	X	X	X	E	E	G	E	E	E
mercury	E	E	E	E	G	C	X	X	E	E	E	E	G	E	E	E
methanol	I	E	E	E	X	G	E	C	E	E	E	E	G	E	G	C
methyl acetate	E	I	E	I	I	E	E	I	I	G	E	I	I	I	X	X
methyl acetone	E	I	E	I	I	E	E	I	E	E	E	I	I	I	X	X
methyl acrylate	I	I	I	I	I	I	I	I	I	I	I	I	I	I	X	X
methyl alcohol 10%	E	I	E	I	I	C	C	I	I	G	E	E	I	I	G	I
methyl bromide	I	I	I	I	I	I	I	I	I	I	I	I	X	I	G	E
methyl butyl ketone	I	I	E	I	I	E	I	I	I	I	I	I	I	I	X	X
methyl cellosolve	I	I	I	I	I	E	E	I	I	I	I	I	I	E	X	X
methyl chloride	I	E	E	I	X	X	E	I	I	I	E	E	X	X	X	E
methyl dichloride	I	I	I	I	I	I	I	I	I	I	I	I	I	I	X	E
methyl ethyl ketone	I	E	E	I	I	E	E	I	I	I	E	E	X	E	X	X

* NOTE: The ratings given for BUNA N and VITON rubber are based on their use as seals in couplings. For Chemical Resistance of Hose components refer to the tables in our Hose Catalog.

CHEMICAL RESISTANCE CHART

	302SS	304SS	316SS	440SS	Acetyl	Aluminum	Cast Bronze	Brass	Cast iron	Carbon Steel	Teflon	Nylon	Polyethylene	Polypropylene	Buna N Seal *	Viton Seal *
methyl isobutyl ketone	I	I	E	I	I	I	I	I	I	I	E	E	I	C	X	X
methyl isopropyl ketone	I	I	E	I	I	I	I	I	I	I	I	E	I	I	X	X
methyl methacrylate	I	I	I	I	I	I	I	I	I	I	I	I	I	I	X	X
methylamine	E	I	E	I	I	E	X	I	G	G	I	I	I	I	G	I
methylene chloride	E	E	E	I	I	E	E	C	I	G	E	X	X	X	X	X
milk	E	E	E	E	G	E	C	C	X	X	I	E	G	E	E	E
mineral oil	E	E	E	E	I	E	E	I	E	G	I	E	I	G	E	E
molasses	E	E	E	E	I	E	E	G	E	E	I	E	G	E	E	E
naptha	E	E	E	E	I	E	G	I	G	G	E	E	X	E	G	E
napthalene	G	E	G	I	I	G	C	I	G	E	E	I	X	G	X	G
nickel chloride	I	E	G	I	I	X	X	I	X	I	E	E	G	E	E	E
nickel sulfate	G	E	G	I	I	X	C	C	X	X	E	E	G	E	E	E
nitric acid (10% solution)	E	E	E	E	X	X	X	I	X	X	E	X	G	E	X	E
nitric acid (20% solution)	I	E	E	E	X	X	X	I	X	I	E	X	G	E	X	E
nitric acid (50% solution)	I	E	E	E	X	X	X	I	X	I	E	X	C	X	X	E
nitric acid (concentrated solution)	I	X	G	E	X	G	X	X	X	I	E	X	X	X	X	G
nitrobenzene	G	E	G	I	X	C	X	I	G	G	E	C	X	C	X	X
octyl alcohol	I	E	E	I	I	E	E	C	I	E	I	E	I	I	G	E
oleic acid	G	E	E	G	G	G	G	C	C	C	E	E	X	C	G	X
oleum	G	I	E	I	I	G	C	C	I	G	E	I	I	X	C	E
oleum 25%	I	I	I	I	I	I	I	I	I	I	E	I	I	I	X	E
olive oil	E	E	E	E	I	G	E	G	I	E	G	E	E	I	E	E
oxalic acid (cold)	C	E	G	E	G	C	G	C	X	X	E	X	E	E	G	E
paraffin	E	E	E	E	I	E	E	I	G	G	E	E	I	E	E	E
peanut oil	I	E	E	I	I	E	E	I	E	I	I	I	I	X	E	E
pentane	E	C	C	I	I	E	E	I	G	G	E	E	I	I	E	E
perchloroethylene	G	E	E	I	I	E	C	I	G	G	E	I	I	X	C	E
petrolatum	E	I	E	I	I	G	G	I	C	C	E	E	I	I	E	E
phenol (carbolic acid)	G	E	E	E	I	G	G	X	X	X	E	X	X	G	X	E
phenol 10%	G	E	E	I	X	E	C	I	G	X	E	X	I	I	X	G
phosphoric acid (crude)	I	X	C	C	X	X	X	X	X	X	E	X	C	I	X	E
phosphoric acid (to 40% solution)	I	G	E	E	X	X	X	X	X	I	E	X	G	E	X	E
phosphoric anhydride (dry or moist)	I	E	E	I	I	I	I	X	I	I	E	I	I	I	X	X
photographic (developer)	I	C	E	C	I	C	I	I	X	I	I	I	G	E	E	E
phosphoric acid (40-100% solution)	I	C	G	G	I	X	X	X	X	I	E	X	C	E	X	E
phosphoric anhydride (molten)	I	E	E	I	I	X	X	X	I	I	E	E	X	I	C	X
phthalic anhydride	G	E	G	I	I	G	G	I	C	C	E	E	I	I	C	E
picric acid	G	E	E	I	I	C	X	X	X	X	E	E	E	I	E	E
pine oil	E	E	E	I	I	E	X	I	C	G	E	I	I	I	E	E
plating solutions:																
- antimony plating 130°f	I	I	E	I	I	I	I	I	I	I	E	X	I	E	E	E
- arsenic plating 110°f	I	I	E	I	I	I	I	I	I	I	E	E	I	E	E	E
- brass bath 100°f	I	I	E	I	I	I	I	I	I	I	E	E	I	E	E	E
- bronze	I	I	E	I	I	I	I	I	I	I	E	E	I	E	E	E
- cadmium cyanide bath 90°f	I	I	E	I	I	I	I	I	I	I	E	E	I	E	E	E
- cadmium fluoborate bath 100°f	I	I	E	I	I	I	I	I	I	I	E	X	I	E	G	E
- chromium barrel chrome bath 95°f	I	I	X	I	I	I	I	I	I	I	E	X	I	E	X	C
- chromium black chrome bath 115°f	I	I	C	I	I	I	I	I	I	I	E	X	I	E	X	C
- chromium chromic-sulfuric bath 130°f	I	I	C	I	I	I	I	I	I	I	E	X	I	E	X	C
- chromium fluoride bath 130°f	I	I	X	I	I	I	I	I	I	I	E	X	I	E	X	C
- chromium fluosilicate bath 95°f	I	I	C	I	I	I	I	I	I	I	E	X	I	E	X	C
- copper (electroless) 140°f	I	I	I	I	I	I	X	I	I	I	E	E	I	E	X	E
- copper acid fluoborate bath 120°f	I	I	X	I	I	I	I	I	I	I	E	X	I	E	G	E
- copper acid sulfate bath r.t.	I	I	X	I	I	I	I	I	I	I	E	X	I	E	E	E
- copper cyanide rochelle salt bath 150°f	I	I	E	I	I	I	I	I	I	I	E	E	I	E	E	E
- copper cyanide high speed bath 180°f	I	I	E	I	I	I	I	I	I	I	E	E	I	E	E	E
- copper pyrophosphate 140°f	I	I	E	I	I	I	I	I	I	I	E	E	I	E	E	E
- gold acid 75°f	I	I	C	I	I	I	I	I	I	I	E	E	I	E	E	E
- gold cyanide 150°f	I	I	E	I	I	I	C	I	I	I	E	E	I	E	E	E
- gold neutral 75°f	I	I	C	I	I	I	I	I	I	I	E	E	I	E	E	E
- iron ferrous am. sulfate bath 150°f	I	I	C	I	I	I	I	I	I	I	E	X	I	E	E	E
- iron ferrous chloride bath 190°f	I	I	X	I	I	I	I	I	I	I	E	X	I	C	G	E
- iron ferrous sulfate bath 150°f	I	I	C	I	I	I	I	I	I	I	E	X	I	E	E	E
- iron fluoborate bath 145°f	I	I	X	I	I	I	I	I	I	I	E	X	I	E	G	E
- iron sulfamate 140°f	I	I	X	I	I	I	I	I	I	I	E	X	I	E	E	E
- iron sulfate-chloride bath 160°f	I	I	X	I	I	I	I	I	I	I	E	X	I	E	G	E

* NOTE: The ratings given for BUNA N and VITON rubber are based on their use as seals in couplings. For Chemical Resistance of Hose components refer to the tables in our Hose Catalog.

CHEMICAL RESISTANCE CHART

	302SS	304SS	316SS	440SS	Acetyl	Aluminum	Cast Bronze	Brass	Cast iron	Carbon Steel	Teflon	Nylon	Polyethylene	Polypropylene	Buna N Seal *	Viton Seal *
- lead fluoborate	I	I	C	I	I	I	I	I	I	I	E	X	I	E	G	E
- nickel electroless 200°f	I	I	I	I	I	I	I	I	I	I	E	X	I	X	X	E
plating solutions:																
- nickel fluoborate 100-170°f	I	I	C	I	I	I	X	I	I	I	E	X	I	E	G	E
- nickel high chloride 130-160°f	I	I	C	I	I	I	I	I	I	I	E	X	I	E	E	E
- nickel sulfamate 100-140°f	I	I	C	I	I	I	I	I	I	I	E	E	I	E	E	E
- nickel watts type 115-160°f	I	I	C	I	I	I	I	I	I	I	E	E	I	E	E	E
- rhodium plating 120°f	I	I	X	I	I	I	I	I	I	I	E	X	I	E	E	E
- silver plating 80-120°f	I	I	E	I	I	I	I	I	I	I	E	E	I	E	E	E
- tine-lead plating 100°f	I	I	C	I	I	I	I	I	I	I	E	X	I	E	G	E
- tin-fluoborate plating 100°f	I	I	C	I	I	I	I	I	I	I	E	X	I	E	G	E
- zinc acid chloride 140°f	I	I	X	I	I	I	I	I	I	I	E	X	I	E	E	E
- zinc acid fluoborate bath r.t.	I	I	I	C	I	I	I	I	I	I	E	X	I	E	G	E
- zinc acid sulfate bath 150°f	I	I	C	I	I	I	I	I	I	I	E	X	I	E	E	E
- zinc alkaline cyanide bath r.t.	I	I	I	E	I	I	I	I	I	I	E	E	I	E	E	E
potash	I	E	I	E	I	C	C	I	G	I	I	E	G	E	E	E
potassium bicarbonate	I	E	I	G	I	C	G	I	X	I	E	E	G	E	E	E
potassium bromide	E	E	I	G	I	C	C	I	X	X	E	C	G	E	E	E
potassium carbonate	G	E	I	E	I	C	C	I	G	G	E	E	G	E	G	E
potassium chlorate	G	E	E	E	I	G	G	I	G	G	E	X	G	E	E	E
potassium chloride	C	E	E	G	I	G	C	C	G	G	E	G	G	E	E	E
potassium chromate	I	I	G	G	I	E	E	I	E	I	I	I	G	I	E	E
potassium cyanide solutions	G	E	G	E	I	X	X	I	G	G	E	E	G	E	E	G
potassium dichromate	G	E	E	E	I	E	C	I	G	C	E	X	G	E	E	G
potassium ferrocyanide	G	E	I	E	I	C	E	I	I	C	E	E	E	I	X	I
potassium hydroxide (50%)	E	G	G	G	I	X	X	X	C	E	E	E	G	E	G	X
potassium nitrate	G	E	G	E	I	G	G	I	I	G	E	C	G	E	E	G
potassium permanganate	G	E	G	G	I	G	G	I	G	G	E	X	G	G	E	G
potassium sulfate	G	E	G	G	I	E	G	G	G	G	E	C	G	E	E	E
potassium sulfide	E	E	I	E	I	G	G	I	G	G	E	I	I	I	E	I
propane (liquified)	E	E	I	E	X	E	E	E	I	G	E	E	I	X	E	E
propyl alcohol	I	E	E	I	I	E	E	I	I	E	E	E	I	E	E	E
propylene glycol	G	G	I	E	I	E	G	I	G	G	E	G	G	I	E	E
pyridine	I	C	I	G	X	G	I	I	G	E	E	I	C	G	X	X
pyrogalllic acid	G	E	E	E	I	G	G	I	G	G	E	E	I	I	E	E
rape seed oil	I	E	E	I	I	I	E	I	I	I	I	I	I	I	G	E
rosins	E	E	E	E	I	E	E	C	I	C	E	E	I	E	E	I
sea water	E	E	C	E	E	C	C	I	I	X	E	E	G	E	E	E
shellac (bleached)	E	E	I	E	I	E	E	G	G	E	E	E	I	E	E	I
shellac (orange)	E	E	I	E	I	E	E	C	C	E	E	E	I	E	E	I
silicone	I	G	I	E	I	G	E	I	I	I	I	E	I	E	E	E
silicone oil	I	E	E	I	I	I	E	I	E	I	I	E	I	E	E	E
silver bromide	I	C	C	G	I	X	I	I	I	I	I	I	I	I	I	I
silver nitrate	G	E	G	E	G	X	X	I	X	X	E	E	G	E	C	E
soap solutions	E	E	C	E	E	G	E	I	G	G	E	E	E	E	I	G
sodium acetate	G	E	E	G	I	G	G	I	C	C	E	E	G	E	X	X
sodium aluminat	G	I	I	E	I	C	G	I	I	C	E	E	I	I	E	E
sodium bicarbonate	G	E	E	E	I	E	G	E	C	C	E	E	G	E	E	E
sodium bisulfate	E	E	I	E	X	X	C	C	X	X	E	C	G	E	E	G
sodium bisulfite	I	I	I	I	X	X	X	G	X	X	E	E	G	E	E	E
sodium borate	G	E	I	E	E	C	E	I	C	C	E	E	E	I	I	E
sodium carbonate (soda ash)	G	E	G	G	I	C	G	G	G	G	E	E	G	E	E	E
sodium chlorate	G	E	I	E	I	G	G	I	I	C	E	E	G	E	X	E
sodium chloride	G	E	C	G	E	C	G	C	G	C	E	E	G	E	E	E
sodium chromate	E	E	E	I	I	X	G	I	G	G	E	E	I	E	E	G
sodium cyanide	G	E	I	E	C	X	X	X	G	G	E	C	G	E	E	E
sodium fluoride	G	C	I	C	I	C	C	I	X	X	E	E	C	I	X	G
sodium hydrosulfite	I	I	I	I	I	E	C	I	I	I	E	E	I	I	I	E
sodium hydroxide (20%)	I	E	E	E	C	X	C	X	E	I	E	C	G	E	E	E
sodium hydroxide (50% solution)	I	E	G	I	C	X	C	X	G	I	E	C	C	E	X	E
sodium hydroxide (80% solution)	I	E	X	I	C	X	C	X	C	I	E	C	C	E	X	G
sodium hypochlorite	X	I	E	I	I	X	X	I	X	X	E	E	I	E	G	G
sodium hypochlorite (to 20%)	I	C	C	C	I	C	X	X	X	I	E	E	G	X	C	E
sodium hyposulfate	I	E	E	I	I	X	X	I	I	I	E	I	I	I	I	I
sodium metaphosphate	E	I	E	I	I	E	C	C	G	G	E	E	I	X	E	E
sodium metasilicate	E	I	E	I	I	G	G	I	C	C	E	I	I	I	E	E

* NOTE: The ratings given for BUNA N and VITON rubber are based on their use as seals in couplings. For Chemical Resistance of Hose components refer to the tables in our Hose Catalog.

CHEMICAL RESISTANCE CHART

	302SS	304SS	316SS	440SS	Acryel	Aluminum	Cast Bronze	Brass	Cast iron	Carbon Steel	Teflon	Nylon	Polyethylene	Polypropylene	Buna N Seal *	Viton Seal *
sodium nitrate	G	E	E	E	I	E	G	C	E	G	E	E	G	E	C	X
sodium perborate	G	I	C	I	I	G	C	C	G	G	E	E	I	E	G	E
sodium peroxide	G	E	E	I	I	C	C	C	X	C	E	X	I	I	C	E
sodium polyphosphate (mono, di, tribasic)	I	E	E	I	I	X	C	I	I	I	E	I	I	I	E	E
sodium silicate	G	E	G	E	I	C	C	C	I	G	E	E	I	E	E	E
sodium sulfate	G	E	E	C	I	G	G	G	E	G	E	E	G	E	E	E
sodium sulfide	G	E	G	I	I	X	X	X	E	G	E	E	G	E	C	E
sodium sulfide	I	C	C	I	I	C	C	I	E	I	E	X	E	I	E	E
sodium tetraborate	I	I	E	I	I	I	I	I	I	I	I	I	I	I	E	E
sodium thiosulphate (hypo)	E	E	E	I	I	G	X	X	C	G	E	E	I	E	G	E
sorghum	I	E	E	I	I	I	I	I	E	I	I	E	I	I	E	E
soy sauce	I	E	E	I	I	E	E	I	X	I	I	E	I	I	E	E
soybean oil	I	E	E	I	I	E	G	I	E	I	I	E	I	E	E	E
stannic chloride	X	X	X	I	I	X	X	I	X	X	E	E	G	E	E	E
stannic fluoborate	I	I	E	I	I	I	I	I	X	I	I	I	I	I	E	E
stannous chloride	X	X	C	I	I	X	X	I	X	X	E	X	E	I	C	G
starch	G	E	E	I	I	E	G	I	C	C	E	E	G	I	E	E
stearic acid	G	E	E	E	G	G	C	C	C	E	E	E	G	X	G	E
stoddard solvent	E	E	E	E	I	E	E	E	G	G	E	E	X	X	G	E
styrene	E	E	E	I	I	E	E	I	I	E	E	I	I	I	X	G
sugar (liquids)	E	E	E	E	I	E	E	I	G	G	E	E	I	E	E	E
sulfate liquors	I	C	C	I	I	G	C	I	I	I	I	I	I	E	I	I
sulfur chloride	I	X	X	X	X	X	C	X	I	I	E	E	E	X	X	E
sulfur dioxide	I	E	E	C	X	E	G	I	I	I	E	X	C	X	X	X
sulfur dioxide (dry)	E	E	E	I	I	E	E	C	E	G	E	E	X	I	I	X
sulfur trioxide (dry)	E	E	E	C	I	E	G	I	G	G	E	X	I	I	X	E
sulfuric acid (to 10%)	I	X	C	C	I	C	X	X	X	I	E	X	G	E	C	E
sulfuric acid 10%-75%	I	X	X	X	I	X	X	X	X	I	E	X	C	E	X	E
sulfuric acid 75%-100%	I	I	X	I	X	I	I	X	I	I	E	X	I	G	X	E
sulfurous acid	C	C	G	C	X	C	X	I	X	X	E	X	G	E	C	E
sulfuryl chloride	I	I	I	I	I	I	I	I	I	I	E	I	I	I	I	I
syrup	I	E	E	E	I	E	X	I	I	I	I	E	I	E	E	E
tallow	I	E	E	I	I	E	I	I	I	I	I	E	C	I	E	E
tannic acid	G	E	E	E	G	C	G	I	C	C	E	X	G	E	X	E
tanning liquors	I	E	E	I	I	C	E	I	I	I	E	I	I	E	C	E
tartaric acid	G	E	G	G	X	C	E	C	X	X	E	E	G	E	X	E
tetrachlorethane	I	I	E	I	I	I	I	I	I	I	E	E	I	E	X	E
tetrahydrofuran	I	E	E	I	I	X	X	I	X	E	E	E	X	C	X	X
toluene, toluol	E	E	E	I	X	E	E	E	E	E	E	E	X	X	X	C
tomato juice	E	E	E	I	I	E	C	I	C	C	E	E	I	E	E	E
trichlorethane	I	C	E	I	X	C	C	I	C	I	E	I	I	I	X	E
trichlorethylene	G	E	E	I	I	G	G	E	C	G	E	C	X	X	X	E
trichloropropane	I	I	E	I	I	I	E	I	I	I	I	I	I	I	E	E
tricresylphosphate	I	I	E	I	I	I	E	I	I	I	E	I	I	I	X	G
triethylamine	I	I	I	I	I	I	E	I	I	I	I	I	I	I	E	E
turbine oil	I	E	E	I	I	E	E	I	E	I	I	I	I	I	E	E
turpentine	G	E	E	I	G	C	G	C	G	G	E	E	X	G	X	E
varnish	E	E	E	E	G	E	E	G	I	C	E	E	I	E	G	E
vegetable juice	I	E	E	I	I	E	C	I	X	I	I	E	I	I	E	E
vinegar	E	E	E	E	G	X	G	G	C	X	E	E	G	C	E	E
water, acid, mine	I	E	E	I	I	C	C	X	C	I	I	E	I	E	E	E
water, distilled, lab grade 7	I	E	E	I	I	G	E	I	X	I	E	E	I	E	E	E
water, fresh	E	E	E	I	I	E	E	C	G	I	E	E	X	E	E	E
water, salt	I	E	E	I	I	G	G	C	X	I	I	E	I	E	E	E
weed killers	I	E	E	I	I	C	C	I	I	I	I	E	I	I	G	E
whey	I	E	E	I	I	G	I	I	I	I	I	I	I	I	E	E
whiskey & wines	E	E	E	E	I	X	G	G	X	X	E	E	G	E	E	E
white liquor (pulp mill)	I	E	E	I	I	I	X	I	C	I	E	E	I	E	E	E
white water (paper mill)	I	E	E	I	I	I	E	I	I	I	I	E	I	E	I	E
xylene	E	E	E	I	X	E	E	E	E	G	E	E	X	X	X	E
zinc chloride	X	X	G	G	X	X	X	X	X	X	E	E	G	E	E	E
zinc hydrosulphite	I	I	E	I	I	X	X	I	X	I	I	I	I	I	E	I
zinc sulfate	G	E	E	E	I	X	G	C	C	X	E	E	G	E	E	E

* NOTE: The ratings given for BUNA N and VITON rubber are based on their use as seals in couplings. For Chemical Resistance of Hose components refer to the tables in our Hose Catalog.

NUMERICAL INDEX

Part No.	Page	Part No.	Page	Part No.	Page	Part No.	Page	Part No.	Page	Part No.	Page
0314	59	B30	34	C66	34	CST-GHTB	37	G0898V	115	G16T66B	67
100	130	B32	34	C7	32	CST-KEW	37	G08T86B	67	G16T88B	67
101	130	B32E	34	C701	44	CST-WB	37	G08T88B	67,68	G17	30
104	130	B33	34	C701BOP	47	CT	135	G08T88G	112	G1708B	61
107	130	B33E	34	C701H	45	CTB	135	G08T88M	112	G1716B	61
108	130	B34	34	C701VEP	45	DKF	129	G08T88SS	118	G1717B	61
119	130	B35	34	C702	44	EKF	129	G08T88V	115	G17L	30
126	130	B36	34	C702BOP	46	F.B	128	G08X88B	67	G18	30
127	130	B37	34	C702CP	44	F.D	128	G08X88G	112	G18SL	30
150	130	C..D	128	C702H	45	G0008B	65	G08X88M	112	G18V	30
151	130	C-001	97	C702VEP	45	G0008MC	117	G10-12/34	135	G19DS	28
200	132	C1	32	C703	44	G0008SS	119	G10L	135	G19F	28
201	132	C10	32,33	C703FB	45	G0008XH	117	G10LM	135	G19N	28
202	132	C101	40	C703VEP	45	G0012	70	G10P	135	G19S	28
208	132	C101BOP	46	C704	44	G0012S	70	G10PG	135	G1SS	96
209	132	C102	40	C704CP	44	G0012SL	70	G10PH	135	G2	96
211	132	C102BOP	46	C704FB	45	G0014	68	G10PSS	135	G2000	64
221	132	C1-03	32	C704VEP	45	G0014F	68	G10PW	135	G2001	64
240	132	C108	40	C708	45	G0014L	68	G11	38,136	G2002	64
528	59	C111B	40	C708H	45	G0019FG	115	G11KIT	136	G2004	64
711	133	C112B	40	C708VEP	45	G0019MG	115	G1200	70	G2005	64
902	130	C1B	32	C709	45	G0019RG	115	G12PT	135	G2006	64
908	130	C2	32	C709H	45	G0202	71	G13BSPT	137	G2008	64
3404	130	C20	33	C709VEP	45	G0208	71	G13C	137	G2012	64
3406	130	C20SS	33	C711	45	G0216	71	G13CHD	137	G2014	64
3408	130	C201	41	C712	45	G0246	71	G13KIT	137	G2015	64
50502	59	C201VV	41	C718	45	G0296	71	G13M	137	G2016	64
64008	57	C202	41	C719	45	G0298	71	G13NPT	137	G20B	19,62
74008	57	C202VV	41	C791	45	G02T00	71	G13PC	137	G20B90	62
74016	57	C208	41	C792	45	G02T06	71	G13UNF	137	G20BT	62
11-208	132	C208D	41	C8	32	G0400	68	G1400	68	G20M	19
0898XHD	131	C208VV	41	C801	46	G0404	68	G1408	69	G20N	19,83
1608GR	137	C209	41	C802	46	G0404SW	68	G1412	68	G20N90	83
1648GR	137	C209VV	41	C9	32,33	G0414	68	G1414	69	G20NT	84
1698GR	137	C20B	33	CH20	31	G0416	68	G1416	69	G20NTM	84
2000L	18	C21	33	CH21	31	G0700B	61	G1446	69	G20S	19
2002-H-HN	131	C21B	33	CH25	31	G0707BSW	61	G1494	69	G20SS	19
203VST	132	C21SS	33	CH26	31	G0708B	61	G1496	69	G20SL	19
204-30A	132	C25	33	CH29	31	G0708BSW	61	G1498	68	G21B	62
20PF	36	C26	33	CH30	31	G0716B	61	G14C	137	G21B45	62
20PH	36	C27	35	CH37	31	G0716BS	61	G14NPT	137	G21B90	62
20PM	36	C28	35	CH38	31	G0716SX	59	G14T44	70	G21BLM	62
20SF	36	C2B	32	CH60	31	G07Y77B	60	G14T46	70	G21BRI	62
20SH	36	C301	42	CH61	31	G07Y77BV	60	G14T64	70	G21BRS	62
20SM	36	C301F	42	CM2F	37	G07Y77PVG	60	G14X44	70	G21C	15
2500L	18	C302	42	CM2M	37	G07Y77Z	60	G15L	30	G21CRLM	15
2CMF1	37	C308	42	CM4F	37	G07Y77ZV	60	G16	30	G21N	83
30PF	36	C309	42	CM4M	37	G0800B	65	G1600B	65	G21N90	84
30PH	36	C35	35	CP1	32	G0800G	113	G1600EM	133	G21SAE	63
30PM	36	C36	35	CP10	32	G0800M	113	G1600G	113	G21SS	119
30SF	36	C37	35	CP17	33	G0800SS	118	G1600HB	65	G21TVB	130
30SH	36	C37B	35	CP18	33	G0808A	117	G1600M	113	G21XS	130
30SM	36	C38	35	CP1B	32	G0808B	35,37	G1600N	85	G21Z	15
400PF	36	C38B	35	CP2	32	G0808BBH	65	G1600N	85	G22B	63
400PH	36	C400C	43	CP20	33	G0808BBHS	65	G1600SB	65	G22BFS	63
400PM	36	C401	42	CP20B	33	G0808BH	65	G1600SLB	65	G22N	83
400SF	36	C402	42	CP20SS	33	G0808BHL	65	G1600SS	118	G22N	83
400SH	36	C403	42	CP21	33	G0808BHV	17	G1600VB	133	G22SAE	63
400SM	36	C404	42	CP21B	33	G0808G	110	G1601TV	131	G22TVB	130
40PF	36	C405	43	CP21SS	33	G0808G	110	G1601TVL	131	G23C	27
40PH	36	C406	43	CP25	33	G0808GU	112	G1608B	66	G23S	27
40PM	36	C406MR	43	CP26	33	G0808HLLU	116	G1608XA	18	G23SSX	67
40R	130	C408R	43	CP27	35	G0808M	110	G1608XAU	18	G25	28,29
40SF	36	C409R	43	CP28	35	G0808MC	117	G1608XB	130	G25B	29
40SH	36	C5	32	CP2B	32	G0808MU	112	G1608XSS	130	G26	29
40SM	36	C501	43	CP35	35	G0808PBH	85	G1616	107	G26B	29
4CMF4	37	C501BOP	47	CP36	35	G0808SS	118	G1616B	66	G27	28,29
4CMM4	37	C501H	44	CP37	35	G0808SSU	118	G1616BC	66	G27B	29
500AV	18	C502	43	CP38	35	G0808XH	117	G1616BL	66	G28	28,29
525AV	18	C502BOP	43	CP5	32	G0816B	65,67	G1616G	108	G28C	29
571TFRL	59	C502H	44	CP6	32	G0816BH	65	G1616PC	109	G28L	29
572TFRL	59	C508	43	CP6	32	G0816G	111	G1616S80	109	G28P	29
600PF	36	C508H	44	CP60	34	G0816G	111	G1616SS	119	G28SC	29
600PH	36	C509	43	CP61	34	G0816M	111	G1616SW	109	G28SP	29
600PM	36	C509H	44	CP632	39	G0816N	85	G1616V	115	G28Y	29
600SF	36	C6	32	CP632HP	39	G0816SS	118	G1619AB	64	G2908N	26,27
600SH	36	C60	34	CP632HPM	39	G0819M	113	G1648B	66,68	G29C	27,87
600SM	36	C601	44	CP632M	39	G0819RF	113	G1648G	111	G29CR	27,87
800PF	36	C602	44	CP65	34	G0819V	114	G1648M	111	G29DS	26
800PH	36	C61	34	CP66	34	G0848B	66,67	G1648M	111	G29F	26
800PM	36	C632	39	CP7	32	G0848G	111	G1696B	66	G29M	26
800SF	36	C632HP	39	CP8	32	G0848M	111	G1698B	67,68	G29N	26
800SH	36	C632HPBV	39	CP9	32	G0848SS	118	G1698G	111	G29N	26
800SM	36	C638	39	CP9	32	G0848V	115	G1698M	111	G29R	28
AKF	129	C639	39	CPST	38	G0898B	66,65	G1698SS	118	G29S	26
AS	134	C65	34	CPST-GHTB	37	G0898G	110	G1698XA	130	G29SC	26
				CPST-WB	37	G0898M	110	G1698XB	130	G29SH	28
				CST	38	G0898SS	118	G16L	30	G29WS	28

NUMERICAL INDEX

Part No.	Page	Part No.	Page	Part No.	Page	Part No.	Page	Part No.	Page	Part No.	Page
G3	98	G38	86	G61	15	G65SSDC	10	G80F	50	ID101	134
G3A	97	G38-GL	134	G61C	15	G65SSDD	11	G80M	50	J	96
G3F	97	G38V	114	G61CX	15	G65SSDP	10	G80WT	49	J-001	96
G3LS	97	G38VR	21	G6100	72	G65SSE	10	G81	14	L..L	129
G3S	98	G38W	86	G6100P	82	G65SSF	10	G81BAT	52	L-30	130
G3SS	98	G39	92	G6103	72	G65SSLB	12	G81BZF	52	MBR	133
G3SSF	98	G4	63	G62	15	G65SSLC	12	G81CSA	52	MEGR	131
G30G	21	G40L	63	G63	15	G65SSLD	12	G81FL	14	Model 80	131
G30NK	56	G40R	63	G63C	15	G65SSLDC	12	G81FLSS	14	OILPAD	133
G31	22	G41L	63	G6300	79	G65SST	13	G81FM	52	P..B	128
G31B	22,53	G41R	63	G6300LC	80	G65SSY	13	G81MM	52	P-1	95
G31BAT	51	G42	63	G6300MC	80	G65SSZ	13	G81NS1	52	P-1000	95
G31BLS	21	G4300	74	G6304	79	G65ST	13	G81QMT	52	P-38	95
G31BNST	53	G4316	74	G6308	79	G65THX	13	G81SM	52	PC	95
G32	22	G4316G	74	G6316	78	G65VS	13	G81SS	14	PCO	96
G32B	22,53	G4330	74	G6361	79	G65VX	13	G81WCT	52	PG	125
G32BAT	51	G4331	74	G6363	79	G65X	13	G81V	14	PGB	125
G32BLS	21	G4331G	74	G6363BH	79	G65Y	13	G82	14	PGD	125
G32BNST	53	G4332	74	G6363CV	79	G6603	79	G82BAT	52	PGP	126
G32NK	56	G4333	74	G6393	79	G6616	78	G82CSA	52	PGSS	126
G33	20	G4334	74	G6396	78	G6621	79	G82NS1	52	PL	128
G33A	15,20	G43L	63	G6396X	78	G66LB	6	G82QMT	52	PRV	106
G33B	20	G43R	63	G63T16X	78	G66LC	6	G82WCT	52	PW	57,58
G33C	21	G45F	30	G63T33	79	G66LD	6	G83	14	QKF	129
G33G	20	G45M	30	G63T63X	78	G66LDC	6	G84	48	R..R	128
G33N	20,84	G46F	30	G64C	5	G67	16	G84A	48	RG-1002-BK	132
G33SS	20,119	G46M	30	G64E	5	G67P	16	G84C	48	S-150	59
G33SSC	21	G47F	30	G64SSC	11	G67PB	16	G84E	48	SB	97
G33V	20	G47M	30	G64SSE	11	G68	16	G84NK	48	SC	97
G33VG	21	G48	30	G65A	3,4	G68A	16	G84SZ	48	TG	126
G33VLG	21	G5	89	G65AA	5	G68AUL	16	G84U	48	TK-M	131
G33W	21	G5090BW	121	G65AFL	6	G69	17	G85	49	TPG	133
G34	23	G50TBW	121	G65B	3,4	G6HD	99	G85B	49	TSG	133
G34EFV	22	G53	120	G65BRA	9	G6N	99	G86	49	UCS	133
G34F	23	G5343	122	G65BRB	9	G6T	700	G86N	49	V10	61,104
G34FV	22	G5393	122	G65BRC	9	G7	88	G87	49	V12	105
G34FVB	22	G5353C	122	G65BRD	9	G7A	93	G87N	49	V14	105
G34FVL	22	G5353E	122	G65BRDC	9	G7000	86	G87S	49	V16	105,106
G34FVS	22	G53C	120	G65BRDP	9	G7001	86	G87WT	49	V18	104
G34L	23	G53CAP	122	G65BRE	9	G7008	86	G88	49	V201	101
G34P	23	G53CB	120	G65BRF	9	G7008P	75	G88C	49	V201PVC	106
G34SK	23	G53CSN	120	G65C	3,4	G7016	76	G88R	50	V202	101
G34SQ	23	G53F	122	G53CAP	126	G7016P	75	G89	92	V202L	101
G35FC	24	G53G	120	G65CA	5	G7046	76	G8L	90	V202LB	101
G35FFL	25	G53GS	120	G65CA90	5	G7046P	75	G8M	88	V203	102
G35FFLA	25	G53L	120	G65CV	6	G7070	76	G9	134	V205	102
G35FH	24	G53M	122	G65D	3,4	G7070P	75	G91JM	53	V207	102
G35FHA	25	G53S	120	G65DC	4	G7070PBH	75	G91MC	53	V215L	106
G35FP	25	G53T	122	G65DCL	6	G7090	73	G92	93	V215P	106
G35G	24	G53WL	121	G65DD	5	G7090P	75	G92JM	53	V302	101
G35GA	25	G53WS	121	G65DFL	6	G7096	76	G92MC	53	V302W	101
G35L	24	G53X	122	G65DP	4	G7096P	75	G92-RACK	89	V303	102
G35LA	25	G54	121	G65E	3,4	G7096PX	75	G94	93	V305	102
G35MC	24	G54G	121	G65F	3,4	G7098	76	G95	49	V306	102
G35MF	25	G54GT	121	G65LC	6	G7098P	75	G95NK	53	V307	102
G35MFL	25	G54N	121	G65LD	6	G70T00	73	G95SZ	53	V308	102
G35MFLA	25	G59	121	G65LDC	6	G70T00P	75	G97	48	V401	103
G35MH	24	G5A	91	G65LY	13	G70T06	73	G97B	48	V402	103
G35MHA	25	G5AB	91	G65NA	7	G70T06PX	75	G97B-GHT	48,59	V412	103
G35MP	25	G5AM	91	G65NB	7	G70T60	77	G97G	48	V432	103
G35SC	24	G5A-RACK	89	G65NC	7	G70T60PX	75	G97-GHT	48,59	V53PH	103
G36BFH	60	G5M	90	G65ND	7	G7103	76	G97JM	54	V53TH	103
G36BLF	60	G6	99	G65NDC	7	G72	123	G97MC	54	V601	103
G36BLM	60	G6T	100	G65NDP	7	G72B	123	G97NK	54	V605	103
G36BM	60	G6000	72	G65NE	7	G72M	123	G97SZ	54	V610	104
G36NF	84	G6001	72	G65NF	7	G73H	124	G98JM	56	V611	104
G36NM	84	G6008	72	G65PA	8	G73NPT	124	G98JMA	54	V611M	104
G36RG	60	G6008P	81	G65PB	8	G73V	124	G98JMC	55	V63AW	80
G36SG	60	G6016	72	G65PC	8	G75	123	G98MC	56	V6406	80
G36VG	60	G6016N	85	G65PD	8	G75B	123	G98MCA	54	V6416W	80
G37	48	G6016P	81	G65PDC	8	G77	123	G98NHC	55	V6498W	80
G37-GHT	48,59	G6046	73	G65PDP	8	G77B	123	G98NHHP	55	V64V	80
G37AB-GHT	59	G6060	72	G65PE	8	G78	123	G98NK	56	V803	106
G37JM	55	G6060P	81	G65PF	8	G79	124	G98NKA	54	V825	106
G37MC	55	G6090	72	G65R	13	G79G	124	G98NKC	55	V853	106
G37M-GHT	58	G6090P	81	G65SBDC	12	G79M	124	G98NPSHA	54	XP100	132
G37NK	55	G6096	73	G65SBDP	12	G7A	90	G98NSTA	54		
G37NST	55	G6096N	85	G65SBY	12	G7ET	90	G98SZ	56		
G37P	48	G6096P	81	G65SC	13	G7ETM	90	G98SZA	54		
G37SZ	55	G6098	73	G65SL	12	G7M	88	G98SZC	55		
G37T	54	G60T00	73	G65SSA	10	G7RACK	85	G99	133		
G37TJM	54	G60T00P	82	G65SSAA	11	G8	88	G99B	133		
G37TMC	54	G60T06	73	G65SSB	10	G80	50	G99TSNIP	133		
G37TNK	54	G60T06P	82	G65SSC	10	G80B	50	GBIN	133		
G37TNST	54	G60T60	73	G65SSCA	11	G80BF	50	HB	133		
G37TSZ	54	G60T60P	82	G65SSD	10	G80BM	50	HH	133		