

Gallery SH-4834

Model number:

105596

Dimensions: 48" x 34" x 75"

Installation: Alcove

Material: AcrylX™ Ap-



Standard Features:

- 2-piece unit with center drain and textured bottom
- Unique MAAX PIN system for easy front installation
- Low 3" threshold base allowing an easy and safe access
- Large right or left built-in seat for added comfort
- Large two level corner shelves
- Knock-down packaging offers optimal

Product characteristics:

- Multi-Piece Unit
- Easy Installation
- Low Threshold

Warranty:

Lifetime limited

Standard colors:



White (002)



Bone (004)



Biscuit (007)

Certifications

MAAX products adhere to one or more of the following certifications:



Recommended doors (Visit our website for a complete list of our recommended doors)

No	Description
135663	Aura Sliding Shower Door 43-47 x 71 in. 6 mm
135671	Aura Sliding Shower Door 43-47 x 71 in. 8 mm
135674	Aura SC Sliding Shower Door 43-47 x 71 in. 8mm

Options (Visit our website for a complete list of our options)

No	Description
<input type="checkbox"/> OPT 10189	All walls reinforced
<input type="checkbox"/> OPT 20203-B	18" Modern straight horizontal grab bar on back wall
<input type="checkbox"/> OPT 20203-L	18" Modern straight vertical grab bar on left wall
<input type="checkbox"/> OPT 20203-R	18" Modern straight vertical grab bar on right wall
<input type="checkbox"/> OPT 20204-B	24" Modern straight horizontal grab bar on back wall

Gallery SH-4834

Model number:

105596

Dimensions: 48" x 34" x 75"

Installation: Alcove

Material: AcrylX™ Ap-

1

Dimensions:

47 7/8 x 34 x 75 in.
(1219 x 864 x 1905 mm)

Weight:

131 lbs - 59 kg

Shape:

Rectangular

Pieces:

2

Drain location:

Left seat, center drain

Right seat, center drain

STANDARD

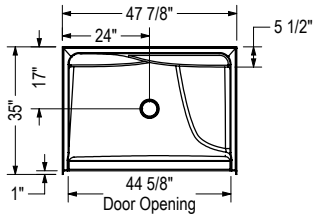

BASE ONLY

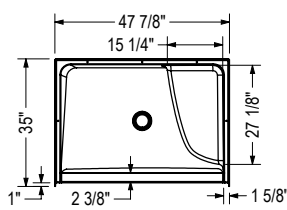

REINFORCEMENT BACKING

OPT 10189 (Left shown, Right symmetrical)

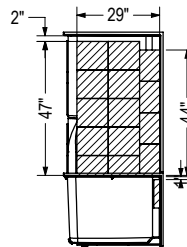

OPT 10189 (Back shown)

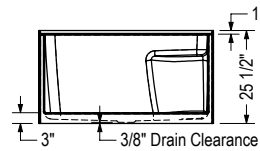
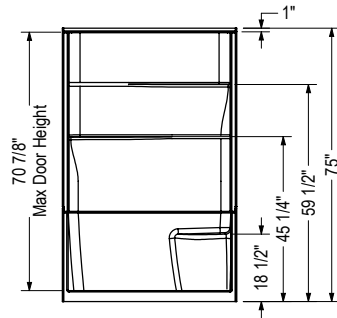
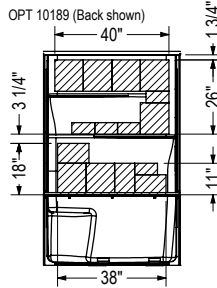

GRAB BAR

OPTION 20203-20204

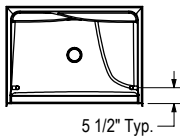

OPTION 20203

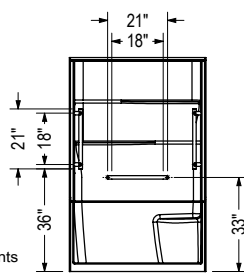

OPTION 20204

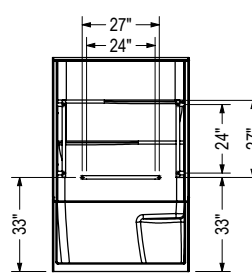

All dimensions are approximate. Structure measurements must be verified against the unit to ensure proper fit.

Project:

Contractor:

Representative:

Date:

Tel:

Notes: