

MAAX SUBMITTAL SPECIFICATIONS

Tandem II 6060

MODEL NUMBER 100054

DIMENSIONS: 60" x 60" x 19" Acrylic

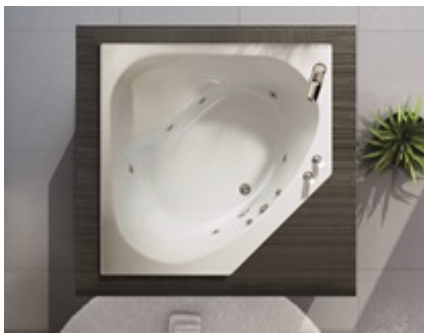

STANDARD FEATURES

- Corner shape bathtub
- Drop-in or corner installation (optional nailing flange available)
- Textured floor
- Center drain
- Apron available
- Tiling flange available



OPTIONS

- One-piece acrylic apron
- Nailing flange
- One chromatherapy light
- Metal trim kit for whirlpool and combined systems
- Water heater assembly (factory installed)
- One 6-in. acrylic grab bar

UNIQUE FEATURES

- None

SYSTEMS

-  MAAX Professional Whirlpool
-  Aeroeffect **DOOR**
-  Combined Whirlpool/Aeroeffect

SELECTION

Combine with MAAX's complete shower door offering visit www.maax.com

CERTIFICATIONS

Maax products adhere to one or more of the following certifications:



Project :

Contractor :

MAAX Representative : Tel :

Date :

MAAX SUBMITTAL SPECIFICATIONS

Tandem II 6060

MODEL NUMBER 100054

TECHNICAL DRAWINGS

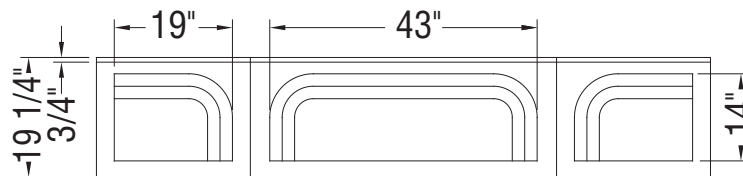
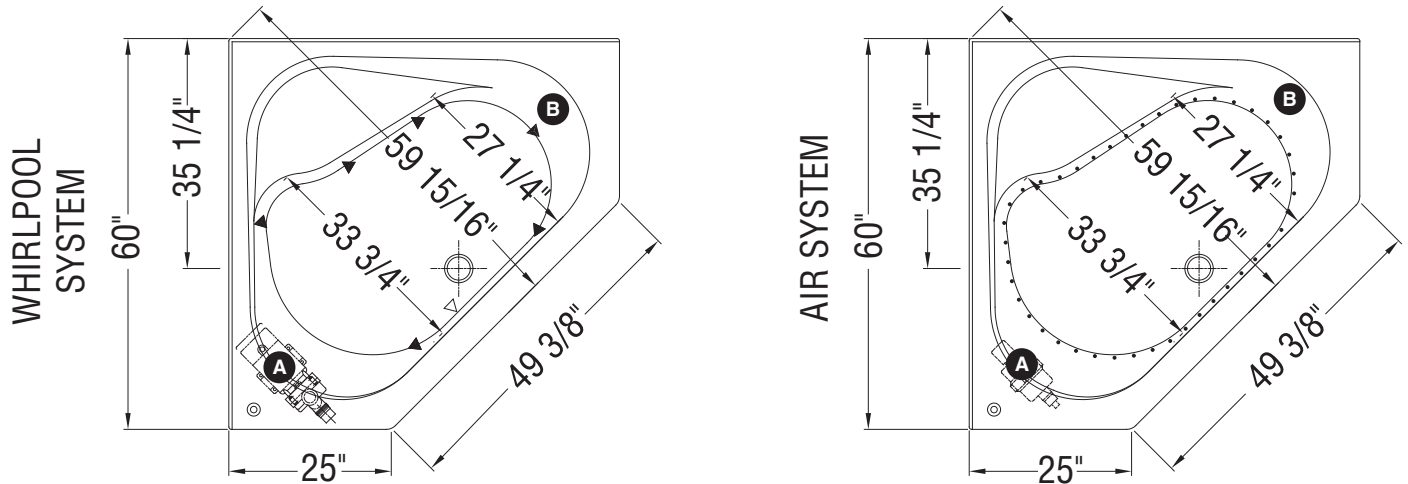

Note: In front view, skirt is shown flat.

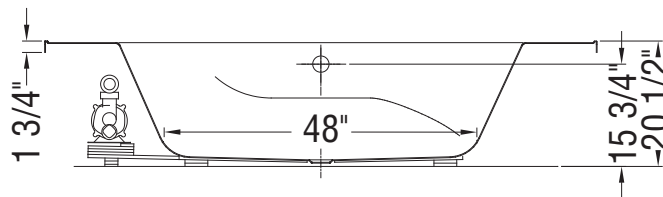

- (A) : Standard blower and/or pump location
- (B) : Optional blower and/or pump location
- (▲) : Indicates Whirlpool jets positioning
- (●) : Indicates airjets positioning
- (△) : Indicates suction positioning

All dimensions are approximate. Structure measurements must be verified against the unit to ensure proper fit.