



Laboratory Products



Chicago Faucets Laboratory Products

Unparalleled Quality

Since 1901, Chicago Faucets has been the leading brand of commercial faucets and fixtures in the United States. Every one of our products is manufactured to the same high standard that has made us the choice of professionals in education, healthcare, research, public assembly, food service, hospitality, and commercial buildings all across the country.

Now, you can get the same unparalleled quality and support with our extensive offering of laboratory products. Like our commercial faucets, the components of our laboratory products are interchangeable. So, you can easily design a product to meet your unique needs. You also get a single source for all of your faucet needs – from the lab to the restroom, janitorial closet, cafeteria and more.

Table of Contents

| SECTION | TAB | PAGE |
|--------------------------------|-----------------------------------|---------|
| Laboratory Water | Laboratory Water Valves | 4-15 |
| | Laboratory Water Single Faucets | 16-35 |
| | Laboratory Water Mixing Faucets | 36-49 |
| | Laboratory General Faucets | 50-53 |
| | Foot Operated Pedal Valves | 54-55 |
| | Laboratory Electronic Faucets | 56-57 |
| | Laboratory Pre-Rinse Fittings | 58-59 |
| Laboratory Gas | Laboratory Gas Needle Valves | 60-71 |
| | Laboratory Gas Fine Needle Valves | 72-83 |
| | Laboratory Gas Ball Valves | 84-89 |
| Laboratory Pure Water | Laboratory Pure Water Faucets | 90-91 |
| Laboratory Steam | Laboratory Steam Valves | 92-97 |
| Combination Fittings | Laboratory Combination Fittings | 98-107 |
| Fume Hoods | Laboratory Remote Spouts | 108-113 |
| | Laboratory Remote Valves | 114-123 |
| Electrical Outlet Boxes | Boxes, Rods, Sockets, Clamps | 124-125 |
| Safety Products | Laboratory Safety Products | 126-127 |

How to build and order a Chicago Faucets laboratory water valve fitting.

Chicago Faucets makes it easy for you to build water valve fittings that meet your exact requirements. You can reference the charts on the following pages, or you can build your own valve by choosing the components below to configure your model number.



Valve Base

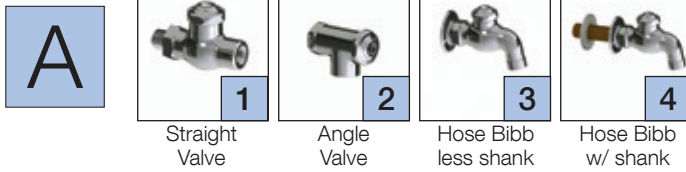

Cartridge

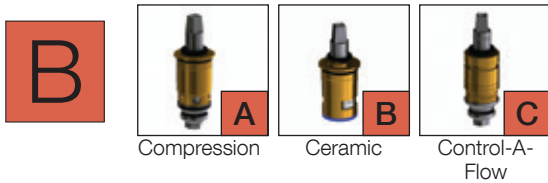

EXAMPLE



LWV1-A12-20
 Two straight valves with compression cartridges, straight nozzles, metal handles with hot index buttons, and a dual 90° turret.

Outlet

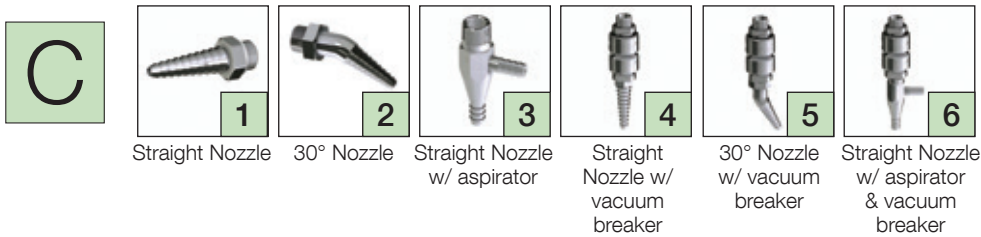

Handle

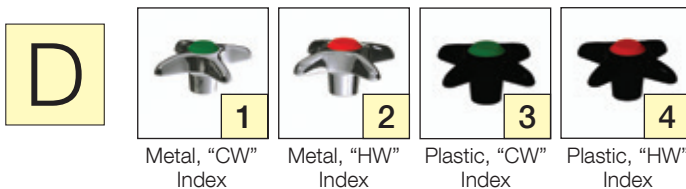

Turret



Straight Pattern Water Valve

- Solid brass straight valve body
- Polished chrome plated finish
- 2-1/2" vandal proof cross handle
- 3/8" - 18 NPT male thread inlet



Straight Nozzle

| Handle/Index | Vacuum Breaker | Compression Cartridge | Ceramic Cartridge | Control-A-Flow Cartridge |
|--------------|----------------|-----------------------|-------------------|--------------------------|
| Metal/Cold | - | LWV1-A11 | LWV1-B11 | LWV1-C11 |
| | • | LWV1-A41 | LWV1-B41 | LWV1-C41 |
| Metal/Hot | - | LWV1-A12 | LWV1-B12 | LWV1-C12 |
| | • | LWV1-A42 | LWV1-B42 | LWV1-C42 |
| Plastic/Cold | - | LWV1-A13 | LWV1-B13 | LWV1-C13 |
| | • | LWV1-A43 | LWV1-B43 | LWV1-C43 |
| Plastic/Hot | - | LWV1-A14 | LWV1-B14 | LWV1-C14 |
| | • | LWV1-A44 | LWV1-B44 | LWV1-C44 |

30° Nozzle

| Handle/Index | Vacuum Breaker | Compression Cartridge | Ceramic Cartridge | Control-A-Flow Cartridge |
|--------------|----------------|-----------------------|-------------------|--------------------------|
| Metal/Cold | - | LWV1-A21 | LWV1-B21 | LWV1-C21 |
| | • | LWV1-A51 | LWV1-B51 | LWV1-C51 |
| Metal/Hot | - | LWV1-A22 | LWV1-B22 | LWV1-C22 |
| | • | LWV1-A52 | LWV1-B52 | LWV1-C52 |
| Plastic/Cold | - | LWV1-A23 | LWV1-B23 | LWV1-C23 |
| | • | LWV1-A53 | LWV1-B53 | LWV1-C53 |
| Plastic/Hot | - | LWV1-A24 | LWV1-B24 | LWV1-C24 |
| | • | LWV1-A54 | LWV1-B54 | LWV1-C54 |

Straight Nozzle With Aspirator

| Handle/Index | Vacuum Breaker | Compression Cartridge | Ceramic Cartridge | Control-A-Flow Cartridge |
|--------------|----------------|-----------------------|-------------------|--------------------------|
| Metal/Cold | - | LWV1-A31 | LWV1-B31 | LWV1-C31 |
| | • | LWV1-A61 | LWV1-B61 | LWV1-C61 |
| Metal/Hot | - | LWV1-A32 | LWV1-B32 | LWV1-C32 |
| | • | LWV1-A62 | LWV1-B62 | LWV1-C62 |
| Plastic/Cold | - | LWV1-A33 | LWV1-B33 | LWV1-C33 |
| | • | LWV1-A63 | LWV1-B63 | LWV1-C63 |
| Plastic/Hot | - | LWV1-A34 | LWV1-B34 | LWV1-C34 |
| | • | LWV1-A64 | LWV1-B64 | LWV1-C64 |

Deck Mounted, Straight Pattern Single Water Valve Assembly

- Solid brass turret with one outlet
- Solid brass straight valve body
- Polished chrome plated finish
- 2-1/2" vandal proof cross handle
- 3/8" - 18 NPT male thread shank assembly



Straight Nozzle

| Handle/Index | Vacuum Breaker | Compression Cartridge | Ceramic Cartridge | Control-A-Flow Cartridge |
|--------------|----------------|-----------------------|-------------------|--------------------------|
| Metal/Cold | - | LWV1-A11-10 | LWV1-B11-10 | LWV1-C11-10 |
| | • | LWV1-A41-10 | LWV1-B41-10 | LWV1-C41-10 |
| Metal/Hot | - | LWV1-A12-10 | LWV1-B12-10 | LWV1-C12-10 |
| | • | LWV1-A42-10 | LWV1-B42-10 | LWV1-C42-10 |
| Plastic/Cold | - | LWV1-A13-10 | LWV1-B13-10 | LWV1-C13-10 |
| | • | LWV1-A43-10 | LWV1-B43-10 | LWV1-C43-10 |
| Plastic/Hot | - | LWV1-A14-10 | LWV1-B14-10 | LWV1-C14-10 |
| | • | LWV1-A44-10 | LWV1-B44-10 | LWV1-C44-10 |

30° Nozzle

| Handle/Index | Vacuum Breaker | Compression Cartridge | Ceramic Cartridge | Control-A-Flow Cartridge |
|--------------|----------------|-----------------------|-------------------|--------------------------|
| Metal/Cold | - | LWV1-A21-10 | LWV1-B21-10 | LWV1-C21-10 |
| | • | LWV1-A51-10 | LWV1-B51-10 | LWV1-C51-10 |
| Metal/Hot | - | LWV1-A22-10 | LWV1-B22-10 | LWV1-C22-10 |
| | • | LWV1-A52-10 | LWV1-B52-10 | LWV1-C52-10 |
| Plastic/Cold | - | LWV1-A23-10 | LWV1-B23-10 | LWV1-C23-10 |
| | • | LWV1-A53-10 | LWV1-B53-10 | LWV1-C53-10 |
| Plastic/Hot | - | LWV1-A24-10 | LWV1-B24-10 | LWV1-C24-10 |
| | • | LWV1-A54-10 | LWV1-B54-10 | LWV1-C54-10 |

Straight Nozzle With Aspirator

| Handle/Index | Vacuum Breaker | Compression Cartridge | Ceramic Cartridge | Control-A-Flow Cartridge |
|--------------|----------------|-----------------------|-------------------|--------------------------|
| Metal/Cold | - | LWV1-A31-10 | LWV1-B31-10 | LWV1-C31-10 |
| | • | LWV1-A61-10 | LWV1-B61-10 | LWV1-C61-10 |
| Metal/Hot | - | LWV1-A32-10 | LWV1-B32-10 | LWV1-C32-10 |
| | • | LWV1-A62-10 | LWV1-B62-10 | LWV1-C62-10 |
| Plastic/Cold | - | LWV1-A33-10 | LWV1-B33-10 | LWV1-C33-10 |
| | • | LWV1-A63-10 | LWV1-B63-10 | LWV1-C63-10 |
| Plastic/Hot | - | LWV1-A34-10 | LWV1-B34-10 | LWV1-C34-10 |
| | • | LWV1-A64-10 | LWV1-B64-10 | LWV1-C64-10 |

Deck Mounted, Straight Pattern Dual 90° Water Valve Assembly

- Solid brass turret with two 90° outlets
- Solid brass straight valve body
- Polished chrome plated finish
- 2-1/2" vandal proof cross handle
- 3/8" - 18 NPT male thread shank assembly



30° Nozzle

| Handle/ Index | Vacuum Breaker | Compression Cartridge | Ceramic Cartridge | Control-A-Flow Cartridge |
|------------------|-------------------|--------------------------|----------------------|-----------------------------|
| Metal/Cold | - | LWV1-A21-20 | LWV1-B21-20 | LWV1-C21-20 |
| | • | LWV1-A51-20 | LWV1-B51-20 | LWV1-C51-20 |
| Metal/Hot | - | LWV1-A22-20 | LWV1-B22-20 | LWV1-C42-20 |
| | • | LWV1-A52-20 | LWV1-B52-20 | LWV1-C52-20 |
| Plastic/Cold | - | LWV1-A23-20 | LWV1-B23-20 | LWV1-C23-20 |
| | • | LWV1-A53-20 | LWV1-B53-20 | LWV1-C53-20 |
| Plastic/Hot | - | LWV1-A24-20 | LWV1-B24-20 | LWV1-C24-20 |
| | • | LWV1-A54-20 | LWV1-B54-20 | LWV1-C54-20 |

Straight Nozzle

| Handle/ Index | Vacuum Breaker | Compression Cartridge | Ceramic Cartridge | Control-A-Flow Cartridge |
|------------------|-------------------|--------------------------|----------------------|-----------------------------|
| Metal/Cold | - | LWV1-A11-20 | LWV1-B11-20 | LWV1-C11-20 |
| | • | LWV1-A41-20 | LWV1-B41-20 | LWV1-C41-20 |
| Metal/Hot | - | LWV1-A12-20 | LWV1-B12-20 | LWV1-C12-20 |
| | • | LWV1-A42-20 | LWV1-B42-20 | LWV1-C42-20 |
| Plastic/Cold | - | LWV1-A13-20 | LWV1-B13-20 | LWV1-C13-20 |
| | • | LWV1-A43-20 | LWV1-B43-20 | LWV1-C43-20 |
| Plastic/Hot | - | LWV1-A14-20 | LWV1-B14-20 | LWV1-C14-20 |
| | • | LWV1-A44-20 | LWV1-B44-20 | LWV1-C44-20 |

Straight Nozzle With Aspirator

| Handle/ Index | Vacuum Breaker | Compression Cartridge | Ceramic Cartridge | Control-A-Flow Cartridge |
|------------------|-------------------|--------------------------|----------------------|-----------------------------|
| Metal/Cold | - | LWV1-A31-20 | LWV1-B31-20 | LWV1-C31-20 |
| | • | LWV1-A61-20 | LWV1-B61-20 | LWV1-C61-20 |
| Metal/Hot | - | LWV1-A32-20 | LWV1-B32-20 | LWV1-C32-20 |
| | • | LWV1-A62-20 | LWV1-B62-20 | LWV1-C62-20 |
| Plastic/Cold | - | LWV1-A33-20 | LWV1-B33-20 | LWV1-C33-20 |
| | • | LWV1-A63-20 | LWV1-B63-20 | LWV1-C63-20 |
| Plastic/Hot | - | LWV1-A34-20 | LWV1-B34-20 | LWV1-C34-20 |
| | • | LWV1-A64-20 | LWV1-B64-20 | LWV1-C64-20 |

Deck Mounted, Straight Pattern Dual 180° Water Valve Assembly

- Solid brass turret with two 180° outlets
- Solid brass straight valve body
- Polished chrome plated finish
- 2-1/2" vandal proof cross handle
- 3/8" - 18 NPT male thread shank assembly



30° Nozzle

| Handle/ Index | Vacuum Breaker | Compression Cartridge | Ceramic Cartridge | Control-A-Flow Cartridge |
|------------------|-------------------|--------------------------|----------------------|-----------------------------|
| Metal/Cold | - | LWV1-A21-25 | LWV1-B21-25 | LWV1-C21-25 |
| | • | LWV1-A51-25 | LWV1-B51-25 | LWV1-C51-25 |
| Metal/Hot | - | LWV1-A22-25 | LWV1-B22-25 | LWV1-C22-25 |
| | • | LWV1-A52-25 | LWV1-B52-25 | LWV1-C52-25 |
| Plastic/Cold | - | LWV1-A23-25 | LWV1-B23-25 | LWV1-C23-25 |
| | • | LWV1-A53-25 | LWV1-B53-25 | LWV1-C53-25 |
| Plastic/Hot | - | LWV1-A24-25 | LWV1-B24-25 | LWV1-C24-25 |
| | • | LWV1-A54-25 | LWV1-B54-25 | LWV1-C54-25 |

Straight Nozzle

| Handle/ Index | Vacuum Breaker | Compression Cartridge | Ceramic Cartridge | Control-A-Flow Cartridge |
|------------------|-------------------|--------------------------|----------------------|-----------------------------|
| Metal/Cold | - | LWV1-A11-25 | LWV1-B11-25 | LWV1-C11-25 |
| | • | LWV1-A41-25 | LWV1-B41-25 | LWV1-C41-25 |
| Metal/Hot | - | LWV1-A12-25 | LWV1-B12-25 | LWV1-C12-25 |
| | • | LWV1-A42-25 | LWV1-B42-25 | LWV1-C42-25 |
| Plastic/Cold | - | LWV1-A13-25 | LWV1-B13-25 | LWV1-C13-25 |
| | • | LWV1-A43-25 | LWV1-B43-25 | LWV1-C43-25 |
| Plastic/Hot | - | LWV1-A14-25 | LWV1-B14-25 | LWV1-C14-25 |
| | • | LWV1-A44-25 | LWV1-B44-25 | LWV1-C44-25 |

Straight Nozzle With Aspirator

| Handle/ Index | Vacuum Breaker | Compression Cartridge | Ceramic Cartridge | Control-A-Flow Cartridge |
|------------------|-------------------|--------------------------|----------------------|-----------------------------|
| Metal/Cold | - | LWV1-A31-25 | LWV1-B31-25 | LWV1-C31-25 |
| | • | LWV1-A61-25 | LWV1-B61-25 | LWV1-C61-25 |
| Metal/Hot | - | LWV1-A32-25 | LWV1-B32-25 | LWV1-C32-25 |
| | • | LWV1-A62-25 | LWV1-B62-25 | LWV1-C62-25 |
| Plastic/Cold | - | LWV1-A33-25 | LWV1-B33-25 | LWV1-C33-25 |
| | • | LWV1-A63-25 | LWV1-B63-25 | LWV1-C63-25 |
| Plastic/Hot | - | LWV1-A34-25 | LWV1-B34-25 | LWV1-C34-25 |
| | • | LWV1-A64-25 | LWV1-B64-25 | LWV1-C64-25 |

Deck Mounted, Straight Pattern Three Water Valve Assembly

- Solid brass turret with three outlets
- Solid brass straight valve body
- Polished chrome plated finish
- 2-1/2" vandal proof cross handle
- 3/8" - 18 NPT male thread shank assembly



30° Nozzle

| Handle/Index | Vacuum Breaker | Compression Cartridge | Ceramic Cartridge | Control-A-Flow Cartridge |
|--------------|----------------|-----------------------|-------------------|--------------------------|
| Metal/Cold | – | LWV1-A21-30 | LWV1-B21-30 | LWV1-C21-30 |
| | • | LWV1-A51-30 | LWV1-B51-30 | LWV1-C51-30 |
| Metal/Hot | – | LWV1-A22-30 | LWV1-B22-30 | LWV1-C22-30 |
| | • | LWV1-A52-30 | LWV1-B52-30 | LWV1-C52-30 |
| Plastic/Cold | – | LWV1-A23-30 | LWV1-B23-30 | LWV1-C23-30 |
| | • | LWV1-A53-30 | LWV1-B53-30 | LWV1-C53-30 |
| Plastic/Hot | – | LWV1-A24-30 | LWV1-B24-30 | LWV1-C24-30 |
| | • | LWV1-A54-30 | LWV1-B54-30 | LWV1-C54-30 |

Straight Nozzle

| Handle/Index | Vacuum Breaker | Compression Cartridge | Ceramic Cartridge | Control-A-Flow Cartridge |
|--------------|----------------|-----------------------|-------------------|--------------------------|
| Metal/Cold | – | LWV1-A11-30 | LWV1-B11-30 | LWV1-C11-30 |
| | • | LWV1-A41-30 | LWV1-B41-30 | LWV1-C41-30 |
| Metal/Hot | – | LWV1-A12-30 | LWV1-B12-30 | LWV1-C12-30 |
| | • | LWV1-A42-30 | LWV1-B42-30 | LWV1-C42-30 |
| Plastic/Cold | – | LWV1-A13-30 | LWV1-B13-30 | LWV1-C13-30 |
| | • | LWV1-A43-30 | LWV1-B43-30 | LWV1-C43-30 |
| Plastic/Hot | – | LWV1-A14-30 | LWV1-B14-30 | LWV1-C14-30 |
| | • | LWV1-A44-30 | LWV1-B44-30 | LWV1-C44-30 |

Straight Nozzle With Aspirator

| Handle/Index | Vacuum Breaker | Compression Cartridge | Ceramic Cartridge | Control-A-Flow Cartridge |
|--------------|----------------|-----------------------|-------------------|--------------------------|
| Metal/Cold | – | LWV1-A31-30 | LWV1-B31-30 | LWV1-C31-30 |
| | • | LWV1-A61-30 | LWV1-B61-30 | LWV1-C61-30 |
| Metal/Hot | – | LWV1-A32-30 | LWV1-B32-30 | LWV1-C32-30 |
| | • | LWV1-A62-30 | LWV1-B62-30 | LWV1-C62-30 |
| Plastic/Cold | – | LWV1-A33-30 | LWV1-B33-30 | LWV1-C33-30 |
| | • | LWV1-A63-30 | LWV1-B63-30 | LWV1-C63-30 |
| Plastic/Hot | – | LWV1-A34-30 | LWV1-B34-30 | LWV1-C34-30 |
| | • | LWV1-A64-30 | LWV1-B64-30 | LWV1-C64-30 |

Deck Mounted, Straight Pattern Four Water Valve Assembly

- Solid brass turret with four outlets
- Solid brass straight valve body
- Polished chrome plated finish
- 2-1/2" vandal proof cross handle
- 3/8" - 18 NPT male thread shank assembly



30° Nozzle

| Handle/Index | Vacuum Breaker | Compression Cartridge | Ceramic Cartridge | Control-A-Flow Cartridge |
|--------------|----------------|-----------------------|-------------------|--------------------------|
| Metal/Cold | – | LWV1-A21-40 | LWV1-B21-40 | LWV1-C21-40 |
| | • | LWV1-A51-40 | LWV1-B51-40 | LWV1-C51-40 |
| Metal/Hot | – | LWV1-A22-40 | LWV1-B22-40 | LWV1-C22-40 |
| | • | LWV1-A52-40 | LWV1-B52-40 | LWV1-C52-40 |
| Plastic/Cold | – | LWV1-A23-40 | LWV1-B23-40 | LWV1-C23-40 |
| | • | LWV1-A53-40 | LWV1-B53-40 | LWV1-C53-40 |
| Plastic/Hot | – | LWV1-A24-40 | LWV1-B24-40 | LWV1-C24-40 |
| | • | LWV1-A54-40 | LWV1-B54-40 | LWV1-C54-40 |

Straight Nozzle

| Handle/Index | Vacuum Breaker | Compression Cartridge | Ceramic Cartridge | Control-A-Flow Cartridge |
|--------------|----------------|-----------------------|-------------------|--------------------------|
| Metal/Cold | – | LWV1-A11-40 | LWV1-B11-40 | LWV1-C11-40 |
| | • | LWV1-A41-40 | LWV1-B41-40 | LWV1-C41-40 |
| Metal/Hot | – | LWV1-A12-40 | LWV1-B12-40 | LWV1-C12-40 |
| | • | LWV1-A42-40 | LWV1-B42-40 | LWV1-C42-40 |
| Plastic/Cold | – | LWV1-A13-40 | LWV1-B13-40 | LWV1-C13-40 |
| | • | LWV1-A43-40 | LWV1-B43-40 | LWV1-C43-40 |
| Plastic/Hot | – | LWV1-A14-40 | LWV1-B14-40 | LWV1-C14-40 |
| | • | LWV1-A44-40 | LWV1-B44-40 | LWV1-C44-40 |

Straight Nozzle With Aspirator

| Handle/Index | Vacuum Breaker | Compression Cartridge | Ceramic Cartridge | Control-A-Flow Cartridge |
|--------------|----------------|-----------------------|-------------------|--------------------------|
| Metal/Cold | – | LWV1-A31-40 | LWV1-B31-40 | LWV1-C31-40 |
| | • | LWV1-A61-40 | LWV1-B61-40 | LWV1-C61-40 |
| Metal/Hot | – | LWV1-A32-40 | LWV1-B32-40 | LWV1-C32-40 |
| | • | LWV1-A62-40 | LWV1-B62-40 | LWV1-C62-40 |
| Plastic/Cold | – | LWV1-A33-40 | LWV1-B33-40 | LWV1-C33-40 |
| | • | LWV1-A63-40 | LWV1-B63-40 | LWV1-C63-40 |
| Plastic/Hot | – | LWV1-A34-40 | LWV1-B34-40 | LWV1-C34-40 |
| | • | LWV1-A64-40 | LWV1-B64-40 | LWV1-C64-40 |

Wall Mounted, Straight Pattern Single Water Valve Assembly Less Shank

- Solid brass straight valve body
- Wall flange
- Polished chrome plated finish
- 2-1/2" vandal proof cross handle
- 3/8" - 18 NPT female thread inlet



Straight Nozzle

| Handle/Index | Vacuum Breaker | Compression Cartridge | Ceramic Cartridge | Control-A-Flow Cartridge |
|--------------|----------------|-----------------------|-------------------|--------------------------|
| Metal/Cold | – | LWW1-A11-50 | LWW1-B11-50 | LWW1-C11-50 |
| | • | LWW1-A41-50 | LWW1-B41-50 | LWW1-C41-50 |
| Metal/Hot | – | LWW1-A12-50 | LWW1-B12-50 | LWW1-C12-50 |
| | • | LWW1-A42-50 | LWW1-B42-50 | LWW1-C42-50 |
| Plastic/Cold | – | LWW1-A13-50 | LWW1-B13-50 | LWW1-C13-50 |
| | • | LWW1-A43-50 | LWW1-B43-50 | LWW1-C43-50 |
| Plastic/Hot | – | LWW1-A14-50 | LWW1-B14-50 | LWW1-C14-50 |
| | • | LWW1-A44-50 | LWW1-B44-50 | LWW1-C44-50 |

30° Nozzle

| Handle/Index | Vacuum Breaker | Compression Cartridge | Ceramic Cartridge | Control-A-Flow Cartridge |
|--------------|----------------|-----------------------|-------------------|--------------------------|
| Metal/Cold | – | LWW1-A21-50 | LWW1-B21-50 | LWW1-C21-50 |
| | • | LWW1-A51-50 | LWW1-B51-50 | LWW1-C51-50 |
| Metal/Hot | – | LWW1-A22-50 | LWW1-B22-50 | LWW1-C22-50 |
| | • | LWW1-A52-50 | LWW1-B52-50 | LWW1-C52-50 |
| Plastic/Cold | – | LWW1-A23-50 | LWW1-B23-50 | LWW1-C23-50 |
| | • | LWW1-A53-50 | LWW1-B53-50 | LWW1-C53-50 |
| Plastic/Hot | – | LWW1-A24-50 | LWW1-B24-50 | LWW1-C24-50 |
| | • | LWW1-A54-50 | LWW1-B54-50 | LWW1-C54-50 |

Straight Nozzle With Aspirator

| Handle/Index | Vacuum Breaker | Compression Cartridge | Ceramic Cartridge | Control-A-Flow Cartridge |
|--------------|----------------|-----------------------|-------------------|--------------------------|
| Metal/Cold | – | LWW1-A31-50 | LWW1-B31-50 | LWW1-C31-50 |
| | • | LWW1-A61-50 | LWW1-B61-50 | LWW1-C61-50 |
| Metal/Hot | – | LWW1-A32-50 | LWW1-B32-50 | LWW1-C32-50 |
| | • | LWW1-A62-50 | LWW1-B62-50 | LWW1-C62-50 |
| Plastic/Cold | – | LWW1-A33-50 | LWW1-B33-50 | LWW1-C33-50 |
| | • | LWW1-A63-50 | LWW1-B63-50 | LWW1-C63-50 |
| Plastic/Hot | – | LWW1-A34-50 | LWW1-B34-50 | LWW1-C34-50 |
| | • | LWW1-A64-50 | LWW1-B64-50 | LWW1-C64-50 |

Wall Mounted, Straight Pattern Single Water Valve Assembly With Shank

- Solid brass straight valve body
- Wall flange
- Forged brass straight valve body
- Polished chrome plated finish
- 2-1/2" vandal proof cross handle
- 3/8" - 18 NPT male thread shank assembly



Straight Nozzle

| Handle/Index | Vacuum Breaker | Compression Cartridge | Ceramic Cartridge | Control-A-Flow Cartridge |
|--------------|----------------|-----------------------|-------------------|--------------------------|
| Metal/Cold | – | LWW1-A11-55 | LWW1-B11-55 | LWW1-C11-55 |
| | • | LWW1-A41-55 | LWW1-B41-55 | LWW1-C41-55 |
| Metal/Hot | – | LWW1-A12-55 | LWW1-B12-55 | LWW1-C12-55 |
| | • | LWW1-A42-55 | LWW1-B42-55 | LWW1-C42-55 |
| Plastic/Cold | – | LWW1-A13-55 | LWW1-B13-55 | LWW1-C13-55 |
| | • | LWW1-A43-55 | LWW1-B43-55 | LWW1-C43-55 |
| Plastic/Hot | – | LWW1-A14-55 | LWW1-B14-55 | LWW1-C14-55 |
| | • | LWW1-A44-55 | LWW1-B44-55 | LWW1-C44-55 |

Straight Nozzle With Aspirator

| Handle/Index | Vacuum Breaker | Compression Cartridge | Ceramic Cartridge | Control-A-Flow Cartridge |
|--------------|----------------|-----------------------|-------------------|--------------------------|
| Metal/Cold | – | LWW1-A31-55 | LWW1-B31-55 | LWW1-C31-55 |
| | • | LWW1-A61-55 | LWW1-B61-55 | LWW1-C61-55 |
| Metal/Hot | – | LWW1-A32-55 | LWW1-B32-55 | LWW1-C32-55 |
| | • | LWW1-A62-55 | LWW1-B62-55 | LWW1-C62-55 |
| Plastic/Cold | – | LWW1-A33-55 | LWW1-B33-55 | LWW1-C33-55 |
| | • | LWW1-A63-55 | LWW1-B63-55 | LWW1-C63-55 |
| Plastic/Hot | – | LWW1-A34-55 | LWW1-B34-55 | LWW1-C34-55 |
| | • | LWW1-A64-55 | LWW1-B64-55 | LWW1-C64-55 |

30° Nozzle

| Handle/Index | Vacuum Breaker | Compression Cartridge | Ceramic Cartridge | Control-A-Flow Cartridge |
|--------------|----------------|-----------------------|-------------------|--------------------------|
| Metal/Cold | – | LWW1-A21-55 | LWW1-B21-55 | LWW1-C21-55 |
| | • | LWW1-A51-55 | LWW1-B51-55 | LWW1-C51-55 |
| Metal/Hot | – | LWW1-A22-55 | LWW1-B22-55 | LWW1-C22-55 |
| | • | LWW1-A52-55 | LWW1-B52-55 | LWW1-C52-55 |
| Plastic/Cold | – | LWW1-A23-55 | LWW1-B23-55 | LWW1-C23-55 |
| | • | LWW1-A53-55 | LWW1-B53-55 | LWW1-C53-55 |
| Plastic/Hot | – | LWW1-A24-55 | LWW1-B24-55 | LWW1-C24-55 |
| | • | LWW1-A54-55 | LWW1-B54-55 | LWW1-C54-55 |

Wall Mounted, Straight Pattern Dual 90° Water Valve Assembly Less Shank

- Solid brass straight valve body
- “Y” pattern wall flange with two valves
- Polished chrome plated finish
- 2-1/2” vandal proof cross handle
- 3/8” - 18 NPT female thread inlet



Straight Nozzle

| Handle/Index | Vacuum Breaker | Compression Cartridge | Ceramic Cartridge | Control-A-Flow Cartridge |
|--------------|----------------|-----------------------|-------------------|--------------------------|
| Metal/Cold | – | LWV1-A11-60 | LWV1-B11-60 | LWV1-C11-60 |
| | • | LWV1-A41-60 | LWV1-B41-60 | LWV1-C41-60 |
| Metal/Hot | – | LWV1-A12-60 | LWV1-B12-60 | LWV1-C12-60 |
| | • | LWV1-A42-60 | LWV1-B42-60 | LWV1-C42-60 |
| Plastic/Cold | – | LWV1-A13-60 | LWV1-B13-60 | LWV1-C13-60 |
| | • | LWV1-A43-60 | LWV1-B43-60 | LWV1-C43-60 |
| Plastic/Hot | – | LWV1-A14-60 | LWV1-B14-60 | LWV1-C14-60 |
| | • | LWV1-A44-60 | LWV1-B44-60 | LWV1-C44-60 |

30° Nozzle

| Handle/Index | Vacuum Breaker | Compression Cartridge | Ceramic Cartridge | Control-A-Flow Cartridge |
|--------------|----------------|-----------------------|-------------------|--------------------------|
| Metal/Cold | – | LWV1-A21-60 | LWV1-B21-60 | LWV1-C21-60 |
| | • | LWV1-A51-60 | LWV1-B51-60 | LWV1-C51-60 |
| Metal/Hot | – | LWV1-A22-60 | LWV1-B22-60 | LWV1-C22-60 |
| | • | LWV1-A52-60 | LWV1-B52-60 | LWV1-C52-60 |
| Plastic/Cold | – | LWV1-A23-60 | LWV1-B23-60 | LWV1-C23-60 |
| | • | LWV1-A53-60 | LWV1-B53-60 | LWV1-C53-60 |
| Plastic/Hot | – | LWV1-A24-60 | LWV1-B24-60 | LWV1-C24-60 |
| | • | LWV1-A54-60 | LWV1-B54-60 | LWV1-C54-60 |

Straight Nozzle With Aspirator

| Handle/Index | Vacuum Breaker | Compression Cartridge | Ceramic Cartridge | Control-A-Flow Cartridge |
|--------------|----------------|-----------------------|-------------------|--------------------------|
| Metal/Cold | – | LWV1-A31-60 | LWV1-B31-60 | LWV1-C31-60 |
| | • | LWV1-A61-60 | LWV1-B61-60 | LWV1-C61-60 |
| Metal/Hot | – | LWV1-A32-60 | LWV1-B32-60 | LWV1-C32-60 |
| | • | LWV1-A62-60 | LWV1-B62-60 | LWV1-C62-60 |
| Plastic/Cold | – | LWV1-A33-60 | LWV1-B33-60 | LWV1-C33-60 |
| | • | LWV1-A63-60 | LWV1-B63-60 | LWV1-C63-60 |
| Plastic/Hot | – | LWV1-A34-60 | LWV1-B34-60 | LWV1-C34-60 |
| | • | LWV1-A64-60 | LWV1-B64-60 | LWV1-C64-60 |

Wall Mounted, Straight Pattern Dual 90° Water Valve Assembly With Shank

- “Y” pattern wall flange with two valves
- Solid brass straight valve body
- Polished chrome plated finish
- 2-1/2” vandal proof cross handle
- 3/8” - 18 NPT male thread shank assembly



Straight Nozzle

| Handle/Index | Vacuum Breaker | Compression Cartridge | Ceramic Cartridge | Control-A-Flow Cartridge |
|--------------|----------------|-----------------------|-------------------|--------------------------|
| Metal/Cold | – | LWV1-A11-65 | LWV1-B11-65 | LWV1-C11-65 |
| | • | LWV1-A41-65 | LWV1-B41-65 | LWV1-C41-65 |
| Metal/Hot | – | LWV1-A12-65 | LWV1-B12-65 | LWV1-C12-65 |
| | • | LWV1-A42-65 | LWV1-B42-65 | LWV1-C42-65 |
| Plastic/Cold | – | LWV1-A13-65 | LWV1-B13-65 | LWV1-C13-65 |
| | • | LWV1-A43-65 | LWV1-B43-65 | LWV1-C43-65 |
| Plastic/Hot | – | LWV1-A14-65 | LWV1-B14-65 | LWV1-C14-65 |
| | • | LWV1-A44-65 | LWV1-B44-65 | LWV1-C44-65 |

30° Nozzle

| Handle/Index | Vacuum Breaker | Compression Cartridge | Ceramic Cartridge | Control-A-Flow Cartridge |
|--------------|----------------|-----------------------|-------------------|--------------------------|
| Metal/Cold | – | LWV1-A21-65 | LWV1-B21-65 | LWV1-C21-65 |
| | • | LWV1-A51-65 | LWV1-B51-65 | LWV1-C51-65 |
| Metal/Hot | – | LWV1-A22-65 | LWV1-B22-65 | LWV1-C22-65 |
| | • | LWV1-A52-65 | LWV1-B52-65 | LWV1-C52-65 |
| Plastic/Cold | – | LWV1-A23-65 | LWV1-B23-65 | LWV1-C23-65 |
| | • | LWV1-A53-65 | LWV1-B53-65 | LWV1-C53-65 |
| Plastic/Hot | – | LWV1-A24-65 | LWV1-B24-65 | LWV1-C24-65 |
| | • | LWV1-A54-65 | LWV1-B54-65 | LWV1-C54-65 |

Straight Nozzle With Aspirator

| Handle/Index | Vacuum Breaker | Compression Cartridge | Ceramic Cartridge | Control-A-Flow Cartridge |
|--------------|----------------|-----------------------|-------------------|--------------------------|
| Metal/Cold | – | LWV1-A31-65 | LWV1-B31-65 | LWV1-C31-65 |
| | • | LWV1-A61-65 | LWV1-B61-65 | LWV1-C61-65 |
| Metal/Hot | – | LWV1-A32-65 | LWV1-B32-65 | LWV1-C32-65 |
| | • | LWV1-A62-65 | LWV1-B62-65 | LWV1-C62-65 |
| Plastic/Cold | – | LWV1-A33-65 | LWV1-B33-65 | LWV1-C33-65 |
| | • | LWV1-A63-65 | LWV1-B63-65 | LWV1-C63-65 |
| Plastic/Hot | – | LWV1-A34-65 | LWV1-B34-65 | LWV1-C34-65 |
| | • | LWV1-A64-65 | LWV1-B64-65 | LWV1-C64-65 |

Angle Pattern Water Valve

- Solid brass angle valve body
- Polished chrome plated finish
- 2-1/2" vandal proof cross handle
- 3/8" - 18 NPT female thread inlet



30° Nozzle

| Handle/ Index | Vacuum Breaker | Compression Cartridge | Ceramic Cartridge | Control-A-Flow Cartridge |
|---------------|----------------|-----------------------|-------------------|--------------------------|
| Metal/Cold | – | LWW2-A21 | LWW2-B21 | LWW2-C21 |
| | • | LWW2-A51 | LWW2-B51 | LWW2-C51 |
| Metal/Hot | – | LWW2-A22 | LWW2-B22 | LWW2-C22 |
| | • | LWW2-A52 | LWW2-B52 | LWW2-C52 |
| Plastic/Cold | – | LWW2-A23 | LWW2-B23 | LWW2-C23 |
| | • | LWW2-A53 | LWW2-B53 | LWW2-C53 |
| Plastic/Hot | – | LWW2-A24 | LWW2-B24 | LWW2-C24 |
| | • | LWW2-A54 | LWW2-B54 | LWW2-C54 |

Straight Nozzle

| Handle/ Index | Vacuum Breaker | Compression Cartridge | Ceramic Cartridge | Control-A-Flow Cartridge |
|---------------|----------------|-----------------------|-------------------|--------------------------|
| Metal/Cold | – | LWW2-A11 | LWW2-B11 | LWW2-C11 |
| | • | LWW2-A41 | LWW2-B41 | LWW2-C41 |
| Metal/Hot | – | LWW2-A12 | LWW2-B12 | LWW2-C12 |
| | • | LWW2-A42 | LWW2-B42 | LWW2-C42 |
| Plastic/Cold | – | LWW2-A13 | LWW2-B13 | LWW2-C13 |
| | • | LWW2-A43 | LWW2-B43 | LWW2-C43 |
| Plastic/Hot | – | LWW2-A14 | LWW2-B14 | LWW2-C14 |
| | • | LWW2-A44 | LWW2-B44 | LWW2-C44 |

Straight Nozzle With Aspirator

| Handle/ Index | Vacuum Breaker | Compression Cartridge | Ceramic Cartridge | Control-A-Flow Cartridge |
|---------------|----------------|-----------------------|-------------------|--------------------------|
| Metal/Cold | – | LWW2-A31 | LWW2-B31 | LWW2-C31 |
| | • | LWW2-A61 | LWW2-B61 | LWW2-C61 |
| Metal/Hot | – | LWW2-A32 | LWW2-B32 | LWW2-C32 |
| | • | LWW2-A62 | LWW2-B62 | LWW2-C62 |
| Plastic/Cold | – | LWW2-A33 | LWW2-B33 | LWW2-C33 |
| | • | LWW2-A63 | LWW2-B63 | LWW2-C63 |
| Plastic/Hot | – | LWW2-A34 | LWW2-B34 | LWW2-C34 |
| | • | LWW2-A64 | LWW2-B64 | LWW2-C64 |

Overhead Mounted, Single Water Valve Assembly

- Solid brass turret with one outlet
- Solid brass straight valve body
- Polished chrome plated finish
- 2-1/2" vandal proof cross handle
- 3/8" - 18 NPT male thread shank assembly



30° Nozzle

| Handle/ Index | Vacuum Breaker | Compression Cartridge | Ceramic Cartridge | Control-A-Flow Cartridge |
|---------------|----------------|-----------------------|-------------------|--------------------------|
| Metal/Cold | – | LWW2-A21-10 | LWW2-B21-10 | LWW2-C21-10 |
| | • | LWW2-A51-10 | LWW2-B51-10 | LWW2-C51-10 |
| Metal/Hot | – | LWW2-A22-10 | LWW2-B22-10 | LWW2-C22-10 |
| | • | LWW2-A52-10 | LWW2-B52-10 | LWW2-C52-10 |
| Plastic/Cold | – | LWW2-A23-10 | LWW2-B23-10 | LWW2-C23-10 |
| | • | LWW2-A53-10 | LWW2-B53-10 | LWW2-C53-10 |
| Plastic/Hot | – | LWW2-A24-10 | LWW2-B24-10 | LWW2-C24-10 |
| | • | LWW2-A54-10 | LWW2-B54-10 | LWW2-C54-10 |

Straight Nozzle

| Handle/ Index | Vacuum Breaker | Compression Cartridge | Ceramic Cartridge | Control-A-Flow Cartridge |
|---------------|----------------|-----------------------|-------------------|--------------------------|
| Metal/Cold | – | LWW2-A11-10 | LWW2-B11-10 | LWW2-C11-10 |
| | • | LWW2-A41-10 | LWW2-B41-10 | LWW2-C41-10 |
| Metal/Hot | – | LWW2-A12-10 | LWW2-B12-10 | LWW2-C12-10 |
| | • | LWW2-A42-10 | LWW2-B42-10 | LWW2-C42-10 |
| Plastic/Cold | – | LWW2-A13-10 | LWW2-B13-10 | LWW2-C13-10 |
| | • | LWW2-A43-10 | LWW2-B43-10 | LWW2-C43-10 |
| Plastic/Hot | – | LWW2-A14-10 | LWW2-B14-10 | LWW2-C14-10 |
| | • | LWW2-A44-10 | LWW2-B44-10 | LWW2-C44-10 |

Straight Nozzle With Aspirator

| Handle/ Index | Vacuum Breaker | Compression Cartridge | Ceramic Cartridge | Control-A-Flow Cartridge |
|---------------|----------------|-----------------------|-------------------|--------------------------|
| Metal/Cold | – | LWW2-A31-10 | LWW2-B31-10 | LWW2-C31-10 |
| | • | LWW2-A61-10 | LWW2-B61-10 | LWW2-C61-10 |
| Metal/Hot | – | LWW2-A32-10 | LWW2-B32-10 | LWW2-C32-10 |
| | • | LWW2-A62-10 | LWW2-B62-10 | LWW2-C62-10 |
| Plastic/Cold | – | LWW2-A33-10 | LWW2-B33-10 | LWW2-C33-10 |
| | • | LWW2-A63-10 | LWW2-B63-10 | LWW2-C63-10 |
| Plastic/Hot | – | LWW2-A34-10 | LWW2-B34-10 | LWW2-C34-10 |
| | • | LWW2-A64-10 | LWW2-B64-10 | LWW2-C64-10 |

Overhead Mounted, Dual 90° Water Valve Assembly

- Solid brass turret with two 90° outlets
- Solid brass straight valve body
- Polished chrome plated finish
- 2-1/2" vandal proof cross handle
- 3/8" - 18 NPT male thread shank assembly



30° Nozzle

| Handle/Index | Vacuum Breaker | Compression Cartridge | Ceramic Cartridge | Control-A-Flow Cartridge |
|--------------|----------------|-----------------------|-------------------|--------------------------|
| Metal/Cold | – | LWV2-A21-20 | LWV2-B21-20 | LWV2-C21-20 |
| | • | LWV2-A51-20 | LWV2-B51-20 | LWV2-C51-20 |
| Metal/Hot | – | LWV2-A22-20 | LWV2-B22-20 | LWV2-C22-20 |
| | • | LWV2-A52-20 | LWV2-B52-20 | LWV2-C52-20 |
| Plastic/Cold | – | LWV2-A23-20 | LWV2-B23-20 | LWV2-C23-20 |
| | • | LWV2-A53-20 | LWV2-B53-20 | LWV2-C53-20 |
| Plastic/Hot | – | LWV2-A24-20 | LWV2-B24-20 | LWV2-C24-20 |
| | • | LWV2-A54-20 | LWV2-B54-20 | LWV2-C54-20 |

Straight Nozzle

| Handle/Index | Vacuum Breaker | Compression Cartridge | Ceramic Cartridge | Control-A-Flow Cartridge |
|--------------|----------------|-----------------------|-------------------|--------------------------|
| Metal/Cold | – | LWV2-A11-20 | LWV2-B11-20 | LWV2-C11-20 |
| | • | LWV2-A41-20 | LWV2-B41-20 | LWV2-C41-20 |
| Metal/Hot | – | LWV2-A12-20 | LWV2-B12-20 | LWV2-C12-20 |
| | • | LWV2-A42-20 | LWV2-B42-20 | LWV2-C42-20 |
| Plastic/Cold | – | LWV2-A13-20 | LWV2-B13-20 | LWV2-C13-20 |
| | • | LWV2-A43-20 | LWV2-B43-20 | LWV2-C43-20 |
| Plastic/Hot | – | LWV2-A14-20 | LWV2-B14-20 | LWV2-C14-20 |
| | • | LWV2-A44-20 | LWV2-B44-20 | LWV2-C44-20 |

Straight Nozzle With Aspirator

| Handle/Index | Vacuum Breaker | Compression Cartridge | Ceramic Cartridge | Control-A-Flow Cartridge |
|--------------|----------------|-----------------------|-------------------|--------------------------|
| Metal/Cold | – | LWV2-A31-20 | LWV2-B31-20 | LWV2-C31-20 |
| | • | LWV2-A61-20 | LWV2-B61-20 | LWV2-C61-20 |
| Metal/Hot | – | LWV2-A32-20 | LWV2-B32-20 | LWV2-C32-20 |
| | • | LWV2-A62-20 | LWV2-B62-20 | LWV2-C62-20 |
| Plastic/Cold | – | LWV2-A33-20 | LWV2-B33-20 | LWV2-C33-20 |
| | • | LWV2-A63-20 | LWV2-B63-20 | LWV2-C63-20 |
| Plastic/Hot | – | LWV2-A34-20 | LWV2-B34-20 | LWV2-C34-20 |
| | • | LWV2-A64-20 | LWV2-B64-20 | LWV2-C64-20 |

Overhead Mounted, Dual 180° Water Valve Assembly

- Solid brass turret with two 180° outlets
- Solid brass straight valve body
- Polished chrome plated finish
- 2-1/2" vandal proof cross handle
- 3/8" - 18 NPT male thread shank assembly



30° Nozzle

| Handle/Index | Vacuum Breaker | Compression Cartridge | Ceramic Cartridge | Control-A-Flow Cartridge |
|--------------|----------------|-----------------------|-------------------|--------------------------|
| Metal/Cold | – | LWV2-A21-25 | LWV2-B21-25 | LWV2-C21-25 |
| | • | LWV2-A51-25 | LWV2-B51-25 | LWV2-C51-25 |
| Metal/Hot | – | LWV2-A22-25 | LWV2-B22-25 | LWV2-C22-25 |
| | • | LWV2-A52-25 | LWV2-B52-25 | LWV2-C52-25 |
| Plastic/Cold | – | LWV2-A23-25 | LWV2-B23-25 | LWV2-C23-25 |
| | • | LWV2-A53-25 | LWV2-B53-25 | LWV2-C53-25 |
| Plastic/Hot | – | LWV2-A24-25 | LWV2-B24-25 | LWV2-C24-25 |
| | • | LWV2-A54-25 | LWV2-B54-25 | LWV2-C54-25 |

Straight Nozzle

| Handle/Index | Vacuum Breaker | Compression Cartridge | Ceramic Cartridge | Control-A-Flow Cartridge |
|--------------|----------------|-----------------------|-------------------|--------------------------|
| Metal/Cold | – | LWV2-A11-25 | LWV2-B11-25 | LWV2-C11-25 |
| | • | LWV2-A41-25 | LWV2-B41-25 | LWV2-C41-25 |
| Metal/Hot | – | LWV2-A12-25 | LWV2-B12-25 | LWV2-C12-25 |
| | • | LWV2-A42-25 | LWV2-B42-25 | LWV2-C42-25 |
| Plastic/Cold | – | LWV2-A13-25 | LWV2-B13-25 | LWV2-C13-25 |
| | • | LWV2-A43-25 | LWV2-B43-25 | LWV2-C43-25 |
| Plastic/Hot | – | LWV2-A14-25 | LWV2-B14-25 | LWV2-C14-25 |
| | • | LWV2-A44-25 | LWV2-B44-25 | LWV2-C44-25 |

Straight Nozzle With Aspirator

| Handle/Index | Vacuum Breaker | Compression Cartridge | Ceramic Cartridge | Control-A-Flow Cartridge |
|--------------|----------------|-----------------------|-------------------|--------------------------|
| Metal/Cold | – | LWV2-A31-25 | LWV2-B31-25 | LWV2-C31-25 |
| | • | LWV2-A61-25 | LWV2-B61-25 | LWV2-C61-25 |
| Metal/Hot | – | LWV2-A32-25 | LWV2-B32-25 | LWV2-C32-25 |
| | • | LWV2-A62-25 | LWV2-B62-25 | LWV2-C62-25 |
| Plastic/Cold | – | LWV2-A33-25 | LWV2-B33-25 | LWV2-C33-25 |
| | • | LWV2-A63-25 | LWV2-B63-25 | LWV2-C63-25 |
| Plastic/Hot | – | LWV2-A34-25 | LWV2-B34-25 | LWV2-C34-25 |
| | • | LWV2-A64-25 | LWV2-B64-25 | LWV2-C64-25 |

Overhead Mounted, Three Water Valve Assembly

- Solid brass turret with three outlets
- Solid brass angled valve body
- Polished chrome plated finish
- 2-1/2" vandal proof cross handle
- 3/8" - 18 NPT male thread shank assembly

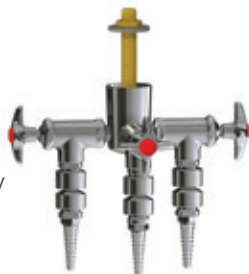

30° Nozzle

| Handle/Index | Vacuum Breaker | Compression Cartridge | Ceramic Cartridge | Control-A-Flow Cartridge |
|--------------|----------------|-----------------------|-------------------|--------------------------|
| Metal/Cold | – | LWV2-A21-30 | LWV2-B21-30 | LWV2-C21-30 |
| | • | LWV2-A51-30 | LWV2-B51-30 | LWV2-C51-30 |
| Metal/Hot | – | LWV2-A22-30 | LWV2-B22-30 | LWV2-C22-30 |
| | • | LWV2-A52-30 | LWV2-B52-30 | LWV2-C52-30 |
| Plastic/Cold | – | LWV2-A23-30 | LWV2-B23-30 | LWV2-C23-30 |
| | • | LWV2-A53-30 | LWV2-B53-30 | LWV2-C53-30 |
| Plastic/Hot | – | LWV2-A24-30 | LWV2-B24-30 | LWV2-C24-30 |
| | • | LWV2-A54-30 | LWV2-B54-30 | LWV2-C54-30 |

Straight Nozzle

| Handle/Index | Vacuum Breaker | Compression Cartridge | Ceramic Cartridge | Control-A-Flow Cartridge |
|--------------|----------------|-----------------------|-------------------|--------------------------|
| Metal/Cold | – | LWV2-A11-30 | LWV2-B11-30 | LWV2-C11-30 |
| | • | LWV2-A41-30 | LWV2-B41-30 | LWV2-C41-30 |
| Metal/Hot | – | LWV2-A12-30 | LWV2-B12-30 | LWV2-C12-30 |
| | • | LWV2-A42-30 | LWV2-B42-30 | LWV2-C42-30 |
| Plastic/Cold | – | LWV2-A13-30 | LWV2-B13-30 | LWV2-C13-30 |
| | • | LWV2-A43-30 | LWV2-B43-30 | LWV2-C43-30 |
| Plastic/Hot | – | LWV2-A14-30 | LWV2-B14-30 | LWV2-C14-30 |
| | • | LWV2-A44-30 | LWV2-B44-30 | LWV2-C44-30 |

Straight Nozzle With Aspirator

| Handle/Index | Vacuum Breaker | Compression Cartridge | Ceramic Cartridge | Control-A-Flow Cartridge |
|--------------|----------------|-----------------------|-------------------|--------------------------|
| Metal/Cold | – | LWV2-A31-30 | LWV2-B31-30 | LWV2-C31-30 |
| | • | LWV2-A61-30 | LWV2-B61-30 | LWV2-C61-30 |
| Metal/Hot | – | LWV2-A32-30 | LWV2-B32-30 | LWV2-C32-30 |
| | • | LWV2-A62-30 | LWV2-B62-30 | LWV2-C62-30 |
| Plastic/Cold | – | LWV2-A33-30 | LWV2-B33-30 | LWV2-C33-30 |
| | • | LWV2-A63-30 | LWV2-B63-30 | LWV2-C63-30 |
| Plastic/Hot | – | LWV2-A34-30 | LWV2-B34-30 | LWV2-C34-30 |
| | • | LWV2-A64-30 | LWV2-B64-30 | LWV2-C64-30 |

Overhead Mounted, Four Water Valve Assembly

- Solid brass turret with four outlets
- Solid brass angled valve body
- Polished chrome plated finish
- 2-1/2" vandal proof cross handle
- 3/8" - 18 NPT male thread shank assembly



30° Nozzle

| Handle/Index | Vacuum Breaker | Compression Cartridge | Ceramic Cartridge | Control-A-Flow Cartridge |
|--------------|----------------|-----------------------|-------------------|--------------------------|
| Metal/Cold | – | LWV2-A21-40 | LWV2-B21-40 | LWV2-C21-40 |
| | • | LWV2-A51-40 | LWV2-B51-40 | LWV2-C51-40 |
| Metal/Hot | – | LWV2-A22-40 | LWV2-B22-40 | LWV2-C22-40 |
| | • | LWV2-A52-40 | LWV2-B52-40 | LWV2-C52-40 |
| Plastic/Cold | – | LWV2-A23-40 | LWV2-B23-40 | LWV2-C23-40 |
| | • | LWV2-A53-40 | LWV2-B53-40 | LWV2-C53-40 |
| Plastic/Hot | – | LWV2-A24-40 | LWV2-B24-40 | LWV2-C24-40 |
| | • | LWV2-A54-40 | LWV2-B54-40 | LWV2-C54-40 |

Straight Nozzle

| Handle/Index | Vacuum Breaker | Compression Cartridge | Ceramic Cartridge | Control-A-Flow Cartridge |
|--------------|----------------|-----------------------|-------------------|--------------------------|
| Metal/Cold | – | LWV2-A11-40 | LWV2-B11-40 | LWV2-C11-40 |
| | • | LWV2-A41-40 | LWV2-B41-40 | LWV2-C41-40 |
| Metal/Hot | – | LWV2-A12-40 | LWV2-B12-40 | LWV2-C12-40 |
| | • | LWV2-A42-40 | LWV2-B42-40 | LWV2-C42-40 |
| Plastic/Cold | – | LWV2-A13-40 | LWV2-B13-40 | LWV2-C13-40 |
| | • | LWV2-A43-40 | LWV2-B43-40 | LWV2-C43-40 |
| Plastic/Hot | – | LWV2-A14-40 | LWV2-B14-40 | LWV2-C14-40 |
| | • | LWV2-A44-40 | LWV2-B44-40 | LWV2-C44-40 |

Straight Nozzle With Aspirator

| Handle/Index | Vacuum Breaker | Compression Cartridge | Ceramic Cartridge | Control-A-Flow Cartridge |
|--------------|----------------|-----------------------|-------------------|--------------------------|
| Metal/Cold | – | LWV2-A31-40 | LWV2-B31-40 | LWV2-C31-40 |
| | • | LWV2-A61-40 | LWV2-B61-40 | LWV2-C61-40 |
| Metal/Hot | – | LWV2-A32-40 | LWV2-B32-40 | LWV2-C32-40 |
| | • | LWV2-A62-40 | LWV2-B62-40 | LWV2-C62-40 |
| Plastic/Cold | – | LWV2-A33-40 | LWV2-B33-40 | LWV2-C33-40 |
| | • | LWV2-A63-40 | LWV2-B63-40 | LWV2-C63-40 |
| Plastic/Hot | – | LWV2-A34-40 | LWV2-B34-40 | LWV2-C34-40 |
| | • | LWV2-A64-40 | LWV2-B64-40 | LWV2-C64-40 |

Overhead Mounted, Angle Pattern Single Water Valve Assembly Less Shank

- Solid brass angled valve body
- Wall flange
- Polished chrome plated finish
- 2-1/2" vandal proof cross handle
- 3/8" - 18 NPT female thread inlet



30° Nozzle

| Handle/Index | Vacuum Breaker | Compression Cartridge | Ceramic Cartridge | Control-A-Flow Cartridge |
|--------------|----------------|-----------------------|-------------------|--------------------------|
| Metal/Cold | - | LWV2-A21-50 | LWV2-B21-50 | LWV2-C21-50 |
| | • | LWV2-A51-50 | LWV2-B51-50 | LWV2-C51-50 |
| Metal/Hot | - | LWV2-A22-50 | LWV2-B22-50 | LWV2-C22-50 |
| | • | LWV2-A52-50 | LWV2-B52-50 | LWV2-C52-50 |
| Plastic/Cold | - | LWV2-A23-50 | LWV2-B23-50 | LWV2-C23-50 |
| | • | LWV2-A53-50 | LWV2-B53-50 | LWV2-C53-50 |
| Plastic/Hot | - | LWV2-A24-50 | LWV2-B24-50 | LWV2-C24-50 |
| | • | LWV2-A54-50 | LWV2-B54-50 | LWV2-C54-50 |

Straight Nozzle

| Handle/Index | Vacuum Breaker | Compression Cartridge | Ceramic Cartridge | Control-A-Flow Cartridge |
|--------------|----------------|-----------------------|-------------------|--------------------------|
| Metal/Cold | - | LWV2-A11-50 | LWV2-B11-50 | LWV2-C11-50 |
| | • | LWV2-A41-50 | LWV2-B41-50 | LWV2-C41-50 |
| Metal/Hot | - | LWV2-A12-50 | LWV2-B12-50 | LWV2-C12-50 |
| | • | LWV2-A42-50 | LWV2-B42-50 | LWV2-C42-50 |
| Plastic/Cold | - | LWV2-A13-50 | LWV2-B13-50 | LWV2-C13-50 |
| | • | LWV2-A43-50 | LWV2-B43-50 | LWV2-C43-50 |
| Plastic/Hot | - | LWV2-A14-50 | LWV2-B14-50 | LWV2-C14-50 |
| | • | LWV2-A44-50 | LWV2-B44-50 | LWV2-C44-50 |

Straight Nozzle With Aspirator

| Handle/Index | Vacuum Breaker | Compression Cartridge | Ceramic Cartridge | Control-A-Flow Cartridge |
|--------------|----------------|-----------------------|-------------------|--------------------------|
| Metal/Cold | - | LWV2-A31-50 | LWV2-B31-50 | LWV2-C31-50 |
| | • | LWV2-A61-50 | LWV2-B61-50 | LWV2-C61-50 |
| Metal/Hot | - | LWV2-A32-50 | LWV2-B32-50 | LWV2-C32-50 |
| | • | LWV2-A62-50 | LWV2-B62-50 | LWV2-C62-50 |
| Plastic/Cold | - | LWV2-A33-50 | LWV2-B33-50 | LWV2-C33-50 |
| | • | LWV2-A63-50 | LWV2-B63-50 | LWV2-C63-50 |
| Plastic/Hot | - | LWV2-A34-50 | LWV2-B34-50 | LWV2-C34-50 |
| | • | LWV2-A64-50 | LWV2-B64-50 | LWV2-C64-50 |

Overhead Mounted, Angle Pattern Single Water Valve Assembly With Shank

- Wall flange
- Solid brass angled valve body
- Polished chrome plated finish
- 2-1/2" vandal proof cross handle
- 3/8" - 18 NPT male thread shank assembly



30° Nozzle

| Handle/Index | Vacuum Breaker | Compression Cartridge | Ceramic Cartridge | Control-A-Flow Cartridge |
|--------------|----------------|-----------------------|--------------------|--------------------------|
| Metal/Cold | - | LWV2-A21-55 | LWV2-B21-55 | LWV2-C21-55 |
| | • | LWV2-A51-55 | LWV2-B51-55 | LWV2-C51-55 |
| Metal/Hot | - | LWV2-A22-55 | LWV2-B22-55 | LWV2-C22-55 |
| | • | LWV2-A52-55 | LWV2-B52-55 | LWV2-C52-55 |
| Plastic/Cold | - | LWV2-A23-55 | LWV2-B23-55 | LWV2-C23-55 |
| | • | LWV2-A53-55 | LWV2-B53-55 | LWV2-C53-55 |
| Plastic/Hot | - | LWV2-A24-55 | LWV2-B24-55 | LWV2-C24-55 |
| | • | LWV2-A54-55 | LWV2-B54-55 | LWV2-C54-55 |

Straight Nozzle

| Handle/Index | Vacuum Breaker | Compression Cartridge | Ceramic Cartridge | Control-A-Flow Cartridge |
|--------------|----------------|-----------------------|-------------------|--------------------------|
| Metal/Cold | - | LWV2-A11-55 | LWV2-B11-55 | LWV2-C11-55 |
| | • | LWV2-A41-55 | LWV2-B41-55 | LWV2-C41-55 |
| Metal/Hot | - | LWV2-A12-55 | LWV2-B12-55 | LWV2-C12-55 |
| | • | LWV2-A42-55 | LWV2-B42-55 | LWV2-C42-55 |
| Plastic/Cold | - | LWV2-A13-55 | LWV2-B13-55 | LWV2-C13-55 |
| | • | LWV2-A43-55 | LWV2-B43-55 | LWV2-C43-55 |
| Plastic/Hot | - | LWV2-A14-55 | LWV2-B14-55 | LWV2-C14-55 |
| | • | LWV2-A44-55 | LWV2-B44-55 | LWV2-C44-55 |

Straight Nozzle With Aspirator

| Handle/Index | Vacuum Breaker | Compression Cartridge | Ceramic Cartridge | Control-A-Flow Cartridge |
|--------------|----------------|-----------------------|-------------------|--------------------------|
| Metal/Cold | - | LWV2-A31-55 | LWV2-B31-55 | LWV2-C31-55 |
| | • | LWV2-A61-55 | LWV2-B61-55 | LWV2-C61-55 |
| Metal/Hot | - | LWV2-A32-55 | LWV2-B32-55 | LWV2-C32-55 |
| | • | LWV2-A62-55 | LWV2-B62-55 | LWV2-C62-55 |
| Plastic/Cold | - | LWV2-A33-55 | LWV2-B33-55 | LWV2-C33-55 |
| | • | LWV2-A63-55 | LWV2-B63-55 | LWV2-C63-55 |
| Plastic/Hot | - | LWV2-A34-55 | LWV2-B34-55 | LWV2-C34-55 |
| | • | LWV2-A64-55 | LWV2-B64-55 | LWV2-C64-55 |

Overhead Mounted, Angle Pattern Dual 90° Water Valve Assembly Less Shank

- Solid brass angled valve body
- “Y” pattern wall flange with two valves
- Polished chrome plated finish
- 2-1/2” vandal proof cross handle
- 3/8” - 18 NPT female thread inlet



Straight Nozzle

| Handle/Index | Vacuum Breaker | Compression Cartridge | Ceramic Cartridge | Control-A-Flow Cartridge |
|--------------|----------------|-----------------------|-------------------|--------------------------|
| Metal/Cold | – | LWW2-A11-60 | LWW2-B11-60 | LWW2-C11-60 |
| | • | LWW2-A41-60 | LWW2-B41-60 | LWW2-C41-60 |
| Metal/Hot | – | LWW2-A12-60 | LWW2-B12-60 | LWW2-C12-60 |
| | • | LWW2-A42-60 | LWW2-B42-60 | LWW2-C42-60 |
| Plastic/Cold | – | LWW2-A13-60 | LWW2-B13-60 | LWW2-C13-60 |
| | • | LWW2-A43-60 | LWW2-B43-60 | LWW2-C43-60 |
| Plastic/Hot | – | LWW2-A14-60 | LWW2-B14-60 | LWW2-C14-60 |
| | • | LWW2-A44-60 | LWW2-B44-60 | LWW2-C44-60 |

30° Nozzle

| Handle/Index | Vacuum Breaker | Compression Cartridge | Ceramic Cartridge | Control-A-Flow Cartridge |
|--------------|----------------|-----------------------|-------------------|--------------------------|
| Metal/Cold | – | LWW2-A21-60 | LWW2-B21-60 | LWW2-C21-60 |
| | • | LWW2-A51-60 | LWW2-B51-60 | LWW2-C51-60 |
| Metal/Hot | – | LWW2-A22-60 | LWW2-B22-60 | LWW2-C22-60 |
| | • | LWW2-A52-60 | LWW2-B52-60 | LWW2-C52-60 |
| Plastic/Cold | – | LWW2-A23-60 | LWW2-B23-60 | LWW2-C23-60 |
| | • | LWW2-A53-60 | LWW2-B53-60 | LWW2-C53-60 |
| Plastic/Hot | – | LWW2-A24-60 | LWW2-B24-60 | LWW2-C24-60 |
| | • | LWW2-A54-60 | LWW2-B54-60 | LWW2-C54-60 |

Straight Nozzle With Aspirator

| Handle/Index | Vacuum Breaker | Compression Cartridge | Ceramic Cartridge | Control-A-Flow Cartridge |
|--------------|----------------|-----------------------|-------------------|--------------------------|
| Metal/Cold | – | LWW2-A31-60 | LWW2-B31-60 | LWW2-C31-60 |
| | • | LWW2-A61-60 | LWW2-B61-60 | LWW2-C61-60 |
| Metal/Hot | – | LWW2-A32-60 | LWW2-B32-60 | LWW2-C32-60 |
| | • | LWW2-A62-60 | LWW2-B62-60 | LWW2-C62-60 |
| Plastic/Cold | – | LWW2-A33-60 | LWW2-B33-60 | LWW2-C33-60 |
| | • | LWW2-A63-60 | LWW2-B63-60 | LWW2-C63-60 |
| Plastic/Hot | – | LWW2-A34-60 | LWW2-B34-60 | LWW2-C34-60 |
| | • | LWW2-A64-60 | LWW2-B64-60 | LWW2-C64-60 |

Overhead Mounted, Angle Pattern Dual 90° Water Valve Assembly With Shank

- “Y” pattern wall flange with two valves
- Solid brass straight valve body
- Polished chrome plated finish
- 2-1/2” vandal proof cross handle
- 3/8” - 18 NPT male thread shank assembly



Straight Nozzle

| Handle/Index | Vacuum Breaker | Compression Cartridge | Ceramic Cartridge | Control-A-Flow Cartridge |
|--------------|----------------|-----------------------|-------------------|--------------------------|
| Metal/Cold | – | LWW2-A11-65 | LWW2-B11-65 | LWW2-C11-65 |
| | • | LWW2-A41-65 | LWW2-B41-65 | LWW2-C41-65 |
| Metal/Hot | – | LWW2-A12-65 | LWW2-B12-65 | LWW2-C12-65 |
| | • | LWW2-A42-65 | LWW2-B42-65 | LWW2-C42-65 |
| Plastic/Cold | – | LWW2-A13-65 | LWW2-B13-65 | LWW2-C13-65 |
| | • | LWW2-A43-65 | LWW2-B43-65 | LWW2-C43-65 |
| Plastic/Hot | – | LWW2-A14-65 | LWW2-B14-65 | LWW2-C14-65 |
| | • | LWW2-A44-65 | LWW2-B44-65 | LWW2-C44-65 |

30° Nozzle

| Handle/Index | Vacuum Breaker | Compression Cartridge | Ceramic Cartridge | Control-A-Flow Cartridge |
|--------------|----------------|-----------------------|-------------------|--------------------------|
| Metal/Cold | – | LWW2-A21-65 | LWW2-B21-65 | LWW2-C21-65 |
| | • | LWW2-A51-65 | LWW2-B51-65 | LWW2-C51-65 |
| Metal/Hot | – | LWW2-A22-65 | LWW2-B22-65 | LWW2-C22-65 |
| | • | LWW2-A52-65 | LWW2-B52-65 | LWW2-C52-65 |
| Plastic/Cold | – | LWW2-A23-65 | LWW2-B23-65 | LWW2-C23-65 |
| | • | LWW2-A53-65 | LWW2-B53-65 | LWW2-C53-65 |
| Plastic/Hot | – | LWW2-A24-65 | LWW2-B24-65 | LWW2-C24-65 |
| | • | LWW2-A54-65 | LWW2-B54-65 | LWW2-C54-65 |

Straight Nozzle With Aspirator

| Handle/Index | Vacuum Breaker | Compression Cartridge | Ceramic Cartridge | Control-A-Flow Cartridge |
|--------------|----------------|-----------------------|-------------------|--------------------------|
| Metal/Cold | – | LWW2-A31-65 | LWW2-B31-65 | LWW2-C31-65 |
| | • | LWW2-A61-65 | LWW2-B61-65 | LWW2-C61-65 |
| Metal/Hot | – | LWW2-A32-65 | LWW2-B32-65 | LWW2-C32-65 |
| | • | LWW2-A62-65 | LWW2-B62-65 | LWW2-C62-65 |
| Plastic/Cold | – | LWW2-A33-65 | LWW2-B33-65 | LWW2-C33-65 |
| | • | LWW2-A63-65 | LWW2-B63-65 | LWW2-C63-65 |
| Plastic/Hot | – | LWW2-A34-65 | LWW2-B34-65 | LWW2-C34-65 |
| | • | LWW2-A64-65 | LWW2-B64-65 | LWW2-C64-65 |

Hose Bibb Water Valve Less Shank

- Solid brass straight valve body
- Polished chrome plated finish
- 2-1/2" vandal proof cross handle
- 3/8" - 18 NPT female thread inlet



30° Nozzle

| Handle/Index | Vacuum Breaker | Compression Cartridge | Ceramic Cartridge | Control-A-Flow Cartridge |
|--------------|----------------|-----------------------|-------------------|--------------------------|
| Metal/Cold | – | LWV3-A21 | LWV3-B21 | LWV3-C21 |
| | • | LWV3-A51 | LWV3-B51 | LWV3-C51 |
| Metal/Hot | – | LWV3-A22 | LWV3-B22 | LWV3-C22 |
| | • | LWV3-A52 | LWV3-B52 | LWV3-C52 |
| Plastic/Cold | – | LWV3-A23 | LWV3-B23 | LWV3-C23 |
| | • | LWV3-A53 | LWV3-B53 | LWV3-C53 |
| Plastic/Hot | – | LWV3-A24 | LWV3-B24 | LWV3-C24 |
| | • | LWV3-A44 | LWV3-B44 | LWV3-C44 |

Straight Nozzle

| Handle/Index | Vacuum Breaker | Compression Cartridge | Ceramic Cartridge | Control-A-Flow Cartridge |
|--------------|----------------|-----------------------|-------------------|--------------------------|
| Metal/Cold | – | LWV3-A11 | LWV3-B11 | LWV3-C11 |
| | • | LWV3-A41 | LWV3-B41 | LWV3-C41 |
| Metal/Hot | – | LWV3-A12 | LWV3-B12 | LWV3-C12 |
| | • | LWV3-A42 | LWV3-B42 | LWV3-C42 |
| Plastic/Cold | – | LWV3-A13 | LWV3-B13 | LWV3-C13 |
| | • | LWV3-A43 | LWV3-B43 | LWV3-C43 |
| Plastic/Hot | – | LWV3-A14 | LWV3-B14 | LWV3-C14 |
| | • | LWV3-A44 | LWV3-B44 | LWV3-C44 |

Straight Nozzle With Aspirator

| Handle/Index | Vacuum Breaker | Compression Cartridge | Ceramic Cartridge | Control-A-Flow Cartridge |
|--------------|----------------|-----------------------|-------------------|--------------------------|
| Metal/Cold | – | LWV3-A31 | LWV3-B31 | LWV3-C31 |
| | • | LWV3-A61 | LWV3-B61 | LWV3-C61 |
| Metal/Hot | – | LWV3-A32 | LWV3-B32 | LWV3-C32 |
| | • | LWV3-A62 | LWV3-B62 | LWV3-C62 |
| Plastic/Cold | – | LWV3-A33 | LWV3-B33 | LWV3-C33 |
| | • | LWV3-A63 | LWV3-B63 | LWV3-C63 |
| Plastic/Hot | – | LWV3-A34 | LWV3-B34 | LWV3-C34 |
| | • | LWV3-A64 | LWV3-B64 | LWV3-C64 |

Hose Bibb Water Valve With Shank

- Solid brass straight valve body
- Polished chrome plated finish
- 2-1/2" vandal proof cross handle
- 3/8" - 18 NPT male thread shank assembly



30° Nozzle

| Handle/Index | Vacuum Breaker | Compression Cartridge | Ceramic Cartridge | Control-A-Flow Cartridge |
|--------------|----------------|-----------------------|-------------------|--------------------------|
| Metal/Cold | – | LWV4-A21 | LWV4-B21 | LWV4-C21 |
| | • | LWV4-A51 | LWV4-B51 | LWV4-C51 |
| Metal/Hot | – | LWV4-A22 | LWV4-B22 | LWV4-C22 |
| | • | LWV4-A52 | LWV4-B52 | LWV4-C52 |
| Plastic/Cold | – | LWV4-A23 | LWV4-B23 | LWV4-C23 |
| | • | LWV4-A53 | LWV4-B53 | LWV4-C53 |
| Plastic/Hot | – | LWV4-A24 | LWV4-B24 | LWV4-C24 |
| | • | LWV4-A54 | LWV4-B54 | LWV4-C54 |

Straight Nozzle

| Handle/Index | Vacuum Breaker | Compression Cartridge | Ceramic Cartridge | Control-A-Flow Cartridge |
|--------------|----------------|-----------------------|-------------------|--------------------------|
| Metal/Cold | – | LWV4-A11 | LWV4-B11 | LWV4-C11 |
| | • | LWV4-A41 | LWV4-B41 | LWV4-C41 |
| Metal/Hot | – | LWV4-A12 | LWV4-B12 | LWV4-C12 |
| | • | LWV4-A42 | LWV4-B42 | LWV4-C42 |
| Plastic/Cold | – | LWV4-A13 | LWV4-B13 | LWV4-C13 |
| | • | LWV4-A43 | LWV4-B43 | LWV4-C43 |
| Plastic/Hot | – | LWV4-A14 | LWV4-B14 | LWV4-C14 |
| | • | LWV4-A44 | LWV4-B44 | LWV4-C44 |

Straight Nozzle With Aspirator

| Handle/Index | Vacuum Breaker | Compression Cartridge | Ceramic Cartridge | Control-A-Flow Cartridge |
|--------------|----------------|-----------------------|-------------------|--------------------------|
| Metal/Cold | – | LWV4-A31 | LWV4-B31 | LWV4-C31 |
| | • | LWV4-A61 | LWV4-B61 | LWV4-C61 |
| Metal/Hot | – | LWV4-A32 | LWV4-B32 | LWV4-C32 |
| | • | LWV4-A62 | LWV4-B62 | LWV4-C62 |
| Plastic/Cold | – | LWV4-A33 | LWV4-B33 | LWV4-C33 |
| | • | LWV4-A63 | LWV4-B63 | LWV4-C63 |
| Plastic/Hot | – | LWV4-A34 | LWV4-B34 | LWV4-C34 |
| | • | LWV4-A64 | LWV4-B64 | LWV4-C64 |

How to build and order a Chicago Faucets laboratory water single faucet.

Chicago Faucets makes it easy for you to build a faucet that meets your exact requirements. You can reference the charts on the following pages, or you can build your own faucet by choosing the components below to configure your model number.

LWS A-B C D-E

(Lab Water Single)

Base

A



Deck Mount Right-Hand Operation



Deck Mount Left-Hand Operation



Deck Mount Back-Mount Handle



Wall Mount



Wall Mount w/ Shanks

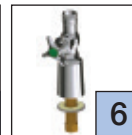

Turret with Front-Mount Handle

Cartridge

B



Compression



Ceramic



Control-A-Flow

Outlet

C



Straight Nozzle



2.2 GPM Aerated Outlet



Straight Nozzle w/ aspirator

EXAMPLE



LWS4-B31-5

Wall mount, ceramic cartridge, straight nozzle with aspirator, metal handle with cold index, and 5-1/4" gooseneck spout with vacuum breaker.

Handles

D



Metal Cross, "CW" Index



Metal Cross, "HW" Index

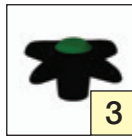

Plastic Cross, "CW" Index

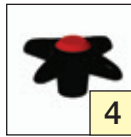

Plastic Cross, "HW" Index

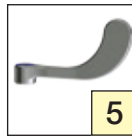

Wristblade, Cold Index

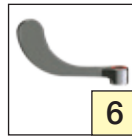

Wristblade, Hot Index

Spouts

E



5-1/4" Rigid/Swing Gooseneck



8" Rigid/Swing Gooseneck



5-1/4" Rigid/Swing Gooseneck w/ Vacuum Breaker



8" Rigid/Swing Gooseneck w/ Vacuum Breaker



5-1/4" Rigid Gooseneck w/ Vacuum Breaker

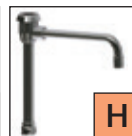

8" Rigid Gooseneck w/ Vacuum Breaker

Deck Mounted, Right-Hand Operation, 5-1/4" Gooseneck Spout

- Solid brass construction
- Polished chrome plated finish
- 1/2" NPSM supply inlet with coupling nut for 3/8" or 1/2" flexible riser



Straight Nozzle

| Handle/Index | Compression Cartridge | Ceramic Cartridge | Control-A-Flow Cartridge |
|--------------------|-----------------------|-------------------|--------------------------|
| Metal Cross/Cold | LWS1-A11-A | LWS1-B11-A | LWS1-C11-A |
| Metal Cross/Hot | LWS1-A12-A | LWS1-B12-A | LWS1-C12-A |
| Plastic Cross/Cold | LWS1-A13-A | LWS1-B13-A | LWS1-C13-A |
| Plastic Cross/Hot | LWS1-A14-A | LWS1-B14-A | LWS1-C14-A |
| Wristblade/Cold | LWS1-A15-A | LWS1-B15-A | LWS1-C15-A |
| Wristblade/Hot | LWS1-A16-A | LWS1-B16-A | LWS1-C16-A |

2.2 GPM Aerated Outlet

| Handle/Index | Compression Cartridge | Ceramic Cartridge | Control-A-Flow Cartridge |
|--------------------|-----------------------|-------------------|--------------------------|
| Metal Cross/Cold | LWS1-A21-A | LWS1-B21-A | LWS1-C21-A |
| Metal Cross/Hot | LWS1-A22-A | LWS1-B22-A | LWS1-C22-A |
| Plastic Cross/Cold | LWS1-A23-A | LWS1-B23-A | LWS1-C23-A |
| Plastic Cross/Hot | LWS1-A24-A | LWS1-B24-A | LWS1-C24-A |
| Wristblade/Cold | LWS1-A25-A | LWS1-B25-A | LWS1-C25-A |
| Wristblade/Hot | LWS1-A26-A | LWS1-B26-A | LWS1-C26-A |

Straight Nozzle With Aspirator

| Handle/Index | Compression Cartridge | Ceramic Cartridge | Control-A-Flow Cartridge |
|--------------------|-----------------------|-------------------|--------------------------|
| Metal Cross/Cold | LWS1-A31-A | LWS1-B31-A | LWS1-C31-A |
| Metal Cross/Hot | LWS1-A32-A | LWS1-B32-A | LWS1-C32-A |
| Plastic Cross/Cold | LWS1-A33-A | LWS1-B33-A | LWS1-C33-A |
| Plastic Cross/Hot | LWS1-A34-A | LWS1-B34-A | LWS1-C34-A |
| Wristblade/Cold | LWS1-A35-A | LWS1-B35-A | LWS1-C35-A |
| Wristblade/Hot | LWS1-A36-A | LWS1-B36-A | LWS1-C36-A |

Deck Mounted, Right-Hand Operation, 8" Gooseneck Spout

- Solid brass construction
- Polished chrome plated finish
- 1/2" NPSM supply inlet with coupling nut for 3/8" or 1/2" flexible riser



Straight Nozzle

| Handle/Index | Compression Cartridge | Ceramic Cartridge | Control-A-Flow Cartridge |
|--------------------|-----------------------|-------------------|--------------------------|
| Metal Cross/Cold | LWS1-A11-B | LWS1-B11-B | LWS1-C11-B |
| Metal Cross/Hot | LWS1-A12-B | LWS1-B12-B | LWS1-C12-B |
| Plastic Cross/Cold | LWS1-A13-B | LWS1-B13-B | LWS1-C13-B |
| Plastic Cross/Hot | LWS1-A14-B | LWS1-B14-B | LWS1-C14-B |
| Wristblade/Cold | LWS1-A15-B | LWS1-B15-B | LWS1-C15-B |
| Wristblade/Hot | LWS1-A16-B | LWS1-B16-B | LWS1-C16-B |

2.2 GPM Aerated Outlet

| Handle/Index | Compression Cartridge | Ceramic Cartridge | Control-A-Flow Cartridge |
|--------------------|-----------------------|-------------------|--------------------------|
| Metal Cross/Cold | LWS1-A21-B | LWS1-B21-B | LWS1-C21-B |
| Metal Cross/Hot | LWS1-A22-B | LWS1-B22-B | LWS1-C22-B |
| Plastic Cross/Cold | LWS1-A23-B | LWS1-B23-B | LWS1-C23-B |
| Plastic Cross/Hot | LWS1-A24-B | LWS1-B24-B | LWS1-C24-B |
| Wristblade/Cold | LWS1-A25-B | LWS1-B25-B | LWS1-C25-B |
| Wristblade/Hot | LWS1-A26-B | LWS1-B26-B | LWS1-C26-B |

Straight Nozzle With Aspirator

| Handle/Index | Compression Cartridge | Ceramic Cartridge | Control-A-Flow Cartridge |
|--------------------|-----------------------|-------------------|--------------------------|
| Metal Cross/Cold | LWS1-A31-B | LWS1-B31-B | LWS1-C31-B |
| Metal Cross/Hot | LWS1-A32-B | LWS1-B32-B | LWS1-C32-B |
| Plastic Cross/Cold | LWS1-A33-B | LWS1-B33-B | LWS1-C33-B |
| Plastic Cross/Hot | LWS1-A34-B | LWS1-B34-B | LWS1-C34-B |
| Wristblade/Cold | LWS1-A35-B | LWS1-B35-B | LWS1-C35-B |
| Wristblade/Hot | LWS1-A36-B | LWS1-B36-B | LWS1-C36-B |

Deck Mounted, Right-Hand Operation, 5-1/4" Gooseneck Spout with Vacuum Breaker

- Solid brass construction
- Polished chrome plated finish
- 1/2" NPSM supply inlet with coupling nut for 3/8" or 1/2" flexible riser



2.2 GPM Aerated Outlet

| Handle/Index | Compression Cartridge | Ceramic Cartridge | Control-A-Flow Cartridge |
|--------------------|-----------------------|-------------------|--------------------------|
| Metal Cross/Cold | LWS1-A21-E | LWS1-B21-E | LWS1-C21-E |
| Metal Cross/Hot | LWS1-A22-E | LWS1-B22-E | LWS1-C22-E |
| Plastic Cross/Cold | LWS1-A23-E | LWS1-B23-E | LWS1-C23-E |
| Plastic Cross/Hot | LWS1-A24-E | LWS1-B24-E | LWS1-C24-E |
| Wristblade/Cold | LWS1-A25-E | LWS1-B25-E | LWS1-C25-E |
| Wristblade/Hot | LWS1-A26-E | LWS1-B26-E | LWS1-C26-E |

Straight Nozzle

| Handle/Index | Compression Cartridge | Ceramic Cartridge | Control-A-Flow Cartridge |
|--------------------|-----------------------|-------------------|--------------------------|
| Metal Cross/Cold | LWS1-A11-E | LWS1-B11-E | LWS1-C11-E |
| Metal Cross/Hot | LWS1-A12-E | LWS1-B12-E | LWS1-C12-E |
| Plastic Cross/Cold | LWS1-A13-E | LWS1-B13-E | LWS1-C13-E |
| Plastic Cross/Hot | LWS1-A14-E | LWS1-B14-E | LWS1-C14-E |
| Wristblade/Cold | LWS1-A15-E | LWS1-B15-E | LWS1-C15-E |
| Wristblade/Hot | LWS1-A16-E | LWS1-B16-E | LWS1-C16-E |

Straight Nozzle With Aspirator

| Handle/Index | Compression Cartridge | Ceramic Cartridge | Control-A-Flow Cartridge |
|--------------------|-----------------------|-------------------|--------------------------|
| Metal Cross/Cold | LWS1-A31-E | LWS1-B31-E | LWS1-C31-E |
| Metal Cross/Hot | LWS1-A32-E | LWS1-B32-E | LWS1-C32-E |
| Plastic Cross/Cold | LWS1-A33-E | LWS1-B33-E | LWS1-C33-E |
| Plastic Cross/Hot | LWS1-A34-E | LWS1-B34-E | LWS1-C34-E |
| Wristblade/Cold | LWS1-A35-E | LWS1-B35-E | LWS1-C35-E |
| Wristblade/Hot | LWS1-A36-E | LWS1-B36-E | LWS1-C36-E |

Deck Mounted, Right-Hand Operation, 8" Gooseneck Spout with Vacuum Breaker

- Solid brass construction
- Polished chrome plated finish
- 1/2" NPSM supply inlet with coupling nut for 3/8" or 1/2" flexible riser



2.2 GPM Aerated Outlet

| Handle/Index | Compression Cartridge | Ceramic Cartridge | Control-A-Flow Cartridge |
|--------------------|-----------------------|-------------------|--------------------------|
| Metal Cross/Cold | LWS1-A21-F | LWS1-B21-F | LWS1-C21-F |
| Metal Cross/Hot | LWS1-A22-F | LWS1-B22-F | LWS1-C22-F |
| Plastic Cross/Cold | LWS1-A23-F | LWS1-B23-F | LWS1-C23-F |
| Plastic Cross/Hot | LWS1-A24-F | LWS1-B24-F | LWS1-C24-F |
| Wristblade/Cold | LWS1-A25-F | LWS1-B25-F | LWS1-C25-F |
| Wristblade/Hot | LWS1-A26-F | LWS1-B26-F | LWS1-C26-F |

Straight Nozzle

| Handle/Index | Compression Cartridge | Ceramic Cartridge | Control-A-Flow Cartridge |
|--------------------|-----------------------|-------------------|--------------------------|
| Metal Cross/Cold | LWS1-A11-F | LWS1-B11-F | LWS1-C11-F |
| Metal Cross/Hot | LWS1-A12-F | LWS1-B12-F | LWS1-C12-F |
| Plastic Cross/Cold | LWS1-A13-F | LWS1-B13-F | LWS1-C13-F |
| Plastic Cross/Hot | LWS1-A14-F | LWS1-B14-F | LWS1-C14-F |
| Wristblade/Cold | LWS1-A15-F | LWS1-B15-F | LWS1-C15-F |
| Wristblade/Hot | LWS1-A16-F | LWS1-B16-F | LWS1-C16-F |

Straight Nozzle With Aspirator

| Handle/Index | Compression Cartridge | Ceramic Cartridge | Control-A-Flow Cartridge |
|--------------------|-----------------------|-------------------|--------------------------|
| Metal Cross/Cold | LWS1-A31-F | LWS1-B31-F | LWS1-C31-F |
| Metal Cross/Hot | LWS1-A32-F | LWS1-B32-F | LWS1-C32-F |
| Plastic Cross/Cold | LWS1-A33-F | LWS1-B33-F | LWS1-C33-F |
| Plastic Cross/Hot | LWS1-A34-F | LWS1-B34-F | LWS1-C34-F |
| Wristblade/Cold | LWS1-A35-F | LWS1-B35-F | LWS1-C35-F |
| Wristblade/Hot | LWS1-A36-F | LWS1-B36-F | LWS1-C36-F |

Deck Mounted, Right-Hand Operation, 5-1/4" Rigid Spout with Vacuum Breaker

- Solid brass construction
- Polished chrome plated finish
- 1/2" NPSM supply inlet with coupling nut for 3/8" or 1/2" flexible riser



2.2 GPM Aerated Outlet

| Handle/Index | Compression Cartridge | Ceramic Cartridge | Control-A-Flow Cartridge |
|--------------------|-----------------------|-------------------|--------------------------|
| Metal Cross/Cold | LWS1-A21-G | LWS1-B21-G | LWS1-C21-G |
| Metal Cross/Hot | LWS1-A22-G | LWS1-B22-G | LWS1-C22-G |
| Plastic Cross/Cold | LWS1-A23-G | LWS1-B23-G | LWS1-C23-G |
| Plastic Cross/Hot | LWS1-A24-G | LWS1-B24-G | LWS1-C24-G |
| Wristblade/Cold | LWS1-A25-G | LWS1-B25-G | LWS1-C25-G |
| Wristblade/Hot | LWS1-A26-G | LWS1-B26-G | LWS1-C26-G |

Straight Nozzle

| Handle/Index | Compression Cartridge | Ceramic Cartridge | Control-A-Flow Cartridge |
|--------------------|-----------------------|-------------------|--------------------------|
| Metal Cross/Cold | LWS1-A11-G | LWS1-B11-G | LWS1-C11-G |
| Metal Cross/Hot | LWS1-A12-G | LWS1-B12-G | LWS1-C12-G |
| Plastic Cross/Cold | LWS1-A13-G | LWS1-B13-G | LWS1-C13-G |
| Plastic Cross/Hot | LWS1-A14-G | LWS1-B14-G | LWS1-C14-G |
| Wristblade/Cold | LWS1-A15-G | LWS1-B15-G | LWS1-C15-G |
| Wristblade/Hot | LWS1-A16-G | LWS1-B16-G | LWS1-C16-G |

Straight Nozzle With Aspirator

| Handle/Index | Compression Cartridge | Ceramic Cartridge | Control-A-Flow Cartridge |
|--------------------|-----------------------|-------------------|--------------------------|
| Metal Cross/Cold | LWS1-A31-G | LWS1-B31-G | LWS1-C31-G |
| Metal Cross/Hot | LWS1-A32-G | LWS1-B32-G | LWS1-C32-G |
| Plastic Cross/Cold | LWS1-A33-G | LWS1-B33-G | LWS1-C33-G |
| Plastic Cross/Hot | LWS1-A34-G | LWS1-B34-G | LWS1-C34-G |
| Wristblade/Cold | LWS1-A35-G | LWS1-B35-G | LWS1-C35-G |
| Wristblade/Hot | LWS1-A36-G | LWS1-B36-G | LWS1-C36-G |

Deck Mounted, Right-Hand Operation, 8" Rigid Spout with Vacuum Breaker

- Solid brass construction
- Polished chrome plated finish
- 1/2" NPSM supply inlet with coupling nut for 3/8" or 1/2" flexible riser



2.2 GPM Aerated Outlet

| Handle/Index | Compression Cartridge | Ceramic Cartridge | Control-A-Flow Cartridge |
|--------------------|-----------------------|-------------------|--------------------------|
| Metal Cross/Cold | LWS1-A21-H | LWS1-B21-H | LWS1-C21-H |
| Metal Cross/Hot | LWS1-A22-H | LWS1-B22-H | LWS1-C22-H |
| Plastic Cross/Cold | LWS1-A23-H | LWS1-B23-H | LWS1-C23-H |
| Plastic Cross/Hot | LWS1-A24-H | LWS1-B24-H | LWS1-C24-H |
| Wristblade/Cold | LWS1-A25-H | LWS1-B25-H | LWS1-C25-H |
| Wristblade/Hot | LWS1-A26-H | LWS1-B26-H | LWS1-C26-H |

Straight Nozzle

| Handle/Index | Compression Cartridge | Ceramic Cartridge | Control-A-Flow Cartridge |
|--------------------|-----------------------|-------------------|--------------------------|
| Metal Cross/Cold | LWS1-A11-H | LWS1-B11-H | LWS1-C11-H |
| Metal Cross/Hot | LWS1-A12-H | LWS1-B12-H | LWS1-C12-H |
| Plastic Cross/Cold | LWS1-A13-H | LWS1-B13-H | LWS1-C13-H |
| Plastic Cross/Hot | LWS1-A14-H | LWS1-B14-H | LWS1-C14-H |
| Wristblade/Cold | LWS1-A15-H | LWS1-B15-H | LWS1-C15-H |
| Wristblade/Hot | LWS1-A16-H | LWS1-B16-H | LWS1-C16-H |

Straight Nozzle With Aspirator

| Handle/Index | Compression Cartridge | Ceramic Cartridge | Control-A-Flow Cartridge |
|--------------------|-----------------------|-------------------|--------------------------|
| Metal Cross/Cold | LWS1-A31-H | LWS1-B31-H | LWS1-C31-H |
| Metal Cross/Hot | LWS1-A32-H | LWS1-B32-H | LWS1-C32-H |
| Plastic Cross/Cold | LWS1-A33-H | LWS1-B33-H | LWS1-C33-H |
| Plastic Cross/Hot | LWS1-A34-H | LWS1-B34-H | LWS1-C34-H |
| Wristblade/Cold | LWS1-A35-H | LWS1-B35-H | LWS1-C35-H |
| Wristblade/Hot | LWS1-A36-H | LWS1-B36-H | LWS1-C36-H |

Deck Mounted, Left-Hand Operation, 5-1/4" Gooseneck Spout

- Solid brass construction
- Polished chrome plated finish
- 1/2" NPSM supply inlet with coupling nut for 3/8" or 1/2" flexible riser



2.2 GPM Aerated Outlet

| Handle/Index | Compression Cartridge | Ceramic Cartridge | Control-A-Flow Cartridge |
|--------------------|-----------------------|-------------------|--------------------------|
| Metal Cross/Cold | LWS2-A21-A | LWS2-B21-A | LWS2-C21-A |
| Metal Cross/Hot | LWS2-A22-A | LWS2-B22-A | LWS2-C22-A |
| Plastic Cross/Cold | LWS2-A23-A | LWS2-B23-A | LWS2-C23-A |
| Plastic Cross/Hot | LWS2-A24-A | LWS2-B24-A | LWS2-C24-A |
| Wristblade/Cold | LWS2-A25-A | LWS2-B25-A | LWS2-C25-A |
| Wristblade/Hot | LWS2-A26-A | LWS2-B26-A | LWS2-C26-A |

Straight Nozzle

| Handle/Index | Compression Cartridge | Ceramic Cartridge | Control-A-Flow Cartridge |
|--------------------|-----------------------|-------------------|--------------------------|
| Metal Cross/Cold | LWS2-A11-A | LWS2-B11-A | LWS2-C11-A |
| Metal Cross/Hot | LWS2-A12-A | LWS2-B12-A | LWS2-C12-A |
| Plastic Cross/Cold | LWS2-A13-A | LWS2-B13-A | LWS2-C13-A |
| Plastic Cross/Hot | LWS2-A14-A | LWS2-B14-A | LWS2-C14-A |
| Wristblade/Cold | LWS2-A15-A | LWS2-B15-A | LWS2-C15-A |
| Wristblade/Hot | LWS2-A16-A | LWS2-B16-A | LWS2-C16-A |

Straight Nozzle With Aspirator

| Handle/Index | Compression Cartridge | Ceramic Cartridge | Control-A-Flow Cartridge |
|--------------------|-----------------------|-------------------|--------------------------|
| Metal Cross/Cold | LWS2-A31-A | LWS2-B31-A | LWS2-C31-A |
| Metal Cross/Hot | LWS2-A32-A | LWS2-B32-A | LWS2-C32-A |
| Plastic Cross/Cold | LWS2-A33-A | LWS2-B33-A | LWS2-C33-A |
| Plastic Cross/Hot | LWS2-A34-A | LWS2-B34-A | LWS2-C34-A |
| Wristblade/Cold | LWS2-A35-A | LWS2-B35-A | LWS2-C35-A |
| Wristblade/Hot | LWS2-A36-A | LWS2-B36-A | LWS2-C36-A |

Deck Mounted, Left-Hand Operation, 8" Gooseneck Spout

- Solid brass construction
- Polished chrome plated finish
- 1/2" NPSM supply inlet with coupling nut for 3/8" or 1/2" flexible riser



2.2 GPM Aerated Outlet

| Handle/Index | Compression Cartridge | Ceramic Cartridge | Control-A-Flow Cartridge |
|--------------------|-----------------------|-------------------|--------------------------|
| Metal Cross/Cold | LWS2-A21-B | LWS2-B21-B | LWS2-C21-B |
| Metal Cross/Hot | LWS2-A22-B | LWS2-B22-B | LWS2-C22-B |
| Plastic Cross/Cold | LWS2-A23-B | LWS2-B23-B | LWS2-C23-B |
| Plastic Cross/Hot | LWS2-A24-B | LWS2-B24-B | LWS2-C24-B |
| Wristblade/Cold | LWS2-A25-B | LWS2-B25-B | LWS2-C25-B |
| Wristblade/Hot | LWS2-A26-B | LWS2-B26-B | LWS2-C26-B |

Straight Nozzle

| Handle/Index | Compression Cartridge | Ceramic Cartridge | Control-A-Flow Cartridge |
|--------------------|-----------------------|-------------------|--------------------------|
| Metal Cross/Cold | LWS2-A11-B | LWS2-B11-B | LWS2-C11-B |
| Metal Cross/Hot | LWS2-A12-B | LWS2-B12-B | LWS2-C12-B |
| Plastic Cross/Cold | LWS2-A13-B | LWS2-B13-B | LWS2-C13-B |
| Plastic Cross/Hot | LWS2-A14-B | LWS2-B14-B | LWS2-C14-B |
| Wristblade/Cold | LWS2-A15-B | LWS2-B15-B | LWS2-C15-B |
| Wristblade/Hot | LWS2-A16-B | LWS2-B16-B | LWS2-C16-B |

Straight Nozzle With Aspirator

| Handle/Index | Compression Cartridge | Ceramic Cartridge | Control-A-Flow Cartridge |
|--------------------|-----------------------|-------------------|--------------------------|
| Metal Cross/Cold | LWS2-A31-B | LWS2-B31-B | LWS2-C31-B |
| Metal Cross/Hot | LWS2-A32-B | LWS2-B32-B | LWS2-C32-B |
| Plastic Cross/Cold | LWS2-A33-B | LWS2-B33-B | LWS2-C33-B |
| Plastic Cross/Hot | LWS2-A34-B | LWS2-B34-B | LWS2-C34-B |
| Wristblade/Cold | LWS2-A35-B | LWS2-B35-B | LWS2-C35-B |
| Wristblade/Hot | LWS2-A36-B | LWS2-B36-B | LWS2-C36-B |

Deck Mounted, Left-Hand Operation, 5-1/4" Gooseneck Spout with Vacuum Breaker

- Solid brass construction
- Polished chrome plated finish
- 1/2" NPSM supply inlet with coupling nut for 3/8" or 1/2" flexible riser



2.2 GPM Aerated Outlet

| Handle/Index | Compression Cartridge | Ceramic Cartridge | Control-A-Flow Cartridge |
|--------------------|-----------------------|-------------------|--------------------------|
| Metal Cross/Cold | LWS2-A21-E | LWS2-B21-E | LWS2-C21-E |
| Metal Cross/Hot | LWS2-A22-E | LWS2-B22-E | LWS2-C22-E |
| Plastic Cross/Cold | LWS2-A23-E | LWS2-B23-E | LWS2-C23-E |
| Plastic Cross/Hot | LWS2-A24-E | LWS2-B24-E | LWS2-C24-E |
| Wristblade/Cold | LWS2-A25-E | LWS2-B25-E | LWS2-C25-E |
| Wristblade/Hot | LWS2-A26-E | LWS2-B26-E | LWS2-C26-E |

Straight Nozzle

| Handle/Index | Compression Cartridge | Ceramic Cartridge | Control-A-Flow Cartridge |
|--------------------|-----------------------|-------------------|--------------------------|
| Metal Cross/Cold | LWS2-A11-E | LWS2-B11-E | LWS2-C11-E |
| Metal Cross/Hot | LWS2-A12-E | LWS2-B12-E | LWS2-C12-E |
| Plastic Cross/Cold | LWS2-A13-E | LWS2-B13-E | LWS2-C13-E |
| Plastic Cross/Hot | LWS2-A14-E | LWS2-B14-E | LWS2-C14-E |
| Wristblade/Cold | LWS2-A15-E | LWS2-B15-E | LWS2-C15-E |
| Wristblade/Hot | LWS2-A16-E | LWS2-B16-E | LWS2-C16-E |

Straight Nozzle With Aspirator

| Handle/Index | Compression Cartridge | Ceramic Cartridge | Control-A-Flow Cartridge |
|--------------------|-----------------------|-------------------|--------------------------|
| Metal Cross/Cold | LWS2-A31-E | LWS2-B31-E | LWS2-C31-E |
| Metal Cross/Hot | LWS2-A32-E | LWS2-B32-E | LWS2-C32-E |
| Plastic Cross/Cold | LWS2-A33-E | LWS2-B33-E | LWS2-C33-E |
| Plastic Cross/Hot | LWS2-A34-E | LWS2-B34-E | LWS2-C34-E |
| Wristblade/Cold | LWS2-A35-E | LWS2-B35-E | LWS2-C35-E |
| Wristblade/Hot | LWS2-A36-E | LWS2-B36-E | LWS2-C36-E |

Deck Mounted, Left-Hand Operation, 8" Gooseneck Spout with Vacuum Breaker

- Solid brass construction
- Polished chrome plated finish
- 1/2" NPSM supply inlet with coupling nut for 3/8" or 1/2" flexible riser



2.2 GPM Aerated Outlet

| Handle/Index | Compression Cartridge | Ceramic Cartridge | Control-A-Flow Cartridge |
|--------------------|-----------------------|-------------------|--------------------------|
| Metal Cross/Cold | LWS2-A21-F | LWS2-B21-F | LWS2-C21-F |
| Metal Cross/Hot | LWS2-A22-F | LWS2-B22-F | LWS2-C22-F |
| Plastic Cross/Cold | LWS2-A23-F | LWS2-B23-F | LWS2-C23-F |
| Plastic Cross/Hot | LWS2-A24-F | LWS2-B24-F | LWS2-C24-F |
| Wristblade/Cold | LWS2-A25-F | LWS2-B25-F | LWS2-C25-F |
| Wristblade/Hot | LWS2-A26-F | LWS2-B26-F | LWS2-C26-F |

Straight Nozzle

| Handle/Index | Compression Cartridge | Ceramic Cartridge | Control-A-Flow Cartridge |
|--------------------|-----------------------|-------------------|--------------------------|
| Metal Cross/Cold | LWS2-A11-F | LWS2-B11-F | LWS2-C11-F |
| Metal Cross/Hot | LWS2-A12-F | LWS2-B12-F | LWS2-C12-F |
| Plastic Cross/Cold | LWS2-A13-F | LWS2-B13-F | LWS2-C13-F |
| Plastic Cross/Hot | LWS2-A14-F | LWS2-B14-F | LWS2-C14-F |
| Wristblade/Cold | LWS2-A15-F | LWS2-B15-F | LWS2-C15-F |
| Wristblade/Hot | LWS2-A16-F | LWS2-B16-F | LWS2-C16-F |

Straight Nozzle With Aspirator

| Handle/Index | Compression Cartridge | Ceramic Cartridge | Control-A-Flow Cartridge |
|--------------------|-----------------------|-------------------|--------------------------|
| Metal Cross/Cold | LWS2-A31-F | LWS2-B31-F | LWS2-C31-F |
| Metal Cross/Hot | LWS2-A32-F | LWS2-B32-F | LWS2-C32-F |
| Plastic Cross/Cold | LWS2-A33-F | LWS2-B33-F | LWS2-C33-F |
| Plastic Cross/Hot | LWS2-A34-F | LWS2-B34-F | LWS2-C34-F |
| Wristblade/Cold | LWS2-A35-F | LWS2-B35-F | LWS2-C35-F |
| Wristblade/Hot | LWS2-A36-F | LWS2-B36-F | LWS2-C36-F |

Deck Mounted, Left-Hand Operation, 5-1/4" Rigid Spout with Vacuum Breaker

- Solid brass construction
- Polished chrome plated finish
- 1/2" NPSM supply inlet with coupling nut for 3/8" or 1/2" flexible riser



2.2 GPM Aerated Outlet

| Handle/Index | Compression Cartridge | Ceramic Cartridge | Control-A-Flow Cartridge |
|--------------------|-----------------------|-------------------|--------------------------|
| Metal Cross/Cold | LWS2-A21-G | LWS2-B21-G | LWS2-C21-G |
| Metal Cross/Hot | LWS2-A22-G | LWS2-B22-G | LWS2-C22-G |
| Plastic Cross/Cold | LWS2-A23-G | LWS2-B23-G | LWS2-C23-G |
| Plastic Cross/Hot | LWS2-A24-G | LWS2-B24-G | LWS2-C24-G |
| Wristblade/Cold | LWS2-A25-G | LWS2-B25-G | LWS2-C25-G |
| Wristblade/Hot | LWS2-A26-G | LWS2-B26-G | LWS2-C26-G |

Straight Nozzle

| Handle/Index | Compression Cartridge | Ceramic Cartridge | Control-A-Flow Cartridge |
|--------------------|-----------------------|-------------------|--------------------------|
| Metal Cross/Cold | LWS2-A11-G | LWS2-B11-G | LWS2-C11-G |
| Metal Cross/Hot | LWS2-A12-G | LWS2-B12-G | LWS2-C12-G |
| Plastic Cross/Cold | LWS2-A13-G | LWS2-B13-G | LWS2-C13-G |
| Plastic Cross/Hot | LWS2-A14-G | LWS2-B14-G | LWS2-C14-G |
| Wristblade/Cold | LWS2-A15-G | LWS2-B15-G | LWS2-C15-G |
| Wristblade/Hot | LWS2-A16-G | LWS2-B16-G | LWS2-C16-G |

Straight Nozzle With Aspirator

| Handle/Index | Compression Cartridge | Ceramic Cartridge | Control-A-Flow Cartridge |
|--------------------|-----------------------|-------------------|--------------------------|
| Metal Cross/Cold | LWS2-A31-G | LWS2-B31-G | LWS2-C31-G |
| Metal Cross/Hot | LWS2-A32-G | LWS2-B32-G | LWS2-C32-G |
| Plastic Cross/Cold | LWS2-A33-G | LWS2-B33-G | LWS2-C33-G |
| Plastic Cross/Hot | LWS2-A34-G | LWS2-B34-G | LWS2-C34-G |
| Wristblade/Cold | LWS2-A35-G | LWS2-B35-G | LWS2-C35-G |
| Wristblade/Hot | LWS2-A36-G | LWS2-B36-G | LWS2-C36-G |

Deck Mounted, Left-Hand Operation, 8" Rigid Spout with Vacuum Breaker

- Solid brass construction
- Polished chrome plated finish
- 1/2" NPSM supply inlet with coupling nut for 3/8" or 1/2" flexible riser



2.2 GPM Aerated Outlet

| Handle/Index | Compression Cartridge | Ceramic Cartridge | Control-A-Flow Cartridge |
|--------------------|-----------------------|-------------------|--------------------------|
| Metal Cross/Cold | LWS2-A21-H | LWS2-B21-H | LWS2-C21-H |
| Metal Cross/Hot | LWS2-A22-H | LWS2-B22-H | LWS2-C22-H |
| Plastic Cross/Cold | LWS2-A23-H | LWS2-B23-H | LWS2-C23-H |
| Plastic Cross/Hot | LWS2-A24-H | LWS2-B24-H | LWS2-C24-H |
| Wristblade/Cold | LWS2-A25-H | LWS2-B25-H | LWS2-C25-H |
| Wristblade/Hot | LWS2-A26-H | LWS2-B26-H | LWS2-C26-H |

Straight Nozzle

| Handle/Index | Compression Cartridge | Ceramic Cartridge | Control-A-Flow Cartridge |
|--------------------|-----------------------|-------------------|--------------------------|
| Metal Cross/Cold | LWS2-A11-H | LWS2-B11-H | LWS2-C11-H |
| Metal Cross/Hot | LWS2-A12-H | LWS2-B12-H | LWS2-C12-H |
| Plastic Cross/Cold | LWS2-A13-H | LWS2-B13-H | LWS2-C13-H |
| Plastic Cross/Hot | LWS2-A14-H | LWS2-B14-H | LWS2-C14-H |
| Wristblade/Cold | LWS2-A15-H | LWS2-B15-H | LWS2-C15-H |
| Wristblade/Hot | LWS2-A16-H | LWS2-B16-H | LWS2-C16-H |

Straight Nozzle With Aspirator

| Handle/Index | Compression Cartridge | Ceramic Cartridge | Control-A-Flow Cartridge |
|--------------------|-----------------------|-------------------|--------------------------|
| Metal Cross/Cold | LWS2-A31-H | LWS2-B31-H | LWS2-C31-H |
| Metal Cross/Hot | LWS2-A32-H | LWS2-B32-H | LWS2-C32-H |
| Plastic Cross/Cold | LWS2-A33-H | LWS2-B33-H | LWS2-C33-H |
| Plastic Cross/Hot | LWS2-A34-H | LWS2-B34-H | LWS2-C34-H |
| Wristblade/Cold | LWS2-A35-H | LWS2-B35-H | LWS2-C35-H |
| Wristblade/Hot | LWS2-A36-H | LWS2-B36-H | LWS2-C36-H |

Deck Mounted, Back-Mounted Handle, 5-1/4" Gooseneck Spout

- Solid brass construction
- Polished chrome plated finish
- 1/2" NPSM supply inlet with coupling nut for 3/8" or 1/2" flexible riser



2.2 GPM Aerated Outlet

| Handle/Index | Compression Cartridge | Ceramic Cartridge | Control-A-Flow Cartridge |
|--------------------|-----------------------|-------------------|--------------------------|
| Metal Cross/Cold | LWS3-A21-A | LWS3-B21-A | LWS3-C21-A |
| Metal Cross/Hot | LWS3-A22-A | LWS3-B22-A | LWS3-C22-A |
| Plastic Cross/Cold | LWS3-A23-A | LWS3-B23-A | LWS3-C23-A |
| Plastic Cross/Hot | LWS3-A24-A | LWS3-B24-A | LWS3-C24-A |
| Wristblade/Cold | LWS3-A25-A | LWS3-B25-A | LWS3-C25-A |
| Wristblade/Hot | LWS3-A26-A | LWS3-B26-A | LWS3-C26-A |

Straight Nozzle

| Handle/Index | Compression Cartridge | Ceramic Cartridge | Control-A-Flow Cartridge |
|--------------------|-----------------------|-------------------|--------------------------|
| Metal Cross/Cold | LWS3-A11-A | LWS3-B11-A | LWS3-C11-A |
| Metal Cross/Hot | LWS3-A12-A | LWS3-B12-A | LWS3-C12-A |
| Plastic Cross/Cold | LWS3-A13-A | LWS3-B13-A | LWS3-C13-A |
| Plastic Cross/Hot | LWS3-A14-A | LWS3-B14-A | LWS3-C14-A |
| Wristblade/Cold | LWS3-A15-A | LWS3-B15-A | LWS3-C15-A |
| Wristblade/Hot | LWS3-A16-A | LWS3-B16-A | LWS3-C16-A |

Straight Nozzle With Aspirator

| Handle/Index | Compression Cartridge | Ceramic Cartridge | Control-A-Flow Cartridge |
|--------------------|-----------------------|-------------------|--------------------------|
| Metal Cross/Cold | LWS3-A31-A | LWS3-B31-A | LWS3-C31-A |
| Metal Cross/Hot | LWS3-A32-A | LWS3-B32-A | LWS3-C32-A |
| Plastic Cross/Cold | LWS3-A33-A | LWS3-B33-A | LWS3-C33-A |
| Plastic Cross/Hot | LWS3-A34-A | LWS3-B34-A | LWS3-C34-A |
| Wristblade/Cold | LWS3-A35-A | LWS3-B35-A | LWS3-C35-A |
| Wristblade/Hot | LWS3-A36-A | LWS3-B36-A | LWS3-C36-A |

Deck Mounted, Back-Mounted Handle, 8" Gooseneck Spout

- Solid brass construction
- Polished chrome plated finish
- 1/2" NPSM supply inlet with coupling nut for 3/8" or 1/2" flexible riser



2.2 GPM Aerated Outlet

| Handle/Index | Compression Cartridge | Ceramic Cartridge | Control-A-Flow Cartridge |
|--------------------|-----------------------|-------------------|--------------------------|
| Metal Cross/Cold | LWS3-A21-B | LWS3-B21-B | LWS3-C21-B |
| Metal Cross/Hot | LWS3-A22-B | LWS3-B22-B | LWS3-C22-B |
| Plastic Cross/Cold | LWS3-A23-B | LWS3-B23-B | LWS3-C23-B |
| Plastic Cross/Hot | LWS3-A24-B | LWS3-B24-B | LWS3-C24-B |
| Wristblade/Cold | LWS3-A25-B | LWS3-B25-B | LWS3-C25-B |
| Wristblade/Hot | LWS3-A26-B | LWS3-B26-B | LWS3-C26-B |

Straight Nozzle

| Handle/Index | Compression Cartridge | Ceramic Cartridge | Control-A-Flow Cartridge |
|--------------------|-----------------------|-------------------|--------------------------|
| Metal Cross/Cold | LWS3-A11-B | LWS3-B11-B | LWS3-C11-B |
| Metal Cross/Hot | LWS3-A12-B | LWS3-B12-B | LWS3-C12-B |
| Plastic Cross/Cold | LWS3-A13-B | LWS3-B13-B | LWS3-C13-B |
| Plastic Cross/Hot | LWS3-A14-B | LWS3-B14-B | LWS3-C14-B |
| Wristblade/Cold | LWS3-A15-B | LWS3-B15-B | LWS3-C15-B |
| Wristblade/Hot | LWS3-A16-B | LWS3-B16-B | LWS3-C16-B |

Straight Nozzle With Aspirator

| Handle/Index | Compression Cartridge | Ceramic Cartridge | Control-A-Flow Cartridge |
|--------------------|-----------------------|-------------------|--------------------------|
| Metal Cross/Cold | LWS3-A31-B | LWS3-B31-B | LWS3-C31-B |
| Metal Cross/Hot | LWS3-A32-B | LWS3-B32-B | LWS3-C32-B |
| Plastic Cross/Cold | LWS3-A33-B | LWS3-B33-B | LWS3-C33-B |
| Plastic Cross/Hot | LWS3-A34-B | LWS3-B34-B | LWS3-C34-B |
| Wristblade/Cold | LWS3-A35-B | LWS3-B35-B | LWS3-C35-B |
| Wristblade/Hot | LWS3-A36-B | LWS3-B36-B | LWS3-C36-B |

Deck Mounted, Back-Mounted Handle, 5-1/4" Gooseneck Spout with Vacuum Breaker

- Solid brass construction
- Polished chrome plated finish
- 1/2" NPSM supply inlet with coupling nut for 3/8" or 1/2" flexible riser



2.2 GPM Aerated Outlet

| Handle/Index | Compression Cartridge | Ceramic Cartridge | Control-A-Flow Cartridge |
|--------------------|-----------------------|-------------------|--------------------------|
| Metal Cross/Cold | LWS3-A21-E | LWS3-B21-E | LWS3-C21-E |
| Metal Cross/Hot | LWS3-A22-E | LWS3-B22-E | LWS3-C22-E |
| Plastic Cross/Cold | LWS3-A23-E | LWS3-B23-E | LWS3-C23-E |
| Plastic Cross/Hot | LWS3-A24-E | LWS3-B24-E | LWS3-C24-E |
| Wristblade/Cold | LWS3-A25-E | LWS3-B25-E | LWS3-C25-E |
| Wristblade/Hot | LWS3-A26-E | LWS3-B26-E | LWS3-C26-E |

Straight Nozzle

| Handle/Index | Compression Cartridge | Ceramic Cartridge | Control-A-Flow Cartridge |
|--------------------|-----------------------|-------------------|--------------------------|
| Metal Cross/Cold | LWS3-A11-E | LWS3-B11-E | LWS3-C11-E |
| Metal Cross/Hot | LWS3-A12-E | LWS3-B12-E | LWS3-C12-E |
| Plastic Cross/Cold | LWS3-A13-E | LWS3-B13-E | LWS3-C13-E |
| Plastic Cross/Hot | LWS3-A14-E | LWS3-B14-E | LWS3-C14-E |
| Wristblade/Cold | LWS3-A15-E | LWS3-B15-E | LWS3-C15-E |
| Wristblade/Hot | LWS3-A16-E | LWS3-B16-E | LWS3-C16-E |

Straight Nozzle With Aspirator

| Handle/Index | Compression Cartridge | Ceramic Cartridge | Control-A-Flow Cartridge |
|--------------------|-----------------------|-------------------|--------------------------|
| Metal Cross/Cold | LWS3-A31-E | LWS3-B31-E | LWS3-C31-E |
| Metal Cross/Hot | LWS3-A32-E | LWS3-B32-E | LWS3-C32-E |
| Plastic Cross/Cold | LWS3-A33-E | LWS3-B33-E | LWS3-C33-E |
| Plastic Cross/Hot | LWS3-A34-E | LWS3-B34-E | LWS3-C34-E |
| Wristblade/Cold | LWS3-A35-E | LWS3-B35-E | LWS3-C35-E |
| Wristblade/Hot | LWS3-A36-E | LWS3-B36-E | LWS3-C36-E |

Deck Mounted, Back-Mounted Handle, 8" Gooseneck Spout with Vacuum Breaker

- Solid brass construction
- Polished chrome plated finish
- 1/2" NPSM supply inlet with coupling nut for 3/8" or 1/2" flexible riser



2.2 GPM Aerated Outlet

| Handle/Index | Compression Cartridge | Ceramic Cartridge | Control-A-Flow Cartridge |
|--------------------|-----------------------|-------------------|--------------------------|
| Metal Cross/Cold | LWS3-A21-F | LWS3-B21-F | LWS3-C21-F |
| Metal Cross/Hot | LWS3-A22-F | LWS3-B22-F | LWS3-C22-F |
| Plastic Cross/Cold | LWS3-A23-F | LWS3-B23-F | LWS3-C23-F |
| Plastic Cross/Hot | LWS3-A24-F | LWS3-B24-F | LWS3-C24-F |
| Wristblade/Cold | LWS3-A25-F | LWS3-B25-F | LWS3-C25-F |
| Wristblade/Hot | LWS3-A26-F | LWS3-B26-F | LWS3-C26-F |

Straight Nozzle

| Handle/Index | Compression Cartridge | Ceramic Cartridge | Control-A-Flow Cartridge |
|--------------------|-----------------------|-------------------|--------------------------|
| Metal Cross/Cold | LWS3-A11-F | LWS3-B11-F | LWS3-C11-F |
| Metal Cross/Hot | LWS3-A12-F | LWS3-B12-F | LWS3-C12-F |
| Plastic Cross/Cold | LWS3-A13-F | LWS3-B13-F | LWS3-C13-F |
| Plastic Cross/Hot | LWS3-A14-F | LWS3-B14-F | LWS3-C14-F |
| Wristblade/Cold | LWS3-A15-F | LWS3-B15-F | LWS3-C15-F |
| Wristblade/Hot | LWS3-A16-F | LWS3-B16-F | LWS3-C16-F |

Straight Nozzle With Aspirator

| Handle/Index | Compression Cartridge | Ceramic Cartridge | Control-A-Flow Cartridge |
|--------------------|-----------------------|-------------------|--------------------------|
| Metal Cross/Cold | LWS3-A31-F | LWS3-B31-F | LWS3-C31-F |
| Metal Cross/Hot | LWS3-A32-F | LWS3-B32-F | LWS3-C32-F |
| Plastic Cross/Cold | LWS3-A33-F | LWS3-B33-F | LWS3-C33-F |
| Plastic Cross/Hot | LWS3-A34-F | LWS3-B34-F | LWS3-C34-F |
| Wristblade/Cold | LWS3-A35-F | LWS3-B35-F | LWS3-C35-F |
| Wristblade/Hot | LWS3-A36-F | LWS3-B36-F | LWS3-C36-F |

Deck Mounted, Back-Mounted Handle, 5-1/4" Rigid Spout with Vacuum Breaker

- Solid brass construction
- Polished chrome plated finish
- 1/2" NPSM supply inlet with coupling nut for 3/8" or 1/2" flexible riser



2.2 GPM Aerated Outlet

| Handle/Index | Compression Cartridge | Ceramic Cartridge | Control-A-Flow Cartridge |
|--------------------|-----------------------|-------------------|--------------------------|
| Metal Cross/Cold | LWS3-A21-G | LWS3-B21-G | LWS3-C21-G |
| Metal Cross/Hot | LWS3-A22-G | LWS3-B22-G | LWS3-C22-G |
| Plastic Cross/Cold | LWS3-A23-G | LWS3-B23-G | LWS3-C23-G |
| Plastic Cross/Hot | LWS3-A24-G | LWS3-B24-G | LWS3-C24-G |
| Wristblade/Cold | LWS3-A25-G | LWS3-B25-G | LWS3-C25-G |
| Wristblade/Hot | LWS3-A26-G | LWS3-B26-G | LWS3-C26-G |

Straight Nozzle

| Handle/Index | Compression Cartridge | Ceramic Cartridge | Control-A-Flow Cartridge |
|--------------------|-----------------------|-------------------|--------------------------|
| Metal Cross/Cold | LWS3-A11-G | LWS3-B11-G | LWS3-C11-G |
| Metal Cross/Hot | LWS3-A12-G | LWS3-B12-G | LWS3-C12-G |
| Plastic Cross/Cold | LWS3-A13-G | LWS3-B13-G | LWS3-C13-G |
| Plastic Cross/Hot | LWS3-A14-G | LWS3-B14-G | LWS3-C14-G |
| Wristblade/Cold | LWS3-A15-G | LWS3-B15-G | LWS3-C15-G |
| Wristblade/Hot | LWS3-A16-G | LWS3-B16-G | LWS3-C16-G |

Straight Nozzle With Aspirator

| Handle/Index | Compression Cartridge | Ceramic Cartridge | Control-A-Flow Cartridge |
|--------------------|-----------------------|-------------------|--------------------------|
| Metal Cross/Cold | LWS3-A31-G | LWS3-B31-G | LWS3-C31-G |
| Metal Cross/Hot | LWS3-A32-G | LWS3-B32-G | LWS3-C32-G |
| Plastic Cross/Cold | LWS3-A33-G | LWS3-B33-G | LWS3-C33-G |
| Plastic Cross/Hot | LWS3-A34-G | LWS3-B34-G | LWS3-C34-G |
| Wristblade/Cold | LWS3-A35-G | LWS3-B35-G | LWS3-C35-G |
| Wristblade/Hot | LWS3-A36-G | LWS3-B36-G | LWS3-C36-G |

Deck Mounted, Back-Mounted Handle, 8" Rigid Spout with Vacuum Breaker

- Solid brass construction
- Polished chrome plated finish
- 1/2" NPSM supply inlet with coupling nut for 3/8" or 1/2" flexible riser



2.2 GPM Aerated Outlet

| Handle/Index | Compression Cartridge | Ceramic Cartridge | Control-A-Flow Cartridge |
|--------------------|-----------------------|-------------------|--------------------------|
| Metal Cross/Cold | LWS3-A21-H | LWS3-B21-H | LWS3-C21-H |
| Metal Cross/Hot | LWS3-A22-H | LWS3-B22-H | LWS3-C22-H |
| Plastic Cross/Cold | LWS3-A23-H | LWS3-B23-H | LWS3-C23-H |
| Plastic Cross/Hot | LWS3-A24-H | LWS3-B24-H | LWS3-C24-H |
| Wristblade/Cold | LWS3-A25-H | LWS3-B25-H | LWS3-C25-H |
| Wristblade/Hot | LWS3-A26-H | LWS3-B26-H | LWS3-C26-H |

Straight Nozzle

| Handle/Index | Compression Cartridge | Ceramic Cartridge | Control-A-Flow Cartridge |
|--------------------|-----------------------|-------------------|--------------------------|
| Metal Cross/Cold | LWS3-A11-H | LWS3-B11-H | LWS3-C11-H |
| Metal Cross/Hot | LWS3-A12-H | LWS3-B12-H | LWS3-C12-H |
| Plastic Cross/Cold | LWS3-A13-H | LWS3-B13-H | LWS3-C13-H |
| Plastic Cross/Hot | LWS3-A14-H | LWS3-B14-H | LWS3-C14-H |
| Wristblade/Cold | LWS3-A15-H | LWS3-B15-H | LWS3-C15-H |
| Wristblade/Hot | LWS3-A16-H | LWS3-B16-H | LWS3-C16-H |

Straight Nozzle With Aspirator

| Handle/Index | Compression Cartridge | Ceramic Cartridge | Control-A-Flow Cartridge |
|--------------------|-----------------------|-------------------|--------------------------|
| Metal Cross/Cold | LWS3-A31-H | LWS3-B31-H | LWS3-C31-H |
| Metal Cross/Hot | LWS3-A32-H | LWS3-B32-H | LWS3-C32-H |
| Plastic Cross/Cold | LWS3-A33-H | LWS3-B33-H | LWS3-C33-H |
| Plastic Cross/Hot | LWS3-A34-H | LWS3-B34-H | LWS3-C34-H |
| Wristblade/Cold | LWS3-A35-H | LWS3-B35-H | LWS3-C35-H |
| Wristblade/Hot | LWS3-A36-H | LWS3-B36-H | LWS3-C36-H |

Wall Mounted, 5-1/4" Gooseneck Spout, Less Shank

- Solid brass construction
- Polished chrome plated finish
- 1/2" NPT female thread inlet with integral flange



2.2 GPM Aerated Outlet

| Handle/Index | Compression Cartridge | Ceramic Cartridge | Control-A-Flow Cartridge |
|--------------------|-----------------------|-------------------|--------------------------|
| Metal Cross/Cold | LWS4-A21-A | LWS4-B21-A | LWS4-C21-A |
| Metal Cross/Hot | LWS4-A22-A | LWS4-B22-A | LWS4-C22-A |
| Plastic Cross/Cold | LWS4-A23-A | LWS4-B23-A | LWS4-C23-A |
| Plastic Cross/Hot | LWS4-A24-A | LWS4-B24-A | LWS4-C24-A |
| Wristblade/Cold | LWS4-A25-A | LWS4-B25-A | LWS4-C25-A |
| Wristblade/Hot | LWS4-A26-A | LWS4-B26-A | LWS4-C26-A |

Straight Nozzle

| Handle/Index | Compression Cartridge | Ceramic Cartridge | Control-A-Flow Cartridge |
|--------------------|-----------------------|-------------------|--------------------------|
| Metal Cross/Cold | LWS4-A11-A | LWS4-B11-A | LWS4-C11-A |
| Metal Cross/Hot | LWS4-A12-A | LWS4-B12-A | LWS4-C12-A |
| Plastic Cross/Cold | LWS4-A13-A | LWS4-B13-A | LWS4-C13-A |
| Plastic Cross/Hot | LWS4-A14-A | LWS4-B14-A | LWS4-C14-A |
| Wristblade/Cold | LWS4-A15-A | LWS4-B15-A | LWS4-C15-A |
| Wristblade/Hot | LWS4-A16-A | LWS4-B16-A | LWS4-C16-A |

Straight Nozzle With Aspirator

| Handle/Index | Compression Cartridge | Ceramic Cartridge | Control-A-Flow Cartridge |
|--------------------|-----------------------|-------------------|--------------------------|
| Metal Cross/Cold | LWS4-A31-A | LWS4-B31-A | LWS4-C31-A |
| Metal Cross/Hot | LWS4-A32-A | LWS4-B32-A | LWS4-C32-A |
| Plastic Cross/Cold | LWS4-A33-A | LWS4-B33-A | LWS4-C33-A |
| Plastic Cross/Hot | LWS4-A34-A | LWS4-B34-A | LWS4-C34-A |
| Wristblade/Cold | LWS4-A35-A | LWS4-B35-A | LWS4-C35-A |
| Wristblade/Hot | LWS4-A36-A | LWS4-B36-A | LWS4-C36-A |

Wall Mounted, 8" Gooseneck Spout, Less Shank

- Solid brass construction
- Polished chrome plated finish
- 1/2" NPT female thread inlet with integral flange



2.2 GPM Aerated Outlet

| Handle/Index | Compression Cartridge | Ceramic Cartridge | Control-A-Flow Cartridge |
|--------------------|-----------------------|-------------------|--------------------------|
| Metal Cross/Cold | LWS4-A21-B | LWS4-B21-B | LWS4-C21-B |
| Metal Cross/Hot | LWS4-A22-B | LWS4-B22-B | LWS4-C22-B |
| Plastic Cross/Cold | LWS4-A23-B | LWS4-B23-B | LWS4-C23-B |
| Plastic Cross/Hot | LWS4-A24-B | LWS4-B24-B | LWS4-C24-B |
| Wristblade/Cold | LWS4-A25-B | LWS4-B25-B | LWS4-C25-B |
| Wristblade/Hot | LWS4-A26-B | LWS4-B26-B | LWS4-C26-B |

Straight Nozzle

| Handle/Index | Compression Cartridge | Ceramic Cartridge | Control-A-Flow Cartridge |
|--------------------|-----------------------|-------------------|--------------------------|
| Metal Cross/Cold | LWS4-A11-B | LWS4-B11-B | LWS4-C11-B |
| Metal Cross/Hot | LWS4-A12-B | LWS4-B12-B | LWS4-C12-B |
| Plastic Cross/Cold | LWS4-A13-B | LWS4-B13-B | LWS4-C13-B |
| Plastic Cross/Hot | LWS4-A14-B | LWS4-B14-B | LWS4-C14-B |
| Wristblade/Cold | LWS4-A15-B | LWS4-B15-B | LWS4-C15-B |
| Wristblade/Hot | LWS4-A16-B | LWS4-B16-B | LWS4-C16-B |

Straight Nozzle With Aspirator

| Handle/Index | Compression Cartridge | Ceramic Cartridge | Control-A-Flow Cartridge |
|--------------------|-----------------------|-------------------|--------------------------|
| Metal Cross/Cold | LWS4-A31-B | LWS4-B31-B | LWS4-C31-B |
| Metal Cross/Hot | LWS4-A32-B | LWS4-B32-B | LWS4-C32-B |
| Plastic Cross/Cold | LWS4-A33-B | LWS4-B33-B | LWS4-C33-B |
| Plastic Cross/Hot | LWS4-A34-B | LWS4-B34-B | LWS4-C34-B |
| Wristblade/Cold | LWS4-A35-B | LWS4-B35-B | LWS4-C35-B |
| Wristblade/Hot | LWS4-A36-B | LWS4-B36-B | LWS4-C36-B |

Wall Mounted, 5-1/4" Gooseneck Spout with Vacuum Breaker, Less Shank

- Solid brass construction
- Polished chrome plated finish
- 1/2" NPT female thread inlet with integral flange



2.2 GPM Aerated Outlet

| Handle/Index | Compression Cartridge | Ceramic Cartridge | Control-A-Flow Cartridge |
|--------------------|-----------------------|-------------------|--------------------------|
| Metal Cross/Cold | LWS4-A21-E | LWS4-B21-E | LWS4-C21-E |
| Metal Cross/Hot | LWS4-A22-E | LWS4-B22-E | LWS4-C22-E |
| Plastic Cross/Cold | LWS4-A23-E | LWS4-B23-E | LWS4-C23-E |
| Plastic Cross/Hot | LWS4-A24-E | LWS4-B24-E | LWS4-C24-E |
| Wristblade/Cold | LWS4-A25-E | LWS4-B25-E | LWS4-C25-E |
| Wristblade/Hot | LWS4-A26-E | LWS4-B26-E | LWS4-C26-E |

Straight Nozzle

| Handle/Index | Compression Cartridge | Ceramic Cartridge | Control-A-Flow Cartridge |
|--------------------|-----------------------|-------------------|--------------------------|
| Metal Cross/Cold | LWS4-A11-E | LWS4-B11-E | LWS4-C11-E |
| Metal Cross/Hot | LWS4-A12-E | LWS4-B12-E | LWS4-C12-E |
| Plastic Cross/Cold | LWS4-A13-E | LWS4-B13-E | LWS4-C13-E |
| Plastic Cross/Hot | LWS4-A14-E | LWS4-B14-E | LWS4-C14-E |
| Wristblade/Cold | LWS4-A15-E | LWS4-B15-E | LWS4-C15-E |
| Wristblade/Hot | LWS4-A16-E | LWS4-B16-E | LWS4-C16-E |

Straight Nozzle With Aspirator

| Handle/Index | Compression Cartridge | Ceramic Cartridge | Control-A-Flow Cartridge |
|--------------------|-----------------------|-------------------|--------------------------|
| Metal Cross/Cold | LWS4-A31-E | LWS4-B31-E | LWS4-C31-E |
| Metal Cross/Hot | LWS4-A32-E | LWS4-B32-E | LWS4-C32-E |
| Plastic Cross/Cold | LWS4-A33-E | LWS4-B33-E | LWS4-C33-E |
| Plastic Cross/Hot | LWS4-A34-E | LWS4-B34-E | LWS4-C34-E |
| Wristblade/Cold | LWS4-A35-E | LWS4-B35-E | LWS4-C35-E |
| Wristblade/Hot | LWS4-A36-E | LWS4-B36-E | LWS4-C36-E |

Wall Mounted, 8" Gooseneck Spout with Vacuum Breaker, Less Shank

- Solid brass construction
- Polished chrome plated finish
- 1/2" NPT female thread inlet with integral flange



2.2 GPM Aerated Outlet

| Handle/Index | Compression Cartridge | Ceramic Cartridge | Control-A-Flow Cartridge |
|--------------------|-----------------------|-------------------|--------------------------|
| Metal Cross/Cold | LWS4-A21-F | LWS4-B21-F | LWS4-C21-F |
| Metal Cross/Hot | LWS4-A22-F | LWS4-B22-F | LWS4-C22-F |
| Plastic Cross/Cold | LWS4-A23-F | LWS4-B23-F | LWS4-C23-F |
| Plastic Cross/Hot | LWS4-A24-F | LWS4-B24-F | LWS4-C24-F |
| Wristblade/Cold | LWS4-A25-F | LWS4-B25-F | LWS4-C25-F |
| Wristblade/Hot | LWS4-A26-F | LWS4-B26-F | LWS4-C26-F |

Straight Nozzle

| Handle/Index | Compression Cartridge | Ceramic Cartridge | Control-A-Flow Cartridge |
|--------------------|-----------------------|-------------------|--------------------------|
| Metal Cross/Cold | LWS4-A11-F | LWS4-B11-F | LWS4-C11-F |
| Metal Cross/Hot | LWS4-A12-F | LWS4-B12-F | LWS4-C12-F |
| Plastic Cross/Cold | LWS4-A13-F | LWS4-B13-F | LWS4-C13-F |
| Plastic Cross/Hot | LWS4-A14-F | LWS4-B14-F | LWS4-C14-F |
| Wristblade/Cold | LWS4-A15-F | LWS4-B15-F | LWS4-C15-F |
| Wristblade/Hot | LWS4-A16-F | LWS4-B16-F | LWS4-C16-F |

Straight Nozzle With Aspirator

| Handle/Index | Compression Cartridge | Ceramic Cartridge | Control-A-Flow Cartridge |
|--------------------|-----------------------|-------------------|--------------------------|
| Metal Cross/Cold | LWS4-A31-F | LWS4-B31-F | LWS4-C31-F |
| Metal Cross/Hot | LWS4-A32-F | LWS4-B32-F | LWS4-C32-F |
| Plastic Cross/Cold | LWS4-A33-F | LWS4-B33-F | LWS4-C33-F |
| Plastic Cross/Hot | LWS4-A34-F | LWS4-B34-F | LWS4-C34-F |
| Wristblade/Cold | LWS4-A35-F | LWS4-B35-F | LWS4-C35-F |
| Wristblade/Hot | LWS4-A36-F | LWS4-B36-F | LWS4-C36-F |

Wall Mounted, 5-1/4" Rigid Spout with Vacuum Breaker, Less Shank

- Solid brass construction
- Polished chrome plated finish
- 1/2" NPT female thread inlet with integral flange



2.2 GPM Aerated Outlet

| Handle/Index | Compression Cartridge | Ceramic Cartridge | Control-A-Flow Cartridge |
|--------------------|-----------------------|-------------------|--------------------------|
| Metal Cross/Cold | LWS4-A21-G | LWS4-B21-G | LWS4-C21-G |
| Metal Cross/Hot | LWS4-A22-G | LWS4-B22-G | LWS4-C22-G |
| Plastic Cross/Cold | LWS4-A23-G | LWS4-B23-G | LWS4-C23-G |
| Plastic Cross/Hot | LWS4-A24-G | LWS4-B24-G | LWS4-C24-G |
| Wristblade/Cold | LWS4-A25-G | LWS4-B25-G | LWS4-C25-G |
| Wristblade/Hot | LWS4-A26-G | LWS4-B26-G | LWS4-C26-G |

Straight Nozzle

| Handle/Index | Compression Cartridge | Ceramic Cartridge | Control-A-Flow Cartridge |
|--------------------|-----------------------|-------------------|--------------------------|
| Metal Cross/Cold | LWS4-A11-G | LWS4-B11-G | LWS4-C11-G |
| Metal Cross/Hot | LWS4-A12-G | LWS4-B12-G | LWS4-C12-G |
| Plastic Cross/Cold | LWS4-A13-G | LWS4-B13-G | LWS4-C13-G |
| Plastic Cross/Hot | LWS4-A14-G | LWS4-B14-G | LWS4-C14-G |
| Wristblade/Cold | LWS4-A15-G | LWS4-B15-G | LWS4-C15-G |
| Wristblade/Hot | LWS4-A16-G | LWS4-B16-G | LWS4-C16-G |

Straight Nozzle With Aspirator

| Handle/Index | Compression Cartridge | Ceramic Cartridge | Control-A-Flow Cartridge |
|--------------------|-----------------------|-------------------|--------------------------|
| Metal Cross/Cold | LWS4-A31-G | LWS4-B31-G | LWS4-C31-G |
| Metal Cross/Hot | LWS4-A32-G | LWS4-B32-G | LWS4-C32-G |
| Plastic Cross/Cold | LWS4-A33-G | LWS4-B33-G | LWS4-C33-G |
| Plastic Cross/Hot | LWS4-A34-G | LWS4-B34-G | LWS4-C34-G |
| Wristblade/Cold | LWS4-A35-G | LWS4-B35-G | LWS4-C35-G |
| Wristblade/Hot | LWS4-A36-G | LWS4-B36-G | LWS4-C36-G |

Wall Mounted, 8" Rigid Spout with Vacuum Breaker, Less Shank

- Solid brass construction
- Polished chrome plated finish
- 1/2" NPT female thread inlet with integral flange



2.2 GPM Aerated Outlet

| Handle/Index | Compression Cartridge | Ceramic Cartridge | Control-A-Flow Cartridge |
|--------------------|-----------------------|-------------------|--------------------------|
| Metal Cross/Cold | LWS4-A21-H | LWS4-B21-H | LWS4-C21-H |
| Metal Cross/Hot | LWS4-A22-H | LWS4-B22-H | LWS4-C22-H |
| Plastic Cross/Cold | LWS4-A23-H | LWS4-B23-H | LWS4-C23-H |
| Plastic Cross/Hot | LWS4-A24-H | LWS4-B24-H | LWS4-C24-H |
| Wristblade/Cold | LWS4-A25-H | LWS4-B25-H | LWS4-C25-H |
| Wristblade/Hot | LWS4-A26-H | LWS4-B26-H | LWS4-C26-H |

Straight Nozzle

| Handle/Index | Compression Cartridge | Ceramic Cartridge | Control-A-Flow Cartridge |
|--------------------|-----------------------|-------------------|--------------------------|
| Metal Cross/Cold | LWS4-A11-H | LWS4-B11-H | LWS4-C11-H |
| Metal Cross/Hot | LWS4-A12-H | LWS4-B12-H | LWS4-C12-H |
| Plastic Cross/Cold | LWS4-A13-H | LWS4-B13-H | LWS4-C13-H |
| Plastic Cross/Hot | LWS4-A14-H | LWS4-B14-H | LWS4-C14-H |
| Wristblade/Cold | LWS4-A15-H | LWS4-B15-H | LWS4-C15-H |
| Wristblade/Hot | LWS4-A16-H | LWS4-B16-H | LWS4-C16-H |

Straight Nozzle With Aspirator

| Handle/Index | Compression Cartridge | Ceramic Cartridge | Control-A-Flow Cartridge |
|--------------------|-----------------------|-------------------|--------------------------|
| Metal Cross/Cold | LWS4-A31-H | LWS4-B31-H | LWS4-C31-H |
| Metal Cross/Hot | LWS4-A32-H | LWS4-B32-H | LWS4-C32-H |
| Plastic Cross/Cold | LWS4-A33-H | LWS4-B33-H | LWS4-C33-H |
| Plastic Cross/Hot | LWS4-A34-H | LWS4-B34-H | LWS4-C34-H |
| Wristblade/Cold | LWS4-A35-H | LWS4-B35-H | LWS4-C35-H |
| Wristblade/Hot | LWS4-A36-H | LWS4-B36-H | LWS4-C36-H |

Wall Mounted, 5-1/4" Gooseneck Spout, with Shank

- Solid brass construction
- Polished chrome plated finish
- 1/2" NPT male thread shank assembly with integral flange



2.2 GPM Aerated Outlet

| Handle/Index | Compression Cartridge | Ceramic Cartridge | Control-A-Flow Cartridge |
|--------------------|-----------------------|-------------------|--------------------------|
| Metal Cross/Cold | LWS5-A21-A | LWS5-B21-A | LWS5-C21-A |
| Metal Cross/Hot | LWS5-A22-A | LWS5-B22-A | LWS5-C22-A |
| Plastic Cross/Cold | LWS5-A23-A | LWS5-B23-A | LWS5-C23-A |
| Plastic Cross/Hot | LWS5-A24-A | LWS5-B24-A | LWS5-C24-A |
| Wristblade/Cold | LWS5-A25-A | LWS5-B25-A | LWS5-C25-A |
| Wristblade/Hot | LWS5-A26-A | LWS5-B26-A | LWS5-C26-A |

Straight Nozzle

| Handle/Index | Compression Cartridge | Ceramic Cartridge | Control-A-Flow Cartridge |
|--------------------|-----------------------|-------------------|--------------------------|
| Metal Cross/Cold | LWS5-A11-A | LWS5-B11-A | LWS5-C11-A |
| Metal Cross/Hot | LWS5-A12-A | LWS5-B12-A | LWS5-C12-A |
| Plastic Cross/Cold | LWS5-A13-A | LWS5-B13-A | LWS5-C13-A |
| Plastic Cross/Hot | LWS5-A14-A | LWS5-B14-A | LWS5-C14-A |
| Wristblade/Cold | LWS5-A15-A | LWS5-B15-A | LWS5-C15-A |
| Wristblade/Hot | LWS5-A16-A | LWS5-B16-A | LWS5-C16-A |

Straight Nozzle With Aspirator

| Handle/Index | Compression Cartridge | Ceramic Cartridge | Control-A-Flow Cartridge |
|--------------------|-----------------------|-------------------|--------------------------|
| Metal Cross/Cold | LWS5-A31-A | LWS5-B31-A | LWS5-C31-A |
| Metal Cross/Hot | LWS5-A32-A | LWS5-B32-A | LWS5-C32-A |
| Plastic Cross/Cold | LWS5-A33-A | LWS5-B33-A | LWS5-C33-A |
| Plastic Cross/Hot | LWS5-A34-A | LWS5-B34-A | LWS5-C34-A |
| Wristblade/Cold | LWS5-A35-A | LWS5-B35-A | LWS5-C35-A |
| Wristblade/Hot | LWS5-A36-A | LWS5-B36-A | LWS5-C36-A |

Wall Mounted, 8" Gooseneck Spout, with Shank

- Solid brass construction
- Polished chrome plated finish
- 1/2" NPT male thread shank assembly with integral flange



2.2 GPM Aerated Outlet

| Handle/Index | Compression Cartridge | Ceramic Cartridge | Control-A-Flow Cartridge |
|--------------------|-----------------------|-------------------|--------------------------|
| Metal Cross/Cold | LWS5-A21-B | LWS5-B21-B | LWS5-C21-B |
| Metal Cross/Hot | LWS5-A22-B | LWS5-B22-B | LWS5-C22-B |
| Plastic Cross/Cold | LWS5-A23-B | LWS5-B23-B | LWS5-C23-B |
| Plastic Cross/Hot | LWS5-A24-B | LWS5-B24-B | LWS5-C24-B |
| Wristblade/Cold | LWS5-A25-B | LWS5-B25-B | LWS5-C25-B |
| Wristblade/Hot | LWS5-A26-B | LWS5-B26-B | LWS5-C26-B |

Straight Nozzle

| Handle/Index | Compression Cartridge | Ceramic Cartridge | Control-A-Flow Cartridge |
|--------------------|-----------------------|-------------------|--------------------------|
| Metal Cross/Cold | LWS5-A11-B | LWS5-B11-B | LWS5-C11-B |
| Metal Cross/Hot | LWS5-A12-B | LWS5-B12-B | LWS5-C12-B |
| Plastic Cross/Cold | LWS5-A13-B | LWS5-B13-B | LWS5-C13-B |
| Plastic Cross/Hot | LWS5-A14-B | LWS5-B14-B | LWS5-C14-B |
| Wristblade/Cold | LWS5-A15-B | LWS5-B15-B | LWS5-C15-B |
| Wristblade/Hot | LWS5-A16-B | LWS5-B16-B | LWS5-C16-B |

Straight Nozzle With Aspirator

| Handle/Index | Compression Cartridge | Ceramic Cartridge | Control-A-Flow Cartridge |
|--------------------|-----------------------|-------------------|--------------------------|
| Metal Cross/Cold | LWS5-A31-B | LWS5-B31-B | LWS5-C31-B |
| Metal Cross/Hot | LWS5-A32-B | LWS5-B32-B | LWS5-C32-B |
| Plastic Cross/Cold | LWS5-A33-B | LWS5-B33-B | LWS5-C33-B |
| Plastic Cross/Hot | LWS5-A34-B | LWS5-B34-B | LWS5-C34-B |
| Wristblade/Cold | LWS5-A35-B | LWS5-B35-B | LWS5-C35-B |
| Wristblade/Hot | LWS5-A36-B | LWS5-B36-B | LWS5-C36-B |

Wall Mounted, 5-1/4" Gooseneck Spout with Vacuum Breaker, with Shank

- Solid brass construction
- Polished chrome plated finish
- 1/2" NPT male thread shank assembly with integral flange



2.2 GPM Aerated Outlet

| Handle/Index | Compression Cartridge | Ceramic Cartridge | Control-A-Flow Cartridge |
|--------------------|-----------------------|-------------------|--------------------------|
| Metal Cross/Cold | LWS5-A21-E | LWS5-B21-E | LWS5-C21-E |
| Metal Cross/Hot | LWS5-A22-E | LWS5-B22-E | LWS5-C22-E |
| Plastic Cross/Cold | LWS5-A23-E | LWS5-B23-E | LWS5-C23-E |
| Plastic Cross/Hot | LWS5-A24-E | LWS5-B24-E | LWS5-C24-E |
| Wristblade/Cold | LWS5-A25-E | LWS5-B25-E | LWS5-C25-E |
| Wristblade/Hot | LWS5-A26-E | LWS5-B26-E | LWS5-C26-E |

Straight Nozzle

| Handle/Index | Compression Cartridge | Ceramic Cartridge | Control-A-Flow Cartridge |
|--------------------|-----------------------|-------------------|--------------------------|
| Metal Cross/Cold | LWS5-A11-E | LWS5-B11-E | LWS5-C11-E |
| Metal Cross/Hot | LWS5-A12-E | LWS5-B12-E | LWS5-C12-E |
| Plastic Cross/Cold | LWS5-A13-E | LWS5-B13-E | LWS5-C13-E |
| Plastic Cross/Hot | LWS5-A14-E | LWS5-B14-E | LWS5-C14-E |
| Wristblade/Cold | LWS5-A15-E | LWS5-B15-E | LWS5-C15-E |
| Wristblade/Hot | LWS5-A16-E | LWS5-B16-E | LWS5-C16-E |

Straight Nozzle With Aspirator

| Handle/Index | Compression Cartridge | Ceramic Cartridge | Control-A-Flow Cartridge |
|--------------------|-----------------------|-------------------|--------------------------|
| Metal Cross/Cold | LWS5-A31-E | LWS5-B31-E | LWS5-C31-E |
| Metal Cross/Hot | LWS5-A32-E | LWS5-B32-E | LWS5-C32-E |
| Plastic Cross/Cold | LWS5-A33-E | LWS5-B33-E | LWS5-C33-E |
| Plastic Cross/Hot | LWS5-A34-E | LWS5-B34-E | LWS5-C34-E |
| Wristblade/Cold | LWS5-A35-E | LWS5-B35-E | LWS5-C35-E |
| Wristblade/Hot | LWS5-A36-E | LWS5-B36-E | LWS5-C36-E |

Wall Mounted, 8" Gooseneck Spout with Vacuum Breaker, with Shank

- Solid brass construction
- Polished chrome plated finish
- 1/2" NPT male thread shank assembly with integral flange



2.2 GPM Aerated Outlet

| Handle/Index | Compression Cartridge | Ceramic Cartridge | Control-A-Flow Cartridge |
|--------------------|-----------------------|-------------------|--------------------------|
| Metal Cross/Cold | LWS5-A21-F | LWS5-B21-F | LWS5-C21-F |
| Metal Cross/Hot | LWS5-A22-F | LWS5-B22-F | LWS5-C22-F |
| Plastic Cross/Cold | LWS5-A23-F | LWS5-B23-F | LWS5-C23-F |
| Plastic Cross/Hot | LWS5-A24-F | LWS5-B24-F | LWS5-C24-F |
| Wristblade/Cold | LWS5-A25-F | LWS5-B25-F | LWS5-C25-F |
| Wristblade/Hot | LWS5-A26-F | LWS5-B26-F | LWS5-C26-F |

Straight Nozzle

| Handle/Index | Compression Cartridge | Ceramic Cartridge | Control-A-Flow Cartridge |
|--------------------|-----------------------|-------------------|--------------------------|
| Metal Cross/Cold | LWS5-A11-F | LWS5-B11-F | LWS5-C11-F |
| Metal Cross/Hot | LWS5-A12-F | LWS5-B12-F | LWS5-C12-F |
| Plastic Cross/Cold | LWS5-A13-F | LWS5-B13-F | LWS5-C13-F |
| Plastic Cross/Hot | LWS5-A14-F | LWS5-B14-F | LWS5-C14-F |
| Wristblade/Cold | LWS5-A15-F | LWS5-B15-F | LWS5-C15-F |
| Wristblade/Hot | LWS5-A16-F | LWS5-B16-F | LWS5-C16-F |

Straight Nozzle With Aspirator

| Handle/Index | Compression Cartridge | Ceramic Cartridge | Control-A-Flow Cartridge |
|--------------------|-----------------------|-------------------|--------------------------|
| Metal Cross/Cold | LWS5-A31-F | LWS5-B31-F | LWS5-C31-F |
| Metal Cross/Hot | LWS5-A32-F | LWS5-B32-F | LWS5-C32-F |
| Plastic Cross/Cold | LWS5-A33-F | LWS5-B33-F | LWS5-C33-F |
| Plastic Cross/Hot | LWS5-A34-F | LWS5-B34-F | LWS5-C34-F |
| Wristblade/Cold | LWS5-A35-F | LWS5-B35-F | LWS5-C35-F |
| Wristblade/Hot | LWS5-A36-F | LWS5-B36-F | LWS5-C36-F |

Wall Mounted, 5-1/4" Rigid Spout with Vacuum Breaker, with Shank

- Solid brass construction
- Polished chrome plated finish
- 1/2" NPT male thread shank assembly with integral flange



2.2 GPM Aerated Outlet

| Handle/Index | Compression Cartridge | Ceramic Cartridge | Control-A-Flow Cartridge |
|--------------------|-----------------------|-------------------|--------------------------|
| Metal Cross/Cold | LWS5-A21-G | LWS5-B21-G | LWS5-C21-G |
| Metal Cross/Hot | LWS5-A22-G | LWS5-B22-G | LWS5-C22-G |
| Plastic Cross/Cold | LWS5-A23-G | LWS5-B23-G | LWS5-C23-G |
| Plastic Cross/Hot | LWS5-A24-G | LWS5-B24-G | LWS5-C24-G |
| Wristblade/Cold | LWS5-A25-G | LWS5-B25-G | LWS5-C25-G |
| Wristblade/Hot | LWS5-A26-G | LWS5-B26-G | LWS5-C26-G |

Straight Nozzle

| Handle/Index | Compression Cartridge | Ceramic Cartridge | Control-A-Flow Cartridge |
|--------------------|-----------------------|-------------------|--------------------------|
| Metal Cross/Cold | LWS5-A11-G | LWS5-B11-G | LWS5-C11-G |
| Metal Cross/Hot | LWS5-A12-G | LWS5-B12-G | LWS5-C12-G |
| Plastic Cross/Cold | LWS5-A13-G | LWS5-B13-G | LWS5-C13-G |
| Plastic Cross/Hot | LWS5-A14-G | LWS5-B14-G | LWS5-C14-G |
| Wristblade/Cold | LWS5-A15-G | LWS5-B15-G | LWS5-C15-G |
| Wristblade/Hot | LWS5-A16-G | LWS5-B16-G | LWS5-C16-G |

Straight Nozzle With Aspirator

| Handle/Index | Compression Cartridge | Ceramic Cartridge | Control-A-Flow Cartridge |
|--------------------|-----------------------|-------------------|--------------------------|
| Metal Cross/Cold | LWS5-A31-G | LWS5-B31-G | LWS5-C31-G |
| Metal Cross/Hot | LWS5-A32-G | LWS5-B32-G | LWS5-C32-G |
| Plastic Cross/Cold | LWS5-A33-G | LWS5-B33-G | LWS5-C33-G |
| Plastic Cross/Hot | LWS5-A34-G | LWS5-B34-G | LWS5-C34-G |
| Wristblade/Cold | LWS5-A35-G | LWS5-B35-G | LWS5-C35-G |
| Wristblade/Hot | LWS5-A36-G | LWS5-B36-G | LWS5-C36-G |

Wall Mounted, 8" Rigid Spout with Vacuum Breaker, with Shank

- Solid brass construction
- Polished chrome plated finish
- 1/2" NPT male thread shank assembly with integral flange



2.2 GPM Aerated Outlet

| Handle/Index | Compression Cartridge | Ceramic Cartridge | Control-A-Flow Cartridge |
|--------------------|-----------------------|-------------------|--------------------------|
| Metal Cross/Cold | LWS5-A21-H | LWS5-B21-H | LWS5-C21-H |
| Metal Cross/Hot | LWS5-A22-H | LWS5-B22-H | LWS5-C22-H |
| Plastic Cross/Cold | LWS5-A23-H | LWS5-B23-H | LWS5-C23-H |
| Plastic Cross/Hot | LWS5-A24-H | LWS5-B24-H | LWS5-C24-H |
| Wristblade/Cold | LWS5-A25-H | LWS5-B25-H | LWS5-C25-H |
| Wristblade/Hot | LWS5-A26-H | LWS5-B26-H | LWS5-C26-H |

Straight Nozzle

| Handle/Index | Compression Cartridge | Ceramic Cartridge | Control-A-Flow Cartridge |
|--------------------|-----------------------|-------------------|--------------------------|
| Metal Cross/Cold | LWS5-A11-H | LWS5-B11-H | LWS5-C11-H |
| Metal Cross/Hot | LWS5-A12-H | LWS5-B12-H | LWS5-C12-H |
| Plastic Cross/Cold | LWS5-A13-H | LWS5-B13-H | LWS5-C13-H |
| Plastic Cross/Hot | LWS5-A14-H | LWS5-B14-H | LWS5-C14-H |
| Wristblade/Cold | LWS5-A15-H | LWS5-B15-H | LWS5-C15-H |
| Wristblade/Hot | LWS5-A16-H | LWS5-B16-H | LWS5-C16-H |

Straight Nozzle With Aspirator

| Handle/Index | Compression Cartridge | Ceramic Cartridge | Control-A-Flow Cartridge |
|--------------------|-----------------------|-------------------|--------------------------|
| Metal Cross/Cold | LWS5-A31-H | LWS5-B31-H | LWS5-C31-H |
| Metal Cross/Hot | LWS5-A32-H | LWS5-B32-H | LWS5-C32-H |
| Plastic Cross/Cold | LWS5-A33-H | LWS5-B33-H | LWS5-C33-H |
| Plastic Cross/Hot | LWS5-A34-H | LWS5-B34-H | LWS5-C34-H |
| Wristblade/Cold | LWS5-A35-H | LWS5-B35-H | LWS5-C35-H |
| Wristblade/Hot | LWS5-A36-H | LWS5-B36-H | LWS5-C36-H |

Deck Mounted, Turret with Front-Mount Handle, 5-1/4" Gooseneck Spout

- Solid brass construction
- Polished chrome plated finish
- 1/2" NPSM supply inlet with coupling nut for 3/8" or 1/2" flexible riser



2.2 GPM Aerated Outlet

| Handle/Index | Compression Cartridge | Ceramic Cartridge | Control-A-Flow Cartridge |
|--------------------|-----------------------|-------------------|--------------------------|
| Metal Cross/Cold | LWS6-A21-A | LWS6-B21-A | LWS6-C21-A |
| Metal Cross/Hot | LWS6-A22-A | LWS6-B22-A | LWS6-C22-A |
| Plastic Cross/Cold | LWS6-A23-A | LWS6-B23-A | LWS6-C23-A |
| Plastic Cross/Hot | LWS6-A24-A | LWS6-B24-A | LWS6-C24-A |
| Wristblade/Cold | LWS6-A25-A | LWS6-B25-A | LWS6-C25-A |
| Wristblade/Hot | LWS6-A26-A | LWS6-B26-A | LWS6-C26-A |

Straight Nozzle

| Handle/Index | Compression Cartridge | Ceramic Cartridge | Control-A-Flow Cartridge |
|--------------------|-----------------------|-------------------|--------------------------|
| Metal Cross/Cold | LWS6-A11-A | LWS6-B11-A | LWS6-C11-A |
| Metal Cross/Hot | LWS6-A12-A | LWS6-B12-A | LWS6-C12-A |
| Plastic Cross/Cold | LWS6-A13-A | LWS6-B13-A | LWS6-C13-A |
| Plastic Cross/Hot | LWS6-A14-A | LWS6-B14-A | LWS6-C14-A |
| Wristblade/Cold | LWS6-A15-A | LWS6-B15-A | LWS6-C15-A |
| Wristblade/Hot | LWS6-A16-A | LWS6-B16-A | LWS6-C16-A |

Straight Nozzle With Aspirator

| Handle/Index | Compression Cartridge | Ceramic Cartridge | Control-A-Flow Cartridge |
|--------------------|-----------------------|-------------------|--------------------------|
| Metal Cross/Cold | LWS6-A31-A | LWS6-B31-A | LWS6-C31-A |
| Metal Cross/Hot | LWS6-A32-A | LWS6-B32-A | LWS6-C32-A |
| Plastic Cross/Cold | LWS6-A33-A | LWS6-B33-A | LWS6-C33-A |
| Plastic Cross/Hot | LWS6-A34-A | LWS6-B34-A | LWS6-C34-A |
| Wristblade/Cold | LWS6-A35-A | LWS6-B35-A | LWS6-C35-A |
| Wristblade/Hot | LWS6-A36-A | LWS6-B36-A | LWS6-C36-A |

Deck Mounted, Turret with Front-Mount Handle, 8" Gooseneck Spout

- Solid brass construction
- Polished chrome plated finish
- 1/2" NPSM supply inlet with coupling nut for 3/8" or 1/2" flexible riser



2.2 GPM Aerated Outlet

| Handle/Index | Compression Cartridge | Ceramic Cartridge | Control-A-Flow Cartridge |
|--------------------|-----------------------|-------------------|--------------------------|
| Metal Cross/Cold | LWS6-A21-B | LWS6-B21-B | LWS6-C21-B |
| Metal Cross/Hot | LWS6-A22-B | LWS6-B22-B | LWS6-C22-B |
| Plastic Cross/Cold | LWS6-A23-B | LWS6-B23-B | LWS6-C23-B |
| Plastic Cross/Hot | LWS6-A24-B | LWS6-B24-B | LWS6-C24-B |
| Wristblade/Cold | LWS6-A25-B | LWS6-B25-B | LWS6-C25-B |
| Wristblade/Hot | LWS6-A26-B | LWS6-B26-B | LWS6-C26-B |

Straight Nozzle

| Handle/Index | Compression Cartridge | Ceramic Cartridge | Control-A-Flow Cartridge |
|--------------------|-----------------------|-------------------|--------------------------|
| Metal Cross/Cold | LWS6-A11-B | LWS6-B11-B | LWS6-C11-B |
| Metal Cross/Hot | LWS6-A12-B | LWS6-B12-B | LWS6-C12-B |
| Plastic Cross/Cold | LWS6-A13-B | LWS6-B13-B | LWS6-C13-B |
| Plastic Cross/Hot | LWS6-A14-B | LWS6-B14-B | LWS6-C14-B |
| Wristblade/Cold | LWS6-A15-B | LWS6-B15-B | LWS6-C15-B |
| Wristblade/Hot | LWS6-A16-B | LWS6-B16-B | LWS6-C16-B |

Straight Nozzle With Aspirator

| Handle/Index | Compression Cartridge | Ceramic Cartridge | Control-A-Flow Cartridge |
|--------------------|-----------------------|-------------------|--------------------------|
| Metal Cross/Cold | LWS6-A31-B | LWS6-B31-B | LWS6-C31-B |
| Metal Cross/Hot | LWS6-A32-B | LWS6-B32-B | LWS6-C32-B |
| Plastic Cross/Cold | LWS6-A33-B | LWS6-B33-B | LWS6-C33-B |
| Plastic Cross/Hot | LWS6-A34-B | LWS6-B34-B | LWS6-C34-B |
| Wristblade/Cold | LWS6-A35-B | LWS6-B35-B | LWS6-C35-B |
| Wristblade/Hot | LWS6-A36-B | LWS6-B36-B | LWS6-C36-B |

Deck Mounted, Turret with Front-Mount Handle, 5-1/4" Gooseneck Spout with Vacuum Breaker

- Solid brass construction
- Polished chrome plated finish
- 1/2" NPSM supply inlet with coupling nut for 3/8" or 1/2" flexible riser



2.2 GPM Aerated Outlet

| Handle/Index | Compression Cartridge | Ceramic Cartridge | Control-A-Flow Cartridge |
|--------------------|-----------------------|-------------------|--------------------------|
| Metal Cross/Cold | LWS6-A21-E | LWS6-B21-E | LWS6-C21-E |
| Metal Cross/Hot | LWS6-A22-E | LWS6-B22-E | LWS6-C22-E |
| Plastic Cross/Cold | LWS6-A23-E | LWS6-B23-E | LWS6-C23-E |
| Plastic Cross/Hot | LWS6-A24-E | LWS6-B24-E | LWS6-C24-E |
| Wristblade/Cold | LWS6-A25-E | LWS6-B25-E | LWS6-C25-E |
| Wristblade/Hot | LWS6-A26-E | LWS6-B26-E | LWS6-C26-E |

Straight Nozzle

| Handle/Index | Compression Cartridge | Ceramic Cartridge | Control-A-Flow Cartridge |
|--------------------|-----------------------|-------------------|--------------------------|
| Metal Cross/Cold | LWS6-A11-E | LWS6-B11-E | LWS6-C11-E |
| Metal Cross/Hot | LWS6-A12-E | LWS6-B12-E | LWS6-C12-E |
| Plastic Cross/Cold | LWS6-A13-E | LWS6-B13-E | LWS6-C13-E |
| Plastic Cross/Hot | LWS6-A14-E | LWS6-B14-E | LWS6-C14-E |
| Wristblade/Cold | LWS6-A15-E | LWS6-B15-E | LWS6-C15-E |
| Wristblade/Hot | LWS6-A16-E | LWS6-B16-E | LWS6-C16-E |

Straight Nozzle With Aspirator

| Handle/Index | Compression Cartridge | Ceramic Cartridge | Control-A-Flow Cartridge |
|--------------------|-----------------------|-------------------|--------------------------|
| Metal Cross/Cold | LWS6-A31-E | LWS6-B31-E | LWS6-C31-E |
| Metal Cross/Hot | LWS6-A32-E | LWS6-B32-E | LWS6-C32-E |
| Plastic Cross/Cold | LWS6-A33-E | LWS6-B33-E | LWS6-C33-E |
| Plastic Cross/Hot | LWS6-A34-E | LWS6-B34-E | LWS6-C34-E |
| Wristblade/Cold | LWS6-A35-E | LWS6-B35-E | LWS6-C35-E |
| Wristblade/Hot | LWS6-A36-E | LWS6-B36-E | LWS6-C36-E |

Deck Mounted, Turret with Front-Mount Handle, 8" Gooseneck Spout with Vacuum Breaker

- Solid brass construction
- Polished chrome plated finish
- 1/2" NPSM supply inlet with coupling nut for 3/8" or 1/2" flexible riser



2.2 GPM Aerated Outlet

| Handle/Index | Compression Cartridge | Ceramic Cartridge | Control-A-Flow Cartridge |
|--------------------|-----------------------|-------------------|--------------------------|
| Metal Cross/Cold | LWS6-A21-F | LWS6-B21-F | LWS6-C21-F |
| Metal Cross/Hot | LWS6-A22-F | LWS6-B22-F | LWS6-C22-F |
| Plastic Cross/Cold | LWS6-A23-F | LWS6-B23-F | LWS6-C23-F |
| Plastic Cross/Hot | LWS6-A24-F | LWS6-B24-F | LWS6-C24-F |
| Wristblade/Cold | LWS6-A25-F | LWS6-B25-F | LWS6-C25-F |
| Wristblade/Hot | LWS6-A26-F | LWS6-B26-F | LWS6-C26-F |

Straight Nozzle

| Handle/Index | Compression Cartridge | Ceramic Cartridge | Control-A-Flow Cartridge |
|--------------------|-----------------------|-------------------|--------------------------|
| Metal Cross/Cold | LWS6-A11-F | LWS6-B11-F | LWS6-C11-F |
| Metal Cross/Hot | LWS6-A12-F | LWS6-B12-F | LWS6-C12-F |
| Plastic Cross/Cold | LWS6-A13-F | LWS6-B13-F | LWS6-C13-F |
| Plastic Cross/Hot | LWS6-A14-F | LWS6-B14-F | LWS6-C14-F |
| Wristblade/Cold | LWS6-A15-F | LWS6-B15-F | LWS6-C15-F |
| Wristblade/Hot | LWS6-A16-F | LWS6-B16-F | LWS6-C16-F |

Straight Nozzle With Aspirator

| Handle/Index | Compression Cartridge | Ceramic Cartridge | Control-A-Flow Cartridge |
|--------------------|-----------------------|-------------------|--------------------------|
| Metal Cross/Cold | LWS6-A31-F | LWS6-B31-F | LWS6-C31-F |
| Metal Cross/Hot | LWS6-A32-F | LWS6-B32-F | LWS6-C32-F |
| Plastic Cross/Cold | LWS6-A33-F | LWS6-B33-F | LWS6-C33-F |
| Plastic Cross/Hot | LWS6-A34-F | LWS6-B34-F | LWS6-C34-F |
| Wristblade/Cold | LWS6-A35-F | LWS6-B35-F | LWS6-C35-F |
| Wristblade/Hot | LWS6-A36-F | LWS6-B36-F | LWS6-C36-F |

Deck Mounted, Turret with Front-Mount Handle, 5-1/4" Rigid Spout with Vacuum Breaker

- Solid brass construction
- Polished chrome plated finish
- 1/2" NPSM supply inlet with coupling nut for 3/8" or 1/2" flexible riser



2.2 GPM Aerated Outlet

| Handle/Index | Compression Cartridge | Ceramic Cartridge | Control-A-Flow Cartridge |
|--------------------|-----------------------|-------------------|--------------------------|
| Metal Cross/Cold | LWS6-A21-G | LWS6-B21-G | LWS6-C21-G |
| Metal Cross/Hot | LWS6-A22-G | LWS6-B22-G | LWS6-C22-G |
| Plastic Cross/Cold | LWS6-A23-G | LWS6-B23-G | LWS6-C23-G |
| Plastic Cross/Hot | LWS6-A24-G | LWS6-B24-G | LWS6-C24-G |
| Wristblade/Cold | LWS6-A25-G | LWS6-B25-G | LWS6-C25-G |
| Wristblade/Hot | LWS6-A26-G | LWS6-B26-G | LWS6-C26-G |

Straight Nozzle

| Handle/Index | Compression Cartridge | Ceramic Cartridge | Control-A-Flow Cartridge |
|--------------------|-----------------------|-------------------|--------------------------|
| Metal Cross/Cold | LWS6-A11-G | LWS6-B11-G | LWS6-C11-G |
| Metal Cross/Hot | LWS6-A12-G | LWS6-B12-G | LWS6-C12-G |
| Plastic Cross/Cold | LWS6-A13-G | LWS6-B13-G | LWS6-C13-G |
| Plastic Cross/Hot | LWS6-A14-G | LWS6-B14-G | LWS6-C14-G |
| Wristblade/Cold | LWS6-A15-G | LWS6-B15-G | LWS6-C15-G |
| Wristblade/Hot | LWS6-A16-G | LWS6-B16-G | LWS6-C16-G |

Straight Nozzle With Aspirator

| Handle/Index | Compression Cartridge | Ceramic Cartridge | Control-A-Flow Cartridge |
|--------------------|-----------------------|-------------------|--------------------------|
| Metal Cross/Cold | LWS6-A31-G | LWS6-B31-G | LWS6-C31-G |
| Metal Cross/Hot | LWS6-A32-G | LWS6-B32-G | LWS6-C32-G |
| Plastic Cross/Cold | LWS6-A33-G | LWS6-B33-G | LWS6-C33-G |
| Plastic Cross/Hot | LWS6-A34-G | LWS6-B34-G | LWS6-C34-G |
| Wristblade/Cold | LWS6-A35-G | LWS6-B35-G | LWS6-C35-G |
| Wristblade/Hot | LWS6-A36-G | LWS6-B36-G | LWS6-C36-G |

Deck Mounted, Turret with Front-Mount Handle, 8" Rigid Spout with Vacuum Breaker

- Solid brass construction
- Polished chrome plated finish
- 1/2" NPSM supply inlet with coupling nut for 3/8" or 1/2" flexible riser



2.2 GPM Aerated Outlet

| Handle/Index | Compression Cartridge | Ceramic Cartridge | Control-A-Flow Cartridge |
|--------------------|-----------------------|-------------------|--------------------------|
| Metal Cross/Cold | LWS6-A21-H | LWS6-B21-H | LWS6-C21-H |
| Metal Cross/Hot | LWS6-A22-H | LWS6-B22-H | LWS6-C22-H |
| Plastic Cross/Cold | LWS6-A23-H | LWS6-B23-H | LWS6-C23-H |
| Plastic Cross/Hot | LWS6-A24-H | LWS6-B24-H | LWS6-C24-H |
| Wristblade/Cold | LWS6-A25-H | LWS6-B25-H | LWS6-C25-H |
| Wristblade/Hot | LWS6-A26-H | LWS6-B26-H | LWS6-C26-H |

Straight Nozzle

| Handle/Index | Compression Cartridge | Ceramic Cartridge | Control-A-Flow Cartridge |
|--------------------|-----------------------|-------------------|--------------------------|
| Metal Cross/Cold | LWS6-A11-H | LWS6-B11-H | LWS6-C11-H |
| Metal Cross/Hot | LWS6-A12-H | LWS6-B12-H | LWS6-C12-H |
| Plastic Cross/Cold | LWS6-A13-H | LWS6-B13-H | LWS6-C13-H |
| Plastic Cross/Hot | LWS6-A14-H | LWS6-B14-H | LWS6-C14-H |
| Wristblade/Cold | LWS6-A15-H | LWS6-B15-H | LWS6-C15-H |
| Wristblade/Hot | LWS6-A16-H | LWS6-B16-H | LWS6-C16-H |

Straight Nozzle With Aspirator

| Handle/Index | Compression Cartridge | Ceramic Cartridge | Control-A-Flow Cartridge |
|--------------------|-----------------------|-------------------|--------------------------|
| Metal Cross/Cold | LWS6-A31-H | LWS6-B31-H | LWS6-C31-H |
| Metal Cross/Hot | LWS6-A32-H | LWS6-B32-H | LWS6-C32-H |
| Plastic Cross/Cold | LWS6-A33-H | LWS6-B33-H | LWS6-C33-H |
| Plastic Cross/Hot | LWS6-A34-H | LWS6-B34-H | LWS6-C34-H |
| Wristblade/Cold | LWS6-A35-H | LWS6-B35-H | LWS6-C35-H |
| Wristblade/Hot | LWS6-A36-H | LWS6-B36-H | LWS6-C36-H |

How to build and order a Chicago Faucets laboratory water mixing faucet.

Chicago Faucets makes it easy for you to build a water mixing faucet that meets your exact requirements. You can reference the charts on the following pages, or you can build your own faucet by choosing the components below to configure your model number.

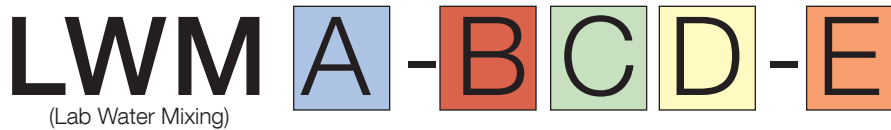

Base

A

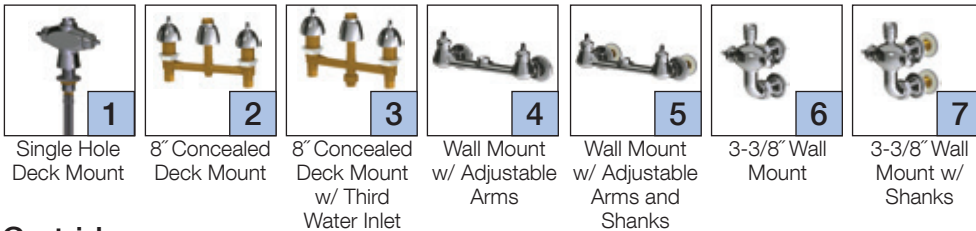

Cartridge

B

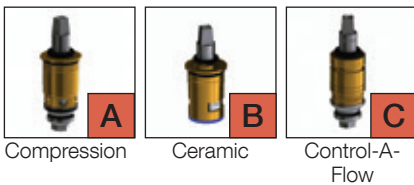

Outlet

C

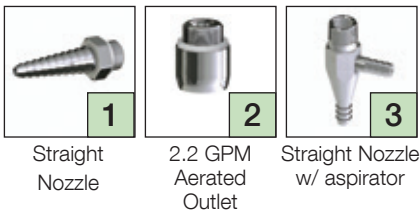

Handles

D

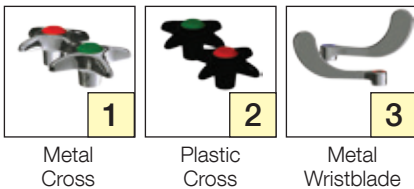

Spouts

E

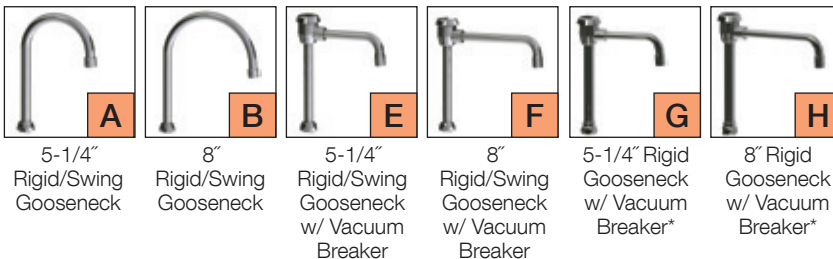

EXAMPLE



LWM2-A11-A
8" concealed deck mount, compression cartridge, straight nozzle, metal cross handles, and 5-1/4" gooseneck spout.

**Rigid spouts can not be used on base number 2 or base number 3.*

Deck Mounted, Single Hole, with 5-1/4" Gooseneck Spout



- Solid brass construction
- Polished chrome plated finish
- 3/8" compression stainless steel hoses
- Gooseneck spout includes rigid/swing option

2.2 GPM Aerated Outlet

| Handle | Compression Cartridge | Ceramic Cartridge | Control-A-Flow Cartridge |
|------------------|-----------------------|-------------------|--------------------------|
| Metal Cross | LWM1-A21-A | LWM1-B21-A | LWM1-C21-A |
| Plastic Cross | LWM1-A22-A | LWM1-B22-A | LWM1-C22-A |
| Metal Wristblade | LWM1-A23-A | LWM1-B23-A | LWM1-C23-A |

Straight Nozzle

| Handle | Compression Cartridge | Ceramic Cartridge | Control-A-Flow Cartridge |
|------------------|-----------------------|-------------------|--------------------------|
| Metal Cross | LWM1-A11-A | LWM1-B11-A | LWM1-C11-A |
| Plastic Cross | LWM1-A12-A | LWM1-B12-A | LWM1-C12-A |
| Metal Wristblade | LWM1-A13-A | LWM1-B13-A | LWM1-C13-A |

Straight Nozzle With Aspirator

| Handle | Compression Cartridge | Ceramic Cartridge | Control-A-Flow Cartridge |
|------------------|-----------------------|-------------------|--------------------------|
| Metal Cross | LWM1-A31-A | LWM1-B31-A | LWM1-C31-A |
| Plastic Cross | LWM1-A32-A | LWM1-B32-A | LWM1-C32-A |
| Metal Wristblade | LWM1-A33-A | LWM1-B33-A | LWM1-C33-A |

Deck Mounted, Single Hole, with 8" Gooseneck Spout



- Solid brass construction
- Polished chrome plated finish
- 3/8" compression stainless steel hoses
- Gooseneck spout includes rigid/swing option

2.2 GPM Aerated Outlet

| Handle | Compression Cartridge | Ceramic Cartridge | Control-A-Flow Cartridge |
|------------------|-----------------------|-------------------|--------------------------|
| Metal Cross | LWM1-A21-B | LWM1-B21-B | LWM1-C21-B |
| Plastic Cross | LWM1-A22-B | LWM1-B22-B | LWM1-C22-B |
| Metal Wristblade | LWM1-A23-B | LWM1-B23-B | LWM1-C23-B |

Straight Nozzle

| Handle | Compression Cartridge | Ceramic Cartridge | Control-A-Flow Cartridge |
|------------------|-----------------------|-------------------|--------------------------|
| Metal Cross | LWM1-A11-B | LWM1-B11-B | LWM1-C11-B |
| Plastic Cross | LWM1-A12-B | LWM1-B12-B | LWM1-C12-B |
| Metal Wristblade | LWM1-A13-B | LWM1-B13-B | LWM1-C13-B |

Straight Nozzle With Aspirator

| Handle | Compression Cartridge | Ceramic Cartridge | Control-A-Flow Cartridge |
|------------------|-----------------------|-------------------|--------------------------|
| Metal Cross | LWM1-A31-B | LWM1-B31-B | LWM1-C31-B |
| Plastic Cross | LWM1-A32-B | LWM1-B32-B | LWM1-C32-B |
| Metal Wristblade | LWM1-A33-B | LWM1-B33-B | LWM1-C33-B |

Deck Mounted, Single Hole, 5-1/4" Gooseneck Spout with Vacuum Breaker

- Solid brass construction
- Polished chrome plated finish
- 3/8" compression stainless steel hoses
- Gooseneck spout includes rigid/swing option



Straight Nozzle

| Handle | Compression Cartridge | Ceramic Cartridge | Control-A-Flow Cartridge |
|------------------|-----------------------|-------------------|--------------------------|
| Metal Cross | LWM1-A11-E | LWM1-B11-E | LWM1-C11-E |
| Plastic Cross | LWM1-A12-E | LWM1-B12-E | LWM1-C12-E |
| Metal Wristblade | LWM1-A13-E | LWM1-B13-E | LWM1-C13-E |

2.2 GPM Aerated Outlet

| Handle | Compression Cartridge | Ceramic Cartridge | Control-A-Flow Cartridge |
|------------------|-----------------------|-------------------|--------------------------|
| Metal Cross | LWM1-A21-E | LWM1-B21-E | LWM1-C21-E |
| Plastic Cross | LWM1-A22-E | LWM1-B22-E | LWM1-C22-E |
| Metal Wristblade | LWM1-A23-E | LWM1-B23-E | LWM1-C23-E |

Straight Nozzle With Aspirator

| Handle | Compression Cartridge | Ceramic Cartridge | Control-A-Flow Cartridge |
|------------------|-----------------------|-------------------|--------------------------|
| Metal Cross | LWM1-A31-E | LWM1-B31-E | LWM1-C31-E |
| Plastic Cross | LWM1-A32-E | LWM1-B32-E | LWM1-C32-E |
| Metal Wristblade | LWM1-A33-E | LWM1-B33-E | LWM1-C33-E |

Deck Mounted, Single Hole, 8" Gooseneck Spout with Vacuum Breaker

- Solid brass construction
- Polished chrome plated finish
- 3/8" compression stainless steel hoses
- Gooseneck spout includes rigid/swing option



Straight Nozzle

| Handle | Compression Cartridge | Ceramic Cartridge | Control-A-Flow Cartridge |
|------------------|-----------------------|-------------------|--------------------------|
| Metal Cross | LWM1-A11-F | LWM1-B11-F | LWM1-C11-F |
| Plastic Cross | LWM1-A12-F | LWM1-B12-F | LWM1-C12-F |
| Metal Wristblade | LWM1-A13-F | LWM1-B13-F | LWM1-C13-F |

2.2 GPM Aerated Outlet

| Handle | Compression Cartridge | Ceramic Cartridge | Control-A-Flow Cartridge |
|------------------|-----------------------|-------------------|--------------------------|
| Metal Cross | LWM1-A21-F | LWM1-B21-F | LWM1-C21-F |
| Plastic Cross | LWM1-A22-F | LWM1-B22-F | LWM1-C22-F |
| Metal Wristblade | LWM1-A23-F | LWM1-B23-F | LWM1-C23-F |

Straight Nozzle With Aspirator

| Handle | Compression Cartridge | Ceramic Cartridge | Control-A-Flow Cartridge |
|------------------|-----------------------|-------------------|--------------------------|
| Metal Cross | LWM1-A31-F | LWM1-B31-F | LWM1-C31-F |
| Plastic Cross | LWM1-A32-F | LWM1-B32-F | LWM1-C32-F |
| Metal Wristblade | LWM1-A33-F | LWM1-B33-F | LWM1-C33-F |

Deck Mounted, Single Hole, 5-1/4" Rigid Gooseneck Spout with Vacuum Breaker

- Solid brass construction
- Polished chrome plated finish
- 3/8" compression stainless steel hoses



Straight Nozzle

| Handle | Compression Cartridge | Ceramic Cartridge | Control-A-Flow Cartridge |
|------------------|-----------------------|-------------------|--------------------------|
| Metal Cross | LWM1-A11-G | LWM1-B11-G | LWM1-C11-G |
| Plastic Cross | LWM1-A12-G | LWM1-B12-G | LWM1-C12-G |
| Metal Wristblade | LWM1-A13-G | LWM1-B13-G | LWM1-C13-G |

2.2 GPM Aerated Outlet

| Handle | Compression Cartridge | Ceramic Cartridge | Control-A-Flow Cartridge |
|------------------|-----------------------|-------------------|--------------------------|
| Metal Cross | LWM1-A21-G | LWM1-B21-G | LWM1-C21-G |
| Plastic Cross | LWM1-A22-G | LWM1-B22-G | LWM1-C22-G |
| Metal Wristblade | LWM1-A23-G | LWM1-B23-G | LWM1-C23-G |

Straight Nozzle With Aspirator

| Handle | Compression Cartridge | Ceramic Cartridge | Control-A-Flow Cartridge |
|------------------|-----------------------|-------------------|--------------------------|
| Metal Cross | LWM1-A31-G | LWM1-B31-G | LWM1-C31-G |
| Plastic Cross | LWM1-A32-G | LWM1-B32-G | LWM1-C32-G |
| Metal Wristblade | LWM1-A33-G | LWM1-B33-G | LWM1-C33-G |

Deck Mounted, Single Hole, 8" Rigid Gooseneck Spout with Vacuum Breaker

- Solid brass construction
- Polished chrome plated finish
- 3/8" compression stainless steel hoses



Straight Nozzle

| Handle | Compression Cartridge | Ceramic Cartridge | Control-A-Flow Cartridge |
|------------------|-----------------------|-------------------|--------------------------|
| Metal Cross | LWM1-A11-H | LWM1-B11-H | LWM1-C11-H |
| Plastic Cross | LWM1-A12-H | LWM1-B12-H | LWM1-C12-H |
| Metal Wristblade | LWM1-A13-H | LWM1-B13-H | LWM1-C13-H |

2.2 GPM Aerated Outlet

| Handle | Compression Cartridge | Ceramic Cartridge | Control-A-Flow Cartridge |
|------------------|-----------------------|-------------------|--------------------------|
| Metal Cross | LWM1-A21-H | LWM1-B21-H | LWM1-C21-H |
| Plastic Cross | LWM1-A22-H | LWM1-B22-H | LWM1-C22-H |
| Metal Wristblade | LWM1-A23-H | LWM1-B23-H | LWM1-C23-H |

Straight Nozzle With Aspirator

| Handle | Compression Cartridge | Ceramic Cartridge | Control-A-Flow Cartridge |
|------------------|-----------------------|-------------------|--------------------------|
| Metal Cross | LWM1-A31-H | LWM1-B31-H | LWM1-C31-H |
| Plastic Cross | LWM1-A32-H | LWM1-B32-H | LWM1-C32-H |
| Metal Wristblade | LWM1-A33-H | LWM1-B33-H | LWM1-C33-H |

Deck Mounted, 8" Fixed Centers, with 5-1/4" Gooseneck Spout



- Solid brass construction
- Polished chrome plated finish
- 1/2" NPSM supply inlets and coupling nut for 3/8" or 1/2" flexible riser

2.2 GPM Aerated Outlet

| Handle | Compression Cartridge | Ceramic Cartridge | Control-A-Flow Cartridge |
|------------------|-----------------------|-------------------|--------------------------|
| Metal Cross | LWM2-A21-A | LWM2-B21-A | LWM2-C21-A |
| Plastic Cross | LWM2-A22-A | LWM2-B22-A | LWM2-C22-A |
| Metal Wristblade | LWM2-A23-A | LWM2-B23-A | LWM2-C23-A |

Straight Nozzle

| Handle | Compression Cartridge | Ceramic Cartridge | Control-A-Flow Cartridge |
|------------------|-----------------------|-------------------|--------------------------|
| Metal Cross | LWM2-A11-A | LWM2-B11-A | LWM2-C11-A |
| Plastic Cross | LWM2-A12-A | LWM2-B12-A | LWM2-C12-A |
| Metal Wristblade | LWM2-A13-A | LWM2-B13-A | LWM2-C13-A |

Straight Nozzle With Aspirator

| Handle | Compression Cartridge | Ceramic Cartridge | Control-A-Flow Cartridge |
|------------------|-----------------------|-------------------|--------------------------|
| Metal Cross | LWM2-A31-A | LWM2-B31-A | LWM2-C31-A |
| Plastic Cross | LWM2-A32-A | LWM2-B32-A | LWM2-C32-A |
| Metal Wristblade | LWM2-A33-A | LWM2-B33-A | LWM2-C33-A |

Deck Mounted, 8" Fixed Centers, with 8" Gooseneck Spout



- Solid brass construction
- Polished chrome plated finish
- 1/2" NPSM supply inlets and coupling nut for 3/8" or 1/2" flexible riser

2.2 GPM Aerated Outlet

| Handle | Compression Cartridge | Ceramic Cartridge | Control-A-Flow Cartridge |
|------------------|-----------------------|-------------------|--------------------------|
| Metal Cross | LWM2-A21-B | LWM2-B21-B | LWM2-C21-B |
| Plastic Cross | LWM2-A22-B | LWM2-B22-B | LWM2-C22-B |
| Metal Wristblade | LWM2-A23-B | LWM2-B23-B | LWM2-C23-B |

Straight Nozzle

| Handle | Compression Cartridge | Ceramic Cartridge | Control-A-Flow Cartridge |
|------------------|-----------------------|-------------------|--------------------------|
| Metal Cross | LWM2-A11-B | LWM2-B11-B | LWM2-C11-B |
| Plastic Cross | LWM2-A12-B | LWM2-B12-B | LWM2-C12-B |
| Metal Wristblade | LWM2-A13-B | LWM2-B13-B | LWM2-C13-B |

Straight Nozzle With Aspirator

| Handle | Compression Cartridge | Ceramic Cartridge | Control-A-Flow Cartridge |
|------------------|-----------------------|-------------------|--------------------------|
| Metal Cross | LWM2-A31-B | LWM2-B31-B | LWM2-C31-B |
| Plastic Cross | LWM2-A32-B | LWM2-B32-B | LWM2-C32-B |
| Metal Wristblade | LWM2-A33-B | LWM2-B33-B | LWM2-C33-B |

Deck Mounted, 8" Fixed Centers, 5-1/4" Gooseneck Spout with Vacuum Breaker



- Solid brass construction
- Polished chrome plated finish
- 1/2" NPSM supply inlets and coupling nut for 3/8" or 1/2" flexible riser

2.2 GPM Aerated Outlet

| Handle | Compression Cartridge | Ceramic Cartridge | Control-A-Flow Cartridge |
|------------------|-----------------------|-------------------|--------------------------|
| Metal Cross | LWM2-A21-E | LWM2-B21-E | LWM2-C21-E |
| Plastic Cross | LWM2-A22-E | LWM2-B22-E | LWM2-C22-E |
| Metal Wristblade | LWM2-A23-E | LWM2-B23-E | LWM2-C23-E |

Straight Nozzle

| Handle | Compression Cartridge | Ceramic Cartridge | Control-A-Flow Cartridge |
|------------------|-----------------------|-------------------|--------------------------|
| Metal Cross | LWM2-A11-E | LWM2-B11-E | LWM2-C11-E |
| Plastic Cross | LWM2-A12-E | LWM2-B12-E | LWM2-C12-E |
| Metal Wristblade | LWM2-A13-E | LWM2-B13-E | LWM2-C13-E |

Straight Nozzle With Aspirator

| Handle | Compression Cartridge | Ceramic Cartridge | Control-A-Flow Cartridge |
|------------------|-----------------------|-------------------|--------------------------|
| Metal Cross | LWM1-A31-E | LWM1-B31-E | LWM1-C31-E |
| Plastic Cross | LWM1-A32-E | LWM1-B32-E | LWM1-C32-E |
| Metal Wristblade | LWM1-A33-E | LWM1-B33-E | LWM1-C33-E |

Deck Mounted, 8" Fixed Centers, 8" Gooseneck Spout with Vacuum Breaker



- Solid brass construction
- Polished chrome plated finish
- 1/2" NPSM supply inlets and coupling nut for 3/8" or 1/2" flexible riser

2.2 GPM Aerated Outlet

| Handle | Compression Cartridge | Ceramic Cartridge | Control-A-Flow Cartridge |
|------------------|-----------------------|-------------------|--------------------------|
| Metal Cross | LWM2-A21-F | LWM2-B21-F | LWM2-C21-F |
| Plastic Cross | LWM2-A22-F | LWM2-B22-F | LWM2-C22-F |
| Metal Wristblade | LWM2-A23-F | LWM2-B23-F | LWM2-C23-F |

Straight Nozzle

| Handle | Compression Cartridge | Ceramic Cartridge | Control-A-Flow Cartridge |
|------------------|-----------------------|-------------------|--------------------------|
| Metal Cross | LWM2-A11-F | LWM2-B11-F | LWM2-C11-F |
| Plastic Cross | LWM2-A12-F | LWM2-B12-F | LWM2-C12-F |
| Metal Wristblade | LWM2-A13-F | LWM2-B13-F | LWM2-C13-F |

Straight Nozzle With Aspirator

| Handle | Compression Cartridge | Ceramic Cartridge | Control-A-Flow Cartridge |
|------------------|-----------------------|-------------------|--------------------------|
| Metal Cross | LWM2-A31-F | LWM2-B31-F | LWM2-C31-F |
| Plastic Cross | LWM2-A32-F | LWM2-B32-F | LWM2-C32-F |
| Metal Wristblade | LWM2-A33-F | LWM2-B33-F | LWM2-C33-F |

Deck Mounted, 8" Fixed Centers, Third Water Inlet, 5-1/4" Gooseneck Spout



- Solid brass construction
- Polished chrome plated finish
- 3/8" compression stainless steel hoses

2.2 GPM Aerated Outlet

| Handle | Compression Cartridge | Ceramic Cartridge | Control-A-Flow Cartridge |
|------------------|-----------------------|-------------------|--------------------------|
| Metal Cross | LWM3-A21-A | LWM3-B21-A | LWM3-C21-A |
| Plastic Cross | LWM3-A22-A | LWM3-B22-A | LWM3-C22-A |
| Metal Wristblade | LWM3-A23-A | LWM3-B23-A | LWM3-C23-A |

Straight Nozzle

| Handle | Compression Cartridge | Ceramic Cartridge | Control-A-Flow Cartridge |
|------------------|-----------------------|-------------------|--------------------------|
| Metal Cross | LWM3-A11-A | LWM3-B11-A | LWM3-C11-A |
| Plastic Cross | LWM3-A12-A | LWM3-B12-A | LWM3-C12-A |
| Metal Wristblade | LWM3-A13-A | LWM3-B13-A | LWM3-C13-A |

Straight Nozzle With Aspirator

| Handle | Compression Cartridge | Ceramic Cartridge | Control-A-Flow Cartridge |
|------------------|-----------------------|-------------------|--------------------------|
| Metal Cross | LWM3-A31-A | LWM3-B31-A | LWM3-C31-A |
| Plastic Cross | LWM3-A32-A | LWM3-B32-A | LWM3-C32-A |
| Metal Wristblade | LWM3-A33-A | LWM3-B33-A | LWM3-C33-A |

Deck Mounted, 8" Fixed Centers, Third Water Inlet, 8" Gooseneck Spout



- Solid brass construction
- Polished chrome plated finish
- 3/8" compression stainless steel hoses

2.2 GPM Aerated Outlet

| Handle | Compression Cartridge | Ceramic Cartridge | Control-A-Flow Cartridge |
|------------------|-----------------------|-------------------|--------------------------|
| Metal Cross | LWM3-A21-B | LWM3-B21-B | LWM3-C21-B |
| Plastic Cross | LWM3-A22-B | LWM3-B22-B | LWM3-C22-B |
| Metal Wristblade | LWM3-A23-B | LWM3-B23-B | LWM3-C23-B |

Straight Nozzle

| Handle | Compression Cartridge | Ceramic Cartridge | Control-A-Flow Cartridge |
|------------------|-----------------------|-------------------|--------------------------|
| Metal Cross | LWM3-A11-B | LWM3-B11-B | LWM3-C11-B |
| Plastic Cross | LWM3-A12-B | LWM3-B12-B | LWM3-C12-B |
| Metal Wristblade | LWM3-A13-B | LWM3-B13-B | LWM3-C13-B |

Straight Nozzle With Aspirator

| Handle | Compression Cartridge | Ceramic Cartridge | Control-A-Flow Cartridge |
|------------------|-----------------------|-------------------|--------------------------|
| Metal Cross | LWM3-A31-B | LWM3-B31-B | LWM3-C31-B |
| Plastic Cross | LWM3-A32-B | LWM3-B32-B | LWM3-C32-B |
| Metal Wristblade | LWM3-A33-B | LWM3-B33-B | LWM3-C33-B |

Deck Mounted, 8" Fixed Centers, Third Water Inlet, 5-1/4" Gooseneck Spout with Vacuum Breaker



- Solid brass construction
- Polished chrome plated finish
- 1/2" NPSM supply inlets and coupling nut for 3/8" or 1/2" flexible riser

2.2 GPM Aerated Outlet

| Handle | Compression Cartridge | Ceramic Cartridge | Control-A-Flow Cartridge |
|------------------|-----------------------|-------------------|--------------------------|
| Metal Cross | LWM3-A21-E | LWM3-B21-E | LWM3-C21-E |
| Plastic Cross | LWM3-A22-E | LWM3-B22-E | LWM3-C22-E |
| Metal Wristblade | LWM3-A23-E | LWM3-B23-E | LWM3-C23-E |

Straight Nozzle

| Handle | Compression Cartridge | Ceramic Cartridge | Control-A-Flow Cartridge |
|------------------|-----------------------|-------------------|--------------------------|
| Metal Cross | LWM3-A11-E | LWM3-B11-E | LWM3-C11-E |
| Plastic Cross | LWM3-A12-E | LWM3-B12-E | LWM3-C12-E |
| Metal Wristblade | LWM3-A13-E | LWM3-B13-E | LWM3-C13-E |

Straight Nozzle With Aspirator

| Handle | Compression Cartridge | Ceramic Cartridge | Control-A-Flow Cartridge |
|------------------|-----------------------|-------------------|--------------------------|
| Metal Cross | LWM3-A31-E | LWM3-B31-E | LWM3-C31-E |
| Plastic Cross | LWM3-A32-E | LWM3-B32-E | LWM3-C32-E |
| Metal Wristblade | LWM3-A33-E | LWM3-B33-E | LWM3-C33-E |

Deck Mounted, 8" Fixed Centers, Third Water Inlet, 8" Gooseneck Spout with Vacuum Breaker



- Solid brass construction
- Polished chrome plated finish
- 1/2" NPSM supply inlets and coupling nut for 3/8" or 1/2" flexible riser

2.2 GPM Aerated Outlet

| Handle | Compression Cartridge | Ceramic Cartridge | Control-A-Flow Cartridge |
|------------------|-----------------------|-------------------|--------------------------|
| Metal Cross | LWM3-A21-F | LWM3-B21-F | LWM3-C21-F |
| Plastic Cross | LWM3-A22-F | LWM3-B22-F | LWM3-C22-F |
| Metal Wristblade | LWM3-A23-F | LWM3-B23-F | LWM3-C23-F |

Straight Nozzle

| Handle | Compression Cartridge | Ceramic Cartridge | Control-A-Flow Cartridge |
|------------------|-----------------------|-------------------|--------------------------|
| Metal Cross | LWM3-A11-F | LWM3-B11-F | LWM3-C11-F |
| Plastic Cross | LWM3-A12-F | LWM3-B12-F | LWM3-C12-F |
| Metal Wristblade | LWM3-A13-F | LWM3-B13-F | LWM3-C13-F |

Straight Nozzle With Aspirator

| Handle | Compression Cartridge | Ceramic Cartridge | Control-A-Flow Cartridge |
|------------------|-----------------------|-------------------|--------------------------|
| Metal Cross | LWM3-A31-F | LWM3-B31-F | LWM3-C31-F |
| Plastic Cross | LWM3-A32-F | LWM3-B32-F | LWM3-C32-F |
| Metal Wristblade | LWM3-A33-F | LWM3-B33-F | LWM3-C33-F |

Wall Mounted with Adjustable Arms, 5-1/4" Gooseneck Spout



- Solid brass construction, polished chrome plated finish
- 8" Body, adjustable arms 7-1/4" - 8-3/4"
- 1/2" NPT female thread inlet or 1/2" NPT male thread shank assembly
- Slip wall flanges

2.2 GPM Aerated Outlet

| Handle | With Shanks | Compression Cartridge | Ceramic Cartridge | Control-A-Flow Cartridge |
|------------------|-------------|-----------------------|-------------------|--------------------------|
| Metal Cross | – | LWM4-A21-A | LWM4-B21-A | LWM4-C21-A |
| | • | LWM5-A21-A | LWM5-B21-A | LWM5-C21-A |
| Plastic Cross | – | LWM4-A22-A | LWM4-B22-A | LWM4-C22-A |
| | • | LWM5-A22-A | LWM5-B22-A | LWM5-C22-A |
| Metal Wristblade | – | LWM4-A23-A | LWM4-B23-A | LWM4-C23-A |
| | • | LWM5-A23-A | LWM5-B23-A | LWM5-C23-A |

Straight Nozzle

| Handle | With Shanks | Compression Cartridge | Ceramic Cartridge | Control-A-Flow Cartridge |
|------------------|-------------|-----------------------|-------------------|--------------------------|
| Metal Cross | – | LWM4-A11-A | LWM4-B11-A | LWM4-C11-A |
| | • | LWM5-A11-A | LWM5-B11-A | LWM5-C11-A |
| Plastic Cross | – | LWM4-A12-A | LWM4-B12-A | LWM4-C12-A |
| | • | LWM5-A12-A | LWM5-B12-A | LWM5-C12-A |
| Metal Wristblade | – | LWM4-A13-A | LWM4-B13-A | LWM4-C13-A |
| | • | LWM5-A13-A | LWM5-B13-A | LWM5-C13-A |

Straight Nozzle With Aspirator

| Handle | With Shanks | Compression Cartridge | Ceramic Cartridge | Control-A-Flow Cartridge |
|------------------|-------------|-----------------------|-------------------|--------------------------|
| Metal Cross | – | LWM4-A31-A | LWM4-B31-A | LWM4-C31-A |
| | • | LWM5-A31-A | LWM5-B31-A | LWM5-C31-A |
| Plastic Cross | – | LWM4-A32-A | LWM4-B32-A | LWM4-C32-A |
| | • | LWM5-A32-A | LWM5-B32-A | LWM5-C32-A |
| Metal Wristblade | – | LWM4-A33-A | LWM4-B33-A | LWM4-C33-A |
| | • | LWM5-A33-A | LWM5-B33-A | LWM5-C33-A |

Wall Mounted with Adjustable Arms, 8" Gooseneck Spout



- Solid brass construction, polished chrome plated finish
- 8" Body, adjustable arms 7-1/4" - 8-3/4"
- 1/2" NPT female thread inlet or 1/2" NPT male thread shank assembly
- Slip wall flanges

2.2 GPM Aerated Outlet

| Handle | With Shanks | Compression Cartridge | Ceramic Cartridge | Control-A-Flow Cartridge |
|------------------|-------------|-----------------------|-------------------|--------------------------|
| Metal Cross | – | LWM4-A21-B | LWM4-B21-B | LWM4-C21-B |
| | • | LWM5-A21-B | LWM5-B21-B | LWM5-C21-B |
| Plastic Cross | – | LWM4-A22-B | LWM4-B22-B | LWM4-C22-B |
| | • | LWM5-A22-B | LWM5-B22-B | LWM5-C22-B |
| Metal Wristblade | – | LWM4-A23-B | LWM4-B23-B | LWM4-C23-B |
| | • | LWM5-A23-B | LWM5-B23-B | LWM5-C23-B |

Straight Nozzle

| Handle | With Shanks | Compression Cartridge | Ceramic Cartridge | Control-A-Flow Cartridge |
|------------------|-------------|-----------------------|-------------------|--------------------------|
| Metal Cross | – | LWM4-A11-B | LWM4-B11-B | LWM4-C11-B |
| | • | LWM5-A11-B | LWM5-B11-B | LWM5-C11-B |
| Plastic Cross | – | LWM4-A12-B | LWM4-B12-B | LWM4-C12-B |
| | • | LWM5-A12-B | LWM5-B12-B | LWM5-C12-B |
| Metal Wristblade | – | LWM4-A13-B | LWM4-B13-B | LWM4-C13-B |
| | • | LWM5-A13-B | LWM5-B13-B | LWM5-C13-B |

Straight Nozzle With Aspirator

| Handle | With Shanks | Compression Cartridge | Ceramic Cartridge | Control-A-Flow Cartridge |
|------------------|-------------|-----------------------|-------------------|--------------------------|
| Metal Cross | – | LWM4-A31-B | LWM4-B31-B | LWM4-C31-B |
| | • | LWM5-A31-B | LWM5-B31-B | LWM5-C31-B |
| Plastic Cross | – | LWM4-A32-B | LWM4-B32-B | LWM4-C32-B |
| | • | LWM5-A32-B | LWM5-B32-B | LWM5-C32-B |
| Metal Wristblade | – | LWM4-A33-B | LWM4-B33-B | LWM4-C33-B |
| | • | LWM5-A33-B | LWM5-B33-B | LWM5-C33-B |

Wall Mounted with Adjustable Arms, 5-1/4" Gooseneck Spout with Vacuum Breaker



- Solid brass construction, polished chrome plated finish
- 8" Body, adjustable arms 7-1/4" - 8-3/4"
- 1/2" NPT female thread inlet or 1/2" NPT male thread shank assembly
- Slip wall flanges

2.2 GPM Aerated Outlet

| Handle | With Shanks | Compression Cartridge | Ceramic Cartridge | Control-A-Flow Cartridge |
|------------------|-------------|-----------------------|-------------------|--------------------------|
| Metal Cross | – | LWM4-A21-E | LWM4-B21-E | LWM4-C21-E |
| | • | LWM5-A21-E | LWM5-B21-E | LWM5-C21-E |
| Plastic Cross | – | LWM4-A22-E | LWM4-B22-E | LWM4-C22-E |
| | • | LWM5-A22-E | LWM5-B22-E | LWM5-C22-E |
| Metal Wristblade | – | LWM4-A23-E | LWM4-B23-E | LWM4-C23-E |
| | • | LWM5-A23-E | LWM5-B23-E | LWM5-C23-E |

Straight Nozzle

| Handle | With Shanks | Compression Cartridge | Ceramic Cartridge | Control-A-Flow Cartridge |
|------------------|-------------|-----------------------|-------------------|--------------------------|
| Metal Cross | – | LWM4-A11-E | LWM4-B11-E | LWM4-C11-E |
| | • | LWM5-A11-E | LWM5-B11-E | LWM5-C11-E |
| Plastic Cross | – | LWM4-A12-E | LWM4-B12-E | LWM4-C12-E |
| | • | LWM5-A12-E | LWM5-B12-E | LWM5-C12-E |
| Metal Wristblade | – | LWM4-A13-E | LWM4-B13-E | LWM4-C13-E |
| | • | LWM5-A13-E | LWM5-B13-E | LWM5-C13-E |

Straight Nozzle With Aspirator

| Handle | With Shanks | Compression Cartridge | Ceramic Cartridge | Control-A-Flow Cartridge |
|------------------|-------------|-----------------------|-------------------|--------------------------|
| Metal Cross | – | LWM4-A31-E | LWM4-B31-E | LWM4-C31-E |
| | • | LWM5-A31-E | LWM5-B31-E | LWM5-C31-E |
| Plastic Cross | – | LWM4-A32-E | LWM4-B32-E | LWM4-C32-E |
| | • | LWM5-A32-E | LWM5-B32-E | LWM5-C32-E |
| Metal Wristblade | – | LWM4-A33-E | LWM4-B33-E | LWM4-C33-E |
| | • | LWM5-A33-E | LWM5-B33-E | LWM5-C33-E |

Wall Mounted with Adjustable Arms, 8" Gooseneck Spout with Vacuum Breaker



- Solid brass construction, polished chrome plated finish
- 8" Body, adjustable arms 7-1/4" - 8-3/4"
- 1/2" NPT female thread inlet or 1/2" NPT male thread shank assembly
- Slip wall flanges

2.2 GPM Aerated Outlet

| Handle | With Shanks | Compression Cartridge | Ceramic Cartridge | Control-A-Flow Cartridge |
|------------------|-------------|-----------------------|-------------------|--------------------------|
| Metal Cross | – | LWM4-A21-F | LWM4-B21-F | LWM4-C21-F |
| | • | LWM5-A21-F | LWM5-B21-F | LWM5-C21-F |
| Plastic Cross | – | LWM4-A22-F | LWM4-B22-F | LWM4-C22-F |
| | • | LWM5-A22-F | LWM5-B22-F | LWM5-C22-F |
| Metal Wristblade | – | LWM4-A23-F | LWM4-B23-F | LWM4-C23-F |
| | • | LWM5-A23-F | LWM5-B23-F | LWM5-C23-F |

Straight Nozzle

| Handle | With Shanks | Compression Cartridge | Ceramic Cartridge | Control-A-Flow Cartridge |
|------------------|-------------|-----------------------|-------------------|--------------------------|
| Metal Cross | – | LWM4-A11-F | LWM4-B11-F | LWM4-C11-F |
| | • | LWM5-A11-F | LWM5-B11-F | LWM5-C11-F |
| Plastic Cross | – | LWM4-A12-F | LWM4-B12-F | LWM4-C12-F |
| | • | LWM5-A12-F | LWM5-B12-F | LWM5-C12-F |
| Metal Wristblade | – | LWM4-A13-F | LWM4-B13-F | LWM4-C13-F |
| | • | LWM5-A13-F | LWM5-B13-F | LWM5-C13-F |

Straight Nozzle With Aspirator

| Handle | With Shanks | Compression Cartridge | Ceramic Cartridge | Control-A-Flow Cartridge |
|------------------|-------------|-----------------------|-------------------|--------------------------|
| Metal Cross | – | LWM4-A31-F | LWM4-B31-F | LWM4-C31-F |
| | • | LWM5-A31-F | LWM5-B31-F | LWM5-C31-F |
| Plastic Cross | – | LWM4-A32-F | LWM4-B32-F | LWM4-C32-F |
| | • | LWM5-A32-F | LWM5-B32-F | LWM5-C32-F |
| Metal Wristblade | – | LWM4-A33-F | LWM4-B33-F | LWM4-C33-F |
| | • | LWM5-A33-F | LWM5-B33-F | LWM5-C33-F |

Wall Mounted with Adjustable Arms, 5-1/4" Rigid Gooseneck Spout with Vacuum Breaker



- Solid brass construction, polished chrome plated finish
- 8" Body, adjustable arms 7-1/4" - 8-3/4"
- 1/2" NPT female thread inlet or 1/2" NPT male thread shank assembly
- Slip wall flanges

2.2 GPM Aerated Outlet

| Handle | With Shanks | Compression Cartridge | Ceramic Cartridge | Control-A-Flow Cartridge |
|------------------|-------------|-----------------------|-------------------|--------------------------|
| Metal Cross | - | LWM4-A21-G | LWM4-B21-G | LWM4-C21-G |
| | • | LWM5-A21-G | LWM5-B21-G | LWM5-C21-G |
| Plastic Cross | - | LWM4-A22-G | LWM4-B22-G | LWM4-C22-G |
| | • | LWM5-A22-G | LWM5-B22-G | LWM5-C22-G |
| Metal Wristblade | - | LWM4-A23-G | LWM4-B23-G | LWM4-C23-G |
| | • | LWM5-A23-G | LWM5-B23-G | LWM5-C23-G |

Straight Nozzle

| Handle | With Shanks | Compression Cartridge | Ceramic Cartridge | Control-A-Flow Cartridge |
|------------------|-------------|-----------------------|-------------------|--------------------------|
| Metal Cross | - | LWM4-A11-G | LWM4-B11-G | LWM4-C11-G |
| | • | LWM5-A11-G | LWM5-B11-G | LWM5-C11-G |
| Plastic Cross | - | LWM4-A12-G | LWM4-B12-G | LWM4-C12-G |
| | • | LWM5-A12-G | LWM5-B12-G | LWM5-C12-G |
| Metal Wristblade | - | LWM4-A13-G | LWM4-B13-G | LWM4-C13-G |
| | • | LWM5-A13-G | LWM5-B13-G | LWM5-C13-G |

Straight Nozzle With Aspirator

| Handle | With Shanks | Compression Cartridge | Ceramic Cartridge | Control-A-Flow Cartridge |
|------------------|-------------|-----------------------|-------------------|--------------------------|
| Metal Cross | - | LWM4-A31-G | LWM4-B31-G | LWM4-C31-G |
| | • | LWM5-A31-G | LWM5-B31-G | LWM5-C31-G |
| Plastic Cross | - | LWM4-A32-G | LWM4-B32-G | LWM4-C32-G |
| | • | LWM5-A32-G | LWM5-B32-G | LWM5-C32-G |
| Metal Wristblade | - | LWM4-A33-G | LWM4-B33-G | LWM4-C33-G |
| | • | LWM5-A33-G | LWM5-B33-G | LWM5-C33-G |

Wall Mounted with Adjustable Arms, 8" Rigid Gooseneck Spout with Vacuum Breaker



- Solid brass construction, polished chrome plated finish
- 8" Body, adjustable arms 7-1/4" - 8-3/4"
- 1/2" NPT female thread inlet or 1/2" NPT male thread shank assembly
- Slip wall flanges

2.2 GPM Aerated Outlet

| Handle | With Shanks | Compression Cartridge | Ceramic Cartridge | Control-A-Flow Cartridge |
|------------------|-------------|-----------------------|-------------------|--------------------------|
| Metal Cross | - | LWM4-A21-H | LWM4-B21-H | LWM4-C21-H |
| | • | LWM5-A21-H | LWM5-B21-H | LWM5-C21-H |
| Plastic Cross | - | LWM4-A22-H | LWM4-B22-H | LWM4-C22-H |
| | • | LWM5-A22-H | LWM5-B22-H | LWM5-C22-H |
| Metal Wristblade | - | LWM4-A23-H | LWM4-B23-H | LWM4-C23-H |
| | • | LWM5-A23-H | LWM5-B23-H | LWM5-C23-H |

Straight Nozzle

| Handle | With Shanks | Compression Cartridge | Ceramic Cartridge | Control-A-Flow Cartridge |
|------------------|-------------|-----------------------|-------------------|--------------------------|
| Metal Cross | - | LWM4-A11-H | LWM4-B11-H | LWM4-C11-H |
| | • | LWM5-A11-H | LWM5-B11-H | LWM5-C11-H |
| Plastic Cross | - | LWM4-A12-H | LWM4-B12-H | LWM4-C12-H |
| | • | LWM5-A12-H | LWM5-B12-H | LWM5-C12-H |
| Metal Wristblade | - | LWM4-A13-H | LWM4-B13-H | LWM4-C13-H |
| | • | LWM5-A13-H | LWM5-B13-H | LWM5-C13-H |

Straight Nozzle With Aspirator

| Handle | With Shanks | Compression Cartridge | Ceramic Cartridge | Control-A-Flow Cartridge |
|------------------|-------------|-----------------------|-------------------|--------------------------|
| Metal Cross | - | LWM4-A31-H | LWM4-B31-H | LWM4-C31-H |
| | • | LWM5-A31-H | LWM5-B31-H | LWM5-C31-H |
| Plastic Cross | - | LWM4-A32-H | LWM4-B32-H | LWM4-C32-H |
| | • | LWM5-A32-H | LWM5-B32-H | LWM5-C32-H |
| Metal Wristblade | - | LWM4-A33-H | LWM4-B33-H | LWM4-C33-H |
| | • | LWM5-A33-H | LWM5-B33-H | LWM5-C33-H |

Wall Mounted, 5-1/4" Gooseneck Spout



- Solid brass construction, polished chrome plated finish
- 3" vertical centers
- Straight inlet arm with 1/2" NPT female thread inlet or 1/2" NPT male thread shank assembly
- Integral wall flanges

2.2 GPM Aerated Outlet

| Handle | With Shanks | Compression Cartridge | Ceramic Cartridge | Control-A-Flow Cartridge |
|------------------|-------------|-----------------------|-------------------|--------------------------|
| Metal Cross | – | LWM6-A21-A | LWM6-B21-A | LWM6-C21-A |
| | • | LWM7-A21-A | LWM7-B21-A | LWM7-C21-A |
| Plastic Cross | – | LWM6-A22-A | LWM6-B22-A | LWM6-C22-A |
| | • | LWM7-A22-A | LWM7-B22-A | LWM7-C22-A |
| Metal Wristblade | – | LWM6-A23-A | LWM6-B23-A | LWM6-C23-A |
| | • | LWM7-A23-A | LWM7-B23-A | LWM7-C23-A |

Straight Nozzle

| Handle | With Shanks | Compression Cartridge | Ceramic Cartridge | Control-A-Flow Cartridge |
|------------------|-------------|-----------------------|-------------------|--------------------------|
| Metal Cross | – | LWM6-A11-A | LWM6-B11-A | LWM6-C11-A |
| | • | LWM7-A11-A | LWM7-B11-A | LWM7-C11-A |
| Plastic Cross | – | LWM6-A12-A | LWM6-B12-A | LWM6-C12-A |
| | • | LWM7-A12-A | LWM7-B12-A | LWM7-C12-A |
| Metal Wristblade | – | LWM6-A13-A | LWM6-B13-A | LWM6-C13-A |
| | • | LWM7-A13-A | LWM7-B13-A | LWM7-C13-A |

Straight Nozzle With Aspirator

| Handle | With Shanks | Compression Cartridge | Ceramic Cartridge | Control-A-Flow Cartridge |
|------------------|-------------|-----------------------|-------------------|--------------------------|
| Metal Cross | – | LWM6-A31-A | LWM6-B31-A | LWM6-C31-A |
| | • | LWM7-A31-A | LWM7-B31-A | LWM7-C31-A |
| Plastic Cross | – | LWM6-A32-A | LWM6-B32-A | LWM6-C32-A |
| | • | LWM7-A32-A | LWM7-B32-A | LWM7-C32-A |
| Metal Wristblade | – | LWM6-A33-A | LWM6-B33-A | LWM6-C33-A |
| | • | LWM7-A33-A | LWM7-B33-A | LWM7-C33-A |

Wall Mounted, 8" Gooseneck Spout



- Solid brass construction, polished chrome plated finish
- 3" vertical centers
- Straight inlet arm with 1/2" NPT female thread inlet or 1/2" NPT male thread shank assembly
- Integral wall flanges

2.2 GPM Aerated Outlet

| Handle | With Shanks | Compression Cartridge | Ceramic Cartridge | Control-A-Flow Cartridge |
|------------------|-------------|-----------------------|-------------------|--------------------------|
| Metal Cross | – | LWM6-A21-B | LWM6-B21-B | LWM6-C21-B |
| | • | LWM7-A21-B | LWM7-B21-B | LWM7-C21-B |
| Plastic Cross | – | LWM6-A22-B | LWM6-B22-B | LWM6-C22-B |
| | • | LWM7-A22-B | LWM7-B22-B | LWM7-C22-B |
| Metal Wristblade | – | LWM6-A23-B | LWM6-B23-B | LWM6-C23-B |
| | • | LWM7-A23-B | LWM7-B23-B | LWM7-C23-B |

Straight Nozzle

| Handle | With Shanks | Compression Cartridge | Ceramic Cartridge | Control-A-Flow Cartridge |
|------------------|-------------|-----------------------|-------------------|--------------------------|
| Metal Cross | – | LWM6-A11-B | LWM6-B11-B | LWM6-C11-B |
| | • | LWM7-A11-B | LWM7-B11-B | LWM7-C11-B |
| Plastic Cross | – | LWM6-A12-B | LWM6-B12-B | LWM6-C12-B |
| | • | LWM7-A12-B | LWM7-B12-B | LWM7-C12-B |
| Metal Wristblade | – | LWM6-A13-B | LWM6-B13-B | LWM6-C13-B |
| | • | LWM7-A13-B | LWM7-B13-B | LWM7-C13-B |

Straight Nozzle With Aspirator

| Handle | With Shanks | Compression Cartridge | Ceramic Cartridge | Control-A-Flow Cartridge |
|------------------|-------------|-----------------------|-------------------|--------------------------|
| Metal Cross | – | LWM6-A31-B | LWM6-B31-B | LWM6-C31-B |
| | • | LWM7-A31-B | LWM7-B31-B | LWM7-C31-B |
| Plastic Cross | – | LWM6-A32-B | LWM6-B32-B | LWM6-C32-B |
| | • | LWM7-A32-B | LWM7-B32-B | LWM7-C32-B |
| Metal Wristblade | – | LWM6-A33-B | LWM6-B33-B | LWM6-C33-B |
| | • | LWM7-A33-B | LWM7-B33-B | LWM7-C33-B |

Wall Mounted, 5-1/4" Gooseneck Spout with Vacuum Breaker



- Solid brass construction, polished chrome plated finish
- 3" vertical centers
- Straight inlet arm with 1/2" NPT female thread inlet or 1/2" NPT male thread shank assembly
- Integral wall flanges

2.2 GPM Aerated Outlet

| Handle | With Shanks | Compression Cartridge | Ceramic Cartridge | Control-A-Flow Cartridge |
|------------------|-------------|-----------------------|-------------------|--------------------------|
| Metal Cross | – | LWM6-A21-E | LWM6-B21-E | LWM6-C21-E |
| | • | LWM7-A21-E | LWM7-B21-E | LWM7-C21-E |
| Plastic Cross | – | LWM6-A22-E | LWM6-B22-E | LWM6-C22-E |
| | • | LWM7-A22-E | LWM7-B22-E | LWM7-C22-E |
| Metal Wristblade | – | LWM6-A23-E | LWM6-B23-E | LWM6-C23-E |
| | • | LWM7-A23-E | LWM7-B23-E | LWM7-C23-E |

Straight Nozzle

| Handle | With Shanks | Compression Cartridge | Ceramic Cartridge | Control-A-Flow Cartridge |
|------------------|-------------|-----------------------|-------------------|--------------------------|
| Metal Cross | – | LWM6-A11-E | LWM6-B11-E | LWM6-C11-E |
| | • | LWM7-A11-E | LWM7-B11-E | LWM7-C11-E |
| Plastic Cross | – | LWM6-A12-E | LWM6-B12-E | LWM6-C12-E |
| | • | LWM7-A12-E | LWM7-B12-E | LWM7-C12-E |
| Metal Wristblade | – | LWM6-A13-E | LWM6-B13-E | LWM6-C13-E |
| | • | LWM7-A13-E | LWM7-B13-E | LWM7-C13-E |

Straight Nozzle With Aspirator

| Handle | With Shanks | Compression Cartridge | Ceramic Cartridge | Control-A-Flow Cartridge |
|------------------|-------------|-----------------------|-------------------|--------------------------|
| Metal Cross | – | LWM6-A31-E | LWM6-B31-E | LWM6-C31-E |
| | • | LWM7-A31-E | LWM7-B31-E | LWM7-C31-E |
| Plastic Cross | – | LWM6-A32-E | LWM6-B32-E | LWM6-C32-E |
| | • | LWM7-A32-E | LWM7-B32-E | LWM7-C32-E |
| Metal Wristblade | – | LWM6-A33-E | LWM6-B33-E | LWM6-C33-E |
| | • | LWM7-A33-E | LWM7-B33-E | LWM7-C33-E |

Wall Mounted, 8" Gooseneck Spout with Vacuum Breaker



- Solid brass construction, polished chrome plated finish
- 3" vertical centers
- Straight inlet arm with 1/2" NPT female thread inlet or 1/2" NPT male thread shank assembly
- Integral wall flanges

2.2 GPM Aerated Outlet

| Handle | With Shanks | Compression Cartridge | Ceramic Cartridge | Control-A-Flow Cartridge |
|------------------|-------------|-----------------------|-------------------|--------------------------|
| Metal Cross | – | LWM6-A21-F | LWM6-B21-F | LWM6-C21-F |
| | • | LWM7-A21-F | LWM7-B21-F | LWM7-C21-F |
| Plastic Cross | – | LWM6-A22-F | LWM6-B22-F | LWM6-C22-F |
| | • | LWM7-A22-F | LWM7-B22-F | LWM7-C22-F |
| Metal Wristblade | – | LWM6-A23-F | LWM6-B23-F | LWM6-C23-F |
| | • | LWM7-A23-F | LWM7-B23-F | LWM7-C23-F |

Straight Nozzle

| Handle | With Shanks | Compression Cartridge | Ceramic Cartridge | Control-A-Flow Cartridge |
|------------------|-------------|-----------------------|-------------------|--------------------------|
| Metal Cross | – | LWM6-A11-F | LWM6-B11-F | LWM6-C11-F |
| | • | LWM7-A11-F | LWM7-B11-F | LWM7-C11-F |
| Plastic Cross | – | LWM6-A12-F | LWM6-B12-F | LWM6-C12-F |
| | • | LWM7-A12-F | LWM7-B12-F | LWM7-C12-F |
| Metal Wristblade | – | LWM6-A13-F | LWM6-B13-F | LWM6-C13-F |
| | • | LWM7-A13-F | LWM7-B13-F | LWM7-C13-F |

Straight Nozzle With Aspirator

| Handle | With Shanks | Compression Cartridge | Ceramic Cartridge | Control-A-Flow Cartridge |
|------------------|-------------|-----------------------|-------------------|--------------------------|
| Metal Cross | – | LWM6-A31-F | LWM6-B31-F | LWM6-C31-F |
| | • | LWM7-A31-F | LWM7-B31-F | LWM7-C31-F |
| Plastic Cross | – | LWM6-A32-F | LWM6-B32-F | LWM6-C32-F |
| | • | LWM7-A32-F | LWM7-B32-F | LWM7-C32-F |
| Metal Wristblade | – | LWM6-A33-F | LWM6-B33-F | LWM6-C33-F |
| | • | LWM7-A33-F | LWM7-B33-F | LWM7-C33-F |

Wall Mounted, 5-1/4" Rigid Gooseneck Spout with Vacuum Breaker



- Solid brass construction, polished chrome plated finish
- 3" vertical centers
- Straight inlet arm with 1/2" NPT female thread inlet or 1/2" NPT male thread shank assembly
- Integral wall flanges

2.2 GPM Aerated Outlet

| Handle | With Shanks | Compression Cartridge | Ceramic Cartridge | Control-A-Flow Cartridge |
|------------------|-------------|-----------------------|-------------------|--------------------------|
| Metal Cross | – | LWM6-A21-G | LWM6-B21-G | LWM6-C21-G |
| | • | LWM7-A21-G | LWM7-B21-G | LWM7-C21-G |
| Plastic Cross | – | LWM6-A22-G | LWM6-B22-G | LWM6-C22-G |
| | • | LWM7-A22-G | LWM7-B22-G | LWM7-C22-G |
| Metal Wristblade | – | LWM6-A23-G | LWM6-B23-G | LWM6-C23-G |
| | • | LWM7-A23-G | LWM7-B23-G | LWM7-C23-G |

Straight Nozzle

| Handle | With Shanks | Compression Cartridge | Ceramic Cartridge | Control-A-Flow Cartridge |
|------------------|-------------|-----------------------|-------------------|--------------------------|
| Metal Cross | – | LWM6-A11-G | LWM6-B11-G | LWM6-C11-G |
| | • | LWM7-A11-G | LWM7-B11-G | LWM7-C11-G |
| Plastic Cross | – | LWM6-A12-G | LWM6-B12-G | LWM6-C12-G |
| | • | LWM7-A12-G | LWM7-B12-G | LWM7-C12-G |
| Metal Wristblade | – | LWM6-A13-G | LWM6-B13-G | LWM6-C13-G |
| | • | LWM7-A13-G | LWM7-B13-G | LWM7-C13-G |

Straight Nozzle With Aspirator

| Handle | With Shanks | Compression Cartridge | Ceramic Cartridge | Control-A-Flow Cartridge |
|------------------|-------------|-----------------------|-------------------|--------------------------|
| Metal Cross | – | LWM6-A31-G | LWM6-B31-G | LWM6-C31-G |
| | • | LWM7-A31-G | LWM7-B31-G | LWM7-C31-G |
| Plastic Cross | – | LWM6-A32-G | LWM6-B32-G | LWM6-C32-G |
| | • | LWM7-A32-G | LWM7-B32-G | LWM7-C32-G |
| Metal Wristblade | – | LWM6-A33-G | LWM6-B33-G | LWM6-C33-G |
| | • | LWM7-A33-G | LWM7-B33-G | LWM7-C33-G |

Wall Mounted, 8" Rigid Gooseneck Spout with Vacuum Breaker



- Solid brass construction, polished chrome plated finish
- 3" vertical centers
- Straight inlet arm with 1/2" NPT female thread inlet or 1/2" NPT male thread shank assembly
- Integral wall flanges

2.2 GPM Aerated Outlet

| Handle | With Shanks | Compression Cartridge | Ceramic Cartridge | Control-A-Flow Cartridge |
|------------------|-------------|-----------------------|-------------------|--------------------------|
| Metal Cross | – | LWM6-A21-H | LWM6-B21-H | LWM6-C21-H |
| | • | LWM7-A21-H | LWM7-B21-H | LWM7-C21-H |
| Plastic Cross | – | LWM6-A22-H | LWM6-B22-H | LWM6-C22-H |
| | • | LWM7-A22-H | LWM7-B22-H | LWM7-C22-H |
| Metal Wristblade | – | LWM6-A23-H | LWM6-B23-H | LWM6-C23-H |
| | • | LWM7-A23-H | LWM7-B23-H | LWM7-C23-H |

Straight Nozzle

| Handle | With Shanks | Compression Cartridge | Ceramic Cartridge | Control-A-Flow Cartridge |
|------------------|-------------|-----------------------|-------------------|--------------------------|
| Metal Cross | – | LWM6-A11-H | LWM6-B11-H | LWM6-C11-H |
| | • | LWM7-A11-H | LWM7-B11-H | LWM7-C11-H |
| Plastic Cross | – | LWM6-A12-H | LWM6-B12-H | LWM6-C12-H |
| | • | LWM7-A12-H | LWM7-B12-H | LWM7-C12-H |
| Metal Wristblade | – | LWM6-A13-H | LWM6-B13-H | LWM6-C13-H |
| | • | LWM7-A13-H | LWM7-B13-H | LWM7-C13-H |

Straight Nozzle With Aspirator

| Handle | With Shanks | Compression Cartridge | Ceramic Cartridge | Control-A-Flow Cartridge |
|------------------|-------------|-----------------------|-------------------|--------------------------|
| Metal Cross | – | LWM6-A31-H | LWM6-B31-H | LWM6-C31-H |
| | • | LWM7-A31-H | LWM7-B31-H | LWM7-C31-H |
| Plastic Cross | – | LWM6-A32-H | LWM6-B32-H | LWM6-C32-H |
| | • | LWM7-A32-H | LWM7-B32-H | LWM7-C32-H |
| Metal Wristblade | – | LWM6-A33-H | LWM6-B33-H | LWM6-C33-H |
| | • | LWM7-A33-H | LWM7-B33-H | LWM7-C33-H |

Deck Mounted, Single Hole Manual Faucet

- Hot and cold water mixing faucet
- 2.2 GPM (8.3 L/min) aerator
- 2-3/8" Vandal proof lever handle
- Polished chrome plated finish
- Quatern compression operating cartridge
- 3/8" Compression flexible stainless steel supply hoses



| Spout | Model |
|------------------|----------------|
| 6" S Type Swing | 51-ABCP |
| 8" L Type Swing | 51-L8ABCP |
| 12" L Type Swing | 51-L12ABCP |

Deck Mounted, 4" Fixed Centers, Manual Faucet

- Hot and cold water mixing faucet
- 2.2 GPM (8.3 L/min) aerator
- Quatern compression operating cartridge
- 1/2" NPSM supply inlets and coupling nut for 3/8" or 1/2" flexible riser
- Polished chrome plated finish
- Gooseneck spouts include rigid/swing option



| Spout | Handle | Model |
|--------------------------------|------------|--------------------------|
| 3-1/2" Gooseneck | Wristblade | 895-317ABCP |
| 5-1/4" Gooseneck | | 895-317GN2AE3ABCP |
| 8" Gooseneck w/ Vacuum Breaker | | 895-317GN8BVBE2-2* |
| 8" Gooseneck w/ Vacuum Breaker | | 895-317GN8BVBE3MAB |
| 8" Gooseneck | Lever | 895-GN8AE3ABCP |

*Full-flow 3/4" male hose thread outlet

Deck Mounted, 8" Fixed Centers, Manual Faucet

- Concealed, hot and cold water faucet
- 2.2 GPM (8.3 L/min) aerator
- Quatern compression operating cartridge
- 1/2" NPSM supply inlets and coupling nut for 3/8" or 1/2" flexible riser
- Polished chrome plated finish
- Gooseneck spouts include rigid/swing option



| Spout | Handle | Model |
|--------------------------------|------------|---------------------------|
| 9-1/2" L Type Swing | Wristblade | 201-A317ABCP |
| 8" Gooseneck w/ Vacuum Breaker | | 201-AG8BVBE3M317AB |
| 5-1/4" Gooseneck | | 786-E3ABCP |
| 6" Gooseneck w/ Vacuum Breaker | | 786-GN2BVBE3-2ABCP |
| 8" Gooseneck | | 786-GN8AE3ABCP |
| 9-1/2" L Type Swing | Lever | 201-AABCP |
| 9-1/2" L Type Swing | Canopy | 201-A1000ABCP |

Wall Mounted, Manual Faucet

- 8" Body, adjustable arms 7-1/4" - 8-3/4"
- Concealed, hot and cold water faucet
- 2.2 GPM (8.3 L/min) aerator
- Quatern compression operating cartridge
- 1/2" NPSM supply inlets and coupling nut for 3/8" or 1/2" flexible riser
- Polished chrome plated finish
- Gooseneck spouts include rigid/swing option



| Spout | Handle | Model |
|---------------------|------------|-----------------|
| 3-1/2" Gooseneck | Wristblade | 631-ABCP |
| 5-1/4" Gooseneck | | 631-GN2AE3ABCP |
| 8" Gooseneck | | 631-GN8AE3ABCP |
| 6" S Type Swing | Lever | 540-LDABCP |
| 8" L Type Swing | | 540-LDL8ABCP |
| 9-1/2" L Type Swing | | 540-LDL9ABCP |
| 12" L Type Swing | | 540-LDL12ABCP |
| 15" L Type Swing | | 540-LDL15ABCP |

Wall Mounted, Service Sink Faucet

- 8" Body, adjustable arms 7-1/4" - 8-3/4"
- Vacuum breaker spout with pail hook and 3/4" male hose thread outlet
- 2-3/8" Vandal proof lever handle
- Polished chrome



| Finish | Model |
|-----------------|---------------------|
| Polished Chrome | 540-LD897SCP |

Wall Mounted, Service Sink Faucet

- 8" Body, adjustable arms 7-5/8" - 8-3/8"
- Integral stop valves for servicing the product
- Vacuum breaker spout with pail hook and 3/4" male hose thread outlet
- 2-3/8" Vandal proof lever handle



| Finish | Check Valves | Model |
|-----------------|--------------|----------------|
| Polished Chrome | Y | 897-CCP |
| | - | 897-CP |
| Rough Chrome | Y | 897-CRCF |
| | - | 897-RCF |

Wall Mounted, Sill Fitting

- Single hole
- 2-1/4" tee handle
- 3/4" male hose thread outlet
- 1/2" NPT female thread inlet
- Slip wall flange



| Finish | Cartridge | In-Line Vacuum Breaker | Model |
|-----------------|---------------------|------------------------|---------------|
| Polished Chrome | Self-closing | – | 293-244CP |
| | Quatum® Compression | – | 293-369COLDCP |
| | Slow Compression | – | 293-CP |
| | Slow Compression | • | 293-E27CP |
| Rough Chrome | Self-closing | – | 293-244RCF |
| | Slow Compression | – | 293-RCF |
| | Ceramic | – | 293-XKRCF |

Wall Mounted, Inside Sill Fitting

- Atmospheric vacuum breaker
- Polished chrome finish
- 3/4" male hose thread outlet
- Integral wall flange



| Inlet | Cartridge | Handle | Model |
|------------------------|------------------|--------|---------------|
| 1/2" NPT Female Thread | Slow Compression | Tee | 952-12CP |
| | Ceramic | Tee | 952-12XKCP |
| 3/4" NPT Female Thread | Slow Compression | Lever | 952-269CP |
| | Slow Compression | Cross | 952-633PLCP |
| | Slow Compression | Tee | 952-CP |
| | Ceramic | Tee | 952-XKCP |

Straight Stops

- 1/2" NPT female inlet
- 1/2" NPT female outlet
- Polished chrome finish



| Handle | Cartridge | Integral Check | Model |
|--------|------------------|----------------|------------------|
| Cross | Slow Compression | – | 45-ABCP |
| | Ceramic | – | 45-XKABCP |
| Tee | Slow Compression | – | 45-LKABCP |
| | Slow Compression | • | 45-LKCABCP |

Angle Stops

- 1/2" NPT female inlet
- 1/2" NPT female outlet
- Slow compression cartridge
- Polished chrome finish



| Handle | Integral Check | Model |
|--------|----------------|-------------------|
| Cross | – | 442-ABCP |
| Tee | – | 442-LKABCP |
| | • | 442-LKCABCP |

Compression Angle Stops

- Loose key handle
- Choice of 1/2" or 3/8" inlets and outlets
- Polished chrome finish



| Outlet | 1/2" NPT Female Thread Inlet | 3/8" NPT Female Thread Inlet |
|------------------------------|------------------------------|------------------------------|
| 1/2" O.D. Female Compression | STC-22-00-AB | STC-12-00-AB |
| 3/8" O.D. Female Compression | STC-21-00-AB | STC-11-00-AB |

Compression Angle Stops with Riser

- Loose key handle
- Choice of 1/2" or 3/8" inlets and outlets
- Polished chrome finish



12" Riser

| Outlet | 1/2" NPT Female Thread Inlet | 3/8" NPT Female Thread Inlet |
|------------------------------|------------------------------|------------------------------|
| 1/2" O.D. Female Compression | STC-22-11-AB | STC-12-11-AB |
| 3/8" O.D. Female Compression | STC-21-11-AB | STC-11-11-AB |

20" Riser

| Outlet | 1/2" NPT Female Thread Inlet | 3/8" NPT Female Thread Inlet |
|------------------------------|------------------------------|------------------------------|
| 1/2" O.D. Female Compression | STC-22-12-AB | STC-12-12-AB |
| 3/8" O.D. Female Compression | STC-21-12-AB | STC-11-12-AB |

Dual Supply Pedal Valve With Long Pedals

- Long pedal valves
- Solid brass construction
- Choice of polished chrome or rough chrome finish
- Choice of slow or fast closing metering cartridge
- Two 1/2" NPT female thread inlets
- 3/8" NPT female thread outlet



| Finish | Slow Closing Cartridge | Fast Closing Cartridge |
|-----------------|------------------------|------------------------|
| Polished Chrome | 625-LPSLOABCP | 625-LPABCP |
| Rough Chrome | 625-LPSLOABRCF | 625-LPABRCF |

Dual Supply Pedal Valve With Short Pedals

- Short pedal valves
- Solid brass construction
- Choice of polished chrome or rough chrome finish
- Choice of slow or fast closing metering cartridge
- Two 1/2" NPT female thread inlets
- 3/8" NPT female thread outlet



| Finish | Slow Closing Cartridge | Fast Closing Cartridge |
|-----------------|------------------------|------------------------|
| Polished Chrome | 625-SLOABCP | 625-ABCP |
| Rough Chrome | 625-SLOABRCF | 625-ABRCF |

Single Supply Pedal Valve With Short Pedal

- Short pedal valve
- Solid brass construction
- Choice of polished chrome or rough chrome finish
- Fast closing metering cartridge
- 1/2" NPT female thread inlet
- 3/8" NPT female thread outlet



| Finish | Fast Closing Cartridge |
|-----------------|------------------------|
| Polished Chrome | 628-ABCP |
| Rough Chrome | 628-ABRCF |

Deck Mount Remote Spouts

- Gooseneck spouts include rigid/swing option
- 2.2 GPM aerator or serrated nozzle outlet
- 1/2" NPSM supply inlet with coupling nut for 3/8" or 1/2" flexible riser
- Chrome plated finish



| Spout Dimensions | 2.2 GPM Aerated | Full Flow Nozzle |
|----------------------------------|-----------------------|------------------|
| 5-1/4" Gooseneck | 626-E3ABCP | 626-GN2BE7CP |
| 6" Gooseneck with Vacuum Breaker | 626-GN2BVBE3-2AB | 626-GN2BVBE7CP |
| 6" S-Type Swing Spout | 626-S6ABCP | - |
| 8" Gooseneck | 626-GN8AE3ABCP | 626-GN8BE7CP |
| 8" Gooseneck with Vacuum Breaker | 626-GN8BVBE3-2AB | 626-GN8BVBE7CP |

Wall Mount Remote Spouts

- Gooseneck spouts include rigid/swing option
- 2.2 GPM aerator or serrated nozzle outlet
- 1/2" NPT female thread inlet
- Chrome plated finish



| Spout Dimensions | 2.2 GPM Aerated | Full Flow Nozzle |
|----------------------------------|-----------------------|------------------|
| 3-1/2" Gooseneck | 629-E3ABCP | - |
| 5-1/4" Gooseneck | 629-GN2AE3ABCP | 629-GN2BE7CP |
| 6" Gooseneck with Vacuum Breaker | 629-GN2BVBE3-2AB | 629-GN2BVBE7CP |
| 6" S-Type Swing Spout | 629-S6ABCP | - |
| 8" Gooseneck | 629-GN8AE3ABCP | 629-GN8BE7CP |
| 8" Gooseneck with Vacuum Breaker | 629-GN8BVBE3-2AB | 629-GN8BVBE7CP |

Deck Mounted Electronic Faucet, Single Supply

- Single supply for tempered water
- Multiple field adjustable modes and ranges
- Compatible with Chicago Faucets Commander™ hand held programming unit
- 5-1/4" gooseneck spout with serrated nozzle
- Available with ASSE 1070 thermostatic mixing valve
- Choice of battery, hard wire, or plug-in power options



| Power | Less Mixing Valve | With Mixing Valve |
|-----------------------|-------------------|-------------------|
| Battery | LEF-B11-00 | LEF-B11-01 |
| Plug-In Transformer | LEF-A11-10 | LEF-A11-11 |
| Hard Wire Transformer | LEF-A11-20 | LEF-A11-21 |

Deck Mounted Electronic Faucet, Dual Supply With Internal Mechanical Mixer

- Dual supply for hot and cold water service
- Multiple field adjustable modes and ranges
- Compatible with Chicago Faucets Commander™ hand held programming unit
- 5-1/4" gooseneck spout with serrated nozzle
- Available with ASSE 1070 thermostatic mixing valve with cold water bypass
- Choice of battery, hard wire, or plug-in power options



| Power | Less Mixing Valve | With Mixing Valve |
|-----------------------|-------------------|-------------------|
| Battery | LEF-B21-00 | LEF-B21-01 |
| Plug-In Transformer | LEF-A21-10 | LEF-A21-11 |
| Hard Wire Transformer | LEF-A21-20 | LEF-A21-21 |

Deck Mounted Electronic Faucet, Dual Supply With User Temperature Control

- Dual supply for hot and cold water service
- Multiple field adjustable modes and ranges
- Compatible with Chicago Faucets Commander™ hand held programming unit
- 5-1/4" gooseneck spout with serrated nozzle
- Available with ASSE 1070 thermostatic mixing valve with cold water bypass
- Choice of battery, hard wire, or plug-in power options



| Power | Less Mixing Valve | With Mixing Valve |
|-----------------------|-------------------|-------------------|
| Battery | LEF-B31-00 | LEF-B31-01 |
| Plug-In Transformer | LEF-A31-10 | LEF-A31-11 |
| Hard Wire Transformer | LEF-A31-20 | LEF-A31-21 |

Wall Mounted Electronic Faucet, Single Supply

- Single supply for tempered water
- Multiple field adjustable modes and ranges
- Compatible with Chicago Faucets Commander™ hand held programming unit
- 5-1/4" gooseneck spout with serrated nozzle
- Available with ASSE 1070 thermostatic mixing valve
- Choice of battery, hard wire, or plug-in power options



| Power | Less Mixing Valve | With Mixing Valve |
|-----------------------|-------------------|-------------------|
| Battery | LEF-B41-00 | LEF-B41-01 |
| Plug-In Transformer | LEF-A41-10 | LEF-A41-11 |
| Hard Wire Transformer | LEF-A41-20 | LEF-A41-21 |

Wall Mounted Electronic Faucet, Dual Supply With Internal Mechanical Mixer

- Dual supply for hot and cold water service
- Multiple field adjustable modes and ranges
- Compatible with Chicago Faucets Commander™ hand held programming unit
- 5-1/4" gooseneck spout with serrated nozzle
- Available with ASSE 1070 thermostatic mixing valve with cold water bypass
- Choice of battery, hard wire, or plug-in power options



| Power | Less Mixing Valve | With Mixing Valve |
|-----------------------|-------------------|-------------------|
| Battery | LEF-B51-00 | LEF-B51-01 |
| Plug-In Transformer | LEF-A51-10 | LEF-A51-11 |
| Hard Wire Transformer | LEF-A51-20 | LEF-A51-21 |

Wall Mounted Electronic Faucet, Dual Supply With User Temperature Control

- Dual supply for hot and cold water service
- Multiple field adjustable modes and ranges
- Compatible with Chicago Faucets Commander™ hand held programming unit
- 5-1/4" gooseneck spout with serrated nozzle
- Available with ASSE 1070 thermostatic mixing valve with cold water bypass
- Choice of battery, hard wire, or plug-in power options



| Power | Less Mixing Valve | With Mixing Valve |
|-----------------------|-------------------|-------------------|
| Battery | LEF-B61-00 | LEF-B61-01 |
| Plug-In Transformer | LEF-A61-10 | LEF-A61-11 |
| Hard Wire Transformer | LEF-A61-20 | LEF-A61-21 |

Chicago Faucets Commander™ Hand Held Programming Unit

- Includes Commander software pre-installed, USB cable, two 'AA' batteries, Quick Start Guide
- Adjust timing, response, sensor range, select special operational modes, and collect usage data



| Commander |
|--------------|
| 116.585.00.1 |

Deck Mounted Pre-Rinse Units



2305-VBABCP

- 90-L spray valve
- 23" riser and 44" flexible steel hose with insulated handle
- 3/8" compression stainless steel supply hoses
- With in-line back flow preventer



526-919SLABCP

- 90-L spray valve
- 23" riser and 44" flexible steel hose with insulated handle
- 1/2" NPSM supply inlets and coupling nut for 3/8" or 1/2" flexible risers



920-L204AB

- 90-L spray valve
- 23" riser and 44" flexible steel hose with insulated handle
- 3/8" compression stainless steel supply hoses



919-VBHS90ANGABCP

- 90-L spray valve
- 44" flexible hose with insulated handle
- 3/8" compression stainless steel supply hoses
- With in-line back flow preventer

920-LVB204AB

- With in-line back flow preventer



919-L204ABCP

- 90-L spray valve
- 23" riser and 44" flexible steel hose with insulated handle
- 3-1/2" inlet tee with 1/4" NPT check stop tailpieces



923-GCL204WSAB

- 90-L spray valve
- 23" riser and 44" flexible steel hose with insulated handle
- 1/2" NPT male inlet and outlet with locknut washers



919-L613AABCP

- 90-L spray valve
- 9-1/2" L type swing spout
- Full flow outlet
- 23" riser and 44" flexible steel hose with insulated handle
- 3-1/2" inlet tee with 1/4" NPT check stop tailpieces



613-AABCP

- 9-1/2" L type swing spout
- Full flow outlet
- 1-1/16" - 18 UNEF female thread inlet

919-LVB204ABCP

- With in-line back flow preventer

923-GCLVB204WSAB

- With in-line back flow preventer

Wall Mounted Pre-Rinse Units



510-GC613AL12ABCP

- 90-L spray valve
- 12" L type swing spout
- Full flow outlet
- 23" riser and 44" flexible steel hose with insulated handle
- 3-3/8" body, adjustable arms 3" - 8-3/8"
- 2-5/16" diameter slip flange



923-LHC613AABCP

- 90-L spray valve
- 9-1/2" L type swing spout
- Full flow outlet
- 23" riser and 44" flexible steel hose with insulated handle
- 3-3/8" body, adjustable arms 3" - 8-3/8"
- 2-5/16" diameter slip flange



509-GCLABCP

- 90-ANG spray valve
- 9-1/2" L type swing spout
- Full flow outlet
- 60" flexible steel hose with insulated handle
- 8" body, adjustable arms 7-1/4" - 8-3/4"
- 3/8" offset inlet supply arm with integral check with 1/2" NPT female inlet



510-GCL204WSAB

- 90-L spray valve
- 23" riser and 44" flexible steel hose with insulated handle
- 3-3/8" body, adjustable arms 3" - 8-3/8"
- 1/2" NPT male inlet and outlet with locknut washers

510-GCLVB204WSAB

- With in-line back flow preventer

Spray Valves



90-ANGABCP

- 1.0 GPM spray



90-ANGE3ABCP

- 2.2 GPM outlet



90-GNABCP

- Full flow gooseneck



90-HABCP

- 2.5 GPM spray



90-LABCP

- 1.0 GPM spray



99-ASAB

- 1.25 GPM adjustable spray pattern



99TFAB

- 0.91/0.99 GPM adjustable spray pattern

How to build and order a Chicago Faucets laboratory gas needle valve fitting.

Chicago Faucets makes it easy for you to build gas needle valve fittings that meet your exact requirements. You can reference the charts on the following pages, or you can build your own valve by choosing the components below to configure your model number.

LGN **A** - **B** **C** **D** **E** - **F**

(Lab Gas Needle Valve)

Valve Base

A



Straight Valve



Angle Valve

Cartridge

B



Compression

Outlet

C



Straight Nozzle



30° Nozzle

EXAMPLE



LGN1-A21A-25

Straight valves with 30° outlets, metal lever handles with AIR index buttons, and single hole turret.

Handle

D



Metal

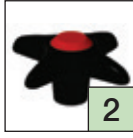

Plastic

Button

E

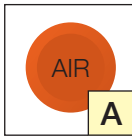

Air

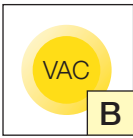

Vacuum

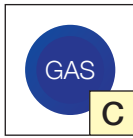

Gas

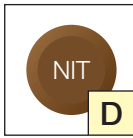

Nitrogen



Helium

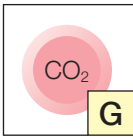

Carbon Dioxide

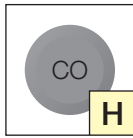

Carbon Monoxide

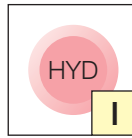

Hydrogen

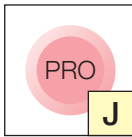

Propane

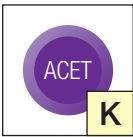

Acetylene

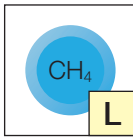

Methane

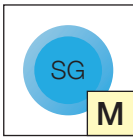

Specialty Gas

Turret

F



Single



Dual 90°



Dual 180°



Three Hole



Four Hole



Single Wall Flange

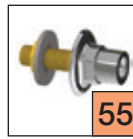

Single Wall Flange with Shank



Dual Wall Flange

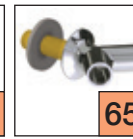

Dual Wall Flange with Shank

Straight Pattern Gas Needle Valve

- Solid brass straight valve body
- Polished chrome plated finish
- 2-1/2" vandal proof cross handle
- 3/8" - 18 NPT male thread inlet



| Index Button | Metal Handle | | Plastic Handle | |
|--------------|------------------|------------|-----------------|------------|
| | Straight Nozzle | 30° Nozzle | Straight Nozzle | 30° Nozzle |
| AIR | LGN1-A11A | LGN1-A21A | LGN1-A12A | LGN1-A22A |
| VAC | LGN1-A11B | LGN1-A21B | LGN1-A12B | LGN1-A22B |
| GAS | LGN1-A11C | LGN1-A21C | LGN1-A12C | LGN1-A22C |
| NIT | LGN1-A11D | LGN1-A21D | LGN1-A12D | LGN1-A22D |
| HE | LGN1-A11F | LGN1-A21F | LGN1-A12F | LGN1-A22F |
| CO2 | LGN1-A11G | LGN1-A21G | LGN1-A12G | LGN1-A22G |
| CO | LGN1-A11H | LGN1-A21H | LGN1-A12H | LGN1-A22H |
| HYD | LGN1-A11I | LGN1-A21I | LGN1-A12I | LGN1-A22I |
| PRO | LGN1-A11J | LGN1-A21J | LGN1-A12J | LGN1-A22J |
| ACET | LGN1-A11K | LGN1-A21K | LGN1-A12K | LGN1-A22K |
| CH4 | LGN1-A11L | LGN1-A21L | LGN1-A12L | LGN1-A22L |
| SG | LGN1-A11M | LGN1-A21M | LGN1-A12M | LGN1-A22M |

Deck Mounted, Straight Pattern Single Gas Needle Valve Assembly

- Solid brass turret with one outlet
- Solid brass straight valve body
- Polished chrome plated finish
- 2-1/2" vandal proof cross handle
- 3/8" - 18 NPT male thread shank assembly



| Index Button | Metal Handle | | Plastic Handle | |
|--------------|-----------------|--------------|-----------------|---------------------|
| | Straight Nozzle | 30° Nozzle | Straight Nozzle | 30° Nozzle |
| AIR | LGN1-A11A-10 | LGN1-A21A-10 | LGN1-A12A-10 | LGN1-A22A-10 |
| VAC | LGN1-A11B-10 | LGN1-A21B-10 | LGN1-A12B-10 | LGN1-A22B-10 |
| GAS | LGN1-A11C-10 | LGN1-A21C-10 | LGN1-A12C-10 | LGN1-A22C-10 |
| NIT | LGN1-A11D-10 | LGN1-A21D-10 | LGN1-A12D-10 | LGN1-A22D-10 |
| HE | LGN1-A11F-10 | LGN1-A21F-10 | LGN1-A12F-10 | LGN1-A22F-10 |
| CO2 | LGN1-A11G-10 | LGN1-A21G-10 | LGN1-A12G-10 | LGN1-A22G-10 |
| CO | LGN1-A11H-10 | LGN1-A21H-10 | LGN1-A12H-10 | LGN1-A22H-10 |
| HYD | LGN1-A11I-10 | LGN1-A21I-10 | LGN1-A12I-10 | LGN1-A22I-10 |
| PRO | LGN1-A11J-10 | LGN1-A21J-10 | LGN1-A12J-10 | LGN1-A22J-10 |
| ACET | LGN1-A11K-10 | LGN1-A21K-10 | LGN1-A12K-10 | LGN1-A22K-10 |
| CH4 | LGN1-A11L-10 | LGN1-A21L-10 | LGN1-A12L-10 | LGN1-A22L-10 |
| SG | LGN1-A11M-10 | LGN1-A21M-10 | LGN1-A12M-10 | LGN1-A22M-10 |

Deck Mounted, Straight Pattern Dual 90° Gas Needle Valve Assembly

- Solid brass turret with two 90° outlets
- Solid brass straight valve body
- Polished chrome plated finish
- 2-1/2" vandal proof cross handle
- 3/8" - 18 NPT male thread shank assembly



| Index Button | Metal Handle | | Plastic Handle | |
|--------------|-----------------|---------------------|-----------------|--------------|
| | Straight Nozzle | 30° Nozzle | Straight Nozzle | 30° Nozzle |
| AIR | LGN1-A11A-20 | LGN1-A21A-20 | LGN1-A12A-20 | LGN1-A22A-20 |
| VAC | LGN1-A11B-20 | LGN1-A21B-20 | LGN1-A12B-20 | LGN1-A22B-20 |
| GAS | LGN1-A11C-20 | LGN1-A21C-20 | LGN1-A12C-20 | LGN1-A22C-20 |
| NIT | LGN1-A11D-20 | LGN1-A21D-20 | LGN1-A12D-20 | LGN1-A22D-20 |
| HE | LGN1-A11F-20 | LGN1-A21F-20 | LGN1-A12F-20 | LGN1-A22F-20 |
| CO2 | LGN1-A11G-20 | LGN1-A21G-20 | LGN1-A12G-20 | LGN1-A22G-20 |
| CO | LGN1-A11H-20 | LGN1-A21H-20 | LGN1-A12H-20 | LGN1-A22H-20 |
| HYD | LGN1-A11I-20 | LGN1-A21I-20 | LGN1-A12I-20 | LGN1-A22I-20 |
| PRO | LGN1-A11J-20 | LGN1-A21J-20 | LGN1-A12J-20 | LGN1-A22J-20 |
| ACET | LGN1-A11K-20 | LGN1-A21K-20 | LGN1-A12K-20 | LGN1-A22K-20 |
| CH4 | LGN1-A11L-20 | LGN1-A21L-20 | LGN1-A12L-20 | LGN1-A22L-20 |
| SG | LGN1-A11M-20 | LGN1-A21M-20 | LGN1-A12M-20 | LGN1-A22M-20 |

Deck Mounted, Straight Pattern Dual 180° Gas Needle Valve Assembly

- Solid brass turret with two 180° outlets
- Solid brass straight valve body
- Polished chrome plated finish
- 2-1/2" vandal proof cross handle
- 3/8" - 18 NPT male thread shank assembly



| Index Button | Metal Handle | | Plastic Handle | |
|--------------|-----------------|--------------|---------------------|--------------|
| | Straight Nozzle | 30° Nozzle | Straight Nozzle | 30° Nozzle |
| AIR | LGN1-A11A-25 | LGN1-A21A-25 | LGN1-A12A-25 | LGN1-A22A-25 |
| VAC | LGN1-A11B-25 | LGN1-A21B-25 | LGN1-A12B-25 | LGN1-A22B-25 |
| GAS | LGN1-A11C-25 | LGN1-A21C-25 | LGN1-A12C-25 | LGN1-A22C-25 |
| NIT | LGN1-A11D-25 | LGN1-A21D-25 | LGN1-A12D-25 | LGN1-A22D-25 |
| HE | LGN1-A11F-25 | LGN1-A21F-25 | LGN1-A12F-25 | LGN1-A22F-25 |
| CO2 | LGN1-A11G-25 | LGN1-A21G-25 | LGN1-A12G-25 | LGN1-A22G-25 |
| CO | LGN1-A11H-25 | LGN1-A21H-25 | LGN1-A12H-25 | LGN1-A22H-25 |
| HYD | LGN1-A11I-25 | LGN1-A21I-25 | LGN1-A12I-25 | LGN1-A22I-25 |
| PRO | LGN1-A11J-25 | LGN1-A21J-25 | LGN1-A12J-25 | LGN1-A22J-25 |
| ACET | LGN1-A11K-25 | LGN1-A21K-25 | LGN1-A12K-25 | LGN1-A22K-25 |
| CH4 | LGN1-A11L-25 | LGN1-A21L-25 | LGN1-A12L-25 | LGN1-A22L-25 |
| SG | LGN1-A11M-25 | LGN1-A21M-25 | LGN1-A12M-25 | LGN1-A22M-25 |

Deck Mounted, Straight Pattern Three Gas Needle Valve Assembly

- Solid brass turret with three outlets
- Solid brass straight valve body
- Polished chrome plated finish
- 2-1/2" vandal proof cross handle
- 3/8" - 18 NPT male thread shank assembly



| Index Button | Metal Handle | | Plastic Handle | |
|--------------|---------------------|--------------|-----------------|--------------|
| | Straight Nozzle | 30° Nozzle | Straight Nozzle | 30° Nozzle |
| AIR | LGN1-A11A-30 | LGN1-A21A-30 | LGN1-A12A-30 | LGN1-A22A-30 |
| VAC | LGN1-A11B-30 | LGN1-A21B-30 | LGN1-A12B-30 | LGN1-A22B-30 |
| GAS | LGN1-A11C-30 | LGN1-A21C-30 | LGN1-A12C-30 | LGN1-A22C-30 |
| NIT | LGN1-A11D-30 | LGN1-A21D-30 | LGN1-A12D-30 | LGN1-A22D-30 |
| HE | LGN1-A11F-30 | LGN1-A21F-30 | LGN1-A12F-30 | LGN1-A22F-30 |
| CO2 | LGN1-A11G-30 | LGN1-A21G-30 | LGN1-A12G-30 | LGN1-A22G-30 |
| CO | LGN1-A11H-30 | LGN1-A21H-30 | LGN1-A12H-30 | LGN1-A22H-30 |
| HYD | LGN1-A11I-30 | LGN1-A21I-30 | LGN1-A12I-30 | LGN1-A22I-30 |
| PRO | LGN1-A11J-30 | LGN1-A21J-30 | LGN1-A12J-30 | LGN1-A22J-30 |
| ACET | LGN1-A11K-30 | LGN1-A21K-30 | LGN1-A12K-30 | LGN1-A22K-30 |
| CH4 | LGN1-A11L-30 | LGN1-A21L-30 | LGN1-A12L-30 | LGN1-A22L-30 |
| SG | LGN1-A11M-30 | LGN1-A21M-30 | LGN1-A12M-30 | LGN1-A22M-30 |

Deck Mounted, Straight Pattern Four Gas Needle Valve Assembly

- Solid brass turret with four outlets
- Solid brass straight valve body
- Polished chrome plated finish
- 2-1/2" vandal proof cross handle
- 3/8" - 18 NPT male thread shank assembly



| Index Button | Metal Handle | | Plastic Handle | |
|--------------|-----------------|--------------|-----------------|---------------------|
| | Straight Nozzle | 30° Nozzle | Straight Nozzle | 30° Nozzle |
| AIR | LGN1-A11A-40 | LGN1-A21A-40 | LGN1-A12A-40 | LGN1-A22A-40 |
| VAC | LGN1-A11B-40 | LGN1-A21B-40 | LGN1-A12B-40 | LGN1-A22B-40 |
| GAS | LGN1-A11C-40 | LGN1-A21C-40 | LGN1-A12C-40 | LGN1-A22C-40 |
| NIT | LGN1-A11D-40 | LGN1-A21D-40 | LGN1-A12D-40 | LGN1-A22D-40 |
| HE | LGN1-A11F-40 | LGN1-A21F-40 | LGN1-A12F-40 | LGN1-A22F-40 |
| CO2 | LGN1-A11G-40 | LGN1-A21G-40 | LGN1-A12G-40 | LGN1-A22G-40 |
| CO | LGN1-A11H-40 | LGN1-A21H-40 | LGN1-A12H-40 | LGN1-A22H-40 |
| HYD | LGN1-A11I-40 | LGN1-A21I-40 | LGN1-A12I-40 | LGN1-A22I-40 |
| PRO | LGN1-A11J-40 | LGN1-A21J-40 | LGN1-A12J-40 | LGN1-A22J-40 |
| ACET | LGN1-A11K-40 | LGN1-A21K-40 | LGN1-A12K-40 | LGN1-A22K-40 |
| CH4 | LGN1-A11L-40 | LGN1-A21L-40 | LGN1-A12L-40 | LGN1-A22L-40 |
| SG | LGN1-A11M-40 | LGN1-A21M-40 | LGN1-A12M-40 | LGN1-A22M-40 |

Wall Mounted, Straight Pattern Single Gas Needle Valve Assembly Less Shank

- Wall flange
- Solid brass straight valve body
- Polished chrome plated finish
- 2-1/2" vandal proof cross handle
- 3/8" - 18 NPT female thread inlet



| Index Button | Metal Handle | | Plastic Handle | |
|--------------|---------------------|--------------|-----------------|--------------|
| | Straight Nozzle | 30° Nozzle | Straight Nozzle | 30° Nozzle |
| AIR | LGN1-A11A-50 | LGN1-A21A-50 | LGN1-A12A-50 | LGN1-A22A-50 |
| VAC | LGN1-A11B-50 | LGN1-A21B-50 | LGN1-A12B-50 | LGN1-A22B-50 |
| GAS | LGN1-A11C-50 | LGN1-A21C-50 | LGN1-A12C-50 | LGN1-A22C-50 |
| NIT | LGN1-A11D-50 | LGN1-A21D-50 | LGN1-A12D-50 | LGN1-A22D-50 |
| HE | LGN1-A11F-50 | LGN1-A21F-50 | LGN1-A12F-50 | LGN1-A22F-50 |
| CO2 | LGN1-A11G-50 | LGN1-A21G-50 | LGN1-A12G-50 | LGN1-A22G-50 |
| CO | LGN1-A11H-50 | LGN1-A21H-50 | LGN1-A12H-50 | LGN1-A22H-50 |
| HYD | LGN1-A11I-50 | LGN1-A21I-50 | LGN1-A12I-50 | LGN1-A22I-50 |
| PRO | LGN1-A11J-50 | LGN1-A21J-50 | LGN1-A12J-50 | LGN1-A22J-50 |
| ACET | LGN1-A11K-50 | LGN1-A21K-50 | LGN1-A12K-50 | LGN1-A22K-50 |
| CH4 | LGN1-A11L-50 | LGN1-A21L-50 | LGN1-A12L-50 | LGN1-A22L-50 |
| SG | LGN1-A11M-50 | LGN1-A21M-50 | LGN1-A12M-50 | LGN1-A22M-50 |

Wall Mounted, Straight Pattern Single Gas Needle Valve Assembly With Shank

- Wall flange
- Solid brass straight valve body
- Polished chrome plated finish
- 2-1/2" vandal proof cross handle
- 3/8" - 18 NPT male thread shank assembly



| Index Button | Metal Handle | | Plastic Handle | |
|--------------|-----------------|--------------|---------------------|--------------|
| | Straight Nozzle | 30° Nozzle | Straight Nozzle | 30° Nozzle |
| AIR | LGN1-A11A-55 | LGN1-A21A-55 | LGN1-A12A-55 | LGN1-A22A-55 |
| VAC | LGN1-A11B-55 | LGN1-A21B-55 | LGN1-A12B-55 | LGN1-A22B-55 |
| GAS | LGN1-A11C-55 | LGN1-A21C-55 | LGN1-A12C-55 | LGN1-A22C-55 |
| NIT | LGN1-A11D-55 | LGN1-A21D-55 | LGN1-A12D-55 | LGN1-A22D-55 |
| HE | LGN1-A11F-55 | LGN1-A21F-55 | LGN1-A12F-55 | LGN1-A22F-55 |
| CO2 | LGN1-A11G-55 | LGN1-A21G-55 | LGN1-A12G-55 | LGN1-A22G-55 |
| CO | LGN1-A11H-55 | LGN1-A21H-55 | LGN1-A12H-55 | LGN1-A22H-55 |
| HYD | LGN1-A11I-55 | LGN1-A21I-55 | LGN1-A12I-55 | LGN1-A22I-55 |
| PRO | LGN1-A11J-55 | LGN1-A21J-55 | LGN1-A12J-55 | LGN1-A22J-55 |
| ACET | LGN1-A11K-55 | LGN1-A21K-55 | LGN1-A12K-55 | LGN1-A22K-55 |
| CH4 | LGN1-A11L-55 | LGN1-A21L-55 | LGN1-A12L-55 | LGN1-A22L-55 |
| SG | LGN1-A11M-55 | LGN1-A21M-55 | LGN1-A12M-55 | LGN1-A22M-55 |

Wall Mounted, “Y” Pattern Dual 90° Gas Needle Valve Assembly Less Shank

- “Y” pattern wall flange with two valves at 90°
- Solid brass straight valve body
- Polished chrome plated finish
- 2-1/2” vandal proof cross handle
- 3/8” - 18 NPT female thread inlet



| Index Button | Metal Handle | | Plastic Handle | |
|--------------|-----------------|---------------------|-----------------|--------------|
| | Straight Nozzle | 30° Nozzle | Straight Nozzle | 30° Nozzle |
| AIR | LGN1-A11A-60 | LGN1-A21A-60 | LGN1-A12A-60 | LGN1-A22A-60 |
| VAC | LGN1-A11B-60 | LGN1-A21B-60 | LGN1-A12B-60 | LGN1-A22B-60 |
| GAS | LGN1-A11C-60 | LGN1-A21C-60 | LGN1-A12C-60 | LGN1-A22C-60 |
| NIT | LGN1-A11D-60 | LGN1-A21D-60 | LGN1-A12D-60 | LGN1-A22D-60 |
| HE | LGN1-A11F-60 | LGN1-A21F-60 | LGN1-A12F-60 | LGN1-A22F-60 |
| CO2 | LGN1-A11G-60 | LGN1-A21G-60 | LGN1-A12G-60 | LGN1-A22G-60 |
| CO | LGN1-A11H-60 | LGN1-A21H-60 | LGN1-A12H-60 | LGN1-A22H-60 |
| HYD | LGN1-A11I-60 | LGN1-A21I-60 | LGN1-A12I-60 | LGN1-A22I-60 |
| PRO | LGN1-A11J-60 | LGN1-A21J-60 | LGN1-A12J-60 | LGN1-A22J-60 |
| ACET | LGN1-A11K-60 | LGN1-A21K-60 | LGN1-A12K-60 | LGN1-A22K-60 |
| CH4 | LGN1-A11L-60 | LGN1-A21L-60 | LGN1-A12L-60 | LGN1-A22L-60 |
| SG | LGN1-A11M-60 | LGN1-A21M-60 | LGN1-A12M-60 | LGN1-A22M-60 |

Wall Mounted, “Y” Pattern Dual 90° Gas Needle Valve Assembly With Shank

- “Y” pattern wall flange with two valves at 90°
- Solid brass straight valve body
- Polished chrome plated finish
- 2-1/2” vandal proof cross handle
- 3/8” - 18 NPT male thread shank assembly



| Index Button | Metal Handle | | Plastic Handle | |
|--------------|---------------------|--------------|-----------------|--------------|
| | Straight Nozzle | 30° Nozzle | Straight Nozzle | 30° Nozzle |
| AIR | LGN1-A11A-65 | LGN1-A21A-65 | LGN1-A12A-65 | LGN1-A22A-65 |
| VAC | LGN1-A11B-65 | LGN1-A21B-65 | LGN1-A12B-65 | LGN1-A22B-65 |
| GAS | LGN1-A11C-65 | LGN1-A21C-65 | LGN1-A12C-65 | LGN1-A22C-65 |
| NIT | LGN1-A11D-65 | LGN1-A21D-65 | LGN1-A12D-65 | LGN1-A22D-65 |
| HE | LGN1-A11F-65 | LGN1-A21F-65 | LGN1-A12F-65 | LGN1-A22F-65 |
| CO2 | LGN1-A11G-65 | LGN1-A21G-65 | LGN1-A12G-65 | LGN1-A22G-65 |
| CO | LGN1-A11H-65 | LGN1-A21H-65 | LGN1-A12H-65 | LGN1-A22H-65 |
| HYD | LGN1-A11I-65 | LGN1-A21I-65 | LGN1-A12I-65 | LGN1-A22I-65 |
| PRO | LGN1-A11J-65 | LGN1-A21J-65 | LGN1-A12J-65 | LGN1-A22J-65 |
| ACET | LGN1-A11K-65 | LGN1-A21K-65 | LGN1-A12K-65 | LGN1-A22K-65 |
| CH4 | LGN1-A11L-65 | LGN1-A21L-65 | LGN1-A12L-65 | LGN1-A22L-65 |
| SG | LGN1-A11M-65 | LGN1-A21M-65 | LGN1-A12M-65 | LGN1-A22M-65 |

Angle Pattern Gas Needle Valve

- Solid brass angle valve body
- Polished chrome plated finish
- 2-1/2" vandal proof cross handle
- 3/8" - 18 NPT female thread inlet



| Index Button | Metal Handle | | Plastic Handle | |
|--------------|-----------------|------------------|-----------------|------------|
| | Straight Nozzle | 30° Nozzle | Straight Nozzle | 30° Nozzle |
| AIR | LGN3-A11A | LGN3-A21A | LGN3-A12A | LGN3-A22A |
| VAC | LGN3-A11B | LGN3-A21B | LGN3-A12B | LGN3-A22B |
| GAS | LGN3-A11C | LGN3-A21C | LGN3-A12C | LGN3-A22C |
| NIT | LGN3-A11D | LGN3-A21D | LGN3-A12D | LGN3-A22D |
| HE | LGN3-A11F | LGN3-A21F | LGN3-A12F | LGN3-A22F |
| CO2 | LGN3-A11G | LGN3-A21G | LGN3-A12G | LGN3-A22G |
| CO | LGN3-A11H | LGN3-A21H | LGN3-A12H | LGN3-A22H |
| HYD | LGN3-A11I | LGN3-A21I | LGN3-A12I | LGN3-A22I |
| PRO | LGN3-A11J | LGN3-A21J | LGN3-A12J | LGN3-A22J |
| ACET | LGN3-A11K | LGN3-A21K | LGN3-A12K | LGN3-A22K |
| CH4 | LGN3-A11L | LGN3-A21L | LGN3-A12L | LGN3-A22L |
| SG | LGN3-A11M | LGN3-A21M | LGN3-A12M | LGN3-A22M |

Overhead Mounted, Angle Pattern Single Gas Needle Valve Assembly

- Solid brass turret with one outlet
- Solid brass angle valve body
- Polished chrome plated finish
- 2-1/2" vandal proof cross handle
- 3/8" - 18 NPT male thread shank assembly



| Index Button | Metal Handle | | Plastic Handle | |
|--------------|-----------------|--------------|-----------------|---------------------|
| | Straight Nozzle | 30° Nozzle | Straight Nozzle | 30° Nozzle |
| AIR | LGN3-A11A-10 | LGN3-A21A-10 | LGN3-A12A-10 | LGN3-A22A-10 |
| VAC | LGN3-A11B-10 | LGN3-A21B-10 | LGN3-A12B-10 | LGN3-A22B-10 |
| GAS | LGN3-A11C-10 | LGN3-A21C-10 | LGN3-A12C-10 | LGN3-A22C-10 |
| NIT | LGN3-A11D-10 | LGN3-A21D-10 | LGN3-A12D-10 | LGN3-A22D-10 |
| HE | LGN3-A11F-10 | LGN3-A21F-10 | LGN3-A12F-10 | LGN3-A22F-10 |
| CO2 | LGN3-A11G-10 | LGN3-A21G-10 | LGN3-A12G-10 | LGN3-A22G-10 |
| CO | LGN3-A11H-10 | LGN3-A21H-10 | LGN3-A12H-10 | LGN3-A22H-10 |
| HYD | LGN3-A11I-10 | LGN3-A21I-10 | LGN3-A12I-10 | LGN3-A22I-10 |
| PRO | LGN3-A11J-10 | LGN3-A21J-10 | LGN3-A12J-10 | LGN3-A22J-10 |
| ACET | LGN3-A11K-10 | LGN3-A21K-10 | LGN3-A12K-10 | LGN3-A22K-10 |
| CH4 | LGN3-A11L-10 | LGN3-A21L-10 | LGN3-A12L-10 | LGN3-A22L-10 |
| SG | LGN3-A11M-10 | LGN3-A21M-10 | LGN3-A12M-10 | LGN3-A22M-10 |

Overhead Mounted, Angle Pattern Dual 90° Gas Needle Valve Assembly

- Solid brass turret with two 90° outlets
- Solid brass angle valve body
- Polished chrome plated finish
- 2-1/2" vandal proof cross handle
- 3/8" - 18 NPT male thread shank assembly



| Index Button | Metal Handle | | Plastic Handle | |
|--------------|---------------------|--------------|-----------------|--------------|
| | Straight Nozzle | 30° Nozzle | Straight Nozzle | 30° Nozzle |
| AIR | LGN3-A11A-20 | LGN3-A21A-20 | LGN3-A12A-20 | LGN3-A22A-20 |
| VAC | LGN3-A11B-20 | LGN3-A21B-20 | LGN3-A12B-20 | LGN3-A22B-20 |
| GAS | LGN3-A11C-20 | LGN3-A21C-20 | LGN3-A12C-20 | LGN3-A22C-20 |
| NIT | LGN3-A11D-20 | LGN3-A21D-20 | LGN3-A12D-20 | LGN3-A22D-20 |
| HE | LGN3-A11F-20 | LGN3-A21F-20 | LGN3-A12F-20 | LGN3-A22F-20 |
| CO2 | LGN3-A11G-20 | LGN3-A21G-20 | LGN3-A12G-20 | LGN3-A22G-20 |
| CO | LGN3-A11H-20 | LGN3-A21H-20 | LGN3-A12H-20 | LGN3-A22H-20 |
| HYD | LGN3-A11I-20 | LGN3-A21I-20 | LGN3-A12I-20 | LGN3-A22I-20 |
| PRO | LGN3-A11J-20 | LGN3-A21J-20 | LGN3-A12J-20 | LGN3-A22J-20 |
| ACET | LGN3-A11K-20 | LGN3-A21K-20 | LGN3-A12K-20 | LGN3-A22K-20 |
| CH4 | LGN3-A11L-20 | LGN3-A21L-20 | LGN3-A12L-20 | LGN3-A22L-20 |
| SG | LGN3-A11M-20 | LGN3-A21M-20 | LGN3-A12M-20 | LGN3-A22M-20 |

Overhead Mounted, Angle Pattern Dual 180° Gas Needle Valve Assembly

- Solid brass turret with two 180° outlets
- Solid brass angle valve body
- Polished chrome plated finish
- 2-1/2" vandal proof cross handle
- 3/8" - 18 NPT male thread shank assembly

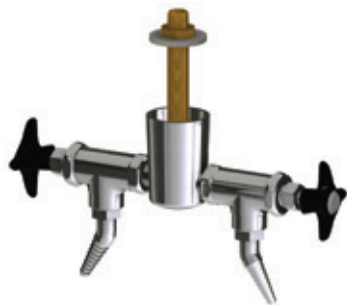

| Index Button | Metal Handle | | Plastic Handle | |
|--------------|-----------------|--------------|-----------------|---------------------|
| | Straight Nozzle | 30° Nozzle | Straight Nozzle | 30° Nozzle |
| AIR | LGN3-A11A-25 | LGN3-A21A-25 | LGN3-A12A-25 | LGN3-A22A-25 |
| VAC | LGN3-A11B-25 | LGN3-A21B-25 | LGN3-A12B-25 | LGN3-A22B-25 |
| GAS | LGN3-A11C-25 | LGN3-A21C-25 | LGN3-A12C-25 | LGN3-A22C-25 |
| NIT | LGN3-A11D-25 | LGN3-A21D-25 | LGN3-A12D-25 | LGN3-A22D-25 |
| HE | LGN3-A11F-25 | LGN3-A21F-25 | LGN3-A12F-25 | LGN3-A22F-25 |
| CO2 | LGN3-A11G-25 | LGN3-A21G-25 | LGN3-A12G-25 | LGN3-A22G-25 |
| CO | LGN3-A11H-25 | LGN3-A21H-25 | LGN3-A12H-25 | LGN3-A22H-25 |
| HYD | LGN3-A11I-25 | LGN3-A21I-25 | LGN3-A12I-25 | LGN3-A22I-25 |
| PRO | LGN3-A11J-25 | LGN3-A21J-25 | LGN3-A12J-25 | LGN3-A22J-25 |
| ACET | LGN3-A11K-25 | LGN3-A21K-25 | LGN3-A12K-25 | LGN3-A22K-25 |
| CH4 | LGN3-A11L-25 | LGN3-A21L-25 | LGN3-A12L-25 | LGN3-A22L-25 |
| SG | LGN3-A11M-25 | LGN3-A21M-25 | LGN3-A12M-25 | LGN3-A22M-25 |

Overhead Mounted, Angle Pattern Three Gas Needle Valve Assembly

- Solid brass turret with three outlets
- Solid brass angle valve body
- Polished chrome plated finish
- 2-1/2" vandal proof cross handle
- 3/8" - 18 NPT male thread shank assembly

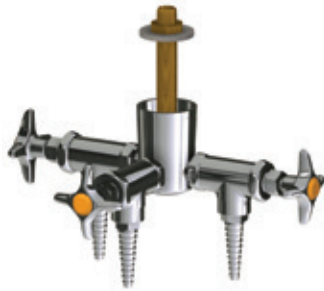

| Index Button | Metal Handle | | Plastic Handle | |
|--------------|---------------------|--------------|-----------------|--------------|
| | Straight Nozzle | 30° Nozzle | Straight Nozzle | 30° Nozzle |
| AIR | LGN3-A11A-30 | LGN3-A21A-30 | LGN3-A12A-30 | LGN3-A22A-30 |
| VAC | LGN3-A11B-30 | LGN3-A21B-30 | LGN3-A12B-30 | LGN3-A22B-30 |
| GAS | LGN3-A11C-30 | LGN3-A21C-30 | LGN3-A12C-30 | LGN3-A22C-30 |
| NIT | LGN3-A11D-30 | LGN3-A21D-30 | LGN3-A12D-30 | LGN3-A22D-30 |
| HE | LGN3-A11F-30 | LGN3-A21F-30 | LGN3-A12F-30 | LGN3-A22F-30 |
| CO2 | LGN3-A11G-30 | LGN3-A21G-30 | LGN3-A12G-30 | LGN3-A22G-30 |
| CO | LGN3-A11H-30 | LGN3-A21H-30 | LGN3-A12H-30 | LGN3-A22H-30 |
| HYD | LGN3-A11I-30 | LGN3-A21I-30 | LGN3-A12I-30 | LGN3-A22I-30 |
| PRO | LGN3-A11J-30 | LGN3-A21J-30 | LGN3-A12J-30 | LGN3-A22J-30 |
| ACET | LGN3-A11K-30 | LGN3-A21K-30 | LGN3-A12K-30 | LGN3-A22K-30 |
| CH4 | LGN3-A11L-30 | LGN3-A21L-30 | LGN3-A12L-30 | LGN3-A22L-30 |
| SG | LGN3-A11M-30 | LGN3-A21M-30 | LGN3-A12M-30 | LGN3-A22M-30 |

Overhead Mounted, Angle Pattern Four Gas Needle Valve Assembly

- Solid brass turret with four outlets
- Solid brass angle valve body
- Polished chrome plated finish
- 2-1/2" vandal proof cross handle
- 3/8" - 18 NPT male thread shank assembly

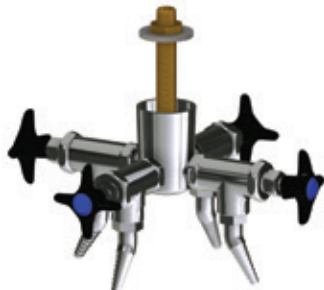

| Index Button | Metal Handle | | Plastic Handle | |
|--------------|-----------------|--------------|-----------------|---------------------|
| | Straight Nozzle | 30° Nozzle | Straight Nozzle | 30° Nozzle |
| AIR | LGN3-A11A-40 | LGN3-A21A-40 | LGN3-A12A-40 | LGN3-A22A-40 |
| VAC | LGN3-A11B-40 | LGN3-A21B-40 | LGN3-A12B-40 | LGN3-A22B-40 |
| GAS | LGN3-A11C-40 | LGN3-A21C-40 | LGN3-A12C-40 | LGN3-A22C-40 |
| NIT | LGN3-A11D-40 | LGN3-A21D-40 | LGN3-A12D-40 | LGN3-A22D-40 |
| HE | LGN3-A11F-40 | LGN3-A21F-40 | LGN3-A12F-40 | LGN3-A22F-40 |
| CO2 | LGN3-A11G-40 | LGN3-A21G-40 | LGN3-A12G-40 | LGN3-A22G-40 |
| CO | LGN3-A11H-40 | LGN3-A21H-40 | LGN3-A12H-40 | LGN3-A22H-40 |
| HYD | LGN3-A11I-40 | LGN3-A21I-40 | LGN3-A12I-40 | LGN3-A22I-40 |
| PRO | LGN3-A11J-40 | LGN3-A21J-40 | LGN3-A12J-40 | LGN3-A22J-40 |
| ACET | LGN3-A11K-40 | LGN3-A21K-40 | LGN3-A12K-40 | LGN3-A22K-40 |
| CH4 | LGN3-A11L-40 | LGN3-A21L-40 | LGN3-A12L-40 | LGN3-A22L-40 |
| SG | LGN3-A11M-40 | LGN3-A21M-40 | LGN3-A12M-40 | LGN3-A22M-40 |

Wall Mounted, Angle Pattern Single Gas Needle Valve Assembly Less Shank

- Wall flange
- Solid brass angle valve body
- Polished chrome plated finish
- 2-1/2" vandal proof cross handle
- 3/8" - 18 NPT female thread inlet



| Index Button | Metal Handle | | Plastic Handle | |
|--------------|---------------------|--------------|-----------------|--------------|
| | Straight Nozzle | 30° Nozzle | Straight Nozzle | 30° Nozzle |
| AIR | LGN3-A11A-50 | LGN3-A21A-50 | LGN3-A12A-50 | LGN3-A22A-50 |
| VAC | LGN3-A11B-50 | LGN3-A21B-50 | LGN3-A12B-50 | LGN3-A22B-50 |
| GAS | LGN3-A11C-50 | LGN3-A21C-50 | LGN3-A12C-50 | LGN3-A22C-50 |
| NIT | LGN3-A11D-50 | LGN3-A21D-50 | LGN3-A12D-50 | LGN3-A22D-50 |
| HE | LGN3-A11F-50 | LGN3-A21F-50 | LGN3-A12F-50 | LGN3-A22F-50 |
| CO2 | LGN3-A11G-50 | LGN3-A21G-50 | LGN3-A12G-50 | LGN3-A22G-50 |
| CO | LGN3-A11H-50 | LGN3-A21H-50 | LGN3-A12H-50 | LGN3-A22H-50 |
| HYD | LGN3-A11I-50 | LGN3-A21I-50 | LGN3-A12I-50 | LGN3-A22I-50 |
| PRO | LGN3-A11J-50 | LGN3-A21J-50 | LGN3-A12J-50 | LGN3-A22J-50 |
| ACET | LGN3-A11K-50 | LGN3-A21K-50 | LGN3-A12K-50 | LGN3-A22K-50 |
| CH4 | LGN3-A11L-50 | LGN3-A21L-50 | LGN3-A12L-50 | LGN3-A22L-50 |
| SG | LGN3-A11M-50 | LGN3-A21M-50 | LGN3-A12M-50 | LGN3-A22M-50 |

Wall Mounted, Angle Pattern Single Gas Needle Valve Assembly With Shank

- Wall flange
- Solid brass angle valve body
- Polished chrome plated finish
- 2-1/2" vandal proof cross handle
- 3/8" - 18 NPT male thread shank assembly



| Index Button | Metal Handle | | Plastic Handle | |
|--------------|-----------------|--------------|---------------------|--------------|
| | Straight Nozzle | 30° Nozzle | Straight Nozzle | 30° Nozzle |
| AIR | LGN3-A11A-55 | LGN3-A21A-55 | LGN3-A12A-55 | LGN3-A22A-55 |
| VAC | LGN3-A11B-55 | LGN3-A21B-55 | LGN3-A12B-55 | LGN3-A22B-55 |
| GAS | LGN3-A11C-55 | LGN3-A21C-55 | LGN3-A12C-55 | LGN3-A22C-55 |
| NIT | LGN3-A11D-55 | LGN3-A21D-55 | LGN3-A12D-55 | LGN3-A22D-55 |
| HE | LGN3-A11F-55 | LGN3-A21F-55 | LGN3-A12F-55 | LGN3-A22F-55 |
| CO2 | LGN3-A11G-55 | LGN3-A21G-55 | LGN3-A12G-55 | LGN3-A22G-55 |
| CO | LGN3-A11H-55 | LGN3-A21H-55 | LGN3-A12H-55 | LGN3-A22H-55 |
| HYD | LGN3-A11I-55 | LGN3-A21I-55 | LGN3-A12I-55 | LGN3-A22I-55 |
| PRO | LGN3-A11J-55 | LGN3-A21J-55 | LGN3-A12J-55 | LGN3-A22J-55 |
| ACET | LGN3-A11K-55 | LGN3-A21K-55 | LGN3-A12K-55 | LGN3-A22K-55 |
| CH4 | LGN3-A11L-55 | LGN3-A21L-55 | LGN3-A12L-55 | LGN3-A22L-55 |
| SG | LGN3-A11M-55 | LGN3-A21M-55 | LGN3-A12M-55 | LGN3-A22M-55 |

Wall Mounted, “Y” Pattern Dual 90° Gas Needle Valve Assembly Less Shank

- “Y” pattern wall flange with two valves at 90°
- Solid brass angle valve body
- Polished chrome plated finish
- 2-1/2” vandal proof cross handle
- 3/8” - 18 NPT female thread inlet



| Index Button | Metal Handle | | Plastic Handle | |
|--------------|-----------------|---------------------|-----------------|--------------|
| | Straight Nozzle | 30° Nozzle | Straight Nozzle | 30° Nozzle |
| AIR | LGN3-A11A-60 | LGN3-A21A-60 | LGN3-A12A-60 | LGN3-A22A-60 |
| VAC | LGN3-A11B-60 | LGN3-A21B-60 | LGN3-A12B-60 | LGN3-A22B-60 |
| GAS | LGN3-A11C-60 | LGN3-A21C-60 | LGN3-A12C-60 | LGN3-A22C-60 |
| NIT | LGN3-A11D-60 | LGN3-A21D-60 | LGN3-A12D-60 | LGN3-A22D-60 |
| HE | LGN3-A11F-60 | LGN3-A21F-60 | LGN3-A12F-60 | LGN3-A22F-60 |
| CO2 | LGN3-A11G-60 | LGN3-A21G-60 | LGN3-A12G-60 | LGN3-A22G-60 |
| CO | LGN3-A11H-60 | LGN3-A21H-60 | LGN3-A12H-60 | LGN3-A22H-60 |
| HYD | LGN3-A11I-60 | LGN3-A21I-60 | LGN3-A12I-60 | LGN3-A22I-60 |
| PRO | LGN3-A11J-60 | LGN3-A21J-60 | LGN3-A12J-60 | LGN3-A22J-60 |
| ACET | LGN3-A11K-60 | LGN3-A21K-60 | LGN3-A12K-60 | LGN3-A22K-60 |
| CH4 | LGN3-A11L-60 | LGN3-A21L-60 | LGN3-A12L-60 | LGN3-A22L-60 |
| SG | LGN3-A11M-60 | LGN3-A21M-60 | LGN3-A12M-60 | LGN3-A22M-60 |

Wall Mounted, “Y” Pattern Dual 90° Gas Needle Valve Assembly With Shank

- “Y” pattern wall flange with two valves at 90°
- Solid brass angle valve body
- Polished chrome plated finish
- 2-1/2” vandal proof cross handle
- 3/8” - 18 NPT male thread shank assembly



| Index Button | Metal Handle | | Plastic Handle | |
|--------------|-----------------|--------------|-----------------|---------------------|
| | Straight Nozzle | 30° Nozzle | Straight Nozzle | 30° Nozzle |
| AIR | LGN3-A11A-65 | LGN3-A21A-65 | LGN3-A12A-65 | LGN3-A22A-65 |
| VAC | LGN3-A11B-65 | LGN3-A21B-65 | LGN3-A12B-65 | LGN3-A22B-65 |
| GAS | LGN3-A11C-65 | LGN3-A21C-65 | LGN3-A12C-65 | LGN3-A22C-65 |
| NIT | LGN3-A11D-65 | LGN3-A21D-65 | LGN3-A12D-65 | LGN3-A22D-65 |
| HE | LGN3-A11F-65 | LGN3-A21F-65 | LGN3-A12F-65 | LGN3-A22F-65 |
| CO2 | LGN3-A11G-65 | LGN3-A21G-65 | LGN3-A12G-65 | LGN3-A22G-65 |
| CO | LGN3-A11H-65 | LGN3-A21H-65 | LGN3-A12H-65 | LGN3-A22H-65 |
| HYD | LGN3-A11I-65 | LGN3-A21I-65 | LGN3-A12I-65 | LGN3-A22I-65 |
| PRO | LGN3-A11J-65 | LGN3-A21J-65 | LGN3-A12J-65 | LGN3-A22J-65 |
| ACET | LGN3-A11K-65 | LGN3-A21K-65 | LGN3-A12K-65 | LGN3-A22K-65 |
| CH4 | LGN3-A11L-65 | LGN3-A21L-65 | LGN3-A12L-65 | LGN3-A22L-65 |
| SG | LGN3-A11M-65 | LGN3-A21M-65 | LGN3-A12M-65 | LGN3-A22M-65 |

How to build and order a Chicago Faucets laboratory fine control gas needle valve fitting.

Chicago Faucets makes it easy for you to build fine control gas needle valve fittings that meet your exact requirements. You can reference the charts on the following pages, or you can build your own valve by choosing the components below to configure your model number.

LGF A - B C D E - F
 (Lab Gas Fine Control)

Valve Base

A



Straight Valve



Angle Valve

Cartridge

B

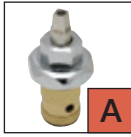

Compression

Outlet

C

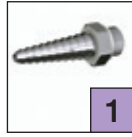

Straight Nozzle



30° Nozzle

EXAMPLE



LGF1-A21A-25

Straight valves with 30° outlets, metal lever handles with AIR index buttons, and single hole turret.

Handle

D



Metal

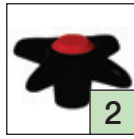

Plastic

Button

E

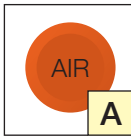

Air

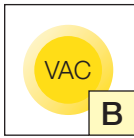

Vacuum

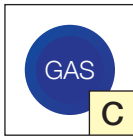

Gas

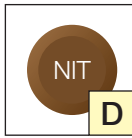

Nitrogen

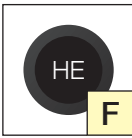

Helium

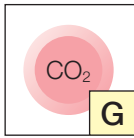

Carbon Dioxide

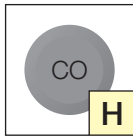

Carbon Monoxide

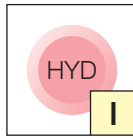

Hydrogen

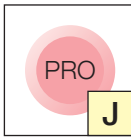

Propane

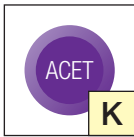

Acetylene

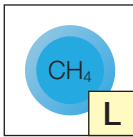

Methane

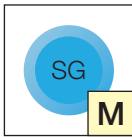

Specialty Gas

Turret

F



Single



Dual 90°



Dual 180°



Three Hole



Four Hole



Single Wall Flange

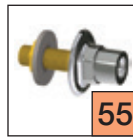

Single Wall Flange with Shank



Dual Wall Flange

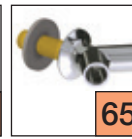

Dual Wall Flange with Shank

Straight Pattern Gas Fine Control Needle Valve

- Solid brass straight valve body
- Polished chrome plated finish
- 2-1/2" vandal proof cross handle
- 3/8" - 18 NPT male thread inlet



| Index Button | Metal Handle | | Plastic Handle | |
|--------------|------------------|------------|-----------------|------------|
| | Straight Nozzle | 30° Nozzle | Straight Nozzle | 30° Nozzle |
| AIR | LGF1-A11A | LGF1-A21A | LGF1-A12A | LGF1-A22A |
| VAC | LGF1-A11B | LGF1-A21B | LGF1-A12B | LGF1-A22B |
| GAS | LGF1-A11C | LGF1-A21C | LGF1-A12C | LGF1-A22C |
| NIT | LGF1-A11D | LGF1-A21D | LGF1-A12D | LGF1-A22D |
| HE | LGF1-A11F | LGF1-A21F | LGF1-A12F | LGF1-A22F |
| CO2 | LGF1-A11G | LGF1-A21G | LGF1-A12G | LGF1-A22G |
| CO | LGF1-A11H | LGF1-A21H | LGF1-A12H | LGF1-A22H |
| HYD | LGF1-A11I | LGF1-A21I | LGF1-A12I | LGF1-A22I |
| PRO | LGF1-A11J | LGF1-A21J | LGF1-A12J | LGF1-A22J |
| ACET | LGF1-A11K | LGF1-A21K | LGF1-A12K | LGF1-A22K |
| CH4 | LGF1-A11L | LGF1-A21L | LGF1-A12L | LGF1-A22L |
| SG | LGF1-A11M | LGF1-A21M | LGF1-A12M | LGF1-A22M |

Deck Mounted, Straight Pattern Single Gas Fine Control Needle Valve Assembly

- Solid brass turret with one outlet
- Solid brass straight valve body
- Polished chrome plated finish
- 2-1/2" vandal proof cross handle
- 3/8" - 18 NPT male thread shank assembly



| Index Button | Metal Handle | | Plastic Handle | |
|--------------|-----------------|--------------|-----------------|---------------------|
| | Straight Nozzle | 30° Nozzle | Straight Nozzle | 30° Nozzle |
| AIR | LGF1-A11A-10 | LGF1-A21A-10 | LGF1-A12A-10 | LGF1-A22A-10 |
| VAC | LGF1-A11B-10 | LGF1-A21B-10 | LGF1-A12B-10 | LGF1-A22B-10 |
| GAS | LGF1-A11C-10 | LGF1-A21C-10 | LGF1-A12C-10 | LGF1-A22C-10 |
| NIT | LGF1-A11D-10 | LGF1-A21D-10 | LGF1-A12D-10 | LGF1-A22D-10 |
| HE | LGF1-A11F-10 | LGF1-A21F-10 | LGF1-A12F-10 | LGF1-A22F-10 |
| CO2 | LGF1-A11G-10 | LGF1-A21G-10 | LGF1-A12G-10 | LGF1-A22G-10 |
| CO | LGF1-A11H-10 | LGF1-A21H-10 | LGF1-A12H-10 | LGF1-A22H-10 |
| HYD | LGF1-A11I-10 | LGF1-A21I-10 | LGF1-A12I-10 | LGF1-A22I-10 |
| PRO | LGF1-A11J-10 | LGF1-A21J-10 | LGF1-A12J-10 | LGF1-A22J-10 |
| ACET | LGF1-A11K-10 | LGF1-A21K-10 | LGF1-A12K-10 | LGF1-A22K-10 |
| CH4 | LGF1-A11L-10 | LGF1-A21L-10 | LGF1-A12L-10 | LGF1-A22L-10 |
| SG | LGF1-A11M-10 | LGF1-A21M-10 | LGF1-A12M-10 | LGF1-A22M-10 |

Deck Mounted, Straight Pattern Dual 90° Gas Fine Control Needle Valve Assembly

- Solid brass turret with two 90° outlets
- Solid brass straight valve body
- Polished chrome plated finish
- 2-1/2" vandal proof cross handle
- 3/8" - 18 NPT male thread shank assembly



| Index Button | Metal Handle | | Plastic Handle | |
|--------------|-----------------|---------------------|-----------------|--------------|
| | Straight Nozzle | 30° Nozzle | Straight Nozzle | 30° Nozzle |
| AIR | LGF1-A11A-20 | LGF1-A21A-20 | LGF1-A12A-20 | LGF1-A22A-20 |
| VAC | LGF1-A11B-20 | LGF1-A21B-20 | LGF1-A12B-20 | LGF1-A22B-20 |
| GAS | LGF1-A11C-20 | LGF1-A21C-20 | LGF1-A12C-20 | LGF1-A22C-20 |
| NIT | LGF1-A11D-20 | LGF1-A21D-20 | LGF1-A12D-20 | LGF1-A22D-20 |
| HE | LGF1-A11F-20 | LGF1-A21F-20 | LGF1-A12F-20 | LGF1-A22F-20 |
| CO2 | LGF1-A11G-20 | LGF1-A21G-20 | LGF1-A12G-20 | LGF1-A22G-20 |
| CO | LGF1-A11H-20 | LGF1-A21H-20 | LGF1-A12H-20 | LGF1-A22H-20 |
| HYD | LGF1-A11I-20 | LGF1-A21I-20 | LGF1-A12I-20 | LGF1-A22I-20 |
| PRO | LGF1-A11J-20 | LGF1-A21J-20 | LGF1-A12J-20 | LGF1-A22J-20 |
| ACET | LGF1-A11K-20 | LGF1-A21K-20 | LGF1-A12K-20 | LGF1-A22K-20 |
| CH4 | LGF1-A11L-20 | LGF1-A21L-20 | LGF1-A12L-20 | LGF1-A22L-20 |
| SG | LGF1-A11M-20 | LGF1-A21M-20 | LGF1-A12M-20 | LGF1-A22M-20 |

Deck Mounted, Straight Pattern Dual 180° Gas Fine Control Needle Valve Assembly

- Solid brass turret with two 180° outlets
- Solid brass straight valve body
- Polished chrome plated finish
- 2-1/2" vandal proof cross handle
- 3/8" - 18 NPT male thread shank assembly



| Index Button | Metal Handle | | Plastic Handle | |
|--------------|-----------------|--------------|---------------------|--------------|
| | Straight Nozzle | 30° Nozzle | Straight Nozzle | 30° Nozzle |
| AIR | LGF1-A11A-25 | LGF1-A21A-25 | LGF1-A12A-25 | LGF1-A22A-25 |
| VAC | LGF1-A11B-25 | LGF1-A21B-25 | LGF1-A12B-25 | LGF1-A22B-25 |
| GAS | LGF1-A11C-25 | LGF1-A21C-25 | LGF1-A12C-25 | LGF1-A22C-25 |
| NIT | LGF1-A11D-25 | LGF1-A21D-25 | LGF1-A12D-25 | LGF1-A22D-25 |
| HE | LGF1-A11F-25 | LGF1-A21F-25 | LGF1-A12F-25 | LGF1-A22F-25 |
| CO2 | LGF1-A11G-25 | LGF1-A21G-25 | LGF1-A12G-25 | LGF1-A22G-25 |
| CO | LGF1-A11H-25 | LGF1-A21H-25 | LGF1-A12H-25 | LGF1-A22H-25 |
| HYD | LGF1-A11I-25 | LGF1-A21I-25 | LGF1-A12I-25 | LGF1-A22I-25 |
| PRO | LGF1-A11J-25 | LGF1-A21J-25 | LGF1-A12J-25 | LGF1-A22J-25 |
| ACET | LGF1-A11K-25 | LGF1-A21K-25 | LGF1-A12K-25 | LGF1-A22K-25 |
| CH4 | LGF1-A11L-25 | LGF1-A21L-25 | LGF1-A12L-25 | LGF1-A22L-25 |
| SG | LGF1-A11M-25 | LGF1-A21M-25 | LGF1-A12M-25 | LGF1-A22M-25 |

Deck Mounted, Straight Pattern Three Gas Fine Control Needle Valve Assembly

- Solid brass turret with three outlets
- Solid brass straight valve body
- Polished chrome plated finish
- 2-1/2" vandal proof cross handle
- 3/8" - 18 NPT male thread shank assembly



| Index Button | Metal Handle | | Plastic Handle | |
|--------------|---------------------|--------------|-----------------|--------------|
| | Straight Nozzle | 30° Nozzle | Straight Nozzle | 30° Nozzle |
| AIR | LGF1-A11A-30 | LGF1-A21A-30 | LGF1-A12A-30 | LGF1-A22A-30 |
| VAC | LGF1-A11B-30 | LGF1-A21B-30 | LGF1-A12B-30 | LGF1-A22B-30 |
| GAS | LGF1-A11C-30 | LGF1-A21C-30 | LGF1-A12C-30 | LGF1-A22C-30 |
| NIT | LGF1-A11D-30 | LGF1-A21D-30 | LGF1-A12D-30 | LGF1-A22D-30 |
| HE | LGF1-A11F-30 | LGF1-A21F-30 | LGF1-A12F-30 | LGF1-A22F-30 |
| CO2 | LGF1-A11G-30 | LGF1-A21G-30 | LGF1-A12G-30 | LGF1-A22G-30 |
| CO | LGF1-A11H-30 | LGF1-A21H-30 | LGF1-A12H-30 | LGF1-A22H-30 |
| HYD | LGF1-A11I-30 | LGF1-A21I-30 | LGF1-A12I-30 | LGF1-A22I-30 |
| PRO | LGF1-A11J-30 | LGF1-A21J-30 | LGF1-A12J-30 | LGF1-A22J-30 |
| ACET | LGF1-A11K-30 | LGF1-A21K-30 | LGF1-A12K-30 | LGF1-A22K-30 |
| CH4 | LGF1-A11L-30 | LGF1-A21L-30 | LGF1-A12L-30 | LGF1-A22L-30 |
| SG | LGF1-A11M-30 | LGF1-A21M-30 | LGF1-A12M-30 | LGF1-A22M-30 |

Deck Mounted, Straight Pattern Four Gas Fine Control Needle Valve Assembly

- Solid brass turret with four outlets
- Solid brass straight valve body
- Polished chrome plated finish
- 2-1/2" vandal proof cross handle
- 3/8" - 18 NPT male thread shank assembly



| Index Button | Metal Handle | | Plastic Handle | |
|--------------|-----------------|--------------|-----------------|---------------------|
| | Straight Nozzle | 30° Nozzle | Straight Nozzle | 30° Nozzle |
| AIR | LGF1-A11A-40 | LGF1-A21A-40 | LGF1-A12A-40 | LGF1-A22A-40 |
| VAC | LGF1-A11B-40 | LGF1-A21B-40 | LGF1-A12B-40 | LGF1-A22B-40 |
| GAS | LGF1-A11C-40 | LGF1-A21C-40 | LGF1-A12C-40 | LGF1-A22C-40 |
| NIT | LGF1-A11D-40 | LGF1-A21D-40 | LGF1-A12D-40 | LGF1-A22D-40 |
| HE | LGF1-A11F-40 | LGF1-A21F-40 | LGF1-A12F-40 | LGF1-A22F-40 |
| CO2 | LGF1-A11G-40 | LGF1-A21G-40 | LGF1-A12G-40 | LGF1-A22G-40 |
| CO | LGF1-A11H-40 | LGF1-A21H-40 | LGF1-A12H-40 | LGF1-A22H-40 |
| HYD | LGF1-A11I-40 | LGF1-A21I-40 | LGF1-A12I-40 | LGF1-A22I-40 |
| PRO | LGF1-A11J-40 | LGF1-A21J-40 | LGF1-A12J-40 | LGF1-A22J-40 |
| ACET | LGF1-A11K-40 | LGF1-A21K-40 | LGF1-A12K-40 | LGF1-A22K-40 |
| CH4 | LGF1-A11L-40 | LGF1-A21L-40 | LGF1-A12L-40 | LGF1-A22L-40 |
| SG | LGF1-A11M-40 | LGF1-A21M-40 | LGF1-A12M-40 | LGF1-A22M-40 |

Wall Mounted, Straight Pattern Single Gas Fine Control Needle Valve Assembly Less Shank

- Wall flange
- Solid brass wall flange and straight valve body
- Polished chrome plated finish
- 2-1/2" vandal proof cross handle
- 3/8" - 18 NPT female thread inlet



| Index Button | Metal Handle | | Plastic Handle | |
|--------------|---------------------|--------------|-----------------|--------------|
| | Straight Nozzle | 30° Nozzle | Straight Nozzle | 30° Nozzle |
| AIR | LGF1-A11A-50 | LGF1-A21A-50 | LGF1-A12A-50 | LGF1-A22A-50 |
| VAC | LGF1-A11B-50 | LGF1-A21B-50 | LGF1-A12B-50 | LGF1-A22B-50 |
| GAS | LGF1-A11C-50 | LGF1-A21C-50 | LGF1-A12C-50 | LGF1-A22C-50 |
| NIT | LGF1-A11D-50 | LGF1-A21D-50 | LGF1-A12D-50 | LGF1-A22D-50 |
| HE | LGF1-A11F-50 | LGF1-A21F-50 | LGF1-A12F-50 | LGF1-A22F-50 |
| CO2 | LGF1-A11G-50 | LGF1-A21G-50 | LGF1-A12G-50 | LGF1-A22G-50 |
| CO | LGF1-A11H-50 | LGF1-A21H-50 | LGF1-A12H-50 | LGF1-A22H-50 |
| HYD | LGF1-A11I-50 | LGF1-A21I-50 | LGF1-A12I-50 | LGF1-A22I-50 |
| PRO | LGF1-A11J-50 | LGF1-A21J-50 | LGF1-A12J-50 | LGF1-A22J-50 |
| ACET | LGF1-A11K-50 | LGF1-A21K-50 | LGF1-A12K-50 | LGF1-A22K-50 |
| CH4 | LGF1-A11L-50 | LGF1-A21L-50 | LGF1-A12L-50 | LGF1-A22L-50 |
| SG | LGF1-A11M-50 | LGF1-A21M-50 | LGF1-A12M-50 | LGF1-A22M-50 |

Wall Mounted, Straight Pattern Single Gas Fine Control Needle Valve Assembly With Shank

- Wall flange
- Solid brass wall flange and straight valve body with shank
- Polished chrome plated finish
- 2-1/2" vandal proof cross handle
- 3/8" - 18 NPT male thread shank assembly



| Index Button | Metal Handle | | Plastic Handle | |
|--------------|-----------------|--------------|---------------------|--------------|
| | Straight Nozzle | 30° Nozzle | Straight Nozzle | 30° Nozzle |
| AIR | LGF1-A11A-55 | LGF1-A21A-55 | LGF1-A12A-55 | LGF1-A22A-55 |
| VAC | LGF1-A11B-55 | LGF1-A21B-55 | LGF1-A12B-55 | LGF1-A22B-55 |
| GAS | LGF1-A11C-55 | LGF1-A21C-55 | LGF1-A12C-55 | LGF1-A22C-55 |
| NIT | LGF1-A11D-55 | LGF1-A21D-55 | LGF1-A12D-55 | LGF1-A22D-55 |
| HE | LGF1-A11F-55 | LGF1-A21F-55 | LGF1-A12F-55 | LGF1-A22F-55 |
| CO2 | LGF1-A11G-55 | LGF1-A21G-55 | LGF1-A12G-55 | LGF1-A22G-55 |
| CO | LGF1-A11H-55 | LGF1-A21H-55 | LGF1-A12H-55 | LGF1-A22H-55 |
| HYD | LGF1-A11I-55 | LGF1-A21I-55 | LGF1-A12I-55 | LGF1-A22I-55 |
| PRO | LGF1-A11J-55 | LGF1-A21J-55 | LGF1-A12J-55 | LGF1-A22J-55 |
| ACET | LGF1-A11K-55 | LGF1-A21K-55 | LGF1-A12K-55 | LGF1-A22K-55 |
| CH4 | LGF1-A11L-55 | LGF1-A21L-55 | LGF1-A12L-55 | LGF1-A22L-55 |
| SG | LGF1-A11M-55 | LGF1-A21M-55 | LGF1-A12M-55 | LGF1-A22M-55 |

Wall Mounted, “Y” Pattern Dual 90° Gas Fine Control Needle Valve Assembly Less Shank

- “Y” pattern wall flange with two valves at 90°
- Polished chrome plated finish
- 2-1/2” vandal proof cross handle
- 3/8” - 18 NPT female thread inlet



| Index Button | Metal Handle | | Plastic Handle | |
|--------------|-----------------|---------------------|-----------------|--------------|
| | Straight Nozzle | 30° Nozzle | Straight Nozzle | 30° Nozzle |
| AIR | LGF1-A11A-60 | LGF1-A21A-60 | LGF1-A12A-60 | LGF1-A22A-60 |
| VAC | LGF1-A11B-60 | LGF1-A21B-60 | LGF1-A12B-60 | LGF1-A22B-60 |
| GAS | LGF1-A11C-60 | LGF1-A21C-60 | LGF1-A12C-60 | LGF1-A22C-60 |
| NIT | LGF1-A11D-60 | LGF1-A21D-60 | LGF1-A12D-60 | LGF1-A22D-60 |
| HE | LGF1-A11F-60 | LGF1-A21F-60 | LGF1-A12F-60 | LGF1-A22F-60 |
| CO2 | LGF1-A11G-60 | LGF1-A21G-60 | LGF1-A12G-60 | LGF1-A22G-60 |
| CO | LGF1-A11H-60 | LGF1-A21H-60 | LGF1-A12H-60 | LGF1-A22H-60 |
| HYD | LGF1-A11I-60 | LGF1-A21I-60 | LGF1-A12I-60 | LGF1-A22I-60 |
| PRO | LGF1-A11J-60 | LGF1-A21J-60 | LGF1-A12J-60 | LGF1-A22J-60 |
| ACET | LGF1-A11K-60 | LGF1-A21K-60 | LGF1-A12K-60 | LGF1-A22K-60 |
| CH4 | LGF1-A11L-60 | LGF1-A21L-60 | LGF1-A12L-60 | LGF1-A22L-60 |
| SG | LGF1-A11M-60 | LGF1-A21M-60 | LGF1-A12M-60 | LGF1-A22M-60 |

Wall Mounted, “Y” Pattern Dual 90° Gas Fine Control Needle Valve Assembly With Shank

- “Y” pattern wall flange with two valves at 90°
- Solid brass straight valve body
- Polished chrome plated finish
- 2-1/2” vandal proof cross handle
- 3/8” - 18 NPT male thread shank assembly



| Index Button | Metal Handle | | Plastic Handle | |
|--------------|---------------------|--------------|-----------------|--------------|
| | Straight Nozzle | 30° Nozzle | Straight Nozzle | 30° Nozzle |
| AIR | LGF1-A11A-65 | LGF1-A21A-65 | LGF1-A12A-65 | LGF1-A22A-65 |
| VAC | LGF1-A11B-65 | LGF1-A21B-65 | LGF1-A12B-65 | LGF1-A22B-65 |
| GAS | LGF1-A11C-65 | LGF1-A21C-65 | LGF1-A12C-65 | LGF1-A22C-65 |
| NIT | LGF1-A11D-65 | LGF1-A21D-65 | LGF1-A12D-65 | LGF1-A22D-65 |
| HE | LGF1-A11F-65 | LGF1-A21F-65 | LGF1-A12F-65 | LGF1-A22F-65 |
| CO2 | LGF1-A11G-65 | LGF1-A21G-65 | LGF1-A12G-65 | LGF1-A22G-65 |
| CO | LGF1-A11H-65 | LGF1-A21H-65 | LGF1-A12H-65 | LGF1-A22H-65 |
| HYD | LGF1-A11I-65 | LGF1-A21I-65 | LGF1-A12I-65 | LGF1-A22I-65 |
| PRO | LGF1-A11J-65 | LGF1-A21J-65 | LGF1-A12J-65 | LGF1-A22J-65 |
| ACET | LGF1-A11K-65 | LGF1-A21K-65 | LGF1-A12K-65 | LGF1-A22K-65 |
| CH4 | LGF1-A11L-65 | LGF1-A21L-65 | LGF1-A12L-65 | LGF1-A22L-65 |
| SG | LGF1-A11M-65 | LGF1-A21M-65 | LGF1-A12M-65 | LGF1-A22M-65 |

Angle Pattern Gas Fine Control Needle Valve

- Solid brass angle valve body
- Polished chrome plated finish
- 2-1/2" vandal proof cross handle
- 3/8" - 18 NPT female thread inlet



| Index Button | Metal Handle | | Plastic Handle | |
|--------------|-----------------|------------------|-----------------|------------|
| | Straight Nozzle | 30° Nozzle | Straight Nozzle | 30° Nozzle |
| AIR | LGF3-A11A | LGF3-A21A | LGF3-A12A | LGF3-A22A |
| VAC | LGF3-A11B | LGF3-A21B | LGF3-A12B | LGF3-A22B |
| GAS | LGF3-A11C | LGF3-A21C | LGF3-A12C | LGF3-A22C |
| NIT | LGF3-A11D | LGF3-A21D | LGF3-A12D | LGF3-A22D |
| HE | LGF3-A11F | LGF3-A21F | LGF3-A12F | LGF3-A22F |
| CO2 | LGF3-A11G | LGF3-A21G | LGF3-A12G | LGF3-A22G |
| CO | LGF3-A11H | LGF3-A21H | LGF3-A12H | LGF3-A22H |
| HYD | LGF3-A11I | LGF3-A21I | LGF3-A12I | LGF3-A22I |
| PRO | LGF3-A11J | LGF3-A21J | LGF3-A12J | LGF3-A22J |
| ACET | LGF3-A11K | LGF3-A21K | LGF3-A12K | LGF3-A22K |
| CH4 | LGF3-A11L | LGF3-A21L | LGF3-A12L | LGF3-A22L |
| SG | LGF3-A11M | LGF3-A21M | LGF3-A12M | LGF3-A22M |

Overhead Mounted, Angle Pattern Single Gas Fine Control Needle Valve Assembly

- Solid brass turret with one outlet
- Solid brass angle valve body
- Polished chrome plated finish
- 2-1/2" vandal proof cross handle
- 3/8" - 18 NPT male thread shank assembly



| Index Button | Metal Handle | | Plastic Handle | |
|--------------|-----------------|--------------|-----------------|---------------------|
| | Straight Nozzle | 30° Nozzle | Straight Nozzle | 30° Nozzle |
| AIR | LGF3-A11A-10 | LGF3-A21A-10 | LGF3-A12A-10 | LGF3-A22A-10 |
| VAC | LGF3-A11B-10 | LGF3-A21B-10 | LGF3-A12B-10 | LGF3-A22B-10 |
| GAS | LGF3-A11C-10 | LGF3-A21C-10 | LGF3-A12C-10 | LGF3-A22C-10 |
| NIT | LGF3-A11D-10 | LGF3-A21D-10 | LGF3-A12D-10 | LGF3-A22D-10 |
| HE | LGF3-A11F-10 | LGF3-A21F-10 | LGF3-A12F-10 | LGF3-A22F-10 |
| CO2 | LGF3-A11G-10 | LGF3-A21G-10 | LGF3-A12G-10 | LGF3-A22G-10 |
| CO | LGF3-A11H-10 | LGF3-A21H-10 | LGF3-A12H-10 | LGF3-A22H-10 |
| HYD | LGF3-A11I-10 | LGF3-A21I-10 | LGF3-A12I-10 | LGF3-A22I-10 |
| PRO | LGF3-A11J-10 | LGF3-A21J-10 | LGF3-A12J-10 | LGF3-A22J-10 |
| ACET | LGF3-A11K-10 | LGF3-A21K-10 | LGF3-A12K-10 | LGF3-A22K-10 |
| CH4 | LGF3-A11L-10 | LGF3-A21L-10 | LGF3-A12L-10 | LGF3-A22L-10 |
| SG | LGF3-A11M-10 | LGF3-A21M-10 | LGF3-A12M-10 | LGF3-A22M-10 |

Overhead Mounted, Angle Pattern Dual 90° Gas Fine Control Needle Valve Assembly

- Solid brass turret with two 90° outlets
- Solid brass angle valve body
- Polished chrome plated finish
- 2-1/2" vandal proof cross handle
- 3/8" - 18 NPT male thread shank assembly



| Index Button | Metal Handle | | Plastic Handle | |
|--------------|---------------------|--------------|-----------------|--------------|
| | Straight Nozzle | 30° Nozzle | Straight Nozzle | 30° Nozzle |
| AIR | LGF3-A11A-20 | LGF3-A21A-20 | LGF3-A12A-20 | LGF3-A22A-20 |
| VAC | LGF3-A11B-20 | LGF3-A21B-20 | LGF3-A12B-20 | LGF3-A22B-20 |
| GAS | LGF3-A11C-20 | LGF3-A21C-20 | LGF3-A12C-20 | LGF3-A22C-20 |
| NIT | LGF3-A11D-20 | LGF3-A21D-20 | LGF3-A12D-20 | LGF3-A22D-20 |
| HE | LGF3-A11F-20 | LGF3-A21F-20 | LGF3-A12F-20 | LGF3-A22F-20 |
| CO2 | LGF3-A11G-20 | LGF3-A21G-20 | LGF3-A12G-20 | LGF3-A22G-20 |
| CO | LGF3-A11H-20 | LGF3-A21H-20 | LGF3-A12H-20 | LGF3-A22H-20 |
| HYD | LGF3-A11I-20 | LGF3-A21I-20 | LGF3-A12I-20 | LGF3-A22I-20 |
| PRO | LGF3-A11J-20 | LGF3-A21J-20 | LGF3-A12J-20 | LGF3-A22J-20 |
| ACET | LGF3-A11K-20 | LGF3-A21K-20 | LGF3-A12K-20 | LGF3-A22K-20 |
| CH4 | LGF3-A11L-20 | LGF3-A21L-20 | LGF3-A12L-20 | LGF3-A22L-20 |
| SG | LGF3-A11M-20 | LGF3-A21M-20 | LGF3-A12M-20 | LGF3-A22M-20 |

Overhead Mounted, Angle Pattern Dual 180° Gas Fine Control Needle Valve Assembly

- Solid brass turret with two 180° outlets
- Solid brass angle valve body
- Polished chrome plated finish
- 2-1/2" vandal proof cross handle
- 3/8" - 18 NPT male thread shank assembly

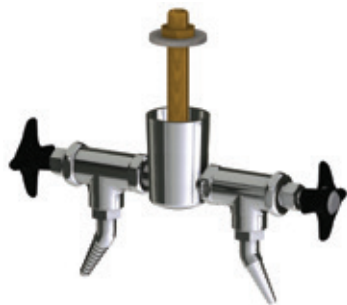

| Index Button | Metal Handle | | Plastic Handle | |
|--------------|-----------------|--------------|-----------------|---------------------|
| | Straight Nozzle | 30° Nozzle | Straight Nozzle | 30° Nozzle |
| AIR | LGF3-A11A-25 | LGF3-A21A-25 | LGF3-A12A-25 | LGF3-A22A-25 |
| VAC | LGF3-A11B-25 | LGF3-A21B-25 | LGF3-A12B-25 | LGF3-A22B-25 |
| GAS | LGF3-A11C-25 | LGF3-A21C-25 | LGF3-A12C-25 | LGF3-A22C-25 |
| NIT | LGF3-A11D-25 | LGF3-A21D-25 | LGF3-A12D-25 | LGF3-A22D-25 |
| HE | LGF3-A11F-25 | LGF3-A21F-25 | LGF3-A12F-25 | LGF3-A22F-25 |
| CO2 | LGF3-A11G-25 | LGF3-A21G-25 | LGF3-A12G-25 | LGF3-A22G-25 |
| CO | LGF3-A11H-25 | LGF3-A21H-25 | LGF3-A12H-25 | LGF3-A22H-25 |
| HYD | LGF3-A11I-25 | LGF3-A21I-25 | LGF3-A12I-25 | LGF3-A22I-25 |
| PRO | LGF3-A11J-25 | LGF3-A21J-25 | LGF3-A12J-25 | LGF3-A22J-25 |
| ACET | LGF3-A11K-25 | LGF3-A21K-25 | LGF3-A12K-25 | LGF3-A22K-25 |
| CH4 | LGF3-A11L-25 | LGF3-A21L-25 | LGF3-A12L-25 | LGF3-A22L-25 |
| SG | LGF3-A11M-25 | LGF3-A21M-25 | LGF3-A12M-25 | LGF3-A22M-25 |

Overhead Mounted, Angle Pattern Three Gas Fine Control Needle Valve Assembly

- Solid brass turret with three outlets
- Solid brass angle valve body
- Polished chrome plated finish
- 2-1/2" vandal proof cross handle
- 3/8" - 18 NPT male thread shank assembly

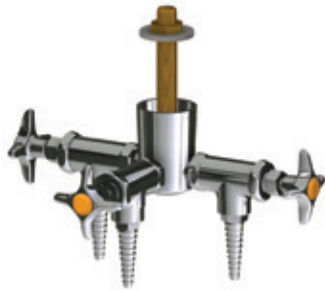

| Index Button | Metal Handle | | Plastic Handle | |
|--------------|---------------------|--------------|-----------------|--------------|
| | Straight Nozzle | 30° Nozzle | Straight Nozzle | 30° Nozzle |
| AIR | LGF3-A11A-30 | LGF3-A21A-30 | LGF3-A12A-30 | LGF3-A22A-30 |
| VAC | LGF3-A11B-30 | LGF3-A21B-30 | LGF3-A12B-30 | LGF3-A22B-30 |
| GAS | LGF3-A11C-30 | LGF3-A21C-30 | LGF3-A12C-30 | LGF3-A22C-30 |
| NIT | LGF3-A11D-30 | LGF3-A21D-30 | LGF3-A12D-30 | LGF3-A22D-30 |
| HE | LGF3-A11F-30 | LGF3-A21F-30 | LGF3-A12F-30 | LGF3-A22F-30 |
| CO2 | LGF3-A11G-30 | LGF3-A21G-30 | LGF3-A12G-30 | LGF3-A22G-30 |
| CO | LGF3-A11H-30 | LGF3-A21H-30 | LGF3-A12H-30 | LGF3-A22H-30 |
| HYD | LGF3-A11I-30 | LGF3-A21I-30 | LGF3-A12I-30 | LGF3-A22I-30 |
| PRO | LGF3-A11J-30 | LGF3-A21J-30 | LGF3-A12J-30 | LGF3-A22J-30 |
| ACET | LGF3-A11K-30 | LGF3-A21K-30 | LGF3-A12K-30 | LGF3-A22K-30 |
| CH4 | LGF3-A11L-30 | LGF3-A21L-30 | LGF3-A12L-30 | LGF3-A22L-30 |
| SG | LGF3-A11M-30 | LGF3-A21M-30 | LGF3-A12M-30 | LGF3-A22M-30 |

Overhead Mounted, Angle Pattern Four Gas Fine Control Needle Valve Assembly

- Solid brass turret with four outlets
- Solid brass angle valve body
- Polished chrome plated finish
- 2-1/2" vandal proof cross handle
- 3/8" - 18 NPT male thread shank assembly

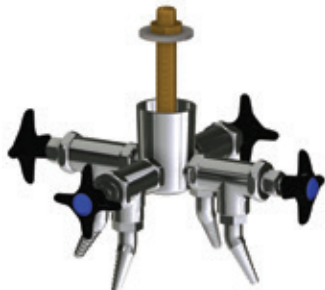

| Index Button | Metal Handle | | Plastic Handle | |
|--------------|-----------------|--------------|-----------------|---------------------|
| | Straight Nozzle | 30° Nozzle | Straight Nozzle | 30° Nozzle |
| AIR | LGF3-A11A-40 | LGF3-A21A-40 | LGF3-A12A-40 | LGF3-A22A-40 |
| VAC | LGF3-A11B-40 | LGF3-A21B-40 | LGF3-A12B-40 | LGF3-A22B-40 |
| GAS | LGF3-A11C-40 | LGF3-A21C-40 | LGF3-A12C-40 | LGF3-A22C-40 |
| NIT | LGF3-A11D-40 | LGF3-A21D-40 | LGF3-A12D-40 | LGF3-A22D-40 |
| HE | LGF3-A11F-40 | LGF3-A21F-40 | LGF3-A12F-40 | LGF3-A22F-40 |
| CO2 | LGF3-A11G-40 | LGF3-A21G-40 | LGF3-A12G-40 | LGF3-A22G-40 |
| CO | LGF3-A11H-40 | LGF3-A21H-40 | LGF3-A12H-40 | LGF3-A22H-40 |
| HYD | LGF3-A11I-40 | LGF3-A21I-40 | LGF3-A12I-40 | LGF3-A22I-40 |
| PRO | LGF3-A11J-40 | LGF3-A21J-40 | LGF3-A12J-40 | LGF3-A22J-40 |
| ACET | LGF3-A11K-40 | LGF3-A21K-40 | LGF3-A12K-40 | LGF3-A22K-40 |
| CH4 | LGF3-A11L-40 | LGF3-A21L-40 | LGF3-A12L-40 | LGF3-A22L-40 |
| SG | LGF3-A11M-40 | LGF3-A21M-40 | LGF3-A12M-40 | LGF3-A22M-40 |

Wall Mounted, Straight Pattern Single Gas Fine Control Needle Valve Assembly Less Shank

- Wall flange
- Solid brass angle valve body
- Polished chrome plated finish
- 2-1/2" vandal proof cross handle
- 3/8" - 18 NPT female thread inlet



| Index Button | Metal Handle | | Plastic Handle | |
|--------------|---------------------|--------------|-----------------|--------------|
| | Straight Nozzle | 30° Nozzle | Straight Nozzle | 30° Nozzle |
| AIR | LGF3-A11A-50 | LGF3-A21A-50 | LGF3-A12A-50 | LGF3-A22A-50 |
| VAC | LGF3-A11B-50 | LGF3-A21B-50 | LGF3-A12B-50 | LGF3-A22B-50 |
| GAS | LGF3-A11C-50 | LGF3-A21C-50 | LGF3-A12C-50 | LGF3-A22C-50 |
| NIT | LGF3-A11D-50 | LGF3-A21D-50 | LGF3-A12D-50 | LGF3-A22D-50 |
| HE | LGF3-A11F-50 | LGF3-A21F-50 | LGF3-A12F-50 | LGF3-A22F-50 |
| CO2 | LGF3-A11G-50 | LGF3-A21G-50 | LGF3-A12G-50 | LGF3-A22G-50 |
| CO | LGF3-A11H-50 | LGF3-A21H-50 | LGF3-A12H-50 | LGF3-A22H-50 |
| HYD | LGF3-A11I-50 | LGF3-A21I-50 | LGF3-A12I-50 | LGF3-A22I-50 |
| PRO | LGF3-A11J-50 | LGF3-A21J-50 | LGF3-A12J-50 | LGF3-A22J-50 |
| ACET | LGF3-A11K-50 | LGF3-A21K-50 | LGF3-A12K-50 | LGF3-A22K-50 |
| CH4 | LGF3-A11L-50 | LGF3-A21L-50 | LGF3-A12L-50 | LGF3-A22L-50 |
| SG | LGF3-A11M-50 | LGF3-A21M-50 | LGF3-A12M-50 | LGF3-A22M-50 |

Wall Mounted, Straight Pattern Single Gas Fine Control Needle Valve Assembly With Shank

- Wall flange
- Solid brass angle valve body
- Polished chrome plated finish
- 2-1/2" vandal proof cross handle
- 3/8" - 18 NPT male thread shank assembly



| Index Button | Metal Handle | | Plastic Handle | |
|--------------|-----------------|--------------|---------------------|--------------|
| | Straight Nozzle | 30° Nozzle | Straight Nozzle | 30° Nozzle |
| AIR | LGF3-A11A-55 | LGF3-A21A-55 | LGF3-A12A-55 | LGF3-A22A-55 |
| VAC | LGF3-A11B-55 | LGF3-A21B-55 | LGF3-A12B-55 | LGF3-A22B-55 |
| GAS | LGF3-A11C-55 | LGF3-A21C-55 | LGF3-A12C-55 | LGF3-A22C-55 |
| NIT | LGF3-A11D-55 | LGF3-A21D-55 | LGF3-A12D-55 | LGF3-A22D-55 |
| HE | LGF3-A11F-55 | LGF3-A21F-55 | LGF3-A12F-55 | LGF3-A22F-55 |
| CO2 | LGF3-A11G-55 | LGF3-A21G-55 | LGF3-A12G-55 | LGF3-A22G-55 |
| CO | LGF3-A11H-55 | LGF3-A21H-55 | LGF3-A12H-55 | LGF3-A22H-55 |
| HYD | LGF3-A11I-55 | LGF3-A21I-55 | LGF3-A12I-55 | LGF3-A22I-55 |
| PRO | LGF3-A11J-55 | LGF3-A21J-55 | LGF3-A12J-55 | LGF3-A22J-55 |
| ACET | LGF3-A11K-55 | LGF3-A21K-55 | LGF3-A12K-55 | LGF3-A22K-55 |
| CH4 | LGF3-A11L-55 | LGF3-A21L-55 | LGF3-A12L-55 | LGF3-A22L-55 |
| SG | LGF3-A11M-55 | LGF3-A21M-55 | LGF3-A12M-55 | LGF3-A22M-55 |

Wall Mounted, “Y” Pattern Dual 90° Gas Fine Control Needle Valve Assembly Less Shank

- “Y” pattern wall flange with two valves at 90°
- Solid brass angle valve body
- Polished chrome plated finish
- 2-1/2” vandal proof cross handle
- 3/8” - 18 NPT female thread inlet



| Index Button | Metal Handle | | Plastic Handle | |
|--------------|-----------------|---------------------|-----------------|--------------|
| | Straight Nozzle | 30° Nozzle | Straight Nozzle | 30° Nozzle |
| AIR | LGF3-A11A-60 | LGF3-A21A-60 | LGF3-A12A-60 | LGF3-A22A-60 |
| VAC | LGF3-A11B-60 | LGF3-A21B-60 | LGF3-A12B-60 | LGF3-A22B-60 |
| GAS | LGF3-A11C-60 | LGF3-A21C-60 | LGF3-A12C-60 | LGF3-A22C-60 |
| NIT | LGF3-A11D-60 | LGF3-A21D-60 | LGF3-A12D-60 | LGF3-A22D-60 |
| HE | LGF3-A11F-60 | LGF3-A21F-60 | LGF3-A12F-60 | LGF3-A22F-60 |
| CO2 | LGF3-A11G-60 | LGF3-A21G-60 | LGF3-A12G-60 | LGF3-A22G-60 |
| CO | LGF3-A11H-60 | LGF3-A21H-60 | LGF3-A12H-60 | LGF3-A22H-60 |
| HYD | LGF3-A11I-60 | LGF3-A21I-60 | LGF3-A12I-60 | LGF3-A22I-60 |
| PRO | LGF3-A11J-60 | LGF3-A21J-60 | LGF3-A12J-60 | LGF3-A22J-60 |
| ACET | LGF3-A11K-60 | LGF3-A21K-60 | LGF3-A12K-60 | LGF3-A22K-60 |
| CH4 | LGF3-A11L-60 | LGF3-A21L-60 | LGF3-A12L-60 | LGF3-A22L-60 |
| SG | LGF3-A11M-60 | LGF3-A21M-60 | LGF3-A12M-60 | LGF3-A22M-60 |

Wall Mounted, “Y” Pattern Dual 90° Gas Fine Control Needle Valve Assembly With Shank

- “Y” pattern wall flange with two valves at 90°
- Solid brass angle valve body
- Polished chrome plated finish
- 2-1/2” vandal proof cross handle
- 3/8” - 18 NPT male thread shank assembly



| Index Button | Metal Handle | | Plastic Handle | |
|--------------|-----------------|--------------|-----------------|---------------------|
| | Straight Nozzle | 30° Nozzle | Straight Nozzle | 30° Nozzle |
| AIR | LGF3-A11A-65 | LGF3-A21A-65 | LGF3-A12A-65 | LGF3-A22A-65 |
| VAC | LGF3-A11B-65 | LGF3-A21B-65 | LGF3-A12B-65 | LGF3-A22B-65 |
| GAS | LGF3-A11C-65 | LGF3-A21C-65 | LGF3-A12C-65 | LGF3-A22C-65 |
| NIT | LGF3-A11D-65 | LGF3-A21D-65 | LGF3-A12D-65 | LGF3-A22D-65 |
| HE | LGF3-A11F-65 | LGF3-A21F-65 | LGF3-A12F-65 | LGF3-A22F-65 |
| CO2 | LGF3-A11G-65 | LGF3-A21G-65 | LGF3-A12G-65 | LGF3-A22G-65 |
| CO | LGF3-A11H-65 | LGF3-A21H-65 | LGF3-A12H-65 | LGF3-A22H-65 |
| HYD | LGF3-A11I-65 | LGF3-A21I-65 | LGF3-A12I-65 | LGF3-A22I-65 |
| PRO | LGF3-A11J-65 | LGF3-A21J-65 | LGF3-A12J-65 | LGF3-A22J-65 |
| ACET | LGF3-A11K-65 | LGF3-A21K-65 | LGF3-A12K-65 | LGF3-A22K-65 |
| CH4 | LGF3-A11L-65 | LGF3-A21L-65 | LGF3-A12L-65 | LGF3-A22L-65 |
| SG | LGF3-A11M-65 | LGF3-A21M-65 | LGF3-A12M-65 | LGF3-A22M-65 |

How to build and order a Chicago Faucets laboratory gas ball valve fitting.

Chicago Faucets makes it easy for you to build gas ball valve fittings that meet your exact requirements. You can reference the charts on the following pages, or you can build your own valve by choosing the components below to configure your model number.

LGB A-B-C-D-E

(Lab Gas Ball Valve)

Valve Base

A

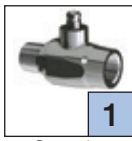

1
Straight Valve

Outlet

B



1
Straight Nozzle



2
30° Nozzle



3
Straight Nozzle w/ check valve

Handle

C



1
Metal Lever

Button

D

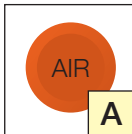

A
Air

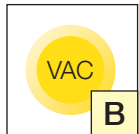

B
Vacuum

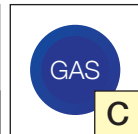

C
Gas

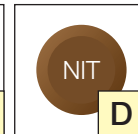

D
Nitrogen



F
Helium

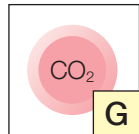

G
Carbon Dioxide

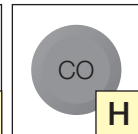

H
Carbon Monoxide

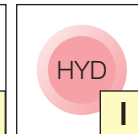

I
Hydrogen

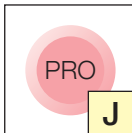

J
Propane

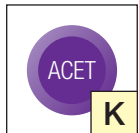

K
Acetylene

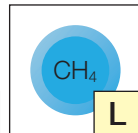

L
Methane

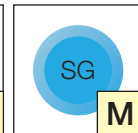

M
Specialty Gas

Turret

E



10
Single



20
Dual 90°



25
Dual 180°



30
Three Hole



40
Four Hole



50
Single Wall Flange



55
Single Wall Flange with Shank



60
Dual Wall Flange

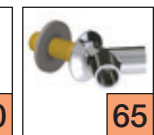

65
Dual Wall Flange with Shank

EXAMPLE



LGB1-21A-10

Straight valve with a 30° nozzle, metal lever handle with AIR index button, and single hole turret.

Straight Pattern Gas Ball Valve

- Solid brass straight valve body
- Polished chrome plated finish
- Metal lever handle with index button
- 3/8" - 18 NPT male thread inlet



| Index Button | Straight Nozzle | 30° Nozzle | Straight Nozzle w/ Check Valve |
|--------------|-----------------|------------|--------------------------------|
| AIR | LGB1-11A | LGB1-21A | LGB1-31A |
| VAC | LGB1-11B | LGB1-21B | - |
| GAS | LGB1-11C | LGB1-21C | LGB1-31C |
| NIT | LGB1-11D | LGB1-21D | LGB1-31D |
| HE | LGB1-11F | LGB1-21F | LGB1-31F |
| CO2 | LGB1-11G | LGB1-21G | LGB1-31G |
| CO | LGB1-11H | LGB1-21H | LGB1-31H |
| HYD | LGB1-11I | LGB1-21I | LGB1-31I |
| PRO | LGB1-11J | LGB1-21J | LGB1-31J |
| ACET | LGB1-11K | LGB1-21K | LGB1-31K |
| CH4 | LGB1-11L | LGB1-21L | LGB1-31L |
| SG | LGB1-11M | LGB1-21M | LGB1-31M |

Deck Mounted, Straight Pattern Single Gas Ball Valve Assembly

- Solid brass turret with one outlet
- Solid brass straight valve body
- Polished chrome plated finish
- Metal lever handle with index button
- 3/8" - 18 NPT male thread shank assembly



| Index Button | Straight Nozzle | 30° Nozzle | Straight Nozzle w/ Check Valve |
|--------------|--------------------|-------------|--------------------------------|
| AIR | LGB1-11A-10 | LGB1-21A-10 | LGB1-31A-10 |
| VAC | LGB1-11B-10 | LGB1-21B-10 | - |
| GAS | LGB1-11C-10 | LGB1-21C-10 | LGB1-31C-10 |
| NIT | LGB1-11D-10 | LGB1-21D-10 | LGB1-31D-10 |
| HE | LGB1-11F-10 | LGB1-21F-10 | LGB1-31F-10 |
| CO2 | LGB1-11G-10 | LGB1-21G-10 | LGB1-31G-10 |
| CO | LGB1-11H-10 | LGB1-21H-10 | LGB1-31H-10 |
| HYD | LGB1-11I-10 | LGB1-21I-10 | LGB1-31I-10 |
| PRO | LGB1-11J-10 | LGB1-21J-10 | LGB1-31J-10 |
| ACET | LGB1-11K-10 | LGB1-21K-10 | LGB1-31K-10 |
| CH4 | LGB1-11L-10 | LGB1-21L-10 | LGB1-31L-10 |
| SG | LGB1-11M-10 | LGB1-21M-10 | LGB1-31M-10 |

Deck Mounted, Straight Pattern Dual 90° Gas Ball Valve Assembly

- Solid brass turret with two 90° outlets
- Solid brass straight valve body
- Polished chrome plated finish
- Metal lever handle with index button
- 3/8" - 18 NPT male thread shank assembly



| Index Button | Straight Nozzle | 30° Nozzle | Straight Nozzle w/ Check Valve |
|--------------|--------------------|-------------|--------------------------------|
| AIR | LGB1-11A-20 | LGB1-21A-20 | LGB1-31A-20 |
| VAC | LGB1-11B-20 | LGB1-21B-20 | - |
| GAS | LGB1-11C-20 | LGB1-21C-20 | LGB1-31C-20 |
| NIT | LGB1-11D-20 | LGB1-21D-20 | LGB1-31D-20 |
| HE | LGB1-11F-20 | LGB1-21F-20 | LGB1-31F-20 |
| CO2 | LGB1-11G-20 | LGB1-21G-20 | LGB1-31G-20 |
| CO | LGB1-11H-20 | LGB1-21H-20 | LGB1-31H-20 |
| HYD | LGB1-11I-20 | LGB1-21I-20 | LGB1-31I-20 |
| PRO | LGB1-11J-20 | LGB1-21J-20 | LGB1-31J-20 |
| ACET | LGB1-11K-20 | LGB1-21K-20 | LGB1-31K-20 |
| CH4 | LGB1-11L-20 | LGB1-21L-20 | LGB1-31L-20 |
| SG | LGB1-11M-20 | LGB1-21M-20 | LGB1-31M-20 |

Deck Mounted, Straight Pattern Dual 180° Gas Ball Valve Assembly

- Solid brass turret with two 180° outlets
- Solid brass straight valve body
- Polished chrome plated finish
- Metal lever handle with index button
- 3/8" - 18 NPT male thread shank assembly



| Index Button | Straight Nozzle | 30° Nozzle | Straight Nozzle w/ Check Valve |
|--------------|--------------------|-------------|--------------------------------|
| AIR | LGB1-11A-25 | LGB1-21A-25 | LGB1-31A-25 |
| VAC | LGB1-11B-25 | LGB1-21B-25 | - |
| GAS | LGB1-11C-25 | LGB1-21C-25 | LGB1-31C-25 |
| NIT | LGB1-11D-25 | LGB1-21D-25 | LGB1-31D-25 |
| HE | LGB1-11F-25 | LGB1-21F-25 | LGB1-31F-25 |
| CO2 | LGB1-11G-25 | LGB1-21G-25 | LGB1-31G-25 |
| CO | LGB1-11H-25 | LGB1-21H-25 | LGB1-31H-25 |
| HYD | LGB1-11I-25 | LGB1-21I-25 | LGB1-31I-25 |
| PRO | LGB1-11J-25 | LGB1-21J-25 | LGB1-31J-25 |
| ACET | LGB1-11K-25 | LGB1-21K-25 | LGB1-31K-25 |
| CH4 | LGB1-11L-25 | LGB1-21L-25 | LGB1-31L-25 |
| SG | LGB1-11M-25 | LGB1-21M-25 | LGB1-31M-25 |

Deck Mounted, Straight Pattern Three Gas Ball Valve Assembly

- Solid brass turret with three outlets
- Solid brass straight valve body
- Polished chrome plated finish
- Metal lever handle with index button
- 3/8" - 18 NPT male thread shank assembly



| Index Button | Straight Nozzle | 30° Nozzle | Straight Nozzle w/ Check Valve |
|--------------|--------------------|-------------|--------------------------------|
| AIR | LGB1-11A-30 | LGB1-21A-30 | LGB1-31A-30 |
| VAC | LGB1-11B-30 | LGB1-21B-30 | – |
| GAS | LGB1-11C-30 | LGB1-21C-30 | LGB1-31C-30 |
| NIT | LGB1-11D-30 | LGB1-21D-30 | LGB1-31D-30 |
| HE | LGB1-11F-30 | LGB1-21F-30 | LGB1-31F-30 |
| CO2 | LGB1-11G-30 | LGB1-21G-30 | LGB1-31G-30 |
| CO | LGB1-11H-30 | LGB1-21H-30 | LGB1-31H-30 |
| HYD | LGB1-11I-30 | LGB1-21I-30 | LGB1-31I-30 |
| PRO | LGB1-11J-30 | LGB1-21J-30 | LGB1-31J-30 |
| ACET | LGB1-11K-30 | LGB1-21K-30 | LGB1-31K-30 |
| CH4 | LGB1-11L-30 | LGB1-21L-30 | LGB1-31L-30 |
| SG | LGB1-11M-30 | LGB1-21M-30 | LGB1-31M-30 |

Deck Mounted, Straight Pattern Four Gas Ball Valve Assembly

- Solid brass turret with four outlets
- Solid brass straight valve body
- Polished chrome plated finish
- Metal lever handle with index button
- 3/8" - 18 NPT male thread shank assembly



| Index Button | Straight Nozzle | 30° Nozzle | Straight Nozzle w/ Check Valve |
|--------------|--------------------|-------------|--------------------------------|
| AIR | LGB1-11A-40 | LGB1-21A-40 | LGB1-31A-40 |
| VAC | LGB1-11B-40 | LGB1-21B-40 | – |
| GAS | LGB1-11C-40 | LGB1-21C-40 | LGB1-31C-40 |
| NIT | LGB1-11D-40 | LGB1-21D-40 | LGB1-31D-40 |
| HE | LGB1-11F-40 | LGB1-21F-40 | LGB1-31F-40 |
| CO2 | LGB1-11G-40 | LGB1-21G-40 | LGB1-31G-40 |
| CO | LGB1-11H-40 | LGB1-21H-40 | LGB1-31H-40 |
| HYD | LGB1-11I-40 | LGB1-21I-40 | LGB1-31I-40 |
| PRO | LGB1-11J-40 | LGB1-21J-40 | LGB1-31J-40 |
| ACET | LGB1-11K-40 | LGB1-21K-40 | LGB1-31K-40 |
| CH4 | LGB1-11L-40 | LGB1-21L-40 | LGB1-31L-40 |
| SG | LGB1-11M-40 | LGB1-21M-40 | LGB1-31M-40 |

Wall Mounted, Straight Pattern Single Gas Ball Valve Assembly Less Shank

- Solid brass straight valve body
- Polished chrome plated finish
- Metal lever handle with index button
- 3/8" - 18 NPT female thread inlet
- Integral wall flange



| Index Button | Straight Nozzle | 30° Nozzle | Straight Nozzle w/ Check Valve |
|--------------|--------------------|-------------|--------------------------------|
| AIR | LGB1-11A-50 | LGB1-21A-50 | LGB1-31A-50 |
| VAC | LGB1-11B-50 | LGB1-21B-50 | - |
| GAS | LGB1-11C-50 | LGB1-21C-50 | LGB1-31C-50 |
| NIT | LGB1-11D-50 | LGB1-21D-50 | LGB1-31D-50 |
| HE | LGB1-11F-50 | LGB1-21F-50 | LGB1-31F-50 |
| CO2 | LGB1-11G-50 | LGB1-21G-50 | LGB1-31G-50 |
| CO | LGB1-11H-50 | LGB1-21H-50 | LGB1-31H-50 |
| HYD | LGB1-11I-50 | LGB1-21I-50 | LGB1-31I-50 |
| PRO | LGB1-11J-50 | LGB1-21J-50 | LGB1-31J-50 |
| ACET | LGB1-11K-50 | LGB1-21K-50 | LGB1-31K-50 |
| CH4 | LGB1-11L-50 | LGB1-21L-50 | LGB1-31L-50 |
| SG | LGB1-11M-50 | LGB1-21M-50 | LGB1-31M-50 |

Wall Mounted, Straight Pattern Single Gas Ball Valve Assembly With Shank

- Solid brass straight valve body
- Polished chrome plated finish
- Metal lever handle with index button
- 3/8" - 18 NPT male thread shank assembly
- Integral wall flange



| Index Button | Straight Nozzle | 30° Nozzle | Straight Nozzle w/ Check Valve |
|--------------|--------------------|-------------|--------------------------------|
| AIR | LGB1-11A-55 | LGB1-21A-55 | LGB1-31A-55 |
| VAC | LGB1-11B-55 | LGB1-21B-55 | - |
| GAS | LGB1-11C-55 | LGB1-21C-55 | LGB1-31C-55 |
| NIT | LGB1-11D-55 | LGB1-21D-55 | LGB1-31D-55 |
| HE | LGB1-11F-55 | LGB1-21F-55 | LGB1-31F-55 |
| CO2 | LGB1-11G-55 | LGB1-21G-55 | LGB1-31G-55 |
| CO | LGB1-11H-55 | LGB1-21H-55 | LGB1-31H-55 |
| HYD | LGB1-11I-55 | LGB1-21I-55 | LGB1-31I-55 |
| PRO | LGB1-11J-55 | LGB1-21J-55 | LGB1-31J-55 |
| ACET | LGB1-11K-55 | LGB1-21K-55 | LGB1-31K-55 |
| CH4 | LGB1-11L-55 | LGB1-21L-55 | LGB1-31L-55 |
| SG | LGB1-11M-55 | LGB1-21M-55 | LGB1-31M-55 |

Wall Mounted, “Y” Pattern Dual 90° Gas Ball Valve Assembly Less Shank

- “Y” pattern wall flange with two ball valves at 90°
- Solid brass straight valve body
- Polished chrome plated finish
- Metal lever handle with index button
- 3/8” - 18 NPT female thread inlet



| Index Button | Straight Nozzle | 30° Nozzle | Straight Nozzle w/ Check Valve |
|--------------|--------------------|-------------|--------------------------------|
| AIR | LGB1-11A-60 | LGB1-21A-60 | LGB1-31A-60 |
| VAC | LGB1-11B-60 | LGB1-21B-60 | – |
| GAS | LGB1-11C-60 | LGB1-21C-60 | LGB1-31C-60 |
| NIT | LGB1-11D-60 | LGB1-21D-60 | LGB1-31D-60 |
| HE | LGB1-11F-60 | LGB1-21F-60 | LGB1-31F-60 |
| CO2 | LGB1-11G-60 | LGB1-21G-60 | LGB1-31G-60 |
| CO | LGB1-11H-60 | LGB1-21H-60 | LGB1-31H-60 |
| HYD | LGB1-11I-60 | LGB1-21I-60 | LGB1-31I-60 |
| PRO | LGB1-11J-60 | LGB1-21J-60 | LGB1-31J-60 |
| ACET | LGB1-11K-60 | LGB1-21K-60 | LGB1-31K-60 |
| CH4 | LGB1-11L-60 | LGB1-21L-60 | LGB1-31L-60 |
| SG | LGB1-11M-60 | LGB1-21M-60 | LGB1-31M-60 |

Wall Mounted, “Y” Pattern Dual 90° Gas Ball Valve Assembly With Shank

- “Y” pattern wall flange with two ball valves at 90°
- Solid brass straight valve body
- Polished chrome plated finish
- Metal lever handle with index button
- 3/8” - 18 NPT male thread shank assembly



| Index Button | Straight Nozzle | 30° Nozzle | Straight Nozzle w/ Check Valve |
|--------------|--------------------|-------------|--------------------------------|
| AIR | LGB1-11A-65 | LGB1-21A-65 | LGB1-31A-65 |
| VAC | LGB1-11B-65 | LGB1-21B-65 | – |
| GAS | LGB1-11C-65 | LGB1-21C-65 | LGB1-31C-65 |
| NIT | LGB1-11D-65 | LGB1-21D-65 | LGB1-31D-65 |
| HE | LGB1-11F-65 | LGB1-21F-65 | LGB1-31F-65 |
| CO2 | LGB1-11G-65 | LGB1-21G-65 | LGB1-31G-65 |
| CO | LGB1-11H-65 | LGB1-21H-65 | LGB1-31H-65 |
| HYD | LGB1-11I-65 | LGB1-21I-65 | LGB1-31I-65 |
| PRO | LGB1-11J-65 | LGB1-21J-65 | LGB1-31J-65 |
| ACET | LGB1-11K-65 | LGB1-21K-65 | LGB1-31K-65 |
| CH4 | LGB1-11L-65 | LGB1-21L-65 | LGB1-31L-65 |
| SG | LGB1-11M-65 | LGB1-21M-65 | LGB1-31M-65 |

Polypropylene Pure Water Faucet

- 3/8" NPT polypropylene male thread inlet
- Choice of chrome or satin antimicrobial finish



| Polished Chrome Finish | Deck Mount | Wall Mount |
|----------------------------|------------|------------|
| 828-ACP | • | – |
| 829-ACP | – | • |
| Satin Antimicrobial Finish | | |
| 828-ASAM | • | – |

Tygon Lined Pure Water Faucet

- 1/2" NPT male thread inlet
- Chrome plated finish
- Self-closing valve



| Polished Chrome Finish | Deck Mount | Wall Mount |
|------------------------|------------|------------|
| 838-CP | • | – |
| 839-ACP | – | • |

PVC Deck Mount Distilled Water Faucet

- 3/8" NPT female inlet or 1/2" NPSM male thread inlet
- Choice of right or left hand operation



| Right Hand Operation |
|----------------------|
| 869-BPVC |
| Left Hand Operation |
| 869-BLHPVC |

PVC Wall Mount Distilled Water Faucet

- 3/8" NPT female inlet or 1/2" NPSM male thread inlet



| Polished Chrome Finish |
|------------------------|
| 870-BPCV |

Tin Lined Deck Mount Pure Water Faucet

- 1/4" NPT male thread inlet tail piece
- Faucet can be installed for right or left hand operation



Self-closing cartridge

| Handle | Finish | |
|----------|--------------|---------------------|
| | Chrome | Satin Antimicrobial |
| Cross | 969-CTF | 969-SAM |
| 4" Blade | 969-317PLCTF | – |

Slow compression cartridge

| Handle | Chrome Finish |
|--------|---------------|
| Cross | 969-217XLHCTF |

Tin Lined Wall Mount Pure Water Faucet

- Gooseneck, straight, or angle valve
- Chrome plated finish
- Self-closing cartridge



| Model | 1/2" NPT Female Inlet | 3/8" NPT Male Inlet | Integral Wall Flange | Handle |
|---------|-----------------------|---------------------|----------------------|--------|
| 970-CTF | • | – | • | Right |
| 971-CTF | – | • | – | Top |
| 972-CTF | • | – | • | Top |

Natural PVDF Deck Mount Recirculating Water Faucet

- 3/8" NPT female inlet
- No metals, lubricants, elastomers used in design



| Deck Mount |
|------------|
| 830-PVDF |

Natural PVDF Wall Mount Recirculating Water Faucet

- 3/8" NPT female inlet or 1/2" NPSM male thread inlet
- No metals, lubricants, elastomers used in design



| Wall Mount |
|------------|
| 831-PVDF |

How to build and order a Chicago Faucets laboratory steam valve fitting.

Chicago Faucets makes it easy for you to build steam valve fittings that meet your exact requirements. You can reference the charts on the following pages, or you can build your own valve by choosing the components below to configure your model number.

LSV A - B C D - E
 (Lab Steam Valve)

Valve Base

A

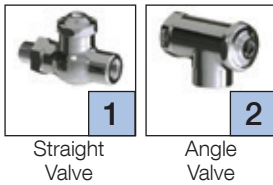

Cartridge

B

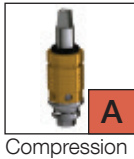

EXAMPLE



LSV1-A21-65

Straight valves with compression cartridges, 30° outlets, plastic handles with steam index buttons, and a dual wall flange with shank.

Outlet

C

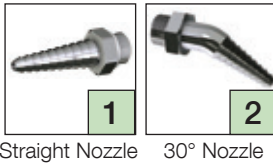

Handle

D

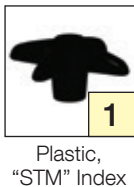

Turret

E

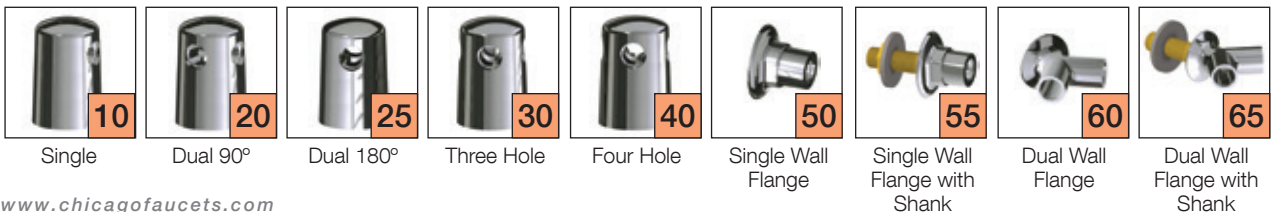

Straight Pattern Steam Valve

- Solid brass valve body
- Polished chrome plated finish
- 2-1/2" vandal proof cross handle
- 3/8" - 18 NPT male thread inlet



| Outlet | Model Number |
|----------|-----------------|
| Straight | LSV1-A11 |
| 30° | LSV1-A21 |

Wall Mounted, Straight Pattern Dual 90° Steam Valve Assembly With Shank

- Turret with one outlet
- Solid brass valve body
- Polished chrome plated finish
- 2-1/2" vandal proof cross handle
- 3/8" - 18 NPT male thread shank assembly



| Outlet | Model Number |
|----------|--------------------|
| Straight | LSV1-A11-10 |
| 30° | LSV1-A21-10 |

Deck Mounted, Straight Pattern Dual 90° Steam Valve Assembly

- Turret with two 90° outlets
- Solid brass valve body
- Polished chrome plated finish
- 2-1/2" vandal proof cross handle
- 3/8" - 18 NPT male thread shank assembly



| Outlet | Model Number |
|----------|--------------------|
| Straight | LSV1-A11-20 |
| 30° | LSV1-A21-20 |

Deck Mounted, Straight Pattern Dual 180° Steam Valve Assembly

- Turret with two 180° outlets
- Solid brass valve body
- Polished chrome plated finish
- 2-1/2" vandal proof cross handle
- 3/8" - 18 NPT male thread shank assembly



| Outlet | Model Number |
|----------|--------------------|
| Straight | LSV1-A11-25 |
| 30° | LSV1-A21-25 |

Deck Mounted, Straight Pattern Three Steam Valve Assembly

- Turret with three outlets
- Solid brass valve body
- Polished chrome plated finish
- 2-1/2" vandal proof cross handle
- 3/8" - 18 NPT male thread shank assembly



| Outlet | Model Number |
|----------|--------------------|
| Straight | LSV1-A11-30 |
| 30° | LSV1-A21-30 |

Deck Mounted, Straight Pattern Four Steam Valve Assembly

- Turret with four outlets
- Solid brass valve body
- Polished chrome plated finish
- 2-1/2" vandal proof cross handle
- 3/8" - 18 NPT male thread shank assembly



| Outlet | Model Number |
|----------|--------------------|
| Straight | LSV1-A11-40 |
| 30° | LSV1-A21-40 |

Wall Mounted, Straight Pattern Single Steam Valve Assembly Less Shank

- Wall flange
- Solid brass valve body
- Polished chrome plated finish
- 2-1/2" vandal proof cross handle
- 3/8" - 18 NPT female thread inlet



| Outlet | Model Number |
|----------|--------------------|
| Straight | LSV1-A11-50 |
| 30° | LSV1-A21-50 |

Wall Mounted, Straight Pattern Single Steam Valve Assembly With Shank

- Wall flange with shank
- Solid brass valve body
- Polished chrome plated finish
- 2-1/2" vandal proof cross handle
- 3/8" - 18 NPT male thread shank assembly



| Outlet | Model Number |
|----------|--------------------|
| Straight | LSV1-A11-55 |
| 30° | LSV1-A21-55 |

Wall Mounted, Straight Pattern Dual 90° Steam Valve Assembly Less Shank

- Wall flange
- Solid brass valve body
- Polished chrome plated finish
- 2-1/2" vandal proof cross handle
- 3/8" - 18 NPT female thread inlet



| Outlet | Model Number |
|----------|--------------------|
| Straight | LSV1-A11-60 |
| 30° | LSV1-A21-60 |

Wall Mounted, Straight Pattern Dual 90° Steam Valve Assembly With Shank

- Wall flange with shank
- Solid brass valve body
- Polished chrome plated finish
- 2-1/2" vandal proof cross handle
- 3/8" - 18 NPT male thread shank assembly



| Outlet | Model Number |
|----------|--------------------|
| Straight | LSV1-A11-65 |
| 30° | LSV1-A21-65 |

Angle Pattern Steam Valve

- Solid brass valve body
- Polished chrome plated finish
- 2-1/2" vandal proof cross handle
- 3/8" - 18 NPT female thread inlet



| Outlet | Model Number |
|----------|-----------------|
| Straight | LSV2-A11 |
| 30° | LSV2-A21 |

Single Steam Valve Assembly, Overhead Mounted

- Turret with one outlet
- Solid brass valve body
- Polished chrome plated finish
- 2-1/2" vandal proof cross handle
- 3/8" - 18 NPT male thread shank assembly



| Outlet | Model Number |
|----------|--------------------|
| Straight | LSV2-A11-10 |
| 30° | LSV2-A21-10 |

Dual 90° Steam Valve Assembly, Overhead Mounted

- Turret with two 90° outlets
- Solid brass valve body
- Polished chrome plated finish
- 2-1/2" vandal proof cross handle
- 3/8" - 18 NPT male thread shank assembly



| Outlet | Model Number |
|----------|--------------------|
| Straight | LSV2-A11-20 |
| 30° | LSV2-A21-20 |

Dual 180° Steam Valve Assembly, Overhead Mounted

- Turret with two 180° outlets
- Solid brass valve body
- Polished chrome plated finish
- 2-1/2" vandal proof cross handle
- 3/8" - 18 NPT male thread shank assembly



| Outlet | Model Number |
|----------|--------------------|
| Straight | LSV2-A11-25 |
| 30° | LSV2-A21-25 |

Three Steam Valve Assembly, Overhead Mounted

- Turret with three outlets
- Solid brass valve body
- Polished chrome plated finish
- 2-1/2" vandal proof cross handle
- 3/8" - 18 NPT male thread shank assembly

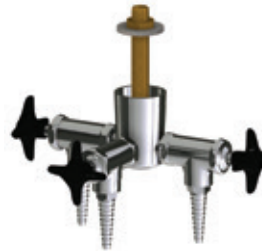

| Outlet | Model Number |
|----------|--------------------|
| Straight | LSV2-A11-30 |
| 30° | LSV2-A21-30 |

Four Steam Valve Assembly, Overhead Mounted

- Turret with four outlets
- Solid brass valve body
- Polished chrome plated finish
- 2-1/2" vandal proof cross handle
- 3/8" - 18 NPT male thread shank assembly



| Outlet | Model Number |
|----------|--------------------|
| Straight | LSV2-A11-40 |
| 30° | LSV2-A21-40 |

Wall Mounted, Angle Pattern Steam Valve with Single Wall Flange

- Wall flange
- Solid brass valve body
- Polished chrome plated finish
- 2-1/2" vandal proof cross handle
- 3/8" - 18 NPT female thread inlet



| Outlet | Model Number |
|----------|--------------------|
| Straight | LSV2-A11-50 |
| 30° | LSV2-A21-50 |

Wall Mounted, Angle Pattern Steam Valve with Single Wall Flange and Shank

- Wall flange with shank
- Solid brass valve body
- Polished chrome plated finish
- 2-1/2" vandal proof cross handle
- 3/8" - 18 NPT male thread shank assembly



| Outlet | Model Number |
|----------|--------------------|
| Straight | LSV2-A11-55 |
| 30° | LSV2-A21-55 |

Dual 180° Steam Valve Assembly, Wall Mounted

- Wall flange with two 180° outlets
- Solid brass valve body
- Polished chrome plated finish
- 2-1/2" vandal proof cross handle
- 3/8" - 18 NPT female thread inlet



| Outlet | Model Number |
|----------|--------------------|
| Straight | LSV2-A11-60 |
| 30° | LSV2-A21-60 |

Dual 180° Steam Valve Assembly With Shank, Wall Mounted

- Wall flange with two 180° outlets and shank
- Solid brass valve body
- Polished chrome plated finish
- 2-1/2" vandal proof cross handle
- 3/8" - 18 NPT male thread shank assembly



| Outlet | Model Number |
|----------|--------------------|
| Straight | LSV2-A11-65 |
| 30° | LSV2-A21-65 |

How to build and order a Chicago Faucets laboratory combination fitting with separate spout.

Chicago Faucets makes it easy for you to build combination fittings that meet your exact requirements. You can reference the charts on the following pages, or you can build your own valve by choosing the components below to configure your model number.

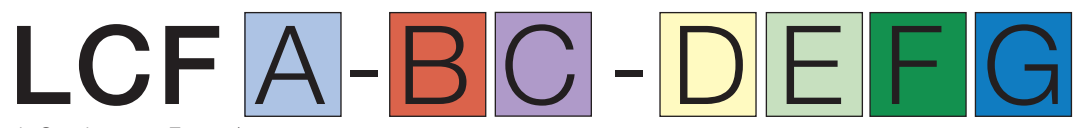

(Lab Combination Fittings)

Valve Base

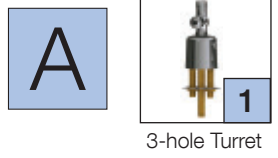

Left Button

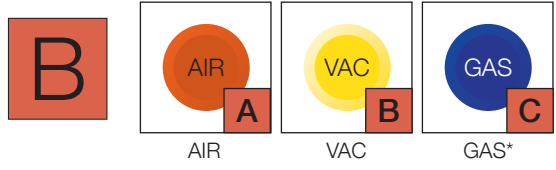

Right Button

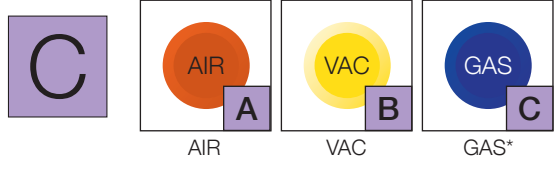

Cartridge

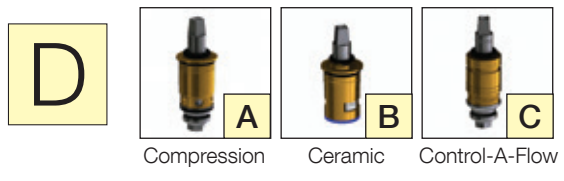

Handle

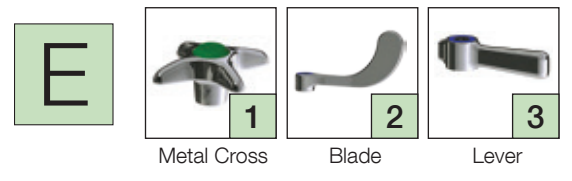

Spout

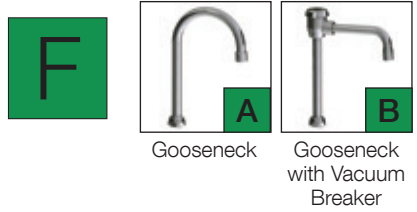

Outlet

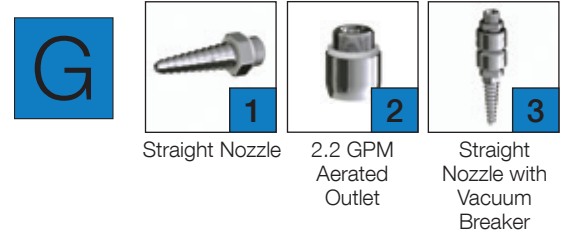

EXAMPLE

LCF1-AB-A1A1
Triple-service fitting, air button on left valve, vacuum button on right valve, compression cartridge, cross handle, and gooseneck spout with straight nozzle.

*Note: if gas service is selected, a check valve will automatically be included in the nozzle of the ball valve

How to build and order a Chicago Faucets laboratory combination fitting with integrated spout.

Chicago Faucets makes it easy for you to build combination fittings that meet your exact requirements. You can reference the charts on the following pages, or you can build your own valve by choosing the components below to configure your model number.

LCF **A** - **B** - **C** **D** **E**

(Lab Combination Fittings)

Valve Base

A



3-hole Fitting

Button (same for both handles)

B

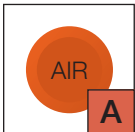

AIR

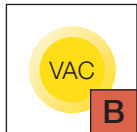

VAC

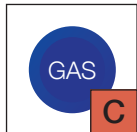

GAS*

Cartridge

C



Compression

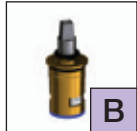

Ceramic

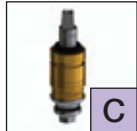

Control-A-Flow

Outlet

E



Straight Nozzle



2.2 GPM Aerated Outlet



Straight Nozzle with Vacuum Breaker

EXAMPLE



LCF2-A-A13

Dual-service fitting, air buttons on valves, compression cartridge, metal cross handle and straight nozzle with vacuum breaker.

Handle

D



Metal Cross

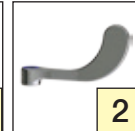

Blade

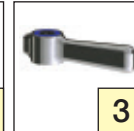

Lever

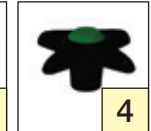

Plastic Cross

*Note: if gas service is selected, a check valve will automatically be included in the nozzle of the ball valve

Triple-service Combination Fitting with Gooseneck Spout and Cross Handle

- Turret with one top outlet for water and two side outlets for other services
- 5-1/4" gooseneck spout
- 7-5/8" water supply shank - 3/8"-18 NPT male inlet and 3/8"-18 NPT male outlet
- 5" gas supply shanks - 3/8"-18 NPT male inlet and 3/8"-18 NPT male outlet

Straight Nozzle on Spout



| Index Buttons L/R | Gooseneck Spout | | | Gooseneck Spout w/ Vacuum Breaker | | |
|----------------------|-----------------------|---------------------|--------------------------|-----------------------------------|-------------------|--------------------------|
| | Compression Cartridge | Ceramic Cartridge | Control-A-Flow Cartridge | Compression Cartridge | Ceramic Cartridge | Control-A-Flow Cartridge |
| AIR/AIR | LCF1-AA-A1A1 | LCF1-AA-B1A1 | LCF1-AA-C1A1 | LCF1-AA-A1B1 | LCF1-AA-B1B1 | LCF1-AA-C1B1 |
| AIR/VAC | LCF1-AB-A1A1 | LCF1-AB-B1A1 | LCF1-AB-C1A1 | LCF1-AB-A1B1 | LCF1-AB-B1B1 | LCF1-AB-C1B1 |
| AIR/GAS | LCF1-AC-A1A1 | LCF1-AC-B1A1 | LCF1-AC-C1A1 | LCF1-AC-A1B1 | LCF1-AC-B1B1 | LCF1-AC-C1B1 |
| VAC/AIR | LCF1-BA-A1A1 | LCF1-BA-B1A1 | LCF1-BA-C1A1 | LCF1-BA-A1B1 | LCF1-BA-B1B1 | LCF1-BA-C1B1 |
| VAC/VAC | LCF1-BB-A1A1 | LCF1-BB-B1A1 | LCF1-BB-C1A1 | LCF1-BB-A1B1 | LCF1-BB-B1B1 | LCF1-BB-C1B1 |
| VAC/GAS | LCF1-BC-A1A1 | LCF1-BC-B1A1 | LCF1-BC-C1A1 | LCF1-BC-A1B1 | LCF1-BC-B1B1 | LCF1-BC-C1B1 |
| GAS/AIR | LCF1-CA-A1A1 | LCF1-CA-B1A1 | LCF1-CA-C1A1 | LCF1-CA-A1B1 | LCF1-CA-B1B1 | LCF1-CA-C1B1 |
| GAS/VAC | LCF1-CB-A1A1 | LCF1-CB-B1A1 | LCF1-CB-C1A1 | LCF1-CB-A1B1 | LCF1-CB-B1B1 | LCF1-CB-C1B1 |
| GAS/GAS | LCF1-CC-A1A1 | LCF1-CC-B1A1 | LCF1-CC-C1A1 | LCF1-CC-A1B1 | LCF1-CC-B1B1 | LCF1-CC-C1B1 |

2.2 GPM Outlet on Spout



| Index Buttons L/R | Gooseneck Spout | | | Gooseneck Spout w/ Vacuum Breaker | | |
|----------------------|-----------------------|-------------------|--------------------------|-----------------------------------|-------------------|--------------------------|
| | Compression Cartridge | Ceramic Cartridge | Control-A-Flow Cartridge | Compression Cartridge | Ceramic Cartridge | Control-A-Flow Cartridge |
| AIR/AIR | LCF1-AA-A2A2 | LCF1-AA-B1A2 | LCF1-AA-C1A2 | LCF1-AA-A1B2 | LCF1-AA-B1B2 | LCF1-AA-C1B2 |
| AIR/VAC | LCF1-AB-A2A2 | LCF1-AB-B1A2 | LCF1-AB-C1A2 | LCF1-AB-A1B2 | LCF1-AB-B1B2 | LCF1-AB-C1B2 |
| AIR/GAS | LCF1-AC-A2A2 | LCF1-AC-B1A2 | LCF1-AC-C1A2 | LCF1-AC-A1B2 | LCF1-AC-B1B2 | LCF1-AC-C1B2 |
| VAC/AIR | LCF1-BA-A2A2 | LCF1-BA-B1A2 | LCF1-BA-C1A2 | LCF1-BA-A1B2 | LCF1-BA-B1B2 | LCF1-BA-C1B2 |
| VAC/VAC | LCF1-BB-A2A2 | LCF1-BB-B1A2 | LCF1-BB-C1A2 | LCF1-BB-A1B2 | LCF1-BB-B1B2 | LCF1-BB-C1B2 |
| VAC/GAS | LCF1-BC-A2A2 | LCF1-BC-B1A2 | LCF1-BC-C1A2 | LCF1-BC-A1B2 | LCF1-BC-B1B2 | LCF1-BC-C1B2 |
| GAS/AIR | LCF1-CA-A2A2 | LCF1-CA-B1A2 | LCF1-CA-C1A2 | LCF1-CA-A1B2 | LCF1-CA-B1B2 | LCF1-CA-C1B2 |
| GAS/VAC | LCF1-CB-A2A2 | LCF1-CB-B1A2 | LCF1-CB-C1A2 | LCF1-CB-A1B2 | LCF1-CB-B1B2 | LCF1-CB-C1B2 |
| GAS/GAS | LCF1-CC-A2A2 | LCF1-CC-B1A2 | LCF1-CC-C1A2 | LCF1-CC-A1B2 | LCF1-CC-B1B2 | LCF1-CC-C1B2 |

Straight Nozzle with Vacuum Breaker on Spout



| Index Buttons L/R | Gooseneck Spout | | | Gooseneck Spout w/ Vacuum Breaker | | |
|----------------------|-----------------------|-------------------|--------------------------|-----------------------------------|-------------------|--------------------------|
| | Compression Cartridge | Ceramic Cartridge | Control-A-Flow Cartridge | Compression Cartridge | Ceramic Cartridge | Control-A-Flow Cartridge |
| AIR/AIR | LCF1-AA-A2A3 | LCF1-AA-B1A3 | LCF1-AA-C1A3 | LCF1-AA-A1B3 | LCF1-AA-B1B3 | LCF1-AA-C1B3 |
| AIR/VAC | LCF1-AB-A2A3 | LCF1-AB-B1A3 | LCF1-AB-C1A3 | LCF1-AB-A1B3 | LCF1-AB-B1B3 | LCF1-AB-C1B3 |
| AIR/GAS | LCF1-AC-A2A3 | LCF1-AC-B1A3 | LCF1-AC-C1A3 | LCF1-AC-A1B3 | LCF1-AC-B1B3 | LCF1-AC-C1B3 |
| VAC/AIR | LCF1-BA-A2A3 | LCF1-BA-B1A3 | LCF1-BA-C1A3 | LCF1-BA-A1B3 | LCF1-BA-B1B3 | LCF1-BA-C1B3 |
| VAC/VAC | LCF1-BB-A2A3 | LCF1-BB-B1A3 | LCF1-BB-C1A3 | LCF1-BB-A1B3 | LCF1-BB-B1B3 | LCF1-BB-C1B3 |
| VAC/GAS | LCF1-BC-A2A3 | LCF1-BC-B1A3 | LCF1-BC-C1A3 | LCF1-BC-A1B3 | LCF1-BC-B1B3 | LCF1-BC-C1B3 |
| GAS/AIR | LCF1-CA-A2A3 | LCF1-CA-B1A3 | LCF1-CA-C1A3 | LCF1-CA-A1B3 | LCF1-CA-B1B3 | LCF1-CA-C1B3 |
| GAS/VAC | LCF1-CB-A2A3 | LCF1-CB-B1A3 | LCF1-CB-C1A3 | LCF1-CB-A1B3 | LCF1-CB-B1B3 | LCF1-CB-C1B3 |
| GAS/GAS | LCF1-CC-A2A3 | LCF1-CC-B1A3 | LCF1-CC-C1A3 | LCF1-CC-A1B3 | LCF1-CC-B1B3 | LCF1-CC-C1B3 |

Triple-service Combination Fitting with Gooseneck Spout and Blade Handle

- Turret with one top outlet for water and two side outlets for other services
- 5-1/4" gooseneck spout
- 7-5/8" water supply shank - 3/8"-18 NPT male inlet and 3/8"-18 NPT male outlet
- 5" gas supply shanks - 3/8"-18 NPT male inlet and 3/8"-18 NPT male outlet

Straight Nozzle on Spout



| Index Buttons L/R | Gooseneck Spout | | | Gooseneck Spout w/ Vacuum Breaker | | |
|----------------------|-----------------------|-------------------|--------------------------|-----------------------------------|-------------------|--------------------------|
| | Compression Cartridge | Ceramic Cartridge | Control-A-Flow Cartridge | Compression Cartridge | Ceramic Cartridge | Control-A-Flow Cartridge |
| AIR/AIR | LCF1-AA-A2A1 | LCF1-AA-B2A1 | LCF1-AA-C2A1 | LCF1-AA-A2B1 | LCF1-AA-B2B1 | LCF1-AA-C2B1 |
| AIR/VAC | LCF1-AB-A2A1 | LCF1-AB-B2A1 | LCF1-AB-C2A1 | LCF1-AB-A2B1 | LCF1-AB-B2B1 | LCF1-AB-C2B1 |
| AIR/GAS | LCF1-AC-A2A1 | LCF1-AC-B2A1 | LCF1-AC-C2A1 | LCF1-AC-A2B1 | LCF1-AC-B2B1 | LCF1-AC-C2B1 |
| VAC/AIR | LCF1-BA-A2A1 | LCF1-BA-B2A1 | LCF1-BA-C2A1 | LCF1-BA-A2B1 | LCF1-BA-B2B1 | LCF1-BA-C2B1 |
| VAC/VAC | LCF1-BB-A2A1 | LCF1-BB-B2A1 | LCF1-BB-C2A1 | LCF1-BB-A2B1 | LCF1-BB-B2B1 | LCF1-BB-C2B1 |
| VAC/GAS | LCF1-BC-A2A1 | LCF1-BC-B2A1 | LCF1-BC-C2A1 | LCF1-BC-A2B1 | LCF1-BC-B2B1 | LCF1-BC-C2B1 |
| GAS/AIR | LCF1-CA-A2A1 | LCF1-CA-B2A1 | LCF1-CA-C2A1 | LCF1-CA-A2B1 | LCF1-CA-B2B1 | LCF1-CA-C2B1 |
| GAS/VAC | LCF1-CB-A2A1 | LCF1-CB-B2A1 | LCF1-CB-C2A1 | LCF1-CB-A2B1 | LCF1-CB-B2B1 | LCF1-CB-C2B1 |
| GAS/GAS | LCF1-CC-A2A1 | LCF1-CC-B2A1 | LCF1-CC-C2A1 | LCF1-CC-A2B1 | LCF1-CC-B2B1 | LCF1-CC-C2B1 |

2.2 GPM Outlet on Spout



| Index Buttons L/R | Gooseneck Spout | | | Gooseneck Spout w/ Vacuum Breaker | | |
|----------------------|-----------------------|-------------------|--------------------------|-----------------------------------|-------------------|--------------------------|
| | Compression Cartridge | Ceramic Cartridge | Control-A-Flow Cartridge | Compression Cartridge | Ceramic Cartridge | Control-A-Flow Cartridge |
| AIR/AIR | LCF1-AA-A2A2 | LCF1-AA-B2A2 | LCF1-AA-C2A2 | LCF1-AA-A1B2 | LCF1-AA-B2B2 | LCF1-AA-C2B2 |
| AIR/VAC | LCF1-AB-A2A2 | LCF1-AB-B2A2 | LCF1-AB-C2A2 | LCF1-AB-A1B2 | LCF1-AB-B2B2 | LCF1-AB-C2B2 |
| AIR/GAS | LCF1-AC-A2A2 | LCF1-AC-B2A2 | LCF1-AC-C2A2 | LCF1-AC-A1B2 | LCF1-AC-B2B2 | LCF1-AC-C2B2 |
| VAC/AIR | LCF1-BA-A2A2 | LCF1-BA-B2A2 | LCF1-BA-C2A2 | LCF1-BA-A1B2 | LCF1-BA-B2B2 | LCF1-BA-C2B2 |
| VAC/VAC | LCF1-BB-A2A2 | LCF1-BB-B2A2 | LCF1-BB-C2A2 | LCF1-BB-A1B2 | LCF1-BB-B2B2 | LCF1-BB-C2B2 |
| VAC/GAS | LCF1-BC-A2A2 | LCF1-BC-B2A2 | LCF1-BC-C2A2 | LCF1-BC-A1B2 | LCF1-BC-B2B2 | LCF1-BC-C2B2 |
| GAS/AIR | LCF1-CA-A2A2 | LCF1-CA-B2A2 | LCF1-CA-C2A2 | LCF1-CA-A1B2 | LCF1-CA-B2B2 | LCF1-CA-C2B2 |
| GAS/VAC | LCF1-CB-A2A2 | LCF1-CB-B2A2 | LCF1-CB-C2A2 | LCF1-CB-A1B2 | LCF1-CB-B2B2 | LCF1-CB-C2B2 |
| GAS/GAS | LCF1-CC-A2A2 | LCF1-CC-B2A2 | LCF1-CC-C2A2 | LCF1-CC-A1B2 | LCF1-CC-B2B2 | LCF1-CC-C2B2 |

Straight Nozzle with Vacuum Breaker on Spout



| Index Buttons L/R | Gooseneck Spout | | | Gooseneck Spout w/ Vacuum Breaker | | |
|----------------------|-----------------------|-------------------|--------------------------|-----------------------------------|-------------------|--------------------------|
| | Compression Cartridge | Ceramic Cartridge | Control-A-Flow Cartridge | Compression Cartridge | Ceramic Cartridge | Control-A-Flow Cartridge |
| AIR/AIR | LCF1-AA-A2A3 | LCF1-AA-B2A3 | LCF1-AA-C2A3 | LCF1-AA-A1B3 | LCF1-AA-B2B3 | LCF1-AA-C2B3 |
| AIR/VAC | LCF1-AB-A2A3 | LCF1-AB-B2A3 | LCF1-AB-C2A3 | LCF1-AB-A1B3 | LCF1-AB-B2B3 | LCF1-AB-C2B3 |
| AIR/GAS | LCF1-AC-A2A3 | LCF1-AC-B2A3 | LCF1-AC-C2A3 | LCF1-AC-A1B3 | LCF1-AC-B2B3 | LCF1-AC-C2B3 |
| VAC/AIR | LCF1-BA-A2A3 | LCF1-BA-B2A3 | LCF1-BA-C2A3 | LCF1-BA-A1B3 | LCF1-BA-B2B3 | LCF1-BA-C2B3 |
| VAC/VAC | LCF1-BB-A2A3 | LCF1-BB-B2A3 | LCF1-BB-C2A3 | LCF1-BB-A1B3 | LCF1-BB-B2B3 | LCF1-BB-C2B3 |
| VAC/GAS | LCF1-BC-A2A3 | LCF1-BC-B2A3 | LCF1-BC-C2A3 | LCF1-BC-A1B3 | LCF1-BC-B2B3 | LCF1-BC-C2B3 |
| GAS/AIR | LCF1-CA-A2A3 | LCF1-CA-B2A3 | LCF1-CA-C2A3 | LCF1-CA-A1B3 | LCF1-CA-B2B3 | LCF1-CA-C2B3 |
| GAS/VAC | LCF1-CB-A2A3 | LCF1-CB-B2A3 | LCF1-CB-C2A3 | LCF1-CB-A1B3 | LCF1-CB-B2B3 | LCF1-CB-C2B3 |
| GAS/GAS | LCF1-CC-A2A3 | LCF1-CC-B2A3 | LCF1-CC-C2A3 | LCF1-CC-A1B3 | LCF1-CC-B2B3 | LCF1-CC-C2B3 |

Triple-service Combination Fitting with Gooseneck Spout and Lever Handle

- Turret with one top outlet for water and two side outlets for other services
- 5-1/4" gooseneck spout
- 7-5/8" water supply shank - 3/8"-18 NPT male inlet and 3/8"-18 NPT male outlet
- 5" gas supply shanks - 3/8"-18 NPT male inlet and 3/8"-18 NPT male outlet

Straight Nozzle on Spout



| Index Buttons L/R | Gooseneck Spout | | | Gooseneck Spout w/ Vacuum Breaker | | |
|----------------------|-----------------------|-------------------|--------------------------|-----------------------------------|-------------------|--------------------------|
| | Compression Cartridge | Ceramic Cartridge | Control-A-Flow Cartridge | Compression Cartridge | Ceramic Cartridge | Control-A-Flow Cartridge |
| AIR/AIR | LCF1-AA-A3A1 | LCF1-AA-B3A1 | LCF1-AA-C3A1 | LCF1-AA-A3B1 | LCF1-AA-B3B1 | LCF1-AA-C3B1 |
| AIR/VAC | LCF1-AB-A3A1 | LCF1-AB-B3A1 | LCF1-AB-C3A1 | LCF1-AB-A3B1 | LCF1-AB-B3B1 | LCF1-AB-C3B1 |
| AIR/GAS | LCF1-AC-A3A1 | LCF1-AC-B3A1 | LCF1-AC-C3A1 | LCF1-AC-A3B1 | LCF1-AC-B3B1 | LCF1-AC-C3B1 |
| VAC/AIR | LCF1-BA-A3A1 | LCF1-BA-B3A1 | LCF1-BA-C3A1 | LCF1-BA-A3B1 | LCF1-BA-B3B1 | LCF1-BA-C3B1 |
| VAC/VAC | LCF1-BB-A3A1 | LCF1-BB-B3A1 | LCF1-BB-C3A1 | LCF1-BB-A3B1 | LCF1-BB-B3B1 | LCF1-BB-C3B1 |
| VAC/GAS | LCF1-BC-A3A1 | LCF1-BC-B3A1 | LCF1-BC-C3A1 | LCF1-BC-A3B1 | LCF1-BC-B3B1 | LCF1-BC-C3B1 |
| GAS/AIR | LCF1-CA-A3A1 | LCF1-CA-B3A1 | LCF1-CA-C3A1 | LCF1-CA-A3B1 | LCF1-CA-B3B1 | LCF1-CA-C3B1 |
| GAS/VAC | LCF1-CB-A3A1 | LCF1-CB-B3A1 | LCF1-CB-C3A1 | LCF1-CB-A3B1 | LCF1-CB-B3B1 | LCF1-CB-C3B1 |
| GAS/GAS | LCF1-CC-A3A1 | LCF1-CC-B3A1 | LCF1-CC-C3A1 | LCF1-CC-A3B1 | LCF1-CC-B3B1 | LCF1-CC-C3B1 |

2.2 GPM Outlet on Spout



| Index Buttons L/R | Gooseneck Spout | | | Gooseneck Spout w/ Vacuum Breaker | | |
|----------------------|-----------------------|-------------------|--------------------------|-----------------------------------|---------------------|--------------------------|
| | Compression Cartridge | Ceramic Cartridge | Control-A-Flow Cartridge | Compression Cartridge | Ceramic Cartridge | Control-A-Flow Cartridge |
| AIR/AIR | LCF1-AA-A3A2 | LCF1-AA-B3A2 | LCF1-AA-C3A2 | LCF1-AA-A3B2 | LCF1-AA-B3B2 | LCF1-AA-C3B2 |
| AIR/VAC | LCF1-AB-A3A2 | LCF1-AB-B3A2 | LCF1-AB-C3A2 | LCF1-AB-A3B2 | LCF1-AB-B3B2 | LCF1-AB-C3B2 |
| AIR/GAS | LCF1-AC-A3A2 | LCF1-AC-B3A2 | LCF1-AC-C3A2 | LCF1-AC-A3B2 | LCF1-AC-B3B2 | LCF1-AC-C3B2 |
| VAC/AIR | LCF1-BA-A3A2 | LCF1-BA-B3A2 | LCF1-BA-C3A2 | LCF1-BA-A3B2 | LCF1-BA-B3B2 | LCF1-BA-C3B2 |
| VAC/VAC | LCF1-BB-A3A2 | LCF1-BB-B3A2 | LCF1-BB-C3A2 | LCF1-BB-A3B2 | LCF1-BB-B3B2 | LCF1-BB-C3B2 |
| VAC/GAS | LCF1-BC-A3A2 | LCF1-BC-B3A2 | LCF1-BC-C3A2 | LCF1-BC-A3B2 | LCF1-BC-B3B2 | LCF1-BC-C3B2 |
| GAS/AIR | LCF1-CA-A3A2 | LCF1-CA-B3A2 | LCF1-CA-C3A2 | LCF1-CA-A3B2 | LCF1-CA-B3B2 | LCF1-CA-C3B2 |
| GAS/VAC | LCF1-CB-A3A2 | LCF1-CB-B3A2 | LCF1-CB-C3A2 | LCF1-CB-A3B2 | LCF1-CB-B3B2 | LCF1-CB-C3B2 |
| GAS/GAS | LCF1-CC-A3A2 | LCF1-CC-B3A2 | LCF1-CC-C3A2 | LCF1-CC-A3B2 | LCF1-CC-B3B2 | LCF1-CC-C3B2 |

Straight Nozzle with Vacuum Breaker on Spout



| Index Buttons L/R | Gooseneck Spout | | | Gooseneck Spout w/ Vacuum Breaker | | |
|----------------------|-----------------------|-------------------|--------------------------|-----------------------------------|-------------------|--------------------------|
| | Compression Cartridge | Ceramic Cartridge | Control-A-Flow Cartridge | Compression Cartridge | Ceramic Cartridge | Control-A-Flow Cartridge |
| AIR/AIR | LCF1-AA-A3A3 | LCF1-AA-B3A3 | LCF1-AA-C3A3 | LCF1-AA-A3B3 | LCF1-AA-B3B3 | LCF1-AA-C3B3 |
| AIR/VAC | LCF1-AB-A3A3 | LCF1-AB-B3A3 | LCF1-AB-C3A3 | LCF1-AB-A3B3 | LCF1-AB-B3B3 | LCF1-AB-C3B3 |
| AIR/GAS | LCF1-AC-A3A3 | LCF1-AC-B3A3 | LCF1-AC-C3A3 | LCF1-AC-A3B3 | LCF1-AC-B3B3 | LCF1-AC-C3B3 |
| VAC/AIR | LCF1-BA-A3A3 | LCF1-BA-B3A3 | LCF1-BA-C3A3 | LCF1-BA-A3B3 | LCF1-BA-B3B3 | LCF1-BA-C3B3 |
| VAC/VAC | LCF1-BB-A3A3 | LCF1-BB-B3A3 | LCF1-BB-C3A3 | LCF1-BB-A3B3 | LCF1-BB-B3B3 | LCF1-BB-C3B3 |
| VAC/GAS | LCF1-BC-A3A3 | LCF1-BC-B3A3 | LCF1-BC-C3A3 | LCF1-BC-A3B3 | LCF1-BC-B3B3 | LCF1-BC-C3B3 |
| GAS/AIR | LCF1-CA-A3A3 | LCF1-CA-B3A3 | LCF1-CA-C3A3 | LCF1-CA-A3B3 | LCF1-CA-B3B3 | LCF1-CA-C3B3 |
| GAS/VAC | LCF1-CB-A3A3 | LCF1-CB-B3A3 | LCF1-CB-C3A3 | LCF1-CB-A3B3 | LCF1-CB-B3B3 | LCF1-CB-C3B3 |
| GAS/GAS | LCF1-CC-A3A3 | LCF1-CC-B3A3 | LCF1-CC-C3A3 | LCF1-CC-A3B3 | LCF1-CC-B3B3 | LCF1-CC-C3B3 |

Dual-service Combination Fitting with Integrated Spout and Metal Cross Handle

- One-piece spout design with one top and two side outlets
- 2-1/4", 3/8" NPT male front shank for water
- 2-1/4", 3/8" NPT male rear shank for other services



Straight Nozzle on Spout

| Index Buttons | Integrated Spout | | |
|---------------|-----------------------|-------------------|--------------------------|
| | Compression Cartridge | Ceramic Cartridge | Control-A-Flow Cartridge |
| AIR | LCF2-A-A11 | LCF2-A-B11 | LCF2-A-C11 |
| VAC | LCF2-B-A11 | LCF2-B-B11 | LCF2-B-C11 |
| GAS | LCF2-C-A11 | LCF2-C-B11 | LCF2-C-C11 |



2.2 GPM Outlet on Spout

| Index Buttons | Integrated Spout | | |
|---------------|-----------------------|-------------------|--------------------------|
| | Compression Cartridge | Ceramic Cartridge | Control-A-Flow Cartridge |
| AIR | LCF2-A-A12 | LCF2-A-B12 | LCF2-A-C12 |
| VAC | LCF2-B-A12 | LCF2-B-B12 | LCF2-B-C12 |
| GAS | LCF2-C-A12 | LCF2-C-B12 | LCF2-C-C12 |



Straight Nozzle with Vacuum Breaker on Spout

| Index Buttons | Integrated Spout | | |
|---------------|-----------------------|-------------------|--------------------------|
| | Compression Cartridge | Ceramic Cartridge | Control-A-Flow Cartridge |
| AIR | LCF2-A-A13 | LCF2-A-B13 | LCF2-A-C13 |
| VAC | LCF2-B-A13 | LCF2-B-B13 | LCF2-B-C13 |
| GAS | LCF2-C-A13 | LCF2-C-B13 | LCF2-C-C13 |

Dual-service Combination Fitting with Integrated Spout and Blade Handle

- One-piece spout design with one top and two side outlets
- 2-1/4", 3/8" NPT male front shank for water
- 2-1/4", 3/8" NPT male rear shank for other services



Straight Nozzle on Spout

| Index Buttons | Integrated Spout | | |
|---------------|-----------------------|-------------------|--------------------------|
| | Compression Cartridge | Ceramic Cartridge | Control-A-Flow Cartridge |
| AIR | LCF2-A-A21 | LCF2-A-B21 | LCF2-A-C21 |
| VAC | LCF2-B-A21 | LCF2-B-B21 | LCF2-B-C21 |
| GAS | LCF2-C-A21 | LCF2-C-B21 | LCF2-C-C21 |



2.2 GPM Outlet on Spout

| Index Buttons | Integrated Spout | | |
|---------------|-----------------------|-------------------|--------------------------|
| | Compression Cartridge | Ceramic Cartridge | Control-A-Flow Cartridge |
| AIR | LCF2-A-A22 | LCF2-A-B22 | LCF2-A-C22 |
| VAC | LCF2-B-A22 | LCF2-B-B22 | LCF2-B-C22 |
| GAS | LCF2-C-A22 | LCF2-C-B22 | LCF2-C-C22 |



Straight Nozzle with Vacuum Breaker on Spout

| Index Buttons | Integrated Spout | | |
|---------------|-----------------------|-------------------|--------------------------|
| | Compression Cartridge | Ceramic Cartridge | Control-A-Flow Cartridge |
| AIR | LCF2-A-A23 | LCF2-A-B23 | LCF2-A-C23 |
| VAC | LCF2-B-A23 | LCF2-B-B23 | LCF2-B-C23 |
| GAS | LCF2-C-A23 | LCF2-C-B23 | LCF2-C-C23 |

Dual-service Combination Fitting with Integrated Spout and Lever Handle

- One-piece spout design with one top and two side outlets
- 2-1/4", 3/8" NPT male front shank for water
- 2-1/4", 3/8" NPT male rear shank for other services



Straight Nozzle on Spout

| Index Buttons | Integrated Spout | | |
|---------------|-----------------------|-------------------|--------------------------|
| | Compression Cartridge | Ceramic Cartridge | Control-A-Flow Cartridge |
| AIR | LCF2-A-A31 | LCF2-A-B31 | LCF2-A-C31 |
| VAC | LCF2-B-A31 | LCF2-B-B31 | LCF2-B-C31 |
| GAS | LCF2-C-A31 | LCF2-C-B31 | LCF2-C-C31 |



2.2 GPM Outlet on Spout

| Index Buttons | Integrated Spout | | |
|---------------|-----------------------|-------------------|--------------------------|
| | Compression Cartridge | Ceramic Cartridge | Control-A-Flow Cartridge |
| AIR | LCF2-A-A32 | LCF2-A-B32 | LCF2-A-C32 |
| VAC | LCF2-B-A32 | LCF2-B-B32 | LCF2-B-C32 |
| GAS | LCF2-C-A32 | LCF2-C-B32 | LCF2-C-C32 |



Straight Nozzle with Vacuum Breaker on Spout

| Index Buttons | Integrated Spout | | |
|---------------|-----------------------|-------------------|--------------------------|
| | Compression Cartridge | Ceramic Cartridge | Control-A-Flow Cartridge |
| AIR | LCF2-A-A33 | LCF2-A-B33 | LCF2-A-C33 |
| VAC | LCF2-B-A33 | LCF2-B-B33 | LCF2-B-C33 |
| GAS | LCF2-C-A33 | LCF2-C-B33 | LCF2-C-C33 |

Dual-service Combination Fitting with Integrated Spout and Plastic Cross Handle

- One-piece spout design with one top and two side outlets
- 2-1/4", 3/8" NPT male front shank for water
- 2-1/4", 3/8" NPT male rear shank for other services



Straight Nozzle on Spout

| Index Buttons | Integrated Spout | | |
|---------------|-----------------------|-------------------|--------------------------|
| | Compression Cartridge | Ceramic Cartridge | Control-A-Flow Cartridge |
| AIR | LCF2-A-A41 | LCF2-A-B41 | LCF2-A-C41 |
| VAC | LCF2-B-A41 | LCF2-B-B41 | LCF2-B-C41 |
| GAS | LCF2-C-A41 | LCF2-C-B41 | LCF2-C-C41 |



2.2 GPM Outlet on Spout

| Index Buttons | Integrated Spout | | |
|---------------|-----------------------|-------------------|--------------------------|
| | Compression Cartridge | Ceramic Cartridge | Control-A-Flow Cartridge |
| AIR | LCF2-A-A42 | LCF2-A-B42 | LCF2-A-C42 |
| VAC | LCF2-B-A42 | LCF2-B-B42 | LCF2-B-C42 |
| GAS | LCF2-C-A42 | LCF2-C-B42 | LCF2-C-C42 |



Straight Nozzle with Vacuum Breaker on Spout

| Index Buttons | Integrated Spout | | |
|---------------|-----------------------|-------------------|--------------------------|
| | Compression Cartridge | Ceramic Cartridge | Control-A-Flow Cartridge |
| AIR | LCF2-A-A43 | LCF2-A-B43 | LCF2-A-C43 |
| VAC | LCF2-B-A43 | LCF2-B-B43 | LCF2-B-C43 |
| GAS | LCF2-C-A43 | LCF2-C-B43 | LCF2-C-C43 |

How to build and order a Chicago Faucets laboratory remote spout.

Chicago Faucets makes it easy for you to build remote spouts that meet your exact requirements. You can reference the charts on the following pages or you can build your own fitting by using the chart below to configure your model number.

LRS- **Base** (A,B,C,D or E) **Outlet** (01,02,11,12) **Finish** (no code required for chrome)

EXAMPLE



LRS-A01-DGR
Straight base with straight nozzle in a dark green finish.

| Outlet Options | | Base Options | | | | |
|----------------|--|--------------|---|---|---|---|
| | | A | B | C | D | E |
| 01 | | | | | | |
| 02 | | | | | | |
| 11 | | | | | | |
| 21 | | | | | | |

Finish Options

| | | | | | | | | | | |
|-------|--------|--------|------------|-----|-----------|------------|-------------|-------|------|-------|
| | | | | | | | | | | |
| White | Yellow | Orange | Dark Green | Red | Dark Blue | Light Blue | Light Green | Brown | Pink | Black |

Panel Mount Straight Base, Straight Nozzle

- Solid brass straight fitting base
- Choice of finishes
- 3/8" - 18 NPT male thread shank assembly

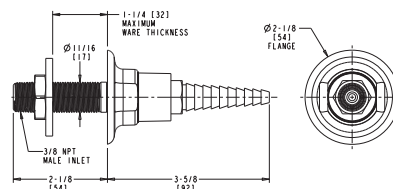

| Finish | Model Number |
|-------------|----------------|
| Chrome | LRS-A01 |
| White | LRS-A01-WHT |
| Yellow | LRS-A01-YEL |
| Orange | LRS-A01-ORG |
| Dark Green | LRS-A01-DGR |
| Red | LRS-A01-RED |
| Dark Blue | LRS-A01-DBL |
| Light Blue | LRS-A01-LBL |
| Light Green | LRS-A01-LGR |
| Brown | LRS-A01-BRN |
| Pink | LRS-A01-PNK |
| Black | LRS-A01-BLK |

Panel Mount Straight Base, 30° Nozzle

- Solid brass straight fitting base
- Choice of finishes
- 3/8" - 18 NPT male thread shank assembly

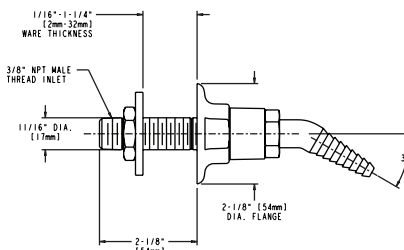

| Finish | Model Number |
|-------------|----------------|
| Chrome | LRS-A02 |
| White | LRS-A02-WHT |
| Yellow | LRS-A02-YEL |
| Orange | LRS-A02-ORG |
| Dark Green | LRS-A02-DGR |
| Red | LRS-A02-RED |
| Dark Blue | LRS-A02-DBL |
| Light Blue | LRS-A02-LBL |
| Light Green | LRS-A02-LGR |
| Brown | LRS-A02-BRN |
| Pink | LRS-A02-PNK |
| Black | LRS-A02-BLK |

Panel Mount Angle Base with Extension, Straight Nozzle

- Solid brass angle fitting with extension
- Choice of finishes
- 3/8" - 18 NPT male thread shank assembly

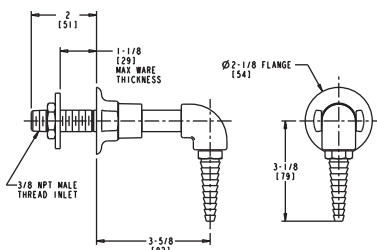

| Finish | Model Number |
|-------------|----------------|
| Chrome | LRS-B01 |
| White | LRS-B01-WHT |
| Yellow | LRS-B01-YEL |
| Orange | LRS-B01-ORG |
| Dark Green | LRS-B01-DGR |
| Red | LRS-B01-RED |
| Dark Blue | LRS-B01-DBL |
| Light Blue | LRS-B01-LBL |
| Light Green | LRS-B01-LGR |
| Brown | LRS-B01-BRN |
| Pink | LRS-B01-PNK |
| Black | LRS-B01-BLK |

Panel Mount Angle Base with Extension, 30° Nozzle

- Solid brass angle fitting with extension
- Choice of finishes
- 3/8" - 18 NPT male thread shank assembly

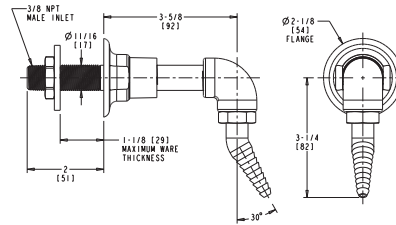

| Finish | Model Number |
|-------------|----------------|
| Chrome | LRS-B02 |
| White | LRS-B02-WHT |
| Yellow | LRS-B02-YEL |
| Orange | LRS-B02-ORG |
| Dark Green | LRS-B02-DGR |
| Red | LRS-B02-RED |
| Dark Blue | LRS-B02-DBL |
| Light Blue | LRS-B02-LBL |
| Light Green | LRS-B02-LGR |
| Brown | LRS-B02-BRN |
| Pink | LRS-B02-PNK |
| Black | LRS-B02-BLK |

Panel Mount Angle Base, Straight Nozzle

- Solid brass angle fitting base
- Choice of finishes
- 3/8" - 18 NPT male thread shank assembly

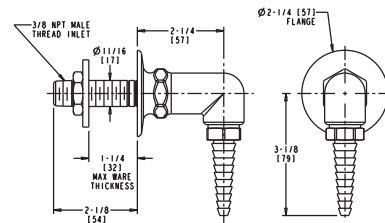

| Finish | Model Number |
|-------------|----------------|
| Chrome | LRS-C01 |
| White | LRS-C01-WHT |
| Yellow | LRS-C01-YEL |
| Orange | LRS-C01-ORG |
| Dark Green | LRS-C01-DGR |
| Red | LRS-C01-RED |
| Dark Blue | LRS-C01-DBL |
| Light Blue | LRS-C01-LBL |
| Light Green | LRS-C01-LGR |
| Brown | LRS-C01-BRN |
| Pink | LRS-C01-PNK |
| Black | LRS-C01-BLK |

Panel Mount Angle Base, 30° Nozzle

- Solid brass angle fitting base
- Choice of finishes
- 3/8" - 18 NPT male thread shank assembly

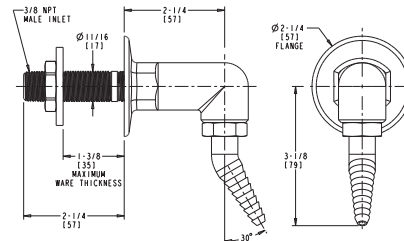

| Finish | Model Number |
|-------------|----------------|
| Chrome | LRS-C02 |
| White | LRS-C02-WHT |
| Yellow | LRS-C02-YEL |
| Orange | LRS-C02-ORG |
| Dark Green | LRS-C02-DGR |
| Red | LRS-C02-RED |
| Dark Blue | LRS-C02-DBL |
| Light Blue | LRS-C02-LBL |
| Light Green | LRS-C02-LGR |
| Brown | LRS-C02-BRN |
| Pink | LRS-C02-PNK |
| Black | LRS-C02-BLK |

Deck Mount Turret Base, Straight Nozzle

- Solid brass turret base
- Choice of finishes
- 3/8" - 18 NPT male thread shank assembly

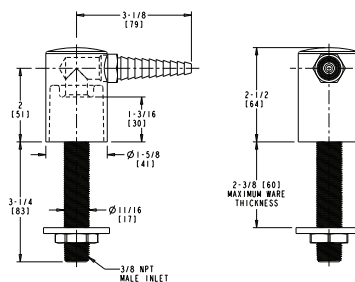

| Finish | Model Number |
|-------------|----------------|
| Chrome | LRS-D01 |
| White | LRS-D01-WHT |
| Yellow | LRS-D01-YEL |
| Orange | LRS-D01-ORG |
| Dark Green | LRS-D01-DGR |
| Red | LRS-D01-RED |
| Dark Blue | LRS-D01-DBL |
| Light Blue | LRS-D01-LBL |
| Light Green | LRS-D01-LGR |
| Brown | LRS-D01-BRN |
| Pink | LRS-D01-PNK |
| Black | LRS-D01-BLK |

Deck Mount Turret Base, 30° Nozzle

- Solid brass turret base
- Choice of finishes
- 3/8" - 18 NPT male thread shank assembly

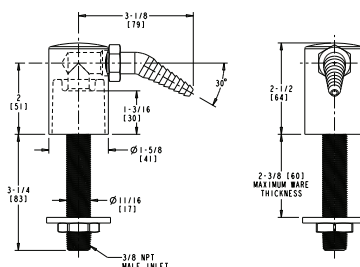

| Finish | Model Number |
|-------------|----------------|
| Chrome | LRS-D02 |
| White | LRS-D02-WHT |
| Yellow | LRS-D02-YEL |
| Orange | LRS-D02-ORG |
| Dark Green | LRS-D02-DGR |
| Red | LRS-D02-RED |
| Dark Blue | LRS-D02-DBL |
| Light Blue | LRS-D02-LBL |
| Light Green | LRS-D02-LGR |
| Brown | LRS-D02-BRN |
| Pink | LRS-D02-PNK |
| Black | LRS-D02-BLK |

Panel Mount Angle Base with Gooseneck Spout

- Solid brass angle fitting base
- 5-1/4" rigid/swing gooseneck spout
- Choice of finishes
- 3/8" - 18 NPT male thread shank assembly

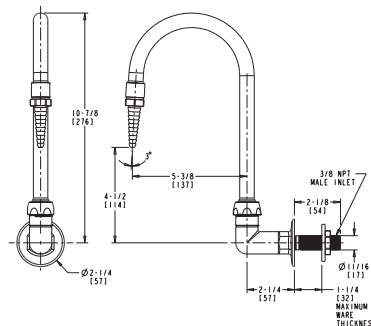

| Finish | Model Number |
|-------------|----------------|
| Chrome | LRS-C11 |
| White | LRS-C11-WHT |
| Yellow | LRS-C11-YEL |
| Orange | LRS-C11-ORG |
| Dark Green | LRS-C11-DGR |
| Red | LRS-C11-RED |
| Dark Blue | LRS-C11-DBL |
| Light Blue | LRS-C11-LBL |
| Light Green | LRS-C11-LGR |
| Brown | LRS-C11-BRN |
| Pink | LRS-C11-PNK |
| Black | LRS-C11-BLK |

Panel Mount Angle Base with Gooseneck Spout

- Solid brass angle fitting base
- 6" rigid/swing gooseneck spout with vacuum breaker
- Choice of finishes
- 3/8" - 18 NPT male thread shank assembly

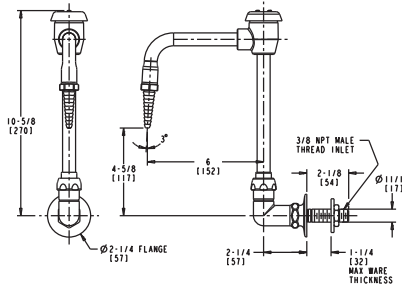

| Finish | Model Number |
|-------------|----------------|
| Chrome | LRS-C21 |
| White | LRS-C21-WHT |
| Yellow | LRS-C21-YEL |
| Orange | LRS-C21-ORG |
| Dark Green | LRS-C21-DGR |
| Red | LRS-C21-RED |
| Dark Blue | LRS-C21-DBL |
| Light Blue | LRS-C21-LBL |
| Light Green | LRS-C21-LGR |
| Brown | LRS-C21-BRN |
| Pink | LRS-C21-PNK |
| Black | LRS-C21-BLK |

Panel Mount Turret Base with Gooseneck Spout

- Solid brass turret base
- 5-1/4" rigid/swing gooseneck spout
- Choice of finishes
- 3/8" - 18 NPT male thread shank assembly

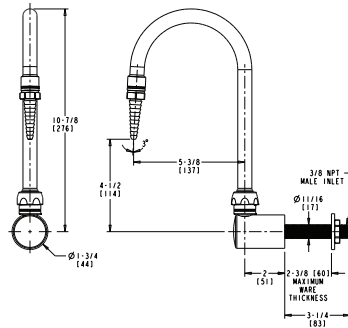

| Finish | Model Number |
|-------------|----------------|
| Chrome | LRS-D11 |
| White | LRS-D11-WHT |
| Yellow | LRS-D11-YEL |
| Orange | LRS-D11-ORG |
| Dark Green | LRS-D11-DGR |
| Red | LRS-D11-RED |
| Dark Blue | LRS-D11-DBL |
| Light Blue | LRS-D11-LBL |
| Light Green | LRS-D11-LGR |
| Brown | LRS-D11-BRN |
| Pink | LRS-D11-PNK |
| Black | LRS-D11-BLK |

Panel Mount Turret Base with Gooseneck Spout

- Solid brass turret base
- 6" rigid/swing gooseneck spout with vacuum breaker
- Choice of finishes
- 3/8" - 18 NPT male thread shank assembly

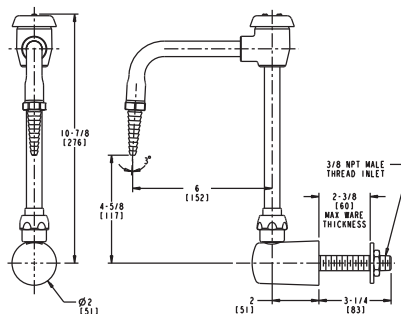

| Finish | Model Number |
|-------------|----------------|
| Chrome | LRS-D21 |
| White | LRS-D21-WHT |
| Yellow | LRS-D21-YEL |
| Orange | LRS-D21-ORG |
| Dark Green | LRS-D21-DGR |
| Red | LRS-D21-RED |
| Dark Blue | LRS-D21-DBL |
| Light Blue | LRS-D21-LBL |
| Light Green | LRS-D21-LGR |
| Brown | LRS-D21-BRN |
| Pink | LRS-D21-PNK |
| Black | LRS-D21-BLK |

Deck Mount Turret Base with Gooseneck Spout

- Solid brass turret base
- 5-1/4" rigid/swing gooseneck spout
- Choice of finishes
- 3/8" - 18 NPT male thread assembly

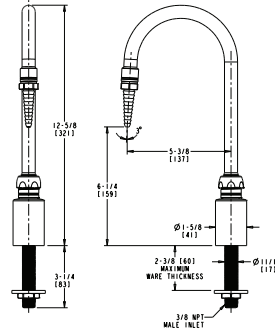

| Finish | Model Number |
|-------------|----------------|
| Chrome | LRS-E11 |
| White | LRS-E11-WHT |
| Yellow | LRS-E11-YEL |
| Orange | LRS-E11-ORG |
| Dark Green | LRS-E11-DGR |
| Red | LRS-E11-RED |
| Dark Blue | LRS-E11-DBL |
| Light Blue | LRS-E11-LBL |
| Light Green | LRS-E11-LGR |
| Brown | LRS-E11-BRN |
| Pink | LRS-E11-PNK |
| Black | LRS-E11-BLK |

Deck Mount Turret Base with Gooseneck Spout

- Forged brass turret base
- 6" rigid/swing gooseneck spout with vacuum breaker
- Choice of finishes
- 3/8" - 18 NPT male thread assembly

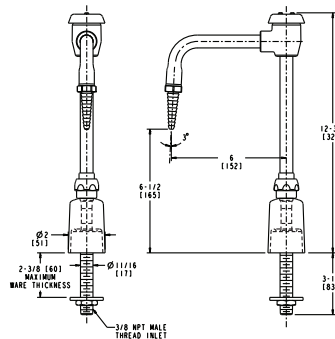

| Finish | Model Number |
|-------------|----------------|
| Chrome | LRS-E21 |
| White | LRS-E21-WHT |
| Yellow | LRS-E21-YEL |
| Orange | LRS-E21-ORG |
| Dark Green | LRS-E21-DGR |
| Red | LRS-E21-RED |
| Dark Blue | LRS-E21-DBL |
| Light Blue | LRS-E21-LBL |
| Light Green | LRS-E21-LGR |
| Brown | LRS-E21-BRN |
| Pink | LRS-E21-PNK |
| Black | LRS-E21-BLK |

How to build and order a Chicago Faucets laboratory water remote valve.

Chicago Faucets makes it easy for you to build remote valves that meet your exact requirements. You can reference the charts on the following pages or you can build your own fitting by using the chart below to configure your model number.







LRV-W A - B C D
 (Lab Remote Valve - Water)

EXAMPLE



LRV-W2-A1A
 Water valve with left hand 45° angle base, compression cartridges, metal cross handle with cold index button.

Base

| | | | | | | |
|---|--|--|--|--|---|--|
| A |  1 |  2 |  3 |  4 |  5 |  6 |
| | RH 45° Angle | LH 45° Angle | Concealed Valve with Escutcheon | Concealed Valve | Angle Valve for Straight Panels | Angle Valve for 45° Angle Panels |

Cartridge

| | |
|---|---|
| B |  A |
| | Compression |

Handle

| | | |
|---|---|---|
| C |  1 |  2 |
| | Metal Cross | Plastic Cross |

Button

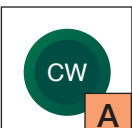
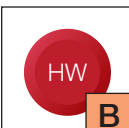
| | | |
|---|---|---|
| D |  A |  B |
| | Plastic, "CW" Index | Plastic, "HW" Index |

How to build and order a Chicago Faucets laboratory steam remote valve.

Chicago Faucets makes it easy for you to build remote valves that meet your exact requirements. You can reference the charts on the following pages or you can build your own fitting by using the chart below to configure your model number.

LRV-S A - B C D
 (Lab Remote Valve - Steam)

EXAMPLE



LRV-S2-A1A
 Steam valve with left hand 45° angle base, compression cartridges, plastic cross handle with steam index button.

Base

A



RH 45° Angle



LH 45° Angle



Concealed Valve

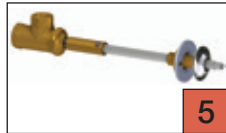

Angle Valve for Straight Panels

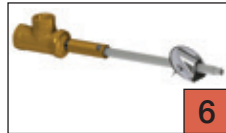

Angle Valve for 45° Angle Panels

Cartridge

B

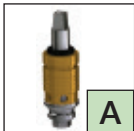

Slow Compression Steam

Handle

C

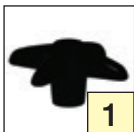

Plastic Cross

Button

D

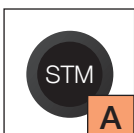

Plastic, "STM" Index

How to build and order a Chicago Faucets laboratory remote needle valve.

Chicago Faucets makes it easy for you to build remote valves that meet your exact requirements. You can reference the charts on the following pages or you can build your own fitting by using the chart below to configure your model number.

LRV-N A - B C D

(Lab Remote Valve - Needle)

EXAMPLE



LRV-N2-A1D
Needle valve with left hand 45° angle base, compression cartridge, metal cross handle with NIT index button.

Base

A



RH 45° Angle



LH 45° Angle

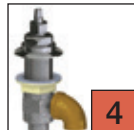

Concealed Valve



Angle Valve for Straight Panels

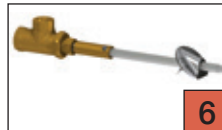

Angle Valve for 45° Angle Panels

Cartridge

B

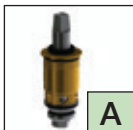

Needle Compression

Handle

C



Metal Cross



Plastic Cross

Button

D

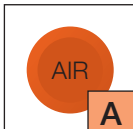

Plastic, "AIR" Index

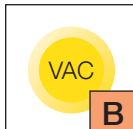

Plastic, "VAC" Index

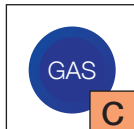

Plastic, "GAS" Index

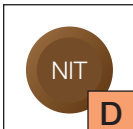

Plastic, "NIT" Index

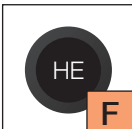

Plastic, "HE" Index

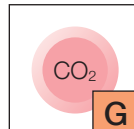

Plastic, "CO2" Index

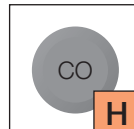

Plastic, "CO" Index

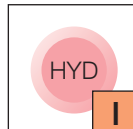

Plastic, "HYD" Index

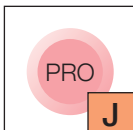

Plastic, "PRO" Index

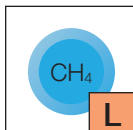

Plastic, "CH4" Index

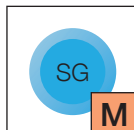

Plastic, "SG" Index

How to build and order a Chicago Faucets laboratory remote fine needle valve.

Chicago Faucets makes it easy for you to build remote valves that meet your exact requirements. You can reference the charts on the following pages or you can build your own fitting by using the chart below to configure your model number.

LRV-F A - B C D
 (Lab Remote Valve - Fine Needle)

EXAMPLE



LRV-F2-A1F

Fine needle valve with left hand 45° angle base, compression cartridge, metal cross handle with HE index button.

Base

A



RH 45° Angle

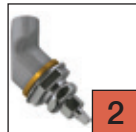

LH 45° Angle



Concealed Valve



Angle Valve for Straight Panels



Angle Valve for 45° Angle Panels

Cartridge

B

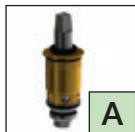

Fine Needle Compression

Handle

C



Metal Cross

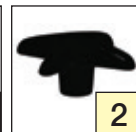

Plastic Cross

Button

D

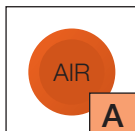

Plastic, "AIR" Index

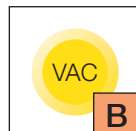

Plastic, "VAC" Index

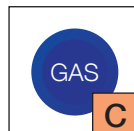

Plastic, "GAS" Index

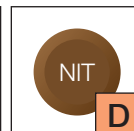

Plastic, "NIT" Index

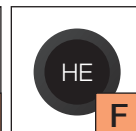

Plastic, "HE" Index

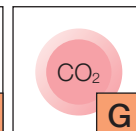

Plastic, "CO₂" Index

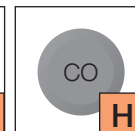

Plastic, "CO" Index

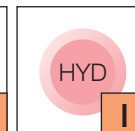

Plastic, "HYD" Index

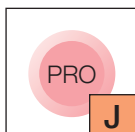

Plastic, "PRO" Index

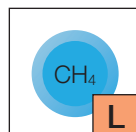

Plastic, "CH₄" Index

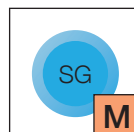

Plastic, "SG" Index

Water Valve, Right Hand 45° Angle

- Solid brass right hand 45° angle base
- Compression cartridge
- 3/8" NPT female thread inlet and outlet



| Button | Metal Cross Handle | Plastic Cross Handle |
|------------|--------------------|----------------------|
| Cold Water | LRV-W1-A1A | LRV-W1-A2A |
| Hot Water | LRV-W1-A1B | LRV-W1-A2B |

Water Valve, Left Hand 45° Angle

- Solid brass left hand 45° angle base
- Compression cartridge
- 3/8" NPT female thread inlet and outlet



| Button | Metal Cross Handle | Plastic Cross Handle |
|------------|--------------------|----------------------|
| Cold Water | LRV-W2-A1A | LRV-W2-A2A |
| Hot Water | LRV-W2-A1B | LRV-W2-A2B |

Water Valve, Concealed with Escutcheon

- Solid brass concealed valve
- Compression cartridge
- 1/2" NPSM coupling nut for 3/8" or 1/2" flexible risers inlet
- 13/16" - 14 UNS to fit 1/2" OD copper or sweat connection outlet



| Button | Metal Cross Handle | Plastic Cross Handle |
|------------|--------------------|----------------------|
| Cold Water | LRV-W3-A1A | LRV-W3-A2A |
| Hot Water | LRV-W3-A1B | LRV-W3-A2B |

Water Valve, Concealed Valve

- Solid brass concealed valve
- Compression cartridge
- 3/8" NPT female thread inlet and outlet



| Button | Metal Cross Handle | Plastic Cross Handle |
|------------|--------------------|----------------------|
| Cold Water | LRV-W4-A1A | LRV-W4-A2A |
| Hot Water | LRV-W4-A1B | LRV-W4-A2B |

Angle Water Valve, for Straight Panels

- Solid brass angle valve for straight panels
- Compression cartridge
- 3/8" NPT female thread inlet and outlet



| Button | Metal Cross Handle | Plastic Cross Handle |
|------------|--------------------|----------------------|
| Cold Water | LRV-W5-A1A | LRV-W5-A2A |
| Hot Water | LRV-W5-A1B | LRV-W5-A2B |

Angle Water Valve, for 45° Angle Panels

- Solid brass angle valve for 45° angle panels
- Compression cartridge
- 3/8" NPT female thread inlet and outlet



| Button | Metal Cross Handle | Plastic Cross Handle |
|------------|--------------------|----------------------|
| Cold Water | LRV-W6-A1A | LRV-W6-A2A |
| Hot Water | LRV-W6-A1B | LRV-W6-A2B |

Steam Valve, Right Hand 45° Angle

- Solid brass right hand 45° angle base
- Slow compression steam cartridge
- 3/8" NPT female thread inlet and outlet



| Model |
|------------|
| LRV-S1-A1A |

Steam Valve, Left Hand 45° Angle

- Solid brass left hand 45° angle base
- Slow compression steam cartridge
- 3/8" NPT female thread inlet and outlet
- Plastic cross handle
- Steam index button



| Model |
|------------|
| LRV-S2-A1A |

Steam Valve, Concealed Valve

- Solid brass concealed valve
- Slow compression steam cartridge
- 3/8" NPT female thread inlet and outlet
- Plastic cross handle
- Steam index button



| Model |
|------------|
| LRV-S4-A1A |

Angle Steam Valve, for Straight Panels

- Solid brass angle valve for straight panels
- Slow compression steam cartridge
- 3/8" NPT female thread inlet and outlet
- Plastic cross handle
- Steam index button



| Model |
|------------|
| LRV-S5-A1A |

Angle Steam Valve, for 45° Angle Panels

- Solid brass angle valve for 45° angle panels
- Slow compression steam cartridge
- 3/8" NPT female thread inlet and outlet
- Plastic cross handle
- Steam index button



| Model |
|------------|
| LRV-S6-A1A |

Needle Valve, Right Hand 45° Angle

- Solid brass right hand 45° angle base
- Compression cartridge
- 3/8" NPT female thread inlet and outlet



| Button | Metal Cross Handle | Plastic Cross Handle |
|--------|--------------------|----------------------|
| AIR | LRV-N1-A1A | LRV-N1-A2A |
| VAC | LRV-N1-A1B | LRV-N1-A2B |
| GAS | LRV-N1-A1C | LRV-N1-A2C |
| NIT | LRV-N1-A1D | LRV-N1-A2D |
| HE | LRV-N1-A1F | LRV-N1-A2F |
| CO2 | LRV-N1-A1G | LRV-N1-A2G |
| CO | LRV-N1-A1H | LRV-N1-A2H |
| HYD | LRV-N1-A1I | LRV-N1-A2I |
| PRO | LRV-N1-A1J | LRV-N1-A2J |
| CH4 | LRV-N1-A1L | LRV-N1-A2L |
| SG | LRV-N1-A1M | LRV-N1-A2M |

Needle Valve, Left Hand 45° Angle

- Solid brass left hand 45° angle base
- Compression cartridge
- 3/8" NPT female thread inlet and outlet



| Button | Metal Cross Handle | Plastic Cross Handle |
|--------|--------------------|----------------------|
| AIR | LRV-N2-A1A | LRV-N2-A2A |
| VAC | LRV-N2-A1B | LRV-N2-A2B |
| GAS | LRV-N2-A1C | LRV-N2-A2C |
| NIT | LRV-N2-A1D | LRV-N2-A2D |
| HE | LRV-N2-A1F | LRV-N2-A2F |
| CO2 | LRV-N2-A1G | LRV-N2-A2G |
| CO | LRV-N2-A1H | LRV-N2-A2H |
| HYD | LRV-N2-A1I | LRV-N2-A2I |
| PRO | LRV-N2-A1J | LRV-N2-A2J |
| CH4 | LRV-N2-A1L | LRV-N2-A2L |
| SG | LRV-N2-A1M | LRV-N2-A2M |

Needle Valve, Concealed Valve

- Solid brass concealed valve
- Compression cartridge
- 3/8" NPT female thread inlet and outlet



| Button | Metal Cross Handle | Plastic Cross Handle |
|--------|--------------------|----------------------|
| AIR | LRV-N4-A1A | LRV-N4-A2A |
| VAC | LRV-N4-A1B | LRV-N4-A2B |
| GAS | LRV-N4-A1C | LRV-N4-A2C |
| NIT | LRV-N4-A1D | LRV-N4-A2D |
| HE | LRV-N4-A1F | LRV-N4-A2F |
| CO2 | LRV-N4-A1G | LRV-N4-A2G |
| CO | LRV-N4-A1H | LRV-N4-A2H |
| HYD | LRV-N4-A1I | LRV-N4-A2I |
| PRO | LRV-N4-A1J | LRV-N4-A2J |
| CH4 | LRV-N4-A1L | LRV-N4-A2L |
| SG | LRV-N4-A1M | LRV-N4-A2M |

Angle Needle Valve, for Straight Panels

- Solid brass angle valve for straight panels
- Compression cartridge
- 3/8" NPT female thread inlet and outlet



| Button | Metal Cross Handle | Plastic Cross Handle |
|--------|--------------------|----------------------|
| AIR | LRV-N5-A1A | LRV-N5-A2A |
| VAC | LRV-N5-A1B | LRV-N5-A2B |
| GAS | LRV-N5-A1C | LRV-N5-A2C |
| NIT | LRV-N5-A1D | LRV-N5-A2D |
| HE | LRV-N5-A1F | LRV-N5-A2F |
| CO2 | LRV-N5-A1G | LRV-N5-A2G |
| CO | LRV-N5-A1H | LRV-N5-A2H |
| HYD | LRV-N5-A1I | LRV-N5-A2I |
| PRO | LRV-N5-A1J | LRV-N5-A2J |
| CH4 | LRV-N5-A1L | LRV-N5-A2L |
| SG | LRV-N5-A1M | LRV-N5-A2M |

Angle Needle Valve, for 45° Angle Panels

- Solid brass angle valve for 45° angle panels
- Compression cartridge
- 3/8" NPT female thread inlet and outlet



| Button | Metal Cross Handle | Plastic Cross Handle |
|--------|--------------------|----------------------|
| AIR | LRV-N6-A1A | LRV-N6-A2A |
| VAC | LRV-N6-A1B | LRV-N6-A2B |
| GAS | LRV-N6-A1C | LRV-N6-A2C |
| NIT | LRV-N6-A1D | LRV-N6-A2D |
| HE | LRV-N6-A1F | LRV-N6-A2F |
| CO2 | LRV-N6-A1G | LRV-N6-A2G |
| CO | LRV-N6-A1H | LRV-N6-A2H |
| HYD | LRV-N6-A1I | LRV-N6-A2I |
| PRO | LRV-N6-A1J | LRV-N6-A2J |
| CH4 | LRV-N6-A1L | LRV-N6-A2L |
| SG | LRV-N6-A1M | LRV-N6-A2M |

Fine Needle Valve, Right Hand 45° Angle

- Solid brass right hand 45° angle base
- Compression cartridge
- 3/8" NPT female thread inlet and outlet



| Button | Metal Cross Handle | Plastic Cross Handle |
|--------|--------------------|----------------------|
| AIR | LRV-F1-A1A | LRV-F1-A2A |
| VAC | LRV-F1-A1B | LRV-F1-A2B |
| GAS | LRV-F1-A1C | LRV-F1-A2C |
| NIT | LRV-F1-A1D | LRV-F1-A2D |
| HE | LRV-F1-A1F | LRV-F1-A2F |
| CO2 | LRV-F1-A1G | LRV-F1-A2G |
| CO | LRV-F1-A1H | LRV-F1-A2H |
| HYD | LRV-F1-A1I | LRV-F1-A2I |
| PRO | LRV-F1-A1J | LRV-F1-A2J |
| CH4 | LRV-F1-A1L | LRV-F1-A2L |
| SG | LRV-F1-A1M | LRV-F1-A2M |

Fine Needle Valve, Left Hand 45° Angle

- Solid brass left hand 45° angle base
- Compression cartridge
- 3/8" NPT female thread inlet and outlet



| Button | Metal Cross Handle | Plastic Cross Handle |
|--------|--------------------|----------------------|
| AIR | LRV-F2-A1A | LRV-F2-A2A |
| VAC | LRV-F2-A1B | LRV-F2-A2B |
| GAS | LRV-F2-A1C | LRV-F2-A2C |
| NIT | LRV-F2-A1D | LRV-F2-A2D |
| HE | LRV-F2-A1F | LRV-F2-A2F |
| CO2 | LRV-F2-A1G | LRV-F2-A2G |
| CO | LRV-F2-A1H | LRV-F2-A2H |
| HYD | LRV-F2-A1I | LRV-F2-A2I |
| PRO | LRV-F2-A1J | LRV-F2-A2J |
| CH4 | LRV-F2-A1L | LRV-F2-A2L |
| SG | LRV-F2-A1M | LRV-F2-A2M |

Fine Needle Valve, Concealed Valve

- Solid brass concealed valve
- Compression cartridge
- 3/8" NPT female thread inlet and outlet



| Button | Metal Cross Handle | Plastic Cross Handle |
|--------|--------------------|----------------------|
| AIR | LRV-F4-A1A | LRV-F4-A2A |
| VAC | LRV-F4-A1B | LRV-F4-A2B |
| GAS | LRV-F4-A1C | LRV-F4-A2C |
| NIT | LRV-F4-A1D | LRV-F4-A2D |
| HE | LRV-F4-A1F | LRV-F4-A2F |
| CO2 | LRV-F4-A1G | LRV-F4-A2G |
| CO | LRV-F4-A1H | LRV-F4-A2H |
| HYD | LRV-F4-A1I | LRV-F4-A2I |
| PRO | LRV-F4-A1J | LRV-F4-A2J |
| CH4 | LRV-F4-A1L | LRV-F4-A2L |
| SG | LRV-F4-A1M | LRV-F4-A2M |

Angle Fine Needle Valve, for Straight Panels

- Solid brass angle valve for straight panels
- Compression cartridge
- 3/8" NPT female thread inlet and outlet



| Button | Metal Cross Handle | Plastic Cross Handle |
|--------|--------------------|----------------------|
| AIR | LRV-F5-A1A | LRV-F5-A2A |
| VAC | LRV-F5-A1B | LRV-F5-A2B |
| GAS | LRV-F5-A1C | LRV-F5-A2C |
| NIT | LRV-F5-A1D | LRV-F5-A2D |
| HE | LRV-F5-A1F | LRV-F5-A2F |
| CO2 | LRV-F5-A1G | LRV-F5-A2G |
| CO | LRV-F5-A1H | LRV-F5-A2H |
| HYD | LRV-F5-A1I | LRV-F5-A2I |
| PRO | LRV-F5-A1J | LRV-F5-A2J |
| CH4 | LRV-F5-A1L | LRV-F5-A2L |
| SG | LRV-F5-A1M | LRV-F5-A2M |

Angle Fine Needle Valve, for 45° Angle Panels

- Solid brass angle valve for 45° angle panels
- Compression cartridge
- 3/8" NPT female thread inlet and outlet



| Button | Metal Cross Handle | Plastic Cross Handle |
|--------|--------------------|----------------------|
| AIR | LRV-F6-A1A | LRV-F6-A2A |
| VAC | LRV-F6-A1B | LRV-F6-A2B |
| GAS | LRV-F6-A1C | LRV-F6-A2C |
| NIT | LRV-F6-A1D | LRV-F6-A2D |
| HE | LRV-F6-A1F | LRV-F6-A2F |
| CO2 | LRV-F6-A1G | LRV-F6-A2G |
| CO | LRV-F6-A1H | LRV-F6-A2H |
| HYD | LRV-F6-A1I | LRV-F6-A2I |
| PRO | LRV-F6-A1J | LRV-F6-A2J |
| CH4 | LRV-F6-A1L | LRV-F6-A2L |
| SG | LRV-F6-A1M | LRV-F6-A2M |

Single Gang Electrical Boxes

- For 120 volt service
- 3/4" NPSM male mounting shank assembly



| Single Face | Double Face |
|-----------------|-----------------|
| 1310-BAF | 1311-BAF |
| 1310-BLK | 1311-BLK |
| 1310-WHT | 1311-WHT |

Double Gang Electrical Boxes

- For 120 volt service
- 3/4" NPSM male mounting shank assembly



| Single Face | Double Face |
|-----------------|-----------------|
| 1312-BAF | 1313-BAF |
| 1312-BLK | 1313-BLK |
| 1312-WHT | 1313-WHT |

Rods

- Choice of aluminum upright or crossbar



| Dimensions | Upright | Crossbar |
|------------|----------------|----------|
| 3/4" x 24" | 9911-NF | 9906-NF |
| 3/4" x 36" | 9902-NF | 9903-NF |
| 3/4" x 39" | – | 9905-NF |
| 3/4" x 48" | 9912-NF | 9907-NF |

Aluminum Burette Rod Sockets

- Choice of 3/4" recessed or countertop mount



| Recessed Mount | Countertop Mount |
|----------------|------------------|
| 9901-NF | 9913-NF |

Aluminum Adjustable Clamp

- Used to secure upright and crossbar rods



| |
|-----------------------|
| 3/4" Adjustable Clamp |
| 9904-NF |

Deck Mounted Eye/Face Wash with Push Paddle Handle

- 1/2" NPT male thread inlet
- Anti-corrosive polyamide 11 plastic coating in high-visibility yellow color
- Eyewash assembly in ABS plastic
- Two high-flow aerated water spray heads operate at low pressure with automatic opening anti-dust covers

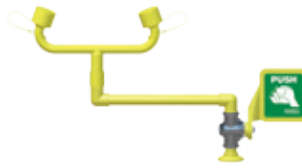

| Left Hand Operation | Right Hand Operation |
|---------------------|----------------------|
| 8404-LHNF | 8404-RHNF |

Deck Mounted Swing Down Eye/Face Wash

- 1/2" NPT male thread inlet
- Anti-corrosive polyamide 11 plastic coating in high-visibility yellow color
- Eyewash assembly in ABS plastic
- Two high-flow aerated water spray heads operate at low pressure with automatic opening anti-dust covers

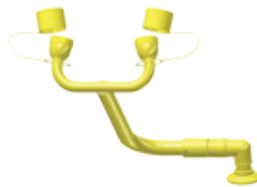

| Vertical Swing Down Operation | Horizontal Swing Operation |
|-------------------------------|----------------------------|
| 8410-NF | 8411-NF |

Wall Mounted Eye/Face Wash with Push Paddle Handle

- 1/2" NPT female thread inlet
- Anti-corrosive polyamide 11 plastic coating in high-visibility yellow color
- Eyewash assembly in ABS plastic
- Eyewash bowl in stainless steel or ABS plastic
- Two high-flow aerated water spray heads operate at low pressure with automatic opening anti-dust covers



| Eyewash Bowl In Stainless Steel | Eyewash Bowl In ABS Plastic |
|---------------------------------|-----------------------------|
| 8401-NF | 8408-NF |

Single Outlet Eye/Face/Body Drench Hose

- 1/2" NPT male thread inlet
- Anti-corrosive polyamide 11 plastic coating in high-visibility yellow color
- Eyewash assembly in ABS plastic
- High-flow aerated water spray at low pressure with automatic opening anti-dust cover
- Lever handle for actuation
- 59" Flexible hose in stainless steel



| Deck Mounted | Wall Mounted |
|----------------|----------------|
| 8407-NF | 8409-NF |

Floor Mounted Eye/Face Wash with Push Paddle Handle

- 1/2" NPT female thread inlet
- 1-1/4" NPT female waste outlet
- Anti-corrosive polyamide 11 plastic coating in high-visibility yellow color
- Eyewash assembly in ABS plastic
- Eyewash bowl in stainless steel
- Two high-flow aerated water spray heads operate at low pressure with automatic opening anti-dust covers



| |
|----------------|
| Eye/Face Wash |
| 8403-NF |

Floor Mounted Combination Eye/Face Wash and Safety Drench Shower

- 1-1/4" NPT female thread inlet
- 1-1/4" NPT female thread outlet
- Anti-corrosive polyamide 11 plastic coating in high-visibility yellow color
- Eyewash assembly in ABS plastic
- Eyewash bowl in stainless steel
- Two high-flow aerated water spray heads operate at low pressure with automatic opening anti-dust covers
- Pull rod for activation



| Shower Head in Stainless Steel | Shower Head in ABS Plastic | Wheel Chair Accessible Shower Head in ABS Plastic |
|--------------------------------|----------------------------|---|
| 8402-NF | 8405-NF | 8416-NF |

Drench Showers

- 1" NPT male thread inlet
- Anti-corrosive polyamide 11 plastic coating in high-visibility yellow color
- Horizontal wall mounted
- Pull rod for activation



| Shower Head in ABS Plastic | Shower Head in Stainless Steel |
|----------------------------|--------------------------------|
| 8400-NF | 8421-NF |

Barrier Free, Recessed Eye/Face Wash and Safety Drench Shower

- 1" NPT male thread inlet (supply connections)
- 1-1/2" NPT male thread inlet (drain connection)
- Anti-corrosive polyamide 11 plastic coating in high-visibility yellow color
- Eyewash assembly in ABS plastic
- Eyewash bowl in stainless steel
- Two high-flow aerated water spray heads operate at low pressure with automatic opening anti-dust covers
- Pull handle for activation
- Shower head in stainless steel
- Wall recessed mounting



| |
|------------------------|
| Wheel Chair Accessible |
| 8420-NF |



We are a member of the U.S. Green Building Council and support the Leadership in Energy and Environmental Design (LEED) Green Building Rating System™, to measure the efficiency and sustainability of buildings in the U.S. and Canada. If you are trying to achieve LEED Certification for your building, our low-flow outlets, metering cartridges, and sensor-operated faucets can contribute points in these areas: Water Efficiency Credit 2: Innovative Wastewater Technologies and Water Efficiency Credit 3: Water Use Reduction



We are proud to be a partner with WaterSense®, sponsored by the EPA and designed to protect the future of our nation's water supply by promoting efficiency and enhancing the market for water efficient products, programs, and practices.



We are a charter sponsor of the Alliance for Water Efficiency, a non-profit organization that is dedicated to the efficient and sustainable use of water. It brings together a diverse range of stakeholders to advocate water efficiency and conservation.



Geberit Group

Chicago Faucets, a member of the Geberit Group, is the leading brand of commercial faucets and fittings in the United States, offering a complete range of products for schools, laboratories, hospitals, office buildings, food service, airports, and sports facilities. Whatever your requirements may be, Chicago Faucets offers standard and made-to-order products that are designed to meet any commercial application.

The Chicago Faucet Company
 2100 South Clearwater Drive
 Des Plaines, IL 60018
 Phone: 847/803-5000
 Fax: 847/803-5454
 Technical: 800/832-8783
www.chicagofaucets.com

