



Centrotherm  
solutions beyond

Fall 2021

# Product Catalog and Dimensional Data



**UL-1738**  
**ULC-S636**



**CE EN 14471 - TUV**

<http://centrotherm.us.com>

518.434.3400

[info@centrotherm.us.com](mailto:info@centrotherm.us.com)

# About Centrotherm



Centrotherm  
solutions beyond

## Worldwide

With a mission to 'Never Compromise the Future', the Ubbink-Centrotherm Group (UCG) is committed to developing and manufacturing sustainable products for the plumbing, heating, and building products markets. Centrotherm explores ways to improve our world by taking a collaborative approach to creating intelligent building solutions.

The UCG is the building products division of CENTROTEC Sustainable, A.G., one of Europe's leading manufacturers of sustainable building solutions. With a rich history dating back to 1896, Ubbink combined with Centrotherm in 2000 to create the Ubbink-Centrotherm Group (UCG). In addition to **Centrotherm Eco Systems** in the United States, the UCG has subsidiaries in the United Kingdom, France, Italy, Belgium, The Netherlands, Germany, and China.

In North America, **Centrotherm Eco Systems** now produces its **InnoFlue®** Polypropylene Vent Systems, BlitzFlex® air-intake systems, and accessories based on a wealth of technical know-how and accumulated experience. Field proven for over 20 years, Centrotherm products have been installed and are performing successfully in millions of homes in the North American, European, and Asian markets today.

Working with a network of manufacturer's representatives, **Centrotherm Eco Systems** supplies its **InnoFlue®** Polypropylene Vent Systems, BlitzFlex® air-intake systems, and accessories to heating professionals through heating and plumbing wholesalers, and to OEMs.



**InnoFlue®** is the first polymeric vent system tested and listed to ULC-S636 and UL-1738 in North America



Centrotherm Eco Systems Albany, New York



Centrotherm Systemtechnik GmbH Brilon, Germany

In addition to vent systems, **Centrotherm Eco Systems** designs, produces, and delivers internal componentry to many international high efficiency boiler, tankless water heater, and furnace manufacturers.

Relentless attention to customer needs has driven **Centrotherm Eco Systems** to be the innovation and safety leader in flue gas venting and combustion air technology and Centrotherm continues to focus on "constructing the future" by creating circular building solutions for the generations to come.

**Centrotherm** has set a tradition of groundbreaking industry firsts, including

- ULC-S636 and UL-1738 listed vent system
- Vent manufacturer to earn ISO 9001:2015
- North American extrusion of polypropylene vent systems
- Dedicated air-intake systems
- 1/4" per foot pitch
- 10' effective vent lengths
- Industry leading commercial polypropylene products

**For more information about Centrotherm Eco Systems, visit [www.centrotherm.us.com](http://www.centrotherm.us.com)**



**Table of Contents**

**About**

**Centrotherm** \_\_\_\_\_ **2**

**Worldwide** \_\_\_\_\_ **2**

**InnoFlue®** \_\_\_\_\_ **6**

**The intelligent alternative to PVC & CPVC** \_\_\_\_\_ **6**

**Why InnoFlue®?** \_\_\_\_\_ **7**

**Applications and Limitations** \_\_\_\_\_ **8**

**More Resources** \_\_\_\_\_ **9**

**QR Code Library** \_\_\_\_\_ **9**

**InnoFlue Quick Guide** \_\_\_\_\_ **10**

**InnoFlue Condensate Quick Guide** \_\_\_\_\_ **10**

**Single Wall - Small Diameter** \_\_\_\_\_ **12**

**Typical Configurations** \_\_\_\_\_ **13**

**Appliance Adaptors** \_\_\_\_\_ **14**

Appliance Adaptor for Coupler Style Flue Collars \_\_\_\_\_ 14

Appliance Adaptor for Flue Collar with Hose Clamp \_\_\_\_\_ 14

Appliance Adaptor Tapered SS to InnoFlue® \_\_\_\_\_ 14

Appliance Adaptor Straight SS to InnoFlue® \_\_\_\_\_ 14

Appliance Adaptors 101mm to PPs \_\_\_\_\_ 15

Custom Appliance Adaptors \_\_\_\_\_ 15

**Increasers & Reducers** \_\_\_\_\_ **15**

Eccentric Increaser \_\_\_\_\_ 15

Centric Increaser \_\_\_\_\_ 15

3/2" Reducer \_\_\_\_\_ 16

Reducers \_\_\_\_\_ 16

**Test Ports** \_\_\_\_\_ **16**

Test Ports \_\_\_\_\_ 16

**Vent Lengths** \_\_\_\_\_ **17**

Rigid Vent Length \_\_\_\_\_ 17

**Base Supports** \_\_\_\_\_ **17**

Base Support \_\_\_\_\_ 17

Base Support Bracket \_\_\_\_\_ 18

**Elbows and Tees** \_\_\_\_\_ **18**

15° Elbow \_\_\_\_\_ 18

30° Elbow \_\_\_\_\_ 18

45° Short Radius Elbow \_\_\_\_\_ 18

87° Short Radius Long \_\_\_\_\_ 19

87° Long Radius Elbow \_\_\_\_\_ 19

Tee \_\_\_\_\_ 19

Tee Cap \_\_\_\_\_ 20

**Condensate Management** \_\_\_\_\_ **20**

Horizontal Drain Tee \_\_\_\_\_ 20

Tee Cap with Drain \_\_\_\_\_ 20

Universal Ball Valve Siphon \_\_\_\_\_ 20

**Small Diameter Single Wall Vent Kits** \_\_\_\_\_ **21**

Horizontal Vent Kit \_\_\_\_\_ 21

InnoFlue Quick Kit (Wall) \_\_\_\_\_ 21

InnoFlue Quick Kit (Roof) \_\_\_\_\_ 21

**Terminations** \_\_\_\_\_ **22**

Chimney Cover PPs-UV \_\_\_\_\_ 22

Chimney Cover SS W/PPs-UV End Pipe \_\_\_\_\_ 22

Low Profile Wall Termination \_\_\_\_\_ 22

Universal B-Vent Cap \_\_\_\_\_ 22

Termination Tee \_\_\_\_\_ 23

End Pipe PPs-UV \_\_\_\_\_ 23

Vent Lengths PPs-UV \_\_\_\_\_ 23

45° Short Radius Elbow (Black) \_\_\_\_\_ 23

87° Short Radius Elbow (Black) \_\_\_\_\_ 24

PPs to PVC Termination Kit \_\_\_\_\_ 24

The Snork (one-piece snorkel termination) \_\_\_\_\_ 24

The Snout (one-piece intake termination) \_\_\_\_\_ 24

**Accessories** \_\_\_\_\_ **24**

Bird Screen PPs-UV \_\_\_\_\_ 24

2', 3', and 4' Spacers \_\_\_\_\_ 25

Flue Clamp \_\_\_\_\_ 25

Support Clamp \_\_\_\_\_ 25

Wall Plate Square (Plastic) \_\_\_\_\_ 25

Double Hose Clamp \_\_\_\_\_ 26

Connector Ring \_\_\_\_\_ 26

EPDM Gaskets \_\_\_\_\_ 26

B-Vent Gasket \_\_\_\_\_ 26

Centrocerin \_\_\_\_\_ 26

**InnoFlue 2" / 3" Field Kit** \_\_\_\_\_ **27**

**Intake / Exhaust Stickers** \_\_\_\_\_ **27**

**Single Wall - Large Diameter** \_\_\_\_\_ **28**

**Typical Configurations** \_\_\_\_\_ **29**

**Appliance Adaptors** \_\_\_\_\_ **30**

Appliance Adaptor for Coupler Style Flue Collar \_\_\_\_\_ 30

Appliance Adaptor for Flue Collar with Hose Clamp \_\_\_\_\_ 30

Appliance Adaptor w/ Condensate Drain \_\_\_\_\_ 30

and Vibration Isolation Boot OEM to InnoFlue® \_\_\_\_\_ 30

Flanged Adaptor OEM to InnoFlue® \_\_\_\_\_ 31

Appliance Adaptor OEM to InnoFlue® \_\_\_\_\_ 31

Appliance Adaptor SS to InnoFlue® \_\_\_\_\_ 31

Vibration Isolation Boot with Clamps \_\_\_\_\_ 31

Custom Appliance Adaptors \_\_\_\_\_ 32

**Increasers & Reducers** \_\_\_\_\_ **32**

Centric Increaser \_\_\_\_\_ 32

Eccentric Increaser \_\_\_\_\_ 32

Reducer \_\_\_\_\_ 33

Tapered Reducer \_\_\_\_\_ 33

**Test Ports** \_\_\_\_\_ **33**

Test Port \_\_\_\_\_ 33

**Vent Lengths** \_\_\_\_\_ **34**

Rigid Vent Length \_\_\_\_\_ 34

<b>Elbows and Tees</b>	<b>34</b>	<b>Couplers and Accessories</b>	<b>47</b>
15° Elbow	34	2', 3', and 4' Spacers	47
8" 15° Zero Radius Elbow	34	2" SW to Flex Coupler	47
30° Elbow	35	2" Flex to SW Coupler	48
8" 30° Zero Radius Elbow	35	3" Flex to SW Coupler	48
45° Elbow	35	4" Flex to SW Coupler	48
8" Zero Radius 45° Elbow	35	3" and 4" Flex to Flex Coupler	48
87° Elbow	35	Connector Ring	48
8" Zero Radius 87° Elbow	36		
Tee Cap	36	<b>B-Vent Flex and Component Kits</b>	<b>49</b>
Tee	36	2" B-Vent Kit	49
<b>Base Supports</b>	<b>36</b>	3" and 4" B-Vent Kit	49
Base Support	36	2" Flex Component B-Vent Kit	49
<b>Common Venting and Condensate Management</b>	<b>37</b>	3" and 4" Flex Component B-Vent Kit	50
Branch Tees	37	<b>Chimney Flex and Component Kits</b>	<b>50</b>
Cascade Component Kits	38	2" Chimney Kit	50
Horizontal Drain Tee	38	3" and 4" Chimney Kit	50
Horizontal Drain Fitting	38	2" Flex Component Chimney Kit	51
Tee Cap with Drain	39	3" and 4" Flex Component Chimney Kit	51
Universal Condensate Drain	39	<b>Terminations</b>	<b>51</b>
Universal Ball Valve Siphon	39	Chimney Cover PPs-UV	51
<b>Terminations</b>	<b>40</b>	Custom Chimney Cover PPs-UV	51
Pitched Roof Flashing	40	2" Flex End Pipe	52
Flat Roof Flashing	40	3" and 4" Flex End Pipe	52
Chimney Cover SS with PPs-Gray End Pipe	40	Universal B-Vent Cap	52
End Pipe PPs-Gray	40		
Termination Tee (long)	41	<b>Concentric</b>	<b>53</b>
Velocity Cone	41	<b>Typical Configurations</b>	<b>54</b>
PPs to PVC Termination Kit	41	<b>Concentric Adaptors</b>	<b>55</b>
6" Low Profile Termination	41	Concentric Centric Increaser	55
<b>Accessories</b>	<b>42</b>	2" / 4 & 3" / 5" Twin Pipe/Concentric Reversible Adaptor	55
Bird Screen PPs-UV	42	Concentric to Twin Pipe Adaptor	55
Bird Screen SS	42	Twin Pipe to Concentric Adaptor	55
Spacers	42	<b>Condensate Management</b>	<b>56</b>
Flue Clamp	42	Concentric Horizontal Drain Tee	56
Connector Ring	42	Universal Ball Valve Siphon	56
Wall Plates	43	<b>Concentric Test Ports</b>	<b>56</b>
Connector Double Hose Clamp	43	Concentric Test Port	56
Support Clamp	43	<b>Concentric Vent Lengths</b>	<b>57</b>
EPDM Gaskets	43	Concentric Vent Lengths	57
Centrocerin	43	<b>Elbows</b>	<b>57</b>
<b>Flex</b>	<b>44</b>	Concentric 45° Elbow	57
<b>Typical Configurations</b>	<b>44</b>	Concentric 87° Elbow	57
<b>Flex Vent Lengths</b>	<b>46</b>	<b>Roof Flashing</b>	<b>58</b>
2" Flex	46	Concentric Roof Flashing	58
3" and 4" Flex	46	<b>Terminations</b>	<b>58</b>
<b>Base Supports</b>	<b>47</b>	Concentric Roof Termination	58
Base Support	47	Concentric Wall Termination	58
Base Support Bracket	47	<b>Concentric Kits</b>	<b>59</b>
		Concentric Kit Horizontal	59
		Concentric Kit Vertical	59
		<b>Accessories</b>	<b>59</b>
		Wall Plate	59
		Support Clamp	59

# InnoFlue®

## The intelligent alternative to PVC & CPVC

Across North America, home owners, maintenance professionals, contractors, distributors, engineers and heating equipment manufacturers are recognizing the unmatched value InnoFlue® delivers to the HVAC industry.

Manufactured from environmentally friendly polypropylene, InnoFlue® has been tested and is listed to all relevant American, Canadian and European Safety Standards. It is listed and warranted for sustained flue gas temperatures up to 230°F (110°C), thus providing enhanced performance properties and significant safety margins. Centrotherm offers a comprehensive product line including test/inspection ports, condensate drains, siphons, flue collar adaptors, as well as excellent technical, sales and marketing support.

InnoFlue® Vent Systems are professional, reliable, environmentally sustainable and offer substantial labor savings due to reduced installation times.



## Why InnoFlue®?

### Ease of Installation

- Integrated gasket system allows for:
  - Faster, cleaner, V.O.C.-free installation
  - Immediate use of appliances upon installation
  - Post-installation adjustments
- No fit up, couplers, primers or adhesives needed
- Light weight makes for easy handling and rapid installation
- New 1/4" pitch for 2", 3" and 4" Single Wall vent systems

### Health and Safety

ETL Listed: UL 1738, ULC-S636  
Listed: CE EN 14471

- Performs at sustained flue temperatures up to 230°F (110°C)
- Listed at zero clearance to combustibles for all systems configurations
- Environmentally-friendly polypropylene is 100% recyclable
- Industry leading wall thickness enhances structural durability
- Chloride free

### Warranty & Reliability

- Manufacturer-supported and guaranteed with an unprecedented 10-year limited warranty
- Enhanced corrosion resistance allows for use with oil, propane, and natural gas fired appliances
- Over 20 years of field service history

## Listings



Centrotherm made the commitment and investment to have its Single Wall, Flexible and Concentric Vent Systems tested to the industry relevant UL-1738, ULC-S636 and CE EN 14471 safety standards. Thus InnoFlue® is approved for use in the United States, Canada and most European Countries.

As of this printing, InnoFlue® is the only polypropylene vent system to be listed by an accredited third party to the rigorous safety standards, UL 1738, ULC-S636 and CE EN 14471.

For information about Centrotherm's product testing and listings, visit:

**UL 1738 - Intertek**  
**ULC-S636 - Intertek**  
**CE EN 14471 - TÜV**



## Product Approvals

Since 2010, Centrotherm's InnoFlue® has been accepted and approved by over 50 North American manufacturers of boilers, water heaters and furnaces. For a complete listing of the approvals, visit

<http://www.centrotherm.us.com/Tools/OEM-Approval-Matrix.aspx>

Our appliance approvals increase regularly.

For any questions, please contact your manufacturer's representative or [Centrotherm Eco Systems](#).

## Applications and Limitations

- In order to maintain relevant listings and Centrotherm's warranty, **InnoFlue**<sup>®</sup> vent systems may not be combined with any polymeric or stainless steel vent components that are not part of Centrotherm's published offerings.
- **InnoFlue**<sup>®</sup> SW, **InnoFlue**<sup>®</sup> Flex, **InnoFlue**<sup>®</sup> Concentric, and **BlitzFlex**<sup>®</sup> must be installed following Centrotherm's published installation instructions.
- **InnoFlue**<sup>®</sup> SW, **InnoFlue**<sup>®</sup> Flex, and **InnoFlue**<sup>®</sup> Concentric are ETL listed to UL and ULC standards for use with natural gas or propane fired, Cat. II or Cat. IV appliances (US) or BH Gas Class II A, B and C gas or propane fired appliances (Canada).
- **InnoFlue**<sup>®</sup> SW, **InnoFlue**<sup>®</sup> Flex, and **InnoFlue**<sup>®</sup> Concentric can also be used for oil fired, condensing appliances with a maximum flue gas temperature that does not exceed 230°F (110°C).
- **InnoFlue**<sup>®</sup> SW, **InnoFlue**<sup>®</sup> Flex, and **InnoFlue**<sup>®</sup> Concentric are ETL listed to UL 1738 and ULC-S636 at zero clearance to combustibles.
- **InnoFlue**<sup>®</sup> SW, **InnoFlue**<sup>®</sup> Flex, and **InnoFlue**<sup>®</sup> Concentric may be installed inside a masonry or sheet rocked chase, through an existing structurally intact metal flue, between floor joists, directly through a wall or if properly supported, can even be left exposed along the interior of a structure.
- **InnoFlue**<sup>®</sup> Flex is available in 2", 3" and 4" diameters and offers all necessary components for combining it with **InnoFlue**<sup>®</sup> SW and **InnoFlue**<sup>®</sup> Concentric to meet specific job requirements.
- **InnoFlue**<sup>®</sup> Flex may be used in offsets or bends not to exceed 45° from vertical.
- **InnoFlue**<sup>®</sup> Flex must be installed inside a masonry chimney or sheet rocked chase, or through an existing, structurally intact metal flue.
- Single or multiple **InnoFlue**<sup>®</sup> Flex exhausts may be installed into an existing masonry chimney or structurally intact metal flue or chase.
- When the outside temperature is less than 32°F (0°C), install **InnoFlue**<sup>®</sup> Flex and **BlitzFlex**<sup>®</sup> from the bottom of a chase from inside the building.
- When using **InnoFlue**<sup>®</sup> Flex, reduce maximum vent length per equipment manufacturer's instruction manual.
- **InnoFlue**<sup>®</sup> Concentric is available in 2 1/4", 3 1/5" and 4 1/6" diameters and offers all necessary components for combining it with **InnoFlue**<sup>®</sup> SW and **InnoFlue**<sup>®</sup> Flex to meet specific job requirements.
- Do not install where ambient air temperature can exceed 300°F.





# More Resources

Quick Guide



Adaptor Guide

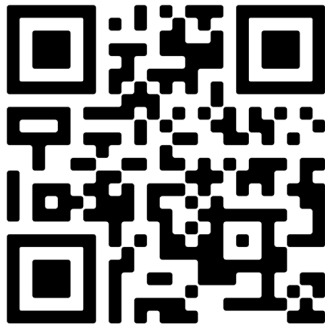

Training Videos



Flex Quick Guide



OEM Matrix

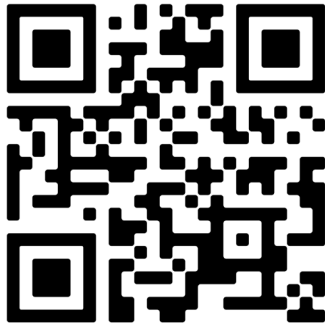

2 Minute Overview



# Installation Quick Guide

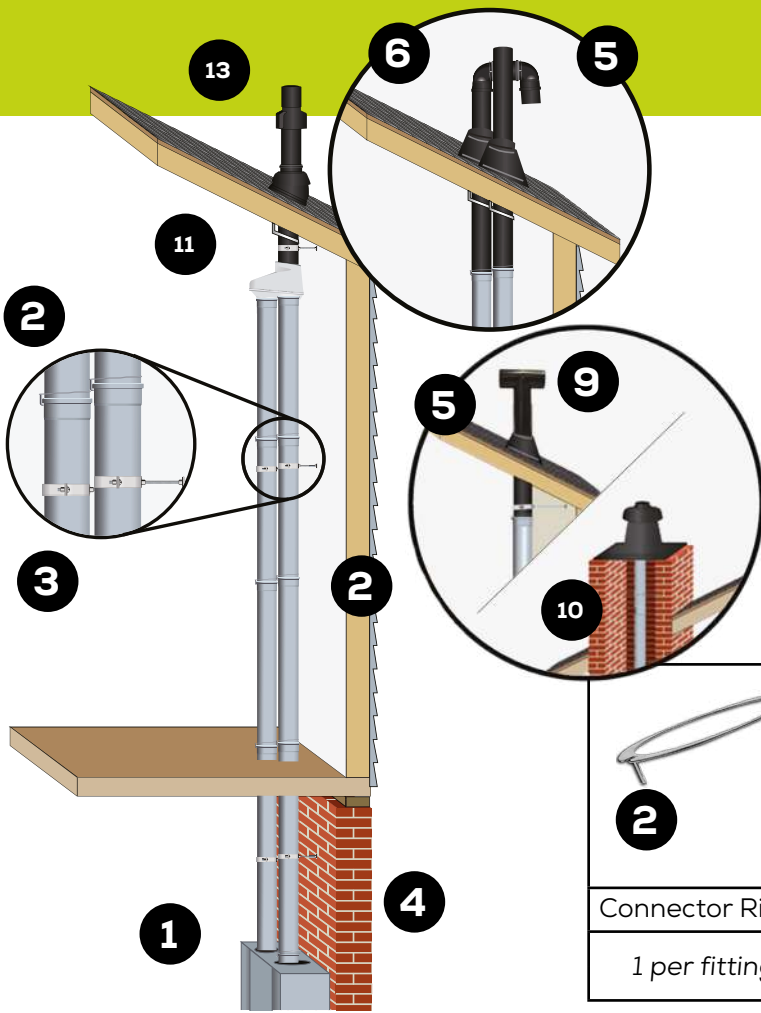





## Adaptors

Consult InnoFlue OEM Matrix for correct fitting

<b>1</b> 		
PVC Adaptor	Gasketed	Steel Adaptor
ISAAL	ISAGL	ISSA





## Accessories

<b>2</b> 	<b>3</b> 	<b>4</b> 	<b>5</b> 
Connector Ring	Support Clamp	Recommended	
1 per fitting	Vertical Every 39"	Horizontal Every 78"	Test Port
			Bird Screen

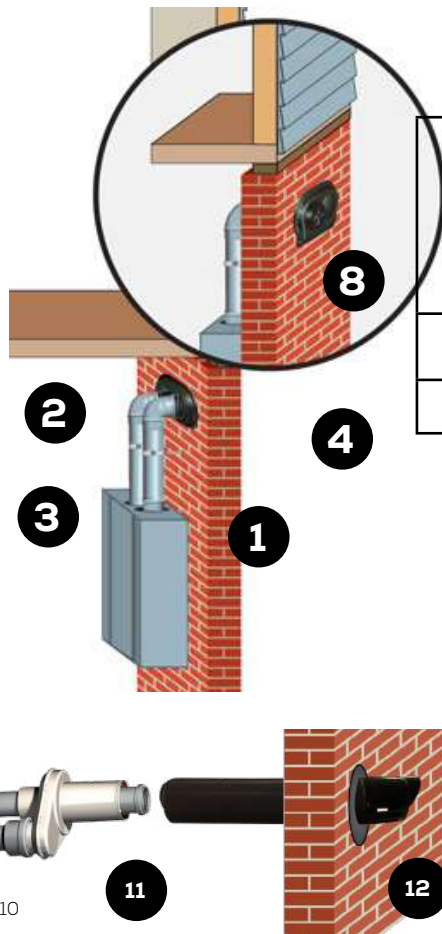
## Termination Options

Consult local codes and OEM I&O manuals for snowline and other requirements



<b>6</b> 	<b>7</b> 	<b>8</b> 	<b>9</b> 	<b>10</b> 
End Pipe	Snorkel	Horizontal Wall	Term Tee	Chimney Cap
ISEP	ISSNKL	ISLPT	ISTT	ISCP





## Concentric Adaptor → Terminations

<b>11</b> 	<b>12</b> 	<b>13</b> 
Required	Select One	
Adaptor	Wall Termination	Roof Term
ICTCR	ICWT	ICRT

# Condensate Management & Cascade Quick Guide

## Siphon & Configurations





Attaches to any InnoFlue® 32mm drain. Allows condensates to flow while unique ball valve assures combustion gases remain contained at higher temperatures. Comes with and can be installed with a barbed or compression fitting.

			
Siphon	Drain	Barbed	Non-Return Valve
IASJVBS	Gasket and cap create 32 mm compression fitting on any InnoFlue drain	Fits 5/8th" tube. Field supply silicon tubing, clamp	<b>NRV supplied by appliance manufacturer</b>

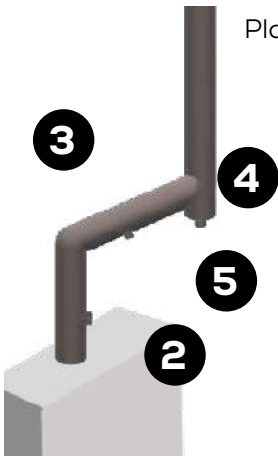
## Condensate Management Components

Place test ports immediately in exhaust run, and drain tee at first horizontal segment of the run



				
<b>All InnoFlue® drains are 32mm</b>				
Test Port	Horizontal Drain Fitting	Tee	Cap w/ Drain	Cap
ISTP	ISHDT	IST	ISTCD	ISTC



## Cascade Components

InnoFlue® cascade kits available up to 12"

**NOTE:** Exhaust must be pitched back to the appliance.

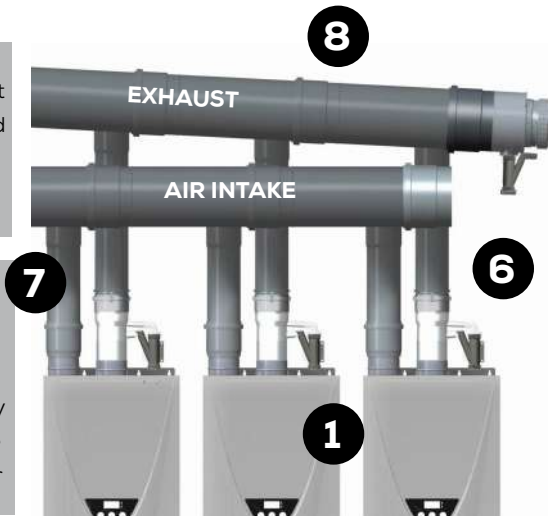
**NOTE:** Non-Return Valves must be supplied by the appliance manufacturer



Branch Tee Orientation			
			
<b>Consult appliance I&amp;O manual.</b>			
Branch Tee	Manifold Drain Cap		
ISBT	ISHDF		

2" - 12"

# Single Wall

## Small Diameter



**Commercial quality in all sizes.**

# Typical configurations

- 2 ISEL87: 87° Elbow
- 3 ISVL: Vent Length
- 4 IASCM: Support Clamp
- 5 IANS: Connector Ring
- 6 IAWP: Wall Plate
- 7 ISEP: End Pipe PPs-UV
- 8 ISTT: Termination Tee PPs-UV
- 9 IASPP: Bird Screen PPs-UV
- 11 ISELLUV: 87° Elbow Long PPs-UV
- 12 ISAGL or ISAAL: Appliance Adaptor
- 13 ISLPT: Low Profile Wall Termination
- 14 ICTC: Twin Pipe to Concentric Adaptor
- 15 ICRT: Concentric Roof Termination
- 16 ISVLUV: Vent Length PPs-UV Black

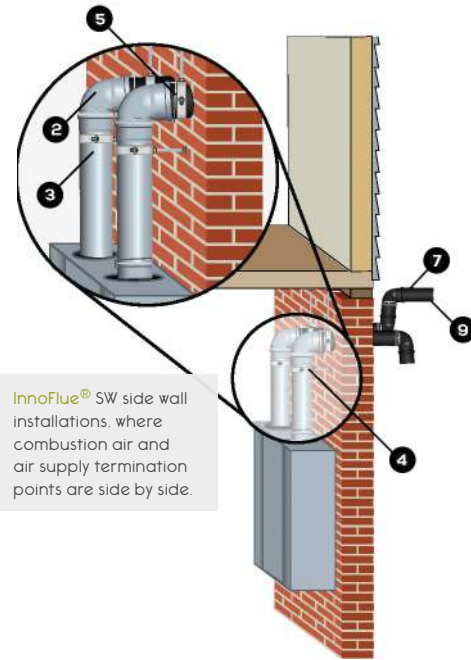

InnoFlue® SW side wall installations, where combustion air and air supply termination points are side by side.

Single Wall · 2" - 4"

InnoFlue® SW side wall installations where combustion air and supply termination points can be significantly separated.

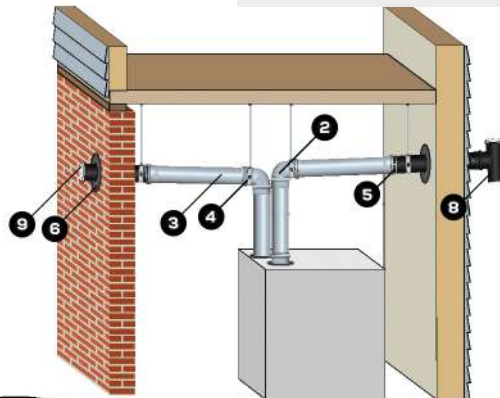

InnoFlue® SW side wall installations, where exhaust and air supply remain separated through the Low Profile Wall Termination.

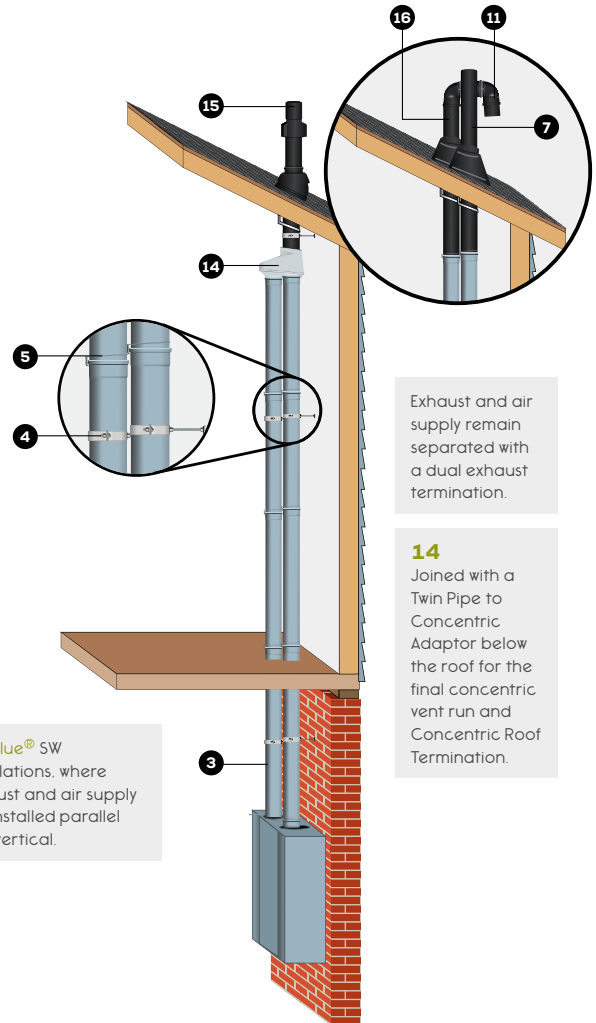
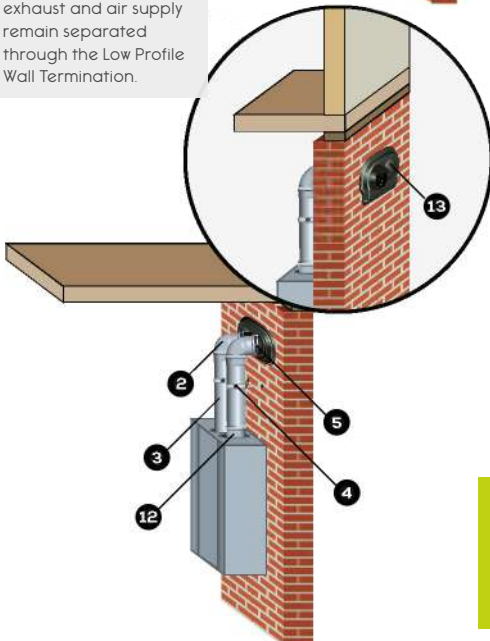

Exhaust and air supply remain separated with a dual exhaust termination.

**14** Joined with a Twin Pipe to Concentric Adaptor below the roof for the final concentric vent run and Concentric Roof Termination.

InnoFlue® SW installations, where exhaust and air supply are installed parallel and vertical.

For each configuration, see installation instructions and specific code requirements.

# Appliance Adaptors

Check adaptor matrix at [www.centrotherm.us.com/Tools/OEM-Approval-Matrix.aspx](http://www.centrotherm.us.com/Tools/OEM-Approval-Matrix.aspx)

Single Wall · 2" – 4"



**Appliance Adaptor for Coupler Style Flue Collars**

Adapts a female PVC / CPVC coupler or appliance flue exhaust to InnoFlue® SW diameters.

Nominal Diameter PVC to PP	Part	Overall Length <b>A</b>	Effective Length <b>B</b>	Max O.D. <b>C</b>
2"/2" (60/60)	ISAGL0202	3.3 (83)	1.0 (26)	3.0 (76)
3"/3" (89/80)	ISAGL0303	3.0 (75)	0.8 (21)	3.8 (97)
4"/4" (114/110)	ISAGL0404	3.4 (87)	0.8 (21)	5.1 (129)



**Appliance Adaptor for Flue Collar with Hose Clamp**

Adapts a female PVC / CPVC sized appliance collar (with integrated gasket) to InnoFlue® SW diameters.

Nominal Diameter PVC to PP	Part	Overall Length <b>A</b>	Effective Length <b>B</b>	Max O.D. <b>C</b>
2"/2" (60/60)	ISAAL0202	3.3 (83)	1.0 (26)	3.0 (76)
3"/3" (89/80)	ISAAL0303	3.0 (75)	0.8 (21)	3.8 (97)
4"/4" (114/110)	ISAAL0404	3.4 (87)	0.8 (21)	5.1 (129)



**Appliance Adaptor Tapered SS to InnoFlue®**

Adapts a tapered female stainless steel appliance flue exhaust with tabs to InnoFlue®.

Nominal Diameter	Part	Overall Length <b>A</b>	Effective Length <b>B</b>	Max O.D. <b>C</b>
3" (80)	ISAAS0303	4.5 (115)	0.8 (21)	3.8 (97)
4" (110)	ISAAS0404	4.8 (122)	0.8 (21)	5.1 (129)



**Appliance Adaptor Straight SS to InnoFlue®**

Adapts a stainless steel appliance flue exhaust with gasket and clamp to InnoFlue®.

Nominal Diameter	Part	Overall Length <b>A</b>	Effective Length <b>B</b>	Max O.D. <b>C</b>
3"/3" (76/80)	ISSA0303	6.0 (153)	3.1 (78)	3.8 (97)
4"/4" (102/110)	ISSA0404	6.0 (153)	3.6 (91)	5.1 (129)

	Appliance Adaptors 101mm to PPs				
	Adapts 101mm diameter flue exhaust to InnoFlue® Adaptors include replacement o-ring for flue collar.				
	Nominal Diameter PVC to PP	Part	Overall Length <b>A</b>	Effective Length <b>B</b>	Max O.D. <b>C</b>
4" (100/101)/3" (80)	ISAO10103	6.5 (165)	3.3 (84)	3.8 (97)	
4" (100/101)/4" (110)	ISAO10104	6.4 (163)	4.0 (102)	5.1 (129)	

Available	Custom Appliance Adaptors
	Available to fit most residential and commercial heating appliances. Call for pricing.

## Increasers & Reducers

	Eccentric Increaser				
	Transitions vent system to a larger diameter. Install in horizontal or vertical orientation. Other size combinations available upon request.				
	Nominal Diameter	Part	Overall Length <b>A</b>	Effective Length <b>B</b>	Max O.D. <b>C</b>
2"/3" (60/80)	ISEI0203	5.3 (135)	3.1 (79)	3.8 (97)	
3"/4" (80/110)	ISEI0304	6.1 (156)	3.6 (91)	5.1 (129)	

	Centric Increaser				
	Transitions vent system to a larger diameter. Install in vertical orientation only. Additional configurations available upon request.				
	Nominal Diameter	Part	Overall Length <b>A</b>	Effective Length <b>B</b>	Max O.D. <b>C</b>
2"/3" (60/80)	ISIA0203	5.9 (150)	3.5 (89)	3.8 (97)	
3"/4" (80/110)	ISIA0304	5.7 (145)	3.2 (81)	5.1 (129)	
4"/4" (100/110)	ISIA10004	6.4 (163)	4.2 (105)	5.1 (129)	

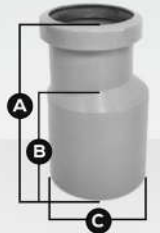
3/2" Reducer				
				
Transitions vent system to a smaller diameter.				
Nominal Diameter	Part	Overall Length <b>A</b>	Effective Length <b>B</b>	Max O.D. <b>C</b>
3"/2" (80/60)	ISRD0302	6.0 (153)	3.5 (89)	3.2 (80)

Reducers				
				
Transitions vent system to a smaller diameter.				
Nominal Diameter	Part	Overall Length <b>A</b>	Effective Length <b>B</b>	Max O.D. <b>C</b>
4"/3" (110/80)	ISRD0403	6.0 (153)	3.5 (89)	4.3 (110)
6"/4" (160/110)	ISRD0604	6.5 (166)	4.0 (102)	6.3 (160)
6"/4" (150/110)	ISRD15004	8.8 (223)	6.5 (165)	5.9 (150)

## Test Ports

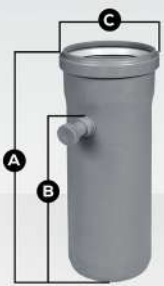
Test Ports				
				
Installed immediately above the appliance, the test port allows plumbing and heating professionals to sample flue gases and ensure the appliance is operating at optimum efficiency.				
Nominal Diameter	Part	Overall Length <b>A</b>	Effective Length <b>B</b>	Max O.D. <b>C</b>
2" (60)	ISTP02	7.0 (170)	4.3 (110)	3.0 (76)
3" (80)	ISTP03	7.0 (170)	4.5 (115)	3.8 (97)
4" (110)	ISTP04	12.4 (314)	9.8 (250)	5.1 (129)



## Vent Lengths

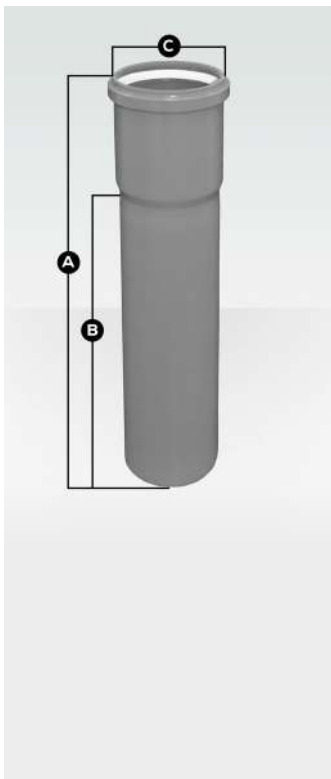

### Rigid Vent Length

Rigid polypropylene vent lengths with dedicated male and female ends. Female ends contain internal gasket and male ends can be field cut and chamfered to desired length.

Nominal Diameter	Part	Overall Length A	Effective Length B	Max O.D. C
2" (60)	ISVL021	16.4 (411)	12 (305)	3.0 (76)
2" (60)	ISVL022	28.4 (716)	24 (610)	3.0 (76)
2" (60)	ISVL023	40.4 (1021)	36 (914)	3.0 (76)
2" (60)	ISVL026	76.4 (1935)	72 (1829)	3.0 (76)
2" (60)	ISVL0210	124.2 (3155)	120 (3048)	3.0 (76)
3" (80)	ISVL031	16.4 (411)	12 (305)	3.8 (97)
3" (80)	ISVL032	28.4 (716)	24 (610)	3.8 (97)
3" (80)	ISVL033	40.2 (1021)	36 (914)	3.8 (97)
3" (80)	ISVL036	76.4 (1935)	72 (1829)	3.8 (97)
3" (80)	ISVL0310	124.2 (3155)	120 (3048)	3.8 (97)
4" (110)	ISVL041	16.0 (406)	12 (305)	5.1 (129)
4" (110)	ISVL042	28.0 (711)	24 (610)	5.1 (129)
4" (110)	ISVL043	40.2 (1016)	36 (914)	5.1 (129)
4" (110)	ISVL046	76.2 (1930)	72 (1829)	5.1 (129)
4" (110)	ISVL0410	124.2 (3155)	120 (3048)	5.1 (129)

Single Wall · 2" - 4"

## Base Supports



### Base Support

Supports vertical sections of rigid (up to 164') and flexible (up to 98' with Flex end pipe) vent lengths installed in chimneys and chases.

Nominal Diameter	Part	Base Length A	Height B	Max O.D. C	Effective D	Effective E
2" (60)	ISBS0287	15.8 (400)	9.4 (238)	3.0 (76)	2.7 (69)	4.6 (118)
3" (80)	ISBS0387	15.8 (400)	10.6 (269)	3.8 (97)	3.4 (86)	4.9 (125)
4" (110)	ISBS0487	15.8 (400)	11.5 (291)	5.1 (129)	2.6 (65)	4.5 (115)

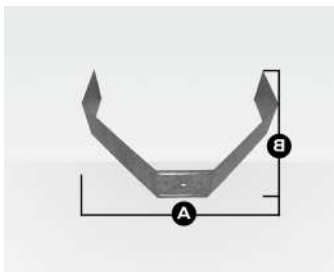

### Base Support Bracket

B-Vent Support Bracket (IABVSB) replaces metal channel on base support to support vertical sections of rigid and flexible vent lengths installed inside a B-Vent. Fastens to floor joists.

Part	Width A	Height B
IABVSB	17.5 (446)	11.8 (298)

## Elbows and Tees

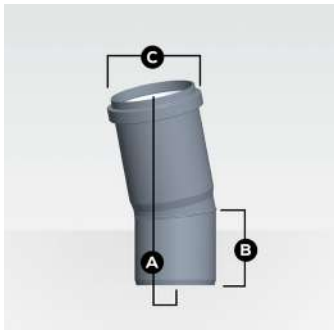

### 15° Elbow

For offsets or changes in the direction of the vent system.

Nominal Diameter	Part	Centerline Offset A	Effective Length B	Max O.D. C
2" (60)	ISEL0215	1.2 (32)	3.5 (88)	2.9 (74)
3" (80)	ISEL0315	1.3 (32)	3.6 (91)	3.7 (94)
4" (110)	ISEL0415	1.2 (32)	3.9 (99)	5.0 (128)



### 30° Elbow

For offsets or changes in the direction of the vent system.

Nominal Diameter	Part	Centerline Offset A	Effective Length B	Max O.D. C
2" (60)	ISEL0230	2.5 (63)	3.7 (94)	2.9 (74)
3" (80)	ISEL0330	2.5 (64)	3.9 (99)	3.7 (94)
4" (110)	ISEL0430	2.5 (64)	4.3 (110)	5.0 (128)

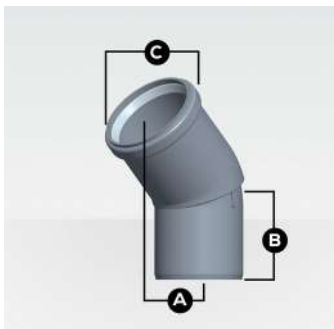

### 45° Short Radius Elbow

For offsets or changes in the direction of the vent system.

Nominal Diameter	Part	Centerline Offset A	Effective Length B	Max O.D. C
2" (60)	ISELS0245	2.5 (64)	3.8 (95)	3.0 (75)
3" (80)	ISELS0345	2.6 (66)	3.9 (98)	3.7 (95)
4" (110)	ISELS0445	2.7 (69)	4.2 (107)	5.0 (127)

87° Short Radius Elbow				
For offsets or changes in the direction of the vent system.				
Nominal Diameter	Part	Centerline Offset A	Effective Length B	Max O.D. C
2" (60)	ISELS0287	4.1 (105)	3.9 (98)	3.0 (75)
3" (80)	ISELS0387	4.5 (114)	4.3 (109)	3.7 (95)
4" (110)	ISELS0487	5.1 (131)	4.9 (124)	5.0 (127)

87° Long Radius Elbow				
For offsets or changes in the direction of the vent system.				
Nominal Diameter	Part	Centerline Offset A	Effective Length B	Max O.D. C
2" (60)	ISELL0287	2.5 (63)	4.8 (121)	3.0 (76)
3" (80)	ISELL0387	5.2 (133)	5.1 (129)	3.7 (95)
4" (110)	ISELL0487	6.5 (165)	4.4 (111)	5.1 (129)

Tee				
Use to change the direction of the vent system and capture condensates at base of long vertical runs.				
Nominal Diameter	Part	Effective Length A	Effective Length B	Effective Length C
2" (60)	IST02	6.3 (160)	8.7 (221)	2.6 (66)
3" (80)	IST03	6.3 (160)	8.7 (221)	2.7 (69)
4" (110)	IST04	5.6 (142)	8.4 (214)	3.0 (76)

Tee Cap		
Seals non-utilized tees and branch tees.		
Nominal Diameter	Part	Max O.D. A
2" (60)	ISTC02	3.0 (76)
3" (80)	ISTC03	3.8 (97)
4" (110)	ISTC04	5.1 (129)

## Condensate Management

Single Wall · 2" – 4"



### Horizontal Drain Tee

Use with any InnoFlue® siphon to drain condensate from the vent system. Install in horizontal section closest to appliance. 1.26" (32mm) O.D. drain.

Nominal Diameter	Part	Overall Length A	Effective Length B	Max O.D. C
2" (60)	ISHDT02	9.8 (250)	7.3 (186)	3.0 (76)
3" (80)	ISHDT03	9.8 (250)	7.3 (186)	3.7 (94)
4" (110)	ISHDT04	12.4 (315)	9.8 (250)	4.1 (129)



### Tee Cap with Drain

Use with any InnoFlue® siphon to drain condensate from the vent system.

Nominal Diameter	Part	Overall Length A	Max O.D. B	Drain O.D.
2" (60)	ISTCD02	6.1 (155)	3.0 (75)	1.3 (32)
3" (80)	ISTCD03	5.3 (135)	3.7 (95)	1.3 (32)
4" (110)	ISTCD04	5.9 (150)	5.0 (126)	1.3 (32)



### Universal Ball Valve Siphon

Attaches to any InnoFlue® drain. Allows condensates to flow while unique ball valve assures combustion gases remain contained at higher temperatures. Comes with and can be installed with a barbed or compression fitting. See configuration options below.

Part	Overall Height A	Width B	Length C
IASJBVS	6.5	4.5	1.9



Compression



Barbed



Directional

## Kits



### Horizontal Vent Kit

Includes all fittings and accessories required for short sidewall termination vent runs.

Nominal Diameter	Part
2" (60)	ISVKH02
3" (80)	ISVKH03
4" (110)	ISVKH04



### Quick Kits (Wall)

Includes everything necessary to terminate an appliance through a side wall

**Kit Contains:**

- 3' vent Lengths (QTY3)
- 87° Elbows (QTY 2)
- Connector Rings (QTY 6)
- Sidewall Termination
- Centrocerin Lubricant

Nominal Diameter	Part
2" (60)	ISQKW02
3" (80)	ISQKW03
4" (110)	ISQKW04



### Quick Kit (Roof)

Includes everything necessary to terminate an appliance through a single roof penetration

**Kit Contains:**

- PVC to PP Adaptor (intake)
- 3' vent Lengths (QTY 6)
- 87° Elbows (QTY 2)
- Connector Rings (QTY 6)
- Twin Pipe to Concentric Adaptor
- Concentric Termination
- Centrocerin Lubricant

Nominal Diameter	Part
2" (60)	ISQKR02
3" (80)	ISQKR03
4" (110)	ISQKR04

# Terminations

Single Wall · 2" – 4"



## Chimney Cover PP5-UV

This termination incorporates a combustion air intake and flue gas termination in a single assembly. Cover seals top of the chimney or chase. Use with End Pipe or Flex End Pipe. End Pipes sold separately.

Nominal Diameter	Part	Length A	Height B
2" (60)	ISCP02	15.8 (400)	9.6 (245)
3" (80)	ISCP03	15.8 (400)	9.6 (245)
4" (110)	ISCP04	15.8 (400)	9.6 (245)



## Low Profile Wall Termination (2" and 3")

Low Profile Wall Termination incorporates combustion air intake and exhaust into a single aesthetically pleasing termination. Part is paintable to match exterior of structure. Comes with interior wall plate and bird screen. Exhaust can be extended or re-directed with elbows or vent lengths. Vent lengths and elbows sold separately.

Nominal Diameter	Part	Overall Width A	Overall Height B	Offset
2" (60)	ISLPT0202	13 (330)	9.1 (231)	4.7 (119)
3" (80)	ISLPT0303	13 (330)	9.1 (231)	4.7 (119)



## Low Profile Wall Termination (4")

Low Profile Wall Termination incorporates combustion air intake and exhaust into a single aesthetically pleasing termination. Part is paintable to match exterior of structure. Comes with interior wall plate and bird screen. Exhaust can be extended or re-directed with elbows or vent lengths. Vent lengths and elbows sold separately.

Nominal Diameter	Part	Overall Width	Overall Height	Offset
4" (110)	ISLPT0404	23 (584)	15 (305)	5.3 (134)



## Universal B-Vent Cap

Allows for multiple flue configurations. Utilize existing B-Vent as a chase. Clean, professional and aesthetically pleasing. Installs quickly and easily.

Part	Length	Height	Width
IAUBVC	10"	10"	10"



Multiple Configuration Options



## Termination Tee

Made from black U.V. stabilized polypropylene. Use where termination is exposed to excessive sunlight, wind or prone to freeze ups.

Nominal Diameter	Part	Overall Width A	Effective Length B	Max Length C
2" (60)	ISTT0220	7.6 (193)	27.6	28.8
3" (80)	ISTT0320	7.6 (193)	27.6	29.2
4" (110)	ISTT0420	7.6 (193)	27.6	29.8



End Pipe PP-UV			
Made from black U.V. stabilized polypropylene. Use where termination is exposed to excessive sunlight.			
Nominal Diameter	Part	Overall Length A	Max O.D. B
2" (60)	ISEP02	19.7 (500)	2.4 (60)
2" (60)	ISEP0239	39.4 (1000)	2.4 (60)
3" (80)	ISEP03	19.7 (500)	3.2 (80)
3" (80)	ISEP0339	39.4 (1000)	3.2 (80)
4" (110)	ISEP04	19.7 (500)	4.3 (110)
4" (110)	ISEP0439	39.4 (1000)	4.3 (110)



Vent Lengths PP-UV				
Allows for the exterior extension of the vent system.				
Nominal Diameter	Part	Overall Length A	Effective Length B	Max O.D. C
2" (60)	ISVL022UV	28.4 (721)	24 (610)	3.0 (75)
3" (80)	ISVL032UV	28.4 (721)	24 (610)	3.8 (97)
4" (110)	ISVL042UV	28.2 (716)	24 (610)	5.1 (129)



45° Short Radius Elbow (Black)				
For exterior offsets or changes in the direction of the vent system.				
Nominal Diameter	Part	Centerline Offset A	Effective Length B	Max O.D. C
2" (60)	ISELS0245UV	2.5 (64)	3.8 (95)	3.0 (75)
3" (80)	ISELS0345UV	2.6 (66)	3.9 (98)	3.7 (95)
4" (110)	ISELS0445UV	2.7 (69)	4.2 (107)	5.0 (127)



87° Short Radius Elbow (Black)				
For exterior offsets or changes in the direction of the vent system.				
Nominal Diameter	Part	Centerline Offset A	Effective Length B	Max O.D. C
2" (60)	ISELS0287UV	4.1 (105)	3.9 (98)	3.0 (75)
3" (80)	ISELS0387UV	4.5 (114)	4.3 (109)	3.7 (95)
4" (110)	ISELS0487UV	5.1 (131)	4.9 (124)	5.0 (127)

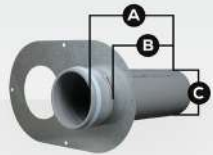

**PPs to PVC Termination Kit**

Adapts PPs to PVC Twin Pipe Termination. Comes with replacement wall plate and termination adaptor.

Nominal Diameter	Part	Overall Length <b>A</b>	Effective Length <b>B</b>	End O.D. <b>C</b>
2" (60)	ISLTK02	12.3 (313)	11.0 (280)	2.4 (61)
3" (80)	ISLTK03	13.0 (330)	11.0 (280)	3.5 (89)
4" (110)	ISLTK04	13.2 (336)	11.0 (280)	4.5 (115)

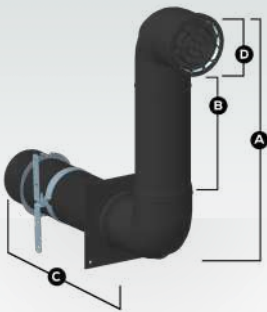

**The Snork – Shorter name, Shorter install time!**

One piece termination. Includes bird screen, connector ring, support clamp, and wall plate.

Nominal Diameter	Part	Overall Height <b>A</b>	Height <b>B</b>	Length <b>C</b>	Max O.D. <b>D</b>
2" (60)	ISSNKL021	17.6 (447)	12.6 (320)	19.1 (485)	3.0 (76)
3" (80)	ISSNKL031	19.2 (488)	12.6 (320)	19.5 (495)	3.7 (94)
4" (110)	ISSNKL041	21.6 (549)	12.6 (320)	20.1 (511)	5.0 (127)

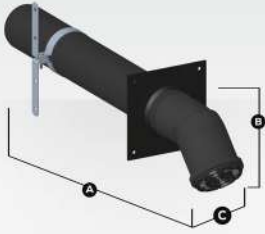

**The Snout – InnoFlue Intake Termination**

One piece intake termination. Includes bird screen, support clamp, and wall plate.

Nominal Diameter	Part	Overall Length <b>A</b>	Height <b>B</b>	Max O.D. <b>C</b>
2" (60)	ISHT0245	26.7 (679)	4.8 (121)	3.0 (75)
3" (80)	ISHT0345	27.1 (689)	5.5 (139)	3.7 (95)
4" (110)	ISHT0445	27.9 (709)	12.6 (320)	5.0 (127)

## Accessories



**Bird Screen PP-UV**

Fits inside InnoFlue® SW and Flex end-pipes at terminations.

Nominal Diameter	Part
2" (60)	IASPP02
3" (80)	IASPP03
4" (110)	IASPP04



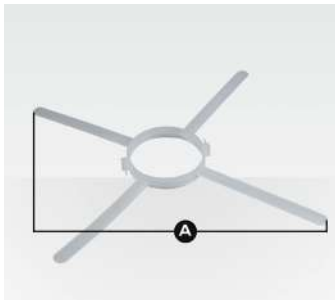

### 2", 3", and 4" Spacers

Self-positioning spacers center InnoFlue® SW or Flex in a chase/chimney/B-vent.

Nominal Diameter	Part	Max Width A	Min Width
2" (60)	IASP02	23.5 (596)	3.3 (85)
3" (80)	IASP03	22.8 (580)	4.2 (106)
4" (110)	IASP04	23.9 (606)	5.4 (138)



### Flue Clamp

Secures ISAGL appliance adaptors to appliance flue collar.

Nominal Diameter	Part	Height A	Max. I.D. B
2" (60)	IAFC02	1.0 (26)	3.0 (77)
3" (80)	IAFC03	1.0 (26)	4.3 (110)
4" (110)	IAFC04	1.0 (26)	5.0 (127)

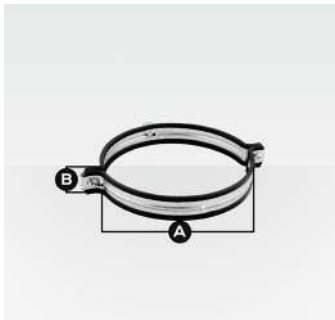

### Support Clamp

Used as vertical or horizontal support. Space 78" in vertical and 39" in horizontal installations. **Use field supplied 3/8" threaded rod.**

Nominal Diameter	Part	Overall Length A	Height B
2" (60)	IASCM02	3 (76.2)	1.1(28)
3" (80)	IASCM03	3.8 (96.5)	1.1 (28)
4" (110)	IASCM04	5.3 (134.6)	1.1 (28)

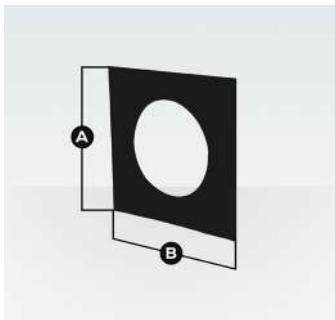

### Wall Plate Square (Plastic)

Used to improve aesthetics and reduce drafts at chimney openings or wall penetrations.

Nominal Diameter	Part	Length A	Width B
2" (60)	IAWP02BP	6 (150)	6 (150)
3" (80)	IAWP03BP	6 (150)	6 (150)
4" (110)	IAWP04BP	6 (150)	6 (150)



### Double Hose Clamp

Connection clamps provide mechanical connection as required by O.E.M.

Nominal Diameter	Part
2" (60)	IADHC0202
3" (80)	IADHC0303
4" (110)	IADHC0404

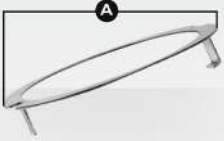

### Connector Ring

Provides reinforcement at joints to support loads of up to 99 lbs (45kg).

Nominal Diameter	Part	O.D. A
2" (60)	IANS02	3.2 (81)
3" (80)	IANS03	4.1 (103)
4" (110)	IANS04	5.3 (134)



### EPDM Gaskets

Standard gasket for 2" through 4" diameter InnoFlue® SW. Inserted into the female end of each part, the gaskets keep flue gases and condensates within the vent system.

Nominal Diameter	Part
2" (60)	ISGE02
3" (80)	ISGE03
4" (110)	ISGE04



### B-Vent Gasket

Rubber gasket for converting existing B-Vent into a combustion air chase.

Diameter	Part	Flange I.D. A	Max O.D. B	Groove Thickness C
2" (60)	IACGE02	2.8 (72)	3.5 (88)	0.1 (2.5)
3" (80)	IACGE03	3.6 (92)	4.3 (108)	0.1 (2.5)
4" (110)	IACGE04	4.8 (122)	5.4 (137)	0.1 (2.5)



### Centrocerin

A water based lubricant used to ease the assembly of InnoFlue® SW & Flex. Sparingly applied to the gasket or male end.

Package Size	Part
50 ml	IACE50

# InnoFlue 2" / 3" Field Kit

**Field Kit**

Be prepared for any installation with the InnoFlue Field Kit.

Nominal Diameter	Part
2" (60) / 3" (80)	ISFK0203

**Kit Contains:**

- ISAGL Adaptor (Qty 2)
- ISAAL Adaptor (QTY 2)
- ISLPT Wall Termination (QTY 1)
- 45° Elbow (QTY 2)
- 87° Elbow (QTY 2)
- 1' Vent Length (QTY 2)
- 2' Vent Length (QTY 2)
- Connector Ring (QTY 5)
- Support Clamp (QTY 3)
- Bird Screen (QTY 3)
- Wall Plate (QTY 2)
- Lubricant (QTY 5)
- Field Kit Inventory Tracker

Be prepared for any installation with the InnoFlue Field Kit.

We have compiled an assortment of parts that will help you adjust to any situation and complete the job without a return trip to the distributor. Adaptors, accessories, extra elbows, and more – this kit will rounds out 2" and 3" installations

See the components and quantities at left.

Both 2" and 3" parts are included with each kit.



**InnoFlue Field Kit Inventory Tracker**

Keep track of the InnoFlue components you use/need and save yourself costly trips back to the wholesaler.

Technician: \_\_\_\_\_  
Truck #: \_\_\_\_\_

ISAGL	ISAAL	ISLPT	45°	87°	1'	2'	IASCM	IASNS	IASPD	PLATE	LUBE
2" 3"	2" 3"	2" 3"	2" 3"	2" 3"	2" 3"	2" 3"	2" 3"	2" 3"	2" 3"	2" 3"	

ISFK0203      Centrotherm Eco Systems • <http://centrotherm.us.com> • 518.434.3400

## Stickers

**Intake / Exhaust Stickers**

Clearly mark intake & exhaust runs with Centrotherm intake/exhaust stickers

Part	
Exhaust Sticker	IMES2021
Intake Sticker	IMIS2021



Single Wall 6" - 12"

# Large Diameter

# Typical configurations

- 2 ISEL87: 87° Elbow
- 3 ISVL: Vent Length
- 4 IASCM: Support Clamp
- 5 IANS: Connector Ring\*
- 6 IAWP: Wall Plate
- 7 ISEP: End Pipe PPs-UV
- 9 IASPP: Bird Screen PPs-UV
- 12 Appliance Adaptor (See OEM approval matrix)
- 19 ISTP: Test Port
- 20 ISHDF: Horizontal Drain Fitting
- 21 IASJVBS: Siphon
- 22 ISBT: Branch Tee
- 23 ISELO430: 30° Elbow
- 24 ISBS: Base Support
- 25 IASP: Spacer
- 26 ISCM: Chimney Cover SS w/PPs-UV End Pipe
- 27 Roof Flashing (see page 56)

\*where required

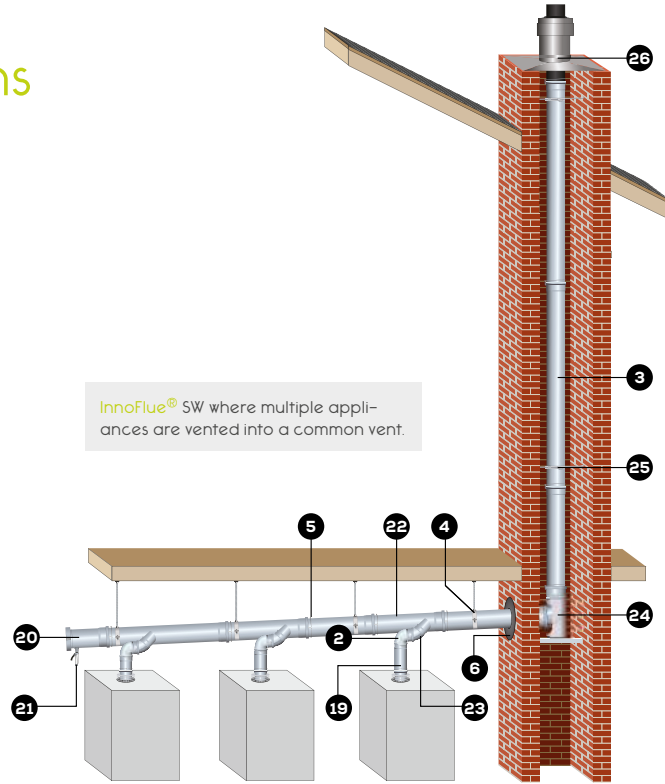

Single Wall 6" - 12"

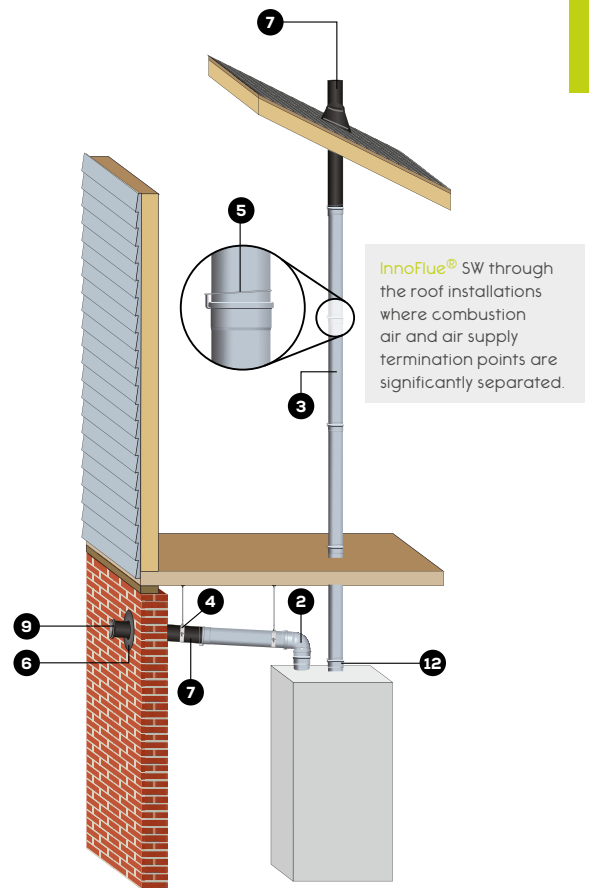
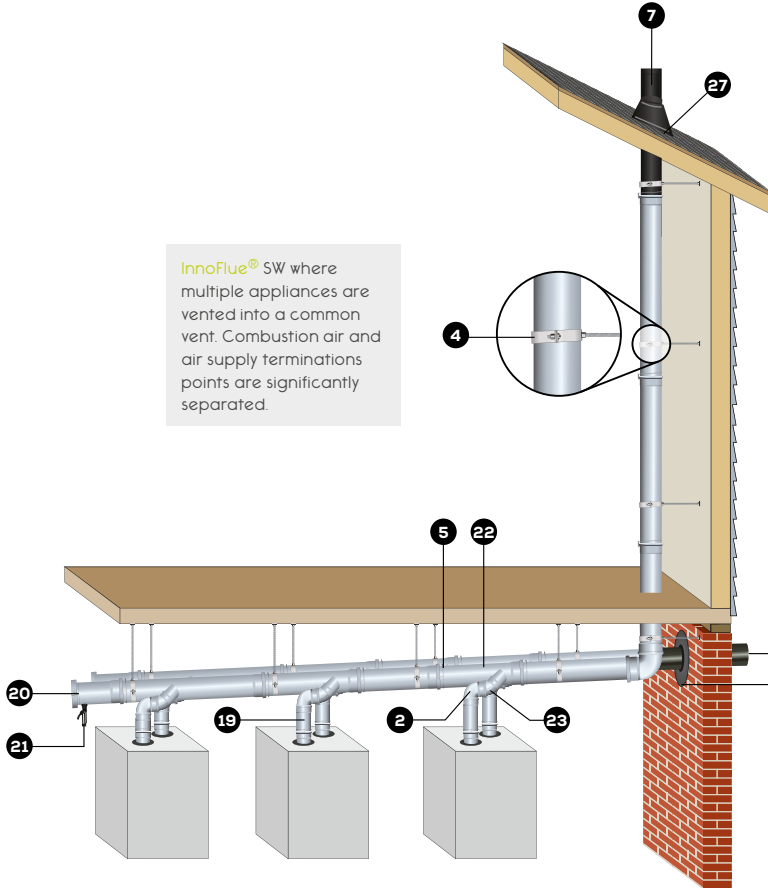

# Appliance Adaptors

Commercial appliance adaptors are made to order. Adaptors can be manufactured to fit any appliance. Call Centrotherm or visit [www.centrotherm.us.com](http://www.centrotherm.us.com) for a complete list of approved appliances.

Single Wall 6" – 12"



### Commercial Appliance Adaptor for Coupler Style Flue Collar

Adapts a female PVC / CPVC coupler or appliance flue exhaust to InnoFlue® SW diameters.

Nominal Diameter PVC to PP	Part	Overall Length <b>A</b>	Max O.D. <b>B</b>
6"/6" (168/160)	ISAGL0606	7.6 (194)	7.0 (178)

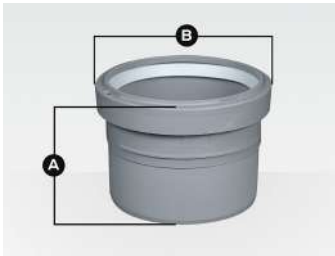

### Commercial Appliance Adaptor for Flue Collar with Hose Clamp

Adapts a female PVC / CPVC diameter appliance flue exhaust (with integrated gasket) to InnoFlue® SW diameters.

Nominal Diameter PVC to PP	Part	Overall Length <b>A</b>	Max O.D. <b>B</b>
6"/6" (168/160)	ISAAL0606	7.6 (194)	7.0 (178)

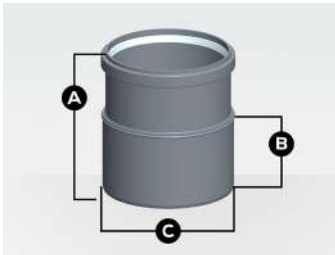

### Commercial PVC to PP Adaptor

Adapts a female PVC / CPVC diameter appliance flue exhaust (with integrated gasket) to InnoFlue® SW diameters.

Nominal Diameter PVC to PP	Part	Overall Length <b>A</b>	Effective Length <b>B</b>	Max O.D. <b>B</b>
8"/8" (219/220)	ISAA0808	9.5 (242)	5.6 (142)	8.8 (224)



### Commercial Appliance Adaptor w/ Condensate Drain and Vibration Isolation Boot OEM to InnoFlue®

Adapts boilers to InnoFlue®. Other increasing size combinations available upon request.

Nominal Diameter	Part	Overall Length <b>A</b>	Maximum OD <b>B</b>	Effective Length <b>C</b>
4" (110)	ISAACD0404	10.3 (262)	5.9 (150)	3.4 (86)
5" (125)	ISAACD0505	13.6 (345)	6.5 (165)	8.5 (216)
6" (160)	ISAACD0606	12.0 (305)	7.9 (201)	5.4 (137)
7" (180) to 8" (200)	ISAACD0708	16.5 (419)	9.5 (241)	9.7 (246)
8" (200)	ISAACD0808	16.5 (419)	9.5 (241)	9.7 (246)
9" (230) to 10" (250)	ISAACD0910	16.9 (429)	11.4 (290)	10.0 (254)
10" (250)	ISAACD1010	16.9 (429)	11.4 (290)	10.0 (254)
12" (315)	ISAACD1212	23.3 (542)	14.7 (373)	7.6 (191)

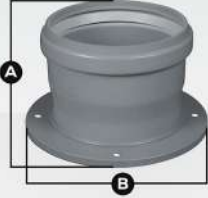

**Commercial Flanged Appliance Adaptor OEM to InnoFlue®**

Adapts InnoFlue® with bolt down flanged adaptor. Available for purchase through Centrotherm.

Nominal Diameter	Part	Overall Length A	Maximum OD B
3" (80)	ISAFLG03	3.7 (94)	8.8 (224)
4" (110)	ISAFLG04	4.7 (119)	8.8 (224)
6" (160)	ISAFLG06	4.3 (109)	8.8 (224)
8" (200)	ISAFLG08	6.2 (158)	11.3 (287)
10" (250)	ISAFLG10	6.2 (157)	15.0 (381)
12" (315)	ISAFLG12	13.2 (335)	15.0 (381)

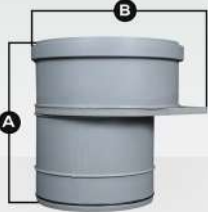

**Commercial Appliance Adaptor OEM to InnoFlue®**

Adapts boilers to InnoFlue®.

Nominal Diameter	Part	Overall Length A	Max O.D. B
7" (180) to 8" (200)	ISAF0708	9.0 (229)	8.8 (224)
8" (200)	ISAF0808	8.0 (204)	8.8 (224)
10" (250)	ISAF1010	8.0 (204)	10.8 (27)



**Commercial Appliance Adaptor SS to InnoFlue®**

Adapts stainless steel flue outlets to InnoFlue®. May require Vibration Isolation Boot.

Nominal Diameter SS to PP	Part	Overall Length A	Effective Length B	Max O.D. C
6"/6" (152/160)	ISSA0606	7.3 (185)	4.2 (107)	7.8 (183)
7" (180) to 8" (200)	ISSA0708	8.7 (221)	6.1 (155)	8.8 (224)
8"/8" 203/200	ISSA0808	8.9 (226)	5.0 (127)	8.8 (224)
10"/10" (254/250)	ISSA1010	8.9 (226)	5.0 (127)	10.7 (272)
12"/12" (305/315)	ISSA1212	16.9 (429)	4.2 (107)	13.8 (350)



**Vibration Isolation Boot with Clamps**

High temperature silicone boot seals InnoFlue® SW Vent lengths and Fittings to appliance flue outlet and minimizes vibration transfer from appliance to vent.

Nominal Diameter PVC to PP	Part	Width	ID
6" (160)	ISVIB06	2.4 (60)	6.3 (160)
8" (200)	ISVIB08	2.4 (60)	7.9 (200)
10" (250)	ISVIB10	2.4 (60)	9.8 (250)
12" (315)	ISVIB12	2.4 (60)	12.4 (315)

Single Wall 6" - 12"

Available	Custom Appliance Adaptors
	Appliance Adaptors are built to order. Contact your sales representative for pricing and availability. <a href="http://www.centrotherm.us.com">www.centrotherm.us.com</a>

## Increasers & Reducers

Single Wall 6" – 12"

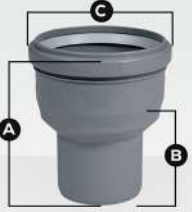

### Centric Increaser

Transitions vent system to a larger diameter. Install in vertical orientation only. Additional configurations available upon request.

Nominal Diameter	Part	Overall Length <b>A</b>	Effective Length <b>B</b>	Max O.D. <b>C</b>
4"/6" (110/160)	ISIA0406	7.6 (193)	4.8 (122)	7.2 (183)
5"/6" (125/160)	ISIA0506	7.2 (185)	4.3 (110)	7.2 (185)
6"/6" (150/160)	ISIA15006	7.7 (196)	4.9 (124)	7.2 (183)
6"/8" (160/200)	ISIA0608	10.4 (265)	6.5 (165)	8.8 (224)
6"/12" (160/315)	ISIA0612	18.1 (460)	5.4 (137)	13.8 (351)
8"/10" (200/250)	ISIA0810	11.6 (295)	7.7 (195)	10.7 (272)
10"/12" (250/315)	ISIA1012	18.2 (463)	5.5 (141)	13.8 (350)
300mm/12" (300/315)	ISIA30012	16.9 (429)	4.2 (107)	13.8 (350)



### Eccentric Increaser

Transitions vent system to a larger diameter. Install in horizontal or vertical orientation. Other size combinations available upon request.

Nominal Diameter	Part	Overall Length <b>A</b>	Effective Length <b>B</b>	Max O.D. <b>C</b>
4"/6" (110/160)	ISEI0406	9.2 (234)	6.4 (163)	7.2 (183)
5"/6" (125/160)	ISEI0506	7.2 (185)	4.3 (108)	7.2 (183)
6"/8" (160/200)	ISEI0608	10.4 (265)	6.5 (165)	8.8 (224)
6"/12" (160/315)	ISEI0612	18.1 (460)	5.4 (137)	13.8 (350)
8"/10" (200/250)	ISEI0810	11.8 (300)	7.8 (200)	10.7 (272)
8"/12" (200/315)	ISEI0812	16.9 (429)	4.2 (107)	13.8 (350)
10"/12" (250/315)	ISEI1012	20.2 (514)	7.8 (200)	13.8 (350)





**Reducer**

Transitions vent system to a smaller diameter.

Nominal Diameter	Part	Overall Length A	Effective Length B	Max O.D. C
8"/6" (200/160)	ISR0806	8.0 (204)	5.2 (133)	7.9 (201)
10"/8" (250/200)	ISR01008	9.2 (234)	5.2 (133)	9.9 (252)
12"/10" (315/250)	ISR01210	17.9 (455)	14.0 (356)	12.5 (318)

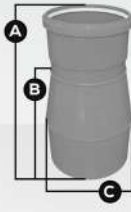

**Tapered Reducer**

Transitions vent system to a smaller diameter with minimal back pressure. Other sizes available. Please contact Centrotherm.

Nominal Diameter	Part	Overall Length A	Effective Length B	Max O.D. C
8"/6" (200/160)	ISTR0806	13.5 (343)	10.7 (272)	7.9 (200)
10"/6" (250/160)	ISTR1006	18.5 (409)	16.3 (414)	9.9 (250)
10"/8" (250/200)	ISTR1008	16.6 (422)	12.6 (320)	9.9 (250)

## Test Port

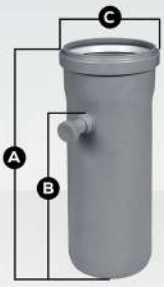

**Test Port**

Installed immediately above the appliance, the test port allows plumbing and heating professionals to sample flue gases and ensure the appliance is operating at optimum efficiency.

Nominal Diameter	Part	Overall Length A	Effective Length B	Max O.D. C
6" (160)	ISTP06	12.7 (323)	9.8 (250)	7.2 (183)
8" (200)	ISTP08	15.9 (405)	12.0 (305)	8.8 (224)
10" (250)	ISTP10	15.9 (405)	12.0 (305)	10.7 (272)
12" (315)	ISTP12	36.7 (932)	24 (610)	13.8 (350)

Single Wall 6" - 12"

## Vent Lengths

Single Wall 6" – 12"

		Rigid Vent Length		
		Rigid polypropylene vent lengths with dedicated male and female ends. Female ends contain internal gasket and male ends can be field cut and chamfered to desired length.		
Nominal Diameter	Part	Overall Length A	Effective Length B	Max O.D. C
6" (160)	ISVL061	15.5 (345)	12 (305)	7.2 (183)
6" (160)	ISVL062	27.5 (700)	24 (610)	7.2 (183)
6" (160)	ISVL063	39.5 (1004)	36 (914)	7.2 (183)
6" (160)	ISVL066	75.5 (1919)	72 (1829)	7.2 (183)
6" (160)	ISVL0610	124.25 (3162)	120 (3048)	7.2 (183)
8" (200)	ISVL081	16.00 (412)	12 (305)	8.8 (224)
8" (200)	ISVL082	28.2 (716)	24 (610)	8.8 (224)
8" (200)	ISVL083	40.2 (1021)	36 (914)	8.8 (224)
8" (200)	ISVL086	76.2 (1935)	72 (1829)	8.8 (224)
8" (200)	ISVL0810	124.5 (3162)	120 (3048)	8.8 (224)
10" (250)	ISVL101	16.00 (410)	12 (305)	10.7 (272)
10" (250)	ISVL102	28.2 (715)	24 (610)	10.7 (272)
10" (250)	ISVL103	40.2 (1019)	36 (914)	10.7 (272)
10" (250)	ISVL106	76.2 (1934)	72 (1829)	10.7 (272)
10" (250)	ISVL1010	123.9 (3147)	120.0 (3048)	10.7 (242)
12" (315)	ISVL122	36.7 (932)	24 (610)	13.8 (350)
12" (315)	ISVL123	48.7 (1236)	36 (914)	13.8 (350)
12" (315)	ISVL126	84.7 (2151)	72 (1829)	13.8 (350)
12" (315)	ISVL129	120.6 (3063)	108.0 (2743)	13.8 (350)

## Elbows and Tees

		15° Elbow		
		For offsets or changes the direction of the vent system.		
Nominal Diameter	Part	Centerline Offset A	Effective Length B	Max O.D. C
6" (160)	ISEL0615	1.0 (25)	5.1 (130)	7.2 (183)
10" (250)	ISEL1015	1.9 (48)	10.6 (269)	10.7 (272)
12" (315)	ISEL1215	4.4 (112)	18.7 (475)	13.8 (350)

		8" Zero Radius 15° Elbow			
		For offsets or changes in the direction of the vent system.			
Nominal Diameter	Part	Centerline Offset A	Effective Length B	Max O.D. C	Zeta Value
8" (160)	ISELS0815	1.18 (30)	5.55 (232)	9.1 (232)	.10



**30° Elbow**

For offsets or changes in the direction of the vent system.

Nominal Diameter	Part	Centerline Offset <b>A</b>	Effective Length <b>B</b>	Max O.D. <b>C</b>
6" (160)	ISEL0630	2.1 (53)	5.8 (147)	7.2 (183)
10" (250)	ISEL1030	4.3 (109)	12.6 (320)	10.7 (272)
12" (315)	ISEL1230	9.3 (21.4)	21.4 (544)	13.8 (350)



**8° Zero Radius 30° Elbow**

For offsets or changes in the direction of the vent system.

Nominal Diameter	Part	Centerline Offset <b>A</b>	Effective Length <b>B</b>	Max O.D. <b>C</b>	Zeta Value
8" (160)	ISELS0830	2.6 (67)	6.46 (164)	9.1 (232)	.20



**45° Elbow**

For offsets or changes in the direction of the vent system.

Nominal Diameter	Part	Centerline Offset <b>A</b>	Effective Length <b>B</b>	Max O.D. <b>C</b>
6" (160)	ISEL0645	3.2 (81)	5.5 (138)	7.2 (183)
6" (160)	ISEL0645UV	3.2 (81)	5.5 (138)	7.2 (183)
10" (250)	ISEL1045	4.1 (105)	14.3 (364)	10.7 (272)
12" (315)	ISEL1245	5.5 (139)	23.6 (599)	13.8 (350)

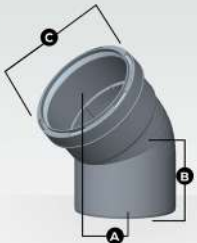

**8° Zero Radius 45° Elbow**

For offsets or changes in the direction of the vent system.

Nominal Diameter	Part	Centerline Offset <b>A</b>	Effective Length <b>B</b>	Max O.D. <b>C</b>	Zeta Value
8" (200)	ISELS0845	4.3 (115)	7.22 (183)	9.1 (232)	.40

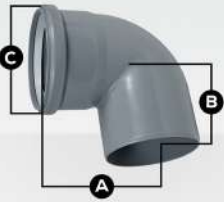

**87° Elbow**

For offsets or changes in the direction of the vent system.

Nominal Diameter	Part	Centerline Offset <b>A</b>	Effective Length <b>B</b>	Max O.D. <b>C</b>
6" (160)	ISEL0687	3.4 (86)	6.3 (160)	7.2 (183)
6" (160)	ISEL0687UV	3.4 (86)	6.3 (160)	7.2 (183)
10" (250)	ISEL1087	11.3 (287)	15.7 (399)	10.7 (272)
12" (315)	ISEL1287	14.3 (364)	25.7 (653)	13.8 (350)

Single Wall 6" - 12"

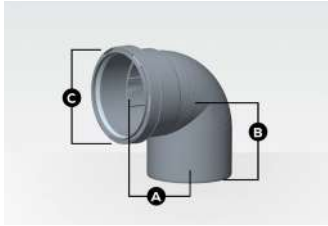

### 8° Zero Radius 87° Elbow

For offsets or changes in the direction of the vent system.

Nominal Diameter	Part	Centerline Offset A	Effective Length B	Max O.D. C	Zeta Value
8" (200)	ISELS0887	12.4 (316)	8.3 (212)	9.1 (232)	.96

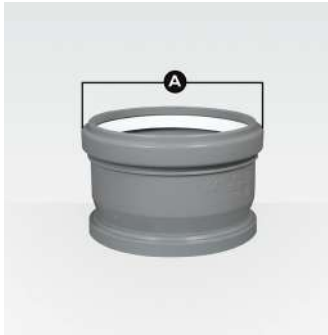

### Tee Cap

Seals non-utilized tees and branch tees.

Nominal Diameter	Part	Max O.D. A
6" (160)	ISTC06	7.3 (185)
8" (200)	ISTC08	8.8 (224)
10" (250)	ISTC10	10.7 (272)
12" (315)	ISTC12	13.8 (350)

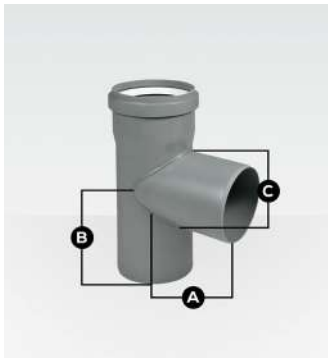

### Tee

Use to change the direction of the vent system, combine multiple appliances, and capture condensates at base of long vertical runs.

Nominal Diameter	Part	Effective Length A	Effective Length B	Effective Length C
6" (160)	IST06	6.6 (168)	11.2 (284)	4.1 (105)
8" (200)	IST08	8.5 (215)	15.2 (387)	6.5 (165)
10" (250)	IST10	16.5 (419)	16.5 (420)	7.0 (179)
12" (315)	IST12	19.7 (500)	28.7 (728)	7.5 (189.5)

## Base Supports

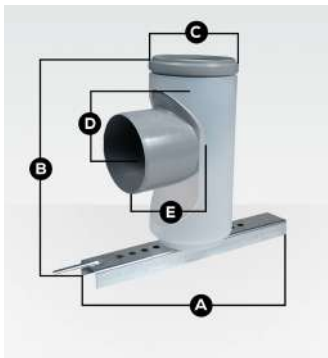

### Base Support

Supports vertical sections of rigid (up to 164') vent lengths installed in chimneys and chases.

Nominal Diameter	Part	Base Length A	Height B	Max O.D. C	Effective D	Effective E
6" (160)	ISBS0687	15.8 (400)	13.2 (335)	7.2 (183)	3.7 (93)	6.1 (156)
8" (200)	ISBS0887	15.8 (400)	22.7 (577)	8.8 (224)	10.2 (260)	13.5 (342)
10" (250)	ISBS1087	27.6 (700)	29.5 (750)	10.7 (272)	12.1 (307)	15.1 (383)
12" (315)	ISBS1287	27.6 (700)	46.9 (1191)	13.8 (350)	15.7 (398)	24.9 (633)

# Common Venting and Condensate Management

Branch Tees						
42° Y allows for the cascading or common venting of appliances. Other size configuration available upon request. Custom branch tees available. Contact Centrotherm for more information						
Nominal Diameter	Part	Overall Length A	Effective Length B	Feeder Diameter C	Feeder Length D	Offset E
3" (80)	ISBT030236	40.4 (1026)	36 (914)	2" (60)	6 (152)	6.5 (165)
4" (110)	ISBT040236	38.8 (986)	36 (914)	2" (60)	6 (152)	7.3 (185)
4" (110)	ISBT040336	38.8 (986)	36 (914)	3" (80)	6 (152)	7.5 (191)
5" (125)	ISBT050236	39.1 (993)	36 (914)	2" (60)	6 (152)	7.6 (193)
5" (125)	ISBT050336	39.1 (993)	36 (914)	3" (80)	6 (152)	7.9 (201)
5" (125)	ISBT050436	39.1 (993)	36 (914)	4" (110)	6 (152)	8.3 (211)
6" (160)	ISBT060236	40 (1016)	36 (914)	2" (60)	6 (152)	8.3 (211)
6" (160)	ISBT060336	40 (1016)	36 (914)	3" (80)	6 (152)	8.6 (218)
6" (160)	ISBT060436	40 (1016)	36 (914)	4" (110)	6 (152)	9 (229)
6" (160)	ISBT060536	40 (1016)	36 (914)	5" (125)	6 (152)	9.2 (234)
8" (200)	ISBT080236	40 (1016)	36 (914)	2" (60)	6 (152)	9.1 (231)
8" (200)	ISBT080336	40 (1016)	36 (914)	3" (80)	6 (152)	9.4 (239)
8" (200)	ISBT080436	40 (1016)	36 (914)	4" (110)	6 (152)	9.8 (249)
8" (200)	ISBT080536	40 (1016)	36 (914)	5" (125)	6 (152)	10 (254)
8" (200)	ISBT080636	40 (1016)	36 (914)	6" (160)	6 (152)	10.6 (269)
10" (250)	ISBT100236	40 (1016)	36 (914)	2" (60)	6 (152)	10.1 (257)
10" (250)	ISBT100336	40 (1016)	36 (914)	3" (80)	6 (152)	10.3 (262)
10" (250)	ISBT100436	40 (1016)	36 (914)	4" (110)	6 (152)	10.8 (274)
10" (250)	ISBT100536	40 (1016)	36 (914)	5" (125)	6 (152)	11 (279)
10" (250)	ISBT100636	40 (1016)	36 (914)	6" (160)	6 (152)	11.7 (297)
10" (250)	ISBT100836	40 (1016)	36 (914)	8" (200)	6 (152)	12.1 (307)
12" (315)	ISBT120236	49 (1245)	36 (914)	2" (60)	6 (152)	11.1 (282)
12" (315)	ISBT120336	49 (1245)	36 (914)	3" (80)	6 (152)	11.3 (287)
12" (315)	ISBT120436	49 (1245)	36 (914)	4" (110)	6 (152)	11.7 (297)
12" (315)	ISBT120536	49 (1245)	36 (914)	5" (125)	6 (152)	11.8 (300)
12" (315)	ISBT120636	49 (1245)	36 (914)	6" (160)	6 (152)	12.2 (310)
12" (315)	ISBT120836	49 (1245)	36 (914)	8" (200)	6 (152)	12.6 (320)
12" (315)	ISBT121036	49 (1245)	36 (914)	10" (250)	6 (152)	13.1 (333)

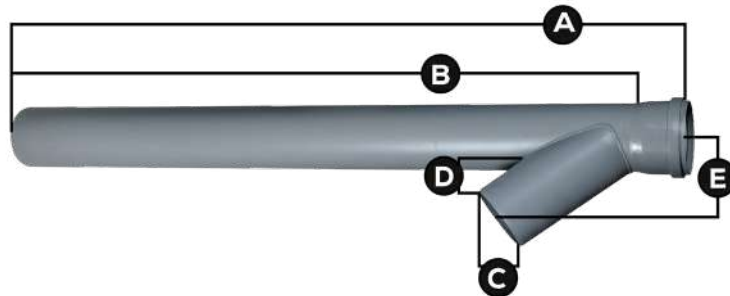

Single Wall 6" - 12"

Available

Cascade Component Kits

Available in various sizes and configurations. Contact your sales representative for more information.

Common Vent Kit Example:



Single Wall 6" – 12"

Horizontal Drain Tee

Use to drain condensate from the vent system. Install in horizontal section closest to appliance. 1.26" (32mm) O.D. drain. Use with any InnoFlue® Siphon.

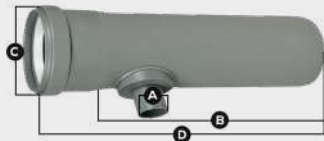

Nominal Diameter	Part	Drain O.D. A	Effective Length B	Max O.D. C	Overall Length D
2" (60)	ISHDT02	1.3 (32)	7.3 (186)	3 (76)	9.8 (250)
3" (80)	ISHDT03	1.3 (32)	7.3 (186)	3.7 (94)	9.8 (250)
4" (110)	ISHDT04	1.3 (32)	9.8 (250)	4.1 (129)	12.4 (315)
6" (160)	ISHDT06	1.3 (32)	9.8 (250)	7.2 (183)	12.4 (315)
8" (200)	ISHDT08	1.3 (32)	12.0 (305)	8.8 (224)	16.0 (405)
10" (250)	ISHDT10	1.3 (32)	12.0 (305)	10.7 (272)	16.0 (405)
12" (315)	ISHDT12	1.3 (32)	24.0 (1610)	13.8 (350)	36.7 (1932)

Horizontal Drain Fitting

Use with any InnoFlue® siphon. Placed at the end of the last Branch Tee in a cascade configuration, the Horizontal Drain Fitting removes condensate from the system and allows for inspections and system clean out. 32mm O.D. drain.



Nominal Diameter	Part	Drain O.D. A	Effective Length B	Max O.D. C	Overall Length D
4" (110)	ISHDF04	1.3 (32)	7.2 (182)	5.1 (129)	9.7
6" (160)	ISHDF06	1.3 (32)	8.1 (209)	7.2 (183)	12.1
8" (200)	ISHDF08	1.3 (32)	8.5 (215)	8.8 (224)	12.7
10" (250)	ISHDF10	1.3 (32)	13.8 (350)	10.7 (272)	18.0
12" (315)	ISHDF12	1.3 (32)	6.3 (160)	13.8 (350)	19.0



### Tee Cap with Drain

Use with any InnoFlue® siphon to drain condensate from the vent system.

Nominal Diameter	Part	Overall Length <b>A</b>	Max O.D. <b>B</b>
6" (160)	ISTCD06	6.9 (175)	7.2 (185)
8" (200)	ISTCD08	8.9 (225)	8.8 (224)
10" (250)	ISTCD10	8.9 (225)	10.7 (273)
12" (315)	ISTCD12	16.0 (407)	13.8 (351)

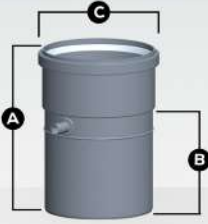

### Universal Condensate Drain

Use with any InnoFlue® siphon to drain condensate from the vent system.

Nominal Diameter	Part	Overall Length <b>A</b>	Effective Length <b>B</b>	Max O.D. <b>C</b>
6" (160)	ISUCD06	11.9 (302)	8.7 (220)	8.0 (204)
8" (200)	ISUCD08	11.9 (302)	7.7 (196)	9.6 (245)
10" (250)	ISUCD10	11.9 (302)	8.0 (202)	11.6 (295)



### Universal Ball Valve Siphon

Attaches to any InnoFlue® drain. Allows condensates to flow while unique ball valve assures combustion gases remain contained at higher temperatures. Comes with and can be installed with a barbed or compression fitting. See configuration options below.

Part	Overall Height <b>A</b>	Overall Length <b>B</b>	Overall Width <b>C</b>
IASJBVS	6.5	4.5	1.9



Compression



Barbed



Directional

Single Wall 6" - 12"

# Terminations

**NOTE: Roof Flashings Require a 10-Day Lead Time**

Single Wall 6" – 12"



Pitched Roof Flashing				
With field supplied sealant, stainless steel flashing creates watertight roof penetration when using InnoFlue commercial on a pitched roof.				
Nominal Diameter	Part	Length A	Width B	Height C
6"	IAPRF06	18"	*	*
8"	IAPRF08	20"	*	*
10"	IAPRF10	22"	*	*
12"	IAPRF12	24"	*	*
			*Dimensions vary based on pitch.	
Indicate required pitch at time of order				



Flat Roof Flashing				
With field supplied sealant, stainless steel flashing creates water-tight roof penetration when using InnoFlue commercial on a flat roof.				
Nominal Diameter	Part	Length A	Width B	Height C
6"	IAFRF06	18"	18"	13.3"
8"	IAFRF08	20"	20"	13.3"
10"	IAFRF10	22"	22"	13.8"
12"	IAFRF12	24"	24"	14.3"

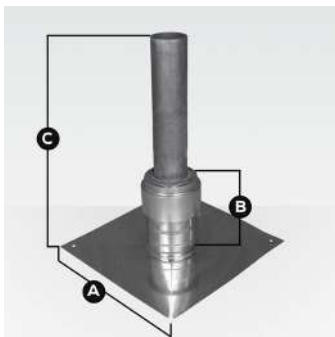

Chimney Cover SS with PP Gray End Pipe				
Stainless steel termination with polypropylene end pipe seals top of the chimney or chase.				
Nominal Diameter	Part	Length A	Height (min) B	Overall Height C
6"	ISCM06	15.8	15.9	Varies
8"	ISCM08	19.7	19.7	*
10"	ISCM10	20	20	*
12"	ISCM12	20	20	*

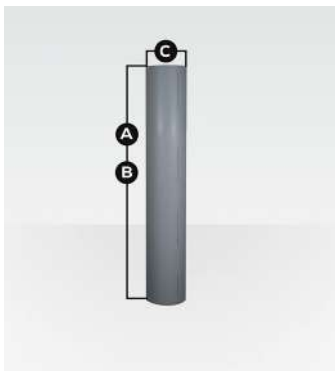

End Pipe PP – Gray				
PPs End Pipes allow for termination of the vent system through the wall or roof. (6' is UV black)				
Nominal Diameter	Part	Overall Length A	Effective Length B	Max O.D. C
6" (160)	ISEP06	20 (508)	20 (508)	6 (160)
6" (160)	ISEP0639	39 (991)	39 (991)	6 (160)
8" (200)	ISEP086	70 (1778)	70 (1778)	8 (200)
10" (250)	ISEP106	70 (1778)	70 (1778)	10 (250)
12" (315)	ISEP126	72 (1829)	72 (1829)	12 (315)



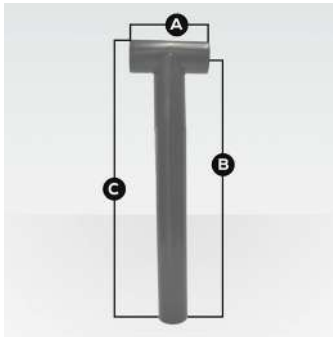

### Termination Tee (long)

Made from polypropylene. Use where termination is exposed to wind or prone to freeze ups.

Nominal Diameter	Part	Length A	Width B	Height C
6"	ISTT0620	9.0	27.9	31.1
8"	ISTT0820	16.0	28.1	32.0
10"	ISTT1020	20.5	27.3	32.2
12"	ISTT1220	21.9	35.3	41.5



### Velocity Cone

Made to order. Call for more information.

Nominal Diameter	Part
3" to 2"	ISVC0302
4" to 3"	ISVC0403
6" to 4"	ISVC0604
8" to 6"	ISVC0806
10" to 6"	ISVC1006
10" to 8"	ISVC1008
12" to 10"	ISVC1210

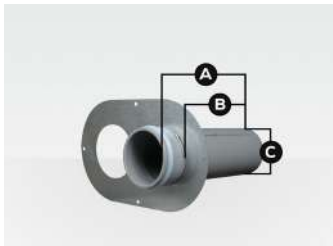

### PPs to PVC Termination Kit

Adapts PPs to PVC Twin Pipe Termination. Comes with replacement wall plate and termination adaptor.

Nominal Diameter	Part	Overall Length A	Effective Length B	End O.D. C
6" (160)	ISLTK06	14.4 (366)	11.0 (280)	6.5 (166)



### Low Profile Wall Termination (6')

Low Profile Wall Termination incorporates combustion air intake and exhaust into a single aesthetically pleasing termination. Part is paintable to match exterior of structure. Comes with interior wall plate and bird screen. Exhaust can be extended or re-directed with elbows or vent lengths. Vent lengths and elbows sold separately.

Nominal Diameter	Part	Overall Width A	Overall Height B	Offset
6" (160)	ISLPT0606	21.8 (553)	12.8 (324)	7.8 (197)

Single Wall 6" - 12"

## Accessories

Single Wall 6" – 12"



### Bird Screen PPs-UV

Fits inside InnoFlue® SW end pipes at terminations.

Nominal Diameter	Part
6" (160)	IASPP06



### Bird Screen SS

Fits inside InnoFlue® SW end pipes at terminations.

Nominal Diameter	Part
8" (200)	IASSS08
10" (250)	IASSS10
12" (315)	IASSS12

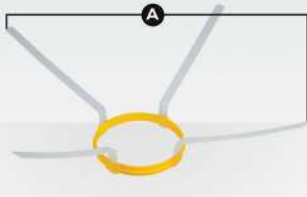

### 6" Spacers

Self-positioning spacers centers InnoFlue® SW in a chase/chimney/B-vent.

Nominal Diameter	Part	Max Width A	Min Width
6" (160)	IASP06	25.0 (635)	7 (186)



### 8", 10" and 12" Spacers

Self-positioning spacers centers InnoFlue® SW in a chase/chimney/B-vent.

Nominal Diameter	Part	Max Width A* (when bent)	Min Width
8" (200)	IASP08	27.6 (700)	9 (228)
10" (250)	IASP10	29.5 (750)	11 (276)
12" (315)	IASP12	32.1 (815)	13 (341)

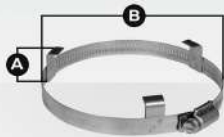

### Flue Clamp

Secures ISAG and ISAGL appliance adaptors to appliance flue exhaust.

Nominal Diameter	Part	Height A	Max. I.D. B
6" (160)	IAFC06	1.0 (26)	8.3 (211)

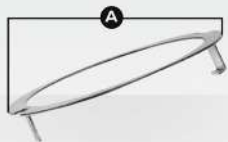

### Connector Ring

Provides reinforcement at joints to support loads of up to 99 lbs (45Kg). 6" through 12" connector rings are available but not required per UL 1738 and ULC-S636.

Nominal Diameter	Part	O.D. A
6" (160)	IANS06	7.5 (191)
8" (200)	IANS08	9.4 (239)
10" (250)	IANS10	10.7 (271)
12" (315)	IANS12	14.9 (378.5)

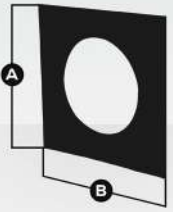

**Wall Plate Square (Plastic)**

Used to improve aesthetics and reduce drafts at chimney openings or wall penetrations.

Nominal Diameter	Part	Length A	Width B
6" (160)	IAWP06BP	9" (228)	9" (228)
8" (200)	IAWPP08	15.8" (401)	15.8" (401)
10" (250)	IAWPP10	16.0 (406)	16.0 (406)
12" (315)	IAWPP12	16.0 (406)	16.0 (406)



**Connector Double Hose Clamp**

Connection clamps provide mechanical connection as required by O.E.M.

Nominal Diameter	Part
6" (160)	IADHC0606
8" (200)	IADHC0808
10" (250)	IADHC1010
12" (315)	IADHC1212



**Support Clamp**

Used as vertical or horizontal support. Space 78" in vertical and 39" in horizontal installations. **Uses 3/8" threaded rod.**

Nominal Diameter	Part	Overall Length A	Height B
6" (160)	IASCM06	6.8 (172.7)	1.1 (28)
8" (200)	IASCM08	8.4 (213.3)	1.1 (28)
10" (250)	IASCM10	10.3 (261.6)	1.1 (28)
12" (315)	IASCM12	12.8 (325.1)	1.1 (28)



**EPDM Gaskets**

Standard gasket for 6" through 12" diameter InnoFlue® SW. Inserted into the female end of each part, the gaskets keep flue gases and condensates within the vent system.

Nominal Diameter	Part
6" (160)	ISGE06
8" (200)	ISGE08
10" (250)	ISGE10
12" (315)	ISGE12



**Centrocerin**

A water based lubricant used to ease the assembly of InnoFlue® SW & Flex. Sparingly applied to the gasket or male end.

Package Size	Part
50 ml	IACE50

Single Wall 6" - 12"

Flex

**Flex**

# Typical configurations

- 2 ISEL87: 87° Elbow
- 3 ISVL: Vent Length
- 4 IASCM: Support Clamp
- 5 IANS: Connector Ring
- 6 IAWP: Wall Plate
- 7 ISEP: End Pipe PPs-UV
- 9 IASPP: Bird Screen PPs-UV
- 12 Appliance Adaptor  
(See OEM approval Matrix)
- 24 ISBS: Base Support
- 25 IASP: Spacer
- 27 IFVL: Flexible Vent Length
- 28 ISCP: Chimney Cover PPs-UV
- 29 IFEP: Flex End Pipe
- 36 IAUBV: Universal B-Vent Cap
- 37 IFPT: Custom Chimney Cover

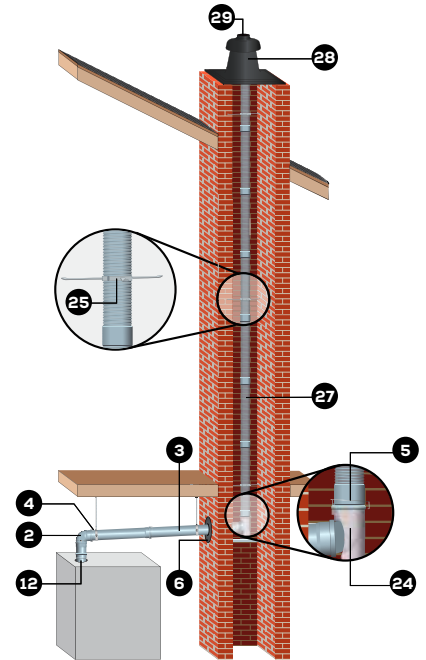
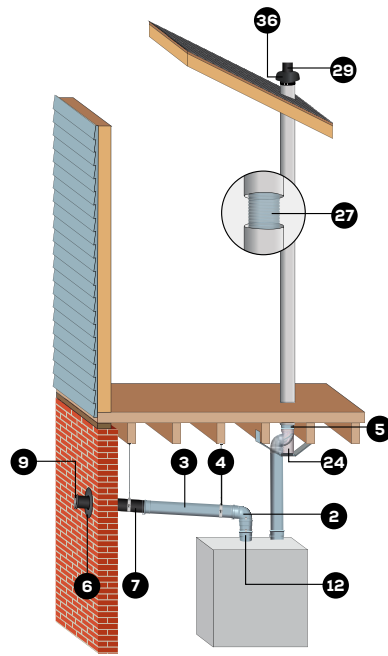

InnoFlue® SW and Flex installations, where InnoFlue® SW is used to pass flue gases to the base of a structurally intact metal chase, then InnoFlue® Flex to get them to the termination at the top. Combustion air is not supplied through the metal flue.

InnoFlue® SW and Flex installations, where InnoFlue® SW is used to pass flue gases to the base of the chimney, then InnoFlue® Flex to get them to the termination at the top.

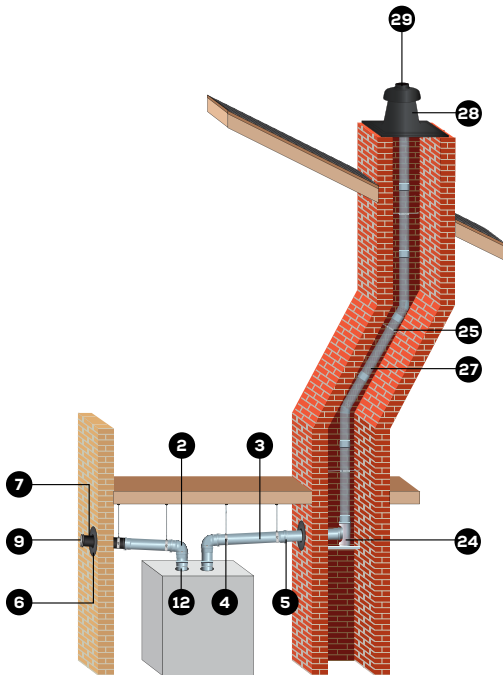

InnoFlue® SW and Flex installations, where InnoFlue® SW is used to pass flue gases to the base of the chimney, then InnoFlue® Flex to get them to the termination at the top. Combustion air is not supplied through the masonry chimney.

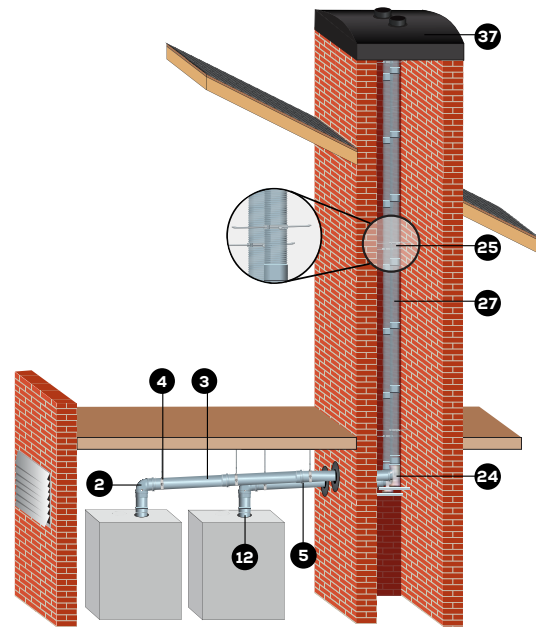

InnoFlue® SW and Flex installations, where InnoFlue® is used to pass flue gases of multiple appliances to the base of a structurally intact masonry chimney or metal flue, then InnoFlue® SW or Flex to get them to the Custom Chimney Cover at top.

Flex

## Flex Vent Lengths

		2" Flex		
		Is manufactured from polypropylene. 2" Flex can be field cut and is ideal for use in chimneys with offsets. With couplers, 2" Flex can be connected to 2" Flex or InnoFlue® SW.		
Nominal Diameter	Part	Coil Length	Max O.D.	
2" (60)	IFVL02025	25' (7.6m)	2.3 (58)	
2" (60)	IFVL02035	35' (10.7m)	2.3 (58)	
2" (60)	IFVL02050	50' (15.2m)	2.3 (58)	
2" (60)	IFVL02150	150' (45.7m)	2.3 (58)	

		3" and 4" Flex		
		Are manufactured from polypropylene and feature rigid sections every 2'. 3" and 4" Flex can be field cut and are ideal for use in chimneys with offsets. The base of your 3" and 4" Flex can be connected to InnoFlue® SW at any rigid section without coupler. Flex-to-Flex couplers available for extended flex runs.		
Nominal Diameter	Part	Coil Length	Max O.D.	
3" (80)	IFVL03025	25' (7.6m)	3.3 (84)	
3" (80)	IFVL03035	35' (10.7m)	3.3 (84)	
3" (80)	IFVL03040	40' (12.2m)	3.3 (84)	
3" (80)	IFVL03050	50' (15.2m)	3.3 (84)	
3" (80)	IFVL03150	150' (45.7m)	3.3 (84)	
4" (110)	IFVL04025	25' (7.6m)	4.3 (110)	
4" (110)	IFVL04035	35' (10.7m)	4.3 (110)	
4" (110)	IFVL04040	40' (12.2m)	4.3 (110)	
4" (110)	IFVL04050	50' (15.2m)	4.3 (110)	
4" (110)	IFVL04080	80' (24.4m)	4.3 (110)	

## Base Supports



### Base Support

Supports vertical sections of rigid (up to 164') and flexible (up to 98' with Flex end pipe) vent lengths installed in chimneys and chases.

Nominal Diameter	Part	Base Length A	Height B	Max O.D. C	Effective D	Effective E
2" (60)	ISBS0287	15.8 (400)	9.4 (238)	3.0 (76)	2.7 (69)	4.6 (118)
3" (80)	ISBS0387	15.8 (400)	10.6 (269)	3.8 (97)	3.4 (86)	4.9 (125)
4" (110)	ISBS0487	15.8 (400)	11.5 (291)	5.1 (129)	2.6 (65)	4.5 (115)

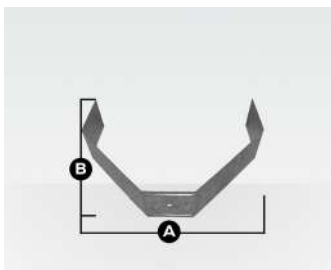

### Base Support Bracket

B-Vent Support Bracket (IABVSB) replaces metal channel on base support to support vertical sections of rigid and flexible vent lengths installed inside a B-Vent. Fastens to floor joists.

Part	Width A	Height B
IABVSB	17.5 (446)	11.8 (298)

## Couplers and Accessories

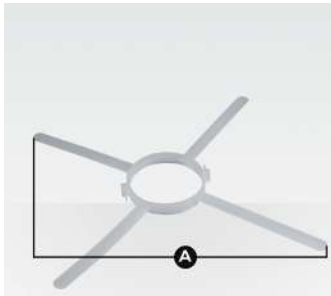

### 2", 3", and 4" Spacers

Self-positioning spacers center InnoFlue® SW or Flex in a chase/chimney/B-vent.

Nominal Diameter	Part	Max Width A	Min Width
2" (60)	IASP02	23.5 (596)	3.3 (85)
3" (80)	IASP03	22.8 (580)	4.2 (106)
4" (110)	IASP04	23.9 (606)	5.4 (138)



### 2" SW to Flex Coupler

Transitions 2" InnoFlue® Single Wall Rigid to 2" InnoFlue® Flex.

Nominal Diameter	Part	Overall Length A	Effective Length B	Max O.D. C
2" (60)	IFSC02	4.2 (107)	3.2 (81)	2.6 (65)

## InnoFlue® Polypropylene Vent Systems



### 2" Flex to SW Coupler

Transitions 2" InnoFlue® Flex to 2" InnoFlue® Single Wall Rigid.

Nominal Diameter	Part	Overall Length A	Max O.D. B
2" (60)	IFFSC02	3.9 (99)	3.0 (76)

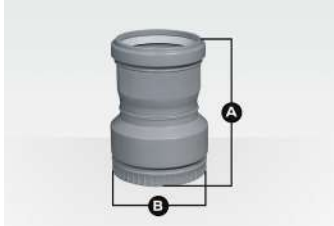

### 3" Flex to SW Coupler

Transitions InnoFlue® Flex to InnoFlue® Single Wall Rigid.

Nominal Diameter	Part	Overall Length A	Max O.D. B
3" (80)	IFFSC03	5.5 (138)	3.9 (100)

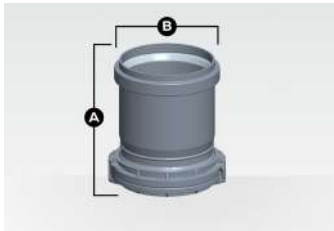

### 4" Flex to SW Coupler

Transitions InnoFlue® Flex to InnoFlue® Single Wall Rigid.

Nominal Diameter	Part	Overall Length A	Max O.D. B
4" (110)	IFFSC04	6.1 (156)	5.6 (139)

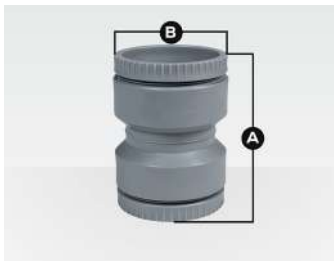

### 3" and 4" Flex to Flex Coupler

Connects 3" and 4" InnoFlue® Flex to 3" and 4" InnoFlue® Flex.

Nominal Diameter	Part	Overall Length A	Max O.D. B
3" (80)	IFFFC03	5.5 (141)	3.9 (100)
4" (110)	IFFFC04	6.7 (166)	5.1 (128)



### Connector Ring

Provides reinforcement at joints to support loads of up to 99 lbs (45Kg).

Nominal Diameter	Part	O.D. A
2" (60)	IANS02	3.2 (81)
3" (80)	IANS03	4.1 (103)
4" (110)	IANS04	5.3 (134)



## B-Vent Kits



### 2" B-Vent Kit

Includes all components necessary to line a B-Vent from base to termination. Rigid vent lengths, elbows, adaptors and other components required to connect B-Vent base support to appliance are sold separately.

Nominal Diameter	Part	Flex Vent Length
2" (60)	IFBK0225	25' (7.6m)
2" (60)	IFBK0235	35' (10.6m)
2" (60)	IFBK0250	50' (15.25m)

Kit contains B-Vent Support Bracket, Base Support, Single Wall-To-Flex Coupler, 2' Flex Vent, Flex End Pipe, Universal B-Vent Cap, Connector Ring, Spacers and Centrocerin®.



### 3" and 4" B-Vent Kit

Includes all components necessary to line a B-Vent from base to termination. Rigid vent lengths, elbows, adaptors and other components required to connect B-Vent base support to appliance are sold separately.

Nominal Diameter	Part	Flex Vent Length	B-Vent Diameter
3" (80)	IFBK0325	25' (7.6m)	4", 5", 6"
3" (80)	IFBK0335	35' (10.6m)	4", 5", 6"
3" (80)	IFBK0350	50' (15.25m)	4", 5", 6"
4" (110)	IFBK0425	25' (7.6m)	5", 6"
4" (110)	IFBK0435	35' (10.6m)	5", 6"
4" (110)	IFBK0440	40' (12.1m)	5", 6"

Kit contains Flex Vent, B-Vent Support Bracket, Base Support, Flex End Pipe, Universal B-Vent Cap, Connector Ring, Spacers and Centrocerin®.

## B-Vent Component Kits



### 2" Flex Component B-Vent Kit

Includes all fittings and accessories required to line a B-Vent excluding 2' flex. 2' flex and rigid vent length, elbows, adaptors required to connect B-Vent Base Support to appliance, and termination are sold separately.

Nominal Diameter	Part	B-Vent Diameter
2" (60)	IFBK02	4"

Kit includes B-Vent Support Bracket, Base Support, Single Wall-To-Flex Coupler, Flex End Pipe, Universal B-Vent Cap, Connector Ring, Spacers and Centrocerin. 2' Flex Vent and other components required.



### 3" and 4" Flex Component B-Vent Kit

Includes all fittings and accessories required to line a B-Vent excluding 3" or 4" Flex Vent, 3" or 4" flex and rigid vent lengths, elbows, adaptors and other components required to connect B-Vent Base Support to appliance, and termination are sold separately.

Nominal Diameter	Part	B-Vent Diameter
3" (80)	IFBKC03	4"
4" (110)	IFBKC04	5"

Kit includes B-Vent Support Bracket, Base Support, Flex End Pipe, Universal B-Vent Cap, Connector Ring, Spacers and Centrocerin.

## Chimney Kits



### 2" Chimney Kit

Includes all components necessary to line a chimney from chimney termination to Base Support. Rigid vent lengths, elbows, adaptors and other components required to connect chimney kit base support to appliance are sold separately. Custom flex lengths are available.

Nominal Diameter	Part	Flex Vent Length
2" (60)	IFCK0225	25' (7.6m)
2" (60)	IFCK0235	35' (10.7m)
2" (60)	IFCK0250	50' (15.2m)

Kit contains Base Support, Single Wall to Flex Coupler, Flex Vent Length, Flex End Pipe, Chimney Cover, Connector Ring, Spacers and Centrocerin.



### 3" and 4" Chimney Kit

Includes all components necessary to line a chimney from chimney termination to Base Support. Rigid vent lengths, elbows, adaptors and other components required to connect chimney kit base support to appliance are sold separately. Custom flex lengths are available.

Nominal Diameter	Part	Flex Vent Length
3" (80)	IFCK0325	25' (7.6m)
3" (80)	IFCK0335	35' (10.7m)
3" (80)	IFCK0350	50' (15.2m)
4" (110)	IFCK0425	25' (7.6m)
4" (110)	IFCK0435	35' (10.7m)
4" (110)	IFCK0440	40' (12.2m)
4" (110)	IFCK0450	50' (15.2m)

Kit contains Base Support, Flex Vent Length, Flex End Pipe, Chimney Cover, Connector Ring, Spacers and Centrocerin.

Flex

## Chimney Component Kits



**2" Flex Component Chimney Kit**

Includes all components necessary to line a chimney from chimney termination to Base Support excluding 2' flex vent, 2' flex and rigid vent lengths, elbows, adaptors and other components required to connect Base Support to appliance, and termination are sold separately.

Nominal Diameter	Part
2" (60)	IFCKC02

Kit contains Base Support, Single Wall to Flex Coupler, Chimney Cover, Flex End Pipe, Connector Ring, Spacers and Centrocerin.



**3" and 4" Flex Component Chimney Kit**

Includes all components necessary to line a chimney from chimney termination to Base Support excluding 3' or 4' flex vent, 3' or 4' flex and rigid vent lengths, elbows, adaptors and other components required to connect Base Support to appliance, and termination are sold separately.

Nominal Diameter	Part
3" (80)	IFCKC03
4" (110)	IFCKC04

Kit contains Base Support, Chimney Cover, Flex End Pipe, Connector Ring, Spacers and Centrocerin.

## Terminations



**Chimney Cover PP's-UV**

This termination incorporates a combustion air intake and flue gas termination in a single assembly. Cover seals top of the chimney or chase. Use with End Pipe or Flex End Pipe. End Pipes sold separately.

Nominal Diameter	Part	Length <b>A</b>	Height <b>B</b>
2" (60)	ISCP02	15.8 (400)	9.6 (245)
3" (80)	ISCP03	15.8 (400)	9.6 (245)
4" (110)	ISCP04	15.8 (400)	9.6 (245)

**Available**

**Custom Chimney Cover PP's-UV**

Custom Chimney Cover sizes available, including multiple flue versions. Call with size requirements for pricing.



### 2" Flex End Pipe

Terminates InnoFlue® Flex Vent at top of chimney. Used in combination with Chimney Cover PPs-UV or B-Vent Cap

Nominal Diameter	Part	Overall Length A	Effective Length B	Max O.D. C
2" (60)	IFEP02	5.3 (135)	4.1 (105)	3.9 (99)



### 3" and 4" Flex End Pipe

Terminates InnoFlue® Flex Vent at top of chimney. Used in combination with Chimney Cover PPs-UV or B-Vent Cap

Nominal Diameter	Part	Overall Length A	Effective Length B	Max O.D. C
3" (80)	IFEP03	7.1 (180)	3.3 (84)	3.9 (100)
4" (110)	IFEP04	10.0 (253)	3.5 (89)	5.2 (132)



### Universal B-Vent Cap

Allows for multiple flue configurations. Utilize existing B-Vent as a chase. Clean, professional and aesthetically pleasing. Installs quickly and easily.

Part	Length	Height	Width
IAUBVC	10"	10"	10"



One Part Multiple Configurations

Concentric

# Concentric



## Typical configurations

- 4 IASCM: Support Clamp
- 6 IAWP: Wall Plate
- 15 ICRT: Concentric Roof Termination
- 31 ICTP: Concentric Test Port
- 32 ICEL45: Concentric 45° Elbow
- 33 ICVL: Concentric Vent Length
- 34 ICEL87: Concentric 87° Elbow
- 35 ICWT: Concentric Wall Termination PP

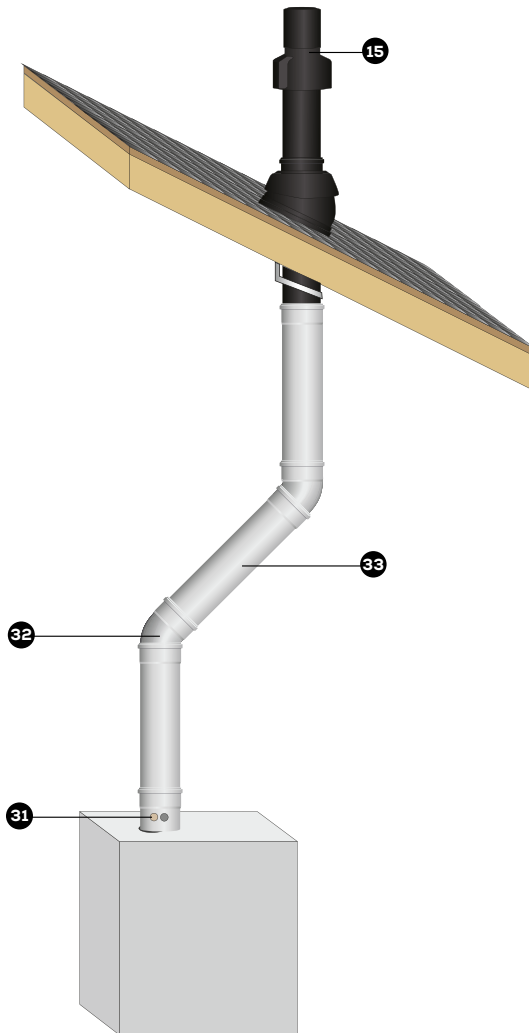

InnoFlue® Concentric installations where combustion air and air intake points are co-located above the roof line.

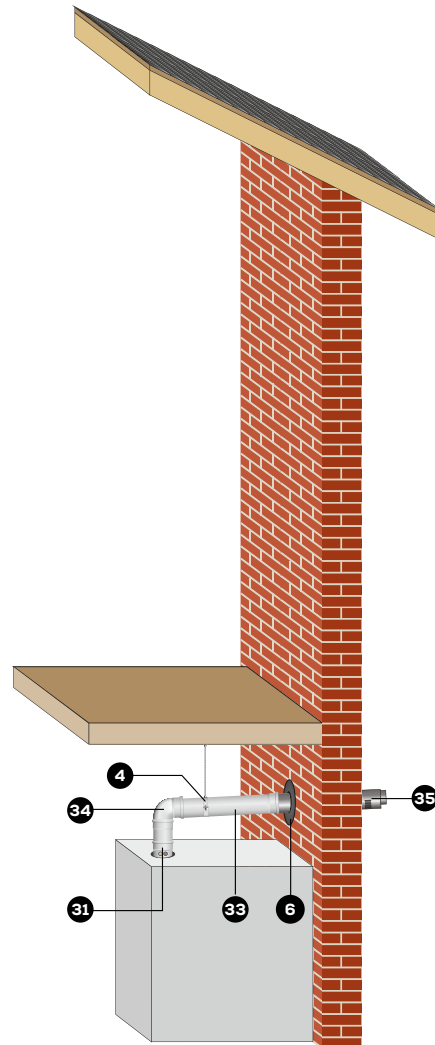

InnoFlue® Concentric installations where combustion air and air intake points are co-located.

# Concentric Adaptors



## Concentric Centric Increaser

Transitions from one diameter to a larger diameter. Install in vertical orientation only.

Nominal Diameter	Part	Overall Length A	Effective Length B	Max O.D. C
4"/6" (100/150mm)	ICIA10015046	6.0 (163)	4.1 (105)	6.8 (173)
4"/6" (110/150mm)	ICIA11015046	6.0 (163)	4.1 (105)	6.8 (173)

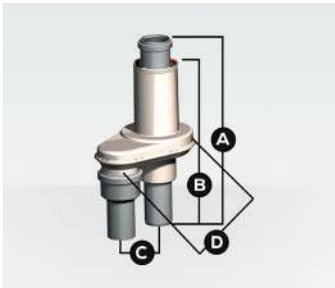

## Reversible Concentric / Twin Pipe Adaptor

Reversible adaptor transitions between 2" InnoFlue® Single Wall and 2 1/4" InnoFlue® Concentric. Reducer and vent length included.

Nominal Diameter	Part	Overall Length A	Effective Length B	Center to Center C	Width D
2"/4" (60/100)	ICTCR24	16.4 (411)	12 (305)	4.76 (120)	10.0 (254)

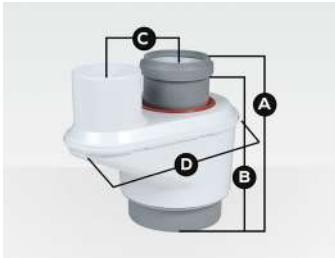

## Reversible Concentric / Twin Pipe Adaptor

Reversible adaptor transitions between 3" InnoFlue® Single Wall and 3 1/5" InnoFlue® Concentric.

Nominal Diameter	Part	Overall Length A	Effective Length B	Offset C	Width D
3"/5" (80/125)	ICCT3503	9.8 (250)	5.9 (150)	4.8 (121)	10.5 (267)



## Twin Pipe to Concentric Adaptor

Adaptor transitions between twin pipe 4" InnoFlue® Single Wall to 4 1/6" InnoFlue® Concentric.

Nominal Diameter	Part	Overall Length A	Effective Length B	Centerline Offset C
4"/6" (110/160)	ICTC0446	14.5 (316)	10.0 (25.3)	8.8 (224)

## Condensate Management

Concentric

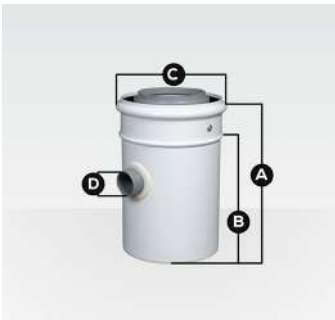

### Concentric Horizontal Drain Tee

Use to drain condensate from the vent system. Install in horizontal section closest to appliance.

Nominal Diameter	Part	Overall Length A	Effective Length B	Max O.D. C	Drain O.D. D
2"/4" (60/100)	ICHDT24	7.9 (200)	5.9 (150)	4.4 (112)	1.4 (32)
3"/5" (80/125)	ICHDT35	7.9 (200)	5.9 (150)	5.5 (139)	1.4 (32)
4"/6" (110/160)	ICHDT46	7.9 (200)	5.9 (150)	6.8 (173)	1.4 (32)



### Universal Ball Valve Siphon

Attaches to any InnoFlue® drain. Allows condensates to flow while unique ball valve assures combustion gases remain contained at higher temperatures. Comes with and can be installed with a barbed or compression fitting. See configuration options below.

Part	Overall Height A	Width B	Length C
IASJBVS	6.5	4.5	1.9



Compression



Barbed



Directional

## Concentric Test Ports

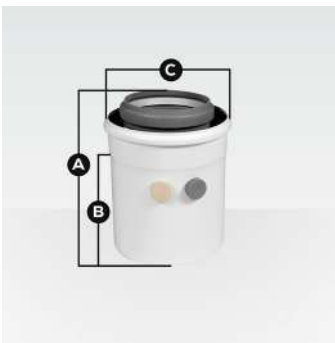

### Concentric Test Port

Installed immediately above the appliance, the test port allows plumbing and heating professionals to sample flue gases and ensure the appliance is operating at optimum efficiency.

Nominal Diameter	Part	Overall Length A	Effective Length B	Max O.D. C
2"/4" (60/100)	ICTP24	6.7 (170)	4.3 (110)	4.4 (112)
3"/5" (80/125)	ICTP35	16.2 (412)	12.0 (305)	5.8 (146)
4"/6" (110/160)	ICTP46	8.1 (207)	5.6 (143)	6.8 (173)



# Concentric Vent Lengths



**Concentric Vent Lengths**

Rigid polypropylene vent lengths with metal outer and dedicated male and female ends. Female end contains internal gasket and male ends can be field cut and chamfered to desired length.

Nominal Diameter	Part	Overall Length A	Effective Length B	Max O.D. C
2"/4" (60/100)	ICVL241	14.5 (368)	12 (305)	4.4 (112)
2"/4" (60/100)	ICVL242	26.5 (673)	24 (610)	4.4 (112)
2"/4" (60/100)	ICVL243	38.5 (978)	36 (914)	4.4 (112)
3"/5" (80/125)	ICVL351	14.5 (368)	12 (305)	5.5 (139)
3"/5" (80/125)	ICVL352	26.5 (673)	24 (610)	5.5 (139)
3"/5" (80/125)	ICVL353	38.5 (978)	36 (914)	5.5 (139)
4"/6" (110/160)	ICVL461	14.5 (368)	12 (305)	6.8 (173)
4"/6" (110/160)	ICVL462	26.5 (673)	24 (610)	6.8 (173)
4"/6" (110/160)	ICVL463	38.5 (978)	36 (914)	6.8 (173)

Concentric

# Elbows



**Concentric 45° Elbow**

For offsets or changes in the direction of the vent system.

Nominal Diameter	Part	Centerline Offset A	Effective Length B	Max O.D. C
2"/4" (60/100)	ICEL2445	.7 (18)	3.3 (85)	4.4 (112)
3"/5" (80/125)	ICEL3545	1.3 (34)	4.6 (117)	5.5 (139)
4"/6" (110/160)	ICEL4645	1.5 (39)	5.2 (133)	6.8 (173)



**Concentric 87° Elbow**

For offsets or changes in the direction of the vent system.

Nominal Diameter	Part	Centerline Offset A	Effective Length B	Max O.D. C
2"/4" (60/100)	ICEL2487	2.0 (50)	4.8 (123)	4.4 (112)
3"/5" (80/125)	ICEL3587	3.1 (79)	5.1 (129)	5.5 (139)
4"/6" (110/160)	ICEL4687	4.4 (111)	6.5 (165)	6.8 (173)

## Roof Flashing

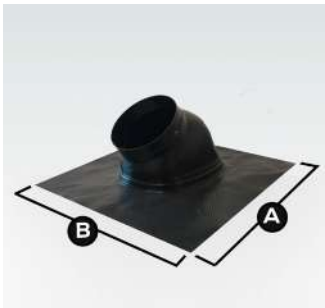

### Concentric Roof Flashing

Concentric PPs roof flashing creates watertight roof penetration when using InnoFlue® Concentric.

Nominal Diameter	Part	Overall Length A	Overall Length B
2"/4" (60/100) / 3"/5" (80/125)	ICRF2435	22.00	19.5
4"/6" (110/160)	ICRF46	22.00	19.5

## Terminations



### Concentric Roof Termination

Roof Termination combines flue gas termination and combustion air intake. Use with InnoFlue® Concentric or with InnoFlue® SW by adding an ICTC Adapter. Includes support clamp.

Nominal Diameter	Part	Overall Length A	Roof Line B	Max O.D. C
2"/4" (60/100)	ICRT2439	42.0	20.5	6.5
3"/5" (80/125)	ICRT3539	42.0	20.5	7.5
4"/6" (110/160)	ICRT4679	78.3	23.6	9.7



### Concentric Wall Termination

Made from PPs-UV outer and PPs-UV inner, the Concentric Wall termination incorporates flue gas termination and combustion air intake. Use with InnoFlue® Concentric or with InnoFlue® SW by adding an ICTC Adapter. Includes support clamp and wall plates.

Nominal Diameter	Part	Overall Length A	O.D. B
2"/4" (60/100)	ICWT242	21.2 (538)	5.54 (141)
3"/5" (80/125)	ICWT352	28.3 (719)	5 (125)

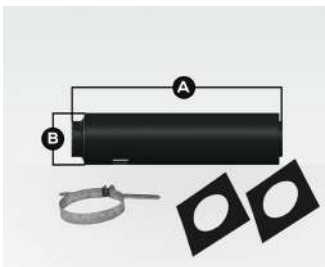

### Concentric Wall Termination

Made from PPs-UV outer and PPs-UV inner, the Concentric Wall termination incorporates flue gas termination and combustion air intake. Use with InnoFlue® Concentric or with InnoFlue® SW by adding an ICTC Adapter. Includes support clamp and wall plates.

Nominal Diameter	Part	Overall Length A	O.D. B
4"/6" (110/160)	ICWT462	32.0 (813)	6.3 (160)

## Concentric Kits



### Concentric Kit Horizontal

Concentric Side Wall Venting Kit contains components needed to vent wall mounted appliance to wall termination. Additional components may be required for longer runs and are sold separately.

Nominal Diameter	Part
2"/4" (60/100)	ICVKH24
3"/5" (80/125)	ICVKH35
4"/6" (110/160)	ICVKH46

Kit includes one 3' Concentric Vent Length, Concentric Elbow, Concentric Wall Termination, Wall Plates and Support Clamp.



### Concentric Kit Vertical

Concentric Vertical Venting Kit contains components needed to vent vertically through roof. Additional components may be required for longer runs and are sold separately.

Nominal Diameter	Part
2"/4" (60/100)	ICVKV24
3"/5" (80/125)	ICVKV35
4"/6" (110/160)	ICVKV46

Kit includes one 2' and one 3' Concentric Vent Length, Concentric Roof Termination, one Wall Plate and Support Clamp.

## Accessories



### Wall Plate

Provides an aesthetically pleasing and water tight finish at wall penetrations when sealed with field-supplied silicone.

Nominal Diameter	Part	Overall Diameter A	Width of Opening B
4" (100)	IAWP100B	5.6 (142)	4" (100)
5" (125)	IAWP05B	8.9 (226)	5" (125)

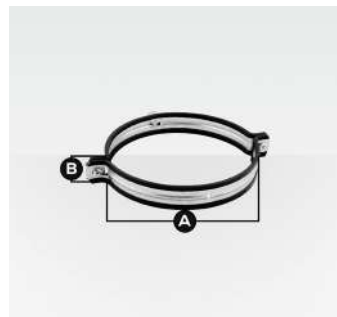

### Support Clamp

Used as vertical or horizontal support. Space 78" in vertical and 39" in horizontal installations. Uses 3/8" threaded rod.

Nominal Diameter	Part#	Overall Length A	Height B
4" (100)	IASCM100	5.3 (134.6)	1.1 (28)
5" (125)	IASCM05	5.8 (147.3)	1.1 (28)
6" (160)	IASCM06	6.8 (172.7)	1.1 (28)



# Centrotherm

solutions beyond

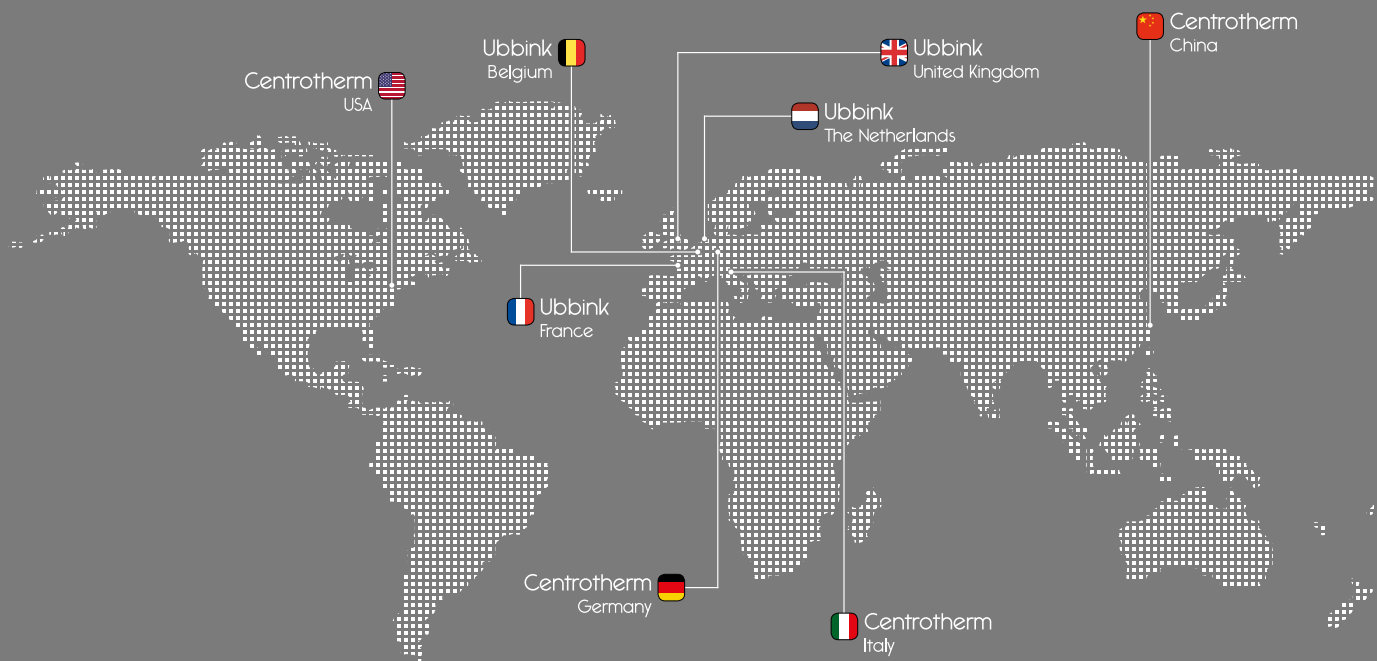

Ubbink Netherlands [www.ubbink.nl](http://www.ubbink.nl)

Ubbink Belgium [www.ubbink.be](http://www.ubbink.be)

Ubbink France [www.ubbink.fr](http://www.ubbink.fr)

Ubbink United Kingdom [www.ubbink.co.uk](http://www.ubbink.co.uk)

Ubbink International [www.ubbink.com](http://www.ubbink.com)

Centrotherm Germany [www.centrotherm.com](http://www.centrotherm.com)

Centrotherm Italy [www.centrotherm.it](http://www.centrotherm.it)

Centrotherm U.S.A. [www.centrotherm.us.com](http://www.centrotherm.us.com)

Centrotherm China [www.centrotherm-china.com](http://www.centrotherm-china.com)

[www.ubbink-centrotherm.com](http://www.ubbink-centrotherm.com)

## NORTH AMERICA

Centrotherm

Toll Free: 877 434 3432

Fax: 518 618 3166

[info@centrotherm.us.com](mailto:info@centrotherm.us.com)

[www.centrotherm.us.com](http://www.centrotherm.us.com)



IMCF2021