

# Oatey<sup>®</sup>SCS

SUPPLY CHAIN SERVICES



## CANADIAN PRODUCT CATALOGUE

# TABLE OF CONTENTS

<b>Plastic Pipe Cements and Primers.....</b>	<b>5</b>
<b>Thread Sealants and Leak Detectors.....</b>	<b>19</b>
<b>Copper Installation.....</b>	<b>26</b>
<b>Putty, Caulks, and Water Barriers.....</b>	<b>34</b>
<b>Oils, Lubricants, and Hand Cleaners.....</b>	<b>38</b>
<b>Drain and Waste System Cleaners.....</b>	<b>40</b>
<b>Heating Chemicals and Anti-Freeze.....</b>	<b>45</b>
<b>Bowl Setting Wax Gaskets and Bolts.....</b>	<b>52</b>
<b>Drains and Closet Flanges.....</b>	<b>55</b>
<b>Shower Systems.....</b>	<b>72</b>
<b>Supply Boxes.....</b>	<b>76</b>
<b>Flashings.....</b>	<b>93</b>
<b>Air Admittance Values (AAV).....</b>	<b>97</b>
<b>Pipe Support.....</b>	<b>101</b>
<b>Brass/Plastic Tubular, Grab Bars &amp; Pipe Wrap.....</b>	<b>110</b>
<b>Bath Waste and Overflow.....</b>	<b>113</b>
<b>Strainers.....</b>	<b>120</b>
<b>Pneumatic Pipe Plugs.....</b>	<b>122</b>
<b>Mechanical Pipe Plugs.....</b>	<b>131</b>
<b>Test Equipment, Drain Flushers, and Accessories.....</b>	<b>137</b>
<b>Pans and Stands.....</b>	<b>143</b>
<b>Commercial Drainage.....</b>	<b>146</b>
<b>Rough-In Products and Tools.....</b>	<b>151</b>



# POWER OF ONE

## The Power of One

**The Oatey Company** is the number one source for purchasing the leading brands in the plumbing and waterworks industries. You can purchase any of our brands easily and efficiently – on one invoice, in one shipment, with one phone call. Only Oatey brings you the plumbing industry's best brands in one source. That's why we're the choice for plumbing professionals. **Due to the dynamic nature of our broad product offering, please consult your price file for items stocked and supported in Canada.**

For more information on Oatey or our product offerings, please visit [Oatey.ca](http://Oatey.ca) or contact our customer service group at **800-321-9532**.

### TRUSTED

- Comprehensive technical support
- Reputable leadership in the plumbing industry
- Experienced customer service professionals

### STRONG

- Central distribution center in Brampton, ON
- Multiple manufacturing locations: Ohio, Nebraska, Minnesota and China
- ISO 9001 Certified
- Twenty-two categories with a broad range of products

### EFFICIENT

- EDI - Paperless ordering, invoices and ship notices
- Automatic acknowledgements and confirmations of shipments
- Economical minimum orders for prepaid freight
- Multi-branded Promotional Opportunities

### SAFE

- Compliant to hazmat policies
- Sustainable practices
- C-TPAT participant



**Oatey®** is the leading manufacturer of solvent cements, roof flashings, washing machine outlet boxes, air admittance valves, plumbing chemicals, wax bowl rings, and hundreds of other plumbing specialty products. Found in many residential and commercial applications, Oatey products have earned the trust of both plumbing professionals and consumers since 1916. Oatey Co. operates a comprehensive global manufacturing and distribution network, backed by experienced and responsive technical service professionals.



**MASTERS®** is Canada's leading brand of pipe thread sealants, copper installation products, and consumable plumbing goods. Founded by G.F. Thompson in 1947, we have been providing quality products under the MASTERS® brand name for over 70 years. Serving the Plumbing, HVAC, Industrial and Retail trades, we offer unparalleled product quality, industry-leading customer service and top-line representation in the field.



**Cherne®** is the recognized world leader in pipe plug and testing equipment manufacturing. In 1998, Cherne demonstrated its commitment to quality and continuous improvement by achieving ISO 9001 registration. Cherne is the only domestic pipe plug manufacturer to achieve this certification. Serving the plumbing and underground industries for more than 60 years, Cherne is dedicated to providing customers with unparalleled product quality in addition to the highest level of customer service. From plumbing to underground—we have your products in stock.



**Hercules®** brand plumbing chemicals have been found in plumber's tool collections for nearly 100 years. The company makes more than 100 different products including chemicals, putty, drain cleaners, hand towels and Megaloc® thread sealant and PTFE tapes.



**Dearborn Brass®** is the leading manufacturer of Brass and Plastic Tubular products for the plumbing industry. Included in our product offering are Commercial Tubular, Bath Waste and Overflow, Basket Strainers and Plumbing Specialties. Dearborn Brass has been successful for more than 100 years because of the commitment of our associates to provide superior quality products at competitive prices. The Dearborn Brass name has grown to become the preferred choice of plumbing professionals, widely recognized by its distinctive checkerboard packaging. Find the checkerboard and you've found assured quality and peace of mind.



**Keeney®** is a leading manufacturer and distributor of tubular drainage products. Founded in 1923, the Keeney and PlumbPak by Keeney families include coin air valves, under-sink drainage, quarter-turn valves, bath drains, toilet repair parts, Bélanger faucets, and more.



**QuickDrain™** products are designed for the Hospitality, Healthcare and Residential Markets. The QuickDrain system can adapt to almost any existing plumbing condition, slashes construction time, saves on cost and minimizes impact on customers.



**Harvey™** began in 1944, when Master Plumber William H. Harvey Sr. came up with the idea of a pre-formed wax gasket for setting toilet bowls. Nearly 70 years later, more than 3500 Harvey-brand plumbing specialty products are sold throughout North and South America.



# Category 1

## Plastic Pipe Cements and Primers

Oatey sells only Lo-VOC solvent cements, which means they are compliant with the South Coast Air Quality Management District (SCAQMD) Rule 1168 and the Ozone Transport Commission (OTC) standards. Plus they meet ASTM, NSF and UPC standards for a wide variety of applications, including potable water, DWV, industrial, pool/spa, turf/irrigation, sewer and many more. With Oatey you get more than just the strongest solvent welded joint – you get the confidence of the top selling brands, backed by years of extensive research and leadership in the plumbing industry. That’s why Oatey has been the choice of plumbing professionals for nearly 100 years.



### MASTERS® ABS-PRO Medium ABS Solvent Cement

- Ideal for joining all schedules and classes of ABS pipe and fittings up to 6" in diameter with interference fit.
- Low VOC and meets South Coast Quality Management District (SCAQMD) 1168/316A or BAAQMD Method 40, as well as ASTM D2235.
- ABS-PRO is recommended for use on potable water or DWV.

Product No.	Size	Description	UPC	Ctn. Qty.
ABS250-1	237 ml	MASTERS® ABS-PRO Medium Yellow Cement	067001022400	24
ABS500-1	473 ml	MASTERS® ABS-PRO Medium Yellow Cement	067001022417	24
ABS1L-1	946 ml	MASTERS® ABS-PRO Medium Yellow Cement	067001022424	12
ABS4L-1	3.78 L	MASTERS® ABS-PRO Medium Yellow Cement	067001022431	6

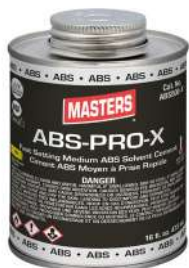

### MASTERS® ABS-PRO-X Fast-Setting ABS Solvent Cement

- Ideal for joining all schedules and classes of ABS pipe and fittings up to 6" in diameter with interference fit.
- Low VOC and meets South Coast Quality Management District (SCAQMD) 1168/316A or BAAQMD Method 40, as well as ASTM D2235.
- ABS-PRO is recommended for use on potable water or DWV.

Product No.	Size	Description	UPC	Ctn. Qty.
ABS250-X	237 ml	MASTERS® ABS-PRO-X Medium/Fast Yellow Cement	067001022448	24
ABS500-X	473 ml	MASTERS® ABS-PRO-X Medium/Fast Yellow Cement	067001022455	24
ABS1L-X	946 ml	MASTERS® ABS-PRO-X Medium/Fast Yellow Cement	067001022462	12
ABS4L-X	3.78 L	MASTERS® ABS-PRO-X Medium/Fast Yellow Cement	067001022479	6



### Oatey® ABS Premium Yellow Cement

- Medium-bodied yellow coloured cement for ABS pipe and fittings. Up to 6" diameter.
- For all types and grades of ABS pipe and fittings for DWV.
- Lo-V.O.C. Solvent Cement meets SCAQMD 1168/316A or BAAQMD Method 40 and various environmental requirements.
- For all non-pressure applications.
- Recommended application temperature 40°F to 110°F / 4°C to 43°C.
- Meets ASTM D2235.

Product No.	Size	Description	UPC	Ctn. Qty.
31500	118 ml	ABS Premium Yellow Cement	038753315003	24
31501	237 ml	ABS Premium Yellow Cement	038753315010	24
31502	473 ml	ABS Premium Yellow Cement	038753315027	24
31503	946 ml	ABS Premium Yellow Cement	038753315034	12
31504	3.78 L	ABS Premium Yellow Cement	038753315041	6



### Oatey® ABS Standard Yellow Cement

- Medium-bodied yellow coloured cement for use on ABS pipe and fittings. Up to 6" diameter.
- Lo-V.O.C. Solvent Cement meets SCAQMD 1168/316A or BAAQMD Method 40 and various environmental requirements.
- For all non-pressure applications.
- For all types and grades of ABS pipe and fittings for DWV.
- Recommended application temperature 40°F to 110°F / 4°C to 43°C.
- Meets ASTM D2235.

Product No.	Size	Description	UPC	Ctn. Qty.
31540	118 ml	ABS Standard Yellow Cement	038753315409	24
31541	237 ml	ABS Standard Yellow Cement	038753315416	24
31542	473 ml	ABS Standard Yellow Cement	038753315423	24
31543	946 ml	ABS Standard Yellow Cement	038753315430	12
31544	3.78 L	ABS Standard Yellow Cement	038753315447	6

## PVC SOLVENT CEMENTS



### MASTERS® PVC-PRO Fast-Setting Medium Grey Cement

- Ideal for joining all schedules and classes of PVC pipe and fittings up to 6" in diameter with interference fit.
- Low VOC and meets South Coast Quality Management District (SCAQMD) 1168/316A or BAAQMD Method 40 requirements, as well as ASTM D2564. Green Guard certified Low VOC.
- Recommended for use on potable water, pressure pipe, conduit or DWV.

Product No.	Size	Description	UPC	Ctn. Qty.
PVC250-G	237 ml	MASTERS® PVC-PRO Medium Grey Cement	067001022639	24
PVC500-G	473 ml	MASTERS® PVC-PRO Medium Grey Cement	067001022677	24
PVC1L-G	946 ml	MASTERS® PVC-PRO Medium Grey Cement	067001022615	12
PVC4L-G	3.78 L	MASTERS® PVC-PRO Medium Grey Cement	067001022653	6

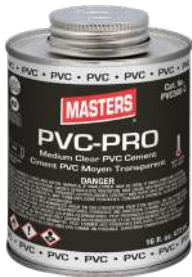

### MASTERS® PVC-PRO Fast-Setting Medium Clear Cement

- Ideal for joining all schedules and classes of PVC pipe and fittings up to 6" in diameter with interference fit.
- Low VOC and meets South Coast Quality Management District (SCAQMD) 1168/316A or BAAQMD Method 40 requirements, as well as ASTM D2564.
- Recommended for use on potable water, pressure pipe, conduit or DWV.

Product No.	Size	Description	UPC	Ctn. Qty.
PVC250-C	237 ml	MASTERS® PVC-PRO Medium Clear Cement	067001022622	24
PVC500-C	473 ml	MASTERS® PVC-PRO Medium Clear Cement	067001022660	24
PVC1L-C	946 ml	MASTERS® PVC-PRO Medium Clear Cement	067001022608	12
PVC4L-C	3.78 L	MASTERS® PVC-PRO Medium Clear Cement	067001022646	6



### PVC Heavy Duty Clear Cement

- Heavy Duty Clear cement for use on all schedules and classes PVC pipe and fitting up to 12" diameter with interference fit, up to 18" for non-pressure.
- Lo-V.O.C. Solvent Cement meets California South Coast Air Quality Management District (SCAQMD) 1168/316A or BAAQMD Method 40 and various environmental requirements.
- Thick formula fills gaps in large diameter pipe and loose fitting joints.
- Recommended for potable water, pressure pipe, conduit and DWV.
- Recommended application temperature 40°F to 110°F / 4°C to 43°C.
- Meets ASTM D2564.

Product No.	Size	Description	UPC	Ctn. Qty.
31476	118 ml	PVC Heavy Duty Clear Cement	038753314761	24
31477	237 ml	PVC Heavy Duty Clear Cement	038753314778	24
31478	473 ml	PVC Heavy Duty Clear Cement	038753314785	24
31479	946 ml	PVC Heavy Duty Clear Cement	038753314792	12
31463	3.78 L	PVC Heavy Duty Clear Cement – Wide Mouth Can	038753310114	6



**Oatey® EP13 Extra Heavy-Duty PVC Cement**

- EP13 extra heavy-bodied, slow-setting, gray solvent cement for use on all classes and schedules of PVC pipe up to 30".
- Recommended for potable water, pressure pipe, drain, waste and vent systems.
- Builds up for large diameter installation to fill gaps.
- Ideal for fabrication.
- Recommended application temperature 40°F to 110°F / 4°C to 43°C.
- Complies with various environmental requirements and SCAQMD Rule 1168/316A or BAAQMD Method 40 for VOC.
- Formulated for warm weather application.
- Three year shelf life.
- Meets and exceeds ASTM D2564.

Product No.	Size	Description	UPC	Ctn. Qty.
31779	946 ml	EP13 Extra Heavy Duty Gray PVC Cement	083675018365	12
31780	3.78 L	EP13 Extra Heavy Duty Gray PVC Cement	083675018242	6



**Oatey® PVC Heavy Duty Gray Cement**

- Heavy Duty Gray cement for use on all schedules and classes PVC pipe and fitting up to 12" diameter with interference fit, up to 18" for non-pressure.
- Lo-V.O.C. Solvent Cement meets California South Coast Air Quality Management District (SCAQMD) 1168/316A or BAAQMD Method 40 and various environmental requirements.
- Thick formula fills gaps in large diameter pipe and loose fitting joints.
- Recommended for potable water, pressure pipe, conduit and DWV.
- Recommended application temperature 40°F to 110°F / 4°C to 43°C.
- Meets ASTM D2564.

Product No.	Size	Description	UPC	Ctn. Qty.
31510	118 ml	PVC Heavy Duty Gray Cement	038753315102	24
31511	237 ml	PVC Heavy Duty Gray Cement	038753315119	24
31512	473 ml	PVC Heavy Duty Gray Cement	038753315126	24
31513	946 ml	PVC Heavy Duty Gray Cement	038753315133	12
31514	3.78 L	PVC Heavy Duty Gray Cement	038753315140	6



**Oatey® PVC Heavy Duty Gray Fast Set Cement**

- Very Heavy-bodied fast setting gray cement for use on all schedules and classes PVC pipe and fittings up to 18" diameter with interference fit.
- Lo-V.O.C. Solvent Cement meets California South Coast Air Quality Management District (SCAQMD) 1168/316A or BAAQMD Method 40 and various environmental requirements.
- Formulated for quick installation of irrigation pipe and fittings.
- Builds up for large diameter installations.
- Fills gaps in large diameter pipe and loose fitting joints.
- Recommended for potable water, pressure pipe, conduit and DWV.
- Recommended application temperature 40°F to 110°F / 4°C to 43°C.
- Meets ASTM D2564.

Product No.	Size	Description	UPC	Ctn. Qty.
31467	473 ml	PVC Heavy Duty Gray Fast Set	038753311210	24
31468	946 ml	PVC Heavy Duty Gray Fast Set	038753311227	12



**Oatey® PVC Heavy Duty Medium Set Gray Cement**

- Very Heavy-bodied medium setting gray cement for use on all schedules and classes PVC pipe and fittings up to 18" diameter with interference fit.
- Lo-V.O.C. Solvent Cement meets California South Coast Air Quality Management District (SCAQMD) 1168/316A or BAAQMD Method 40 and various environmental requirements.
- Formulated for quick installation of irrigation pipe and fittings.
- Builds up for large diameter installations.
- Fills gaps in large diameter pipe and loose fitting joints.
- Recommended for potable water, pressure pipe, conduit and DWV.
- Recommended application temperature 40°F to 110°F / 4°C to 43°C.
- Meets ASTM D2564.

Product No.	Size	Description	UPC	Ctn. Qty.
31446	237 ml	Heavy Duty Medium Set Gray	038753314464	24
31772	473 ml	Heavy Duty Medium Set Gray	038753317724	24
31773	946 ml	Heavy Duty Medium Set Gray	038753317731	12
31774	3.78 L	Heavy Duty Medium Set Gray	038753317748	6





### Oatey® PVC Medium Clear Cement

- Medium-Bodied Clear cement for use on all schedules and classes of PVC pipe and fittings up to 6" diameter with interference fit.
- Lo-V.O.C. Solvent Cement meets California South Coast Air Quality Management District (SCAQMD) 1168/316A or BAAQMD Method 40 and various environmental requirements.
- Recommended for potable water, pressure pipe, conduit and DWV.
- Recommended application temperature 40°F to 110°F / 4°C to 43°C.
- Meets ASTM D2564.

Product No.	Size	Description	UPC	Ctn. Qty.
31535	118 ml	PVC Medium Clear Cement	038753315355	24
31536	237 ml	PVC Medium Clear Cement	038753315362	24
31537	473 ml	PVC Medium Clear Cement	038753315379	24
31538	946 ml	PVC Medium Clear Cement	038753315386	12
31539	3.78 L	PVC Medium Clear Cement	038753315393	6



### Oatey® PVC Medium Gray Cement

- Medium-Bodied Gray cement for use on all schedules and classes of PVC pipe and fittings up to 6" diameter with interference fit.
- Lo-V.O.C. Solvent Cement meets California South Coast Air Quality Management District (SCAQMD) 1168/316A or BAAQMD Method 40 and various environmental requirements.
- Recommended for potable water, pressure pipe, conduit and DWV.
- Recommended application temperature 40°F to 110°F / 4°C to 43°C.
- Meets ASTM D2564.

Product No.	Size	Description	UPC	Ctn. Qty.
31505	118 ml	PVC Medium Gray Cement	038753315058	24
31506	237 ml	PVC Medium Gray Cement	038753315065	24
31507	473 ml	PVC Medium Gray Cement	038753315072	24
31508	946 ml	PVC Medium Gray Cement	038753315089	12
31509	3.78 L	PVC Medium Gray Cement	038753315096	6



### Oatey® PVC Medium Gray 1-Step Cement

- Medium-bodied gray coloured cement for use on PVC pipe and fittings. Up to 6" diameter for Sch. 40 and Sch. 80.
- This cement is specially formulated for use on all non-pressure PVC DWV piping systems up to 6" in diameter.
- Lo-V.O.C. Solvent Cement meets SCAQMD 1168/316A or BAAQMD Method 40 and various environmental requirements.
- Recommended application temperature 40F to 110F / 4C to 43C.
- Meets ASTM D2564.
- No primer needed on non-pressure DWV, up to 4" where local codes permit.

Product No.	Size	Description	UPC	Ctn. Qty.
31595	118 ml	PVC Medium Gray 1-Step Cement	038753315959	24
31596	237 ml	PVC Medium Gray 1-Step Cement	038753315966	24
31597	473 ml	PVC Medium Gray 1-Step Cement	038753315973	24
31598	946 ml	PVC Medium Gray 1-Step Cement	038753315980	12
31599	3.78 L	PVC Medium Gray 1-Step Cement	038753315997	6



### Oatey® PVC Regular Clear Cement

- Regular-Bodied Clear cement for use on all schedules and classes of PVC pipe and fittings up to 4" for Sch. 40 and up to 2" for Sch. 80.
- Lo-V.O.C. Solvent Cement meets California South Coast Air Quality Management District (SCAQMD) 1168/316A or BAAQMD Method 40 and various environmental requirements.
- Recommended for potable water, pressure pipe, conduit and DWV.
- Recommended application temperature 40°F to 110°F / 4°C to 43°C.
- Meets ASTM D2564.

Product No.	Size	Description	UPC	Ctn. Qty.
31470	118 ml	PVC Regular Clear Cement	038753314709	24
31471	237 ml	PVC Regular Clear Cement	038753314716	24
31472	473 ml	PVC Regular Clear Cement	038753314723	24
31464	946 ml	PVC Regular Clear Cement	038753310152	12
31465	3.78 L	PVC Regular Clear Cement	038753310169	6



**Oatey® PVC Blue Lava Hot Cement**

- Medium-bodied blue cement for use on all schedules and classes of PVC pipe and fittings up to 6" diameter with interference fit.
- Lo-V.O.C. Solvent Cement meets California South Coast Air Quality Management District (SCAQMD) 1168/316A or BAAQMD Method 40 and various environmental requirements.
- Very fast-setting "Hot" cement formulated for wet conditions and/or quick pressurization and fast installation.
- Recommended for potable water, sewer and DWV applications.
- Recommended application temperature 40°F to 110°F / 4°C to 43°C.
- No primer needed on non-pressure DWV, where local codes permit.
- Meets ASTM D2564.

Product No.	Size	Description	UPC	Ctn. Qty.
31788	473 ml	PVC Blue Lava Hot Cement	038753317885	24



**Pool-Tite™ 2300 Series Medium Blue "Hot" PVC Cement**

- Medium-bodied blue coloured cement for use on all schedules and classes of flexible and rigid PVC pipe and fittings up to 6" with interference fit.
- Lo-V.O.C. Solvent Cement meets California South Coast Air Quality Management District (SCAQMD) 1168/316A or BAAQMD Method 40 and various environmental requirements.
- No primer needed on non-pressure DWV, where local codes permit.
- Very fast setting cement formulated for wet conditions and/or quick pressurization and fast installation.
- Recommended application temperature 40°F to 110°F / 4°C to 43°C.
- Recommended for potable water, pressure pipe and DWV.
- Meets ASTM D2564.

Product No.	Size	Description	UPC	Ctn. Qty.
2366C	118 ml	Pool-Tite PVC Medium "Hot" Blue	083675023666	24
2346C	473 ml	Pool-Tite PVC Medium "Hot" Blue	083675023468	24
2336C	946 ml	Pool-Tite PVC Medium "Hot" Blue	083675023369	12
2324C	3.78 L	Pool-Tite PVC Medium "Hot" Blue	083675023246	6



**Oatey® PVC Rain-R-Shine® Gray Cement**

- Medium-bodied gray coloured cement for PVC pipe and fittings. Up to 6" diameter.
- Very fast-setting cement formulated for wet conditions and/or quick pressurization and fast installation.
- Recommended for ALL grades and types of PVC pipe and fittings, potable water and DWV.
- Lo-V.O.C. Solvent Cement meets SCAQMD 1168/316A or BAAQMD Method 40 and various environmental requirements.
- Both Schedule 40 and Schedule 80.
- Pool / Irrigation.
- Recommended application temperature 40°F to 110°F / 4°C to 43°C.
- No primer needed on non-pressure DWV, up to 4" where local codes permit.
- Meets ASTM D 2564.

Product No.	Size	Description	UPC	Ctn. Qty.
31580	118 ml	PVC Rain-R-Shine Gray Cement	038753315805	24
31581	237 ml	PVC Rain-R-Shine Gray Cement	038753315812	24
31582	473 ml	PVC Rain-R-Shine Gray Cement	038753315829	24
31583	946 ml	PVC Rain-R-Shine Gray Cement	038753315836	12
31584	3.78 L	PVC Rain-R-Shine Gray Cement	038753315843	6



**Oatey® PVC Rain-R-Shine® Blue Cement**

- Medium-bodied blue cement for use on all schedules and classes of PVC pipe and fittings up to 6" diameter with interference fit.
- Lo-V.O.C. Solvent Cement meets California South Coast Air Quality Management District (SCAQMD) 1168/316A or BAAQMD Method 40 and various environmental requirements.
- Very fast-setting "Hot" cement formulated for wet conditions and/or quick pressurization and fast installation.
- Recommended for pool, irrigation, potable water, pressure pipe, conduit and DWV.
- Recommended application temperature 40°F to 110°F / 4°C to 43°C.
- No primer needed on non-pressure DWV, where local codes permit.
- Meets ASTM D2564.

Product No.	Size	Description	UPC	Ctn. Qty.
31447	237 ml	PVC Rain-R-Shine® Blue	038753314471	24
31786	946 ml	PVC Rain-R-Shine® Blue	038753317861	12

## SPECIALTY PVC SOLVENT CEMENTS



### Oatey® PVC All Weather Clear Cement

- Medium-Bodied Clear cement for use on all schedules and classes of PVC pipe and fittings up to 6" diameter with interference fit.
- Lo-V.O.C. Solvent Cement meets California South Coast Air Quality Management District (SCAQMD) 1168/316A or BAAQMD Method 40 and various environmental requirements.
- Recommended application temperature -15°F to 110°F / -26°C to 43°C.
- Recommended for potable water, drain, waste and vent systems.
- No primer needed on non-pressure DWV, up through 4" diameter where local codes permit.
- Meets ASTM D2564.

Product No.	Size	Description	UPC	Ctn. Qty.
31473	473 ml	PVC All Weather Clear Cement	038753314730	24
31474	946 ml	PVC All Weather Clear Cement	038753314747	12
31469	3.78 L	PVC All Weather Clear – Wide Mouth Can	038753311357	6



### Oatey® PVC Flexible Clear Cement

- Medium-Bodied Clear cement for use on flexible PVC pipe and rigid fittings up to 6" diameter with interference fit.
- Lo-V.O.C. Solvent Cement meets California South Coast Air Quality Management District (SCAQMD) 1168/316A or BAAQMD Method 40 and various environmental requirements.
- Formulated to withstand pressures and vibrations commonly associated with spa and swimming pool installations.
- Meets manufacturer's rated line pressure for flexible PVC pipe.
- Recommended application temperature 40°F to 110°F / 4°C to 43°C.
- Meets ASTM D2564.

Product No.	Size	Description	UPC	Ctn. Qty.
31444	118 ml	PVC Flexible Clear Cement	038753314440	24
31445	237 ml	PVC Flexible Clear Cement	038753314457	24
31758	473 ml	PVC Flexible Clear Cement	038753317588	24
31475	946 ml	PVC Flexible Clear Cement	038753314754	12

## CPVC SOLVENT CEMENTS

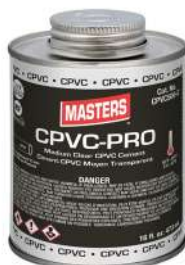

### MASTERS® CPVC-PRO Medium Bodied Clear CPVC Solvent Cement

- Ideal for joining CPVC pipe and fittings up to 6" in diameter with interference fit.
- Low VOC and meets South Coast Quality Management District (SCAQMD) 1168/316A or BAAQMD Method 40 requirements, as well as ASTM F493.
- Recommended for use on potable water, pressure pipe, conduit or DWV.

Product No.	Size	Description	UPC	Ctn. Qty.
CPVC500-C	473 ml	MASTERS® CPVC-PRO Clear Solvent Cement	067001022578	24



### Oatey® All Weather CPVC FlowGuard Gold®\* 1-Step Yellow Cement

- For copper tube size (CTS) CPVC hot and cold potable water pipe and fittings up to 2" diameter interference fit.
- Lo-V.O.C. Solvent Cement meets California South Coast Air Quality Management District (SCAQMD) 1168/316A or BAAQMD Method 40 and various environmental requirements.
- For cold water systems and hot water systems up to 200°F / 93°C.
- May be used without primer where local coders permit.
- Recommended application temperature 0°F to 110°F / -18°C to 43°C.
- Meets ASTM F493.

Product No.	Size	Description	UPC	Ctn. Qty.
31448	237 ml	CPVC Flowguard Gold® 1-Step Yellow	038753314488	24
31547	473 ml	CPVC Flowguard Gold® 1-Step Yellow	038753315478	24

\*FlowGuard Gold is a registered trademark of The Lubrizol Corporation.



### Oatey® CPVC Heavy Duty Orange Solvent Cement

- Heavy-bodied orange cement for use on all schedules and classes of CPVC pipe and fittings up to 12" diameter with interference fit.
- Lo-V.O.C. Solvent Cement meets California South Coast Air Quality Management District (SCAQMD) 1168/316A or BAAQMD Method 40 and various environmental requirements.
- For Commercial hot and cold water systems up to 200°F / 93°C.
- Recommended application temperature 40°F to 110°F / 4°C to 43°C.
- Approved for Corzan® CPVC Piping Systems.
- Meets ASTM F493 and ASTM D2846.

\*Corzan is a registered trademark of The Lubrizol Corporation.

Product No.	Size	Description	UPC	Ctn. Qty.
31776	473 ml	CPVC Heavy Duty Orange	038753317762	24
31777	946 ml	CPVC Heavy Duty Orange	038753317779	12



### Oatey® CPVC Medium Clear Cement

- Medium-bodied clear coloured cement for use on CPVC pipe and fittings. Up to 6" diameter.
- Lo-V.O.C. Solvent Cement meets SCAQMD 1168 / 316A or BAAQMD Method 40 and various environmental requirements.
- Recommended application temperature 40°F to 110°F / 4°C to 38°C.
- Meets ASTM F493.
- For C.T.S. (copper tube size) and Sch. 80, potable water pressure pipe.

Product No.	Size	Description	UPC	Ctn. Qty.
31515	118 ml	CPVC Medium Clear Cement	038753315157	24
31516	237 ml	CPVC Medium Clear Cement	038753315164	24
31517	473 ml	CPVC Medium Clear Cement	038753315171	24



### Oatey® CPVC Heavy Duty Gray Cement

- Heavy-bodied gray cement for use on all schedules and classes of CPVC pipe and fittings up to 12" diameter with interference fit.
- Lo-V.O.C. Solvent Cement meets California South Coast Air Quality Management District (SCAQMD) 1168/316A or BAAQMD Method 40 and various environmental requirements.
- For Commercial hot and cold water systems up to 200°F / 93°C.
- Recommended application temperature 40°F to 110°F / 4°C to 43°C.
- Approved for Corzan® CPVC Piping Systems.
- Meets ASTM F493 and ASTM D2846.

\*Corzan is a registered trademark of The Lubrizol Corporation.

Product No.	Size	Description	UPC	Ctn. Qty.
31775	473 ml	CPVC Heavy Duty Gray	038753317755	24
31466	946 ml	CPVC Heavy Duty Gray	038753314662	12



### Oatey® EP42 CPVC HD Gray Industrial Cement

- Heavy-bodied industrial gray solvent cement specifically designed for use on PVC and CPVC piping systems requiring chemical resistance to caustics including hypochlorite, mineral acids and aqueous salt solutions.
- For Schedules 40 and 80 CPVC and PVC up to 12" diameter, as well as other classes and schedules with interference fit.
- Resistant to caustics and hypochlorites up to 15 percent solution. Refer to EP 42 Chemical Resistance Chart for compatibility prior to using with chemical solutions.
- For use with all CPVC materials including Corzan® Industrial Piping Systems.
- Ultra violet indicator allows for quick and easy inspection of dry fit joints with any UV light source.
- Recommended application temperature 40°F to 110°F / 4°C to 43°C.
- Complies with various environmental requirements and SCAQMD Rule 1168/316A or BAAQMD Method 40 for VOC.
- Two year shelf life.
- Meets and exceeds ASTM F493.

Product No.	Size	Description	UPC	Ctn. Qty.
31781	473 ml	EP42 CPVC HD Gray Industrial Cement	038753317816	24
31459	946 ml	EP42 CPVC HD Gray Industrial Cement	038753303291	12
31782	3.78 L	EP42 CPVC HD Gray Industrial Cement	038753317823	6



### MASTERS® TRANSITION-PRO PVC to ABS White Transition Cement

- Ideal for joining PVC to ABS in non-pressure transition joints up to 6" in diameter.
- Low VOC and meets South Coast Quality Management District (SCAQMD) 1168/316A or BAAQMD Method 40 requirements, as well as ASTM D-3138.

Product No.	Size	Description	UPC	Ctn. Qty.
TR500-W	473 ml	MASTERS® Transition-Pro PVC to ABS White Cement	067001022486	24



### Oatey® ABS To PVC Transition White Cement

- Medium-Bodied white coloured cement for use in joining ABS to PVC in non-pressure transition joints up to 6" diameter.
- Lo-V.O.C. Solvent Cement meets California South Coast Air Quality Management District (SCAQMD) 1168/316A or BAAQMD Method 40 and various environmental requirements.
- Recommended application temperature 40°F to 110°F / 4°C to 43°C.
- Meets ASTM D3138.

Product No.	Size	Description	UPC	Ctn. Qty.
31532	118 ml	ABS To PVC Transition White Cement	038753315324	24
31531	237 ml	ABS To PVC Transition White Cement	038753315317	24
31530	473 ml	ABS To PVC Transition White Cement	038753315300	24

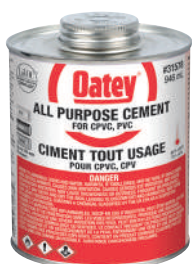

### Oatey® All Purpose Cement

- Medium-bodied milky-clear cement for use on all schedules and classes of ABS, PVC and CPVC pipe and fittings up to 6" diameter with interference fit.
- Lo-V.O.C. Solvent Cement meets California South Coast Air Quality Management District (SCAQMD) 1168/316A or BAAQMD Method 40 and various environmental requirements.
- Recommended for potable water, pressure pipe, conduit and DWV.
- Recommended application temperature 40°F to 110°F / 4°C to 43°C.
- Meets performance requirements of ASTM D2564, D-2235, F-493.
- Always check local codes for acceptability of this product.

Product No.	Size	Description	UPC	Ctn. Qty.
31575	118 ml	All Purpose Cement	038753315751	24
31576	237 ml	All Purpose Cement	038753315768	24
31577	473 ml	All Purpose Cement	038753315775	24
31578	946 ml	All Purpose Cement	038753315782	12





**MASTERS® PRIMER-PRO Purple Primer – NSF Listed**

- Aggressive purple primer for use on PVC and CPVC pipe and fittings.
- Low VOC and meets South Coast Quality Management District (SCAQMD) 1168/316A or BAAQMD Method 40, as well as ASTM F656.
- Removes surface dirt, grease and grime as well as softens the pipe and fitting to allow a fast, secure solvent weld.
- For use in areas where plumbing code calls for verification that a primer has been used.
- NSF and IAPMO Listed.

Product No.	Size	Description	UPC	Ctn. Qty.
PR250-P	237 ml	MASTERS® Primer-Pro Purple Primer	067001022530	24
PR500-P	473 ml	MASTERS® Primer-Pro Purple Primer	067001022547	24
PR1L-P	936 ml	MASTERS® Primer-Pro Purple Primer	067001022554	12
PR4L-P	3.78 L	MASTERS® Primer-Pro Purple Primer	067001022561	6



**MASTERS® PRIMER-PRO Clear Primer – NSF Listed**

- Clear aggressive primer for use on PVC and CPVC pipe and fittings.
- Low VOC and meets South Coast Quality Management District (SCAQMD) 1168/316A or BAAQMD Method 40, as well as ASTM F656.
- Removes surface dirt, grease and grime as well as softens the pipe surface to allow a fast, secure solvent weld.
- For use in areas where plumbing code calls for verification that a primer has been used.
- NSF and IAPMO listed.

Product No.	Size	Description	UPC	Ctn. Qty.
PR250-C	237 ml	MASTERS® Primer-Pro Clear Primer	067001022493	24
PR500-C	473 ml	MASTERS® Primer-Pro Clear Primer	067001022509	24
PR1L-C	946 ml	MASTERS® Primer-Pro Clear Primer	067001022516	12
PR4L-C	3.78 L	MASTERS® Primer-Pro Clear Primer	067001022523	6



**Oatey® Industrial Grade Purple Primer – NSF Listed**

- Very Aggressive Purple-tinted primer for use on CPVC pipe and fittings.
- Lo-V.O.C. Solvent Cement meets California South Coast Air Quality Management District (SCAQMD) 1168/316A or BAAQMD Method 40 and various environmental requirements.
- Recommended for Commercial and Large diameter thermoplastic piping systems, specifically CPVC Sch. 40 / 80.
- Ideal for use in cold weather applications.
- Removes surface dirt, grease and grime as well as softens the pipe surface to allow a fast, secure solvent weld.
- For use in areas where plumbing code calls for verification that a primer has been used.
- NSF and IAPMO Listed.
- Meets ASTM F656.

Product No.	Size	Description	UPC	Ctn. Qty.
31764	473 ml	Purple Primer – Industrial Grade	038753317649	24
31765	946 ml	Purple Primer – Industrial Grade	038753317656	12
31766	3.78 L	Purple Primer – Industrial Grade	038753317663	6



**Oatey® Industrial Grade Clear Primer – NSF Listed**

- Very Aggressive Clear primer for use on PVC and CPVC pipe and fittings.
- Lo-V.O.C. Solvent Cement meets California South Coast Air Quality Management District (SCAQMD) 1168/316A or BAAQMD Method 40 and various environmental requirements.
- Recommended for Commercial and Large diameter thermoplastic piping systems, specifically CPVC Sch. 40 / 80.
- Ideal for use in cold weather applications.
- Removes surface dirt, grease and grime as well as softens the pipe surface to allow a fast, secure solvent weld.
- NSF Listed.
- Meets ASTM F656.

Product No.	Size	Description	UPC	Ctn. Qty.
31760	473 ml	Clear Primer – Industrial Grade	038753317601	24
31761	946 ml	Clear Primer – Industrial Grade	038753317618	12
31762	3.78 ml	Clear Primer – Industrial Grade	038753317625	6



### Oatey® Clear Primer – NSF Listed

- Clear aggressive primer for use on PVC and CPVC pipe and fittings.
- Lo-V.O.C. Solvent Cement meets California South Coast Air Quality Management District (SCAQMD) 1168/316A or BAAQMD Method 40 and various environmental requirements.
- Removes surface dirt, grease and grime as well as softens the pipe surface to allow a fast, secure solvent weld.
- NSF listed.
- Meets ASTM F656.

Product No.	Size	Description	UPC	Ctn. Qty.
31525	118 ml	Clear Primer	038753315256	24
31526	237 ml	Clear Primer	038753315263	24
31527	473 ml	Clear Primer	038753315270	24
31528	946 ml	Clear Primer	038753315287	12
31461	3.78 L	Clear Primer	038753307541	6



### Oatey® Purple Primer – NSF Listed

- Purple-tinted aggressive primer for use on PVC and CPVC pipe and fittings.
- Lo-V.O.C. Primer meets California South Coast Air Quality Management District (SCAQMD) 1168/316A or BAAQMD Method 40 and various environmental requirements.
- Removes surface dirt, grease and grime as well as softens the pipe surface to allow a fast, secure solvent weld.
- For use in areas where plumbing code calls for verification that a primer has been used.
- NSF Listed.
- Meets ASTM F656.

Product No.	Size	Description	UPC	Ctn. Qty.
31480	118 ml	Purple Primer – NSF Listed	038753314808	24
31481	237 ml	Purple Primer – NSF Listed	038753314815	24
31482	473 ml	Purple Primer – NSF Listed	038753314822	24
31483	946 ml	Purple Primer – NSF Listed	038753314839	12
31462	3.78 L	Purple Primer – Wide Mouth Can	038753307596	6



### Oatey® Purple Primer/Cleaner

- Purple-tinted all purpose primer/cleaner for PVC and CPVC pipe and fittings.
- Meets California South Coast Air Quality Management District (SCAQMD) 1171/M24 or BAAQMD Method 40 and various environmental requirements.
- Less aggressive than clear primer and purple primer.
- Removes surface dirt, grease and grime for preparation before solvent cementing.
- Always check local codes for acceptability of this product.

Product No.	Size	Description	UPC	Ctn. Qty.
31585	118 ml	Purple Primer/Cleaner	038753315850	24
31586	237 ml	Purple Primer/Cleaner	038753315867	24
31587	473 ml	Purple Primer/Cleaner	038753315874	24
31588	946 ml	Purple Primer/Cleaner	038753315881	12
31589	3.78 L	Purple Primer/Cleaner	038753315898	6



### Oatey® Clear Cleaner

- Clear Cleaner for ABS, PVC and CPVC pipe and fittings.
- Lo-V.O.C. Solvent Cement meets (SCAQMD) 1171/M24 or BAAQMD Method 40 and various environmental requirements.
- All schedules and all diameters.
- Flows freely and evaporates quickly.
- Fast acting cleaner removes surface dirt, grease and grime.

Product No.	Size	Description	UPC	Ctn. Qty.
31520	118 ml	Clear Cleaner	038753315201	24
31521	237 ml	Clear Cleaner	038753315218	24
31522	473 ml	Clear Cleaner	038753315225	24
31523	946 ml	Clear Cleaner	038753315232	12
31767	3.78 L	Clear Cleaner – Wide Mouth Can	038753317670	6

## ACCESSORIES



### Oatey® Solvent Cement And Primer Accessories

- Standard replacement daubers specifically sized for 4 oz., 8 oz., 16 oz. and 32 oz. cement/primer cans.
- Brush applicator for 16 & 32 oz. cans.
- Standard replacement cans.

Product No.	Size	Description	UPC	Ctn. Qty.
31299	118 ml	Dauber 3/4"	038753312996	48
31309	237 ml	Dauber 3/4"	038753313092	48
31310	473 ml	Dauber 1-1/2"	038753313108	48
31312	946 ml	Dauber 1-1/2"	038753313122	48
31313	473/946 ml	Dauber For CPVC Cement 3/4"	038753313139	48
31257	473/946 ml	Brush Top Dauber 1-1/2" Length	038753312576	50
31275	300 mm	Gallon Can Roller Applicator – Fits Wide And Standard Mouth Size	038753312750	12
31276	300 mm	Gallon Can Swab Applicator – Fits Wide And Standard Mouth Size	038753312767	12
31304	118 ml	Cement Can	038753313047	24
31305	237 ml	Cement Can	038753313054	24
31306	473 ml	Cement Can	038753313061	24
31307	946 ml	Cement Can	038753313078	12
30901	3.78 L	Wide Mouth Can	038753309019	6



### MASTERS® Brush-In-Can

- Reusable HDPE container with brush

Product No.	Size	Description	UPC	Ctn. Qty.
BIC500	500 mL	Empty 500 mL can with brush	067001022585	12
BIC1L	1 L	Empty 1L can with brush	067001022592	12



### Oatey® Adjustable Daubers

- For applying solvent cement and primers.
- Fits can sizes 236 ml to 946 ml.
- Specially constructed easy open, easy close sealing controls evaporation of solvents and prevents spillage.
- Dauber is unbreakable.
- Designed to adjust to various can dimensions and allows application of the proper amount of cement to ensure a good solvent weld.

Product No.	Size	Description	UPC	Ctn. Qty.
31300	1/2"	Adjustable Plastic Dauber w/ 1/2" Ball	038753313009	100
31301	1"	Adjustable Plastic Dauber w/ 1" Ball	038753313016	100
31302	1"	Adjustable Plastic Dauber w/ 1" Ball	038753313023	50



### Oatey® Cement Carrier

- Designed to make it easier to keep cement and cleaner ready for use on the job.
- Caddy holds two 946 ml cans.
- Patented.

Product No.	Size	Description	UPC	Ctn. Qty.
31250	946 ml can	Cement Carrier	038753312507	12



### MASTERS® Utility Brush

- Multi-purpose pure bristle brush.

Product No.	Size	Description	UPC	Ctn. Qty.
UB100	1"	MASTERS Utility Brush	067001000712	20
UB200	2"	MASTERS Utility Brush	035162002333	24





## HOW TO SOLVENT WELD



### Pipe Types

**CPVC: Chlorinated Polyvinyl Chloride** – Typically used for pressure piping applications, including hot and cold potable water distribution. Can also be used for corrosive fluid handling in industrial or chemical applications.

**ABS: Acrylonitrile Butadiene Styrene** – Typically used for non-pressure piping applications.

**PVC: Polyvinyl Chloride** – Typically used for pressure or non-pressure piping applications.

### Solvent Cements for any Application

If you need to solvent weld one pipe joint or one thousand, Oatey® is the solvent cement more professionals choose than any other brand. From hot to cold, wet to dry, Oatey has the solvent cement to meet your exact requirement for any plastic pipe installation.

### Solvent Cement Cure Times

The cure time of solvent cements is dependent on several factors. The pipe size, socket fit, ambient temperature, relative humidity, solvent cements and the system operating pressure should all be considered when determining cure times.

Oatey continues to work hard to provide you peace of mind and confidence when using Oatey brand solvent cements and products.

Cure chart see page 18

### How To Solvent Weld

**PRIOR TO USE: Read all product labels carefully.**

Stir or shake cement before using. If jelly-like, do not use. Keep container closed when not in use. Avoid eye and skin contact. Wear safety glasses with side shields and wear rubber gloves.

1. Square pipe ends, chamfer and remove all dirt.
2. Check dry fit of pipe and fitting. Pipe should easily go 1/3 of the way into the fitting. If pipe bottoms, it should be snug.
3. Use a suitable applicator at least 1/2 the size of the pipe diameter. For larger size pipe systems use a natural bristle brush or roller.
4. Clean pipe and fitting with a listed primer. (Do not use primer on ABS pipe and fittings. Use Clear Cleaner only!)
5. Apply liberal coat of cement to pipe to the depth of the socket, leave no uncoated surface.
6. Apply a thin coat of cement to inside of fitting, avoid puddling of cement. Puddling can cause weakening and premature failure of pipe or fitting. Apply a second coat of cement to the pipe.
7. Assemble parts QUICKLY. Cement must be fluid. If cement surface has dried, recoat both parts.
8. Push pipe FULLY into fitting using a 1/4 turning motion until pipe bottoms.
9. Hold pipe and fitting together for 30 seconds to prevent pipe push-out – longer at low temperatures. Wipe off excess.
10. Allow 15 minutes for good handling strength and 2 hours cure time at temperatures above 60°F (15.5°C) before pressure testing up to 180 psi. Longer cure times may be required at temperatures below 60°F (15.5°C) or with pipe above 3". **Testing a plumbing system with air, regardless of the type of solvent cement used, is dangerous and not recommended.** For specialty cements and chemical applications, please see specific product label instructions.

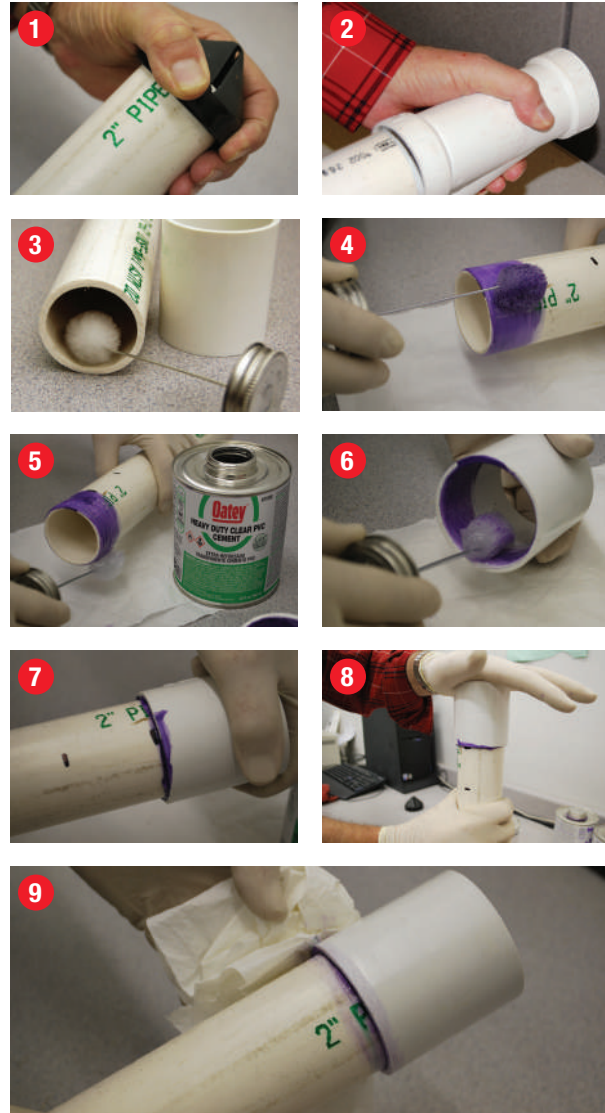

## SET UP/CURING TIMES

The set up/cure time is dependent on several factors. The pipe size, socket fit, ambient temperature, relative humidity, solvent cement used and the system operating pressure should all be considered when determining set up/cure times.

### PVC & ABS

Pipe Diameter	Temperature during assembly and cure period			
	60°-100°F 16°-38°C	40°-60°F 4°-16°C	20°-40°F -7°-4°C	0°-20°F -18°- -7°C
<b>1/2" to 1-1/4"</b> 13 to 32mm	2 min	5 min	8 min	10 min
<b>1-1/2" to 3"</b> 40 to 80mm	5 min	10 min	12 min	15 min
<b>4" to 5"</b> 100 to 125mm	15 min	30 min	60 min	2 hrs
<b>6" to 8"</b> 150 to 200mm	30 min	90 min	3 hrs	6 hrs

### Average Handling/Set Up Times for PVC/CPVC Solvent Cements

Handling/Set Up Time is the time required prior to handling the joint. In damp or humid weather, allow 50% additional time.

These figures should only be used as a general guide. Conditions in the field may vary.

Contact Oatey Technical Services for set up times for pipe larger than 8" diameter.

Pipe Diameter	1/2"	3/4"	1"	1-1/4"	1-1/2"	2"	3"	4"	6"	8"
Number Of Joints	325	250	150	125	90	70	50	30	10	8

### Average Number of Joints Per Quart of Solvent Cement

These figures are estimates based on laboratory testing. Conditions in the field may vary.

### PVC & ABS

Pipe Diameter		Temperature during assembly and cure period			
		60°-100°F 16°-38°C	40°-60°F 4°-16°C	20°-40°F -7°-4°C	0°-20°F -18°- -7°C
<b>1/2" to 1-1/4"</b> 13 to 32mm	Up to 180 psi	15 min	20 min	30 min	Please contact Oatey Technical Services for cure time information
	180 psi +	4 hrs	8 hrs	36 hrs	
<b>1-1/2" to 3"</b> 40 to 80mm	Up to 180 psi	30 min	45 min	60 min	
	180 psi +	8 hrs	16 hrs	72 hrs	
<b>4" to 5"</b> 100 to 125mm	Up to 180 psi	2 hrs	4 hrs	36 hrs	
	180 psi +	12 hrs	24 hrs	4 days	
<b>6" to 8"</b> 150 to 200mm	Up to 180 psi	8 hrs	16 hrs	3 days	
	180 psi +	24 hrs	48 hrs	9 days	

### Average Joint Cure Times for PVC/CPVC Solvent Cements

Joint cure time is the time required before pressure testing the system. In damp or humid weather allow 50% additional cure time.

Contact Oatey Technical Services for cure times for pipe larger than 8" diameter.

This data is applicable only for new piping installations and not recommended for repair or cut-ins on hot and cold water distribution systems. Please contact Oatey Technical Service for recommendations on Cure Times for such applications.

**DO NOT** test PVC and CPVC piping systems with compressed air or gas.

**Notes:** Cure schedule is the time required before pressure testing the system

- This chart can be used as a guideline to determine joint cure
- Cure times stated are for conditions with relative humidity of 60% or less
- + In damp or humid weather allow 50% additional cure time

### CPVC

Pipe Diameter		Temperature during assembly and cure period			
		60°-100°F 16°-38°C	40°-60°F 4°-16°C	20°-40°F -7°-4°C	0°-20°F -18°- -7°C
<b>1/2" to 1-1/4"</b> 13 to 32mm	Up to 180 psi	1 hr	2 hrs	Please contact Oatey Technical Services for cure time information	
	180 psi +	6 hrs	12 hrs		
<b>1-1/2" to 3"</b> 40 to 80mm	Up to 180 psi	2 hrs	4 hrs		
	180 psi +	12 hrs	24 hrs		
<b>4" to 5"</b> 100 to 125mm	Up to 180 psi	6 hrs	12 hrs		
	180 psi +	18 hrs	36 hrs		
<b>6" to 8"</b> 150 to 200mm	Up to 180 psi	8 hrs	16 hrs		
	180 psi +	24 hrs	48 hrs		



# Category 2

## Thread Sealants and Leak Detectors

When it comes to Thread Sealants, nobody does it better than Masters®, Oatey® and Hercules®. Together we have formulated and manufactured thread sealants for more than 150 years. We continuously respond to professional plumbers' changing needs with new technology, new ideas, and new products. From low-pressure to high-pressure piping demands, from plastics to metals, as well as the market's need for PTFE – we lead the industry with Thread Sealants and Pipe Joint Compounds that provide solutions.

CATEGORY 2 THREAD SEALANTS AND LEAK DETECTORS

PIPE THREAD SEALANT CERTIFICATION OVERVIEW

CATEGORY 2 THREAD SEALANTS AND LEAK DETECTORS

CERTIFICATIONS

PRODUCT	NATURAL GAS		SANITATION		ECO		COMPATIBILITY		
	ULC	CSA	NSF	CFIA	LOW VOC	LEED	METALS	PLASTIC	FBC
PRO-DOPE®	✓		✓	✓	✓	✓	✓	✓	
METALLIC COMPOUND™	✓				✓		✓	✓	
PRO-BLUE®	✓		✓		✓	✓	✓	✓	
NON-METALLIC COMPOUND™	✓			✓	✓		✓	✓	
A-PLUS®	✓			✓	✓		✓		
MEGALOC®		✓	✓		✓		✓	✓	
GREAT WHITE®			✓		✓		✓	✓	✓





**MASTERS® Pro-Dope Pipe Thread Sealant**

- PTFE pipe thread sealant
- Effectively seals both metal and plastic threaded connections against leaks of most liquids and gases\* up to 10,000 psi
- Will not dry out, stain, harden or separate
- Lubricates during assembly and disassembles easily even after years of service
- ULC Listed for Natural Gas (CAN/ULC - S642) and NSF/ANSI 61G/372 listed for potable water
- MAS Green Certified
- Low VOC
- CFIA Letter of No Objection Available

Product No.	Size	Description	UPC	Ctn. Qty.
PD250BT	250 ml	Pro-Dope Pipe Thread Sealant Brush Top Can	067001000071	25
PD500BT	500 ml	Pro-Dope Pipe Thread Sealant Brush Top Can	067001000170	12
PD1L	1 L	Pro-Dope Pipe Thread Sealant Flat Top Can	067001000408	4
PD20L	20 L	MASTERS Pro-Dope Pipe Thread Sealant Pail	067001000422	1



**MASTERS® Pro-Blue Pipe Thread Sealant**

- PTFE pipe thread sealant
- Effectively seals both metal and plastic threaded connections against leaks of most liquids and gases\* up to 10,000 psi
- Will not dry out, stain, harden or separate
- Lubricates during assembly and disassembles easily even after years of service
- ULC Listed for Natural Gas ((CAN/ULC - S642) and NSF/ANSI 61G/372 listed for potable water
- MAS Green certified
- Low VOC

Product No.	Size	Description	UPC	Ctn. Qty.
PB250BT	250 ml	MASTERS Pro-Blue Pipe Thread Sealant Brush Top Can	067001001504	25
PB500BT	500 ml	MASTERS Pro-Blue Pipe Thread Sealant Brush Top Can	067001001511	12
NM20L	20 L	MASTERS Non-Metallic Pipe Thread Sealant Pail	067001000392	1



**MASTERS® Non-Metallic Pipe Thread Sealant**

- General purpose pipe thread sealant
- Effectively seals both metal and plastic threaded connections against leaks of most liquids and gases\* at commonly used temperatures and pressures
- All weather, non-corrosive product contains no metal so it is not a conductor of electricity
- Lubricates during assembly, will not harden or separate and disassembles easily even after years of service
- ULC Listed for Natural Gas (CAN/ULC - S642)
- Low VOC
- CFIA Letter of No Objection available

Product No.	Size	Description	UPC	Ctn. Qty.
NM250BT	250 ml	MASTERS Non-Metallic Pipe Thread Sealant Brush Top Can	067001000217	25
NM1L	1 L	MASTERS Non-Metallic Pipe Thread Sealant Flat Top Can	067001000378	4
NM20L	20 L	MASTERS Non-Metallic Pipe Thread Sealant Pail	067001000392	1



**MASTERS® Metallic Pipe Thread Sealant**

- Heavy-duty pipe thread sealant
- Effectively seals both metal and plastic threaded connections against leaks of most liquids and gases\* up to 6,000 psi
- Will not dry out, harden or separate
- Lubricates during assembly and disassembles easily even after years of service
- ULC Listed for Natural Gas (CAN/ULC-S642)
- Low VOC

Product No.	Size	Description	UPC	Ctn. Qty.
CP250BT	250 ml	MASTERS Pipe Thread Sealant Brush Top Can	067001000347	25
CP1L	1 L	MASTERS Pipe Thread Sealant Flat Top Can	067001000354	4



**Hercules™ Megaloc®**

- Made with DuPont™ Kevlar®.
- Wipes easily from hands and tools with dry rag; grit-free.
- No odor - Soft setting - Non Flammable.
- High performing thread sealant for use on metal or plastic pipe - including ABS.
- Safe for potable water lines, approved for use with natural gas and LP gases.
- Withstands hydraulic pressure to 12,000 psi and gas pressure to 2600 psi at temperatures from -50° to +400°F (-46 to 204°C) (on steel pipe).

Product No.	Size	Description	UPC	Ctn. Qty.
15820	29 ml	Megaloc Thread Sealant – Squeeze Tube	032628158207	24
15821	118 ml	Megaloc Thread Sealant – Screw Cap With Brush	032628158214	24
158069	237 ml	Megaloc Thread Sealant – Screw Cap With Brush	032628958067	24
158089	473 ml	Megaloc Thread Sealant – Screw Cap With Brush	032628958081	12
158119	946 ml	Megaloc Thread Sealant – Screw Cap With Brush	032628958111	12



**Oatey® Great White™ Pipe Joint Compound with PTFE**

- Lubricates and seals all threaded joints
- White, non-hardening, non-separating, non-toxic paste
- Withstands up to 3,000 psi on gases from -50° to +400°F (-46 to 204°C), and 10,000 psi on liquids from -50° to +500°F (-46 to 260°C).
- For use with water, steam, caustics or dilute acid lines of PVC, CPVC, ABS, cyclocac, polypropylene, iron, steel, or copper
- Can be used on plastic or metal threads

Product No.	Size	Description	UPC	Ctn. Qty.
48007	29 ml	Great White Pipe Joint Compound w/PTFE	038753480077	12
48008	118 ml	Great White Pipe Joint Compound w/PTFE	038753480084	12
48009	237 ml	Great White Pipe Joint Compound w/PTFE	038753480091	12



**MASTERS® A-PLUS Anaerobic Pipe Thread Sealant**

- General purpose anaerobic pipe thread sealant for sealing metal threads
- Superior sealing and locking properties especially effective where vibrations are prevalent, making it suitable for production lines
- Lubricates during assembly and hardens in threads, with excellent performance on stainless steel
- Seals moderate pressure almost instantly and up to 250 psi steam pressure in approximately 24 hours
- ULC Listed for Natural Gas (CAN/ULC-S642)
- CFIA letter of No Objection available
- Low VOC

Product No.	Size	Description	UPC	Ctn. Qty.
MAP250	250 ml	MASTERS A-PLUS Anaerobic Pipe Thread Sealant Sqze Tube	067001001672	1



### MASTERS® Orange **T**-Tape

- Non-corrosive, non-flammable, clean, easy to use premium quality thread sealing tape
- Because it is chemically inert, it seals all metal and plastic threaded connections against leakage of virtually everything at temperatures between -400°F & +600°F (-240°C & +316°C)
- Allows for easy disassembly of joints, even after years of service
- Meets MIL SPEC A-A-58092 (superseding T-27730A)
- For use on potable water systems
- ULC Listed for Natural Gas (CAN/ULC-S642)

Product No.	Size	Description	UPC	Ctn. Qty.
ULC260	0.50" x 260"	MASTERS T-Tape Orange ULC Listed Roll	067001000828	12
ULC540	0.50" x 540"	MASTERS T-Tape Orange ULC Listed Roll	067001000873	12
ULC540V	0.50" x 540"	MASTERS T-Tape Orange Bulk PK ULC Listed Roll	067001000873	100
ULC260V	0.50" x 260"	MASTERS T-Tape Orange Bulk PK ULC Listed Roll	067001000828	100
ULC1296	0.50" x 1296"	MASTERS T-Tape Orange ULC Listed Roll	067001000880	12
ULC1296V	0.50" x 1296"	MASTERS T-Tape Orange Bulk PK ULC Listed Roll	067001000880	100
TOC540	0.75" x 540"	MASTERS T-Tape Orange ULC Listed Roll	067001000859	12



### MASTERS® Orange **T**-Tape

- Non-corrosive, non-flammable, clean, easy to use premium quality thread sealing tape
- Because it is chemically inert, it seals all metal and plastic threaded connections against leakage of virtually everything at temperatures between -400°F & +600°F (-240°C & +316°C)
- Allows for easy disassembly of joints, even after years of service
- Meets MIL SPEC A-A-58092 (superseding T-27730A)
- For use on potable water systems

Product No.	Size	Description	UPC	Ctn. Qty.
TOA260	0.25" x 260"	MASTERS T-Tape Orange Roll	067001000811	12
TOD540	1.00" x 540"	MASTERS T-Tape Orange Roll	067001000866	12



### MASTERS® Yellow **T**-Tape

- Non-corrosive, non-flammable, clean, easy to use gas seal tape
- Because it is chemically inert, it seals all metal and plastic threaded connections against leakage of virtually everything at temperatures between -400°F & +600°F (-240°C & +316°C)
- Allows for easy disassembly of joints, even after years of service
- Coloured yellow for easy identification during inspection
- Meets MIL SPEC A-A-58092 (superseding T-27730A)
- For use on potable water systems
- ULC Listed for Natural Gas (CAN/ULC-S642)

Product No.	Size	Description	UPC	Ctn. Qty.
TYB480	0.50" x 480"	MASTERS T-Tape Yellow ULC Listed Roll	067001000897	24
TYB260V	0.50" x 260"	MASTERS T-Tape Yellow Bulk PK ULC Listed	067001000798	100
TYB480V	0.50" x 480"	MASTERS T-Tape Yellow Bulk PK ULC Listed Roll	067001000897	100

THREAD SEALANTS AND LEAK DETECTORS



**Hercules™ Megatape**

- Use on any threaded pipe carrying dilute acids, compressed air, aliphatic solvents, dilute caustics, cutting oils, diesel fuel oil, hydraulic fluids, L.P. Gas, natural gas, petroleum solvents, steam, vegetable oils, water and more.
- High density gray tape, 3.5 mils thick.
- Recommended by professionals.
- Safe for use on stainless steel, cast iron, brass and chrome.
- ULC Listed for Natural Gas (CAN/ULC-S642)

Product No.	Size	Description	UPC	Ctn. Qty.
15050D	1/2" x 260"	Megatape – Gray PTFE Tape, display box	032628151901	120
15100	1/2" x 1000"	Megatape – Gray PTFE Tape, display box	032628151918	63
15110	3/4" x 1000"	Megatape – Gray PTFE Tape, display box	032628151925	45
15120	1" x 1000"	Megatape – Gray PTFE Tape, display box	032628151932	36



**Thompsons Industrial Pink Tape**

- Seals all metal and plastic threaded connections against leakage at commonly used temperatures and pressures.
- Non-corrosive, non-flammable, clean, and easy to use. Joints disassemble easily, even after years of service.
- Impervious to virtually all chemicals and gases.

Product No.	Size	Description	UPC	Ctn. Qty.
TOIB1296V	0.50" x 1296" (1.27 cm x 32.94 m)	THOMPSONS Industrial Tape Pink	067001000989	100
TOIB540V	0.50" x 540" (1.27 cm x 13.72 m)	THOMPSONS Industrial Tape Pink	067001000972	100



**Oatey® Pink Water Line Thread Seal Tape With PTFE**

- Provides fast positive seal for water lines, sewage lines and sprinkler systems.
- Effective on metal or plastic threads.
- High density, multi-purpose pink tape.
- Packaged on spools in a display carton.
- ULC Listed

Product No.	Size	Description	UPC	Ctn. Qty.
31402D	1/2" x 260"	PTFE Pink Thread Seal Tape – Display Box	038753314020	50



**MASTERS® White Tape**

- Non-corrosive, non-flammable, clean, easy to use thread sealing tape
- Because it is chemically inert, it seals all metal and plastic threaded connections against leakage of virtually everything at temperatures between -400°F & +600°F (-240°C & +316°C)
- Allows for easy disassembly of joints, even after years of service

Product No.	Size	Description	UPC	Ctn. Qty.
TWB480G	0.50" x 480"	MASTERS White Tape	067001000941	200
TWC480G	0.75" x 480"	MASTERS White Tape	067001000958	12
TWB480P	0.50" x 480"	MASTERS White Economy Tape	067001000934	200





**MASTERS® Leak Detector**

- Bubble type non-freezing (to -35°F/-37°C) liquid quickly locates pin hole leaks even at low pressures
- Will detect leaks of various gases in appliances, air & gas lines, cylinders, pipe & fittings, pressure vessels, tanks, tubing and valves
- Not for use on oxygen systems
- Available in clear or pink liquid
- Non-corrosive

Product No.	Size	Description	UPC	Ctn. Qty.
LD059	59 ml	MASTERS Leak Detector, Spray Bottle	067001000590	20
LD227HD	227 ml HD	MASTERS Leak Detector, Dauber Top Bottle	067001000125	20
LD500	500 ml	MASTERS Leak Detector, Spray Bottle	067001001658	12
LD4L	4 L	MASTERS Leak Detector, Jug	067001000187	4
LD20L	20 L	MASTERS Leak Detector, Pail	067001000521	1
LD4LP	4 L	MASTERS Pink Leak Detector, Jug	067001001993	4
LD20LP	20 L	MASTERS Pink Leak Detector, Pail	067001022264	1



#45802 shown



**Hercules™ Megabubble® Leak Detector**

- Detects even the smallest gas leaks.
- Produces long-lasting bubbles.
- Clings, even to vertical surfaces.
- Non-toxic, non-corrosive formula.
- Won't freeze.

Product No.	Size	Description	UPC	Ctn. Qty.
45801	237 ml	Megabubble® – Leak Detector with Dauber	032628458017	24
45804	473 ml	Megabubble® – Leak Detector with Sprayer	032628458048	12
45802	946 ml	Megabubble® – Leak Detector with Sprayer	032628458024	12
45803	3.78 L	Megabubble® – Leak Detector Jug	032628458031	4



# Category 3

## Copper Installation

The best soldered joints come from the best cleaning and fluxing tools, as well as a careful and professional technique. Our solder, flux and cleaning tools are designed for the professional who takes pride in knowing just how to do the job right and chooses the highest quality products.

**Application:**

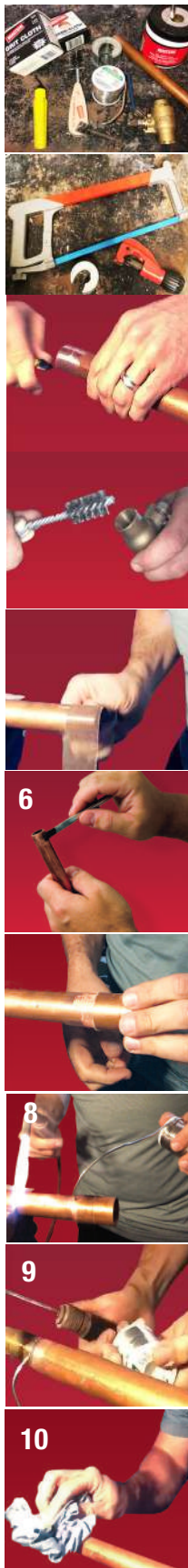

1. Assemble all material you will need.
2. Cut the copper pipe squarely using a tubing cutter or hacksaw.
3. Ream the pipe ends.
4. Clean copper fitting with manual or power fitting brush or sand grit cloth.
- 4.a) Avoid touching cleaned surface or leaving it exposed to air for a prolonged period of time.
5. Clean copper pipe/tubing with sand or grit cloth.
- 5.a) Avoid touching cleaned surface or leaving it exposed to air for a prolonged period of time.
6. Apply tinning or paste flux to the inside of the copper fitting and outside of the copper pipe.
7. Assemble the joint.
8. Heat the joint evenly, tapping wire solder against joint to check if it's hot enough to melt the solder. This indicates proper temperature has been reached.
9. Build up joint around perimeter of pipe/fitting. Remove heat and solder wire once a bead has formed around the fitting.
10. Allow the solder to cool before wiping away excess with a damp cloth.
- 10.a) It is a known practice to apply the flux to the last joint to help remove scorching marks. Be sure to wipe thoroughly afterwards to prevent future corrosion.

PLUMBING WIRE SOLDER



**Oatey® 95/5 Lead Free Plumbing Wire Solder**

- Lead Free Alloy of 95% Tin and 5% Antimony.
- 232°C - 240°C melting range.
- Meets the requirements of the U.S. Safe Drinking Water Act.
- Most commonly used where frequent and extreme temperature changes and vibrations occur.

Product No.	Size	Description	Gauge	UPC	Ctn. Qty.
22004	1/2 lb / 226 g	95/5 Wire Solder - Bulk	.117"	038753220048	10
22017	1 lb / 453 g	95/5 Wire Solder - Bulk	.117"	038753220178	25



**Oatey® Safe Flo® Lead Free Plumbing Wire Solder**

- Copper, bismuth, tin and silver alloy.
- 215°C - 237°C melting range.
- Meets ASTM Standard B-32 and the requirements of the Safe Water Drinking Act.
- Formulated for plumbing/potable water line applications.

Product No.	Size	Description	Gauge	UPC	Ctn. Qty.
23000	1/2 lb / 226 g	Silver Lead Free Wire Solder	.117"	038753230009	10
23001	1 lb / 453 g	Silver Lead Free Wire Solder	.117"	038753230016	25
23002	5 lb / 2.267 kg	Silver Lead Free Wire Solder	.117"	038753230023	10



**Oatey® 97/3 Lead Free Plumbing Wire Solder**

- Lead free alloy of 97% tin and 3% copper.
- 440°F - 572°F melting range.
- Meets the requirements of the Safe Drinking Water Act.
- Formulated for plumbing/potable water line applications.

Product No.	Size	Description	Gauge	UPC	Ctn. Qty.
20973	1 lb / 453 g	Copper/Tin Wire Solder	.117"	038753209739	25

SPECIALTY WIRE SOLDER



**Oatey® Wire Solder**

- 50/50 Alloy of 50% Tin and 50% Lead.
- 182°C - 216°C melting range for 50/50 Alloy.
- Commonly used for tin plating, seaming joints, copper DWV systems and sheet metal repair.
- Contains lead. Not for use on drinking water lines.

Product No.	Size	Description	Gauge	UPC	Ctn. Qty.
20019	1 lb / 453 g	50/50 Wire Solder - Bulk	.125"	038753200194	50
50192	1/2 lb / 226 g	50/50 Wire Solder - Bulk	.125"	038753501925	10



**Oatey® Acid Core Wire Solder**

- 40/60 Alloy of 40% Tin and 60% Lead.
- 50/50 Alloy of 50% Tin and 50% Lead.
- 182°C - 216°C melting range for 50/50 Alloy.
- 182°C - 237°C melting range for 40/60 Alloy.
- General purpose solder for repairing galvanized gutters, filling metal seams and other general repairs.
- Contains lead. Not for use on drinking water lines.

Product No.	Size	Description	Gauge	UPC	Ctn. Qty.
21115	1 lb / 453 g	40/60 Acid Core Wire Solder - Bulk	.125"	038753211152	10
50193	1/2 lb / 226 g	40/60 Acid Core Wire Solder - Bulk	.081"	038753501932	10

## SPECIALTY WIRE SOLDER



### Oatey® Rosin Core Wire Solder

- 40/60 Alloy of 40% Tin and 60% Lead.
- 182°C - 237°C melting range for 40/60 Alloy.
- Can be used for electrical applications including wiring and other fine electronic work.
- Contains lead. Not for use on drinking water lines.

Product No.	Size	Description	Gauge	UPC	Ctn. Qty.
21212	1 lb / 453 g	40/60 Rosin Core - Bulk	.125"	038753212128	10



### Oatey® Bar Solder

- 50/50 Alloy of 50% Tin and 50% Lead.
- 182°C - 237°C melting range.
- Contains lead. Not for use on drinking water lines.
- For use with copper drain piping, tin plating, seaming joints and sheet metal.

Product No.	Size	Description	UPC	Ctn. Qty.
20307	1-1/4 lb / 566 g	50% Tin / 50% Lead Bar	038753203072	50
21305	1-1/4 lb / 566 g	50% Tin / 50% Lead Bar	038753213057	10

## FLUX



### MASTERS® All Condition Soldering Paste

- Petrolatum based paste for typical sweat soldering with excellent wetting properties that allow for smooth flow and reduced voiding
- Paste is lead-free and NSF61G listed for use on potable water systems
- Works well on frozen, cold and wet pipe

Product No.	Size	Description	UPC	Ctn. Qty.
SP057	57 g	MASTERS Soldering Paste, Jar	067001000088	12
SP227	227 g	MASTERS Soldering Paste, Brush Top Jar	067001006211	24
SP454	454 g	MASTERS Soldering Paste, Tub	067001000118	12
SP20L	20 L	MASTERS Soldering Paste, Pail	067001000156	1
SP450	450 lbs	MASTERS Soldering Paste, Drum	067001022271	1



### MASTERS® Tinning Flux

- Specially formulated for use on lead-free valves and fittings
- Petrolatum based paste for typical sweat soldering with excellent wetting properties that allow for smooth flow and lead-free tin powder to draw solder in for reduced voiding
- Paste is lead-free and NSF61G listed for use on potable water systems
- Works well on frozen, cold and wet pipe

Product No.	Size	Description	UPC	Ctn. Qty.
TF227	227 g	MASTERS Tinning Flux, Brush Top Jar	067001000103	24
TF454	454 g	MASTERS Tinning Flux, Tub	067001006202	12

FLUX



**Oatey H-20<sup>®</sup> Water Soluble Paste Flux**

- Effective on most metals, excluding aluminum and stainless steel
- Compatible with all common plumbing solder alloys
- Helps prevent copper pipe corrosion related to flux contamination
- Good for large diameter copper piping
- 100% lead-free paste cleans and fluxes copper piping to provide uniform solder flow
- Meets ASTM Standard B-813
- NSF Standard 14 (Performance) and Standard 61 (Health Effects) certified
- Safe for use in potable water applications

Product No.	Size	Description	UPC	Ctn. Qty.
48362	454 g	H-20 <sup>®</sup> Water Soluble Paste Flux	038753483627	12

CLEANING TOOLS



**Oatey<sup>®</sup> Acid Brushes**

- Perfect brush for applying liquid or paste fluxes.
- Approximately 3" long, 1/2" wide.

Product No.	Size	Description	UPC	Ctn. Qty.
30710	1/2"	Acid Brush – Carded	038753307107	12
30712	1/2"	Acid Brush – with Barcode	038753307121	144



**MASTERS<sup>®</sup> Heavy Duty Fitting Brushes**

- High quality, heavy-duty brush for cleaning copper fittings
- Heavy gauge galvanized double-wound stem wire with double-spiral construction
- High carbon level fill wire

Product No.	Size	Description	UPC	Ctn. Qty.
FB50HD	0.50"	MASTERS Heavy Duty Fitting Brush	067001000644	10
FB75HD	0.75"	MASTERS Heavy Duty Fitting Brush	067001000651	10
FB100HD	1.00"	MASTERS Heavy Duty Fitting Brush	067001000668	10
FB125HD	1.25"	MASTERS Heavy Duty Fitting Brush	067001000736	1
FB150HD	1.50"	MASTERS Heavy Duty Fitting Brush	067001000743	1
FB200HD	2.00"	MASTERS Heavy Duty Fitting Brush	067001000750	1



**Oatey<sup>®</sup> Economy Fitting Brush**

- Easy to use, contoured, heavy duty handle is perfect for cleaning copper and brass fittings fast and effectively.
- High carbon twisted steel shaft and brush gives long life and durability.

Product No.	Size	Description	UPC	Ctn. Qty.
31327	1/2"	ID Fitting Brush w/ Heavy Duty Handle	038753313276	12
31328	3/4"	ID Fitting Brush w/ Heavy Duty Handle	038753313283	12
31329	1"	ID Fitting Brush w/ Heavy Duty Handle	038753313290	12
31330	1-1/4"	ID Fitting Brush w/ Heavy Duty Handle	038753313306	12
31331	1-1/2"	ID Fitting Brush w/ Heavy Duty Handle	038753313313	6
31332	2"	ID Fitting Brush w/ Heavy Duty Handle	038753313320	6
31404	1/2"	ID Fitting Brush w/ Heavy Duty Handle Carded	038753314044	10
31405	3/4"	ID Fitting Brush w/ Heavy Duty Handle Carded	038753314051	10



### Oatey® 4-In-1 Brush

- Includes long lasting high carbon steel brushes for cleaning the I.D. and O.D. of 1/2" and 3/4" copper tube and fittings.

Product No.	Size	Description	UPC	Ctn. Qty.
31348	1/2" & 3/4"	4-in-1 brush	038753313481	12
31407	1/2" & 3/4"	4-in-1 brush – Carded	038753314075	10



### Oatey® O.D. Tube Cleaning Brush

- Cleans the outside of copper and plastic tubing fast and effectively.
- The easy-to-grip brush ensures a clean surface and prepares the pipe for soldering or solvent welding.

Product No.	Size	Description	UPC	Ctn. Qty.
31345	1/2"	O.D. tube brush	038753313450	12
31346	3/4"	O.D. tube brush	038753313467	12
31347	1"	O.D. tube brush	038753313474	12
31412	1/2"	O.D. tube brush – Carded	038753314129	10
31413	3/4"	O.D. tube brush – Carded	038753314136	10



### MASTERS® 2-In-1 Power Fitting-Tube Cleaning Brushes

- Heavy duty bristles inside and out for cleaning both the ID of copper fittings & OD of copper tubing
- Fits on all power drills for a fast and efficient clean

Product No.	Size	Description	UPC	Ctn. Qty.
PFB50	0.50"	MASTERS 2-in-1 Power Fitting-Tube Cleaning Brush	067001003780	1
PFB75	0.75"	MASTERS 2-in-1 Power Fitting-Tube Cleaning Brush	067001003799	1

### MASTERS® Power Fitting Brushes

- Heavy duty bristle brushes
- Fits all power drills for a fast clean of the inside diameter of copper fittings

Product No.	Size	Description	UPC	Ctn. Qty.
PFB25HD	0.25"	MASTERS Heavy Duty Fitting Brush for Power Drill	067001003829	1
PFB50HD	0.50"	MASTERS Heavy Duty Fitting Brush for Power Drill	067001003706	1
PFB75HD	0.75"	MASTERS Heavy Duty Fitting Brush for Power Drill	067001003713	1
PFB100HD	1.00"	MASTERS Heavy Duty Power Fitting for Power Drill	067001003720	1
PFB125HD	1.25"	MASTERS Heavy Duty Fitting Brush for Power Drill	067001003737	1
PFB150HD	1.50"	MASTERS Heavy Duty Fitting Brush for Power Drill	067001003744	1
PFB200HD	2.00"	MASTERS Heavy Duty Fitting Brush for Power Drill	067001003751	1
PFB250HD	2.50"	MASTERS Heavy Duty Fitting Brush for Power Drill	067001003768	1
PFB300HD	3.50"	MASTERS Heavy Duty Fitting Brush for Power Drill	067001003775	1
PFB400HD	4.00"	MASTERS Heavy Duty Fitting Brush for Power Drill	067001003812	1





**MASTERS® Grit Cloth**

- Water-proof 180 grit open mesh cloth
- Open mesh allows debris to fall through screen rather than building up on surface
- High tensile strength that resists tearing

Product No.	Size	Description	UPC	Ctn. Qty.
GC5HD	5 Yd x 1 3/8"	MASTERS Gritcloth Heavy Duty Premium Grade	067001001573	25



**Oatey® Open Mesh Cloth**

- Water-proof 180 grit open mesh cloth
- Open mesh allows debris to fall through screen rather than building up on surface

Product No.	Size	Description	UPC	Ctn. Qty.
31320	1.5" x 5 yd	180 Open Mesh Cloth	038753313207	24
31321	1.5" x 10 yd	180 Open Mesh Cloth	038753313214	24



**MASTERS® Sand Cloth**

- Water resistant 120 grit plumbers roll for abrasive metal cleaning of all types
- High tensile strength that resists tearing

Product No.	Size	Description	UPC	Ctn. Qty.
SC2	2 Yd Roll	MASTERS Sandcloth	067001000583	50
SC5	5 Yd Roll	MASTERS Sandcloth	067001000552	100
SC25	25 Yd Roll	MASTERS Sandcloth	067001000569	20





### Oatey/MASTERS® Flame Protector Pads

- 9" x 12" woven ceramic (non asbestos) heat shield.
- Protects work areas from torches up to 2000°F.
- Packaged in a polybag.

Product No.	Size	Description	UPC	Ctn. Qty.
FPPHD912	9" x 12"	MASTERS Heavy Duty Flame Protector Pad	067001000729	1
31400	9" x 12"	Bagged Flame Protector	038753314006	5



### MASTERS® Pipeslice

- Self adjusting copper pipe cutter with a replaceable blade
- Ideal for confined spaces, especially where there is a minimal pipe to wall clearance

Product No.	Size	Description	UPC	Ctn. Qty.
KPX100	0.50"	MASTERS Pipeslice Tool	067001001757	1
KPX103	0.75"	MASTERS Pipeslice Tool	067001001764	1
KPX101	1.00"	MASTERS Pipeslice Tool	067001001740	1
KPX200	0.50"	MASTERS Pipeslice Replacement Wheel for Tool	067001001771	1
KPX234	0.75"	MASTERS Pipeslice Replacement Wheel for Tool	067001001788	1
KPX300	1.00"	MASTERS Pipeslice Replacement Wheel for Tool	067001001801	1



### MASTERS® Pipe Plug

- "Plumber's Bread"
- Stops the flow of water without draining down the system, allowing for soldering to be done without water getting into the soldering weld
- Plug slides through fittings, most gate valves and some ball valves with full bore
- Replacement parts available upon request

Product No.	Size	Description	UPC	Ctn. Qty.
B6001	0.5" to 2.5"	MASTERS Pipe Plug (Plumbers Bread) Complete Kit	067001003027	1



# Category 4

## Putty, Caulks and Water Barriers

Whether installing a faucet or strainer, resetting tile, sealing roof flashing, or repairing a pipe, professional plumbers can't afford a leak. They demand a watertight seal and they know that MASTERS®, Oatey® and Hercules® products are formulated to do the job right every time. Oatey caulks and putties are trusted and synonymous with high quality and top performance.



### MASTERS® Silicone Sealant

- Rated for interior and exterior use from -50°F to +450°F (-45°C to +232°C)
- Creates a mildew resistant and watertight seal when fully cured
- Ideal for tub/shower surrounds, sinks, siding, window frames, tiling and countertops
- Comes with a re-sealable cap to keep product from drying out
- NSF-51 listed for food preparation surfaces

Product No.	Size	Description	UPC	Ctn. Qty.
SS300-C	300 ml	MASTERS Silicone Sealant Cartridge CLEAR	067001003119	12
SS300-T	300 ml	MASTERS Silicone Sealant Cartridge TRANSLUCENT	067001003133	12
SS300-W	300 ml	MASTERS Silicone Sealant Cartridge WHITE	067001003102	12
SS80-C	80 ml	MASTERS Silicone Sealant Squeeze Tube CLEAR	067001000040	12
SS80-W	80 ml	MASTERS Silicone Sealant Squeeze Tube WHITE	067001000164	12



### MASTERS® High Temperature Silicone Sealant

- Rated for interior and exterior use from -85°F to +500°F (-65°C to +260°C) consistent or up to 600°F (316°C) intermittent and is oxygen sensor safe
- Creates a mildew resistant and watertight seal when fully cured and comes with a re-sealable cap to keep product from drying out
- Can be used to replace cork, felt, rubber or asbestos gaskets and is ideal for sealing around ovens, flues on gas appliances, metal stacks and ductwork
- RED 302 is NSF-51 listed for food preparation surfaces

Product No.	Size	Description	UPC	Ctn. Qty.
BLACK-302	300 ml	MASTERS® Silicone Sealant Cartridge HIGH TEMP BLACK	067001002051	12
RED-302	300 ml	MASTERS® Silicone Sealant Cartridge HIGH TEMP RED	067001001924	12



#MPS162-C shown

### MASTERS® Paintable Silicone

- Available in White or Clear - rated for interior and exterior use from -20°F to 180°F (-29°C to 82°C) once cured
- For caulking around showers, tubs, lavatories, window frames, siding, backsplashes, and sinks
- Cleans up with soap and water prior to curing. White product dries clear after 2 hours. Dries to touch and latex paintable in approx. 2 hours (24 hours for oil-based paint)

Product No.	Size	Description	UPC	Ctn. Qty.
MPS162-W	162 ml	MASTERS® Paintable Silicone Squeeze Tube - White- 162 mL	067001004512	12
MPS162-C	162 ml	MASTERS® Paintable Silicone Squeeze Tube - Clear - 162 mL	067001004505	12



### MASTERS® Trim Plus

- Interior/Exterior Acrylic Painter's Caulk rated for use from -18°C to 71°C (0°F to 160°F) once cured.
- Leaves a professional finish between walls and cabinetry, baseboards, wainscoting, door casing, window casing, crown moulding, and mitred joints
- Cleans up with soap and water. Flexible material won't crack or peel and adheres tightly
- Dries to the touch and paintable in approximately 2 hours (24 hours for oil-based paints)

Product No.	Size	Description	UPC	Ctn. Qty.
MTP300-W	300 ml	MASTERS® Trim Plus Painter's Caulk Cartridge - White- 300 mL	067001004529	12



### MASTERS® Silicone Tooling Foam

- Provides professional tooling results with no tools and less mess
- Virtually evaporates after use
- For best results, use with MASTERS® SILICONE SEALANT

Product No.	Size	Description	UPC	Ctn. Qty.
MSTF-370	370 g	MASTERS Silicone Tooling Foam Spray Can	067001003157	12



### Oatey® Plumber's Putty

- Fixture setting compound for setting frames, faucets, strainer baskets, etc.
- Stays flexible, will not crack or shrink. Easily workable, soft, pliable material.
- Not for use on marble, granite, plastic or any other dimensional stone.
- Meets Military Spec TTP-1536A.

Product No.	Size	Description	UPC	Ctn. Qty.
48003	397 g	Putty – Plastic Container	038753480039	24
48004	2 kg	Putty – Plastic Container	038753480046	6



### Oatey® Stain-Free Plumber's Putty

- Safe for most surfaces including: Granite, Marble, Quartz, Sandstone, Corian® or any natural, porous surface.
- Oil Free, NON-STAINING formula. Cleans up quickly.
- Great for sinks, bowls, faucets, strainers and shower bases.
- Stays flexible; will not crack or shrink. Not for use on ABS.

Product No.	Size	Description	UPC	Ctn. Qty.
48336	255 g	Stain-Free Putty	038753483368	18



### MASTERS® Emergency Repair Tape

- Non-adhesive, environmentally safe and non-toxic emergency repair tape
- Temporarily stops leaks of up to 150 PSI (water, air, steam) even without turning off the system
- UV and tear resistant to allow for maximum stretch and tension to form silicone mass through compression, preventing leakage from damaged pipe, valves or fittings

Product No.	Size	Description	UPC	Ctn. Qty.
RI-5-8A12	1" x 12 ft	MASTERS Emergency Repair Tape, Roll	890160001104	9
RI-5-8K12M	2" x 12 ft	MASTERS Emergency Repair Tape, Roll	890160001333	6
RI-5-8K40	2" x 36 ft	MASTERS Emergency Repair Tape, Roll	890160001173	1



### Oatey® Fix-It™ Stick Epoxy Putty

- Convenient multi-purpose sealing, patching and mending compound.
- Steel filled material, mixes in your hand and hardens in minutes.
- May be drilled, tapped, filed, sanded, sealed and painted when hardened.
- Non-toxic material contains no solvents and will not shrink.

Product No.	Size	Description	UPC	Ctn. Qty.
31270	113 g	Fix-It Stick Epoxy Putty	038753312705	12



### MASTERS® Porc-A-Fix

- Porcelain touch up paint used to fill chips, scratches and other imperfections in porcelain fixtures
- Non-yellowing, high gloss finish available in a variety of colours\*
- Easy one step process with brush-top applicator included

Product No.	Size	Description	UPC	Ctn. Qty.
AQ-01	15 ml	MASTERS Porcafix Aquasource White	067001022318	4
AS-01	15 ml	MASTERS Porcafix American Standard White	067001020017	4
AS-07	15 ml	MASTERS Porcafix American Standard Bone	067001020079	4
AS-11	15 ml	MASTERS Porcafix American Standard Fawn Beige	067001020116	4
AS-23	15 ml	MASTERS Porcafix American Standard Dresden Blue	067001020239	4
AS-33	15 ml	MASTERS Porcafix American Standard Sterling Silver	067001020338	4
BR-01	15 ml	MASTERS Porcafix Briggs White	067001020659	4
BS-01	15 ml	MASTERS Porcafix Basic White	067001020642	4
CA-01	15 ml	MASTERS Porcafix Crane White	067001020802	4
CA-13	15 ml	MASTERS Porcafix Crane Antique White	067001020925	4
CA-23	15 ml	MASTERS Porcafix Crane Platinum Gray	067001021021	4
CA-28	15 ml	MASTERS Porcafix Crane Warm White	067001021076	4
CA-29	15 ml	MASTERS Porcafix Crane Antique Bone	067001021083	4
EM-01	15 ml	MASTERS Porcafix Eljer Murray White	067001021151	4
EM-14	15 ml	MASTERS Porcafix Eljer Murray Natural	067001021274	4
GB-01	15 ml	MASTERS Porcafix Glacier Bay White	067001022301	4
GE-05	15 ml	MASTERS Porcafix General Electric White	067001021519	4
GE-10	15 ml	MASTERS Porcafix General Electric Almond	067001021526	4



### Hercules™ Roof & Flashing Sealant

- Long-lasting sealant. No separation; no stirring time; no objectionable odor.
- Forms durable, flexible, weatherproof coating.
- Can be applied on cold or wet surfaces. Not for use on rubber boot of flashings.

Product No.	Size	Description	UPC	Ctn. Qty.
25410	3.78 L	Roof & Flashing Sealant	032628254107	6



# Category 5

## Oils, Lubricants and Hand Cleaners

Oatey and MASTERS® offer an extensive line of oils, lubricants and hand cleaners.



**MASTERS® Cutting Oil**

- Heavy duty sulphurized, paraffinic oil specially blended for pipe threading, tapping, drilling, milling, broaching and general machine use
- Recommended for use on high carbon and alloy steels, stainless steel, many ferrous and non-ferrous metals as well as aluminum

Product No.	Size	Description	UPC	Ctn. Qty.
C0500	500 ml	MASTERS Cutting Oil, Spray Bottle	067001001962	12
C01L	1 L	MASTERS Cutting Oil, Spout Bottle	067001000484	12
C04L	4 L	MASTERS Cutting Oil, Jug	067001000491	4
C020L	20 L (5 gal)	MASTERS Cutting Oil, Pail	067001000507	1
C0205L	205 L (55 gal)	MASTERS Cutting Oil, Drum	067001000514	1



**MASTERS® Hand Cleaner**

- Industrial strength, lanolin-enriched pumice emulsion removes grease, grime, paint, carbon, soot, ink, cement and much more
- Contains no acids or other caustic chemicals and is biodegradable

Product No.	Size	Description	UPC	Ctn. Qty.
HC455	455ml	MASTERS Hand Cleaner Squeeze Bottle	067001001115	24
HC4L	4 L	MASTERS Hand Cleaner with Dispensing Pump, Jug	067001001122	6



**MASTERS® Lubricating Oiler**

- Premium grade, petroleum based, high viscosity, non-detergent general purpose lubricating oil
- Provides superior anti-wear protection and reduces sludge/sticking in close-tolerance components
- Dispenses upside down or right side up

Product No.	Size	Description	UPC	Ctn. Qty.
L0113HD	113 ml	MASTERS Lubricating Oiler, Sqz Bottle w Flex Spout	067001000132	20



**MASTERS® Pro-Grit Towels**

- Waterless hand cleaning with shop-sized and durable pre-moistened towels
- Heavy-duty towels clean with pumice scrubbing power
- Remove dirt and grime from hands, equipment, tools, work surfaces, etc.

Product No.	Description	UPC	Ctn. Qty.
MS72	MASTERS Pro-Grit Towels - 72 Towels	067001001108	6



**Oatey® Pipe/Gasket Lube**

- Non-toxic, soft, paste like material for lubricating bell joint pipe gaskets.
- Will not deteriorate natural or synthetic rubber.
- Will not support bacteria.
- Dissolves in hot water.

Product No.	Size	Description	UPC	Ctn. Qty.
30599	473 ml	Pipe Lubricant	038753305998	24
30600	946 ml	Pipe Lubricant	038753306001	12
30601	3.78 L	Pipe Lubricant	038753306018	4



**Hercules® Plumber's Grease**

- Unique grease formula to lubricate and prevent corrosion on valve stems, faucets, ballcock linkage, and other places where a water-resistant grease is needed.

Product No.	Size	Description	UPC	Ctn. Qty.
40601	2 oz.	300 Degree Plumber's Grease - petroleum based	032628406018	24
40610	2 oz.	Plumber's Silicone Grease	032628406100	24



# Category 6

## Drain and Waste System Cleaners

When plumbing professionals need to use drain and waste system cleaners, they turn to Hercules for the best quality and highest performing products available. Two trusted brands, Hercules® and Cherne®, offer a variety of solutions for the toughest of drain cleaning challenges. These include emergency drain openers, drain system maintenance including unique clog-specific formulations, septic system care and repair, root controls, and unique grease management products.





# The Right Drainage Product for the Right Job!

Identifying your drainage trouble is the first step towards correcting it.

Once you have selected the right drain opener to unclog your system, the next step is to decide on a preventative maintenance product to assure that blockages do not occur again.

*Use these charts to select the correct products for your system.*

DRAIN OPENERS	SOLUTIONS			PREVENTION		
	PROBLEM	Clobber®	Glug®	Sizzle®	PT-4™	PT-BI01™
Grease, Fats, Oils	•	•		•	•	•
Soaps, Detergents	•	•		•	•	•
Sludge	•	•		•	•	•
Paper, Cloth, Lint	•					
Hair		•				
Rust, Scale, Minerals			•			
Concrete Grout			•			
Slime			•	•	•	•

SEPTIC SYSTEMS	SOLUTIONS		PREVENTION		
	PROBLEM	Aid-Ox®	PT-4™	Septic-Flow™	Bacta-Life®
Sluggishness/Ponding	•	•	•		•
Drywell/Seepage Pit Back-Ups	•	•	•	•	•
Odors	•	•	•		•
Compacted Solids		•	•		
Tank Back-Up		•	•	•	

GREASE TRAPS	SOLUTIONS		PREVENTION	
	PROBLEM	PT-4™	PT-BI01™	PT-4™
Frequent Pumping			•	•
Back-Ups			•	•
Discharge Violations		•		•
Odors	•	•	•	•
Greasy Lines	•	•	•	•

**Due to the dangerous nature of these products, GLUG, CLOBBER and SIZZLE should only be used by licensed plumbers.**

## NON ACID DRAIN OPENERS



### Hercules™ Glug® Crystals

- Works fast on sluggish drains.
- Leaves no offensive after odor.
- Non-acid crystals clear sluggish drains, prevents clogs.
- Harmless to most metal and plastic pipe, valves and fittings.
- Not for use with garbage disposal.

Product No.	Size	Description	UPC	Ctn. Qty.
20412	543 g	Glug® – Crystals	032628204126	24
20413	907 g	Glug® – Crystals	032628204133	12
20415	2.7 kg	Glug® – Crystals	032628204157	4



### Hercules™ Glug® Liquid

- Kitchen - attacks clogs caused by buildup of fats, grease and foodstuffs.
- Bath - attacks clogs caused by hair and soap products.

Product No.	Size	Description	UPC	Ctn. Qty.
20450	946 ml	Glug® – Bath – Liquid	032628204508	10
20455	1.9 L	Glug® – Bath – Liquid	032628204553	6
20470	946 ml	Glug® – Kitchen – Liquid	032628204706	10
20475	1.9 L	Glug® – Kitchen – Liquid	032628204751	6

## ACID DRAIN OPENERS



#20211 shown

### Hercules™ Clobber®

- Fastest method for clearing emergency waste line stoppages.
- Rapidly disintegrates paper, rags, food and all organic matter.
- Not for retail use or sale; for professional use only.

Product No.	Size	Description	UPC	Ctn. Qty.
20205	940 ml	Clobber®	032628202054	12
20211	1.89 L	Clobber®	032628202115	6



### Hercules™ Sizzle®

- Triple action formula.
- Effective removal of urinary salts, lime, rust, scale, etc.
- Not for retail sale or use; for professional use only.

Product No.	Size	Description	UPC	Ctn. Qty.
20305	940 ml	Sizzle®	032628203051	12
20310	3.78 L	Sizzle®	032628203105	4

## FLOW IMPROVERS



### Hercules™ Wham®

- Powerful, multi-use, concentrated chemical emulsifier and waste system cleaner.
- Environmentally safe and biodegradable.
- Liquefies and disperses grease, soap, detergents and other organic waste.
- Will not harm digestive bacteria.
- Floral scent.
- Dissolves and controls build up - deodorizes.
- Safe to use in metal or PVC plastic plumbing.
- NOT RECOMMENDED FOR USE ON ABS

Product No.	Size	Description	UPC	Ctn. Qty.
20110	946 ml	Wham®	032628201101	12
20115	3.78 L	Wham®	032628201156	6



### Hercules™ Iron Ike® Rust Remover

- Dissolves and removes rust stains on contact.
- Contains no dangerous phosphoric acid, phosphates or chlorine.

Product No.	Size	Description	Ctn. Qty.
45400	591 ml	Iron Ike® Rust Remover	12



#137503 shown

### Hercules™ PT-4™

- Unique pine-scented, solvent-based, non-acid, non-caustic formulation that emulsifies grease.
- Safely liquefies and disperses grease, soap scum, food residue, sludge and other build-ups.
- Biodegradable.

Product No.	Size	Description	UPC	Ctn. Qty.
137501	940 ml	Hercules PT-4™	661000010712	12
137503	3.78 L	Hercules PT-4™	661000010729	4
137504	18.9 L	Hercules PT-4™ – Pail	661000010972	1
137507	56.7 L	Hercules PT-4™ – Drum	661000010743	1
137509	208 L	Hercules PT-4™ – Drum	661000010767	1



#137301 shown

### Hercules™ PT-BIO1™

- Concentrated liquid blend of fast acting grease and waste digesting bacteria.
- Safe, biodegradable grease and soil modifiers.
- Contains no acids, caustics, solvents or other harsh chemicals.

Product No.	Size	Description	UPC	Ctn. Qty.
137301	940 ml	Hercules PT-BIO1™	661000010415	12
137303	3.78 L	Hercules PT-BIO1™	661000010422	4
137304	18.9 L	Hercules PT-BIO1™ - Pail	661000010989	1
137307	56.7 L	Hercules PT-BIO1™ - Drum	661000010439	1

## SEPTIC PRODUCTS



### Hercules™ Aid-Ox®

- Oxygen-based foaming porosity restorer and cleaner.
- Frequently used on seasonal rentals.
- Non-acid, non-caustic formulation.

Product No.	Size	Description	UPC	Ctn. Qty.
252034	4.08 L	Hercules Aid-Ox®	661000010347	4

**SEPTIC PRODUCTS**



**Hercules™ Septic-Flow™**

- Concentrated liquid bacterial additives.
- Keeps septic systems in peak condition.

Product No.	Size	Description	UPC	Ctn. Qty.
139302	1.89 L	Hercules Septic-Flow™	661000020018	6



**Hercules™ Bacta-Life®**

- A concentrated powdered product.
- Replaces beneficial bacteria.
- Use immediately after pumping your septic or cesspool system.

Product No.	Size	Description	UPC	Ctn. Qty.
222031	473 ml	Hercules Bacta-Life®	661000010323	12



**Hercules™ Cesspool Cleaner**

- Usage: Emergencies to temporarily eliminate back-ups and overflows.
- Dissolves all organic material including: hair, grease, paper, etc.
- Removes grease and sludge from baffles, pump floats, distribution boxes and lateral lines.
- Pump system within a few hours of adding this product.
- Add Bacta-Life® 5 days after treatment to restore microbial activity.

Product No.	Size	Description	UPC	Ctn. Qty.
20715	25 lb / 11 kg	Hercules Cesspool Cleaner	032628207158	1

**DRAIN FLUSHERS**



**Cherne® Clog-Buster® Drain Flusher**

- Unclogs drain pipes in seconds.
- Simply remove aerator from faucet spigot and attach faucet adapter to garden hose.
- Attaches to standard garden hose fitting.
- Natural rubber body provides excellent seal.

Product No.	Size	Description	Ctn. Qty.
303127	1"-2"	Clog-Buster® Drain Flusher	1
303135	1-1/2"-3"	Clog-Buster® Drain Flusher	1
303143	4"- 6"	Clog-Buster® Drain Flusher	1
006193		Clog-Buster® Faucet Adapter	1



**MASTERS® Plunger**

- Accordion style plunger with more push power than any other style
- Funnel-nose design ensures perfect fit in toilet bowls and kitchen sinks preventing slippage and splash back

Product No.	Size	Description	UPC	Ctn. Qty.
MP100		MASTERS Plunger	077115100000	1



# Category 7

## Heating Chemicals and Anti-Freeze

A well-maintained hydronic heating system provides reliable performance even during the harshest winters. Heating maintenance professionals know that top quality materials are critical to achieve superior performance. That's why contractors depend on Hercules™ and MASTERS®. They are formulated for high performance and developed with both the user and the environment in mind.

**How to Maintain a Boiler System**

**Prior to Use: Read all product labels carefully.**

Keep container closed when not in use. Avoid eye and skin contact. Wear safety glasses with side shields and wear rubber gloves.

1. Turn off the gas and autofeeder and disconnect the electrical supply.
2. Bleed a small amount of fluid from hydronic loop to inspect for rust, sediment or mucus-like sludge to determine if system restorer is required.
3. If sludge and sediment are present, drain system completely until water runs clear.
4. Flush system with Sludgehammer System Restorer by mixing 1 quart System Restorer with 1 gallon of water in a bucket and pumping into the system.
5. Without breaking suction, add enough water to completely fill the system. Close valve. Remove pump. Reconnect the power and circulate for 4 hours.
6. Completely drain and flush the system.
7. Recharge system with Sludgehammer Corrosion Inhibitor and Cryo-Tek.
8. Reconnect power supply and circulate for two hours.
9. Recheck inhibitor and propylene glycol (PG) levels using Cryo-Tek test strips, pH meter, or refractometer.

**For Regular Maintenance**

- a. Open drain valve and remove a small amount of liquid (close valve).
- b. Use Cryo-Tek Test Strips to check the corrosion inhibitor and PG levels.
- c. Add Sludgehammer Corrosion Inhibitor if system is low.
  - i. To add Inhibitor: open drain valve and remove 2 gallons of water. Mix one quart of Sludgehammer and two gallons of water.
  - ii. Attach pump hose to drain valve, prime the pump, and turn it on.
  - iii. Without breaking suction, pump one gallon of water to ensure all Inhibitor gets into the system.
  - iv. Close drain valve, and turn pump off.
  - v. Reconnect the power supply and circulate for two hours before rechecking the Inhibitor and anti-freeze levels.
10. Add PG if the system is low.
  - a. Properly dilute Anti-Freeze in water.
  - b. Attach pump hose to drain valve, prime the pump, and turn it on.
  - c. Close drain valve, and turn pump off.
  - d. Reconnect the power supply, and circulate for two hours before rechecking the inhibitor and anti-freeze levels.



# Cryo-Tek™ Products Keep Systems Clean and Operating Efficiently.

Improves heat transfer and minimizes wear to moving parts.



	Original	-100	AG	Universal
<b>PG Ratio</b>	45%	55%	95%	97%
<b>PG Quality</b>	Virgin	Virgin	Virgin	Virgin
<b>Color</b>	Blue	Red	Blue	Purple
<b>Freeze Point</b>	-22	-70	-70	<-60
<b>Flow Point</b>	-27	-80	-80	<-70
<b>Burst Point</b>	-80	-100	-100	-100
<b>pH</b>	8.5-100	9.0-100	9.0-10	7.5-8.5
<b>Viscosity</b> (At 50% - 100°F)	5 cps	7 cps	37 cps	35 cps
<b>Boiling Point</b>	220°F	230°F	370°F	320°F
<b>Temperature Rating</b>	300°F	300°F	300°F	300°F
<b>Heat Transfer</b>	.908	.843	.681	.600



#353319

### Hercules™ Universal Cryo-Tek™

Our triple-protection inhibitor package stabilizes pH to prevent corrosion, chelates, hard water minerals, and inhibits the formation of scale and sediment.

- Concentrated universal solution with 97% virgin propylene glycol.
- Triple Protection Inhibitor stabilizes pH to prevent corrosion, chelates, hard water minerals, and inhibits scale and sediment formation.
- Approved for use with **all metals, PEX and elastomeric tubing** (not for use with CPVC)
- Meets and exceeds the corrosion protection requirements of ASTM D1384.

Product No.	Size	Description	Ctn. Qty.
353330	3.78 L / Gallon	Universal Cryo-Tek	6
353319	18.9 L / 5 gal.	Universal Cryo-Tek	1
353327	208 L / 55 gal.	Universal Cryo-Tek	1

For application, freeze protection and specific dilutions, view submittal sheet at herchem.com



#352859

### Hercules™ Cryo-Tek™ AG

- Concentrated Arctic Grade solution with **95% Virgin Propylene Glycol**.
- Triple Protection Inhibitor stabilizes pH to prevent corrosion, chelates, hard water minerals, and inhibits scale and sediment formation.
- Approved for use with **copper, steel, iron, brass, PEX and elastomeric tubing** (not for use with galvanized, CPVC and aluminum).

Product No.	Size	Description	UPC	Ctn. Qty.
352859	18.9 L / 5 gal.	Cryo-Tek AG	032628352858	1
352899	208 L / 55 gal.	Cryo-Tek AG	032628352896	1



#352849

### Hercules™ Cryo-Tek™-100

- Pre-Mixed: Ready to use formula with **55% Virgin Propylene Glycol**.
- Triple Protection Inhibitor stabilizes pH to prevent corrosion, chelates, hard water minerals and inhibits scale and sediment formation.
- Approved for use with **copper, steel, iron, brass, PEX and elastomeric tubing** (not for use with galvanized, CPVC, and aluminum).

Product No.	Size	Description	UPC	Ctn. Qty.
352819	3.78 L / Gallon	Cryo-Tek-100	032628952812	6
352849	18.9 L / 5 gal.	Cryo-Tek-100	032628952843	1
352879	208 L / 55 gal.	Cryo-Tek-100	032628952874	1



#352609

### Hercules™ Cryo-Tek™ Original

- Pre-Mixed: Ready to use formula with **45% Virgin Propylene Glycol**.
- Triple Protection Inhibitor stabilizes pH to prevent corrosion, chelates, hard water minerals and inhibits scale and sediment formation.
- Approved for use with **copper, steel, iron, brass, PEX and elastomeric tubing** (not for use with galvanized, CPVC, and aluminum).

Product No.	Size	Description	UPC	Ctn. Qty.
352609	18.9 L / 5 gal.	Cryo-Tek Original	032628352605	1
352679	208 L / 55 gal.	Cryo-Tek Original	032628352674	1



## SYSTEM TESTING



### Hercules™ Cryo-Tek™ Test Strips

- Contains 10 color-coded disposable test strips.
- Each checks levels of propylene glycol and corrosion protection.
- Check glycol and inhibitor levels annually; add Hercules Sludgehammer Universal Corrosion Inhibitor if level is low.

Product No.	Size	Description	UPC	Ctn. Qty.
35271		Test Kit, 6 - 10 Packs		6



### Hercules™ pH Test Meter

- Ideal for checking acidity or alkalinity of heating or potable water systems.

Product No.	Size	Description	UPC	Ctn. Qty.
35272		pH Test Meter	032628352728	1



### Hercules™ Refractometer

- Fastest and easiest method for ensuring accurate ethylene and propylene glycol levels.

Product No.	Size	Description	UPC	Ctn. Qty.
35290		Refractometer	032628352902	1

## MAINTENANCE PRODUCTS



### Hercules™ Sludgehammer™ Universal Corrosion Inhibitor

- Multi-purpose formula controls scale, corrosion, boiler noise and hydrogen gassing.
- Helps restore efficiency to hydronic heating systems.
- Safe for all metals including aluminum and stainless steel.
- Compatible and for use with all Cryo-Tek antifreezes..

Product No.	Size	Description	UPC	Ctn. Qty.
35297	946 ml / 32 oz.	Universal Corrosion Inhibitor	032628352674	6



### MASTERS® Pro-Tek 922

- Oxygen inhibiting boiler treatment to protect aluminum, brass, copper, iron and steel equipment from corrosion and scale build up
- Recommended by major boiler manufacturers for system use
- Environmentally friendly and non-hazardous
- Concentrated formula (mix 1 part chemical to 50 parts water)

Product No.	Size	Description	UPC	Ctn. Qty.
MPT1L-C	1 L	MASTERS Pro-Tek 922 Concentrated Inhibitor, Bottle	067001001641	12
MPT4L-C	4 L	MASTERS Pro-Tek 922 Concentrated Inhibitor, Jug	067001002037	4

SYSTEM REPAIR PRODUCTS



**Hercules™ Base Hit™ II Sealant & Lubricant**

- Seals and prevents leaks.
- Remedies most squeaking pumps.
- Will not form sludge or precipitates or impede normal operation.

Product No.	Size	Description	UPC	Ctn. Qty.
30213	354 ml / 12 oz.	Base Hit II	032628302013	12



**Hercules™ Boiler Liquid**

- Seals and repairs cracks or leaks in hot water or steam boilers.\*
- Makes a strong lasting repair on difficult leaks.
- Resists pressure and is not affected by boiler cleaners.
- Prevents surging and will not clog or coat heating coils controls, vents or valves.

Product No.	Size	Description	UPC	Ctn. Qty.
30115	946 ml / 32 oz.	Boiler Liquid	032628301153	12

\*Hot water portion of steam boiler

SYSTEM CLEANING PRODUCTS



**Hercules™ Sludgehammer™ System Restorer & Noise Reducer**

- Combination formula removes sludge and corrosion while reducing boiler noise.
- Helps restore efficiency to hydronic heating systems.
- Compatible with aluminum and stainless steel heat exchangers.
- Flush from system after use.

Product No.	Size	Description	UPC	Ctn. Qty.
35298	946 ml / 32 oz.	System Restorer & Noise Reducer	032628352988	6



**Hercules™ Boiler and Heating System Cleaner**

- Formulated to clean and condition steam and hot water systems.
- Protects pumps by lubricating seals and zone valves.
- Prevents clogging of valves and prevents corrosion.
- Safe and easy to use.

Product No.	Size	Description	UPC	Ctn. Qty.
35206	946 ml / 32 oz	Boiler and Heating System Cleaner	032628352063	12
35211	3.78 L / Gallon	Boiler and Heating System Cleaner	032628352117	6

#35211 shown



**MASTERS® Hydro-Solv 9100**

- Safely and effectively cleans aluminum, brass, copper, iron and steel boiler components in new and used systems
- Environmentally friendly, non-hazardous and contains no acid or TSP
- Helps recover lost efficiency and removes scale, corrosion, bacteria, solder/flux, cutting oil, dirt and rust
- Concentrated formula (mix 1 part chemical to 50 parts water)

Product No.	Size	Description	UPC	Ctn. Qty.
MHS1L-C	1 L	MASTERS Hydro-Solv 9100 Concentrated Cleaner, Bottle	067001001719	12
MHS4L-C	4 L	MASTERS Hydro-Solv 9100 Concentrated Cleaner, Jug	067001002044	4



#35245



### Haymaker™ Tankless Water Heater Descaler

- Non-corrosive, effectively removes scale - Professional grade formula
- Clear liquid allows you to see the results of the descaling - Clear, citric acid-based formula
- Safe for potable water. NSF 60 listed
- Will not harm the environment. VOC free, biodegradable
- \*Users have everything they need to descale a tankless water heater. Available in a kit with everything needed to descale a system - 946 ml Haymaker solution, 13 L pail, two hoses, electric pump with 3m cord.

Product No.	Size	Description	UPC	Ctn. Qty.
35240	946 ml / 32 oz.	Descaler	032628352407	6
35231	3.78 L / Gallon	Descaler	032628352315	6
35245		Descaler Kit*		1

The Haymaker solution dissolves 3 times the amount of scale as a gallon of white vinegar, without the foul odor! The concentration of acetic acid in vinegar is relatively low (5%), whereas Haymaker is 50% by weight concentrate that is mixed with water before use.



### MASTERS® HVAC Cleaner

- Heavy-duty, multi-purpose liquid cleaner
- Removes grease, inorganic soils, smoke deposits, etc

Product No.	Size	Description	UPC	Ctn. Qty.
HVLC946	946 ml	MASTERS Heavy Duty HVAC Cleaner, Spray Bottle	067001001153	12



# Category 8

## Bowl Setting Wax Gaskets and Bolts

For generations of professional plumbers, Oatey® has set the standard for the highest quality and best performing toilet-setting products.



**Oatey® Heavy Duty Wax Bowl Ring**

- 100% pure petroleum wax gasket for setting any floor type closet bowl.
- Fits 3" or 4" waste lines and meets Military Spec. TT-P-1536A.
- Provides a permanent seal impervious to vermin, odors, gases and acids.

Product No.	Size	Description	UPC	Ctn. Qty.
31190	3" or 4"	Heavy Duty Wax Bowl Ring	038753311906	48



**Oatey® Heavy Duty Wax Bowl Ring w/ Sleeve**

- 100% pure petroleum wax gasket for setting any floor type closet bowl.
- Provides a permanent seal impervious to vermin, odors, gases and acids.
- Fits 3" or 4" waste lines and meets Military Spec. TT-P-1536A.
- Polyethylene sleeve extends discharge opening for a more positive seal assuring proper bowl alignment.

Product No.	Size	Description	UPC	Ctn. Qty.
31193	3" or 4"	Wax Bowl Ring With Plastic Sleeve with Hardware	038753311937	24
31194	3" or 4"	Wax Bowl Ring With Plastic Sleeve	038753311944	24



**Oatey® MaxWax® Wax Bowl Ring**

- 40% thicker wax ring with a polyethylene sleeve to assure a tight seal.
- 100% pure petroleum wax gasket for setting any floor type closet bowl.
- Fits 3" to 4" waste lines and meets Military Spec. TT-P-1536A.
- Polyethylene sleeve extends discharge opening for a more positive seal assuring proper bowl alignment.
- Provides a permanent seal impervious to vermin, odors, gases and acids.

Product No.	Size	Description	UPC	Ctn. Qty.
31188	3" or 4"	MaxWax Bowl Ring with Sleeve	038753311883	12



**Harvey® No-Seep® 3 in. or 4 in. No 2 Reinforced Wall Mount Gasket**

- Maximum seal on wall hung toilets
- Fits 3" and 4" waste lines.
- Reinforced with urethane ring and fibers embedded into wax

Product No.	Size	Description	UPC	Ctn. Qty.
004005	3" or 4"	Specialty reinforced wax gasket	078864040050	24



**Oatey® Wax Free Gasket**

- For repairs and new installations.
- 3" diameter hole.
- No wax needed.

Product No.	Size	Description	UPC	Ctn. Qty.
42759	3"	Wax Free Gasket	038753427591	12



**Oatey® Urinal Wax Ring**

- Urinal wax ring has a urethane sponge to provide resiliency.

Product No.	Size	Description	UPC	Ctn. Qty.
31187	1-1/2" or 2"	Urinal Wax Ring	038753311876	12

**BOWL SETTING WAX GASKETS AND BOLTS**



**Hercules™ Johni Quick Bolts**

- Unique new bolting system for mounting toilets.
- Fast and easy; just push down and twist to tighten in one quick motion.
- Eliminates "fall-through" and wobble.

Product No.	Size	Description	UPC	Ctn. Qty.
90905	5/16" x 2-1/4"	Johni Quick Bolts Pair	032628909052	100



#051158D shown

**Harvey™ Nylon Bol-Bolts**

- Universal application fits all flanges and material types.
- Increased head size so bolts won't fall through the drain pipe.
- More threads and specified design create a secure fit so the nut will stay in place and reduce backing out.

Product No.	Size	Description	UPC	Ctn. Qty.
051158	2-1/2" x 5/16"	Nylon Bolt Bulk Pack (2 bolts and 2 nuts per bag)	078864511581	50
051158-D	2-1/2" x 5/16"	Nylon Bolt Display Bucket of Bolts (2 bolts and 2 nuts per bag)	078864511581	50
051159	3-1/2" x 5/16"	Nylon Bolt Bulk Pack (2 bolts and 2 nuts per bag)	078864511598	50



**Oatey® Liquilock™**

- Solidifies water for easy toilet removal.
- Prevents water spills.
- Gel forms in 4 minutes. Simply flush gel away once toilet is re-set.
- Non-toxic, Lo-V.O.C.

Product No.	Size	Description	UPC	Ctn. Qty.
31418		0.6 oz. Liquilock Single Pack	038753314181	50
31420		16 oz. Liquilock Bulk Pack	038753314204	6



# Category 9

## Drains and Closet Flanges

Oatey drains and closet flanges come in the widest variety of sizes, materials and configurations. PVC, cast iron, ABS, no matter what your shower drain or closet flange need, Oatey has the part you need to do the job right.

CLOSET FLANGES



**Oatey® Level-Fit Closet Flange With Plastic Ring**

- 3" or 4" all plastic flange solvent welds inside of 4" or over 3" Schedule 40 DWV pipe.
- 3" inside fit flange fits inside 3" Schedule 40 DWV pipe.
- Four mounting slots.
- Four countersunk holes for secure attachment to the floor.

Product No.	Size	Description	UPC	Ctn. Qty.
43502	3" or 4"	ABS closet flange w/ plastic ring	038753435022	12
43503	3" or 4"	PVC closet flange w/ plastic ring	038753435039	12

**Inside Fit Closet Flange With Plastic Ring**

43506	3"	ABS closet flange w/ plastic ring and w/ test cap	038753435060	12
43508	3"	ABS closet flange w/ plastic ring and w/o test cap	038753435084	12



**Oatey® Level-Fit Closet Flange With Stainless Steel Ring**

- Corrosion resistant stainless steel ring.
- 3" x 4" flange fits inside of 4" or over 3" Sch. 40 DWV pipe.
- 4" flange fits over 4" Sch. 40 DWV pipe.
- Meets ASTM D2661 and D2665.
- Adjustable ring for alignment of bolts and screws, sits flush on floor.

Product No.	Size	Description	UPC	Ctn. Qty.
43494	3" or 4"	ABS closet flange w/SS ring w/o test cap	038753434940	12
43495	3" or 4"	PVC closet flange w/SS ring w/o test cap	038753434957	12

**Over 4" Fit Flange**

43498	4"	ABS closet flange w/SS ring w/o test cap	038753434988	12
43499	4"	PVC closet flange w/SS ring w/o test cap	038753434995	12



**Oatey® Level Fit 45° Closet Flange With Plastic Ring**

- 45° bend, 360° rotation allows wide range of plumbing connections in tight spaces.
- Design allows flange to set flush.
- Fits over 3" or inside 4" pipe.

Product No.	Size	Description	UPC	Ctn. Qty.
43815	3" or 4"	ABS 45° Closet Flange w/plastic ring w/o test cap	038753438153	6
43816	3" or 4"	PVC 45° Closet Flange w/plastic ring w/o test cap	038753438160	6



**Oatey® Level Fit 45° Closet Flange With Stainless Steel Ring**

- Solvent weld connection for Sch. 40, 3" outside or 4" inside fit
- Durable and corrosion resistant 430 stainless steel ring
- Ring provides adjustability with 360° swivel
- No restriction throat complies with IAPMO IGC 67-2014el flow requirements

Product No.	Size	Description	UPC	Ctn. Qty.
43607	3" or 4"	PVC 45° Bend Closet Flange w/ SS Ring	038753436074	12
43608	3" or 4"	ABS 45° Bend Closet Flange w/ SS Ring	038753436081	12



**Oatey® Over 4" Level-Fit Closet Flange**

- Fits over 4" Schedule 40 DWV pipe.
- With plastic ring.

Product No.	Size	Description	UPC	Ctn. Qty.
43548	4"	ABS Over Pipe w/o Test Cap	038753007267	12



**Oatey® Level Fit Closet Flange With Plastic Ring, Long Mounting Slots**

- All plastic flange solvent welds inside of 4" or over 3" Schedule 40 DWV pipe.
- Four countersunk holes for secure attachment to the floor.
- Radial slots extend 130° to allow exact alignment of the water closet.

Product No.	Size	Description	UPC	Ctn. Qty.
43510	3"-4"	ABS closet flange w/plastic ring, long mounting slots – w/o test cap	038753435107	12
43511	3"-4"	PVC closet flange w/plastic ring, long mounting slots – w/o test cap	038753435114	12



## CLOSET FLANGES



### Oatey® Fast Set® Closet Flange With Plastic Ring or Stainless Steel Ring

- Patent-pending Bolt Shelf designed to keep bolts in track that is molded into the flange-eliminates bolt fall-through
- 3 strike points make test cap knockout effortless.

Product No.	Size	Description	UPC	Ctn. Qty.
48470	3" hub	Fast Set® Testable ABS Closet Flange w/plastic ring	038753484709	12
48471	3" hub	Fast Set® Testable ABS Closet Flange w/SS ring	038753484716	12



### Oatey® Level Fit Offset Closet Flange With Stainless Steel/Metal Ring

- The metal ring provides added strength and cracking resistance to the flange and can be rotated to allow precise alignment of bolts and screws.
- Solvent welds inside of 4" or over 3" Schedule 40 DWV pipe.
- 2" offset allows a margin of error for drain pipe/flange alignment.

Product No.	Size	Description	UPC	Ctn. Qty.
43500	3"-4"	Offset Metal Ring - ABS w/Metal Ring	038753435008	12 
43501	3"-4"	Offset Metal Ring - PVC w/Metal Ring	038753435015	12 
43605	3"-4"	PVC Offset Closet Flange w/ SS Ring	038753436050	12
43606	3"-4"	ABS Offset Closet Flange w/ SS Ring	038753436067	12



### Oatey® Spigot Fit Closet Flange

- For use in hub-end of fitting.
- Fits on inside of fitting.
- Eight countersunk holes and two closet bolt slots for secure attachment to the floor.

Product No.	Size	Description	UPC	Ctn. Qty.
43584	3"	Spigot Fit Closet Flange, ABS, w/plastic ring	038753435848	12
43585	3"	Spigot Fit Closet Flange, PVC, w/plastic ring	038753435855	12
43586	4"	Spigot Fit Closet Flange, ABS, w/plastic ring	038753435862	12
43587	4"	Spigot Fit Closet Flange, PVC, w/plastic ring	038753435879	12



#42253 shown

### Oatey® Cast Iron Closet Flange

- Cast iron closet flange, no caulking.
- Complete with body, brass ring, bolts and gasket.
- To be used on plastic or heavy weight, no hub or service weight soil pipe.

Product No.	Size	Description	UPC	Ctn. Qty.
42253	3"	Cast iron flange w/o test cap	038753422534	6
42255	4"	Cast iron flange w/o test cap	038753422558	6
42256	4"	Cast iron flange w/ test cap	038753422565	6



### Oatey® Replacement Closet Flange

- Slides inside of 4" cast iron or Sch. 40 DWV plastic pipe.
- 3" stainless steel bolts are tightened from the finished floor.
- No caulking required.
- Compression joint allows up to 6.2 cm of adjustment to the riser.

Product No.	Size	Description	UPC	Ctn. Qty.
43538	4"	ABS Closet Flange Replacement	038753435381	2
43539	4"	PVC Closet Flange Replacement	038753435398	2

CLOSET FLANGE REPAIR



**Oatey® Twist-N-Set® Replacement Closet Flange**

- Replaces broken cast iron closet flanges.
- Installs easily without tools.
- Smooth unrestricted flow design.
- Gasket expands to fit inside service weight, heavy weight and no hub pipe.

Product No.	Size	Description	UPC	Ctn. Qty.
43650	4"	ABS Twist-N-Set closet flange	038753436500	2
43651	4"	PVC Twist-N-Set closet flange	038753436517	2
43653	4"	Cast Iron Twist-N-Set closet flange	038753436531	2
43654	3"	PVC Twist-N-Set closet flange	038753436548	2
43655	3"	ABS Twist-N-Set closet flange	038753436555	2



**Oatey® Horizontal Adjustable Urinal Flange Kit**

- Horizontal mounting slots accommodate urinals with 3-1/2" to 7" mount centers.
- Kit includes all bolts, nuts, washers and gaskets.
- The flange fits over 2" Sch. 40 DWV pipe (Prod No. 43540 and 43541).

Product No.	Size	Description	UPC	Ctn. Qty.
43540	2"	ABS Horizontal Adjustable Urinal Flange Kit	038753435404	10
43541	2"	PVC Horizontal Adjustable Urinal Flange Kit	038753435411	10
43542	2"	ABS Horizontal Spigot Urinal Flange Kit	038753435428	10
43543	2"	PVC Horizontal Spigot Urinal Flange Kit	038753435435	10

**Oatey® Set-Rite® Toilet Flange Extension System**

Stop double stacking wax rings! Double stacking may lead to uneven compression, which could cause potential leak paths. Long term undetected leak paths would require costly water damage restoration.

Use the Set-Rite® System instead for an air tight and leak free seal, every time!

- The only patented and UPC listed flange extension product acceptable for repair and remodels.
- Set-Rite eliminates improper double stacking of wax with spacers to raise the height and a gasket to seal the system.
- Set-Rite can be used on existing PVC, ABS, Cast Iron and Stainless Steel ringed flanges.



Product No.	Size	Description	UPC	Ctn. Qty.
43440C	1/8"- 2-1/4"	Toilet Flange Extension Kit - Extender, 1/8", 1/4", 1/2", 3/4" Spacers, Gasket, 3-1/2" Self-Tapping Screws	038753434407	5
43401	1/8"- 1-1/2"	Toilet Flange Extension Kit - Extender, 1/8", 1/4", 1/2" Spacers, Gasket, 2-1/2" Self-Tapping Screws	038753434018	5
43402	1/8"-2"	Toilet Flange Extension Kit - Extender, 1/8", 3/4" Spacers, Gasket, 2-1/2" Self-Tapping Screws	038753434025	5
43403	1/8"- 1-1/4"	Toilet Flange Extension Kit - Extender, 1/8", 1/2" Spacers, Gasket, 2-1/2" Self-Tapping Screws	038753434032	5
43404	1/4"- 3/8"	Toilet Flange Extension Kit - Extender, 1/8", 1/4" Spacers, Gasket, 2-1/2" Self-Tapping Screws	038753434049	5
43405		Toilet Flange Extension Only	038753434056	6

**Oatey® Fix-It™ Repair Ring**

- Securely repairs broken, cracked or worn out mounting flanges without replacing the current toilet flange.
- 10 mounting holes for wide range of installation options on all flooring types.
- 4 slotted mounting tabs fit under all toilets. The elongated slots allow for angled screws to grab flooring.
- Perfect length bolt slot prevents bending during installation for secure, level and leak-free repairs.

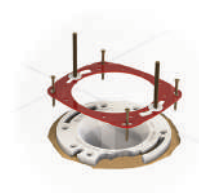

Product No.	Size	Description	UPC	Ctn. Qty.
42775C		Fix-It Repair Ring Toilet Flange Mounting Repair Unit	038753905839	10

## CLOSET FLANGE REPAIR



### Set-Rite® Toilet Flange Spacers

Product No.	Size	Description	UPC	Ctn. Qty.
43446C	1/8"-1-5/8"	Set-Rite Spacer Kit containing 1/8", 1/4", 1/2", 3/4" spacers	038753434469	12
43410	3/4"	Set-Rite Spacer	038753434100	12
43411	1/2"	Set-Rite Spacer	038753434117	18
43412	1/4"	Set-Rite Spacer	038753434124	36
43413	1/8"	Set-Rite Spacer	038753434131	72



### Closet Flange Spacer Kit

- For use when overlaying, replacing or tiling bathroom floors.
- Kit includes gaskets, 1/2" spacer, closet bolts and shims.

Product No.	Size	Description	UPC	Ctn. Qty.
43645		Closet Flange Spacer Kit	038753436456	12



### Closet Flange Spacer

- Builds up an existing closet flange when new flooring is installed.
- Can be stacked to desired height.

Product No.	Size	Description	UPC	Ctn. Qty.
43519	1/4"	Closet Flange Spacer – PVC	038753435190	12
43646	1/2"	Closet Flange Spacer – PVC	038753436463	12



### Galvanized Wood Support Kit

- For repairing wobbly toilets or loose closet flanges without replacing the floor.
- Includes two heavy gauge pre-slotted flange plates, six floor attaching screws and 4 large flathead flange assembly screws.
- Use for holes cut too large, rotting floors or screws that pulled loose.
- Easy-to-use floor and flange support.

Product No.	Size	Description	UPC	Ctn. Qty.
43555		Galvanized Wood Support Kit	038753435558	12



### Stainless Steel Closet Flange Replacement Ring

- For use on 3" or 4" closet flanges.
- Six countersunk holes and two closet bolt slots for secure attachment to the floor.

Product No.	Size	Description	UPC	Ctn. Qty.
42778	3" or 4"	Stainless Steel Closet Flange	038753427782	12

CLOSET FLANGE REPAIR



**Oatey® Moss Bay Replacement Flange**

- For rusted or corroded metal closet flange rings.
- For use on PVC or ABS closet flanges.
- Includes 1/4" closet bolt.

Product No.	Size	Description	UPC	Ctn. Qty.
42777		Moss Bay Replacement Flange	038753427775	12



**Oatey® Brass Closet Flange Replacement Ring**

- For use 4" closet flanges.
- Three countersunk holes and three closet bolt slots for secure attachment to the floor.

Product No.	Size	Description	UPC	Ctn. Qty.
43551	3" or 4"	Brass Closet Flange Replacement Ring	038753007281	12

SHOWER DRAINS FOR PREFORMED BASES



**Oatey® No-Calk Shower Base Drain**

- Made of Cast Brass or Plastic.
- Designed for use with all preformed shower stall bases.
- Mechanically attaches over 2" Schedule 40 DWV pipe. The drain is fixed to the drain pipe from above the shower base, ideal for slab construction.
- Can be used with 1-1/2" Schedule 40 DWV pipe and 1-1/2" or 2" Copper DWV pipe when caulking gasket is replaced.
- Fiber and rubber gasket provide a tight seal to the base.
- Available with 4-1/4" Stainless Steel Snap-Tite Strainer.

Product No.	Size	Description	UPC	Ctn. Qty.
<b>140 Series Brass No-Calk Shower Drain</b>				
42150	2"	140 NC Brass NO-CALK shower drain w/stainless steel strainer	038753421506	12



**101 PNC Series Plastic No-Calk Shower Drain**

42075	2"	101 PNC PVC NO-CALK shower drain w/plastic strainer	038753420752	12
42077	2"	101 PNC ABS NO-CALK shower drain w/plastic strainer	038753420776	12
42084	2"	101 PNC ABS NO-CALK shower drain w/stainless steel strainer	038753420844	12
42099	2"	101 PNC PVC NO-CALK shower drain w/stainless steel strainer	038753420998	12
42180	2"	101 PNC PVC NO-CALK shower drain w/stainless steel square strainer		
42181	2"	101 PNC ABS NO-CALK shower drain w/stainless steel square strainer		



**No-Calk Shower Drain Accessories**

42156	2"	Rubber caulking gasket to fit 2" Sch. 40 DWV drain pipe in the NO-CALK shower drains	038753421568	12
42157	2"	Rubber caulking gasket to fit 2" No-hub cast iron pipe in the NO-CALK shower drains	038753421575	12
42158	2"	Rubber caulking gasket to fit 2" copper DWV drain pipe in the NO-CALK shower drains	038753421582	12
42159	1-1/2"	Rubber caulking gasket to fit 1-1/2" copper DWV drain pipe in the NO-CALK shower drains	038753421599	12
42163	1-1/2"	Rubber caulking gasket to fit 1-1/2" Sch. 40 DWV drain pipe in the NO-CALK shower drains	038753421636	12
42239		NO-CALK shower drain wrench – carded	038753422398	4



## SOLVENT WELD SHOWER DRAINS



#42093 shown

### Oatey® 101 PS Series Solvent Weld Shower Drain

- Solvent weld over 2" Sch. 40 DWV pipe.
- Universal 4-1/4" Snap-Tite Strainer.
- Drain body is sealed to shower base with rubber gasket and fiber slip washer.

Product No.	Size	Description	UPC	Ctn. Qty.
42086	2"	101 PS ABS Solvent Weld Shower Drain w/plastic strainer	038753420868	12
42089	2"	101 PS PVC Solvent Weld Shower Drain w/plastic strainer	038753420899	12
42093	2"	101 PS ABS Solvent Weld Shower Drain w/stainless steel strainer	038753420936	12
42097	2"	101 PS PVC Solvent Weld Shower Drain w/stainless steel strainer	038753420974	12



### Oatey® 102 Series Solvent Weld Shower Drain With Receptor Base

- Solvent weld over 2" Sch. 40 DWV pipe.
- Universal 4-1/4" Snap-Tite Strainer.
- Drain body is sealed to shower base with rubber gasket and fiber slip washer.

Product No.	Size	Description	UPC	Ctn. Qty.
42033	2"	2-part ABS Solvent Weld Shower Drain w/brushed nickel square strainer	038753420332	12
42034	2"	2-part ABS Solvent Weld Shower Drain w/stainless steel square strainer	038753420448	12
42035	2"	2-part PVC Solvent Weld Shower Drain w/brushed nickel square strainer	038753420356	12
42036	2"	2-part PVC Solvent Weld Shower Drain w/stainless steel square strainer	038753420363	12
42044	2"	2-part ABS Solvent Weld Shower Drain w/stainless steel strainer	038753420448	12
42045	2"	2-part PVC Solvent Weld Shower Drain w/stainless steel strainer	038753420455	12
42049	2"	2-part PVC Solvent Weld Shower Drain w/plastic strainer	038753420493	12
42052	2"	2-part ABS Solvent Weld Shower Drain w/matte black round strainer	038753420523	12
42053	2"	2-part ABS Solvent Weld Shower Drain w/matte black square strainer	038753420530	12



### Oatey® 103 Series Offset Solvent Weld Shower Drain With Receptor Base

- Designed for use with preformed shower stall bases.
- Solvent weld over 2" Sch. 40 DWV pipe.
- Universal 4-1/4" Snap-Tite Strainer.
- Drain body provides 1-1/2" offset to work around joists and imperfect slab penetrations.
- Drain body is sealed to shower base with rubber gasket and fiber slip washer.

Product No.	Size	Description	UPC	Ctn. Qty.
42787		2" PVC Offset Drain	038753427874	8
42788		2" ABS Offset Drain	038753427881	8

## CAULKING AND THREADING SHOWER DRAINS



### Oatey® 101 Series Brass NPT And Caulking Drain

- Drain body is sealed to shower base with rubber gasket and fiber slip washer.
- Three DWV connection methods for metallic pipe.
- Universal 4-1/4" Snap-Tite Strainer.

Product No.	Size	Description	UPC	Ctn. Qty.
42070	1-1/2"	101NPT1.5-BRASS DRN w/FMLE IPS	038753420707	6

## SHOWER DRAINS FOR BUILT-UP SHOWERS

### Oatey® 130 Series Shower Drain For Tile Shower Bases

- Designed for use on built-up shower bases of tile or marble, where a shower pan liner is used.
- Quarter turn reusable test plug available
- Base features four countersunk holes to secure to the substrate/deck
- Low profile design for use in tight spaces.
- Solvent welds over 2" or inside 3" Schedule 40 DWV pipe.
- Reversible clamping collar is secured with stainless steel bolts into brass inserts to prevent stripping.
- Tile ring helps preserve grout lines



#### 130 Series ABS Complete Drain Assemblies

Product No.	Size	Description	UPC	Ctn. Qty.
42267	2" or 3"	Square Low Profile Drain Polished SS Screw-In Strainer w/Ring	038753422671	12
42274	2" or 3"	Square Low Profile Drain Polished SS Screw-In Strainer w/Ring w/Plug	038753422749	12
42265	2" or 3"	Square Low Profile Drain Polished SS Snap-In Strainer w/Ring	038753422657	12
42262	2" or 3"	Round Low Profile Drain Polished SS Screw-In Strainer w/Ring	038753422626	12
42272	2" or 3"	Round Low Profile Drain Polished SS Screw-In Strainer w/Ring w/ Plug	038753422725	12
42260	2" or 3"	Round Low Profile Drain Polished SS Snap-In Strainer w/Ring	038753422602	12

#### 130 Series ABS Barrel With Strainer (to be used with drain base)

Product No.	Size	Description	UPC	Ctn. Qty.
<b>ABS</b>				
42276	2" or 3"	Square Barrel With Polished SS Screw-In Strainer w/Ring	038753422763	12
42278	2" or 3"	Square Barrel With Brushed Nickel Screw-In Strainer w/Ring	038753422787	12
42280	2" or 3"	Square Barrel With Oil Rubbed Bronze Screw-In Strainer w/Ring	038753422800	12
42288	2" or 3"	Square Barrel With Polished SS Snap-In Strainer w/Ring	038753422886	12
42290	2" or 3"	Square Barrel With Brushed Nickel Snap-In Strainer w/Ring	038753422909	12
42292	2" or 3"	Square Barrel With Oil Rubbed Bronze Snap-In Strainer w/Ring	038753422923	12
42282	2" or 3"	Round Barrel With Polished SS Screw In Strainer w/Ring	038753422824	12
42284	2" or 3"	Round Barrel With Brushed Nickel Screw-In Strainer w/Ring	038753422848	12
42286	2" or 3"	Round Barrel With Oil Rubbed Bronze Screw-In Strainer w/Ring	038753422862	12
42294	2" or 3"	Round Barrel With Polished SS Snap-In Strainer w/Ring	038753422947	12
42296	2" or 3"	Round Barrel With Brushed Nickel Snap-In Strainer w/Ring	038753422961	12
42298	2" or 3"	Round Barrel With Oil Rubbed Bronze Snap-In Strainer w/Ring	038753422985	12
42261	2" or 3"	Round Low Profile Drain Polished SS Snap-In Strainer w/Ring	038753422619	12



## SHOWER DRAINS FOR BUILT-UP SHOWERS



Gray PVC Shown

### 130 Series PVC Complete Drain Assemblies

Product No.	Size	Description	UPC	Ctn. Qty.
42266	2" or 3"	Square Low Profile Drain Polished SS Screw-In Strainer w/Ring	038753422664	12
42273	2" or 3"	Square Low Profile Drain Polished SS Screw-In Strainer w/Ring w/Plug	038753422732	12
42264	2" or 3"	Square Low Profile Drain Polished SS Snap-In Strainer w/Ring	038753422640	12
42263	2" or 3"	Round Low Profile Drain Polished SS Screw-In Strainer w/Ring	038753422633	12
42271	2" or 3"	Round Low Profile Drain Polished SS Screw-In Strainer w/Ring w/Plug	038753422718	12
42260	2" or 3"	Round Low Profile Drain Polished SS Snap-In Strainer w/Ring	038753422602	12

### Oatey® 130 Series PVC Barrel with Strainer (to be used with drain base)

Product No.	Size	Description	UPC	Ctn. Qty.
42275	2" or 3"	Square Barrel With Polished SS Screw-In Strainer w/Ring	038753422756	12
42277	2" or 3"	Square Barrel With Brushed Nickel Screw-In Strainer w/Ring	038753422770	12
42279	2" or 3"	Square Barrel With Oil Rubbed Bronze Screw-In Strainer w/Ring	038753422794	12
42287	2" or 3"	Square Barrel With Polished SS Snap-In Strainer w/Ring	038753422879	12
42289	2" or 3"	Square Barrel With Brushed Nickel Snap-In Strainer w/Ring	038753422893	12
42291	2" or 3"	Square Barrel With Oil Rubbed Bronze Snap-In Strainer w/Ring	038753422916	12
42281	2" or 3"	Square Barrel With Oil Rubbed Bronze Snap-In Strainer w/Ring	038753422817	12
42283	2" or 3"	Round Barrel With Brushed Nickel Screw-In Strainer w/Ring	038753422831	12
42285	2" or 3"	Round Barrel With Oil Rubbed Bronze Screw-In Strainer w/Ring	038753422855	12
42293	2" or 3"	Round Barrel With Polished SS Snap-In Strainer w/Ring	038753422930	12
42295	2" or 3"	Round Barrel With Brushed Nickel Snap-In Strainer w/Ring	038753422954	12
42297	2" or 3"	Round Barrel With Oil Rubbed Bronze Snap-In Strainer w/Ring	038753422978	12



### 130 Series ABS/PVC Drain Base

Product No.	Size	Description	UPC	Ctn. Qty.
42268		PVC Low Profile Drain Base Clamping Collar And Fasteners	038753422688	12
42269		ABS Low Profile Drain Base Clamping Collar And Fasteners	038753422695	40

### 130 Series Test Plug

Product No.	Size	Description	UPC	Ctn. Qty.
42270		130 Series Test Plug	038753422701	12



## SHOWER DRAINS FOR BUILT-UP SHOWERS



#42201 shown

### Oatey® 151 Series Cast Iron And Plastic Two Part Shower Drain

- Designed for use with tile and marble showers.
- Cast iron or plastic variations with threaded, No-Calk or solvent weld connections.
- 3-1/4" Crown Ring Set.

Product No.	Size	Description	UPC	Ctn. Qty.
42192	1-1/2"	151 cast iron w/ 1-1/2" NPT connection	038753421926	6
42197	2"	151 cast iron w/ 2" NPT connection	038753421971	6
42201	2"	151 cast iron w/ 2" Sch. 40 No-calk connection	038753422015	6
42206	2"	151 cast iron w/ 2" No Hub connection	038753422060	6
42211	2"	151 ABS drain w/ 2" solvent weld connection	038753422114	6
42215	2"	151 cast iron drain top & ABS bottom w/ 2" solvent weld connection	038753422152	6



### Oatey® Designline Decorative Shower Drains

- Designline by Oatey offers rugged dependability under the seamless sophistication of the latest, tasteful, graceful flair in plumbing.
- Made of 304 grade stainless steel construction.
- Every drain channel comes fully assembled and ready to install. Accessories included, provide compatibility with both PVC and CPE waterproofing liners.



#DLS2360R2 shown

Product No.	Description	UPC	Ctn. Qty.
DSS2040R2	4" X 4" Square Shower Drain (Square) SS	038753905402	3
DS32040	4" X 4" Square Shower Drain (Square) Matte Black	038753905518	3
DSS1040R2	4" X 4" Square Shower Drain (Tile-In) SS	038753905396	3
DSS2060R2	6" X 6" Square Shower Drain (Square) SS	038753905433	3
DS32060	6" X 6" Square Shower Drain (Square) Matte Black	038753905631	3
DSS1060R2	6" X 6" Square Shower Drain (Tile-In) SS	038753905426	3
DS32060	6" x 6" Square Shower Drain (Square) Matte Black	038753905631	3
DLS2240R2	24" Linear Shower Drain (Square) SS	038753905310	2
DL32240	24" Linear Shower Drain (Square) Matte Black	038753905730	2
DLS1240R2	24" Linear Shower Drain (Tile-In) SS	038753905303	2
DLS2280R2	28" Linear Shower Drain (Square) SS	038753905334	2
DL32280	28" Linear Shower Drain (Square) Matte Black	038753905822	2
DLS2360R2	36" Linear Shower Drain (Square) SS	038753905389	2
DLS1360R2	36" Linear Shower Drain (Tile-In) SS	038753905372	2

- use with 130 Series Drain Base



## REPLACEMENT STRAINERS

### Oatey® 130 Series Carded Replacement Strainers



Product No.	Size	Description	UPC	Ctn. Qty.
42330	2" or 3"	Square Screw-In Shower Strainer w/Ring - Polished SS	038753423302	4
42331	2" or 3"	Square Screw-In Shower Strainer w/Ring - Brushed Nickel	038753423319	4
42332	2" or 3"	Square Screw-In Shower Strainer w/Ring - Oil Rubbed Bronze	038753423326	4
42336	2" or 3"	Square Snap-In Shower Strainer w/Ring - Polished SS	038753423364	4
42337	2" or 3"	Square Snap-In Shower Strainer w/Ring - Brushed Nickel	038753423371	4
42338	2" or 3"	Square Snap-In Shower Strainer w/Ring - Oil Rubbed Bronze	038753423388	4
42333	2" or 3"	Round Screw-In Shower Strainer w/Ring - Polished SS	038753423333	4
42334	2" or 3"	Round Screw-In Shower Strainer w/Ring - Brushed Nickel	038753423340	4
42335	2" or 3"	Round Screw-In Shower Strainer w/Ring - Oil Rubbed Bronze	038753423357	4
42339	2" or 3"	Round Snap-In Shower Strainer w/Ring - Polished SS	038753423395	4
42340	2" or 3"	Round Snap-In Shower Strainer w/Ring - Brushed Nickel	038753423401	4
42341	2" or 3"	Round Snap-In Shower Strainer w/Ring - Oil Rubbed Bronze	038753423418	4



### Oatey® 4-1/4" Snap-Tite Strainer

- For 101BR, 101PNC, 101NPT, 101PS, 102, 103, and 131 Series Shower Drains with round strainers.
- UltraShine® PVD lifetime finish where noted.
- For series 101BR, 101PNC, 101NPT, 101PS, 102, 103, 13D, 140 NC Series Shower Drains.

Product No.	Size	Description	UPC	Ctn. Qty.
42003	4-1/4"	Carded White Plastic – carded - Round	038753420035	12
42004	4-1/4"	UltraShine® PVD Polished Brass – carded - Round	038753420042	12
42005	4-1/4"	Stainless Steel – carded - Round	038753420059	12
42014	4-1/4"	UltraShine® PVD Satin Nickel – carded - Round	038753420141	4
42015	4-1/4"	UltraShine® PVD Satin Chrome – carded - Round	038753420158	4
42016	4-1/4"	Biscuit – carded - Round	038753420165	4
42017	4-1/4"	Rubbed Bronze – carded - Round	038753420172	4
42018	4-1/4"	Brushed Nickel – carded - Round	038753420189	4
42019	4-1/4"	White Metal – carded - Round	038753420196	4
42140	4-1/4"	Brushed Nickel - Square	038753421407	66

### Oatey® 4" Screw-Tite Strainer

- For screw-on tile shower drains and 2" x 3" slab shower drains.
- Polished brass strainers have PVD lifetime finish.
- For 130 and 131 Series Shower Drains and 43566, 43567, 43578, 43579, 43580, 43581.

Product No.	Size	Description	UPC	Ctn. Qty.
43862	4"	UltraShine® PVD Polished Brass – carded	038753438627	12

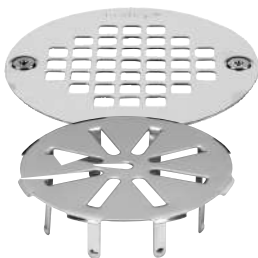

### Oatey® Stainless Steel Snap-In Strainer

- Fits inside Schedule 40 DWV pipe.

Product No.	Size	Description	UPC	Ctn. Qty.
42730	2"	Snap-In Stainless Steel Strainer	038753427300	12
42731	3"	Snap-In Stainless Steel Strainer	038753427317	12
42732	4"	Snap-In Stainless Steel Strainer	038753427324	12

## GENERAL PURPOSE DRAINS



### Oatey® Short General Purpose Drain

- Fits over 2" or inside of 3" Sch. 40 DWV pipe.
- Only 3 cm high for tight spaces.
- Removable 4" stainless steel strainer.

Product No.	Size	Description	UPC	Ctn. Qty.
43580	2" or 3"	ABS short general purpose drain w/ 4" stainless steel Screw-Tite strainer	038753435800	12
43581	2" or 3"	PVC short general purpose drain w/ 4" stainless steel Screw-Tite strainer	038753435817	12



### Oatey® General Purpose Drain

Product No.	Size	Description	UPC	Ctn. Qty.
43578	2" or 3"	ABS general purpose drain w/ 4" stainless steel Screw-Tite strainer	038753435787	12
43579	2" or 3"	PVC general purpose drain w/ 4" stainless steel Screw-Tite strainer	038753435794	12
43582	3" or 4"	ABS general purpose drain w/ 5" stainless steel Screw-Tite strainer	038753435824	12
43583	3" or 4"	PVC general purpose drain w/ 5" stainless steel Screw-Tite strainer	038753435831	12



### Oatey® Light Duty Utility Drains

43598	3" or 4"	ABS general purpose drain w/ 5" brass grate and metal ring	038753435985	12
43599	3" or 4"	PVC general purpose drain w/ 5" brass grate and ring	038753435992	12
43600	3" or 4"	ABS general purpose drain w/ 5" nickel alloy grate	038753436005	12
43601	3" or 4"	PVC general purpose drain w/ 5" nickel grate	038753436012	12



### Oatey® All Plastic Drain

- Also suitable for use as a vent stack or air inlet strainer.

Product No.	Size	Description	UPC	Ctn. Qty.
43560	2"	ABS Snap-In Drain	038753435602	12
43561	2"	PVC Snap-In Drain	038753435619	12
43564	3"	ABS Snap-In Drain	038753435640	12
43565	3"	PVC Snap-In Drain	038753435657	12
43568	4"	ABS Snap-In Drain	038753435688	12
43569	4"	PVC Snap-In Drain	038753435695	12

## GENERAL PURPOSE DRAINS



### Plastic Drain With Removable Stainless Steel Strainer

- Strainer can be removed to allow access to the pipe.

Product No.	Size	Description	UPC	Ctn. Qty.
43562	3"	ABS Snap-In Drain w/ 3-1/2" Stainless Steel Strainer	038753435626	12
43563	3"	PVC Snap-In Drain w/ 3-1/2" Stainless Steel Strainer	038753435633	12
43566	4"	ABS Snap-In Drain w/ 4" Stainless Steel Strainer	038753435664	12
43567	4"	PVC Snap-In Drain w/ 4" Stainless Steel Strainer	038753435671	12



### All Plastic Outlet Cover

- For covering an open pipe.
- Protects piping from dirt and debris.

Product No.	Size	Description	UPC	Ctn. Qty.
43572	3"	ABS Snap-In Drain Outlet Cover	038753435725	12
43573	3"	PVC Snap-In Drain Outlet Cover	038753435732	12



### Bell Trap Drain

- Fits over 1-1/2" Sch. 40 DWV pipe or into 2" coupling.
- Fits over 3" or inside of 4" Sch. 40 DWV pipe.

Product No.	Size	Description	UPC	Ctn. Qty.
43632	3" or 4"	ABS 9" x 9" Bell Trap Drain	038753436326	4
43633	3" or 4"	PVC 9" x 9" Bell Trap Drain	038753436333	4
43636	1-1/2"	ABS 6" x 6" Bell Trap Drain	038753436364	4
43637	1-1/2"	PVC 6" x 6" Bell Trap Drain	038753436371	10



### Utility Drain

- Fits over 1-1/2" Sch. 40 DWV pipe or into 2" coupling.

Product No.	Size	Description	UPC	Ctn. Qty.
43640	1-1/2"	ABS 6" x 6" Utility Drain	038753436401	10
43641	1-1/2"	PVC 6" x 6" Utility Drain	038753436418	10



### Four-Way Area Drain

- Fits over 2" or 3" Schedule 40 DWV pipe.
- General purpose drain for use in garages and utility rooms.
- Sump for large capacity.

Product No.	Size	Description	UPC	Ctn. Qty.
43596	2" or 3"	Four-Way Area Drain, PVC	038753435961	10



### Integral Trap Drain

- One piece trap drain/cleanout design molded from PVC or ABS plastic.
- 3-3/4" deep sump bowl.
- Solvent weld over 2" Sch. 40 DWV pipe.
- Built in 2" FIP threadway for backwater device.
- ASTM 2665 and ASTM D2661.
- Internal 1-1/2" – 14 NPT – cleanout.

Product No.	Size	Description	UPC	Ctn. Qty.
42723	2"	ABS Floor Drain with P-Trap and Cleanout	038753427232	2
42724	2"	PVC Floor Drain with P-Trap and Cleanout	038753427249	2
42725	2"	Backwater Valve Device	038753427256	6

## CLEANOUT ASSEMBLIES



### Oatey® All Plastic 2" x 3" Snap-In Cleanout Assemblies

Product No.	Size	Description	UPC	Ctn. Qty.
43710	2" or 3"	ABS Snap-In Cleanout Assembly	038753437101	12
43711	2" or 3"	PVC Snap-In Cleanout Assembly	038753437118	12



#43733 shown

### Oatey® All Plastic Snap-In Cleanout Assemblies

• Fits inside of Sch. 40 DWV pipe fitting.

Product No.	Size	Description	UPC	Ctn. Qty.
43730	3"	ABS Snap-In Cleanout Assembly	038753437309	12
43731	3"	PVC Snap-In Cleanout Assembly	038753437316	12
43732	4"	ABS Snap-In Cleanout Assembly	038753437323	12
43733	4"	PVC Snap-In Cleanout Assembly	038753437330	12
43764	2-1/3"	ABS Replacement Plug for the 3" and the 2" or 3" cleanout assemblies	038753437644	6
43765	2-1/3"	PVC Replacement Plug for the 3" and the 2" or 3" cleanout assemblies	038753437651	6
43766	3-1/2"	ABS Replacement Plug for the 4" regular and the 3" Hub cleanout assemblies	038753437668	1
43767	3-1/2"	PVC Replacement Plug for the 4" regular and the 3" Hub cleanout assemblies	038753437675	6

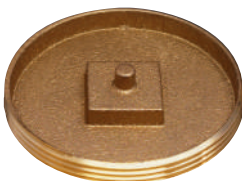

#42745 shown

### Oatey® Brass Cleanout Plug With Recessed Head

• All sizes are countersunk and tapped.

Product No.	Size	Description	UPC	Ctn. Qty.
42740	1-1/2"	Brass Cleanout Plug	038753427409	12
42741	2"	Brass Cleanout Plug	038753427416	12
42742	2-1/2"	Brass Cleanout Plug	038753427423	12
42743	3"	Brass Cleanout Plug	038753427430	12
42744	3-1/2"	Brass Cleanout Plug	038753427447	12
42745	4"	Brass Cleanout Plug	038753427454	12

## CLEANOUT ASSEMBLIES



### Oatey® Cover Plate

- Cover plates conceal the clean-out plug access hole.
- Packaged with 1/4" screw.

Product No.	Size	Description	UPC	Ctn. Qty.
34405	4" (10.2 cm)	Flat Chrome Cover Plate	038753344058	25
34406	5" (12.7 cm)	Flat Chrome Cover Plate	038753344065	25
34410	4" (10.2 cm)	Flat White Cover Plate	038753344102	25
34411	5" (12.7 cm)	Flat White Cover Plate	038753344119	25
34415	4" (10.2 cm)	Bell Chrome Cover Plate	038753344157	25
34416	5" (12.7 cm)	Bell Chrome Cover Plate	038753344164	25
34420	4" (10.2 cm)	Bell White Cover Plate	038753344201	25
34421	5" (12.7 cm)	Bell White Cover Plate	038753344218	25



### Oatey® Stainless Steel Cover Plate

- Stainless steel cover plates conceal the clean-out plug access hole.
- Protective film cover.
- 1/4" – 20 screw included.

Product No.	Size	Description	UPC	Ctn. Qty.
42780	3" (7.6 cm)	Stainless steel cover plate	038753427805	12
42781	4" (10.2 cm)	Stainless steel cover plate	038753427812	12
42782	5" (12.7 cm)	Stainless steel cover plate	038753427829	12
42783	6" (15.2 cm)	Stainless steel cover plate	038753427836	12
42784	8" (20.3 cm)	Stainless steel cover plate	038753427843	12

### MASTERS® Urinal Cleanout Covers

- Round stainless steel cover attached with tightening screw to expandable test plug in various sizes
- Includes hex key for easy installation
- Total unit depth is 1-3/4"



Product No.	Plug Size	Description	UPC	Ctn. Qty.
UC150	1.5"	MASTERS Urinal Cleanout Cover with 1.5" plug, 4.5" cover	067001002013	1
UC200	2.0"	MASTERS Urinal Cleanout Cover with 2.0" plug, 4.5" cover	067001002020	1
UC300	3.0"	MASTERS Urinal Cleanout Cover with 3.0" plug, 4.5" cover	067001002068	1
UC400	4.0"	MASTERS Urinal Cleanout Cover with 4.0" plug, 4.5" cover	067001002082	1
UC300-L	3.0"	MASTERS Urinal Cleanout Cover with 3.0" plug, 8.0" cover	067001002075	1
UC400-L	4.0"	MASTERS Urinal Cleanout Cover with 4.0" plug, 8.0" cover	067001002099	1

**BACKWATER VALVES**



**Oatey® Backwater Valves**

- Protects low areas or basements from backflow or waste from street sewers.
- Elastomeric seal in quick action flapper ensures a water tight seal.
- Threaded access cap incorporates a neoprene seal for positive sealing and can be tightened or removed by hand.
- Valve hub fits DWV pipe and can be adapted for sewer and drain pipe.

Product No.	Size	Description	UPC	Ctn. Qty.
43900	3"	PVC backwater valve	038753439006	4
43901	3"	ABS backwater valve	038753439013	4
43904	4"	PVC backwater valve	038753439044	2
43905	4"	ABS backwater valve	038753439051	2
43908	6"	PVC backwater valve	038753439082	1
43909	6"	ABS backwater valve	038753439099	1

**Oatey® Backwater Accessories**

Product No.	Size	Description	UPC	Ctn. Qty.
43915	3"	PVC threaded cap	038753439150	1
43918	4"	PVC threaded cap	038753439181	1
43919	4"	ABS threaded cap	038753439198	1
43924	3"	PVC flapper w/O-ring	038753439242	1
43927	4"	PVC flapper w/O-ring	038753439273	1
43929	6"	PVC flapper w/O-ring	038753439297	1

**ACCESSORIES**



**Oatey® Traps**

- One-piece design.
- Made from 3/4" PVC Schedule 40 DWV pipe.

Product No.	Size	Description	UPC	Ctn. Qty.
42757	3/4"	PVC Condensate "P"-trap	038753427577	24
42758	3/4"	PVC Condensate Running Trap	038753427584	24



**Oatey® Mushroom Vent Cap**

- Fits either 3" or 4" vent stacks.
- Shipped fully assembled.
- Includes 3 hex-head bolts.
- Made of high-impact PVC.

Product No.	Size	Description	UPC	Ctn. Qty.
43805	3" or 4"	Mushroom Vent Cap	038753438054	12



**Oatey® Mystic Rainwater Diverter**

- Rainwater collection system.
- Directs rainwater from downspouts into collection barrels for re-use in lawn/garden watering.
- Can be painted.
- Includes 1.2 m hi-flo hose.

Product No.	Size	Description	UPC	Ctn. Qty.
14211	3"	Rainwater Diverter Kit	038753142111	4



## designline<sup>®</sup>

**Designline** by Oatey offers rugged dependability under the seamless sophistication of the latest, tasteful, graceful flair in plumbing.



CATEGORY **9** DRAINS AND CLOSET FLANGES

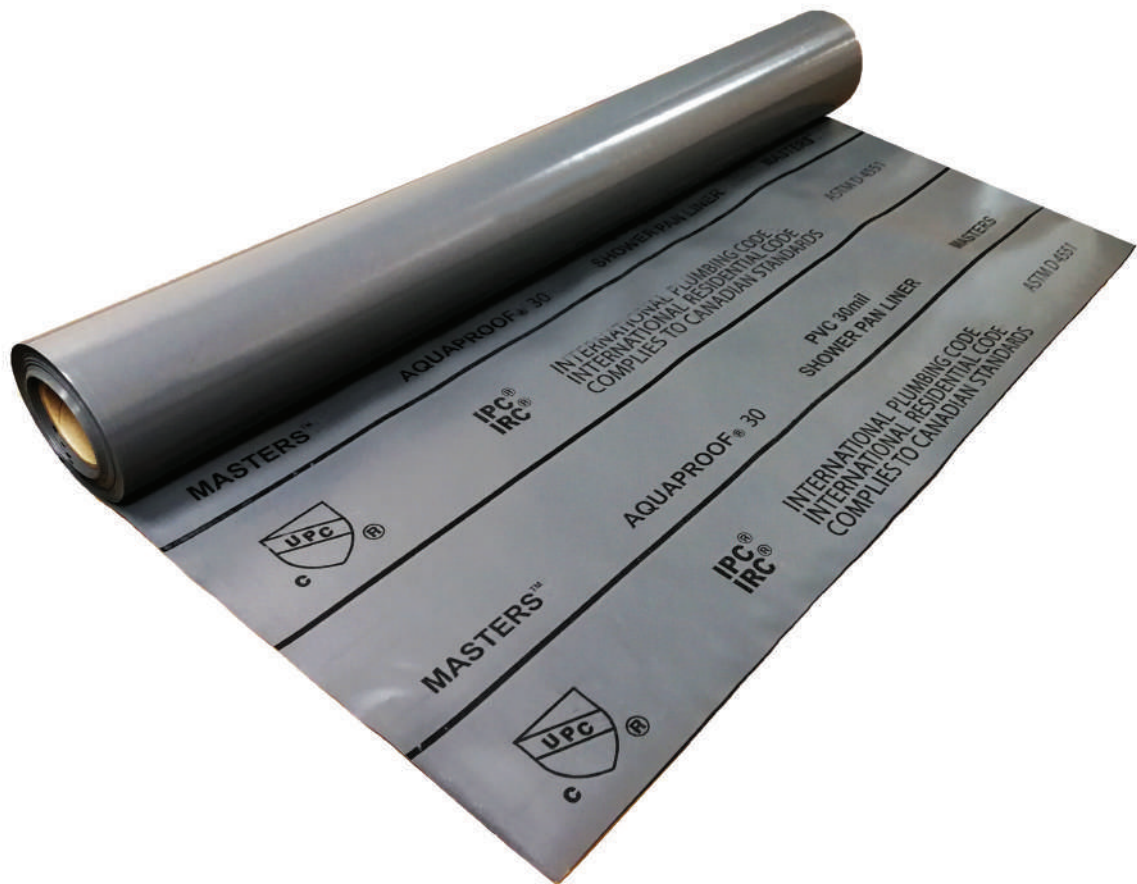

# Category 10

## Shower Systems

MASTERS® and Oatey® Shower systems and accessories are designed as an economical, flexible pan liner for use in tile shower and other concealed water-proofing applications. Shower systems are available in 30 mil or 40 mil thickness, and widths of 4' (1.2 m), 5' (1.5 m) or 6' (1.8 m). Liner is marked every 6" (15.2 cm) to allow for easy measuring of material.



## SHOWER SYSTEMS



### MASTERS® Aquaproof

- 30 mil thick grey PVC shower pan liner marked every 6" for easy cutting
- Creates permanent waterproofing under tile, concrete, etc.
- Meets ASTM D 4551, cUPC listed, IPC & IRC Compliant

Product No.	Size	Description	UPC	Roll
AQ430	30 mil 4' x 50' Roll	MASTERS Aquaproof Shower Pan Liner	067001000194	1
AQ530	30 mil 5' x 40' Roll	MASTERS Aquaproof Shower Pan Liner	067001000200	1
AQ630	30 mil 6' x 33.3' Roll	MASTERS Aquaproof Shower Pan Liner	067001001528	1



### Oatey® Shower Systems

- Economical, time-tested flexible pan liner.
- 40 mil thick gray PVC Shower System
- Liner marked in 15.2 cm (6 in) increments for ease of measuring.
- Dam corners available.
- Meets ASTM Standard D4551.
- Superior cold weather characteristics.

Product No.	Size	Description	UPC	Linear Ft.
41594	5' x 40 ft. / 12.7 x 12.2 m	40 mil Gray – Linear Foot – Roll	038753415949	40
41619	6' x 50 ft. / 15.2 x 12.2 m	40 mil Gray – Linear Foot – Roll	038753416199	50
41626	5' x 40 ft. / 12.7 x 12.2 m	40 mil Gray – Linear Foot – Roll	038753416267	40
41627	5' x 100 ft. / 12.7 x 30.5 m	40 mil Gray – Linear Foot – Roll	038753416274	100
41628	6' x 100 ft. / 15.2 x 30.5 m	40 mil Gray – Linear Foot – Roll	038753416281	100
41620	5' x 6 ft. / 12.7 x 1.8 m	40 mil Gray – Liner Kit: Includes (2) 40 mil Corner Dams	038753416205	4 Ctn.Qty.

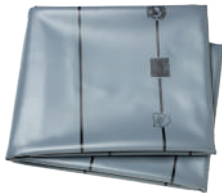

#41620 shown



### Oatey® Corner Dam

- Corner dams have universal design for right or left corners.
- Corner dams for use at junction of curb and door jamb.
- Made of 40 mil PVC.

Product No.	Size	Description	UPC	Ctn. Qty.
41602		Corner Dams – 40 mil PVC	038753416021	48



### Oatey® Perfect Slope

- Creates a code required slope under shower systems
- Install a perfect shower slope that requires half the mortar

Product No.	Size	Description	UPC	Ctn. Qty.
41644	40 x 40	Tile Shower Pre-Slope Base	038753416441	2
41646	40 x 20	Tile Shower Pre-Slope Base Extension	038753416465	2



### Oatey® LO-VOC X-15™ PVC Solvent

- X-15 PVC solvent is specially formulated for extended working times.
- Meets California and other environmental district rules.
- X-15 PVC solvent provides exceptional sheet to sheet bonding.
- Use ONLY on PVC shower systems.

Product No.	Size	Description	UPC	Ctn. Qty.
48034	16 oz./473 ml	X-15 Bond Adhesive	038753480343	6



### Dura Pro Contact Cement

- For joining PVC to sub floor

Product No.	Size	Description	UPC	Ctn. Qty.
CC-24	946 ml	DURA PRO Contact Cement Flat Top Can	058751241005	6

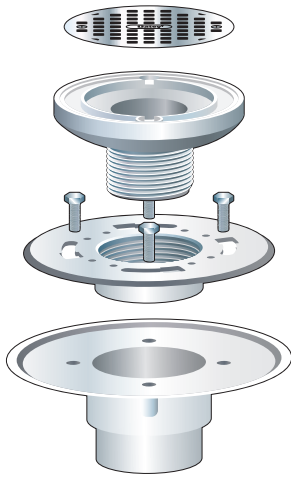

Oatey® provides several products needed for tile shower installations. Choose from the list below before you start your project:

**PVC or CPE Pan Liner** – referred to as pan liner or membrane in our instructions.

**Tile Shower Drain** – PVC for PVC drain pipe or ABS for ABS drain pipe. Each is available with stainless steel, polished brass or white plastic strainer.

**X-15 or CPE (Oateyweld) bonding adhesive** – For use on dam corners or seaming use X-15 for PVC and Oateyweld for CPE.

**PVC or ABS solvent cement** – PVC solvent cement and primer for PVC drainage systems or ABS solvent cement for ABS drainage systems. Use the appropriate cement (and primer for PVC) to solvent weld tile shower drain to the drain pipe.

**Dam Corners** – For outside corners and over the curb preformed dam corners are available, which can be used for PVC or CPE pan liner applications.

**NOTE:** Oatey pan liner instructions assume the shower framing has been constructed and the flooring is plywood. Generally the same principles apply to concrete flooring where the sloped mortar bed is applied beneath the pan liner. Also the instructions apply to either PVC pan liner or CPE pan liner which are installed the same with the exception of the bonding adhesive used for seaming and dam corner applications. If you have questions regarding pan liner installation that are not covered in these instructions, contact Oatey customer service at 800-321-9532 and you will be referred to someone who can assist you.

### Shower Pan Installation

1. For typical wood subfloor cut a 11.4 cm diameter hole in the center of the shower floor where the tile shower drain would normally be positioned. Disassemble the tile shower drain. Lay the tile shower drain base in the opening so the flange of the drain base rests on top of the subfloor. Solvent weld the drain base to the drain pipe using the appropriate solvent cement. See Figure A.
2. Cover the drain base opening with duct tape to keep debris from entering the drain. Begin by applying Portland Sand/Cement mixture mortar bed over the subfloor at 1/4" per foot slope from the wall framing to the top of, but not over, the drain base. After this step the sloped mortar bed should be flush with the top surface of the drain base.

Figure A

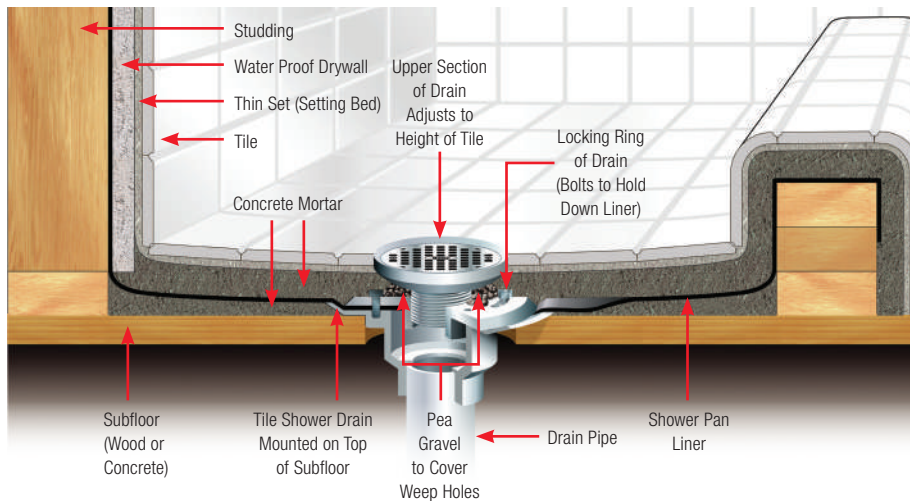

3. After the sloped mortar bed has cured, the pan liner dimensions need to be determined. Pan liner dimensions should be sufficient to completely cover the floor, turn up all sidewalls at least 5 cm above the finished curb height, and adequately cover the curb. Lay the pan liner on a clean floor surface, measure, and cut to the appropriate dimensions. **NOTE: Seaming may be required in larger showers. See Figure B. Follow instructions on bonding adhesive.**

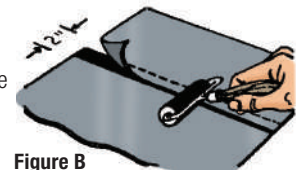
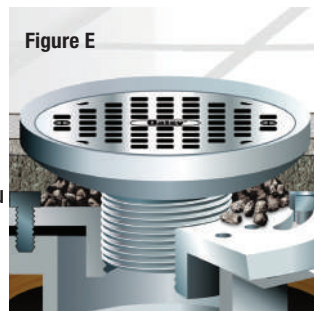
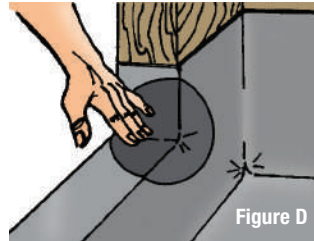
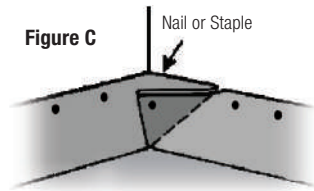

Figure B

4. Before installing the pan liner remove the tape from the drain base and apply a .63-.95 cm bead of 100% silicone caulk around the upper surface of the drain base approximately 2.54 cm in from the outside edge. This will provide a seal between the underside of the pan liner and the drain base surface. Screw the clamping ring bolts into the drain base to 2-3 thread depth. Before the caulk dries lay the premeasured pan liner on the floor and over the drain body. At the top of each bolt slit an "X" so the pan liner slides over the bolts and down to the drain base surface. Press pan liner firmly into place to ensure a seal between the drain base and the bottom surface of the pan liner.

## SHOWER PAN LINER – APPLICATION INSTRUCTIONS

5. Work the pan material from the drain body to the sidewall framing and curb threshold so it lays flat on the floor surface. If desired an adhesive can be used to bond pan liner to the floor and curb. Prior to use of adhesive, confirm compatibility of adhesive to the pan liner. Fold corners and nail or staple pan liner to the sidewall framing or wall studs 1.27 cm below the upper edge of the material to hold it in place. Nail or staple the remainder of the pan liner to the sidewall framing or wall studs 1.27 cm below the upper edge of the material. See Figure C.
6. For outside corners or curbs where it's necessary to cut the pan liner use a dam corner to cover the cut area. To bond dam corners in the cut area use **Oatey brand X-15 for PVC liner installations or Oateyweld for CPE liner installations.** See Figure D.
7. Locate where the drain hole is on the drain base and cut out the pan liner material to the dimension of the drain hole on the drain base. Place clamping ring over the bolts and slide the ring counter clockwise so it's locked in place. Tighten the bolts so they're snug. Make sure the weep holes are clear of any residual pan liner material or silicone. **NOTE: The clamping ring can increase the height of the finished shower floor by approximately 1.9 cm. You will see the extension if you turn the ring upside down. Simply tighten it to the drain base the way you normally would, only inverted.**
8. Water test the installation by closing off the drain pipe opening with a pneumatic or mechanical Cherne® test plug. Fill the shower floor with water just below the top of the curb and let it sit for four (4) hours. Observe for leaks and repair if necessary. Retest the installation. Repeat until the installation is leak free. Completely drain the water before proceeding to Step 9.
9. A reinforcement bed of mortar needs to be applied over the membrane (see step 11) but before doing so nail water impervious drywall to the wall studs to approximately 1" above the pan liner surface. **NOTE: The use of mortar vs. drywall for the curb should be considered because you can avoid the use of nails as you construct this part of your installation.**
10. The clamping ring has an inner thread pattern that will accept the drain barrel and strainer assembly. Once you determine the finished height of the shower thread the drain barrel into the inside clamping ring thread so the finished floor will be flush with the top of the drain barrel. As mentioned in step 7 you can increase the shower drain height by inverting the clamping ring.
11. Before the final mortar application place some pea gravel over the weep holes so the mortar doesn't completely cover them. Now lay the minimum 3.8 cm reinforcement mortar bed of concrete over the pan liner from the wall to the drain barrel, leaving enough room for the final thinset and tile application. See Figure E.



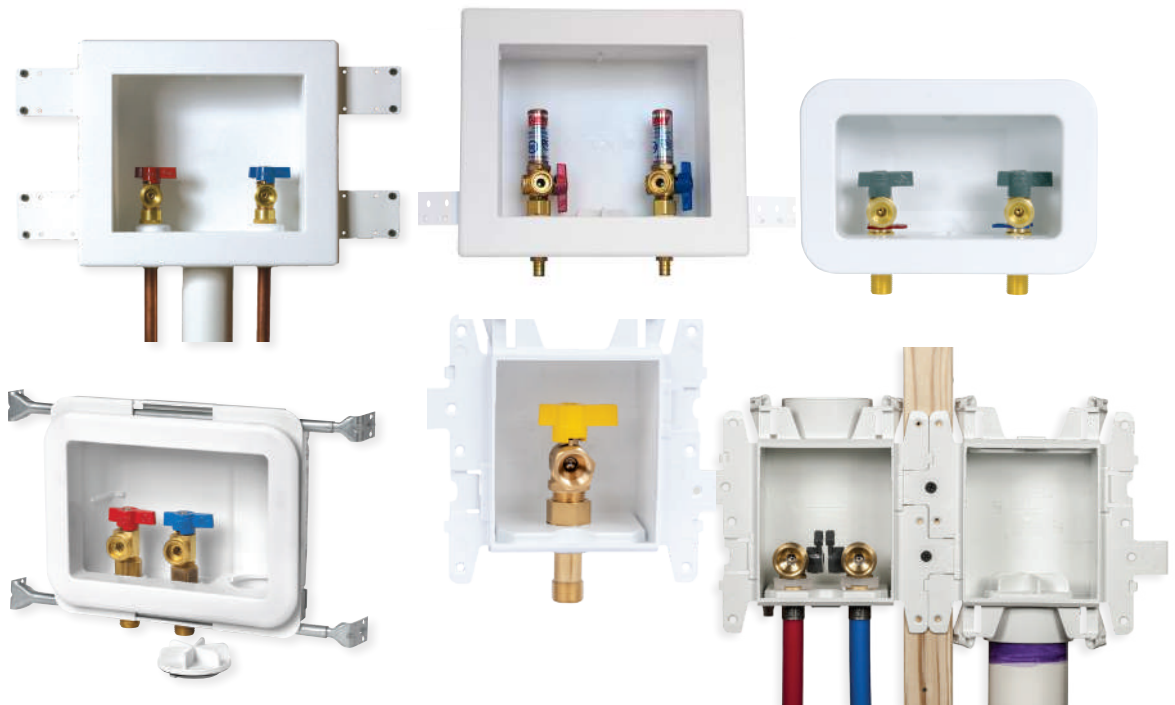

# Category 11

## Supply Boxes

Oatey® supply boxes can be used in commercial or residential applications that require supply valves and waste drains recessed into the wall. Available water hammer arrestor option provides water pressure shock arrestors required for installation on supply lines to quick closing valves. Available in fire-rated and other configurations.

**Oatey® MODA™ Washing Machine Outlet Boxes**

- One universal faceplate is compatible with all box types.
- All boxes can snap to one another, and common brackets can be used on any MODA supply box.
- Unique interlocking wing flanges accommodate on-stud, straddle-stud and three-box installations.
- Two piece valve design makes valve replacement easy to repair, without damaging drywall.

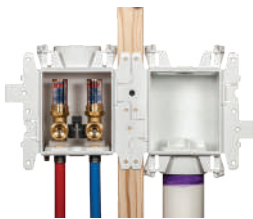

Product No.	Description	UPC	Ctn. Qty.
<b>Two Valve Box + Standard Drain Box without Hammer</b>			
37601	MODA, Copper (Male) – Standard Pack	038753376011	12
37617	MODA, Copper (Male) – Contractor Pack	038753376172	12
37350	🔥 MODA, Copper (Male) – Standard Pack	038753373508	1
37603	MODA, F1807 PEX (Brass) – Standard Pack	038753376035	12
37619	MODA, F1807 PEX (Brass) – Contractor Pack	038753376196	12
37351	🔥 MODA, F1807 PEX (Brass) – Standard Pack	038753373515	1
37605	MODA, F1960 PEX (Brass) – Standard Pack	038753376059	12
37621	MODA, F1960 PEX (Brass) – Contractor Pack	038753376219	12
37353	🔥 MODA, F1960 PEX (Brass) – Standard Pack	038753373539	1
37602	MODA, CPVC (Male) – Standard Pack	038753376028	12
37618	MODA, CPVC (Male) – Contractor Pack	038753376189	12
37355	🔥 MODA, CPVC (Male) – Standard Pack	038753373553	1
37608	MODA, Push Connect – Standard Pack	038753376080	12
37356	🔥 MODA, Push Connect – Standard Pack	038753373560	1
<b>Two Valve Box + Standard Drain Box with Hammer</b>			
37609	MODA, Copper (Male), Hammer – Standard Pack	038753376097	12
37625	MODA, Copper (Male), Hammer – Contractor Pack	038753376257	12
37357	🔥 MODA, Copper (Male), Hammer – Standard Pack	038753373577	1
37611	MODA, F1807 PEX (Brass), Hammer – Standard Pack	038753376110	12
37627	MODA, F1807 PEX (Brass), Hammer – Contractor Pack	038753376271	12
37358	🔥 MODA, F1807 PEX (Brass), Hammer – Standard Pack	038753373584	1
37613	MODA, F1960 PEX (Brass), Hammer – Standard Pack	038753376134	12
37629	MODA, F1960 PEX (Brass), Hammer – Contractor Pack	038753376295	12
37360	🔥 MODA, F1960 PEX (Brass), Hammer – Standard Pack	038753373607	1
37610	MODA, CPVC (Male), Hammer – Standard Pack	038753376103	12
37626	MODA, CPVC (Male), Hammer – Contractor Pack	038753376264	12
37362	🔥 MODA, CPVC (Male), Hammer – Standard Pack	038753373621	1
37616	MODA, Push Connect, Hammer – Standard Pack	038753376165	12
37363	🔥 MODA, Push Connect, Hammer – Standard Pack	038753373638	1
<b>Single Box (Two Valve + Drain) without Hammer</b>			
37540	MODA, Copper (Male) – Standard Pack	038753375403	12
37541	MODA, F1807 PEX (Brass) – Standard Pack	038753375410	12
37543	MODA, F1960 PEX (Brass) – Standard Pack	038753375434	12
37545	MODA, CPVC (Male) – Standard Pack	038753375458	12
37546	MODA, Push Connect – Standard Pack	038753375465	12
<b>Single Box (Two Valve + Drain) with Hammer</b>			
37550	MODA, Copper (Male), Hammer – Standard Pack	038753375502	12
37551	MODA, F1807 PEX (Brass), Hammer – Standard Pack	038753375519	12
37553	MODA, F1960 PEX (Brass), Hammer – Standard Pack	038753375533	12
37555	CPVC (Male), Hammer – Standard Pack	038753375557	12
37556	MODA, Push Connect, Hammer – Standard Pack	038753375564	12

🔥 Denotes Fire-Rated



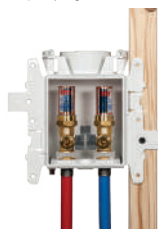

SUPPLY BOXES



Product No.	Description	UPC	Ctn. Qty.
<b>Single Box (Two Valve + Drain) without Hammer</b>			
37540	MODA, Copper (Male) – Standard Pack	038753375403	12
37541	MODA, F1807 PEX (Brass) – Standard Pack	038753375410	12
37542	MODA, F2159/F1807 PEX (PPSU) – Standard Pack	038753375427	12
37543	MODA, F1960 PEX (Brass) – Standard Pack	038753375434	12
37544	MODA, F1960 PEX (PPSU) – Standard Pack	038753375441	12
37545	MODA, CPVC (Male) – Standard Pack	038753375458	12
37546	MODA, Push Connect – Standard Pack	038753375465	12
<b>Single Box (Two Valve + Drain) with Hammer</b>			
37550	MODA, Copper (Male), Hammer – Standard Pack	038753375502	12
37551	MODA, F1807 PEX (Brass), Hammer – Standard Pack	038753375519	12
37552	MODA, F2159/F1807 PEX (PPSU), Hammer – Standard Pack	038753375526	12
37553	MODA, F1960 PEX (Brass), Hammer – Standard Pack	038753375533	12
37554	MODA, F1960 PEX (PPSU), Hammer – Standard Pack	038753375540	12
37555	CPVC (Male), Hammer – Standard Pack	038753375557	12
37556	MODA, Push Connect, Hammer – Standard Pack	038753375564	12

**Oatey® MODA™ Ice Maker Supply Boxes**

- One universal faceplate is compatible with all box types.
- All boxes can snap to one another, and common brackets can be used on any MODA supply box.
- Unique interlocking wing flanges accommodate on-stud, straddle-stud and three-box installations.
- Two piece valve design makes valve replacement easy to repair, without damaging drywall.

Product No.	Description	UPC	Ctn. Qty.
<b>One Valve Box without Hammer</b>			
37679	MODA, Copper (Male) – Standard Pack	038753376790	12
37695	MODA, Copper (Male) – Contractor Pack	038753376950	12
37378	 MODA, Copper (Male) – Standard Pack	038753373782	1
37681	MODA, F1807 PEX (Brass) – Standard Pack	038753376813	12
37697	MODA, F1807 PEX (Brass) – Contractor Pack	038753376974	12
37379	 MODA, F1807 PEX (Brass) – Standard Pack	038753373799	1
37683	MODA, F1960 PEX (Brass) – Standard Pack	038753376837	12
37699	MODA, F1960 PEX (Brass) – Contractor Pack	038753376998	12
37381	 MODA, F1960 PEX (Brass) – Standard Pack	038753373812	1
37680	MODA, CPVC (Male) – Standard Pack	038753376806	12
37696	MODA, CPVC (Male) – Contractor Pack	038753376967	12
37383	 MODA, CPVC (Male) – Standard Pack	038753373836	1
37686	MODA, Push Connect – Standard Pack	038753376868	12
37384	 MODA, Push Connect – Standard Pack	038753373843	1

 Denotes Fire-Rated



**Oatey® MODA™ Ice Maker Supply Boxes (continued)**

Product No.	Description	UPC	Ctn. Qty.
<b>One Valve Box with Hammer</b>			
37687	MODA, Copper (Male), Hammer – Standard Pack	038753376875	12
37703	MODA, Copper (Male), Hammer – Contractor Pack	038753377032	12
37385	MODA, Copper (Male), Hammer – Standard Pack	038753373850	1
37689	MODA, F1807 PEX (Brass), Hammer – Standard Pack	038753376899	12
37705	MODA, F1807 PEX (Brass), Hammer – Contractor Pack	038753377056	12
37386	MODA, F1807 PEX (Brass), Hammer – Standard Pack	038753373867	1
37691	MODA, F1960 PEX (Brass), Hammer – Standard Pack	038753376912	12
37707	MODA, F1960 PEX (Brass), Hammer – Contractor Pack	038753377070	12
37388	MODA, F1960 PEX (Brass), Hammer – Standard Pack	038753373881	1
37688	MODA, CPVC (Male), Hammer – Standard Pack	038753376882	12
37704	MODA, CPVC (Male), Hammer – Contractor Pack	038753377049	12
37390	MODA, CPVC (Male), Hammer – Standard Pack	038753373904	1
37694	MODA, Push Connect, Hammer – Standard Pack	038753376943	12
37391	MODA, Push Connect, Hammer – Standard Pack	038753373911	1

**Oatey® MODA™ Toilet or Dishwasher Supply Boxes**

- One universal faceplate is compatible with all box types.
- All boxes can snap to one another, and common brackets can be used on any MODA supply box.
- Unique interlocking wing flanges accommodate on-stud, straddle-stud and three-box installations.
- Two piece valve design makes valve replacement easy to repair, without damaging drywall.



Product No.	Description	UPC	Ctn. Qty.
<b>One Valve Box without Hammer</b>			
37897	MODA, Copper (Male) – Standard Pack	038753378978	12
37420	MODA, Copper (Male) – Standard Pack	038753374208	1
37899	MODA, F1807 PEX (Brass) – Standard Pack	038753378992	12
37421	MODA, F1807 PEX (Brass) – Standard Pack	038753374215	1
37901	MODA, F1960 PEX (Brass) – Standard Pack	038753379012	12
37423	MODA, F1960 PEX (Brass) – Standard Pack	038753374239	1
37898	MODA, CPVC (Male) – Standard Pack	038753378985	12
37425	MODA, CPVC (Male) – Standard Pack	038753374253	1
37904	MODA, Push Connect – Standard Pack	038753379043	12
37426	MODA, Push Connect – Standard Pack	038753374260	1



<b>One Valve Box with Hammer</b>			
37905	MODA, Copper (Male), Hammer – Standard Pack	038753379050	12
37427	MODA, Copper (Male), Hammer – Standard Pack	038753374277	1
37907	MODA, F1807 PEX (Brass), Hammer – Standard Pack	038753379074	12
37428	MODA, F1807 PEX (Brass), Hammer – Standard Pack	038753374284	1
37909	MODA, F1960 PEX (Brass), Hammer – Standard Pack	038753379098	12
37430	MODA, F1960 PEX (Brass), Hammer – Standard Pack	038753374307	1
37906	MODA, CPVC (Male), Hammer – Standard Pack	038753379067	12
37432	MODA, CPVC (Male), Hammer – Standard Pack	038753374321	1
37912	MODA, Push Connect, Hammer – Standard Pack	038753379128	12
37433	MODA, Push Connect, Hammer – Standard Pack	038753374338	1

Denotes Fire-Rated

**Oatey® MODA™ Lavatory Supply Boxes**

- One universal faceplate is compatible with all box types.
- All boxes can snap to one another, and common brackets can be used on any MODA supply box.
- Unique interlocking wing flanges accommodate on-stud, straddle-stud and three-box installations.
- Two piece valve design makes valve replacement easy to repair, without damaging drywall.



Product No.	Description	UPC	Ctn. Qty.
<b>Two Valve Box without Hammer</b>			
37741	MODA, Copper (Male) – Standard Pack	038753377414	12
37757	MODA, Copper (Male) – Contractor Pack	038753377575	12
37392	🔥 MODA, Copper (Male) – Standard Pack	038753373928	1
37743	MODA, F1807 PEX (Brass) – Standard Pack	038753377438	12
37759	MODA, F1807 PEX (Brass) – Contractor Pack	038753377599	12
37393	🔥 MODA, F1807 PEX (Brass) – Standard Pack	038753373935	1
37745	MODA, F1960 PEX (Brass) – Standard Pack	038753377452	12
37761	MODA, F1960 PEX (Brass) – Contractor Pack	038753377612	12
37395	🔥 MODA, F1960 PEX (Brass) – Standard Pack	038753373959	1
37742	MODA, CPVC (Male) – Standard Pack	038753377421	12
37758	MODA, CPVC (Male) – Contractor Pack	038753377582	12
37397	🔥 MODA, CPVC (Male) – Standard Pack	038753373973	1
37748	MODA, Push Connect – Standard Pack	038753377483	12
37398	🔥 MODA, Push Connect – Standard Pack	038753373980	1
<b>Two Valve Box with Hammer</b>			
37749	MODA, Copper (Male), Hammer – Standard Pack	038753377490	12
37765	MODA, Copper (Male), Hammer – Contractor Pack	038753377650	12
37399	🔥 MODA, Copper (Male), Hammer – Standard Pack	038753373997	1
37751	MODA, F1807 PEX (Brass), Hammer – Standard Pack	038753377513	12
37767	MODA, F1807 PEX (Brass), Hammer – Contractor Pack	038753377674	12
37400	🔥 MODA, F1807 PEX (Brass), Hammer – Standard Pack	038753374000	1
37753	MODA, F1960 PEX (Brass), Hammer – Standard Pack	038753377537	12
37769	MODA, F1960 PEX (Brass), Hammer – Contractor Pack	038753377698	12
37402	🔥 MODA, F1960 PEX (Brass), Hammer – Standard Pack	038753374024	1
37750	MODA, CPVC (Male), Hammer – Standard Pack	038753377506	12
37766	MODA, CPVC (Male), Hammer – Contractor Pack	038753377667	12
37404	🔥 MODA, CPVC (Male), Hammer – Standard Pack	038753374048	1
37756	MODA, Push Connect, Hammer – Standard Pack	038753377568	12
37405	🔥 MODA, Push Connect, Hammer – Standard Pack	038753374055	1

🔥 Denotes Fire-Rated



**Oatey® MODA™ Kitchen Supply Boxes**

- One universal faceplate is compatible with all box types.
- All boxes can snap to one another, and common brackets can be used on any MODA supply box.
- Unique interlocking wing flanges accommodate on-stud, straddle-stud and three-box installations.
- Two piece valve design makes valve replacement easy to repair, without damaging drywall.

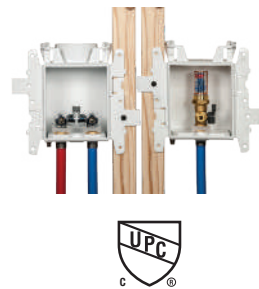
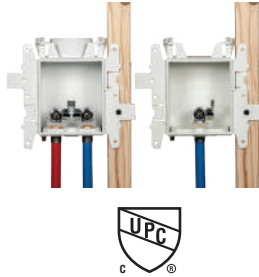

Product No.	Description	UPC	Ctn. Qty.
<b>Two Valve Box + One Valve Box (Lavatory – w/o Hammer, Dishwasher – w/o Hammer)</b>			
37819	MODA, Copper (Male) – Standard Pack	038753378190	12
37406	MODA, Copper (Male) – Standard Pack	038753374062	1
37821	MODA, F1807 PEX (Brass) – Standard Pack	038753378213	12
37407	MODA, F1807 PEX (Brass) – Standard Pack	038753374079	1
37823	MODA, F1960 PEX (Brass) – Standard Pack	038753378237	12
37409	MODA, F1960 PEX (Brass) – Standard Pack	038753374093	1
37820	MODA, CPVC (Male) – Standard Pack	038753378206	12
37411	MODA, CPVC (Male) – Standard Pack	038753374116	1
37826	MODA, Push Connect – Standard Pack	038753378268	12
37412	MODA, Push Connect – Standard Pack	038753374123	1
<b>Two Valve Box + One Valve Box (Lavatory – w/o Hammer, Dishwasher – w Hammer)</b>			
37827	MODA, Copper (Male), Hammer – Standard Pack	038753378275	12
37413	MODA, Copper (Male), Hammer – Standard Pack	038753374130	1
37829	MODA, F1807 PEX (Brass), Hammer – Standard Pack	038753378299	12
37414	MODA, F1807 PEX (Brass), Hammer – Standard Pack	038753374147	1
37831	MODA, F1960 PEX (Brass), Hammer – Standard Pack	038753378312	12
37416	MODA, F1960 PEX (Brass), Hammer – Standard Pack	038753374161	1
37828	MODA, CPVC (Male), Hammer – Standard Pack	038753378282	12
37418	MODA, CPVC (Male), Hammer – Standard Pack	038753374185	1
37834	MODA, Push Connect, Hammer – Standard Pack	038753378343	12
37419	MODA, Push Connect, Hammer – Standard Pack	038753374192	1

**Oatey® MODA™ Plain Boxes**

- All plain boxes come with faceplate
- Valve ports are easily knocked-out

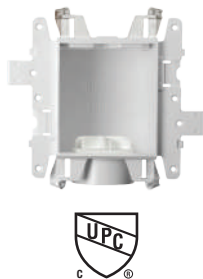

Product No.	Description	UPC	Ctn. Qty.
37971	MODA, 1 Valve Port Plain Box – Standard Pack	038753379715	12
37972	MODA, 2 Valve Port Plain Box – Standard Pack	038753379722	12
37970	MODA, Standard Drain (supplied with Test Cap) – Standard Pack	038753379708	12
37973	MODA, Drain + Aux Port – Standard Pack	038753379739	12
37974	MODA, Drain + 2 Aux Port – Standard Pack	038753379746	12

 Denotes fire-rated



**Oatey® MODA™ Secondary Drain Kits**

- Includes Aux Drain Box and Funnel, 1 inlet correction plus drain and test plug
- Designed to be paired with single MODA washing machine box
- Inlet and funnel design creates air gap
- Rated for high flow applications - i.e. water softener (10 GPM)

Product No.	Description	UPC	Ctn. Qty.
<b>Aux Drain Box + Funnel + 1 Inlet Connection + Drain Test Plug</b>			
37557	MODA, Copper (Male) 1/2" Kit – Standard Pack	038753375571	12
37985	MODA, F1807 PEX (Brass) 1/2" Kit – Standard Pack	038753379852	12
37986	MODA, F1960 PEX (Brass) 1/2" Kit – Standard Pack	038753379869	12
37558	MODA, CPVC (Male) 1/2" Kit – Standard Pack	038753375588	12
37559	MODA, Copper (Male) 3/4" Kit – Standard Pack	038753375595	12
37987	MODA, F1807 PEX (Brass) 3/4" Kit – Standard Pack	038753379876	12
37988	MODA, F1960 PEX (Brass) 3/4" Kit – Standard Pack	038753379883	12

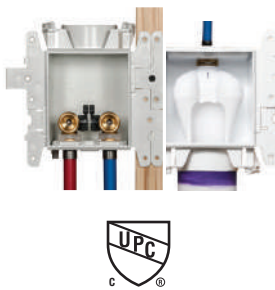

**Oatey® MODA™ Secondary Drain Boxes**

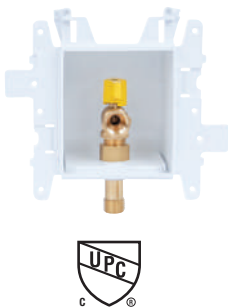

- Includes WMOB, Aux Drain Box and funnel, plus 1 inlet connection and drain test plug
- Ideal for ventless/condensing dryer
- Inlet and funnel design creates air gap
- Rated for high flow applications - i.e. water softener (10 GPM)

Product No.	Description	UPC	Ctn. Qty.
37796	MODA, WMOB1, BR F1960, HAM and DRN BOX, 1/2 IN, BR, F1960 - Contractor Pack	038753377964	12
37797	MODA, WMOB1, BR F1960, NO HAM and DRN BOX, 1/2 IN, BR, F1960 - Contractor Pack	038753377971	12
37798	MODA, WMOB1, BR F1807, HAM and DRN BOX, 1/2 IN, BR, F1807 - Contractor Pack	038753377988	12
37799	MODA, WMOB1, BR F1807, NO HAM and DRN BOX, 1/2 IN, BR, F1807 - Contractor Pack	038753377995	12



**Oatey® MODA™ Gas Supply Boxes**

- Residential or commercial applications
- Mounting direct-to-stud or between studs with supply line from top or bottom
- Valves available with yellow handle, with or without brass shank, and plastic brackets for between stud configuration
- 1/2" or 3/4" outlet with 1/4 turn valve.
- Valves certified to ANSI Z.21.15/CSA 9.1-2009

Product No.	Description	UPC	Ctn. Qty.
<b>Gas Supply Box</b>			1
37560	NPT Valve + Test Plug 1/2" – Single	038753375601	1
37446	 NPT Valve + Test Plug 1/2" – Single	038753374468	1
37561	NPT Valve + Test Plug 3/4" – Single	038753375618	1
37447	 NPT Valve + Test Plug 3/4" – Single	038753374475	1
37562	NPT Valve + Adapter + Test Plug + Locknut Only 1/2" – Single	038753375625	1
37563	NPT Valve + Adapter + Test Plug + Locknut Only 3/4" – Single	038753375637	1
37564	Plain Box, No Valves – Single	038753375649	1

 Denotes Fire-Rated



### Oatey® MODA™ Accessories

- One universal faceplate is compatible with all box types.
- All boxes can snap to one another, and common brackets can be used on any MODA supply box.
- Unique interlocking wing flanges accommodate on-stud, straddle-stud and three-box installations.
- Two piece valve design makes valve replacement easy to repair, without damaging drywall.

Product No.	Description	UPC	Ctn. Qty.
37531	MODA Faceplate	038753375311	12
37532	MODA Faceplate Insert - Solid	038753375328	12
37533	MODA Faceplate Insert - Semi-Cover	038753375335	12
37534	MODA Faceplate Insert - Louvered	038753375342	12
37535	MODA Plastic Bracket	038753375359	12
38576	DWV Quarter Turn Test Plug	038753385761	12
37536	MODA Secondary Drainage Funnel	038753375336	12
37537	MODA Sure-Vent Adapter	038753375373	12
37538	MODA Valve Clip Cover	038753375380	12
37539	MODA Center Support	038753375397	12
37529	MODA Debris Cover Sticker	038753375298	12

### Oatey® MODA™ Valves

- One universal faceplate is compatible with all box types.
- All boxes can snap to one another, and common brackets can be used on any MODA supply box.
- Unique interlocking wing flanges accommodate on-stud, straddle-stud and three-box installations.
- Two piece valve design makes valve replacement easy to repair, without damaging drywall.



Product No.	Description	UPC	Ctn. Qty.
37500	MODA, Valve Top + Clip, WMOB, No Hammer, Gray Handle, Cold	038753375007	1
37501	MODA, Valve Top + Clip, WMOB, No Hammer, Gray Handle, Hot	038753375014	1
37502	MODA, Valve Top + Clip, WMOB, Hammer, Gray Handle, Cold	038753375021	1
37503	MODA, Valve Top + Clip, WMOB, Hammer, Gray Handle, Hot	038753375038	1
37504	MODA, Valve Top + Clip, Utility, No Hammer, Gray Handle, Cold	038753375045	1
37505	MODA, Valve Top + Clip, Utility, No Hammer, Gray Handle, Hot	038753375052	1
37506	MODA, Valve Top + Clip, Utility, Hammer, Gray Handle, Cold	038753375069	1
37507	MODA, Valve Top + Clip, Utility, Hammer, Gray Handle, Hot	038753375076	1
37508	MODA, Valve Top + Clip, IMOB, No Hammer	038753375083	1
37509	MODA, Valve Top + Clip, IMOB, Hammer	038753375090	1
37510	1/2" Copper Tailpiece Adapter Male	038753375106	1
37511	1/2" Brass F1807 Tailpiece Adapter	038753375113	1
37512	1/2" Brass F1960 Tailpiece Adapter	038753375120	1
37515	1/2" CPVC Tailpiece Adapter Male	038753375151	1
37516	3/4" Copper Tailpiece Adapter Male	038753375168	1
37517	3/4" Brass F1807 Tailpiece Adapter	038753375175	1
37518	3/4" Brass F1960 Tailpiece Adapter	038753375182	1



**Oatey® Quadro® Washing Machine Outlet Boxes**

- 2" drain opening fits PVC or ABS Sch. 40 DWV pipe.
- Easy to remove knockout, Patent Pending Hammer Valves.
- Snap-on Faceplate Frame accommodates up to 1" drywall.
- Box made of high impact polystyrene.
- Top or Bottom Valve Mount.
- 4 support brackets included for mounting.
- Dimensions: Box: 8-3/4" W x 7-1/2" H x 3-5/8" D  
Faceplate: 11-3/4" W x 10-1/8" H

Product No.	Description	UPC	Ctn. Qty.
<b>No Hammer</b>			
38530	Quadro, 1/4 Turn, Copper – Standard Pack	038753385303	12
48201	Quadro, 1/4 Turn, Copper – Display Box	038753482019	4
38535	Quadro, Single Lever, Copper – Standard Pack	038753385358	12
38552	Quadro, Brass Boiler Drain, Copper – Standard Pack	038753385525	12
38531	Quadro, 1/4 Turn, CPVC – Standard Pack	038753385310	12
38532	Quadro, 1/4 Turn, F1807 – Standard Pack	038753385327	12
38562	Quadro, 1/4 Turn, F1807 – Contractor Pack	038753385624	12
48200	Quadro, 1/4 Turn, F1807 – Display Box	038753482002	4
38537	Quadro, Single Lever, F1807 – Standard Pack	038753385372	12
38533	Quadro, 1/4 Turn, F1960 – Standard Pack	038753385334	12
38563	Quadro, 1/4 Turn, F1960 – Contractor Pack	038753385631	12
38538	Quadro, Single Lever, F1960 – Standard Pack	038753385389	12
48207	Quadro, 1/4 Turn, Push Connect, Unassembled	038753482071	4
38330	Quadro, 1/4 Turn, Viega PEX Press, Unassembled, Standard Pack	038753383309	12
38350	Quadro, Single Lever, Viega PEX Press, Unassembled, Standard Pack	038753383507	12
<b>Hammer</b>			
38540	Quadro, 1/4 Turn, Copper, Hammer – Standard Pack	038753385402	12
48203	Quadro, 1/4 Turn, Copper, Hammer – Display Pack	038753482033	2
38545	Quadro, Single Lever, Copper, Hammer – Standard Pack	038753385457	12
38541	Quadro, 1/4 Turn, CPVC, Hammer – Standard Pack	038753385419	12
38542	Quadro, 1/4 Turn, F1807, Hammer – Standard Pack	038753385426	12
38547	Quadro, Single Lever, F1807, Hammer – Standard Pack	038753385471	12
48202	Quadro, 1/4 turn, F1807, Hammer - Display Pack	038753482026	4
38543	Quadro, 1/4 Turn, F1960, Hammer – Standard Pack	038753385433	12
38548	Quadro, Single Lever, F1960, Hammer – Standard Pack	038753385488	12
38551	Quadro, 1/4 Turn, Compression – Standard Pack	038753385518	12
48208	Quadro, 1/4 Turn, Push Connect, Hammer, Unassembled	038753482088	4
38331	Quadro, 1/4 Turn, Viega PEX Press, Hammer, Unassembled, Standard Pack	038753383316	12
38351	Quadro, Single Lever, Viega PEX Press, Hammer, Unassembled, Standard Pack	038753383514	12

STANDARD PACK: Faceplates are pre-assembled on box.

CONTRACTOR PACK: Faceplates are NOT pre-assembled on box (but comes separately packed with the box).

## SUPPLY BOXES



# 39343 & #39356 shown



#39347 & #39360 shown



#38460 shown

Product No.	Description	UPC	Ctn. Qty.
-------------	-------------	-----	-----------

### Quadro Replacement Valves - No Hammer

39340	Quadro Valve- 1/4 Turn- Copper- No Hammer Left/Blue	038753393407	1
39353	Quadro Valve- 1/4 Turn- Copper- No Hammer Right/Red	038753393537	1
39130	Quadro Valve- 1/4 Turn- CPVC- No Hammer Left/Blue	038753393414	1
39354	Quadro Valve- 1/4 Turn- CPVC- No Hammer Right/Red	038753393544	1
39342	Quadro Valve- 1/4 Turn- F1807- No Hammer Left/Blue	038753393421	1
39355	Quadro Valve- 1/4 Turn- F1807- No Hammer Right/Red	038753393551	1
39343	Quadro Valve- 1/4 Turn- F1960 No Hammer Left/Blue	038753393438	1
39356	Quadro Valve- 1/4 Turn- F1960 No Hammer Right/Red	038753393568	1

### Quadro Replacement Valves - Hammer

39344	Quadro Valve- 1/4 Turn- Copper- Hammer Left/Blue	038753393445	1
39357	Quadro Valve- 1/4 Turn- Copper- Hammer Right/Red	038753393575	1
39345	Quadro Valve- 1/4 Turn- Cpvc- Hammer Left/Blue	038753393452	1
39358	Quadro Valve- 1/4 Turn- Cpvc- Hammer Right/Red	038753393582	1
39346	Quadro Valve- 1/4 Turn- F1807- Hammer Left/Blue	038753393469	1
39359	Quadro Valve- 1/4 Turn- F1807- Hammer Right/Red	038753393599	1
39347	Quadro Valve- 1/4 Turn- F1960- Hammer Left/Blue	038753393476	1
39360	Quadro Valve- 1/4 Turn- F1960- Hammer Right/Red	038753393605	1

### Quadro Accessories

38550	Quadro, Plain Box, No Valves - Standard Pack	038753385501	12
38576	Quadro Testcap	038753385761	12
38577	Quadro Hub/O-Ring	038753385778	24
38941	Quadro, Plastic Faceplate	038753389417	12
38829	Plastic Locknut 1/2"	038753388298	12

## SUPPLY BOXES - CENTRO II



#38100 shown



### Oatey® Centro II Washing Machine Outlet Boxes

- Takes up less space and will fit almost anywhere.
- Made of high impact polystyrene.
- Knockout drain cap.
- 3 knockouts on box top.
- Two piece valves come installed.
- Two support brackets.
- Available in a wide-variety of tailpiece configurations and packaging options.
- Dimensions: Box: 8" W x 4-3/4" x 3" D  
Faceplate: 10" W x 6-3/4" H

Product No.	Description	UPC	Ctn. Qty.
-------------	-------------	-----	-----------

#### No Hammer

38100	Centro II, 1/4 Turn, Copper – Assembled – Standard Pack	038753381008	12
38104	Centro II, 1/4 Turn, ASTM F1807 – Assembled – Standard Pack	038753381046	12
38151	Centro II, 1/4 Turn, ASTM F1807 – Assembled – Contractor Pack	038753381510	12
38106	Centro II, 1/4 Turn, ASTM F1960 – Assembled – Standard Pack	038753381060	12
38152	Centro II, 1/4 Turn, ASTM F1960 – Assembled – Contractor Pack	038753381527	12

#### Hammer

38101	Centro II, 1/4 Turn, Copper – Assembled – Standard Pack	038753381015	12
38105	Centro II, 1/4 Turn, F1807 – Assembled – Standard Pack	038753381053	12
38155	Centro II, 1/4 Turn, F1807 – Assembled – Contractor Pack	038753381558	12
38107	Centro II, 1/4 Turn, F1960 – Assembled – Standard Pack	038753381077	12
38156	Centro II, 1/4 Turn, F1960 – Assembled – Contractor Pack	038753381565	12

## SUPPLY BOXES



#39337 shown

### Centro II Replacement Vales - No Hammer - Top Handle

Product No.	Description	UPC	Ctn. Qty.
39322	WMOB Valve- 1/4 Turn- Copper- No Hammer- Gray Top Handle	038753393223	1
39327	WMOB Valve- 1/4 Turn- Cpvc- No Hammer- Gray Top Handle	038753393278	1
39332	WMOB Valve- 1/4 Turn- F1807- No Hammer- Gray Top Handle	038753393322	1
39337	WMOB Valve- 1/4 Turn- F1960- No Hammer- Gray Top Handle	038753393377	1



#39325 & #39326 shown

### Centro II Replacement Vales - No Hammer - Side Handle

39320	WMOB Valve- 1/4 Turn- Copper- No Hammer- Side HdL- Left	038753393209	1
39321	WMOB Valve- 1/4 Turn- Copper- No Hammer- Side HdL- Right	038753393216	1
39325	WMOB Valve- 1/4 Turn- Cpvc- No Hammer- Side HdL- Left	038753393254	1
39326	WMOB Valve- 1/4 Turn- Cpvc- No Hammer- Side HdL- Right	038753393261	1
39330	WMOB Valve- 1/4 Turn- F1807- No Hammer- Side HdL- Left	038753393308	1
39331	WMOB Valve- 1/4 Turn- F1807- No Hammer- Side HdL- Right	038753393315	1
39335	WMOB Valve- 1/4 Turn- F1960- No Hammer- Side HdL- Left	038753393353	1
39336	WMOB Valve- 1/4 Turn- F1960- No Hammer- Side HdL- Right	038753393360	1



#39323 & #39324 shown

### Centro II Replacement Vales - Hammer - Side Handle

39323	WMOB Valve- 1/4 Turn- Copper- Hammer- Side HdL- Left	038753393230	1
39324	WMOB Valve- 1/4 Turn- Copper- No Hammer- Side HdL- Right	038753393216	1
39328	WMOB Valve - 1/4 Turn-Cpvc-Hammer-Side HdL-Left	038753393285	1
39329	WMOB Valve- 1/4 Turn- Cpvc- Hammer- Side HdL- Right	038753393292	1
39333	WMOB Valve- 1/4 Turn- F1807- Hammer- Side HdL- Left	038753393339	1
39334	WMOB Valve- 1/4 Turn- F1807- Hammer- Side HdL- Right	038753393346	1
39338	WMOB Valve- 1/4 Turn- F1960- Hammer- Side HdL- Left	038753393384	1
39339	WMOB Valve- 1/4 Turn- F1960- Hammer- Side HdL- Right	038753393391	1



#39349 shown

### Centro II Replacement Vales - Top Only

39349	WMOB Valve- Top Only- 1/4 Turn- No Hammer- Top HdL	038753393490	1
39348	WMOB Valve- Top Only- 1/4 Turn- Hammer- Side HdL	038753393483	1



#38829 shown

### Centro II Accessories

38381	Centro II, Plastic Faceplate	038753383811	12
38383	Brackets 12" Long Plastic	038753383835	12
38829	Locknut 1/2" Plastic	038753388298	1



### Oatey® Fire-Rated Washing Machine Outlet Boxes

- Warnock Hersey certified, for 1-hour and 2-hour fire-rated walls.
- 2" drain opening fits PVC or ABS Sch. 40 DWV pipe.
- Box made of Bulk Molding Compound (BMC) with UL-classified intumescent pads and UL-classified insulating material.
- Adjustable metal mounting brackets, easy to remove test cap.
- Flexible valve/drain arrangement capabilities.
- Dimensions: Box: 8-1/3" W x 5-1/2" H x 3-3/4" D  
Faceplate: 10-1/5" W x 7-2/5" H

Product No.	Description	UPC	Ctn. Qty.
<b>No Hammer</b>			
38470	🔥 Fire Rated, 1/4 Turn, Copper – Standard Pack	038753384702	1
38474	🔥 Fire Rated, Single Lever, Copper – Standard Pack	038753384740	1
38471	🔥 Fire Rated, 1/4 Turn, CPVC – Standard Pack	038753384719	1
38472	🔥 Fire Rated, 1/4 Turn, F1807 – Standard Pack	038753384726	1
38473	🔥 Fire Rated, 1/4 Turn, F1960 – Standard Pack	38753384733	1
<b>Hammer</b>			
38478	🔥 Fire Rated, 1/4 Turn, Copper, Hammer – Standard Pack	038753384788	1
38482	🔥 Fire Rated, Single Lever, Copper, Hammer – Standard Pack	038753384825	1
38479	🔥 Fire Rated, 1/4 Turn, CPVC, Hammer – Standard Pack	038753384795	1
38480	🔥 Fire Rated, 1/4 Turn, F1807, Hammer – Standard Pack	038753384801	1
38484	🔥 Fire Rated, Single Lever, F1807, Hammer – Standard Pack	038753384849	1
38481	🔥 Fire Rated, 1/4 Turn, F1960, Hammer – Standard Pack	038753384818	1
38485	🔥 Fire Rated, Single Lever, F1960, Hammer – Standard Pack	038753384818	1
<b>Accessories</b>			
38494	🔥 Fire Rated, Plain Box, No Valves, Faceplate, or Bracket	038753384948	6
38496	🔥 Fire Rated, Faceplate	038753384962	6
38576	Quadro Testcap	038753385761	12



### Oatey® Metal Washing Machine Outlet Boxes

- Allows left or right hand drain. 2 metal support brackets.
- 2" drain opening – rubber coupling, solvent weld or threaded.
- Box made of 20 gauge steel.
- Dimensions: Box: 9" W x 6-1/8" H x 3-1/16" D  
Faceplate: 10-7/8" W x 7-3/4" H

Product No.	Description	UPC	Ctn. Qty.
<b>No Hammer</b>			
38979	Metal, 1/4 Turn, CPVC, 2" Rubber Tailpiece – Standard Pack	038753389790	1
38981	Metal, 1/4 Turn, Copper, 2" PVC Tailpiece – Standard Pack	38753389813	1
38983	Metal, 1/4 Turn, Copper, 2" ABS Tailpiece – Standard Pack	038753389837	1
38984	Metal, Single Lever, Copper, 2" ABS Tailpiece – Standard Pack	038753389844	1
38985	Metal, 1/4 Turn, Copper, 2" Rubber Tailpiece – Standard Pack	038753389851	1
38986	Metal, Single Lever, Copper, 2" Rubber Tailpiece – Standard Pack	038753389868	1
38993	Metal, 1/4 Turn, Copper, 2" NPT Tailpiece – Standard Pack	038753389936	1
<b>Hammer</b>			
38995	Metal, 1/4 Turn, Copper, Hammer, 2" Rubber Tailpiece – Standard Pack	038753389950	1
38996	Metal, 1/4 Turn, CPVC, Hammer, 2" Rubber Tailpiece – Standard Pack	038753389967	1
<b>Accessories</b>			
38975	Metal, Faceplate	038753389752	1
38980	Metal, Plain Box, No Valves, or Tailpiece – Standard Pack	038753389806	1
38987	Metal, 2" PVC Tailpiece	038753389875	1

🔥 Denotes fire-rated



#38401 shown

### Oatey® Fire-Rated and Metal WMOB Replacement Valves

Product No.	Description	UPC	Ctn. Qty.
<b>Fire-Rated and Metal WMOB Replacement Valves - No Hammer</b>			
38871	Valve 1/4 Turn Copper 3/4" No Hammer Blue	038753388717	1
38870	Valve 1/4 Turn Copper 3/4" No Hammer Red	038753388700	1
38969	Valve 1/4 Turn Cpvc 3/4" No Hammer Blue	038753389691	1
38880	Valve 1/4 Turn F1960 3/4" No Hammer Blue	038753388809	1
38881	Valve 1/4 Turn F1960 3/4" No Hammer Red	038753388816	1
38978	Valve 1/4 Turn F1807 3/4" No Hammer Blue	038753389783	1
38977	Valve 1/4 Turn F1807 3/4" No Hammer Red	038753389776	1
<b>Fire-Rated and Metal WMOB Replacement Vales - Hammer</b>			
38401	Valve 1/4 Turn Copper Hammer Blue	038753384016	1
38400	Valve 1/4 Turn Copper Hammer Red	038753384009	1
38403	Valve 1/4 Turn Cpvc Hammer Blue	038753384030	1
38402	Valve 1/4 Turn Cpvc Hammer Red	038753384023	1
38409	Valve 1/4 Turn F1807 Hammer Blue	038753384092	1
38408	Valve 1/4 Turn F1807 Hammer Red	038753384085	1



#39176 shown



### Oatey® Fire-Rated Ice Maker Outlet Boxes

- Warnock Hersey certified, for 1-hour and 2-hour fire-rated walls.
- Box made of Bulk Molding Compound (BMC) with UL-classified insulating material.
- Adjustable metal mounting brackets.
- Dimensions: Box: 5-9/10" W x 5-4/5" H x 3-3/4" D  
Faceplate: 8-1/8" W X 8-1/16" H

Product No.	Description	UPC	Ctn. Qty.
<b>No Hammer Low Lead</b>			
39117	🔥 Fire Rated, 1/4 Turn, Copper, Low Lead – Standard Pack	038753391175	1
39119	🔥 Fire Rated, 1/4 Turn, F1807, Low Lead – Standard Pack	038753391199	1
39120	🔥 Fire Rated, 1/4 Turn, F1960, Low Lead – Standard Pack	038753391205	1
<b>Hammer Low Lead</b>			
39121	🔥 Fire Rated, 1/4 Turn, Copper, Hammer, Low Lead – Standard Pack	038753391212	1
39123	🔥 Fire Rated, 1/4 Turn, F1807, Hammer, Low Lead – Standard Pack	038753391236	1
39124	🔥 Fire Rated, 1/4 Turn, F1960, Hammer, Low Lead – Standard Pack	038753391243	1
<b>Accessories</b>			
38495	🔥 Fire Rated, Plain Box, No Valves – Standard Pack	038753384955	6
<b>Replacement Valves</b>			
39166	Valve-1/4 Turn IMB Hammer Copper LL	038753391663	1
39167	Valve-1/4 Turn IMB Hammer CPVC LL	038753391670	1
39168	Valve-1/4 Turn IMB Hammer Pex LL	038753391687	1
39169	Valve-1/4 Turn IMB Hammer Wirsbo LL	038753391694	1
39173	Valve-1/4 Turn F1960 1/4 In. LL	038753391731	1
39175	Valve-1/4 Turn CPVC 1/4 In. LL		1
39176	Valve-1/4 Turn Copper 1/4 In. LL	038753391762	1



#39169 shown

🔥 Denotes fire-rated





### Oatey® Metal Ice Maker Outlet Boxes

- Made of 20 gauge steel.
- Nailplate support brackets.
- Dimensions: Box: 5-1/2" W x 5" H x 2-1/2" D  
Faceplate Interior: 5" W x 5" H  
Faceplate Exterior: 6-3/4" W x 6-3/4" H

Product No.	Description	UPC	Ctn. Qty.
<b>No Hammer Low Lead</b>			
39141	Valve 1/4 Turn, Copper, IMB, No Hammer	038753391410	1
39166	Valve 1/4 Turn, Copper, IMB, Hammer	038753391663	1
<b>Hammer Low Lead</b>			
39140	Metal, 1/4 Turn, Copper, Hammer, Low Lead – Standard Pack	038753391403	1
<b>Accessories</b>			
38686	Metal Faceplate	038753386867	1
38687	Metal, Plain Box, No Valves – Standard Pack	038753386874	1
<b>Metal Ice Maker Replacement Valves</b>			
39141	Valve 1/4 Turn Copper IMB - No Hammer	038753391410	1
39166	Valve 1/4 Turn Copper IMB Hammer	038753391663	1



### Oatey® Square Ice Maker Outlet Boxes

- 2 support brackets. Provides quick, safe water supply and shut off for refrigerator ice maker and water dispenser.
- High impact polystyrene. Valves comply with requirements of NSF 61, Section 9.
- Available in several box and valve configurations.
- Dimensions: Box: 6" W x 6" H x 3-3/8" D  
Faceplate: 8-1/4" W x 8-1/4" H

Product No.	Description	UPC	Ctn. Qty.
<b>No Hammer Low Lead</b>			
39158	Square, 1/4 Turn, F1807, Low Lead – Standard Pack	038753391588	6
39160	Square, 1/4 Turn, F1807, Low Lead – Contractor Pack	038753391601	12
39161	Square, 1/4 Turn, F1960 Low Lead – Standard Pack	083753391618	6
39156	Square, 1/4 Turn, Copper, Low Lead – Standard Pack	038753391564	6
39157	Square, 1/4 Turn, Copper, Low Lead – Contractor Pack	038753391571	12
38326	Square, 1/4 Turn, Push Connect, Assembled	038753383262	6
38346	Square, 1/4 Turn, 1/2" Viega PEX Press, Assembled, Standard Pack	038753383460	6
<b>Hammer Low Lead</b>			
39149	Square, 1/4 Turn, F1807, Hammer, Low Lead – Standard Pack	038753391496	6
39150	Square, 1/4 Turn, F1960, Hammer, Low Lead – Standard Pack	038753391502	6
39152	Square, 1/4 Turn, Copper, Hammer, Low Lead – Standard Pack	038753391526	6
38327	Square IMOB, 1/4 Turn, Push Connect, Hammer, Assembled	038753383279	6
38347	Square IMOB, 1/4 Turn, 1/2" Viega PEX Press, Hammer, Assembled, Standard Pack	038753383477	6
<b>Accessories</b>			
38806	Square, Plain Box, No Valves, With Grommet – Standard Pack	038753388069	6
38810	Square, Plain Box, No Valves – Standard Pack	038753388106	6
38942	Square, Plastic Faceplate	038753389424	24

STANDARD PACK: Faceplates are pre-assembled on box.

CONTRACTOR PACK: Faceplates are NOT pre-assembled on box (but comes separately packed with the box).

### Oatey® I2K® Ice Maker Outlet Boxes

- Nails preloaded.
- Right or left hand installation.
- Provides quick, safe water supply and shut-off for refrigerator ice maker and water dispenser.
- Valves comply with requirements of NSF 61, Section 9.
- No support bracket needed.
- Dimensions: Box: 3-1/4" W x 4" H x 2-1/2" D  
Faceplate: 5" W x 6" H



#39130 shown



STANDARD PACK: Faceplates are pre-assembled on box.  
CONTRACTOR PACK: Faceplates are NOT pre-assembled on box (but comes separately packed with the box).

Product No.	Description	UPC	Ctn. Qty.
<b>No Hammer Low Lead</b>			
39134	I2K, 1/4 Turn, Copper, Low Lead - Standard Pack	038753391342	6
39135	I2K, 1/4 Turn, Copper, Low Lead - Contractor Pack	038753391359	12
39130	I2K, 1/4 Turn, Copper, Low Lead - Display Pack	038753391304	4
39133	I2K, 1/4 Turn, CPVC, Low Lead - Standard Pack	038753391335	6
39137	I2K, 1/4 Turn, CPVC, Low Lead - Contractor Pack	038753391373	12
39136	I2K, 1/4 Turn, F1807, Low Lead - Standard Pack	038753391366	6
39138	I2K, 1/4 Turn, F1807, Low Lead - Contractor Pack	038753391380	12
39114	I2K, 1/4 Turn, F1807, Low Lead - Display Pack	038753391144	4
39132	I2K, 1/4 Turn, F1960, Low Lead - Contractor Pack	038753391328	12
39139	I2K, Boiler Drain, Copper, Low Lead, NAFTA - Standard Pack	038753391397	6
38332	I2K, 1/4 Turn, Viega PEX Press – Standard Pack	038753383323	6
38340	I2K, 1/4 Turn, Viega PEX Press – Contractor Pack	038753383408	12
38312	I2K, 1/4 Turn, Push Connect – Standard Pack	038753383125	6
38320	I2K, 1/4 Turn, Push Connect – Contractor Pack	038753383200	12
<b>Hammer Low Lead</b>			
39125	I2K, 1/4 Turn, Copper, Hammer, Low Lead - Contractor Pack	038753391250	12
39126	I2K, 1/4 Turn, CPVC, Hammer, Low Lead - Contractor Pack	038753391267	12
39127	I2K, 1/4 Turn, F1807, Hammer, Low Lead - Contractor Pack	038753391274	12
39128	I2K, 1/4 Turn, F1960, Hammer, Low Lead - Contractor Pack	038753391281	12
38333	I2K, 1/4 Turn, Viega PEX Press – Standard Pack	38753383330	6
38341	I2K, 1/4 Turn, Viega PEX Press – Contractor Pack	038753383415	12
38313	I2K, 1/4 Turn, Push Connect – Standard Pack	038753383132	6
38321	I2K, 1/4 Turn, Push Connect – Contractor Pack	038753383217	12
<b>Accessories</b>			
38619	I2K, Plain Box, No Valves - Standard Pack	038753386195	6
38621	I2K, Plastic Faceplate 1/2" Deep	038753386218	12
38622	I2K, Plastic Faceplate 1" Deep	038753386225	12

### Oatey® Square and I2K® Ice Maker Outlet Box Replacement Valves and Accessories



#39174 shown



#39169 shown

Product No.	Description	UPC	Ctn. Qty.
<b>No Hammer Low Lead</b>			
39176	IMOB Valve, 1/4 Turn, Copper, Low Lead	038753391762	1
39175	IMOB Valve, 1/4 Turn, CPVC, Low Lead	038753391755	1
39173	IMOB Valve, 1/4 Turn, F1960 Low Lead	038753391731	1
39174	IMOB Valve, 1/4 Turn, F1807, Low Lead	038753391748	1
39171	IMOB Valve, Boiler Drain, Copper, Low Lead	038753391717	1
<b>Hammer Low Lead</b>			
39166	IMOB Valve, 1/4 Turn, Copper, Hammer, Low Lead	038753391663	1
39167	IMOB Valve, 1/4 Turn, CPVC, Hammer, Low Lead	038753391670	1
39168	IMOB Valve, 1/4 Turn, F1807, Hammer, Low Lead	038753391687	1
39169	IMOB Valve, 1/4 Turn, F1960, Hammer, Low Lead	038753391694	1
<b>Accessories</b>			
38779	Adapter 1/2" Female NPT X 1/2" Copper	038753387796	1
38829	Locknut 1/2" Plastic	038753388298	1
38769	Grommets 1/2"	038753387697	12



#34015 shown

**Oatey® Pex Water Supply Tubes**

- Meets performance requirements of ASME A122.18.6 ASTM F876 and ASTM F877.
- Fast and easy to install.
- One-piece ready to use.

Product No.	Description	UPC	Ctn. Qty.
34015	PEX Water Supply Kit with 1/4" Valve	038753340159	6
34312	PEX Sink Supply 20"	038753343129	48
34313	PEX Sink Supply 30"	038753343136	48
34314	PEX Sink Supply 36"	038753343143	48
34317	PEX Toilet Riser 20"	038753343174	48

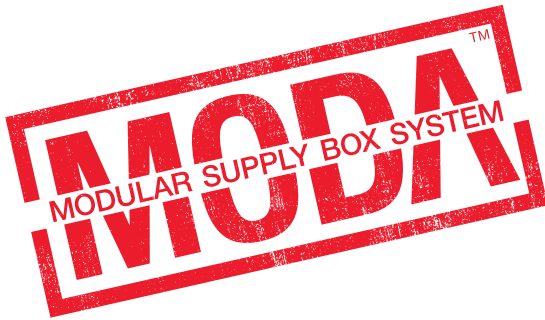

# SECONDARY DRAIN BOX



Old Method

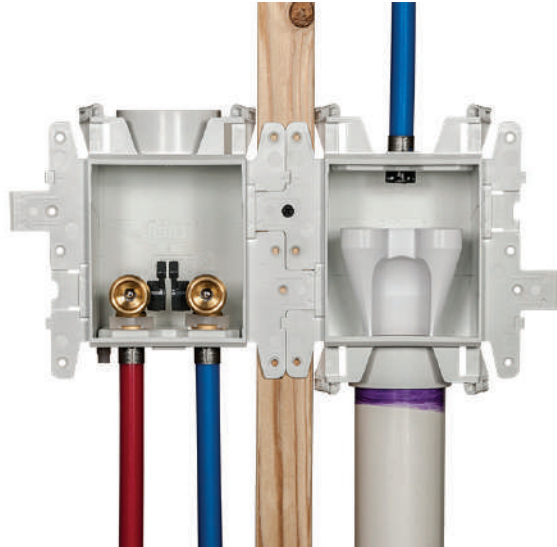

New Method

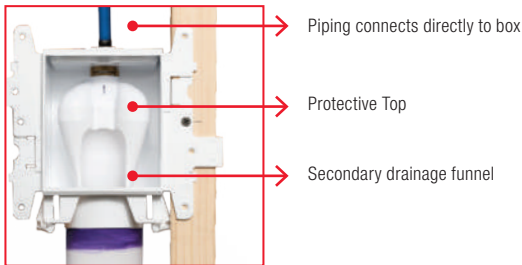

**FEATURES AND BENEFITS**

- Seamless connection from inlet pipe to drain (including air gap)
- Rated for high-flow applications, i.e. water softener (10GPM)
- No additional bracing or supports required for inlet supply
- No need to transition pipe type
- Available in F1807 PEX and F1960 PEX

**Accessory Components Included:**

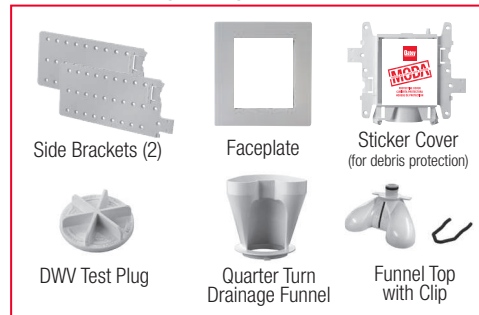

Part #	Description	Pack Type	UPC	Ctn Qty
37796	MODA, WMOB1, BR F1960, HAM and DRN BOX, 1/2 IN, BR, F1960	Contractor	038753377964	12
37797	MODA, WMOB1, BR F1960, NO HAM and DRN BOX, 1/2 IN, BR, F1960	Contractor	038753377971	12
37798	MODA, WMOB1, BR F1807, HAM and DRN BOX, 1/2 IN, BR, F1807	Contractor	038753377988	12
37799	MODA, WMOB1, BR F1807, NO HAM and DRN BOX, 1/2 IN, BR, F1807	Contractor	038753377995	12



# Category 12

## Flashings

Oatey® created the plumbing vent flashing industry nearly 100 years ago. Today Oatey flashings are used in commercial and residential applications where a water-tight seal around plumbing vent pipe or outside wall penetrations is required. Flashings are available in a variety of thermoplastic, aluminum, galvanized and copper materials. All Oatey flashings are rated for a minimum of 82°C continuous heat and approved for Type B Installations.



### Thermoplastic No-Calk® Colour Roof Flashings

- Non-fading, non-cracking, thermoplastic base.
- Self-sealing collar slides over pipe and requires no caulking.
- Do not use petroleum based products or paint on flashing collar or plastic base.
- Not for hot-mopped or built-up roofs.
- Plastic base for pitch from 0-45 degrees or up to 12/12 roof.
- Rated 82°C continuous heat and approved for Type B installations.
- Colours come in Black, Brown, Gray, and Weatherwood.

Product No.	Size	Description	UPC	Ctn. Qty.
48100	1.25" – 1.5"	NC-1" Plastic 14" x 16" Black	038753481005	12
48101	2"	NC-2" Plastic 14" x 16" Black	038753481012	12
48102	3"	NC-3" Plastic 14" x 16" Black	038753481029	12
48103	4"	NC-4" Plastic 14" x 16" Black	038753481036	12
481051	1.5 – 3"	NC-1-2-3" Plastic 14" x 16" Black	038753481050	6
481061	3 - 4"	NC-3-4" Plastic 14" x 16" Black	038753481067	6



### Galvanized No-Calk® Roof Flashings

- Galvanized Base.
- Self-sealing collar slides over pipe and requires no caulking.
- Metal base for pitch from 0-40° or up to 10/12 roof.
- Do not use petroleum based products or paint on flashing collar. Not for hot-mopped or built-up roofs.
- Rated 82°C continuous heat and approved for Type B installations.

Product No.	Size	Description	UPC	Ctn. Qty.
<b>SOLAR FLASHING</b>				
11830	.5" – 1"	Galvanized 9" x 12.5" base	038753118307	12
<b>STANDARD BASE FLASHING</b>				
11840	1.25" – 1.5"	Galvanized 9" x 12.5" base	038753118406	12
11855	2"	Galvanized 9" x 12.5" base	038753118550	12
11866	3"	Galvanized 11" x 14.5" base	038753118666	12
11879	4"	Galvanized 12" x 15" base	038753118796	12



### Flex-Flash™ No-Calk® Roof Flashings

- 100% flexible, foldable plastic base.
- Self-sealing collar slides over pipe and requires no caulking.
- Do not use petroleum based products or paint on flashing collar or plastic base. Not for hot-mopped or built-up roofs.
- Plastic base for pitch from 0-45° or up to 12/12 roof.
- Rated 82°C continuous heat and approved for Type B installations.

Product No.	Size	Description	UPC	Ctn. Qty.
14017	1.25" – 1.5"	NC-1.5" Flex 20" x 20"	038753140179	12
14018	2"	NC-2" Flex 20" x 20"	038753140186	12
14046	3"	NC-3" Flex 20" x 20"	038753140469	12
14047	4"	NC-4" Flex 20" x 20"	038753140476	12

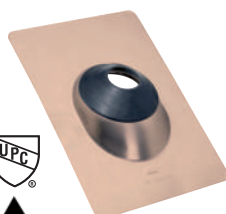

U.S. Patent No.  
5,588,267

### All-Flash® No-Calk® Roof Flashings/Copper Base

- Patented All-Flash® design allows use on multiple pipe sizes.
- Copper base. Rated 82°C continuous heat and approved for Type B installations.
- Metal base for pitch from 0-40°.
- Self-sealing collar slides over pipe and requires no caulking.
- Do not use petroleum based products or paint on flashing collar or plastic base. Not for hot-mopped or built-up roofs.

Product No.	Size	Description	UPC	Ctn. Qty.
12404	3" – 4"	Copper No-Calk® 11" x 14.5" base	750405124046	12



### Aluminum No-Calk® Roof Flashings/18" X 18" Base

- Rustproof stamped aluminum base allows for easy shaping of flashing.
- Rated 82°C continuous heat and approved for Type B installations.
- Metal base for pitch from 0-40° or up to 10/12 roof.
- Self-sealing collar slides over pipe and requires no caulking.
- Do not use petroleum based products or paint on flashing collar. Not for hot-mopped or built-up roofs.

Product No.	Size	Description	UPC	Ctn. Qty.
12836	1.25" – 1.5"	Soft Aluminum 18" x 18" base	038753128368	12
12849	2"	Soft Aluminum 18" x 18" base	038753128498	12
48142	3"	Soft Aluminum 18" x 18" base	038753481425	12
48143	4"	Soft Aluminum 18" x 18" base	038753481432	12



### Sideflash™ Vertical Flashings

- Maintains a constant seal in commercial and residential pipe penetration applications through outside walls.
- Designed with a tear out collar to accommodate pipe size use from ½" to 2½" or 3" to 6".
- Rated 82°C continuous heat and approved for type B installations.

Product No.	Size	Description	UPC	Ctn. Qty.
12805	.5" – 2.5"	Sideflash Vertical Flashing	038753128054	12
12806	3" – 6"	Sideflash Vertical Flashing	038753128061	12



### High-Rise® Thermoplastic All-Flash® No-Calk® Roof Flashings

- Roof Flashing slides over DWV pipe for pitch to 60°.
- Patented All-Flash collar has tear-away ring allowing flashing to seal various pipe diameters.
- Non-fading, non-cracking rigid black thermoplastic base.
- Non-fading sealing collar.
- Rated 82°C continuous heat and approved for type B installations.
- Not for hot-mopped or built-up roofs.
- Do not use paint or petroleum based products on plastic bases or rubber collars.

Product No.	Size	Description	UPC	Ctn. Qty.
11930	1.5" – 3"	All-Flash® High-Rise® 11" x 19" base	038753119304	6
11931	3" – 4"	All-Flash® High-Rise® 13" x 20" base	038753119311	6



### Rain Collar For No-Calk® Roof Flashings

- Use as a protective water shield (slides over existing flashing). No caulking needed.
- Do not use petroleum based products on rubber collars.
- Non-fading collar material.

Product No.	Size	Description	UPC	Ctn. Qty.
14122	1.25" – 1.5"	Collar	038753141220	36
14135	2"	Collar	038753141350	24
14137	3" – 4"	All Flash Collar	038753141374	12
14193	3"	Collar	038753141930	24
14203	4"	Collar	038753142036	12



### Master Flash® Roof Flashings

- Slides over pipe - for pitch to 45 degrees.
- Use silicone sealant between base and surface, and secure with sheet metal screws.
- Multi-size pipe sealing range.
- Molds to metal, plastic, etc.
- Non-fading EPDM collar.
- Rated 100°C continuous heat and approved for Type B installations.

MASTER FLASH® is a Registered Trademark of the Aztec Washer Company, Inc.

Product No.	Size	Description	UPC	Ctn. Qty.
14050	.25" – 2"	Master Flash® 4.5" x 4.5" base	038753140506	6
14051	1.25" – 3"	Master Flash® 6" x 6" base	038753140513	6
14052	.25" – 5.75"	Master Flash® 8" x 8" base	038753140520	6
14053	3" – 6"	Master Flash® 10" x 10" base	038753140537	6
14054	4" – 7"	Master Flash® 11" x 11" base	038753140544	2
14055	5" – 9"	Master Flash® 12" x 12" base	038753140551	2
14056	6" – 11"	Master Flash® 14" x 14" base	038753140568	2
14057	7" – 13"	Master Flash® 17" x 17" base	038753140575	2
14059	10" – 18"	Master Flash® 25" x 25" base	038753140599	5



### Universal Master Flash® Roof Flashings

- Engineered for profiled roofing systems at any pitch.
- Rated 212°F continuous heat and approved for Type B installations.
- Easily customized to accommodate a broad range of pipe diameters.

Product No.	Size	Description	UPC	Ctn. Qty.
14743	1/4" – 5"	Universal Master Flash® 7-3/4" base	750405147434	5

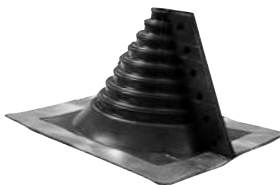

### Retro Master Flash® Roof Flashings

- Split collar design easily installs on pipe with limited over the top access.
- Easily customized to accommodate a broad range of pipe diameters.
- Engineered for profiled roofing systems at any pitch.
- Rated 100°C continuous heat and approved for Type B installations.

Product No.	Size	Description	UPC	Ctn. Qty.
14049	.25" – 4"	Retro Master Flash® 8" x 8" base	038753140490	1
14751	.5" – 4"	Retro Master Flash® 8" x 8" base	750405147519	10
14752	4" – 9.25"	Retro Master Flash® 8" x 8" base	750405147526	5
14753	9.25" – 16"	Retro Master Flash® 8" x 8" base	750405147533	5

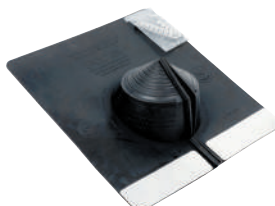

### Electrical Service Mast (ESM) Master Flash® Roof Flashings

- Galvanized base.
- Self-sealing collar slides over pipe and requires no caulking.
- Collar unattached from flashing base for Electrical Service Mast applications.
- Do not use petroleum based products or paint on flashing collar or plastic base. Not for hot-mopped or built-up roofs.

Product No.	Size	Description	UPC	Ctn. Qty.
14090	0 – 5-3/8"	EPDM ESM Master Flash 15" x 15" base	038753140902	4



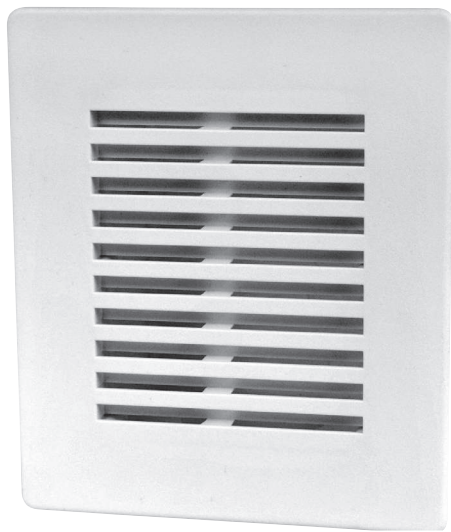

# Category 13

## Air Admittance Valves (AAV)

Sensitivity to pressure changes, combined with its ability to consistently open and close, is what distinguishes the Oatey® Sure-Vent® AAV from all others. Superior engineering along with stringent quality standards ensure a lifetime of unmatched performance. Available in multiple DFU capacities to meet various applications (8, 24, 72 and 500 DFU).

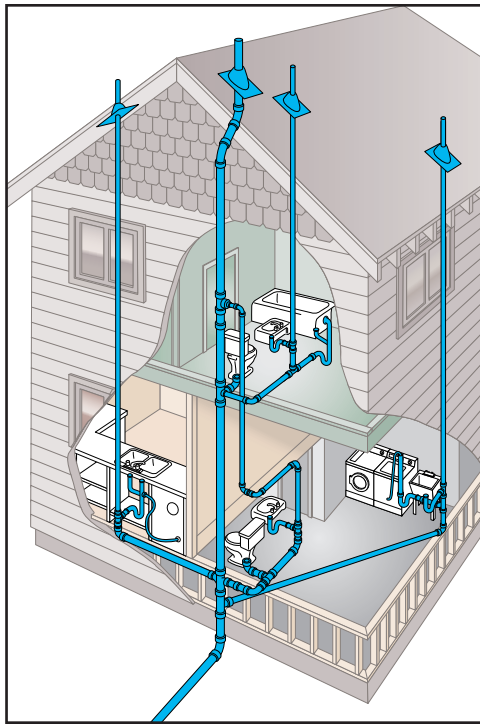

Traditional Vented House

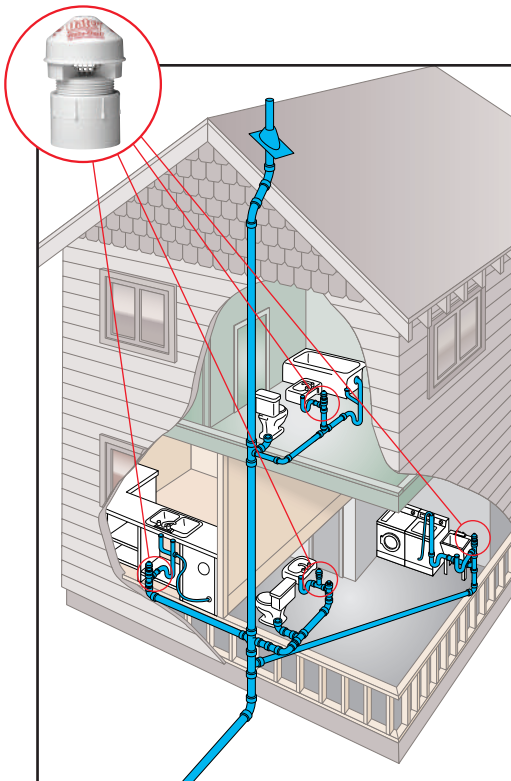

AAV Vented House

Plumbing Drain, Waste and Vent systems, known as DWV, consist of the DRAIN pipes that provide a network for the removal of WASTE and the VENT pipes that prevent traps from siphoning and maintain an equalized pressure. The DWV system uses gravity and air displacement throughout the piping network to function and breathe. In a simplified example, water in an inverted bottle without an air hole will glug and gasp when emptied. Adding an opening to the bottom of the bottle will turn the process into an efficient, steady flow because the bottle “breathes.”

**Every Drain Needs a Trap. Every Trap Needs a Vent.**

To prevent sewer gases from being released into the structure, plumbing code requires a trap to be installed at every fixture. A trap is a U-shaped bend of pipe filled with water that acts as a barrier between the structure and the sewer system. Trap seals can only be compromised under two conditions – high sewer pressures and water siphons, in both cases vents prevent this from happening.

Under high sewer pressures without a vent, trap seals will allow sewer gases to escape and enter the structure. This happens when the sewer pressure is greater than the pressure from the column of water in the trap. A vent will keep the sewer and atmospheric pressures equalized to maintain the trap seal.

Water moving through pipes can create a negative pressure or a siphon. The siphon will pull the water from a trap, leaving a clear path for sewer gases to enter the structure. A vent will prohibit siphoning, maintaining the trap seal.

**Why Use a Sure-Vent® Air Admittance Valve?**

Air Admittance Valves (AAVs) open and close in conjunction with normal DWV system operation, effectively eliminating the need for secondary vent pipes. An AAV provides an alternative to secondary venting when utilized within the scope of model plumbing codes, referenced standards and Oatey® installation instructions.

AAVs provide the ideal venting solution for island sinks, remote bathroom groups and remodeling jobs by eliminating the need to tie into a stack vent.

AAVs are often more economical than running vent pipe in new construction because they reduce the added need for supplies and labor.

The Oatey Sure-Vent offers UNMATCHED PERFORMANCE by opening and closing under the smallest pressures, multiple sizes for OPTIMIZED DFUs and SUPERIOR SEALING technology, providing a lifetime of reliability.

## AIR ADMITTANCE VALVES (AAV)



### Oatey® Sure-Vent® Air Admittance Valve – 20 Branch, 8 Stack DFU Capacity

- Complies to ASSE Standard 1050 and 1051.
- For use as a secondary vent.
- One size approved to handle up to 2" vent pipe.
- Opens/closes as needed by building's plumbing system.

Product No.	Adapter Size	Description	UPC	Ctn. Qty.
39225	1.5"	20 Branch, 8 Stack DFU Sure-Vent AAV 1-1/2" Tubular adapter (white)	038753392257	6
39239	1.5"	20 Branch, 8 Stack DFU AAV Installation Kit 1-1/2" P-trap, 6" extension tube, PVC threaded adapter & deep box flange	038753392394	6
39228	1.5"	20 Branch, 8 Stack DFU Sure-Vent AAV w/ PVC Adapter	038753392288	6
39229	1.5"	20 Branch, 8 Stack DFU Sure-Vent AAV w/ ABS Adapter	038753392295	6
39256	1.5" – 2"	6 DFU Sure-Vent AAV ABS Schedule 40 adapter	038753392561	6



### Oatey® Sure-Vent® Air Admittance Valve – 160 Branch, 24 Stack DFU Capacity

- Complies to ASSE Standard 1050 and 1051.
- For use as a secondary vent.
- One size approved to handle up to 3" vent pipe.
- Opens/closes as needed by building's plumbing system.

Product No.	Adapter Size	Description	UPC	Ctn. Qty.
39016	1.5" – 2"	160 Branch, 24 Stack DFU Sure-Vent AAV 1-1/2" x 2" Sch. 40 PVC Adapter	038753390161	6
39017	1.5" – 2"	160 Branch, 24 Stack DFU Sure-Vent AAV 1-1/2" x 2" Sch. 40 PVC Adapter <b>(Bulk)</b>	038753390178	50
39018	1.5" – 2"	160 Branch, 24 Stack DFU Sure-Vent AAV 1-1/2" x 2" Sch. 40 ABS Adapter	038753390185	6
39019	1.5" – 2"	160 Branch, 24 Stack DFU Sure-Vent AAV 1-1/2" x 2" Sch. 40 ABS Adapter <b>(Bulk)</b>	038753390192	50
39238	1.5" – 2"	160 Branch, 24 Stack DFU Sure-Vent AAV with mechanical adaptor	038753392387	12



### Oatey® Sure-Vent® Air Admittance Valve – 160 Branch, 72 Stack DFU Capacity

- Complies to ASSE Standard 1050 and 1051.
- For use as a secondary vent.
- One size approved to handle up to 4" vent pipe.
- Opens/closes as needed by building's plumbing system.

Product No.	Adapter Size	Description	UPC	Ctn. Qty.
39220	2" – 3"	160 Branch, 72 Stack DFU Sure-Vent AAV 2" x 3" Sch. 40 PVC adapter	038753392202	6
39221	2" – 3"	160 Branch, 72 Stack DFU Sure-Vent AAV 2" x 3" Sch. 40 ABS adapter	038753392219	6

AIR ADMITTANCE VALVES (AAV)



**Oatey® Sure-Vent® Air Admittance Valve – 160 Branch, 500 Stack DFU Capacity**

- Complies to ASSE Standard 1050 and 1051.
- For use as a secondary vent.
- One size approved to handle up to 4" vent pipe.
- Opens/closes as needed by building's plumbing system.

Product No.	Adapter Size	Description	UPC	Ctn. Qty.
39223	3" – 4"	160 Branch, 500 Stack DFU Sure-Vent AAV 3" x 4" Sch. 40 PVC adapter	038753392233	6
39224	3" – 4"	160 Branch, 500 Stack DFU Sure-Vent AAV 3" x 4" Sch. 40 ABS adapter	038753392240	6



**Oatey® MODA™ Sure-Vent® Air Admittance Valve Box**

- Includes 160 branch, 24 stack DFU AAV with louvered faceplate
- Louvered, solid and semi-cover faceplate inserts available. See MODA Accessories

Product No.	Description	UPC	Ctn. Qty.
37981	MODA, Sure-Vent AAV Standard Drain – Standard Pack	038753379814	12



**Oatey® Sure-Vent® Access Panel**

- Allows access to Sure-Vent air admittance valve.
- Meets code requirements for recessing an air admittance valve in a wall.

Product No.	Size	Description	UPC	Ctn. Qty.
34247	6" x 9"	Louvered Design Access Panel	038753342474	6



**Oatey® Sure-Vent® Wall Box**

- New, smaller size: 4-1/2" x 5-3/4".
- High-impact polystyrene construction.
- Accommodates 20 branch/8 stack, 160 branch/24 stack DFU AAVs with 1-1/2" or 2" adapters.

Product No.	Size	Description	UPC	Ctn. Qty.
39260		Box Kit	038753392608	6
39261		Louvered Faceplate	038753392615	6
39262		Box Kit with PVC Adapter and 24 DFU AAV	038753392622	6
39263		Box Kit with ABS Adapter and 24 DFU AAV	038753392639	6



**Oatey® In-Line Vent**

- Mechanical vent installs on the drain line and vents the line without allowing sewer gas to enter the home.
- Available in either chrome or ABS & packaged in polybag.
- For venting sinks, tubs, showers, washing machines, etc.
- Eliminates the need for secondary stacks.

Product No.	Size	Description	UPC	Ctn. Qty.
39000		Chrome In-Line Vent	038753390000	6
39012		ABS In-Line Vent	038753390123	6



# Category 14

## Pipe Support

Oatey® and MASTERS® offer a complete range of pipe support products for all of your application needs. Whether it's securing supply lines, DWV pipe or supporting your work with brackets and bars, you can count on Oatey for quality, performance and innovation.

## Oatey® Full Clamp

**Easy installation.**  
**Easy removal when you need it.**

### FEATURES AND BENEFITS

- Push on installation — lead in edge automatically opens up clamp
- Patented removal wedge and notch allows for clamp removal
- Complete stand-off from surface
- 360° pipe protection — allows tube to expand and contract

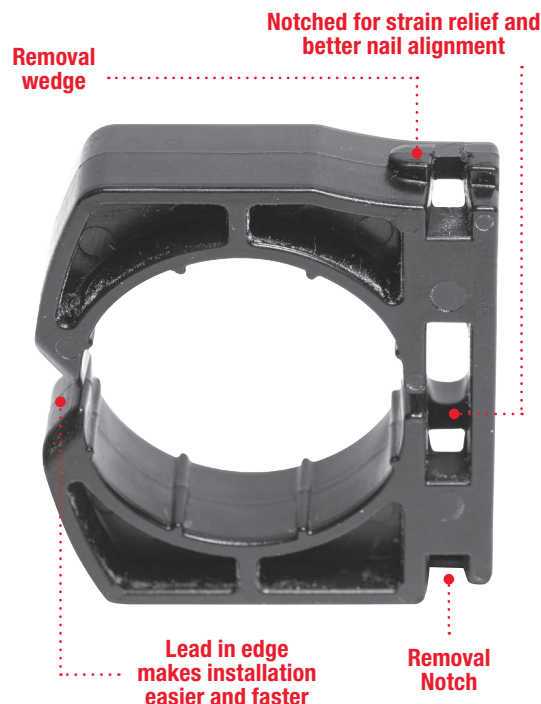

## Clamps by the Bucket

No need to break the bank when buying a bucket of clamps from Oatey®. You can now get your favorite clamps, including the new Duo-Fit and Stand-Off, in a handy 2.1 gallon Oatey bucket. The bucket holds 300-900 clamps depending on the size and type. And each bucket features a unique reclosable lid. No need to cut a hole in the lid like other buckets force you to do, tearing your hand up in the process of grabbing a handful of clamps. Better yet, when the bucket is empty, it makes a great storage container, or is useful when working on plumbing under sinks and tight areas where bigger buckets just can't fit.

- **Smaller size bucket saves you money, more versatile.**
- **Reclosable lid is easy on the hands.**





**Oatey® DuoFit™ Pipe Clamps**

- One clamp fits both 1/2" and 3/4" size pipe.
- Use on copper, CPVC and PEX.
- Move pre-loaded nail to keep pipe off of stud.
- Temperature range: -17°C – 110°C.
- Constructed of black polypropylene.
- UPC listed.
- Available in 2 gallon buckets.

Product No.	Size	Description	UPC	Ctn. Qty.
34285	1/2" – 3/4"	DuoFit Pipe Support System with Nail (100 in polybag)	038753342856	500 Pcs
34295	1/2" – 3/4"	DuoFit Pipe Support System with Nail (12 in polybag)	038753342955	6 Bags
34297	1/2" – 3/4"	DuoFit Pipe Support System with Nail - 400 in 2 gallon <b>bucket</b>	038753342979	1



**Oatey® Stand-Off™ Half Clamps**

- Clamps keep pipe completely off of the stud.
- Pre-loaded nail provides fast and easy installation.
- Made of high-impact polypropylene.
- Temperature range: -51°C – 71°C.
- UPC listed.
- Available in 2 gallon buckets.

Product No.	Size	Description	UPC	Ctn. Qty.
34286	1/2"	Stand-Off Pipe Clamp with Nail (100 in polybag)	038753342863	500 Pcs
34287	3/4"	Stand-Off Pipe Clamp with Nail (100 in polybag)	038753342870	500 Pcs
34288	1"	Stand-Off Pipe Clamp with Nail (50 in polybag)	038753342887	250 Pcs
34298	1/2"	Stand-Off Pipe Clamp with Nail – 500 in 2.1 gallon <b>bucket</b>	038753342986	1
34299	3/4"	Stand-Off Pipe Clamp with Nail – 300 in 2.1 gallon <b>bucket</b>	038753342993	1



**Oatey® Pipe Clamps With Nail**

- Pre-loaded nail feature provides fast and easy installation.
- Ribbed design insulates against water line noise.
- No corrosion – made of high impact polypropylene.
- Rust resistant nails.
- Can be used on hydronic systems.
- UPC listed.

Product No.	Size	Description	UPC	Ctn. Qty.
<b>HALF CLAMP</b>				
33900	1/2"	Half Clamp w/barbed nail (100 in polybag)	038753339009	500 Pcs
33901	3/4"	Half Clamp w/barbed nail (100 in polybag)	038753339016	500 Pcs
33902	1"	Half Clamp w/barbed nail (50 in polybag)	038753339023	250 Pcs
33910	1/2"	Half Clamp w/barbed nail (12 in polybag)	038753339108	6 Bags
33911	3/4"	Half Clamp w/barbed nail (12 in polybag)	038753339115	6 Bags
34290	1/2"	Half Clamp w/barbed nail – 900 in 2.1 gallon <b>bucket</b>	038753342900	1
34291	3/4"	Half Clamp w/barbed nail – 500 in 2.1 gallon <b>bucket</b>	038753342917	1
34292	1"	Half Clamp w/barbed nail – 300 in 2.1 gallon <b>bucket</b>	038753342924	1
34900	1/2"	Half Clamp w/barbed nail (100 in polybag)	038753349008	5 Bags
34901	3/4"	Half Clamp w/barbed nail (100 in polybag)	038753349015	5 Bags
<b>FULL CLAMP</b>				
33905	1/2"	Full Clamp w/barbed nail (100 in polybag)	038753339054	500 Pcs
33906	3/4"	Full Clamp w/barbed nail (50 in polybag)	038753339061	250 Pcs
33907	1"	Full Clamp w/barbed nail (25 in polybag)	038753339078	250 Pcs
33912	1/2"	Full Clamp w/barbed nail (12 in polybag)	038753339122	6 Bags
33913	3/4"	Full Clamp w/barbed nail (12 in polybag)	038753339139	6 Bags





**Oatey® Suspension Pipe Clamps/Half Clamp**

- Eliminates contact between the pipe and framing surface thereby reducing transmission of water line noise.
- No corrosion – made of durable polypropylene.
- Ribbed design allows faster cooling and pipe expansion and contraction.
- Can be used on hydronic systems.
- UPC listed.

Product No.	Size	Description	UPC	Ctn. Qty.
33914	1/2"	Suspension Pipe Clamp (6 in polybag)	038753339146	6 Bags
33915	3/4"	Suspension Pipe Clamp (6 in polybag)	038753339153	6 Bags
33935	1/2"	Suspension Pipe Clamp (100 in polybag)	038753339351	500 Pcs
33936	3/4"	Suspension Pipe Clamp (100 in polybag)	038753339368	500 Pcs
33937	1"	Suspension Pipe Clamp (50 in polybag)	038753339375	250 Pcs
33956	1-1/4"	Suspension Pipe Clamp (25 in polybag)	038753339566	250 Pcs
33957	1-1/2"	Suspension Pipe Clamp (25 in polybag)	038753339573	250 Pcs
33958	2"	Suspension Pipe Clamp (25 in polybag)	038753339580	250 Pcs
34293	1/2"	Suspension Pipe Clamp – 325 in 2.1 gallon bucket	038753342931	250 Pcs
34294	3/4"	Suspension Pipe Clamp – 250 in 2.1 gallon bucket	038753342948	250 Pcs



**Oatey® Insulating Pipe Clamps**

- Designed to eliminate notching and wrapping of pipe when running water lines through framing.
- Reduces water line noise and vibration.
- No corrosion – made of durable, low-density polypropylene (gray colour).
- UPC listed.

Product No.	Size	Description	UPC	Ctn. Qty.
33950	1/2"	Insulating Pipe Clamp (50 in polybag)	038753339504	250 Pcs
33953	1/2"	Insulating Pipe Clamp (6 in polybag)	038753339535	6 Bags
33951	3/4"	Insulating Pipe Clamp (50 in polybag)	038753339511	250 Pcs
33954	3/4"	Insulating Pipe Clamp (6 in polybag)	038753339542	6 Bags
33952	1"	Insulating Pipe Clamp (25 in polybag)	038753339528	250 Pcs



**Oatey® Standard Pipe Clamps**

- Clamp design allows pipe to be flush mounted to walls and joists.
- Minimizes the transmission of water line noise.
- No corrosion – made of durable polypropylene (gray colour).
- Ribbed design allows pipe to cool faster and expand/contract freely.
- Can be used on hydronic systems.
- UPC listed.

Product No.	Size	Description	UPC	Ctn. Qty.
33916	1/2"	Standard Pipe Clamp (6 in polybag)	038753339160	6 Bags
33917	3/4"	Standard Pipe Clamp (6 in polybag)	038753339177	6 Bags
33940	1/2"	Standard Pipe Clamp (100 in polybag)	038753339405	500 Pcs
33941	3/4"	Standard Pipe Clamp (100 in polybag)	038753339412	500 Pcs
33942	1"	Standard Pipe Clamp (50 in polybag)	038753339429	250 Pcs
33943	1-1/4"	Standard Pipe Clamp (25 in polybag)	038753339436	250 Pcs
33944	1-1/2"	Standard Pipe Clamp (25 in polybag)	038753339443	250 Pcs
33946	2"	Standard Pipe Clamp (25 in polybag)	038753339467	250 Pcs



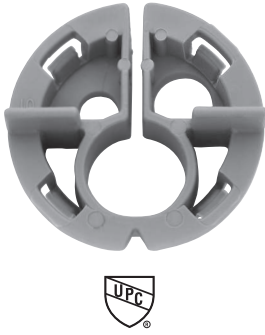

**Oatey® Metal Stud Insulating Pipe Clamps**

- Reduces water line noise and vibration when running water lines through metal studs.
- Hand tighten into place.
- 1/2" size has 1/4" and 3/8" holes.
- Use on 18 gauge or lighter weight metal studs.
- No corrosion – made of durable polypropylene.
- Can be used on hydronic systems.
- Tabs for easy adjustment.
- Patent #6,598,835 and UPC listed.

Product No.	Size	Description	UPC	Ctn. Qty.
33856	1/2"	Metal Stud Insulating Pipe Clamp (50 in polybag)	038753338569	250 Pcs
33857	3/4"	Metal Stud Insulating Pipe Clamp (50 in polybag)	038753338576	250 Pcs
33858	1"	Metal Stud Insulating Pipe Clamp (25 in polybag)	038753338583	250 Pcs



**Oatey® Holdrite® Pipe Support Bracket**

- Supports any water supply lines penetrating the wall.
  - Holes on 2" centers for 1/2" pipe and 4" centers for 3/4" and 1" copper pipe.
  - Nail in place and solder pipe to copper plated bracket for secure installation.
- Holdrite® is a registered trademark of Securus, Inc.

Product No.	Size	Description	UPC	Ctn. Qty.
33980		Pipe Support Bracket	038753339801	25 Pcs



**Oatey® Hyco Bar**

- Multi-purpose Galvanized Strap.

Product No.	Size	Description	UPC	Ctn. Qty.
33982	5/8" x 18"	Hyco-Bar – 14 Ga.	038753339825	100
33983	5/8" x 26"	Hyco-Bar – 14 Ga.	038753339832	100



**Oatey® Flat Tube Nailers**

- Copper plated tube nailers provide quick nail support.
- Use with copper, PVC, CPVC, galvanized, PEX and other piping systems.

Product No.	Size	Description	UPC	Ctn. Qty.
33965	1/2" – 3/4"	Copper Coated Tube Nailers (12 in polybag)	038753339658	36 Bags
33966	1/2" – 3/4"	Copper Coated Steel Nailers (100 in polybag)	038753339665	1000 Pcs



**MASTERS® Copper And Copper Clad Clips**

- Dimples to lock in pipe
- Nails included

Product No.	Size	Description	UPC	Ctn. Qty.
CLCC50	.50"	MASTERS Clips Copper Clad - 10 per bag	067001004413	1000
CLCC50V	.50"	MASTERS Clips Copper Clad - 100 per bag	067001004420	2000
CLCC75	.75"	MASTERS Clips Copper Clad - 10 per bag	067001004437	1000
CLCC75V	.75"	MASTERS Clips Copper Clad - 100 per bag	067001004444	1500
CLC50V	.50"	MASTERS Clips Copper - 100 per bag	067001004383	2000
CLC75V	.75"	MASTERS Clips Copper - 100 per bag	067001004406	1500



**Oatey® Copper and Steel Pipe Hooks**

- Use with copper, PVC, CPVC, galvanized, PEX and other piping systems.
- Support pipe from rafters or joists.
- Self-nailing.

Product No.	Size	Description	UPC	Ctn. Qty.
33971	1/2" x 6"	Copper Pipe Hook – 50 per Box	038753339719	500 Pcs
33973	3/4" x 6"	Copper Pipe Hook – 50 per Box	038753339733	500 Pcs
33972	3/4" x 6"	Copper Pipe Hook – 12 per Bag	038753339726	10 Bags
33975	1" x 6"	Copper Pipe Hook – 50 per Box	038753339757	500 Pcs
33969	1" x 6"	Copper Pipe Hook – 6 per Bag	038753339696	12 Bags
33974	1" x 6"	Copper Pipe Hook – 12 per Bag	038753339740	10 Bags
33997	1" x 6"	Steel Pipe Hook – 50 per Box	038753339979	500 Pcs
33998	1/2" x 6"	Steel Pipe Hook – 50 per Box	038753339986	500 Pcs
33955	1/2" x 6"	Steel Pipe Hook – 6 per Bag	038753339559	6 Bags
33964	1/2" x 6"	Steel Pipe Hook – 12 per Bag	038753339641	12 Bags
33999	3/4" x 6"	Steel Pipe Hook – 50 per Box	038753339993	500 Pcs



**Oatey® DWV J-Hook**

- Pre-loaded nails in stem.
- Diagonal nail path for use in tight applications.
- Locking finger for tight hold at any angle, including inverted.
- Additional holes allow securing with cable ties or other fasteners.
- Made of black and white ABS. Temperature range: -40°C - 82°C.

Product No.	Size	Description	UPC	Ctn. Qty.
33740	1-1/2" x 7-1/2"	DWV J-Hook – White (25 In Polybag)	038753337401	300 Pcs
33741	2" x 7-1/2"	DWV J-Hook – White (25 In Polybag)	038753337418	300 Pcs
33742	3" x 7-1/2"	DWV J-Hook – White (25 In Polybag)	038753337425	300 Pcs
33743	4" x 7-1/2"	DWV J-Hook – White (25 In Polybag)	038753337432	300 Pcs
33755	1-1/2" x 7"	DWV J-Hook – Black (25 In Polybag)	038753337555	300 Pcs
33756	2" x 7"	DWV J-Hook – Black (25 In Polybag)	038753337562	300 Pcs
33757	3" x 7"	DWV J-Hook – Black (25 In Polybag)	038753337579	300 Pcs
33758	4" x 7"	DWV J-Hook – Black (25 In Polybag)	038753337586	300 Pcs
33760	1-1/2" x 7-1/2"	DWV J-Hook – White (4 In Polybag)	038753337609	6 Bags
33761	2" x 7- 1/2"	DWV J-Hook – White (4 In Polybag)	038753337616	6 Bags
33762	3" x 7-1/2"	DWV J-Hook – White (4 In Polybag)	038753337623	6 Bags
33763	4" x 7-1/2"	DWV J-Hook – White (4 In Polybag)	038753337630	6 Bags



**Oatey® CTS J-Hook**

- Support copper and CPVC water supply lines from joists and rafters.
- J-Hook nails flush against a wall or stud.
- Made of high impact ABS for increased load capacity.
- UPC listed.

Product No.	Size	Description	UPC	Ctn. Qty.
33745	1/2" x 4"	CTS Baby J-Hook (25 in polybag)	038753337456	300 Pcs
33764	1/2" x 4"	CTS Baby J-Hook (6 in polybag)	038753337647	6 Bags
33746	3/4" x 4"	CTS Baby J-Hook (25 in polybag)	038753337463	300 Pcs
33765	3/4" x 4"	CTS Baby J-Hook (6 in polybag)	038753337654	6 Bags
33747	1" x 4"	CTS Baby J-Hook (25 in polybag)	038753337470	200 Pcs
33766	1" x 4"	CTS Baby J-Hook (6 in polybag)	038753337661	6 Bags
33750	1/2" x 7-1/2"	CTS Long Baby J-Hook (25 in polybag)	038753337500	200 Pcs
33751	3/4" x 7-1/2"	CTS Long Baby J-Hook (25 in polybag)	038753337517	200 Pcs

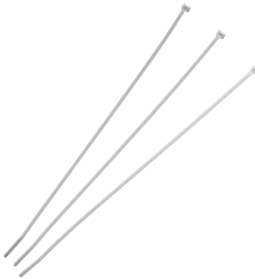

**Oatey® Cable, Conduit & Duct Ties**

- Enables cables, tubing, etc. to be secured together.
- Special locking device provides a positive, non-slip grip.
- Made of nylon.

Product No.	Size	Description	UPC	Ctn. Qty.
33850	7-1/2"	Ties for 1-3/4" diameter (25 in polybag)	038753338507	12 Bags
33851	11"	Ties for 3" diameter (25 in polybag)	038753338514	12 Bags
33852	14"	Ties for 4" diameter (25 in polybag)	038753338521	12 Bags
33853	24"	Ties for 7" diameter (6 in polybag)	038753338538	12 Bags
33854	34"	Ties for 10" diameter (6 in polybag)	038753338545	12 Bags
33855	48"	Ties for 15" diameter (6 in polybag)	038753338552	12 Bags



#33930 shown



#33932 shown

**Oatey® Stud Guards and FHA Plates**

- Provide protection for pipes and wiring installations.
- Stud guards have special self-nailing feature.
- Made of 16 or 18 gauge steel.

Product No.	Size	Description	UPC	Ctn. Qty.
33893	1-1/2" x 3"	16 Gauge Self-Nailing Stud Guard – 2-1/2" between points	038753338934	100 Pcs
33894	1-1/2" x 5"	16 Gauge Self-Nailing Stud Guard – 4-1/2" between points	038753338941	100 Pcs
33895	1-1/2" x 6"	16 Gauge Self-Nailing Stud Guard – 5-1/2" between points	038753338958	100 Pcs
33897	5" x 8"	16 Gauge BOCA Plate Meets BOCA Code P-309.2	038753338972	25 Pcs
33919	1-1/2" x 6"	18 Gauge Self-Nailing Stud Guard – 5-1/2" between points	038753339191	100 Pcs
33930	1-1/2" x 3"	18 Gauge Self-Nailing Stud Guard – 2-1/2" between points	038753339306	100 Pcs
33931	1-1/2" x 5"	18 Gauge Self-Nailing Stud Guard – 4-1/2" between points	038753339313	100 Pcs
33932	1-1/2" x 9"	18 Gauge FHA Plate -Barcoded	038753339320	25 Pcs
33933	1-1/2" x 3"	18 Gauge Self-Nailing Stud Guard – Barcoded	038753339337	25 Pcs



### Oatey® Copper Plated Bell Hangers

- Designed with 13/16" standoff from mounting surface.
- Mounting screw has pierce point for use on metal studs.
- Recessed mounting screw does not contact the piping.
- Includes two clamp screws and one 2-1/2" screws.

Product No.	Size	Description	UPC	Ctn. Qty.
33691	1/2"	Copper Plated Bell Hanger	038753336916	25
33692	3/4"	Copper Plated Bell Hanger	038753336923	25
33693	1"	Copper Plated Bell Hanger	038753336930	25



### Oatey® Copper Plated Milford Hangers

- Hang copper tube size piping.
- Top set plate swivels and locks into place.

Product No.	Size	Description	UPC	Ctn. Qty.
33694	1/2" x 6"	Copper Plated Milford Hanger	038753336947	25
33695	3/4" x 6"	Copper Plated Milford Hanger	038753336954	25
33696	1" x 6"	Copper Plated Milford Hanger	038753336961	25
33697	1/2" x 12"	Copper Plated Milford Hanger	038753336978	25
33698	3/4" x 12"	Copper Plated Milford Hanger	038753336985	25
33699	1" x 12"	Copper Plated Milford Hanger	038753336992	25



### Oatey® Universal Pipe Support

- Meets ASTM Requirements.
- IAPMO Approved.
- Strap adjusts to accommodate 1"-6" diameter pipe.
- Available in white and black color plastic.
- Orientation of the strap can be reversed based on installation need.
- Straight and angled nail hole patterns to accommodate tough installation angles.

Product No.	Size	Description	UPC	Ctn. Qty.
33664	14"	Universal DWV Pipe Hanger - Black	038753336640	25
33665	14"	Universal DWV Pipe Hanger - White	038753336657	25



### Oatey® Plastic Hanger Strap

- Nail holes are 1/8" in diameter and spaced 3/4" apart.
- Non-corrosive, non-conductive, polyethylene.
- Quick and inexpensive way to hang pipe from joists or rafters.

Product No.	Size	Description	UPC	Ctn. Qty.
33925	3/4" x 25'	Plastic Hanger Strap – Bagged	038753339252	20 Pcs
33926	3/4" x 50'	Plastic Hanger Strap – Bagged	038753339269	20 Pcs
33927	3/4" x 100'	Plastic Hanger Strap – Bagged	038753339276	20 Pcs
33928	3/4" x 10'	Plastic Hanger Strap – Bagged	038753339283	12 Pcs



**MASTERS® Suspension Strapping**

- Wavy design for easy bending.
- Available in various gauges, lengths and materials.

Product No.	Size	Description	UPC	Ctn. Qty.
<b>COPPER</b>				
SC222550	22 gauge 25' x 0.50"	MASTERS Strapping Copper	067001004116	20
SC241075	24 gauge 10' x 0.75"	MASTERS Strapping Copper	067001004123	34
SC242575	24 gauge 25' x 0.75"	MASTERS Strapping Copper	067001004130	20
<b>COPPER CLAD</b>				
SCC242575	24 gauge 25' x 0.75"	MASTERS Strapping Copper Clad	067001004154	20
<b>STRAPPING GALVANIZED</b>				
SG202575	20 gauge 25' x 0.75"	MASTERS Strapping Galvanized	067001004178	20
SG241075	24 gauge 10' x 0.75"	MASTERS Strapping Galvanized	067001004192	34
SG242550	24 gauge 25' x 0.50"	MASTERS Strapping Galvanized	067001004208	20
SG242575	24 gauge 25' x 0.75"	MASTERS Strapping Galvanized	067001004215	20
SG2410075	24 gauge 100' x 0.75"	MASTERS Strapping Galvanized	067001004185	12
<b>STRAPPING NYLON COATED</b>				
ST221050COATED	22 gauge 10' x 0.50"	MASTERS Strapping Nylon Coated	067001004499	20
<b>STEEL</b>				
ST202575	20 gauge 25' x 0.75"	MASTERS Strapping Steel	67001004277	20
ST222550	22 gauge 25' x 0.50"	MASTERS Strapping Steel	067001004307	20
ST241075	24 gauge 10' x 0.75"	MASTERS Strapping Steel	067001004338	34
ST242575	24 gauge 25' x 0.75"	MASTERS Strapping Steel	067001004345	20
ST2410075	24 gauge 100' x 0.75"	MASTERS Strapping Steel	067001004321	12





### **SAFETY SERIES**

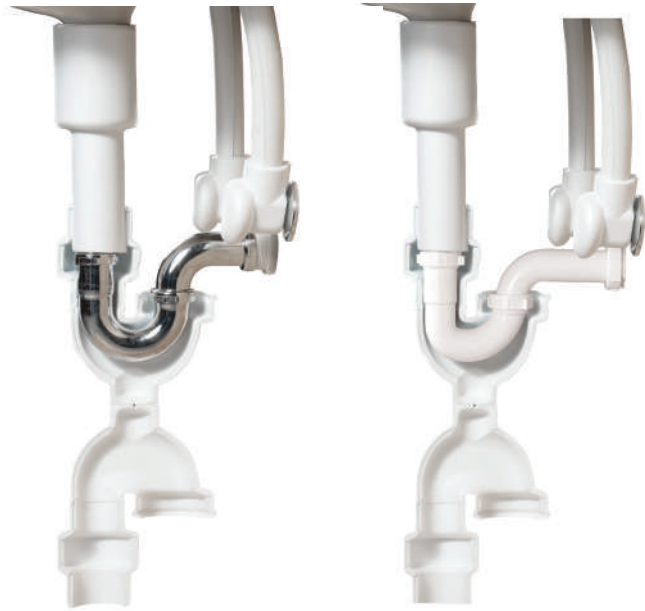

# Category 15

## **Brass/Plastic Tubular, Grab Bars & Pipe Wrap**

Known for tubular throughout North America, Dearborn Brass has been a recognized brand in the commercial and residential market for over a century, and offers an extensive line of grab bars in Peened – textured for better grip – and Satin finishes.

## BRASS TUBULAR



### Dearborn® Tubular Low-Inlet P-Traps

Product No.	Size	Description	UPC	Ctn. Qty.
711A-1	1-1/4"	Low-Inlet P-Trap 17 gauge brass	041193123992	10
714A-1	1-1/2"	Low-Inlet P-Trap 17 gauge brass	041193124005	10



### Dearborn® Extension Tubes

Product No.	Size	Description	UPC	Ctn. Qty.
793A-17BN-1	1-1/2" x 12"	Extension Tube with Slip Joint 17 gauge brass w/Nut	041193125835	10
793A-20-1	1-1/2" x 12"	Extension Tube with Slip Joint 20 gauge brass	041193125842	10
793A-17-1	1-1/2" x 12"	Extension Tube with Slip Joint 17 gauge brass	041193055248	10



### Dearborn® Semi-Cast Grid Patent Outlet Plugs With Overflow

Product No.	Size	Description	UPC	Ctn. Qty.
760-1		Semi-Cast Grid Patent Overflow Plug w/ 1-1/4" x 6" - 17 Ga. Tailpiece	041193124777	25
760W-1		Semi-Cast Grid Wheelchair Patent Overflow Plug w/ 1-1/4" - 17 Ga. Tailpiece	041193124821	10

## BARRIER-FREE LAVATORY TUBULAR COVERS

### Dearborn® Safety Series Lavatory Tubular Covers

- For under-lavatory exposed plumbing in bathrooms.
- Universal offering to cover brass, plastic, and Schedule 40 tubular.
- Hook and loop fasteners make installation fast and simple.
- EVA Foam is easy to cut, size, and measure to fit.
- Easily accommodates offset supply lines.
- Clean appearance and aesthetics.
- Accommodates trap with and without cleanouts.
- Securely fits both 1-1/4" and 1-1/2" tubular systems.



Product No.	Description	UPC	Ctn. Qty.
ADA094	Single Supply Line and Valve Cover (1 each)	041193000927	10
ADA095	Extension Tube Cover	041193000903	10
ADA097	Offset Grid Drain Covers	041193000897	10
ADA098	Two Supply Line and Valve Covers (2 each)	041193000880	10
ADA099	Universal Plastic & Brass P-Trap and Straight Grid Drain Cover Kit	041193000873	10
ADA100	Universal P-Trap Full Cover Kit, Offset Grid Drain, Two Supply Line and Valve Covers	041193000859	10
ADA101	Universal P-Trap Full Cover Kit. Straight Grid Drain. Two Supply Lines and Valve Covers	041193000866	10
ADA103	Schedule 40 P-Trap and Straight Grid Drain Cover Kit	041193000743	10
ADA104	Schedule 40 P-Trap Full Cover Kit, Single Supply Line and Valve Cover	041193000828	10
ADA105	Schedule 40 P-Trap Full Cover Kit, Two Supply Line & Valve Cover	041193000835	10
ADA106	Universal Plastic and Brass Offset Waste Arm Cover Kit	041193000958	10
ADA107	Universal Plastic and Brass Center and End Outlet Waste Cover Kit	041193000965	10
ADA108	Universal Plastic and Sink Trap (Mass Code) and Straight Grid Drain Cover Kit	041193000972	10
ADA110	Universal P-Trap Full Cover Kit Straight Grid Drain, Single Supply Line and Valve Cover	041193001047	10

**BRASS GRAB BARS**



**Dearborn® Grab Bars with Concealed Flanges, Peened Finish**

Product No.	Size	Description	UPC	Ctn. Qty.
DB8712P	1-1/4" x 12"	Stainless Steel Grab Bar w/Concealed Flange, Peened Finish	041193013538	4
DB8716P	1-1/4" x 16"	Stainless Steel Grab Bar w/Concealed Flange, Peened Finish	041193013545	4
DB8736P	1-1/4" x 36"	Stainless Steel Grab Bar w/Concealed Flange, Peened Finish	041193013637	4
DB8924P	1-1/2" x 24"	Stainless Steel Grab Bar w/Concealed Flange, Peened Finish	041193013798	4
DB8936P	1-1/2" x 36"	Stainless Steel Grab Bar w/Concealed Flange, Peened Finish	041193013828	4
DB8948P	1-1/2" x 48"	Stainless Steel Grab Bar w/Concealed Flange, Peened Finish	041193013859	4



**Dearborn® Grab Bars with Concealed Flanges, Satin Finish**

Product No.	Size	Description	UPC	Ctn. Qty.
DB8712	1-1/4" x 12"	Stainless Steel Grab Bar w/ Concealed Flange, Satin Finish	041193008732	4
DB8718	1-1/4" x 18"	Stainless Steel Grab Bar w/ Concealed Flange, Satin Finish	041193008800	4
DB8724	1-1/4" x 24"	Stainless Steel Grab Bar w/ Concealed Flange, Satin Finish	041193008862	4
DB8736	1-1/4" x 36"	Stainless Steel Grab Bar w/ Concealed Flange, Satin Finish	041193008947	4
DB8742	1-1/4" x 42"	Stainless Steel Grab Bar w/ Concealed Flange, Satin Finish	041193008954	4
DB8912	1-1/2" x 12"	Stainless Steel Grab Bar w/ Concealed Flange, Satin Finish	041193009005	4
DB8918	1-1/2" x 18"	Stainless Steel Grab Bar w/ Concealed Flange, Satin Finish	041193009029	4
DB8924	1-1/2" x 24"	Stainless Steel Grab Bar w/ Concealed Flange, Satin Finish	041193009043	4
DB8936	1-1/2" x 36"	Stainless Steel Grab Bar w/ Concealed Flange, Satin Finish	041193009128	4
DB8942	1-1/2" x 42"	Stainless Steel Grab Bar w/ Concealed Flange, Satin Finish	041193009135	4
DB8948	1-1/2" x 48"	Stainless Steel Grab Bar w/ Concealed Flange, Satin Finish	041193009142	4





# Category 16

## Bath Waste and Overflow

True Blue was thoughtfully designed for pros with a variety of cutting-edge features, like integrated locking components that simplify installation, and quarter-turn test plugs that make testing quick and painless.



#F16P9860CP shown



#F16P9860CPD shown

**Dearborn® True Blue™ Full Kit**

Product No.	Description	UPC	Ctn. Qty
<b>PVC</b>			
P9850CP	True Blue PVC Full Kit, Touch Toe Stopper, w/ Test Kit CHR	041193104908	10
P9850BNPS	True Blue PVC Full Kit, Touch Toe Stopper, w/ Test Kit BN	041193104915	10
P9850RBPS	True Blue PVC Full Kit, Touch Toe Stopper, w/ Test Kit ORB	041193104922	10
P9840BNPS	True Blue PVC Full Kit, Push & Pull Stopper w/ Test Kit BN	041193462220	10
P9840RBPS	True Blue PVC Full Kit, Push & Pull Stopper w/ Test Kit ORB	041193462244	10
P9860CP	True Blue PVC Full Kit, Uni-Lift Stopper, w/ Test Kit CHR	041193104939	10
P9860BNPS	True Blue PVC Full Kit, Uni-Lift Stopper, w/ Test Kit BN	041193104946	10
P9860RBPS	True Blue PVC Full Kit, Uni-Lift Stopper, w/ Test Kit ORB	041193104953	10

**ABS**

A9850CP	True Blue ABS Full Kit, Touch Toe Stopper, w/ Test Kit CHR	041193104847	10
A9850BNPS	True Blue ABS Full Kit, Touch Toe Stopper, w/ Test Kit BN	041193104854	10
A9850RBPS	True Blue ABS Full Kit, Touch Toe Stopper, w/ Test Kit ORB	041193104861	10
A9840BNPS	True Blue ABS Full Kit, Push & Pull Stopper w/ Test Kit BN	041193462107	10
A9840RBPS	True Blue ABS Full Kit, Push & Pull Stopper w/ Test Kit ORB	041193462121	10
A9860CP	True Blue ABS Full Kit, Uni-Lift Stopper, w/ Test Kit CHR	041193104878	10
A9860BNPS	True Blue ABS Full Kit, Uni-Lift Stopper, w/ Test Kit BN	041193104885	10
A9860RBPS	True Blue ABS Full Kit, Uni-Lift Stopper, w/ Test Kit ORB	041193104892	10

**Dearborn® True Blue™ Flexible Neck Bathwaste Kit - Full**

Product No.	Description	UPC	Ctn. Qty
F16P9850CP	16" True Blue FLEX PVC Full Kit, Touch Toe Stopper, w/ Test, CHR	041193462923	10
F16P9850BN	16" True Blue FLEX PVC Full Kit, Touch Toe Stopper, w/ Test, BN	041193462930	10
F16P9850RB	16" True Blue FLEX PVC Full Kit, Touch Toe Stopper, w/ Test, ORB	041193462947	10
F16P9850CPD	16" True Blue FLEX PVC Full Kit, Touch Toe Stopper, w/ Test, CHR, Direct Drain	041193463104	10
F16P9850CPZ	16" True Blue FLEX PVC Full Kit, Touch Toe Stopper, w/ Test, CHR, Zinc	041193462954	10
F24P9850CP	24" True Blue FLEX PVC Full Kit, Touch Toe Stopper, w/ Test, CHR	041193463036	10
F24P9850BN	24" True Blue FLEX PVC Full Kit, Touch Toe Stopper, w/ Test, BN	041193463043	10
F24P9850RB	24" True Blue FLEX PVC Full Kit, Touch Toe Stopper, w/ Test, ORB	041193463050	10
F16P9860CP	16" True Blue FLEX PVC Full Kit, Uni-Lift Stopper, w/ Test, CHR	041193462886	10
F16P9860BN	16" True Blue FLEX PVC Full Kit, Uni-Lift Stopper, w/ Test, BN	041193462893	10
F16P9860RB	16" True Blue FLEX PVC Full Kit, Uni-Lift Stopper, w/ Test, ORB	041193462909	10
F16P9860CPD	16" True Blue FLEX PVC Full Kit, Uni-Lift Stopper, w/ Test, CHR, Direct Drain	041193463098	10
F16P9860CPZ	16" True Blue FLEX PVC Full Kit, Uni-Lift Stopper, w/ Test, CHR, Zinc	041193462916	10
F24P9860CP	24" True Blue FLEX PVC Full Kit, Uni-Lift Stopper, w/ Test, CHR	041193463005	10
F24P9860BN	24" True Blue FLEX PVC Full Kit, Uni-Lift Stopper, w/ Test, BN	041193463012	10
F24P9860RB	24" True Blue FLEX PVC Full Kit, Uni-Lift Stopper, w/ Test, ORB	041193463029	10

## BATH WASTE AND OVERFLOW

### Dearborn® True Blue™ Half Kit

**Product No. Description UPC Ctn. Qty**

#### PVC

P9950	True Blue PVC Half Kit, Touch Toe Stopper, no Test Kit, CHR	041193105042	10
P9950CP	True Blue PVC Half Kit, Touch Toe Stopper, w/ Test Kit, CHR	041193105059	10
P9950BNPS	True Blue PVC Half Kit, Touch Toe Stopper, w/ Test Kit, BN	041193105066	10
P9950RBPS	True Blue PVC Half Kit, Touch Toe Stopper, w/ Test Kit, ORB	041193105073	10
P9950RB	True Blue PVC Half Kit, Touch Toe Stopper, w/ Test Kit, ORB	041193105073	10
P9950WHPS	True Blue PVC Half Kit, Touch Toe Stopper, w/ Test Kit, WH	041193343314	10
P9950MBPS	True Blue PVC Half Kit, Touch Toe Stopper, w/ Test Kit, MB	041193462725	10
P9940BNPS	True Blue PVC Half Kit, Push & Pull Stopper, w/ Test Kit, BN	041193462589	10
P9940RBPS	True Blue PVC Half Kit, Push & Pull Stopper, w/ Test Kit, ORB	041193462602	10
P9940WHPS	True Blue PVC Half Kit, Push & Pull Stopper, w/ Test Kit, WH	041193462626	10
P9940MBPS	True Blue PVC Half Kit, Push & Pull Stopper, w/ Test Kit, MB	041193462640	10
P9960	True Blue PVC Half Kit, Uni-Lift Stopper, no Test Kit, CHR	041193105080	10
P9960CP	True Blue PVC Half Kit, Uni-Lift Stopper, w/ Test Kit, CHR	041193105097	10
P9960CPC	True Blue PVC Half Kit, Uni-Lift Stopper, w/ Test Kit, CHR, Condensate Elbow	041193105332	10
P9960CPD	True Blue PVC Half Kit, Uni-Lift Stopper, w/ Test Kit, CHR, Direct Drain	041193105356	10
P9960BNPS	True Blue PVC Half Kit, Uni-Lift Stopper, w/ Test Kit, BN	041193105103	10
P9960RBPS	True Blue PVC Half Kit, Uni-Lift Stopper, w/ Test Kit, ORB	041193105110	10
P9960CPZ	True Blue PVC Half Kit, Uni-Lift Stopper, w/ Test Kit, Zinc CHR	041193105233	10
P9960WHPS	True Blue PVC Half Kit, Uni-Lift Stopper, w/ Test Kit, WH	041193343338	10
P9960MBPS	True Blue PVC Half Kit, Uni-Lift Stopper, w/ Test Kit, MB	041193343345	10

#### ABS

A9950	True Blue ABS Half Kit, Touch Toe Stopper, no Test Kit, CHR	041193104960	10
A9950CP	True Blue ABS Half Kit, Touch Toe Stopper, w/ Test Kit, CHR	041193104977	10
A9950BNPS	True Blue ABS Half Kit, Touch Toe Stopper, w/ Test Kit, BN	041193104984	10
A9950RBPS	True Blue ABS Half Kit, Touch Toe Stopper, w/ Test Kit, ORB	041193104991	10
A9950WHPS	True Blue ABS Half Kit, Touch Toe Stopper, w/ Test Kit, WH	041193343215	10
A9950MBPS	True Blue ABS Half Kit, Touch Toe Stopper, w/ Test Kit, MB	041193343222	10
A9940BNPS	True Blue ABS Half Kit, Push & Pull Stopper, w/ Test Kit, BN	041193462343	10
A9940RBPS	True Blue ABS Half Kit, Push & Pull Stopper, w/ Test Kit, ORB	041193462367	10
A9940WHPS	True Blue ABS Half Kit, Push & Pull Stopper, w/ Test Kit, WH	041193462381	10
A9940MBPS	True Blue ABS Half Kit, Push & Pull Stopper, w/ Test Kit, MB	041193462404	10
A9960	True Blue ABS Half Kit, Uni-Lift Stopper, no Test Kit CHR	041193105004	10
A9960CP	True Blue ABS Half Kit, Uni-Lift Stopper, w/ Test Kit CHR	041193105011	10
A9960CPC	True Blue ABS Half Kit, Uni-Lift Stopper, w/ Test Kit, CHR, Condensate Elbow	041193105325	10
A9960CPD	True Blue ABS Half Kit, Uni-Lift Stopper, w/ Test Kit, CHR, Direct Drain	041193105349	10
A9960BNPS	True Blue ABS Half Kit, Uni-Lift Stopper, w/ Test Kit BN	041193105028	10
A9960RBPS	True Blue ABS Half Kit, Uni-Lift Stopper, w/ Test Kit ORB	041193105035	10
A9960CPZ	True Blue ABS Half Kit, Uni-Lift Stopper, w/ Test Kit Zinc CHR	041193105226	10
A9960WHPS	True Blue ABS Half Kit, Uni-Lift Stopper, w/ Test Kit WH	041193343239	10
A9960MBPS	True Blue ABS Half Kit, Uni-Lift Stopper, w/ Test Kit Zinc MB	041193343246	10



#P9960CP  
shown



#A9950CP  
shown

CATEGORY 16 BATH WASTE AND OVERFLOW



#P9975 shown



#A9975 shown



#F16P9975 shown

**Dearborn® True Blue™ Rough Kit**

Product No.	Description	UPC	Ctn. Qty
<b>PVC</b>			
P9970	True Blue PVC Rough Kit, No Test Kit, CHR	041193105141	10
P9975	True Blue PVC Rough Kit, w/ Test Kit, CHR	041193105158	10
P9975Z	True Blue PVC Rough Kit, w/ Test Kit, Zinc CHR	041193105257	10
P9975C	True Blue PVC Rough Kit, w/ Test Kit, CHR, Zinc, Condensate Elbow	041193105264	10
P9975C	True Blue PVC Rough Kit, w/ Test Kit, CHR, Zinc Condensate Elbow	041193105288	10
P9975D	True Blue PVC Rough Kit, w/ Test Kit, CHR, Direct Drain	041193105295	10
P9975ZD	True Blue PVC Rough Kit, w/ Test Kit, CHR, Zinc, Direct Drain	041193105318	10
<b>ABS</b>			
A9970	True Blue ABS Rough Kit, No Test Kit, CHR	041193105127	10
A9975	True Blue ABS Rough Kit, w/ Test Kit, CHR	041193105134	10
A9975Z	True Blue ABS Rough Kit, w/ Test Kit, Zinc CHR	041193105240	10
A9975C	True Blue ABS Rough Kit, w/ Test Kit, CHR, Condensate Elbow	041193105271	10
A9975D	True Blue ABS Rough Kit, w/ Test Kit, CHR, Direct Drain	041193105301	10

**Dearborn® True Blue™ Flexible Neck Bathwaste Kits - Rough**

Product No.	Description	UPC	Ctn. Qty
F16P9975	16" True Blue FLEX PVC Rough Kit w/ Test, CHR	041193463128	10
F24P9975	24" True Blue FLEX PVC Rough Kit w/ Test, CHR	041193463135	10
F16P9975Z	16" True Blue FLEX PVC Rough Kit w/ Test, CHR, Zinc	041193463142	10
F24P9975Z	24" True Blue FLEX PVC Rough Kit w/ Test, CHR, Zinc	041193463159	10
F16P9975D	16" True Blue FLEX PVC Rough Kit w/ Test, CHR, Direct Drain	041193463166	10
F24P9975D	24" True Blue FLEX PVC Rough Kit w/ Test, CHR, Direct Drain	041193463173	10
F16P9975ZD	16" True Blue FLEX PVC Rough Kit w/ Test, CHR, Direct Drain, Zinc	041193463180	10
F24P9975ZD	24" True Blue FLEX PVC Rough Kit w/ Test, CHR, Direct Drain, Zinc	041193463197	10
F25P9975D	25" True Blue FLEX PVC Rough Kit w/Test, CHR, Direct Drain	041193463203	10



#K97BN shown

**Dearborn® True Blue™ Touch Toe Trim Kit**

Product No.	Description	UPC	Ctn. Qty
K97CP	True Blue Trim Kit, Touch Toe, CHR, No Veneer Included	041193105165	10
K97BN	True Blue Trim Kit, Touch Toe, BN	041193105172	10
K97RB	True Blue Trim Kit, Touch Toe, ORB	041193105189	10
K97WH	True Blue Trim Kit, Touch Toe, WH	041193343413	10
K97MB	True Blue Trim Kit, Touch Toe, MB	041193343420	10



#K98CP shown

**Dearborn® True Blue™ Uni-Lift Trim Kit**

Product No.	Description	UPC	Ctn. Qty
K98CP	True Blue Trim Kit, Uni-Lift, CHR, No Veneer Included	041193105196	10
K98BN	True Blue Trim Kit, Uni-Lift, BN	041193105202	10
K98RB	True Blue Trim Kit, Uni-Lift, ORB	041193105219	10
K98WH	True Blue Trim Kit, Uni-Lift, WH	041193343437	10
K98MB	True Blue Trim Kit, Uni-Lift, MB	041193343444	10



#4516-1 shown



# 4516-3 shown



#4516-4 shown



#4516-6 shown



#4516-10 shown

**Dearborn® True Blue™ Replacement Parts**

Product No.	Description	UPC	Ctn. Qty.
4516-1	True Blue Brass Drain Spud	041193115874	10
4516-2	True Blue Drain Elbow Gasket	041193115805	100 (10 per bag)
4516-3	True Blue Overflow Washer	041193115423	120 (20 per bag)
4516-4	True Blue Drain & Overflow Test Plugs	041193115867	100 (5 each per bag)
4516-5	True Blue Zinc Drain Spud	041193115850	10
4516-6	True Blue Trim Veneer, BN	041193115843	10
4516-7	True Blue Trim Veneer, ORB	041193115836	10
4516-8	True Blue Overflow Faceplate, BN	041193115829	10
4516-9	True Blue Overflow Faceplate, ORB	041193115812	10
4516-10	True Blue Overflow Faceplate, CHR	041193115881	10



#P7224B shown

**Dearborn® Schedule 40 Bath Waste Touch Toe Half Kits**

Product No.	Description	UPC	Ctn. Qty.
P7725	DBlue Half Kit, Schedule 40 - PVC Touch-Toe Stopper w/ Chrome Finish Trim and Test Plug	041193006844	20
A7725BN	DBlue Half Kit, Schedule 40 - ABS Touch-Toe Stopper w/ Brushed Nickel Finish Trim and Test Plug	041193007162	20



#A7725B shown

**Dearborn® Schedule 40 Bath Waste Uni-Lift Half Kits**

Product No.	Size	Description	UPC	Ctn. Qty.
A7225B		DBlue Half Kit, Schedule 40 - ABS Uni-Lift Stopper w/ Chrome Finish Trim	041193095183	20
P7325		DBlue Half Kit, Schedule 40 - PVC Uni-Lift Stopper w/ Chrome Finish Trim and Test Plug	041193006783	20
A7325		DBlue Half Kit, Schedule 40 - ABS Uni-Lift Stopper w/ Chrome Finish Trim and Test Plug	041193006820	20
A7325RB		DBlue Half Kit, Schedule 40 - ABS Uni-Lift Stopper w/ Oil Rubbed Bronze Finish Trim And Test Plug	041193006899	20
A7325BN		DBlue Half Kit, Schedule 40 - ABS Uni-Lift Stopper w/ Brushed Nickel Finish Trim And Test Plug	041193007056	20
A7325BZ		DBlue Half Kit, Schedule 40 - ABS Uni-Lift Stopper w/ Chrome Finish Trim w/ Zinc Spud and Test Plug	041193732545	20



#P7223RK shown

**Dearborn® Schedule 40 Bath Waste Rough-In Kits**

Product No.	Size	Description	UPC	Ctn. Qty.
A7223RK		DBlue Rough-In Kit, Schedule 40 - ABS	041193016652	30



**Dearborn® Schedule 40 Bath Waste Quarter Kit**

Product No.	Size	Description	UPC	Ctn. Qty.
P3225D		DBlue Quarter Kit, Schedule 40 - PVC Uni-Lift Stopper w/ Chrome Finish Trim Direct Drain	041193005885	20

**Dearborn® Bath Waste DBLue Trim Kits - Coarse Thread**



*K22BN shown*

Product No.	Size	Description	UPC	Ctn. Qty.
K22TB		DBLue Trim Kit, for Schedule 40 - Rough-In Kit Uni-Lift Stopper w/ Chrome Finish Trim	041193006745	10
K22BN		DBLue Trim Kit, for Schedule 40 - Rough-In Kit Uni-Lift Stopper w/ Brushed Nickel Finish Trim	041193007308	10
K22WH		DBLue Trim Kit, for Schedule 40 - Rough-In Kit Uni-Lift Stopper w/ White Finish Trim	041193007032	10
K23TB		DBLue Trim Kit, for Schedule 40 - Rough-In Kit Touch-Toe Stopper w/ Chrome Finish Trim	041193006776	10
K23BN		DBLue Trim Kit, for Schedule 40 - Rough-In Kit Touch-Toe Stopper w/ Brushed Nickel Finish Trim	041193007315	10



*Chrome Finish Trim Kits do not include spud*

**Dearborn® Bath Waste Trim Kits - Coarse Thread**

Product No.	Size	Description	UPC	Ctn. Qty.
K25TB		DBLue Trim Kit, for Schedule 40 - Rough-In Kit Uni-Lift Stopper w/ Chrome Finish Trim, Plug Only	041193026330	10



**Dearborn® Cable Bath Waste Conversion Kit**

Product No.	Size	Description	UPC	Ctn. Qty.
K20		DBLue Conversion Kit, Cable Stopper w/Chrome Finish Trim	041193026149	2



**Dearborn® Bath Waste Conversion Kits**

Product No.	Size	Description	UPC	Ctn. Qty.
K27		DBLue Conversion Kit, Uni-Lift Stopper w/ Chrome Finish Trim	041193026477	2
K27BN		DBLue Conversion Kit, Uni-Lift Stopper w/ Brushed Nickel Finish Trim	041193026545	2
K27PB		DBLue Conversion Kit, Uni-Lift Stopper w/ UltraShine® Polished Brass Finish Trim	041193026484	2
K27RB		DBLue Conversion Kit, Uni-Lift Stopper w/ Rubbed Bronze Finish Trim	041193026521	2
K27SC		DBLue Conversion Kit, Uni-Lift Stopper w/ UltraShine® Satin Chrome Finish Trim	041193026538	2
K27SN		DBLue Conversion Kit, Uni-Lift Stopper w/ UltraShine® Satin Nickel Finish Trim	041193026514	2
K28BN		Conversion Kit, w/ Two-Hole Cover Plate, Uni-Lift Stopper w/ Brushed Nickel Finish Trim	041193004253	2



# Category 17

## Strainers

Dearborn® Brass offers the widest variety of Basket and Sink Strainers in the industry. These include Standard and Economy; Locking Cup; Easy Mount; Threaded Body and Bar Sink Strainers. Available in chrome plated brass, stainless steel and decorative plastic materials.





**Dearborn® Rubber Neck Escutcheon**

- Fits comfortably 1/2" and 3/4" pipe.
- Durable material that is non-corrosive and mold resistant.
- Hide blemishes from your customer and add a layer of protection against critters from entering the structure.

Product No.	Size	Description	UPC	Ctn. Qty.
1101R	1/2 – 3/4"	Rubber Neck Escutcheon	041193007179	25



**Dearborn® Chrome Plated Plastic Sleeve**

Product No.	Size	Description	UPC	Ctn. Qty.
1119	1/2"	Chrome Plated Plastic Sleeve (4 in Bag)	041193007186	25 Bags



**Dearborn® Shallow Locking Cup Sink Basket Strainer**

- Shallow Locking Cup Sink Basket Strainer is ideal for use on deep cast iron sinks. Features a stainless steel body and basket.
- Locking cup included.
- 4" Chrome plated stainless steel tailpiece. Neoprene rubber stopper.

Product No.	Size	Description	UPC	Ctn. Qty.
14T	2-3/4"	Shallow Cup Basket Strainer, Stainless Steel Body	041193102140	24



**Dearborn® Spin-N-Lock Sink Basket Strainer**

- Ideal for a 4" commercial sink drain.
- Extra thick washer and wide locknut.
- Heavy duty stainless steel body and basket.

Product No.	Size	Description	UPC	Ctn. Qty.
17		Spin-N-Lock Sink Basket Strainer, Stainless Steel Body w/ Stainless Steel Screw-In Basket	041193050823	24



# Category 18

## Pneumatic Pipe Plugs

Cherne® pneumatic Test-Ball® and Muni-Ball® pipe plugs have been the contractor's choice for more than 60 years. Used in residential DWV systems and sanitary/storm sewers, Cherne® pneumatic pipe plugs do it all! Larger sizes are available with our patented Rupture Disc Technology, which prevents over-inflation. This eliminates plug damage due to over-inflation and enhances user safety.

# THE GLOBAL LEADER IN PIPE PLUG & TESTING



Cherne Industries recently completed an historic move into a newly constructed, 130,000-square-foot facility located in Shakopee, MN. Situated 25 miles southwest of downtown Minneapolis, this state-of-the-art facility features integrated robotic manufacturing with a new R&D lab for product testing, and extensive customer training facilities. The move to Shakopee also taps into a wide cross-section of skilled technical personnel. The new building fortifies Cherne's capabilities as a world-class, industry-leading solution for our end users.



**test with the best**

CATEGORY **18** PNEUMATIC PIPE PLUGS

FEATURED PRODUCTS



**Cherne® Single-Size Test-Ball® Plugs (Plumbing)**

Designed to test DWV systems, Cherne Test-Ball® plugs can be used in any type of pipe.

- Made of natural rubber for excellent expansion and memory.
- Seals both round and out-of-round pipe.
- Zinc-plated steel chain and ring handle acts as an anchor to prevent plug from sliding down a line.
- Fits easily through test tees, sanitary tees, floor drains, and other “tight” situations.
- Broader expansion range than mechanical plugs.

Product No.	Size	Description	Ctn. Qty.	Back Pressure P.S.I.	Feet of Head
270008	3/4"-1-1/4"	Test-Ball® Plug	6	17 PSI	40 FT
270016	1-1/4"-1-1/2"	Test-Ball® Plug	6	13 PSI	30 FT
270024	2"	Test-Ball® Plug	6	13 PSI	30 FT
270108	2-1/2"	Test-Ball® Plug	6	13 PSI	30 FT
270032	3"	Test-Ball® Plug	6	13 PSI	30 FT
270040	4"	Test-Ball® Plug	6	13 PSI	30 FT
270059	5"	Test-Ball® Plug	1	13 PSI	30 FT
270067	6"	Test-Ball® Plug	1	13 PSI	30 FT



#240028 Bulk Pack shown



#240018 shown

**Cherne® Bulk Test-Ball® Plugs – Individual Display Bags\***

- Same great Test-Ball® plug in bulk packaging.
- Preprinted bag designed for use with peg hook displays.

*\* Bulk Test-Ball® Plugs MUST be ordered in quantities of 24 plugs.*

Product No.	Size	Description	Ctn. Qty.	Back Pressure P.S.I.	Feet of Head
240018	1-1/4"-1-1/2"	Test-Ball® Plug	24	13 PSI	30 FT
240028	2"	Test-Ball® Plug	24	13 PSI	30 FT
240038	3"	Test-Ball® Plug	24	13 PSI	30 FT
240048	4"	Test-Ball® Plug	24	13 PSI	30 FT



**Cherne® Multi-Size Test-Ball® Plugs (Plumbing)**

The multi-size yellow-top Test-Ball(R) plugs have the same great features as the original and are ideal for multiple pipe sizes.

- One size fits multiple pipe diameters, doing the job of 2+ single-size plugs.
- Use to block flow (water DWV test) or as a back plug for sewer air testing.
- Seals both round and out-of-round pipe.
- Zinc-plated steel chain and ring handle acts as an anchor to prevent plug from sliding down a line.

Product No.	Size	Description	Ctn. Qty.	Back Pressure P.S.I.	Feet of Head
276128	1-1/4"-2"	Test-Ball® Plug	6	17 PSI	40 FT
276238	2"- 3"	Test-Ball® Plug	6	17 PSI	40 FT
276348	3"- 4"	Test-Ball® Plug	6	17 PSI	40 FT
276468	4"- 6"	Test-Ball® Plug	1	17 PSI	40 FT



#271047 shown

### Cherne® Long Test-Ball® Plugs

- Designed for waste stack testing from floor drain to sewer pipe.
- Long enough to seal wye vertical riser and sewer run.
- Includes 3' extension hose.
- Ring and chain assembly prevents plug from sliding down a line.

Product No.	Size	Description	Ctn. Qty.	Back Pressure P.S.I.	Feet of Head
271020	2"	Long Test-Ball® Plug	1	13 PSI	30 FT
271039	3"	Long Test-Ball® Plug	1	13 PSI	30 FT
271047	4"	Long Test-Ball® Plug	1	13 PSI	30 FT
271063	6"	Long Test-Ball® Plug	1	13 PSI	30 FT
271098	4" - 6"	Long Test-Ball® Plug	1	13 PSI	30 FT



#274526 shown

### Cherne® MS2® Long Test-Ball® Plugs

Multi-size design for use in various pipe diameters.

- Designed for waste stack testing from floor drain to sewer pipe.
- Long enough to seal wye vertical riser and sewer run.
- Multi-stage deflation eliminates backsplash.
- Works in multiple pipe diameters.
- Pressure relief valve to safeguard against over-inflation.
- Nylon strap and safety handle prevents plug from sliding down a line.
- Includes 5' extension hose.

Product No.	Size	Description	Ctn. Qty.	Back Pressure P.S.I.	Feet of Head
274518	2" - 3"	MS2® Plug	1	13 PSI	30 FT
274526	3" - 4"	MS2® Plug	1	13 PSI	30 FT
274534	4" - 6"	MS2® Plug	1	13 PSI	30 FT



### Cherne® Clean-Seal® Plugs

Designed for stack testing of drain, waste, and vent plumbing systems.

- Threads into test tee, eliminating water backsplash.
- Removable snifter valve inflation fitting is replaceable.
- Made from long-lasting natural rubber.
- Seals both cast-iron and plastic pipe

Product No.	Size	Description	Ctn. Qty.	Back Pressure P.S.I.	Feet of Head
271508	1-1/2"	Clean-Seal® Plug	6	13 PSI	30 FT
271705	2"	Clean-Seal® Plug	6	13 PSI	30 FT
271713	3"	Clean-Seal® Plug	6	13 PSI	30 FT
271721	4"	Clean-Seal® Plug	6	13 PSI	30 FT
271758	6"	Clean-Seal® Plug	1	13 PSI	30 FT



#262010 shown

### Cherne® Single-Size Original Muni-Ball® Plugs

Muni-Ball® plugs offer a full bypass allowing both testing and monitoring of pipe systems. Ideal for installation and repair of residential, commercial, or municipal infrastructure including sanitary and storm sewer systems.

- Works in all types of pipe.
- Easily converts to an air test plug with use of a conversion kit.
- Durable natural rubber construction seals the roughest of surfaces.
- 8", 10", 12" and 15"-16" plugs include two port plug for easy use in sewer air tests.
- Threaded aluminum bypass.

Product No.	Size	Description	Ctn. Qty.	Back Pressure P.S.I.	Feet of Head
262008	1-1/2"	Muni-Ball® Plug - 1/4" Bypass	1	22 PSI	50 FT
262010	2"	Muni-Ball® Plug - 1/8" Bypass	1	22 PSI	50 FT
262258	3"	Muni-Ball® Plug - 1/2" Bypass	1	22 PSI	50 FT
262048	4"	Muni-Ball® Plug - 3/4" Bypass	1	22 PSI	50 FT
262064	6"	Muni-Ball® Plug - 1-1/2" Bypass	1	13 PSI	30 FT
262080	8"	Muni-Ball® Plug - 3" Bypass	1	13 PSI	30 FT
262110	10"	Muni-Ball® Plug - 3" Bypass	1	13 PSI	30 FT
262129	12"	Muni-Ball® Plug - 3" Bypass	1	13 PSI	30 FT
262137	15"-16"	Muni-Ball® Plug - 3" Bypass	1	13 PSI	30 FT
262188	18"	Muni-Ball® Plug - 4" Bypass	1	13 PSI	30 FT



#262080 shown

### Cherne® Multi-Size Original Muni-Ball® Plugs

- Work in all types of pipe.
- Durable natural rubber construction seals the roughest of surfaces.
- Threaded aluminum bypass.
- Easily converts to an air test plug with the use of a conversion kit.
- One plug fits multiple pipe diameters.

Product No.	Size	Description	Ctn. Qty.	Back Pressure P.S.I.	Feet of Head
265048	4"- 6"	Muni-Ball® Plug 3/4" Bypass	1	17 PSI	40 FT
265068	6"- 8"	Muni-Ball® Plug 1-1/2" Bypass	1	17 PSI	40 FT
265078	8"- 10"	Muni-Ball® Plug 2" Bypass	1	17 PSI	40 FT



#265068 shown

### Cherne® Multi-Size Test-Ball® Plugs (Underground)

- One plug fits multiple pipe diameters.
- Made of natural rubber for excellent expansion and memory.
- Seals both round and out-of-round pipe.
- Removable inflation valve can be replaced if damaged or replaced with quick disconnect fitting.
- Use to block flow or as a back plug for sewer air testing.

Product No.	Size	Description	Ctn. Qty.	Back Pressure P.S.I.	Feet of Head
275048	4"- 6"	Test-Ball® Plug	1	17 PSI	40 FT
275058	6"- 8"	Test-Ball® Plug	1	17 PSI	40 FT
275088	8"- 12"	Test-Ball® Plug	1	11 PSI	25 FT





### Cherne® Single-Size Test-Ball® Plugs (Underground)

Cherne's single and multi-size test-ball® plugs are our most economical pneumatic plugs for blocking flow to do maintenance in sanitary and storm sewer systems.

- Designed to block sewer flow or for use as a back plug for sewer air testing.
- Natural rubber material for excellent expansion and memory.
- Seals both round and out-of-round pipe.
- Removable inflation valve can be replaced if damaged or replaced with quick disconnect fitting.
- Features an eye-bolt for use with a poly-lift line.

Product No.	Size	Description	Ctn. Qty.	Back Pressure P.S.I.	Feet of Head
041386	8"	Test-Ball® Plug	1	17 PSI	40 FT
041394	10"	Test-Ball® Plug	1	17 PSI	40 FT
041408	12"	Test-Ball® Plug	1	17 PSI	40 FT
041416	15"-16"	Test-Ball® Plug	1	13 PSI	30 FT



### Cherne® AIR-LOC® PLUG

- Industry leading quality, consistency and durability
- Mechanical bonding of premium natural rubber and end plates eliminates failures from chemical bonding
- Improved performance and safety through optimized design
- Superior back pressure (15 psi, 1 bar)
- Premium aesthetics and performance
- Industry first Pressure Relieve Valve engineered specifically for pipe plugs (12"–18" and larger diameter plugs)
- Lightweight, short and flexible

Product No.	Size	Usage Range	Max Back Pressure	Inflation Pressure	Weight (lbs)	Length (in)
317128	6-12"	5.5-12.25"	15 PSI (1 Bar)	45 PSI (3 Bar)	8	25
217128	8-12"	7-12.25"	15 PSI (1 Bar)	45 PSI (3 Bar)	10.4	18.5
217188	12-18"	10.75-18.75"	15 PSI (1 Bar)	45 PSI (3 Bar)	23	25



### Cherne® REMO® PLUG

- Industry leading quality, consistency and durability
- Mechanical bonding of premium natural rubber and end plates eliminates failures from chemical bonding
- Improved performance and safety through optimized design
- Superior back pressure (15 psi, 1 bar)
- Premium aesthetics and performance
- Industry first Pressure Relieve Valve engineered specifically for pipe plugs (12"–18" and larger diameter plugs)
- Lightweight, short and flexible

Product No.	Size	Usage Range	Max Back Pressure	Inflation Pressure	Weight (lbs)	Length (in)
319128	6-12"	5.5-12.25"	15 PSI (1 Bar)	45 PSI (3 Bar)	8.5	25
219128	8-12"	7-12.25"	15 PSI (1 Bar)	45 PSI (3 Bar)	11	18.5
219188	12-18"	10.75-18.75"	15 PSI (1 Bar)	45 PSI (3 Bar)	25	25



**Cherne® Multi-Size High Pressure Plugs**

Cherne's multi-size high pressure plugs are ideal for use in force mains, water mains, industrial lines, or sealing the host pipe up to 150 psi back pressure.

- Multi size use (6 plugs will cover pipe sizes from 4" to 32")
- Unlike single sized products, Cherne's new HP plug has the rubber and metal bonded eliminating fears of separation or rolling off resulting from high backpressures
- Aramid fiber construction
- Optimized design using steel, aramid and natural rubber to ensure longevity and robust construction
- High pressure plugs are designed to be pressurized with water for maximum safety
- Removable and field repairable hardware. Safety/Over-inflation device
- Made in USA

Product No.	Size	Description	Ctn. Qty.	Back Pressure P.S.I.
511088	4-8"	High Pressure Plug with 3/8" bypass	1	150
511128	8-12"	High Pressure Plug with 1-1/2" bypass	1	150
512168	12-16"	High Pressure Plug with 2" bypass	1	150
512208	16-20"	High Pressure Plug with 2" bypass	1	150
512268	20-26"	High Pressure Plug with 2" bypass	1	150
512328	26-32"	High Pressure Plug with 2" bypass	1	150

**WARNING:** This product is only designed for use in water and wastewater applications. If it comes into contact with oil, gas, petroleum, or certain other chemicals, it may rupture, resulting in bodily injury, death, and/or property damage. If there is any question about whether the product is appropriate for your intended application, call Cherne at (800) 843-7584 before using.





**Cherne® I-Series® Plugs**

Cherne's I-Series plugs were designed to meet the needs of both the US and International markets in terms of size and expansion range. Our I-Series plugs have full body cording for added durability.

- Super expansion ranges.
- Small deflated diameters. Plugs through 24"-60" size easily fit through a 24" manhole frame. 48"-72" and 54"-96" plugs fit through 36" openings.
- Bypass opening ranges from 3/4" to 8" diameters.
- Flexible bypass hoses - plugs can bend 90 degrees.
- Protective sleeves available for 12"-24" and plugs 15"-32" and larger.
- Aluminum end plates - minimize corrosion.
- 3/4" eyebolts for improved holding strength.
- Field replaceable rupture disc protect against over inflation.



Product No.	Size	Description	Ctn. Qty.
310088	4-8"	Test Ball® plug	1
310128	6-12"	Test Ball® plug	1
310168	8-16"	Test Ball® plug	1
210188	12-18"	Test Ball® plug	1
310248	12-24"	Test Ball® plug	1
310328	15-32"	Test Ball® plug	1
310488	24-48"	Test Ball® plug	1
310600	24-60"	Test Ball® plug	1
310728	48-72"	Test Ball® plug	1
310968	54-96"	Test Ball® plug	1
311088	4-8"	Muni-Ball® plug w/ 3/4" Bypass	1
311128	6-12"	Muni-Ball® plug w/ 1" Bypass	1
212128	8-12"	Muni-Ball® plug w/ 2" Bypass	1
312168	8-16"	Muni-Ball® plug w/ 2" Bypass	1
214188	12-18"	Muni-Ball® plug w/ 3" Bypass	1
312248	12-24"	Muni-Ball® plug w/ 3" Bypass	1
312328	15-32"	Muni-Ball® plug w/ 2" Bypass	1
314328	15-32"	Muni-Ball® plug w/ 4" Bypass	1
316328	15-32"	Muni-Ball® plug w/ 6" Bypass	1
312418	20-40"	Muni-Ball® plug w/ 2" Bypass	1
314418	20-40"	Muni-Ball® plug w/ 4" Bypass	1
316418	20-40"	Muni-Ball® plug w/ 6" Bypass	1
314488	24-48"	Muni-Ball® plug w/ 4" Bypass	1
316488	24-48"	Muni-Ball® plug w/ 6" Bypass	1
314728	48-72"	Muni-Ball® plug w/ 4" Bypass	1
316728	48-72"	Muni-Ball® plug w/ 6" Bypass	1
318728	48-72"	Muni-Ball® plug w/ 8" Bypass	1
314968	54-96"	Muni-Ball® plug w/ 4" Bypass	1
316968	54-96"	Muni-Ball® plug w/ 6" Bypass	1

Air Loc® plug versions also available. Consult factory.

**BACK PRESSURE DATA: I-Series Plugs**

PLUG SIZE	PIPE DIAMETER																			
	4"	6"	8"	12"	15"	18"	19.35"	21"	24"	30"	36"	42"	48"	54"	60"	66"	72"	84"	96"	
4"-8"	16.7 psi	14.4 psi	13.0 psi																	
6"-12"		23.6 psi	20.9 psi	18.2 psi	-	-	-	-	-	-	-	-	-	-	-	-	-	-	-	-
8"-16"			18.2 psi	14.8 psi	13.4 psi	-	-	-	-	-	-	-	-	-	-	-	-	-	-	-
12"-24"				18.7 psi	16.8 psi	15.2 psi	12.4 psi	14.0 psi	13.0 psi	-	-	-	-	-	-	-	-	-	-	-
15"-32"					18.6 psi	17.6 psi	17.2 psi	16.6 psi	15.4 psi	12.2 psi	-	-	-	-	-	-	-	-	-	-
20"-40"								13.6 psi	12.5 psi	11.2 psi	10.2 psi	8.7 psi	-	-	-	-	-	-	-	-
24"-48"									15.2 psi	13.9 psi	12.8 psi	11.4 psi	10.1 psi	-	-	-	-	-	-	-
24"-60"										15.6 psi	15.2 psi	14.8 psi	14.0 psi	12.6 psi	9.6 psi	6.0 psi	-	-	-	-
40"-60"												15.0 psi	13.0 psi	11.0 psi	8.7 psi	-	-	-	-	-
48"-72"													7.2 psi	6.8 psi	6.4 psi	6.2 psi	6.0 psi	-	-	-
54"-96"															7.3 psi	7.2 psi	6.9 psi	6.8 psi	6.6 psi	6.4 psi

## Point Repair Carriers

### Features

- **New expanded multi-size line** covers pipe sizes from 4"–36" diameters and lengths up to 15' (Custom lengths available).
- **Maximum pipe Contact** guides to ensure proper placement of the repair medium to minimize waste of materials and increase productivity.
- **1/4" NPT Inflation Port** with male quick disconnect for ease of connection.
- Durable, flexible natural **corded rubber**.
- **Bypass design** allows sewage bypass during repair – no need to shut down the line.
- The **flexible design** allows all units to be folded in half for transport.
- **Redesigned integrated caster wheel assembly** optimized for ease of movement along the pipe.



Product No.	For Pipe Size / Diameter	Usage Range (w/o wheels)	Length	Inflation Pressure	Bypass Diameter	Weight (lbs.)	Deflated Diameter (Inside wheel location)	Deflated Diameter (Outside wheel location)
279058	4"-6"	2.9" - 6.25"	5'	45 PSI	NA	10	NA	NA
279108	4"-6"	2.9" - 6.25"	10'	45 PSI	NA	13.5	NA	NA
279158	4"-6"	2.9" - 6.25"	15'	45 PSI	NA	17.5	NA	NA
280058	6"-10"	5" - 10.25"	5'	25 PSI	2"	22	5.13"	5.6"
281058	8"-12"	6.48" - 12.25"	5'	15 PSI	2"	33	7.22"	7.71"
282158	12"-18"	10.33" - 18.25"	15'	15 PSI	2"	81	10.68"	12.61"
283108	18"-24"	16.33" - 24.25"	10'	15 PSI	2"	113	16.57"	19.28"
283158	18"-24"	16.33" - 24.25"	15'	15 PSI	2"	138	16.57"	19.28"
284058	24"-36"	19.3" - 36.25"	5'	15 PSI	4"	107	19.56"	22.28"
284108	24"-36"	19.3" - 36.25"	10'	15 PSI	4"	140.5	19.56"	22.28"
284158	24"-36"	19.3" - 36.25"	15'	15 PSI	4"	182	19.56"	22.28"



# Category 19

## Mechanical Pipe Plugs

Cherne® mechanical test plugs can be used in a wide variety of applications including DWV and stack testing. With a variety of end-of-pipe and in-pipe options available, it's easy to find the right mechanical test plug for the job.

MECHANICAL PIPE PLUGS



**Cherne® Gripper® Mechanical Plugs**

- Ideal for plumbing system tests.
- Easy to install with extra-large wing nut.
- Inside-of-Pipe Gripper Plug seals inside pipe as far as needed.
- Made with glass-reinforced ABS plastic and natural rubber O-Ring.
- End-of-pipe seals only at the end of a pipe, preventing plug from falling into stack.

Product No.	Size	Description	Ctn. Qty.	Back Pressure P.S.I.	Feet of Head
270210	1-1/2"	End of Pipe Gripper® Plug	10	17 PSI	40FT
270229	2"	End of Pipe Gripper® Plug	10	17 PSI	40FT
270237	3"	End of Pipe Gripper® Plug	10	17 PSI	40FT
270245	4"	End of Pipe Gripper® Plug	10	17 PSI	40FT
270261	6"	End of Pipe Gripper® Plug	5	17 PSI	40FT
270270	8"	End of Pipe Gripper® Plug	1	17 PSI	40FT
270296	4"	Inside of Pipe Gripper® Plug	10	17 PSI	40FT
270253	6"	Inside of Pipe Gripper® Plug	5	17 PSI	40FT
270288	8"	Inside of Pipe Gripper® Plug	1	17 PSI	40FT



**Cherne® Hub-Fit Gripper® Plugs**

- Ideal for use in hub fittings and in bell-end pipe.
- Pressure rated for conducting DWV tests.
- Yellow color enhances visibility in pipe.
- Made with glass-reinforced ABS plastic and natural rubber O-ring.

Product No.	Size	Description	Ctn. Qty.	Back Pressure P.S.I.	Feet of Head
270528	2"	Hub-Fit Gripper® Plug	10	13 PSI	30FT
270538	3"	Hub-Fit Gripper® Plug	10	13 PSI	30FT
270548	4"	Hub-Fit Gripper® Plug	10	13 PSI	30FT



**Cherne® Clean-Out Gripper® Plugs**

- Patented threaded O-ring ensures airtight seal.
- Stainless steel hardware prevents corrosion.
- Black color blends well with cast-iron pipe.
- NPT-sized, including hard-to-find 3-1/2".
- Guaranteed to seal most damaged threads.
- Made with glass-reinforced ABS plastic and natural rubber O-ring.

Product No.	Size	Description	Ctn. Qty.	Back Pressure P.S.I.	Feet of Head
270168	2"	Plug Seals 2-1/2" Threaded Opening	10	17 PSI	40FT
270178	3"	Plug Seals 3-1/2" Threaded Opening	10	17 PSI	40FT
270138	3-1/2"	Plug Seals 4" Threaded Opening	10	17 PSI	40FT
270188	4"	Plug Seals 4-1/2" Threaded Opening	10	17 PSI	40FT



**Cherne® T-Handle Aluminum Gripper® Plugs (Underground)**

- Can be used in long-term applications.
- Chemical-resistant neoprene O-ring.
- Made of heavy-duty aluminum body and zinc plated steel T-handle.
- Bypass can be used to conduct sewer air pressure test.

Product No.	Size	Description	Ctn. Qty.	Back Pressure P.S.I.	Feet of Head
272949	6"	Gripper® Plug 1/4" with Bypass	1	17 PSI	40FT
272957	8"	Gripper® Plug 3/4" with Bypass	1	17 PSI	40FT
272965	10"	Gripper® Plug 3/4" with Bypass	1	17 PSI	40FT
272973	12"	Gripper® Plug 3/4" with Bypass	1	13 PSI	30FT
272981	15"	Gripper® Plug 3/4" with Bypass*	1	13 PSI	30FT
272998	18"	Gripper® Plug 3/4" with Bypass*	1	8.7 PSI	20FT

\*Concrete and clay pipe sizes only.



**Cherne® T-Handle Aluminum Gripper® Plugs (Underground)**

- Can be used in long-term applications.
- Chemical-resistant neoprene O-ring.
- Made of heavy-duty aluminum body and zinc plated steel T-handle.

Product No.	Size	Description	Ctn. Qty.	Back Pressure P.S.I.	Feet of Head
272892	6"	Gripper® Plug (Non By-Pass)	1	17 PSI	40FT
272906	8"	Gripper® Plug (Non By-Pass)	1	17 PSI	40FT
272914	10"	Gripper® Plug (Non By-Pass)	1	17 PSI	40FT
272922	12"	Gripper® Plug (Non By-Pass)	1	13 PSI	30FT
272930	15"	Gripper® Plug (Non By-Pass)*	1	13 PSI	30FT
272888	18"	Gripper® Plug (Non By-Pass)*	1	8.7 PSI	20FT

\*Concrete and clay pipe sizes only.



**Cherne® Econ-O-Grip® Plugs**

- Cost-effective method for plugging open-ended pipe.
- Natural rubber O-ring.
- Effective pipe dust cover.
- Not recommended for pressure tests.

Product No.	Size	Description	Ctn. Qty.	Back Pressure P.S.I.	Feet of Head
271519	1-1/2"	Econ-O-Grip® Plug	10	2 PSI	5FT
271527	2"	Econ-O-Grip® Plug	10	2 PSI	5FT
271535	3"	Econ-O-Grip® Plug	10	2 PSI	5FT
271543	4"	Econ-O-Grip® Plug	10	2 PSI	5FT
271551	5"	Econ-O-Grip® Plug	5	1 PSI	2FT
271578	6"	Econ-O-Grip® Plug	5	1 PSI	2FT



**Cherne® Petro Econ-O-Grip® Plugs (Chemical Resistant)**

- Chemical-resistant Nitrile rubber and stainless steel hardware.
- Not recommended for pressure tests.

Product No.	Size	Description	Ctn. Qty.	Back Pressure P.S.I.	Feet of Head
273318	1-1/2"	Stainless Steel Econ-O-Grip® Plug	2	2 PSI	5FT
273328	2"	Stainless Steel Econ-O-Grip® Plug	2	2 PSI	5FT
273338	3"	Stainless Steel Econ-O-Grip® Plug	2	2 PSI	5FT
273348	4"	Stainless Steel Econ-O-Grip® Plug	2	2 PSI	5FT
273358	5"	Stainless Steel Econ-O-Grip® Plug	1	1 PSI	2FT
273368	6"	Stainless Steel Econ-O-Grip® Plug	1	1 PSI	2FT



**Cherne® Sure-Grip® Plugs**

- Polypropylene construction with natural rubber O-ring.
- Can be used as a permanent or temporary plug.
- Fits all type(s) of pipe at nominal sizes.

Product No.	Size	Description	Ctn. Qty.	Back Pressure P.S.I.	Feet of Head
271158	1-1/2"	Sure-Grip® Plug	10	22 PSI	50FT
271208	2"	Sure-Grip® Plug	10	22 PSI	50FT
271308	3"	Sure-Grip® Plug	10	13 PSI	30FT
271408	4"	Sure-Grip® Plug	10	13 PSI	30FT
<b>Schedule 40</b>					
271228	2"	Schedule 40 Sure-Grip® Plug	10	22 PSI	50FT
271338	3"	Schedule 40 Sure-Grip® Plug	10	13 PSI	30FT
271448	4"	Schedule 40 Sure-Grip® Plug	10	13 PSI	30FT

**Cherne® Kwik 'N Sure® Plugs**

- Works in all types of pipe.
- Wing nut on 3/8" – 1-1/4" sizes.
- Hex nut on 1.5" through 5" sizes.
- Works well for plugging water line stub-outs.
- Natural rubber O-ring.



Product No.	Size	Description	Ctn. Qty.	Back Pressure P.S.I.	Feet of Head
269832	0.39"	Kwik 'n Sure® Plug	1	185 PSI	428FT
269840	1/2"	Kwik 'n Sure® Plug	1	180 PSI	415FT
269867	3/4"	Kwik 'n Sure® Plug	1	180 PSI	415FT
269875	1"	Kwik 'n Sure® Plug	1	40 PSI	92FT
269883	1-1/4"	Kwik 'n Sure® Plug	1	112 PSI	258FT
269891	1-1/2"	Kwik 'n Sure® Plug	1	88 PSI	203FT
269905	2"	Kwik 'n Sure® Plug	1	112 PSI	258FT
269913	2-1/2"	Kwik 'n Sure® Plug	1	72 PSI	166FT
269921	3"	Kwik 'n Sure® Plug	1	28 PSI	65FT
269948	4"	Kwik 'n Sure® Plug	1	24 PSI	55FT
269956	5"	Kwik 'n Sure® Plug	1	8 PSI	18FT



**Cherne® Monitor Well™ Locking Plugs**

- Designed to seal monitor wells.
- Sized to seal Schedule 40 piping.
- 2" and 4" sizes can also seal schedule 5 plastic and stainless steel pipe.
- Yellow chromate-coated locking latch accepts Cherne's solid brass padlock or No. 2 Master® padlock.
- Meets all EPA requirements for locking plugs.
- Made with chemical-/petroleum-resistant Estaloc® plastic top/bottom plates and Nitrile sealing O-ring.
- Comes with stainless steel carriage bolt.

Product No.	Size	Description	Ctn. Qty.	Back Pressure P.S.I.	Feet of Head
271648	1"-1-1/4"	Monitor Well™ Locking Plug	12	6.5 PSI	15FT
271675	2"	Monitor Well™ Locking Plug	50	6.5 PSI	15FT
271669	3"	Monitor Well™ Locking Plug	75	6.5 PSI	15FT
271683	4"	Monitor Well™ Locking Plug	25	6.5 PSI	15FT
271691	6"	Monitor Well™ Locking Plug	10	6.5 PSI	15FT
271735	8"	Monitor Well™ Locking Plug	8	6.5 PSI	15FT
112941		Padlock with Key	1		



**Cherne® Iron Grip™ Plugs**

- The sturdy design is perfect for a variety of low-pressure, water/air testing or blocking applications.
- Large wing nut design allows for easy, tool-free installation and superior sealing.
- Can be used as either a temporary or permanent plug.
- Cast iron construction is both economical yet rugged.
- Bypass allows for easy pressure relief.
- Now available in most popular sizes.

Product No.	Description	Ctn. Qty.	Back Pressure P.S.I.	Feet of Head
268028	2" Iron Grip Bypass Plug w/ 3/8" bypass	1	13 PSI	
268038	3" Iron Grip Bypass Plug w/ 1/2" bypass	1	11 PSI	
268048	4" Iron Grip Bypass Plug w/ 1/2" bypass	1	8.7 PSI	
268068	6" Iron Grip Bypass Plug w/ 1/2" bypass	1	4.3 PSI	
268088	8" Iron Grip Bypass Plug w/ 1/2" bypass	1	4.3 PSI	
268108	10" Iron Grip Bypass Plug w/ 1/2" bypass	1	3.5 PSI	
268128	12" Iron Grip Bypass Plug w/ 1/2" bypass	1	2.6 PSI	

**Cherne® Mechanical Cleanout Plugs**

- Quick & Easy – Mechanical Operation.
- High Test Pressures - Up to 150 ft head/ 65 psi / 15 floors\*.
- No Tools Required - Install / Remove in seconds.
- Fits PVC, ABS, & Cast Iron Cleanout Tees.
- Durable & Replaceable Rubber Pads.
- 2 Stage Locking Mechanism - Locks into test & drain positions.



#271058 shown



#271148 shown

Product No.	Description	Ctn. Qty.	Maximum Back Pressure P.S.I.	Flow Rate
271128	2" Mechanical Cleanout Plug	1	150 ft head / 65 psi / 15 floors*	
271038	3" Mechanical Cleanout Plug	1	150 ft head / 65 psi / 15 floors*	
271048	4" Mechanical Cleanout Plug	1	100 ft head / 44 psi / 10 floors*	
271058	4" Mechanical Cleanout Plug with Hose	1	100 ft head / 44 psi / 10 floors*	Up to 9 GPM**
270308	2" Replacement Pad Kit	1		
270318	3" Replacement Pad Kit	1		
270328	4" Replacement Pad Kit	1		
270338	4" Replacement Pad Kit with Hose	1		
271148	Shut off Valve, Mechanical Cleanout Plug	1		

\*calculated using 10 ft head per floor

\*\*calculated with pressure at 80 psi





# Category 20

## Test Equipment, Drain Flushers, and Accessories

Everything from replacement chains and extension hoses to poly lift lines and gauges. Innovation and quality has made Cherne the contractor's choice since 1953, for Hand Pumps, Hose Assemblies, Drain Flushers, Test Gauges, and Manometers!

TEST EQUIPMENT, DRAIN FLUSHERS, AND ACCESSORIES



**Cherne® Hi-Flow™ Air-Loc® Panel**

- Panel includes gauges to monitor compressor pressure, plug pressure and test pressure.
- Stored in a sturdy case.
- Can be used with either 3/8" or 3/4" fill hose, accomplished by simply turning a valve.
- Designed to work with air compressors fitted with either crow's foot or standard quick disconnect fittings.

Product No.	Description
304718	Control Panel
026358	0-10 PSI Test Pressure Gauge – Retarded increments from 11-30 PSI
014828	0-60 PSI Ball Pressure Gauge
014848	0-160 PSI Compressor Gauge
0430480A	3-Way Valve
296643	Regulator



**Cherne® Triple Hose**

- The 3/8" diameter hose assembly is used to connect the Air-Loc Panel to the front plug.
- Triple hose is color-coded, making connections easy to understand.
- Hose features locking quick disconnects for safety and includes strain relief to protect hose from damage.
- Available with 3/4 blue test pressure hose for quick exhausting.

Product No.	Description
035268	25' Triple Hose
257038	50' Triple Hose
257188	400' Triple Hose
257108	25' Hi-Flow Triple Hose
257098	50' Hi-Flow Triple Hose



**Cherne® 22' Interconnect Hose**

- Used to attach the front and back air test plugs when conducting a leak location test.
- Includes a cable for attaching to the pipe plugs to take strain off the hose during the leak location process.

Product No.	Description
043338	22' Interconnect Hose



**Cherne® Air-Loc® Line Acceptance Kit**

- Used to perform low pressure air tests on newly installed sewer lines.
- Includes all items needed to conduct the test except an air compressor and two pipe plugs.

Product No.	Description
253398	Air-Loc® Line Acceptance Kit



**Cherne® Smoke Blowers**

Product No.	Description	Ctn. Qty.
303008	Smoke Fluid Smoke Blower Kit: Briggs & Stratton Engine	1
303550	Smoke Candle Smoke Blower Kit: Briggs & Stratton Engine	1

**Cherne® Residential Smoke Blower**

- Honda engine; 122CC, 3.5 HP, 4 Stroke, >700 CFM
- 5' heavy duty hose with 4" diameter
- Vibration damping – minimize excess movement
- Can be used indoors – exhaust is pumped through plumbing
- Long lasting, dense smoke



Product No.	Size	Description	UPC	Ctn. Qty.
303078		Plumbing Smoke Blower	675115034587	1
036488		Fluid Smoke Pressure Container & Hose	675115036482	1

**Cherne® Smoke Fluid**



Product No.	Description	UPC	Ctn. Qty.
065808	Smoke Fluid: One Gallon	675115065802	1
065818	Smoke Fluid: Five Gallons	675115065819	1
065828	Smoke Fluid: Fifty-Five Gallon Drum	675115065826	1

**Cherne® Smoke Generators (Candles)**



Product No.	Description	UPC	Ctn. Qty.
072608	Smoke Candle: 30 Seconds	675115034341	12
072618	Smoke Candle: 60-Seconds	675115072619	12
072628	Smoke Candle: 3 Minutes	675115072626	12
072638	Smoke Candle: 3 Minutes Double Wick	675115072633	12

**Cherne® Econ-O-Pump™ Test Pump**

- Low cost version for the infrequent user.
- 0-140 PSI gauge.
- Traditional thumb lock.
- All metal construction.



Product No.	Size	Description	UPC	Ctn. Qty.
273888		Econ-O-Pump™ Test Pump	675115273887	1

**Cherne® Air-Max® Test Pumps**

- Gauge raised from base for protection.
- 0-100 PSI gauge.
- Durable steel barrel.
- Textured steel base prevents feet from slipping.
- Durable, no-kink hose.



Product No.	Size	Description	UPC	Ctn. Qty.
034588		Replacement Hose Assembly w/Thumb Lock	675115034587	1
273958		Air-Max® Test Pump	675115273955	1

**Cherne® Air-Max® Pro HV Test Pumps**

- Large barrel for maximum volume means fewer strokes to inflate plug.
- 0-60 PSI gauge for most accurate plug pressure readings.
- All-metal thumb lock for durability.
- Hose strain relief to transfer tension from hose to the barrel.
- Forged steel barrel for extra toughness.
- Large, three-point base for maximum stability.
- Rubber cover to protect gauge from damage.
- Solid wood handle for greater comfort and durability.
- Durable, no-kink hose.



Product No.	Size	Description	UPC	Ctn. Qty.
055728		Replacement Hose Assembly w/Thumb Lock	675115055728	1
273968		Air-Max® Test Pump	675115273962	1

TEST EQUIPMENT, DRAIN FLUSHERS AND ACCESSORIES



**Cherne® Manometer**

- Used for final test of DWV pipe and to test gas lines.
- Reads in 1/10" increments
- Measures water columns from 0" to 16".

Product No.	Size	Description	Ctn. Qty.
010205		Manometer	1



**Cherne® Replacement Chains**

- Replacement assemblies for Test-Ball plugs.
- Rings prevent test plugs from sliding down a line.
- Includes a safety tag.

Product No.	Description	Ctn. Qty.
059708	2" Ring With 12" Chain	1
059718	3" Ring With 12" Chain	1
059728	4" Ring With 12" Chain	1
059748	6" Ring With 12" Chain	1
059758	2" Ring With 24" Chain	1
059768	3" Ring With 24" Chain	1
059778	4" Ring With 24" Chain	1
059798	6" Ring With 24" Chain	1



**Cherne® Gauges**

- Features 2" plastic face.
- High-quality brass 1/4" connection.

Product No.	Description	Ctn. Qty.
000698	0-15 psi Gauge 2" Face 0.1 psi Increments	1
000628	0-30 psi Gauge 2" Face 0.5 psi Increments	1
000638	0-60 psi Gauge 2" Face 1 psi Increments	1
000648	0-100 psi Gauge 2" Face 2 psi Increments	1



### Cherne® Gauges With 3/4" FNPT Test Body

- Features 2" plastic face.
- Chrome plated body.
- 1/8" Schrader valve and 3/4" NPT(F) pipe connection.

Product No.	Description	Ctn. Qty.
024568	0-15 psi Gauge 2" Face 0.1 psi Increments	1
019698	0-30 psi Gauge 2" Face 0.5 psi Increments	1
019708	0-60 psi Gauge 2" Face 1 psi Increments	1
019718	0-100 psi Gauge 2" Face 2 psi Increments	1
000658	Hex Test Body 1/8" Tap	1
068527	Replacement Schrader Valve 1/8"	1



### Cherne® Hose - 3/16" ID

- Recommended for use with plugs up to 15" in diameter.
- Ideal for plumbing applications.
- Standard Schrader air valve connections.
- 3/16" ID hose.

Product No.	Description	Ctn. Qty.
274011	2' Hose, 3/16" ID	6
274038	3' Hose, 3/16" ID	6
274008	2' Hose, 3/16" ID Bagged Bulk Pak	24
274018	3' Hose, 3/16" ID Bagged Bulk Pak	24
274054	5' Hose, 3/16" ID	1
274100	10' Hose, 3/16" ID	1
274208	20' Hose, 3/16" ID	1
055816	Deflator With Clamp (Female End)	1
055808	Inflator With Clamp (Male End)	1
277048	Replacement O-rings (Pack of 10)	1



### Cherne® Extension Hose With Gauge, 3/16" ID

- Recommended for use with plugs up to 15" in diameter.
- Ideal for plumbing applications
- Standard Schrader valve connections.
- 3/16" ID hose.
- 0-100 PSIG gauge.

Product No.	Description	Ctn. Qty.
274218	5' Hose With Gauge 3/16" ID	1
274228	10' Hose With Gauge 3/16" ID	1
274238	20' Hose With Gauge 3/16" ID	1
274248	30' Hose with Gauge 3/16" ID	1
274268	50' Hose with Gauge 3/16" ID	1
274298	100' Hose with Gauge 3/16" ID	1



**Cherne® Hi-Flow Poly Lift Line with and without Gauge**

- Greater Lifting Strength.
- Recommended for plugs 6" to 48".
- Retard gauge: helps prevent "peg-out" damage.
- Heavy-duty rubber gauge cover protects gauge.
- 3/8" heavy-duty ID hose for quick inflate/deflate.
- Quick-dump valve for easy deflation.
- Industrial quick disconnect.
- Designed for use with plugs with removable inflator valve.

Product No.	Description	Ctn. Qty.
380108	10' Hi-Flow Hose, w/o Gauge, 3/8" ID	1
380208	20' Hi-Flow Hose, w/o Gauge, 3/8" ID	1
380308	30' Hi-Flow Hose, w/o Gauge, 3/8" ID	1
380408	40' Hi-Flow Hose, w/o Gauge, 3/8" ID	1
380508	50' Hi-Flow Hose, w/o Gauge, 3/8" ID	1
048468	0-60 psi, 2.5" Dial, Plug Pressure Gauge With Retarded Increments To 160 Psi With Cover	1
053458	0-60 psi, 2.5" Dial, Plug Pressure Gauge With Retarded Increments To 160 Psi	1



**Cherne® Super-Flow Hose with Gauge**

- Designed for large diameter multi-size plugs - (24"-48" to 54"-96").
- 3/4" Heavy-duty hose for both durability and faster deflation.
- Retard gauge: Helps prevent gauge "peg-out".
- Heavy-duty rubber gauge cover protects gauge.
- Utilizes traditional "crow's foot" air compressor fittings.
- Quick dump valve for easy deflation.

Product No.	Description	Ctn. Qty.
341208	20' Super-Flow Hose, w/ Gauge, 3/4" ID	1
341308	30' Super-Flow Hose, w/ Gauge, 3/4" ID	1
341408	40' Super-Flow Hose, w/ Gauge, 3/4" ID	1



**Cherne® Poly Lift Line - 3/16" ID**

- Schrader valve connections.
- Poly rope designed for raising and lowering plug.
- Ideal for plugs 8" and up.
- 3/16" ID hose.
- Snap hook connects to plug eyebolt.

Product No.	Description	Ctn. Qty.
261076	10' Hose With Poly Lift Line, 3/16" ID	1
261084	20' Hose With Poly Lift Line, 3/16" ID	1
261106	30' Hose With Poly Lift Line, 3/16" ID	1
261114	40' Hose With Poly Lift Line, 3/16" ID	1



# Category 21

## Pans and Stands

Oatey® Aluminum and Plastic Water Heater Pans can be installed under gas or electric water heaters to protect from water damage. Pans are manufactured from prime aluminum or semi-flexible, tough and durable .0625" plastic polymer and are expertly worked to exact specifications under strict quality control. Available with 1" PVC, 1½" PVC or 1" CPVC drain fittings to allow for connection to indirect drain.



### Oatey® Aluminum Water Heater Pan

- Manufactured from prime aluminum and are expertly worked to exact specifications under strict quality control.
- Recommended for gas or electric water heaters.
- Exposed edges have been rolled to protect the installer from injury.

Product No.	Size	Description	UPC	Ctn. Qty.
<b>Aluminum Water Heater Pans - 1" To 1-1/2" PVC Adapter (1-1/2" inside)</b>				
34081	20"	Aluminum Pan	038753340814	6
34082	22"	Aluminum Pan	038753340821	6
34083	24"	Aluminum Pan	038753340838	6
34084	26"	Aluminum Pan	038753340845	6
34103	28"	Aluminum Pan	038753341033	6
34107	30"	Aluminum Pan	038753341071	6
34191	32"	Aluminum Pan	038753341910	6
<b>Aluminum Water Heater Pans with 1" CPVC Adapter</b>				
34170	18"	Aluminum Pan	038753341705	6
34171	20"	Aluminum Pan	038753341712	6
34172	22"	Aluminum Pan	038753341729	6
34173	24"	Aluminum Pan	038753341736	6
34174	26"	Aluminum Pan	038753341743	6
34176	28"	Aluminum Pan	038753341767	6
34175	30"	Aluminum Pan	038753341750	6
34193	32"	Aluminum Pan	038753341934	6
<b>Aluminum Water Heater Pans - Without Adapter</b>				
34092	22"	Aluminum Pan Without Hole / Adapter	038753340920	6
34093	24"	Aluminum Pan Without Hole / Adapter	038753340937	6
34094	26"	Aluminum Pan Without Hole / Adapter	038753340944	6
34192	32"	Aluminum Pan Without Hole / Adapter	038753341927	6



### Oatey® Water Heater Pan Adapters

- Available in PVC or CPVC.
- 1" & 1-1/2".

Product No.	Size	Description	UPC	Ctn. Qty.
34086	1" & 1-1/2"	PVC Adapter (1" inside adapter / 1-1/2" inside adapter)	038753340869	12
34088	1" & 1-1/2"	PVC Adapter (1" inside adapter / 1-1/2" over adapter)	038753340883	12
34089	1"	CPVC Adapter	038753340890	12





### Oatey® Plastic Water Heater Pan

- Manufactured from semi-flexible, tough and durable .0625" plastic polymer.
- Recommended for electric water heaters.

Product No.	Size	Description	UPC	Ctn. Qty.
<b>Plastic Water Heater Pans with 1"-1-1/2" PVC Adapter (1-1/2" inside)</b>				
34140	18"	Plastic Pan	038753341408	12
34142	22"	Plastic Pan	038753341422	12
34143	24"	Plastic Pan	038753341439	12
34144	26"	Plastic Pan	038753341446	12
34146	28"	Plastic Pan	038753341460	6
34145	30"	Plastic Pan	038753341453	12
<b>Plastic Water Heater Pans With 1" CPVC Adapter</b>				
34160	18"	Plastic Pan	038753341606	12
34161	20"	Plastic Pan	038753341613	12
34162	22"	Plastic Pan	038753341620	12
34163	24"	Plastic Pan	038753341637	12
34164	26"	Plastic Pan	038753341644	12



### Oatey® Washing Machine Pan

- Provides protection from washing machine overflow or hose failure.
- Made from high impact plastic.
- Will not rust or corrode.
- Pans have formed hole to punch out for the furnished, 1" PVC plastic fitting.

Product No.	Size	Description	UPC	Ctn. Qty.
34051	28" x 30"	Plastic Pan – Bagged	038753340517	4
34052	28" x 30"	Plastic Pan – Without Fitting	038753340524	6
34067	28" x 30"	Plastic Pan	038753340678	12



### Harvey® Water Heater Stand

- Constructed of 18 gauge spangeld galvanized sheet metal.
- Allows placement of water heater tanks 18-in above ground as required by most model plumbing and fuel codes.
- Holds up to 50 gallon water heaters.

Product No.	Size	Description	UPC	Ctn. Qty.
013900	21" x 18"	HV Water Heater Stand 21" Square x 18"	078864139006	4



# Category 22

## Commercial Drainage

Oatey® commercial drains are designed to stand up to heavy traffic areas. Preformed anchor positions are included in each base design and drain barrels include internal thread that accepts clean-out plugs. Four grate finishes are available: Stainless Steel, Nickel, Chrome and Brass.



**Oatey® General Purpose Brass Strainer**

- Features a barrel assembly that is completely adjustable to meet the finished floor height.
- PVC Barrel.

Product No.	Size	Description	UPC	Ctn. Qty.
72017	3" Pipe or 4" Hub	5" Strainer - PVC Base	038753720173	1
72018	4" Pipe Fit	5" Strainer - PVC Base	038753780139	1
72019	4" Hub Fit	5" Strainer - PVC Base	038753720197	1
82017	3" Pipe or 4" Hub	5" Strainer - ABS Base	038753820170	1
82019	4" Hub	5" Strainer - ABS Base	038753820194	1
72117	3" Pipe or 4" Hub	6" Strainer - PVC Base	038753721170	1
72119	4" Hub Fit	6" Strainer - PVC Base	038753721194	1

**Oatey® General Purpose Nickel Strainer**

- Uses an easy-leveling strainer mount to correct tilted drains
- PVC Barrel



#72167 shown

Product No.	Size	Description	UPC	Ctn. Qty.
72067	3" Pipe or 4" Hub	5" Strainer - PVC Base - Round with Ring	038753720678	1
72068	4" Pipe Fit	5" Strainer - PVC Base - Round with Ring	038753720685	1
72077	3" Pipe or 4" Hub	5" Strainer - PVC Base - Round with Sq. Ring	038753720777	1
72079	4" Hub Fit	5" Strainer - PVC Base - Round with Sq. Ring	038753720791	1
82067	3" Pipe or 4" Hub	5" Strainer - ABS Base - Round with Ring	038753820675	1
82068	4" Pipe Fit	5" Strainer - ABS Base - Round with Ring	038753820682	1
72167	3" Pipe or 4" Hub	6" Strainer - PVC Base - Round with Ring	038753721675	1
72168	4" Pipe Fit	6" Strainer - PVC Base - Round with Ring	038753721682	1
72169	4" Hub Fit	6" Strainer - PVC Base - Round with Ring	038753721699	1
72177	3" Pipe or 4" Hub	6" Strainer - PVC Base - Round with Sq. Ring	038753721774	1

**Oatey® General Purpose Cleanout Items**

- Easily converts a drain to a cleanout or vice versa, even after the concrete is poured.



#74168 shown

Product No.	Size	Description	UPC	Ctn. Qty.
74167	3" Pipe or 4" Hub	6" Cleanout - PVC Barrel and PVC Flange Base	038753741673	1
74168	4" Pipe Fit	6" Cleanout - PVC Barrel and PVC Flange Base	038753741680	1
74169	4" Hub Fit	6" Cleanout - PVC Barrel and PVC Flange Base	038753741697	1
74177	3" Pipe or 4" Hub	6" Cleanout - PVC Barrel and PVC Flange - Round with Sq. Ring	038753741772	1
74178	4" Pipe Fit	6" Cleanout - PVC Barrel and PVC Flange - Round with Sq. Ring	038753741789	1
74179	4" Hub Fit	6" Cleanout - PVC Barrel and PVC Flange - Round with Sq. Ring	038753741796	1
84167	3" Pipe or 4" Hub	6" Cleanout - PVC Barrel and ABS Flange - Round with Ring	038753841670	1
84179	4" Hub Fit	6" Cleanout - PVC Barrel and ABS Flange Base - Round with Sq. Ring	038753841793	1

**COMPONENTS**



**Oatey® Replacement Grates**

- Uses an easy-leveling strainer mount to correct tilted drains.
- Solves the problem of drain installs knocked out of plumb after concrete is poured.

Product No.	Size	Description	UPC	Ctn. Qty.
80010	5"	Stainless Steel Grate	038753800103	1
80020	5"	Round Brass Grate	038753800202	1
80040	5"	Round Brass Grate with Sq. Ring	038753800400	1
80050	5"	Round Brass Grate	038753800509	1
80060	5"	Round Nickel Grate and Ring	038753800608	1
80080	5"	Round Chrome Grate	038753800806	1
80120	6"	Round Brass Grate	038753801209	1
80130	6"	Round Brass Grate and Ring	038753801308	1
80140	6"	Round Brass Grate with Sq. Ring	038753801407	1
80150	6"	Round Brass Grate	038753801506	1
80170	6"	Round Nickel Grate with Sq. Ring	038753801704	1
80190	6"	Round Chrome Grate and Ring	038753801902	1
80200	6"	Round Chrome Grate with Sq. Ring	038753802008	1



**Oatey® Replacement Covers**

- Uses an easy-leveling strainer mount to correct tilted drains.
- Solves the problem of drain installs knocked out of plumb after concrete is poured.

Product No.	Size	Description	UPC	Ctn. Qty.
81120	6"	Round Cover - Brass	038753811208	1
81130	6"	Round Cover & Ring - Brass	038753811307	1
81140	6"	Round Cover & Square Ring - Brass	038753811406	1
81150	6"	Round Cover - Nickel	038753811505	1
81160	6"	Round Cover & Ring - Nickel	038753811604	1
81170	6"	Round Cover & Square Ring - Nickel	038753811703	1

**SEDIMENT DRAINS**



**Oatey® Sediment Drains**

- Multipurpose drain for effective effluent removal in any application.
- Optional removable sediment bucket will keep drain lines free of all debris.

Product No.	Size	Description	UPC	Ctn. Qty.
76012	2" Pipe	PVC Sediment Drain, Plastic Grate w/ Bucket	038753760124	1
76022	2" Pipe	PVC Sediment Drain, Plastic Grate w/o Bucket	038753760223	1
76013	3" or 4" Pipe	PVC Sediment Drain, Plastic Grate w/ Bucket	038753760131	1
76023	3" or 4" Pipe	PVC Sediment Drain, Plastic Grate w/o Bucket	038753760230	1
76033	3" or 4" Pipe	PVC Sediment Drain, Cast Iron Grate w/ Bucket	038753760339	1
76014	4" Pipe	PVC Sediment Drain, Plastic Grate w/ Bucket	038753760148	1
76024	4" Pipe	PVC Sediment Drain, Plastic Grate w/o Bucket	038753760247	1
76034	4" Pipe	PVC Sediment Drain, Cast Iron Grate w/ Bucket	038753760346	1
76016	6" Pipe	PVC Sediment Drain, Plastic Grate w/ Bucket	038753760162	1
76026	6" Pipe	PVC Sediment Drain, Plastic Grate w/o Bucket	038753760261	1
76036	6" Pipe	PVC Sediment Drain, Cast Iron Grate w/ Bucket	038753760360	1
86012	2" Pipe	ABS Sediment Drain, Plastic Grate w/Bucket	038753860121	1
86032	2" Pipe	ABS Sediment Drain, Cast Iron Grate W/Bucket	038753860329	1
86034	4" Pipe	ABS Sediment Drain, Cast Iron Grate w/ Bucket	038753860343	1
86036	6" Pipe	ABS Sediment Drain, Cast Iron Grate W/Bucket	038753860367	1

## SEDIMENT DRAINS



### Oatey® General Purpose Brass Strainer

Product No.	Size	Description	UPC	Ctn. Qty.
71740		Grate	038753717401	1
71750		Grate Collar	038753717500	1
71760		Debris Bucket	038753717609	1

## ROOF DRAINS



### Oatey® Roof Drain with Dome

- Superior drainage with robust debris protection.
- Available in cast iron or plastic domes with 2 inch water dam collar.

Product No.	Size	Description	UPC	Ctn. Qty.
78012	2" Pipe	PVC Roof Drain w/ Plastic Dome	038753780122	1
78022	2" Pipe	PVC Roof Drain w/ Cast Iron Dome	038753780221	1
78032	2" Pipe	PVC Roof Drain w/ ABS Dome & Dam Collar	038753780320	1
78042	2" Pipe	PVC Roof Drain w/ Cast Iron Dome & Dam Collar	038753780429	1
78013	3" or 4" Pipe	PVC Roof Drain w/ Plastic Dome	038753780139	1
78023	3" or 4" Pipe	PVC Roof Drain w/ Cast Iron Dome	038753780238	1
78033	3" or 4" Pipe	PVC Roof Drain w/ ABS Dome & Dam Collar	038753780337	1
78043	3" or 4" Pipe	PVC Roof Drain w/ Cast Iron Dome & Dam Collar	038753780436	1
78014	4" Pipe	PVC Roof Drain w/ Plastic Dome	038753780146	1
78024	4" Pipe	PVC Roof Drain w/ Cast Iron Dome	038753780245	1
78034	4" Pipe	PVC Roof Drain w/ ABS Dome & Dam Collar	038753780344	1
78044	4" Pipe	PVC Roof Drain w/ Cast Iron Dome & Dam Collar	038753780443	1
78016	6" Pipe	PVC Roof Drain w/ Plastic Dome	038753780160	1
78026	6" Pipe	PVC Roof Drain w/ Cast Iron Dome	038753780269	1
78036	6" Pipe	PVC Roof Drain w/ ABS Dome & Dam Collar	038753780368	1
78046	6" Pipe	PVC Roof Drain w/ Cast Iron Dome & Dam Collar	038753780467	1
88012	2" Pipe	ABS Roof Drain w/ Plastic Dome Guard	038753880129	1
88022	2" Pipe	ABS Roof Drain w/ Cast Iron Dome Guard	038753880228	1
88032	2" Pipe	ABS Roof Drain w/ ABS Dome Dam Collar	038753880327	1
88042	2" Pipe	ABS Roof Drain w/ Cast Iron Dome Dam Collar	038753880426	1
88013	3" or 4" Pipe	ABS Roof Drain w/ Plastic Dome Guard	038753880136	1
88033	3" or 4" Pipe	ABS Roof Drain w/ ABS Dome & Dam Collar	038753880334	1
88043	3" or 4" Pipe	ABS Roof Drain w/ Cast Iron Dome & Dam Collar	038753880433	1
88014	4" Pipe	ABS Roof Drain w/ Plastic Dome	038753880143	1
88034	4" Pipe	ABS Roof Drain w/ ABS Dome Dam Collar	038753880341	1
88044	4" Pipe	ABS Roof Drain w/ Cast Iron Dome & Dam Collar	038753880440	1
88016	6" Pipe	ABS Roof Drain w/ Plastic Dome	038753880167	1
88026	6" Pipe	ABS Roof Drain w/ Cast Iron Dome	038753880266	1
88036	6" Pipe	ABS Roof Drain w/ ABS Dome & Dam Collar	038753880365	1
88046	6" Pipe	ABS Roof Drain w/ Cast Iron Dome Dam Collar	038753880464	1



### Oatey® Roof Drain Components

- Drain Components include plastic cover plates and brass floor grates for use with bath drains.

Product No.	Size	Description	UPC	Ctn. Qty.
71970		Plastic Gravel Guard	038753719702	1
71960		Dam Collar	038753719603	1



**Oatey® PVC Floor Sinks**

- Allows easy access for cleaning and debris removal caused by indirect waste sources such as sinks, lavatories and condensate drains.

Product No.	Size	Description	UPC	Ctn. Qty.
42720	2"	PVC Floor Sink	038753427201	1
42721	3"	PVC Floor Sink	038753427218	1
42722	4"	PVC Floor Sink	038753427225	1

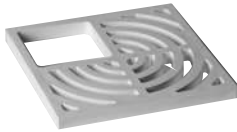

**Oatey® Top Grate for Floor Sinks**

- Allows easy access for cleaning and debris removal caused by indirect waste sources such as sinks, lavatories and condensate drains.

Product No.	Size	Description	UPC	Ctn. Qty.
42751		Half Top Grate For Floor Sink	038753427515	1
42752		Three-Quarter Top Grate For Floor Sink	038753427522	1
42753		Full Top Grate for Floor Sink	038753427539	1



**Oatey® Cast Iron Drain Funnels**

Product No.	Size	Description	UPC	Ctn. Qty.
71720		Round Drain Funnel	038753717203	1
71730		Oval Drain Funnel	038753717302	1



**Oatey® Reversible Dome Strainers/Buckets**

- Allows easy access for cleaning and debris removal caused by indirect waste sources such as sinks, lavatories and condensate drains.

Product No.	Size	Description	UPC	Ctn. Qty.
42754	2"	Bottom Aluminum Dome Strainer	038753427546	1
42755	3"	Bottom Aluminum Dome Strainer	038753427553	60
42756	4"	Bottom Aluminum Dome Strainer	038753427560	48



# Category 23

## Rough-In Products and Tools

Count on Oatey® and MASTERS® rough-in products when you're tackling any plumbing job. Access Panels are great for allowing access to service areas for plumbing, electrical, security systems, telephone, computer cables, sprinkler systems and more. Can be flush or surface mounted. Tub protectors protect tub surfaces from debris during remodel or construction jobs. A wide variety of test caps are also available.

CATEGORY **23** ROUGH-IN PRODUCTS AND TOOLS





## ROUGH-IN PRODUCTS



#38600 shown

### Oatey® Quiet Pipes® STRAIGHT & WASHING MACHINE

- Eliminates water pipe banging caused by quick closing valves.
- Can be installed without opening any walls.
- Can be installed upside down or sideways.

Product No.	Description	UPC	Ctn. Qty.
34498	Quiet Pipes Hammer Arrestor, 1/2" Male Sweat, Straight, AA	038753344577	30
34458	Quiet Pipes Hammer Arrestor, 1/2" CPVC Female, Straight, AA	038753391779	30
34459	Quiet Pipes Hammer Arrestor, 1/2" CPVC Male, Straight, AA	038753344591	30
34460	Quiet Pipes Hammer Arrestor, 1/2" F1960, Straight, AA	038753344607	30
34461	Quiet Pipes Hammer Arrestor, 1/2" F1807, Straight, AA	038753344614	30
34463	Quiet Pipes Hammer Arrestor, 3/4" Male Sweat, Straight, AA	038753344638	30
39177	Quiet Pipes Hammer Arrestor, 1/2" MIP, Straight, AA	038753391779	6
38600	Quiet Pipes Washing Machine Supply Line Shock Absorber, AA	038753386003	6



### Oatey® Quiet Pipes® PEX TEE

Product No.	Description	UPC	Ctn. Qty.
34472	Quiet Pipes Hammer Arrestor, 1/2" PEX F1807 Tee, AA	038753344720	30



### Oatey® Quiet Pipes® COMPRESSION TEE

Product No.	Description	UPC	Ctn. Qty.
34473	Quiet Pipes Hammer Arrestor, 1/4" O.D. Compression Tee, AA	038753344737	30
34474	Quiet Pipes Hammer Arrestor, 3/8" O.D. Compression Tee, AA	038753344744	30



### Oatey® Quiet Pipes® FEMALE COMPRESSION TEE

Product No.	Description	UPC	Ctn. Qty.
34475	Quiet Pipes Hammer Arrestor, 1/4" O.D. Compression x Female Tee, AA	038753344751	30
34465	Quiet Pipes Hammer Arrestor, 3/8" O.D. Compression x Female Tee, AA	038753344652	30
34467	Quiet Pipes Hammer Arrestor, 5/8" O.D. Compression x Female Tee, AA	038753344676	30

ROUGH-IN PRODUCTS



**Oatey® Quiet Pipes® STRAIGHT MALE IRON PIPE**

Product No.	Description	UPC	Ctn. Qty.
34481	Quiet Pipes Hammer Arrestor, 1/2" MIP, Straight, A	038753344812	12
34484	Quiet Pipes Hammer Arrestor, 3/4" MIP, Straight, B	038753344843	30
34485	Quiet Pipes Hammer Arrestor, 1" MIP, Straight, C	038753344850	24
34479	Quiet Pipes Hammer Arrestor, 1" MIP, Straight, E	038753344799	6
34480	Quiet Pipes Hammer Arrestor, 1" MIP, Straight, F	038753344805	6



**Oatey® Quiet Pipes® STRAIGHT MALE SWEAT/PRESS FITTING**

Product No.	Description	UPC	Ctn. Qty.
34499	Quiet Pipes Hammer Arrestor, 1/2" Male Sweat/Press, Straight, A	038753344867	30
34500	Quiet Pipes Hammer Arrestor, 3/4" Male Sweat/Press, Straight, B	038753344836	30
34501	Quiet Pipes Hammer Arrestor, 1" Male Sweat/Press, Straight, C	038753344874	24
34502	Quiet Pipes Hammer Arrestor, 1" Male Sweat/Press, Straight, D	038753344881	6
34503	Quiet Pipes Hammer Arrestor, 1" Male Sweat/Press, Straight, E	038753344898	6
34504	Quiet Pipes Hammer Arrestor, 1" Male Sweat/Press, Straight, F	038753344904	6



**Oatey® Quiet Pipes® CPVC SOCKET ASTM D 2846**

Product No.	Description	UPC	Ctn. Qty.
34491	Quiet Pipes Hammer Arrestor, 1/2" CPVC Socket, Straight, A	038753344911	24
34492	Quiet Pipes Hammer Arrestor, 3/4" CPVC Socket, Straight, B	038753344928	24
34477	Quiet Pipes Hammer Arrestor, 1" CPVC Socket, Straight, C	038753344775	12



**Oatey® Quiet Pipes® ASTM PEX F1807 CRIMP & ASTM PEX F1960 GRIP**

Product No.	Description	UPC	Ctn. Qty.
34482	Quiet Pipes Hammer Arrestor, 1/2" F1807, Straight, A	038753344829	12
34493	Quiet Pipes Hammer Arrestor, 3/4" F1807, Straight, B	038753344935	30
34494	Quiet Pipes Hammer Arrestor, 1" F1807, Straight, C	038753344942	24
34476	Quiet Pipes Hammer Arrestor, 1/2" F1960, Straight, A	038753344768	12
34495	Quiet Pipes Hammer Arrestor, 3/4" F1960, Straight, B	038753344959	30
34496	Quiet Pipes Hammer Arrestor, 1" F1960, Straight, C	038753344966	24

## ROUGH-IN PRODUCTS



### MASTERS® Inside Pipe Cutter

- Fast cutting of ABS & PVC pipe, closet flanges, tub waste & overflows, shower drains and sink rims (wood)
- Can be used with any drill and comes with a replacement blade for longer tool use
- Replacements blades also sold separately

Product No.	Size	Description	UPC	Ctn. Qty.
PS-100	1.5"	MASTERS Inside Pipe Cutter Including Replacement Blade	067001001795	60
PS-102	1.5"	MASTERS Inside Pipe Cutter Replacement blade	067001001917	60



### MASTERS® Clamp or Cut

- Stainless steel cinch ring crimper - clamps (cinch) rings and cuts. Cutting feature activates with the spin of the activator pin so you don't have to search for another tool. Makes F1807 PEX connections fast.
- Ideal for new and re-routed supply lines or salvaging valves and fittings

Product No.	Size	Description	UPC	Ctn. Qty.
COC3810	0.375" to 1"	MASTERS Clamp or Cut	067001003546	1



### MASTERS® Crimpers

- Impact offset crimper with an 8" handle and a GO-NOGO gauge
- Can be used with Brass, Copper and Plastic fittings
- Adjustable for wear

Product No.	Size	Description	UPC	Ctn. Qty.
CM12	0.50"	MASTERS Crimper for F1807 Pex Pipe	067001003508	1
CM34	0.75"	MASTERS Crimper for F1807 Pex Pipe	067001003515	1
CM10	1.00"	MASTERS Crimper for F1807 Pex Pipe	067001003522	1
CM1234	0.50" and 0.75"	MASTERS Combo Crimper for F1807 Pex Pipe	067001003539	1



### MASTERS® Ringbuster

- Heavy duty PEX ring de-crimping tool will cut 1/2", 3/4" & 1" copper, brass and poly alloy/plastic fittings and tube
- Rounded anvil head doesn't fully close/connect allowing for fast cutting without damaging the inside or outside of the fitting, making the fittings reusable

Product No.	Size	Description	UPC	Ctn. Qty.
73015	0.50" to 1.0"	MASTERS Ringbuster for F1807 Pex Rings	067001000767	1



### MASTERS® Pliers

- Zinc plated, rubber gripped water pump pliers with a 2-1/8" jaw opening
- Grip tight clip keeps jaws in line, preventing unwanted locking and seizing

Product No.	Size	Description	UPC	Ctn. Qty.
G253	2 1/8"	MASTERS Pliers 10"	067001022172	10

ROUGH-IN PRODUCTS



**Oatey® Access Panel**

- Provides a service area for plumbing, electrical, security systems, telephone, TV, computer cables and sprinkler system applications.
- Eliminates costly repair.
- Special designed drill guides for cable or wire.
- Paint and wallpaper compatible.
- No lumber framing required. Ideal for new construction.
- Reversible outer frame allows for flush mounting.

Product No.	Size	Description	UPC	Ctn. Qty.
34045	8" x 8" / 20.3 x 20.3 cm	Plastic Access Panel	038753340456	6
34053	6" x 9" / 15.2 x 22.9 cm	Plastic Access Panel – Display	038753340531	6
34055	6" x 9" / 15.2 x 22.9 cm	Plastic Access Panel	038753340555	6
34056	14" x 14" / 35.6 x 35.6 cm	Plastic Access Panel	038753340562	6
34059	14" x 14" / 35.6 x 35.6 cm	Plastic Access Panel – Display	038753340593	4
34044	14" x 29" / 35.6 x 73.7 cm	Plastic Access Panel	038753340449	6



**Oatey® Foam Closet Spacer/Wrap**

- Used to keep cement away from pipe penetrations during rough-in.
- Allows easy fitting installation after cement pour.

Product No.	Size	Description	UPC	Ctn. Qty.
38711	4" x 4" / 10.2 x 10.2 cm	Foam Closet Spacer	038753387116	60



**Oatey® Toilet Base Plate**

- Cover damaged and missing tile when replacing toilet.
- Manufactured from high impact ABS.

Product No.	Size	Description	UPC	Ctn. Qty.
31258		Square Nose Toilet Base Plate	038753312583	12
31259		Round Nose Toilet Base Plate	038753312590	12



**Oatey® Bath Tub Protector**

- Offers protection against tub damage during home construction.
- A semi-flexible, heavy, high-impact plastic with deep-fluted sidewalls.
- Includes a non-skid foam pad to absorb shock and prevent scratched and dented tub finish.
- Nests for space-saving storage.

Product No.	Size	Description	UPC	Ctn. Qty.
34068	15" / 38.1 cm	38.1 cm Deep/144.8 cm Long Fits 36.6 cm Tubs	038753340685	35
34069	14" / 35.6 cm	Bath Tub Protector	038753340692	35
34070	16" / 40.6 cm	Bath Tub Protector	038753340708	35
34076	16" / 40.6 cm	Bath Tub Protector – Oval	038753340760	25
34125	14" – 16" / 35.6 - 40.6 cm	Multi-Size Adjustable Bath Tub Protector	038753341255	35



**Oatey® Tub Box**

- Provides a quick, economical and clean method of installing tub waste and drain.
- Built in cut-out for up to 2" Schedule 40 drain.
- Enables installer to form a clean cavity in a concrete slab so a trap can be easily connected to the drain system.
- Manufactured from semi-flexible, very durable, plastic polymer.
- Bottom I.D.: 11.5" x 11.5" / 29.2 x 29.2 cm. Top I.D.: 13" x 13", Depth 6.5" / 33 x 33 cm, Depth 16.5 cm.

Product No.	Size	Description	UPC	Ctn. Qty.
34080		Standard Tub Box	038753340807	12



### Oatey® TB-2000® Tub Box

- Provides a quick, economical and clean method of installing tub waste and drain.
- Built in cut-out for up to 2" Schedule 40 drain.
- Enables installer to form a clean cavity in a concrete slab so a trap can be easily connected to the drain system.
- Manufactured from semi-flexible, very durable, plastic polymer.
- Bottom I.D.: 11.5" x 11.5" / 29.2 x 29.2 cm. Top I.D.: 13" x 13", Depth 6.5" / 33 x 33 cm, Depth 16.5 cm.

Product No.	Size	Description	UPC	Ctn. Qty.
34087		TB 2000 Tub Box	038753340876	5



### Oatey® Knock-Out™ Test Cap

- Solvent cements to Sch. 40 ABS and PVC DWV pipe.
- Deeper design provides stronger leak-free connections.
- "Tab" feature keeps hands free of solvent cement.
- Will withstand 10 PSI or 30' head pressure.

Product No.	Size	Description	UPC	Ctn. Qty.
33460	1.5"	Knock Out Plug, ABS	038753334608	100
33461	2"	Knock Out Plug, ABS	038753334615	100
33462	3"	Knock Out Plug, ABS	038753334622	50
33463	4"	Knock Out Plug, ABS	038753334639	25
39100	1-1/2"	Knock Out Test Cap w/Barcode	038753391007	20
39101	2"	Knock Out Test Cap w/Barcode	038753391014	20
39102	3"	Knock Out Test Cap w/Barcode	038753391021	15
39103	4"	Knock Out Test Cap w/Barcode	038753391038	15



### Oatey® End-Cap™ Test Cap

- Solvent cements to end of Sch. 40 ABS and PVC DWV pipe.
- Deep design provides extra sealing strength.
- Heavy duty design allows testing to 15 PSI or 40' head pressure.

Product No.	Size	Description	UPC	Ctn. Qty.
33468	1-1/2"	End-Cap™ Test Cap	038753334684	100
33469	1-1/2"	End-Cap™ Test Cap	038753334691	100
33470	2"	End-Cap™ Test Cap	038753334707	100
33472	3"	End-Cap™ Test Cap	038753334721	50
33473	3"	End-Cap™ Test Cap	038753334738	50

ROUGH-IN PRODUCTS



**Cherne® PVC Test-Kap® Plugs**

- Stainless steel hose clamp won't corrode.
- For use on plastic, steel, copper and cast-iron pipe.
- Reinforced cross-molded top increases strength.
- Tighten clamp with torque wrench or screwdriver to 60 inch pounds.

Product No.	Size	Description	UPC	Ctn. Qty.
270725	1-1/2"	Test-Kap® Plug	675115270725	1
270733	2"	Test-Kap® Plug	675115270732	1
270741	3"	Test-Kap® Plug	675115270749	1
270768	4"	Test-Kap® Plug	675115270763	1
270776	5"	Test-Kap® Plug	675115270770	1
270784	6"	Test-Kap® Plug	675115270787	1



**Oatey SCS® Canada**  
**145 Walker Dr. Unit #3, Brampton, Ontario, L6T 5P5 Canada**  
**Phone: 800.321.9532**  
**Fax: 800.321.9535**  
**Oatey.ca**