



WARD MFG

PRODUCT CATALOG

6TH EDITION

Effective: September 12, 2023

HISTORY OF WARD MFG

“WARD'S MISSION IS PROFITABLE GROWTH BY EXCEEDING CUSTOMER EXPECTATIONS THROUGH INNOVATION, QUALITY, AND COMMITMENT.”

After nearly a century, Ward Manufacturing, LLC ("Ward") maintains a leading role in the manufacturing and distribution of piping components utilized around the world. Ward is committed to its customers and will continually invest in machinery and people in order to uphold its position in the industry as a global leader.

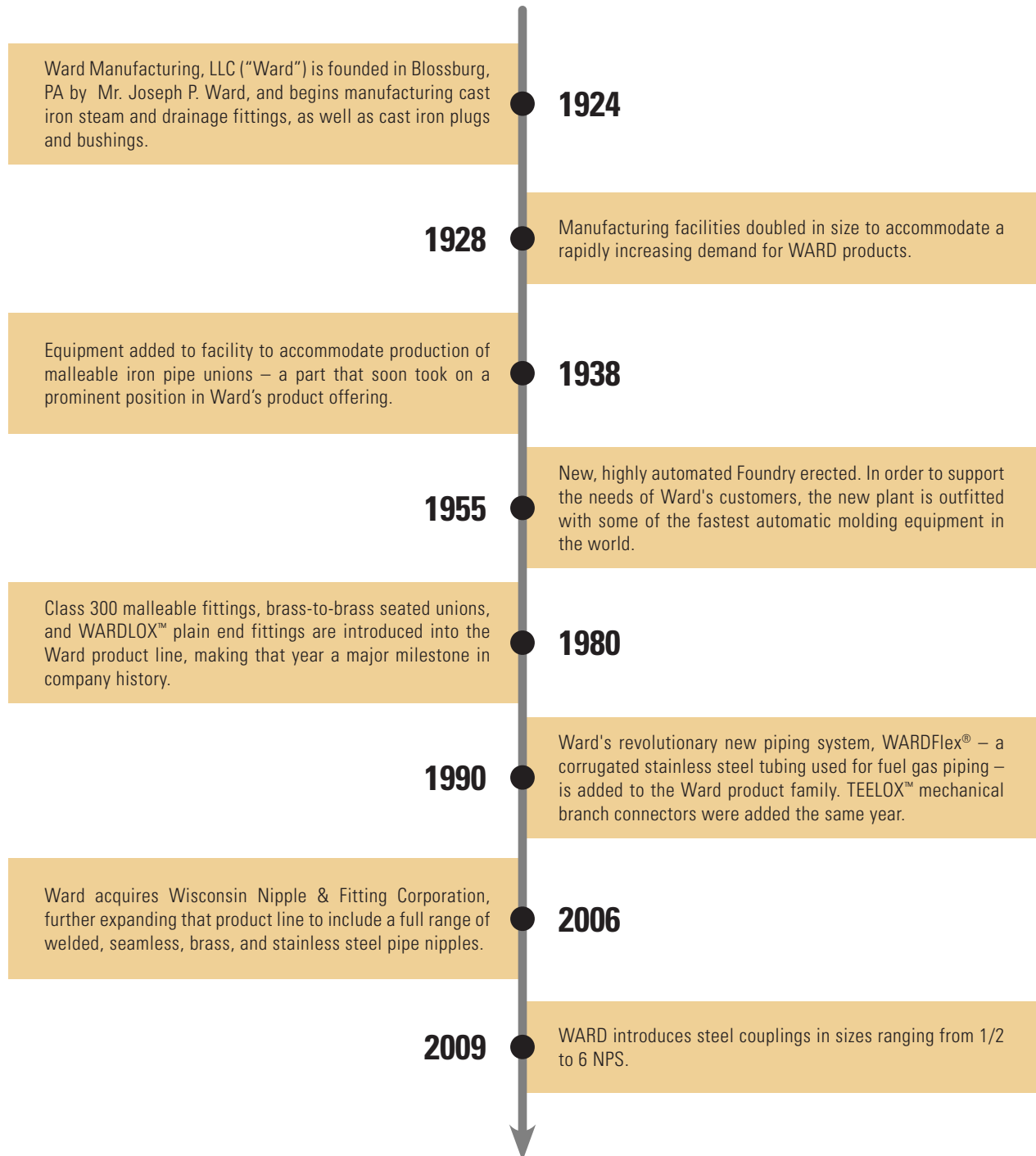

TABLE OF CONTENTS

SECTION 1 - MALLEABLE IRON.....	p. 4
Class 150 Malleable Iron Pipe Fittings.....	p. 6
Class 300 Extra Heavy Malleable Iron Pipe Fittings	p. 13
Class 150, Class 250, & Class 300 Unions	p. 16
SECTION 2 - CAST IRON	p. 18
Class 125 Cast Iron Pipe Fittings	p. 21
Class 250 Cast Iron Pipe Fittings	p. 28
Flanges, Flange Unions, Companion Flanges, Flanged Pipe Fittings	p. 29
Cast Iron Drainage Pipe Fittings	p. 36
SECTION 3 - CAPS, PLUGS, AND BUSHINGS	p. 40
SECTION 4 - WARDLOX™ FITTINGS	p. 45
SECTION 5 - TEELOX™ FITTINGS	p. 48
SECTION 6 - MERCHANT COUPLINGS.....	p. 49
SECTION 7 - PIPE NIPPLES	p. 50

SECTION 1

MALLEABLE IRON



Ward Manufacturing ("Ward") Class 150 & 300 Malleable Iron Pipe Fittings are made in accordance with ASME B.16.3 with threads that meet the requirements of ASME B1.20.1. In addition, Ward fittings have a chamfered opening to allow faster and easier pipe engagement. This feature also protects the fitting threads from damage during handling. All Ward black and galvanized Class 150 malleable iron pipe fittings with outlets ranging from 1/2" through 4" are air tested.

Ward Class 150, 250, & 300 Unions are made from closely grained, high tensile malleable iron. Each one is suitably chamfered, rust-resistant, properly threaded, and uses extra heavy brass rings to insure perfect seating during difficult conditions. Ward unions are manufactured in strict accordance with ASME B16.39.

CLASS 150 & 300 MALLEABLE IRON PIPE FITTINGS SPECIFICATIONS

Material: ASTM A197
Dimensions: ASME B16.3
Threading: ASME B1.20.1
Pressure Ratings: ASME B16.3
Coatings: ASTM A153, ASTM B633
Additional Specifications: UL, ULC, FM, NSF 61 and NSF 372 where applicable

Class 150 Pressure / Temperature Ratings

Temp F°	PSI
-20 to 150	300
200	265
250	225
300	185
350	150
366	150

Class 150 General Dimensions / In Inches

These dimensions apply to all standard malleable banded fittings, both straight and reducing. Length of thread also applies to plain fittings. For center-to-face dimensions, see fittings tables.

NPS	1/8	1/4	3/8	1/2	3/4	1	1-1/4	1-1/2	2	2-1/2	3	3-1/2	4
O.D. of Band (min)	0.69	0.84	1.01	1.20	1.46	1.77	2.15	2.43	2.96	3.59	4.28	4.84	5.40
Thread Length (min)	0.25	0.32	0.36	0.43	0.50	0.58	0.67	0.70	0.75	0.92	0.98	1.03	1.08

Class 300 General Dimensions / In Inches

These dimensions apply to both straight and reducing fittings.

NPS	O.D. of Bands	Thread Length (min)
1/4	0.93	0.43
3/8	1.12	0.48
1/2	1.34	0.56
3/4	1.62	0.62
1	1.93	0.75
1-1/4	2.37	0.84
1-1/2	2.68	0.87
2	3.28	1.00
3	4.62	1.23

Class 300 Pressure / Temperature Ratings

Temp. F	PSI		
	Size 1/4 - 1	Size 1-1/4 - 2	Size 2-1/2 - 3
-20 TO 150	2000	1500	1000
200	1785	1350	910
250	1575	1200	825
300	1360	1050	735
350	1150	900	650
400	935	750	560
450	725	600	475
500	510	450	385
550	300	300	300

UNION SPECIFICATIONS

Material: ASTM A197
Dimensions: ASME B16.39
Threading: ASME B1.20.1
Pressure Ratings: ASME B16.39
Coatings: ASTM A153, ASTM B633
Additional Specifications: UL, ULC, FM, NSF 61, and NSF 372 where applicable

Temp. F	PSI		
	Class 150	Class 250	Class 300
-20 TO 150	300	500	600
200	265	455	550
250	225	405	505
300	185	360	460
350	150	315	415
400	110	270	370
450	75	225	325
500	—	180	280
550	—	130	230

CLASS 150 FITTINGS



MALLEABLE IRON 90° ELL CLASS 150

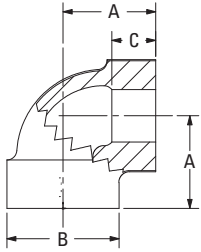

NPS	CENTER TO END A	OUTSIDE DIA. OF BAND B (MIN)	LENGTH OF THREADS C (MIN)	TAKE OUT
1/8	0.69	0.69	0.25	0.42
1/4	0.81	0.84	0.32	0.40
3/8	0.95	1.01	0.36	0.54
1/2	1.12	1.20	0.43	0.58
3/4	1.31	1.46	0.50	0.76
1	1.50	1.77	0.58	0.81
1-1/4	1.75	2.15	0.67	1.04
1-1/2	1.94	2.43	0.70	1.21
2	2.25	2.96	0.75	1.49
2-1/2	2.70	3.59	0.92	1.56
3	3.08	4.28	0.98	1.88
3-1/2	3.42	4.84	1.03	2.17
4	3.79	5.40	1.08	2.49
5	4.50	7.05	1.18	3.59
6	5.13	7.77	1.28	3.61

CLASS 300 FITTINGS



MALLEABLE IRON REDUCING 90° ELL CLASS 150

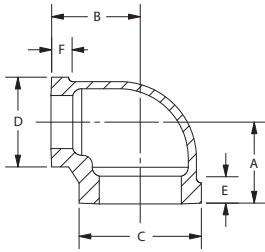

NPS	CENTER TO END A	CENTER TO END B	OUTSIDE DIA. BAND C (MIN)	OUTSIDE DIA. BAND D (MIN)	LENGTH THREAD E (MIN)	LENGTH THREAD F (MIN)	TAKE OUT	TAKE OUT
1/4 x 1/8	0.74	0.76	0.84	0.69	0.32	0.25	0.33	0.49
3/8 x 1/8	0.81	0.85	1.01	0.69	0.36	0.25	0.44	0.55
3/8 x 1/4	0.88	0.90	1.01	0.84	0.36	0.32	0.47	0.49
1/2 x 1/4	0.97	0.98	1.20	0.84	0.43	0.32	0.43	0.57
1/2 x 3/8	1.04	1.03	1.20	1.01	0.43	0.36	0.50	0.62
3/4 x 1/4	1.05	1.08	1.46	0.84	0.50	0.32	0.53	0.65
3/4 x 3/8	1.12	1.13	1.46	1.01	0.50	0.36	0.57	0.72
3/4 x 1/2	1.20	1.22	1.46	1.20	0.50	0.43	0.65	0.68
1 x 3/8	1.18	1.27	1.77	1.01	0.58	0.36	0.49	0.86
1 x 1/2	1.26	1.36	1.77	1.20	0.58	0.43	0.57	0.82
1 x 3/4	1.37	1.45	1.77	1.46	0.58	0.50	0.68	0.90
1-1/4 x 1/2	1.34	1.53	2.15	1.20	0.67	0.43	0.63	0.99
1-1/4 x 3/4	1.45	1.62	2.15	1.46	0.67	0.50	0.74	1.07
1-1/4 x 1	1.58	1.67	2.15	1.77	0.67	0.58	0.87	0.98
*1-1/2 x 1/2	1.41	1.66	2.43	1.20	0.70	0.43	0.68	1.12
1-1/2 x 3/4	1.52	1.75	2.43	1.46	0.70	0.50	0.79	1.20
1-1/2 x 1	1.65	1.80	2.43	1.77	0.70	0.58	0.92	1.11
1-1/2 x 1-1/4	1.82	1.88	2.43	2.15	0.70	0.67	1.09	1.47
*2 x 1/2	1.49	1.88	2.96	1.20	0.75	0.43	0.73	1.34
2 x 3/4	1.60	1.97	2.96	1.46	0.75	0.50	0.84	1.42
2 x 1	1.73	2.02	2.96	1.77	0.75	0.58	0.97	1.33
2 x 1-1/4	1.90	2.10	2.96	2.15	0.75	0.67	1.14	1.69
2 x 1-1/2	2.02	2.16	2.96	2.43	0.75	0.70	1.26	1.63
2-1/2 x 1-1/2	2.16	2.51	3.59	2.43	0.92	0.70	1.02	1.78
2-1/2 x 2	2.39	2.60	3.59	2.96	0.92	0.75	1.25	1.84
3 x 2	2.52	2.89	4.28	2.96	0.98	0.75	1.32	2.13
3 x 2-1/2	2.83	2.99	4.28	2.43	0.98	0.92	1.79	1.69
4 x 3	3.30	3.60	5.40	4.28	1.08	0.98	2.00	2.40

*Manufactured to Ward specifications

CLASS 150, 250, & 300 UNIONS



MALLEABLE IRON 45° ELL CLASS 150

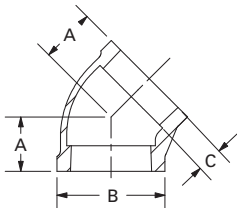

NPS	CENTER TO END A	OUTSIDE DIA. BAND B	LENGTH THREADS C (MIN)	TAKE OUT
1/8	0.73	0.69	0.25	0.46
1/4	0.73	0.84	0.32	0.32
3/8	0.80	1.01	0.36	0.39
1/2	0.88	1.20	0.43	0.34
3/4	0.98	1.46	0.50	0.43
1	1.12	1.77	0.58	0.43
1-1/4	1.29	2.15	0.67	0.58
1-1/2	1.43	2.43	0.70	0.70
2	1.68	2.96	0.75	0.92
2-1/2	1.95	3.59	0.92	0.81
3	2.17	4.28	0.98	0.97
4	2.61	5.40	1.08	1.31
5	3.05	7.05	1.18	1.64
6	3.46	8.28	1.28	1.95



**MALLEABLE IRON
90° STREET ELL
CLASS 150**

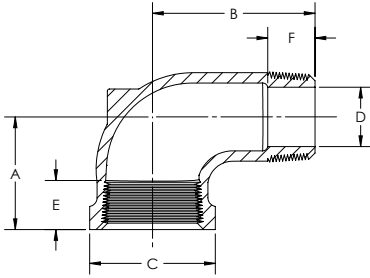

NPS	CENTER TO END A	CENTER TO MALE B	OUTSIDE DIA. BAND C (MIN)	PORT DIA. MALE END D (MAX)	LENGTH INTERNAL THREADS E (MIN)	LENGTH EXTERNAL THREADS F (MIN)	TAKE OUT MALE END	TAKE OUT FEMALE END
1/8	0.69	1.00	0.69	0.20	0.25	0.26	0.73	0.42
1/4	0.81	1.19	0.84	0.26	0.32	0.40	0.78	0.40
3/8	0.95	1.44	1.01	0.37	0.36	0.41	1.03	0.54
1/2	1.12	1.63	1.20	0.51	0.43	0.53	1.09	0.58
3/4	1.31	1.89	1.46	0.69	0.50	0.55	1.34	0.76
1	1.50	2.14	1.77	0.91	0.58	0.68	1.45	0.81
1-1/4	1.75	2.45	2.15	1.19	0.67	0.71	1.74	1.04
1-1/2	1.94	2.69	2.43	1.39	0.70	0.72	1.96	1.21
2	2.25	3.26	2.96	1.79	0.75	0.76	2.50	1.49
2-1/2	2.70	3.86	3.59	2.20	0.92	1.14	2.72	1.56
3	3.08	4.51	4.28	2.78	0.98	1.20	3.31	1.88
4	3.79	5.69	5.40	3.70	1.08	1.30	2.49	4.39
*1/2 x 3/8	1.12	1.56	1.20	0.37	0.43	0.41	0.59	1.15
*3/4 x 1/2	1.31	1.76	1.46	0.51	0.50	0.53	1.21	0.77
*1 x 3/4	1.50	2.02	1.77	0.69	0.58	0.55	0.82	1.47
*1-1/4 x 3/4	1.75	2.17	2.15	0.69	0.67	0.55	1.04	1.62
*1-1/4 x 1	1.75	2.29	2.15	0.91	0.67	0.68	1.58	1.06
*1-1/2 x 1	1.94	2.54	2.43	0.91	0.70	0.68	1.81	1.25
*1-1/2 x 1-1/4	1.81	2.62	2.43	1.19	0.70	0.72	1.90	1.10
*2 x 1-1/2	2.25	2.94	2.96	1.39	0.75	0.72	1.49	2.21

*Manufactured to Ward specifications



**MALLEABLE IRON
STREET 45° ELL
CLASS 150**

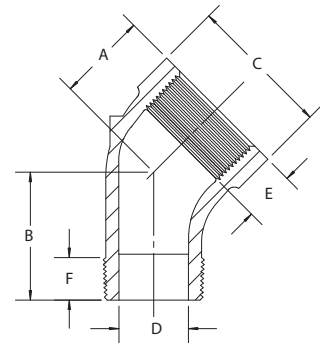

NPS	CENTER TO END A	CENTER TO MALE B	OUTSIDE DIA. BAND C (MIN)	PORT DIA. MALE END D (MAX)	LENGTH INTERNAL THREADS E (MIN)	LENGTH EXTERNAL THREADS F (MIN)	TAKE OUT MALE END	TAKE OUT FEMALE END
1/8	0.69	0.94	0.69	0.20	0.25	0.26	0.67	0.42
1/4	0.73	0.94	0.84	0.26	0.32	0.40	0.53	0.32
3/8	0.80	1.03	1.01	0.37	0.36	0.41	0.62	0.39
1/2	0.88	1.15	1.20	0.51	0.43	0.53	0.61	0.34
3/4	0.98	1.29	1.46	0.69	0.50	0.55	0.74	0.43
1	1.12	1.47	1.77	0.91	0.58	0.68	0.78	0.43
1-1/4	1.29	1.71	2.15	1.19	0.67	0.71	1.00	0.58
1-1/2	1.43	1.88	2.43	1.39	0.70	0.72	1.15	0.70
2	1.68	2.22	2.96	1.79	0.75	0.76	1.46	0.92



**MALLEABLE IRON
TEES CLASS 150**

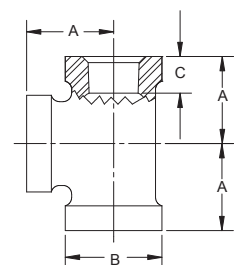

NPS	CENTER TO END A	OUTSIDE DIA. BAND B (MIN)	LENGTH THREADS C (MIN)	TAKE OUT
1/8	0.69	0.69	0.25	0.42
1/4	0.81	0.84	0.32	0.40
3/8	0.95	1.01	0.36	0.54
1/2	1.12	1.20	0.43	0.58
3/4	1.31	1.46	0.50	0.76
1	1.50	1.77	0.58	0.81
1-1/4	1.75	2.15	0.67	1.04
1-1/2	1.94	2.43	0.70	1.21
2	2.25	2.96	0.75	1.49
2-1/2	2.70	3.59	0.92	1.56
3	3.08	4.28	0.98	1.88
3-1/2	3.42	4.84	1.03	2.22
4	3.79	5.40	1.08	2.49
6	5.13	8.28	1.28	3.62



**MALLEABLE IRON
REDUCING TEES
CLASS 150**

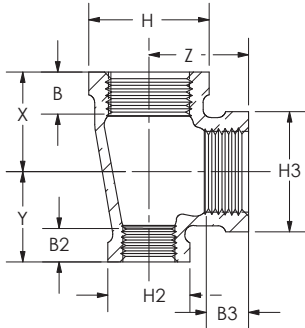

NPS	CENTER TO END X	CENTER TO END Y	CENTER TO END Z	THREAD LENGTH B (MIN)	THREAD LENGTH B2 (MIN)	THREAD LENGTH B3 (MIN)	OUTSIDE DIA. H (MIN)	OUTSIDE DIA. H2 (MIN)	OUTSIDE DIA. H3 (MIN)	TAKE OUT	TAKE OUT	TAKE OUT
1/8 x 1/8 x 1/4	0.76	0.76	0.74	0.25	0.25	0.32	0.69	0.69	0.84	0.50	0.50	0.34
1/4 x 1/4 x 1/8	0.74	0.74	0.76	0.32	0.32	0.25	0.84	0.84	0.69	0.34	0.34	0.50
1/4 x 1/4 x 3/8	0.90	0.90	0.88	0.32	0.32	0.36	0.84	0.84	1.01	0.49	0.49	0.47
3/8 x 1/4 x 1/4	0.88	0.81	0.90	0.36	0.32	0.32	1.01	0.84	0.84	0.47	0.41	0.49
3/8 x 3/8 x 1/4	0.88	0.88	0.90	0.36	0.36	0.32	1.01	1.01	0.84	0.47	0.47	0.49
3/8 x 3/8 x 1/2	1.03	1.03	1.04	0.36	0.36	0.43	1.01	1.01	1.20	0.62	0.62	0.50
1/2 x 1/4 x 1/2	1.12	0.98	1.12	0.43	0.32	0.43	1.20	0.84	1.20	0.58	0.60	0.58
1/2 x 3/8 x 3/8	1.04	0.95	1.03	0.43	0.36	0.36	1.20	1.01	1.01	0.50	0.54	0.62
1/2 x 3/8 x 1/2	1.12	1.03	1.12	0.43	0.36	0.43	1.20	1.01	1.20	0.58	0.62	0.58
1/2 x 1/2 x 1/4	0.97	0.97	0.98	0.43	0.43	0.32	1.20	1.20	0.84	0.43	0.43	0.57
1/2 x 1/2 x 3/8	1.04	1.04	1.03	0.43	0.43	0.36	1.20	1.20	1.01	0.50	0.50	0.62
1/2 x 1/2 x 3/4	1.22	1.22	1.20	0.43	0.43	0.50	1.20	1.20	1.46	0.68	0.68	0.65
1/2 x 1/2 x 1	1.36	1.36	1.26	0.43	0.43	0.58	1.20	1.20	1.77	0.83	0.83	0.58
3/4 x 1/4 x 3/4	1.31	1.08	1.31	0.50	0.32	0.50	1.46	0.84	1.46	0.76	0.67	0.76
3/4 x 3/8 x 3/8	1.12	0.95	1.13	0.50	0.36	0.36	1.46	1.01	1.01	0.57	0.54	0.72
3/4 x 3/8 x 3/4	1.31	1.13	1.13	0.50	0.36	0.50	1.46	1.01	1.46	0.76	0.72	0.58
3/4 x 1/2 x 1/2	1.20	1.12	1.22	0.50	0.43	0.43	1.46	1.20	1.20	0.65	0.58	0.68
3/4 x 1/2 x 3/4	1.31	1.22	1.31	0.50	0.43	0.50	1.46	1.20	1.46	0.76	0.68	0.76
3/4 x 3/4 x 1/4	1.05	1.05	1.08	0.50	0.50	0.32	1.46	1.46	0.84	0.50	0.50	0.67
3/4 x 3/4 x 3/8	1.12	1.12	1.13	0.50	0.50	0.36	1.46	1.46	1.01	0.57	0.57	0.72
3/4 x 3/4 x 1/2	1.20	1.20	1.22	0.50	0.50	0.43	1.46	1.46	1.20	0.65	0.65	0.68
3/4 x 3/4 x 1	1.45	1.45	1.37	0.50	0.50	0.58	1.46	1.46	1.77	0.90	0.90	0.68
3/4 x 3/4 x 1-1/4	1.62	1.62	1.45	0.50	0.50	0.67	1.46	1.46	2.15	1.07	1.07	0.74
*1 x 1/4 x 1	1.50	1.20	1.50	0.58	0.32	0.58	1.77	0.84	1.77	0.81	0.79	0.81
1 x 1/2 x 1/2	1.26	1.12	1.36	0.58	0.43	0.43	1.77	1.20	1.20	0.57	0.58	0.82
1 x 1/2 x 3/4	1.37	1.22	1.45	0.58	0.43	0.50	1.77	1.20	1.46	0.68	0.68	0.90
1 x 1/2 x 1	1.50	1.36	1.50	0.58	0.43	0.58	1.77	1.20	1.77	0.81	0.82	0.81
1 x 3/4 x 1/2	1.26	1.20	1.36	0.58	0.50	0.43	1.77	1.46	1.20	0.57	0.65	0.82
1 x 3/4 x 3/4	1.37	1.31	1.45	0.58	0.50	0.50	1.77	1.46	1.46	0.68	0.76	0.90
1 x 3/4 x 1	1.50	1.45	1.50	0.58	0.50	0.58	1.77	1.46	1.77	0.81	0.90	0.81
1 x 1 x 1/4	1.11	1.11	1.22	0.58	0.58	0.32	1.77	1.77	0.84	0.42	0.42	0.81
1 x 1 x 3/8	1.18	1.18	1.27	0.58	0.58	0.36	1.77	1.77	1.01	0.49	0.49	0.86
1 x 1 x 1/2	1.26	1.26	1.36	0.58	0.58	0.43	1.77	1.77	1.20	0.57	0.57	0.82
1 x 1 x 3/4	1.37	1.37	1.45	0.58	0.58	0.50	1.77	1.77	1.46	0.68	0.68	0.90
1 x 1 x 1-1/4	1.67	1.67	1.58	0.58	0.58	0.67	1.77	1.77	2.15	0.98	0.96	0.87
1 x 1 x 1-1/2	1.80	1.80	1.65	0.58	0.58	0.70	1.77	1.77	2.43	1.11	1.11	0.92
1 x 1 x 2	2.02	2.02	1.73	0.58	0.58	0.75	1.77	1.77	2.96	1.34	1.34	0.97
1-1/4 x 1/2 x 1	1.58	1.36	1.67	0.67	0.43	0.58	2.15	1.20	1.77	0.87	0.83	0.99
1-1/4 x 1/2 x 1-1/4	1.75	1.53	1.75	0.67	0.43	0.67	2.15	1.20	2.15	1.04	0.99	1.04
1-1/4 x 3/4 x 3/4	1.45	1.31	1.62	0.67	0.50	0.50	2.15	1.46	1.46	0.74	0.76	1.07
1-1/4 x 3/4 x 1	1.58	1.45	1.67	0.67	0.50	0.58	2.15	1.46	1.77	0.87	0.90	0.98
1-1/4 x 3/4 x 1-1/4	1.75	1.62	1.75	0.67	0.50	0.67	2.15	1.46	2.15	1.04	1.07	1.04
1-1/4 x 1 x 1/2	1.34	1.26	1.53	0.67	0.58	0.43	2.15	1.77	1.20	0.63	0.57	0.99
1-1/4 x 1 x 3/4	1.45	1.37	1.62	0.67	0.58	0.50	2.15	1.77	1.46	0.74	0.68	1.07
1-1/4 x 1 x 1	1.58	1.50	1.67	0.67	0.58	0.58	2.15	1.77	1.77	0.87	0.81	0.98
1-1/4 x 1 x 1-1/4	1.75	1.67	1.75	0.67	0.58	0.67	2.15	1.77	2.15	1.04	0.98	1.04
1-1/4 x 1-1/4 x 3/8	1.26	1.26	1.44	0.67	0.67	0.36	2.15	2.15	1.01	0.55	0.55	1.03
1-1/4 x 1-1/4 x 1/2	1.34	1.34	1.53	0.67	0.67	0.43	2.15	2.15	1.20	0.63	0.63	0.99
1-1/4 x 1-1/4 x 3/4	1.45	1.45	1.62	0.67	0.67	0.50	2.15	2.15	1.46	0.74	0.74	1.07
1-1/4 x 1-1/4 x 1	1.58	1.58	1.67	0.67	0.67	0.58	2.15	2.15	1.77	0.87	0.87	0.98
1-1/4 x 1-1/4 x 1-1/2	1.88	1.88	1.82	0.67	0.67	0.70	2.15	2.15	2.43	1.17	1.17	1.09
1-1/4 x 1-1/4 x 2	2.10	2.10	1.90	0.67	0.67	0.75	2.15	2.15	2.96	1.39	1.39	1.14
1-1/2 x 1/2 x 1-1/2	1.94	1.66	1.94	0.70	0.43	0.70	2.43	1.20	2.43	1.21	1.12	1.21
*1-1/2 x 3/4 x 3/4	1.55	1.35	1.77	0.70	0.50	0.50	2.43	1.46	1.46	0.82	0.80	1.22
1-1/2 x 3/4 x 1-1/2	1.94	1.75	1.94	0.70	0.50	0.70	2.43	1.46	2.43	1.21	1.20	1.21
1-1/2 x 1 x 1	1.65	1.50	1.80	0.70	0.58	0.58	2.43	1.77	1.77	0.92	0.81	1.11
1-1/2 x 1 x 1-1/4	1.82	1.67	1.88	0.70	0.58	0.67	2.43	1.77	2.15	1.10	0.99	1.17
1-1/2 x 1 x 1-1/2	1.94	1.80	1.94	0.70	0.58	0.70	2.43	1.77	2.43	1.21	1.11	1.21
1-1/2 x 1-1/4 x 1/2	1.41	1.34	1.66	0.70	0.67	0.43	2.43	2.15	1.20	0.68	0.63	1.12
1-1/2 x 1-1/4 x 3/4	1.52	1.45	1.75	0.70	0.67	0.50	2.43	2.15	1.46	0.79	0.74	1.20
1-1/2 x 1-1/4 x 1	1.65	1.58	1.80	0.70	0.67	0.58	2.43	2.15	1.77	0.92	0.87	1.11
1-1/2 x 1-1/4 x 1-1/4	1.82	1.75	1.88	0.70	0.67	0.67	2.43	2.15	2.15	1.09	1.04	1.17
1-1/2 x 1-1/4 x 1-1/2	1.94	1.88	1.94	0.70	0.67	0.70	2.43	2.15	2.43	1.21	1.17	1.21
1-1/2 x 1-1/2 x 1/2	1.41	1.41	1.66	0.70	0.70	0.43	2.43	2.43	1.20	0.68	0.68	1.12
1-1/2 x 1-1/2 x 3/4	1.52	1.52	1.75	0.70	0.70	0.50	2.43	2.43	1.46	0.79	0.79	1.20
1-1/2 x 1-1/2 x 1	1.65	1.65	1.80	0.70	0.70	0.58	2.43	2.43	1.77	0.92	0.92	1.11
1-1/2 x 1-1/2 x 1-1/4	1.82	1.82	1.88	0.70	0.70	0.67	2.43	2.43	2.15	1.09	1.09	1.17
1-1/2 x 1-1/2 x 2	2.16	2.16	2.02	0.70	0.70	0.75	2.43	2.43	2.96	1.44	1.44	1.26

*Manufactured to Ward specifications



**MALLEABLE IRON
REDUCING TEES
CLASS 150, cont.**

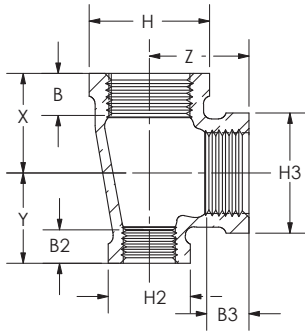

NPS	CENTER TO END X	CENTER TO END Y	CENTER TO END Z	THREAD LENGTH B (MIN)	THREAD LENGTH B2 (MIN)	THREAD LENGTH B3 (MIN)	OUTSIDE DIA. H (MIN)	OUTSIDE DIA. H2 (MIN)	OUTSIDE DIA. H3 (MIN)	TAKE OUT	TAKE OUT	TAKE OUT
2 x 1/2 x 2	2.25	1.88	2.25	0.75	0.43	0.75	2.96	1.20	2.96	1.49	1.34	1.49
2 x 3/4 x 2	2.25	1.97	2.25	0.75	0.50	0.75	2.96	1.46	2.96	1.49	1.42	1.49
*2 x 1 x 1	1.78	1.68	2.08	0.75	0.58	0.58	2.96	1.77	1.77	1.02	0.99	1.39
2 x 1 x 2	2.25	2.02	2.25	0.75	0.58	0.75	2.96	1.77	2.96	1.49	1.33	1.49
2 x 1-1/4 x 1-1/4	1.90	1.75	2.10	0.75	0.67	0.67	2.96	2.15	2.15	1.14	1.04	1.39
2 x 1-1/4 x 1-1/2	2.02	1.88	2.16	0.75	0.67	0.70	2.96	2.15	2.43	1.26	1.17	1.44
2 x 1-1/4 x 2	2.25	2.10	2.25	0.75	0.67	0.75	2.96	2.15	2.96	1.49	1.39	1.49
2 x 1-1/2 x 1	1.73	1.65	2.02	0.75	0.70	0.58	2.96	2.43	1.77	0.97	0.92	1.33
2 x 1-1/2 x 1-1/2	2.02	1.94	2.16	0.75	0.70	0.70	2.96	2.43	2.43	1.26	1.21	1.43
2 x 1-1/2 x 1-1/4	1.90	1.82	2.10	0.75	0.70	0.67	2.96	2.43	2.15	1.14	1.09	1.39
2 x 1-1/2 x 2	2.25	2.16	2.25	0.75	0.70	0.75	2.96	2.43	2.96	1.49	1.43	1.49
2 x 2 x 1/2	1.49	1.49	1.88	0.75	0.75	0.43	2.96	2.96	1.20	0.73	0.73	1.34
2 x 2 x 3/4	1.60	1.60	1.97	0.75	0.75	0.50	2.96	2.96	1.46	0.84	0.84	1.42
2 x 2 x 1	1.73	1.73	2.02	0.75	0.75	0.58	2.96	2.96	1.77	0.97	0.97	1.33
2 x 2 x 1-1/4	1.90	1.90	2.10	0.75	0.75	0.67	2.96	2.96	2.15	1.14	1.14	1.39
2 x 2 x 2-1/2	2.60	2.60	2.39	0.75	0.75	0.92	2.96	2.96	3.59	1.84	1.84	1.25
2-1/2 x 1-1/2 x 2	2.39	2.16	2.60	0.92	0.70	0.75	3.59	2.43	2.96	1.25	1.44	1.84
2-1/2 x 1-1/2 x 2-1/2	2.70	2.51	2.70	0.92	0.70	0.92	3.59	2.43	3.59	1.56	1.79	1.56
2-1/2 x 2 x 2	2.39	2.25	2.60	0.92	0.75	0.75	3.59	2.96	2.96	1.25	1.49	1.84
2-1/2 x 2 x 2-1/2	2.70	2.60	2.70	0.92	0.75	0.92	3.59	2.96	3.59	1.56	1.84	1.56
2-1/2 x 2-1/2 x 3/4	1.74	1.74	2.32	0.92	0.92	0.50	3.59	3.59	1.46	0.60	0.60	1.77
2-1/2 x 2-1/2 x 1	1.87	1.87	2.37	0.92	0.92	0.58	3.59	3.59	1.77	0.73	0.73	1.68
2-1/2 x 2-1/2 x 1-1/4	2.04	2.04	2.45	0.92	0.92	0.67	3.59	3.59	2.15	0.90	0.90	1.74
2-1/2 x 2-1/2 x 1-1/2	2.16	2.16	2.51	0.92	0.92	0.70	3.59	3.59	2.43	1.02	1.02	1.78
2-1/2 x 2-1/2 x 2	2.39	2.39	2.60	0.92	0.92	0.75	3.59	3.59	2.96	1.25	1.25	1.84
2-1/2 x 2-1/2 x 3	2.99	2.99	2.83	0.92	0.92	0.98	3.59	3.59	4.28	1.85	1.85	1.63
3 x 2 x 2	2.52	2.25	2.89	0.98	0.75	0.75	4.28	2.96	2.96	1.32	1.49	2.13
3 x 2 x 3	3.08	2.89	3.08	0.98	0.75	0.98	4.28	2.96	4.28	1.88	2.13	1.88
3 x 2 1/2 x 2	2.52	2.39	2.89	0.98	0.92	0.75	4.28	3.59	2.96	1.32	1.25	2.13
3 x 2-1/2 x 2-1/2	2.83	2.70	2.99	0.98	0.92	0.92	4.28	3.59	3.59	1.63	1.56	1.85
3 x 3 x 3/4	1.87	1.87	2.61	0.98	0.98	0.50	4.28	4.28	1.46	0.67	0.67	2.06
3 x 3 x 1	2.00	2.00	2.66	0.98	0.98	0.58	4.28	4.28	1.77	0.80	0.80	1.97
3 x 3 x 1-1/4	2.17	2.17	2.74	0.98	0.98	0.67	4.28	4.28	2.15	0.97	0.97	2.03
3 x 3 x 1-1/2	2.29	2.29	2.80	0.98	0.98	0.70	4.28	4.28	2.43	1.09	1.09	2.07
3 x 3 x 2	2.52	2.52	2.89	0.98	0.98	0.75	4.28	4.28	2.96	1.32	1.32	2.13
3 x 3 x 2-1/2	2.83	2.83	2.99	0.98	0.98	0.92	4.28	4.28	3.59	1.63	1.63	1.85
4 x 4 x 1-1/2	2.51	2.51	3.32	1.08	1.08	0.70	5.40	5.40	2.43	1.21	1.21	2.60
4 x 4 x 2	2.74	2.74	3.41	1.08	1.08	0.75	5.40	5.40	2.96	1.44	1.44	2.65
4 x 4 x 2-1/2	3.05	3.05	3.51	1.08	1.08	0.92	5.40	5.40	3.59	1.75	1.75	2.37
4 x 3 x 4	3.79	3.60	3.79	1.08	0.98	1.08	5.40	4.28	5.40	2.49	2.40	2.49
4 x 4 x 3	3.30	3.30	3.60	1.08	1.08	0.98	5.40	5.40	4.28	2.00	2.00	2.40

*Manufactured to Ward specifications

CLASS 150 FITTINGS

CLASS 300 FITTINGS

CLASS 150, 250, & 300 UNIONS



MALLEABLE IRON WASTE NUTS CLASS 150

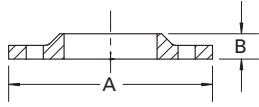

NPS	END TO END A	HEIGHT B
*1/2	2.42	0.34
*3/4	2.65	0.32
*1	2.99	0.37

*Manufactured to Ward specifications



MALLEABLE IRON STREET TEES CLASS 150

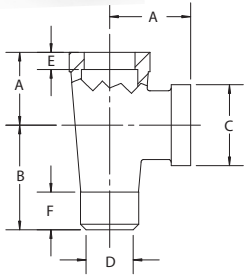

NPS	CENTER TO END A	CENTER TO MALE B	OUTSIDE DIA. BAND C (MIN)	PORT DIA. MALE END D (MAX)	LENGTH INTERNAL THREADS E (MIN)	LENGTH EXTERNAL THREADS F (MIN)	TAKE OUT MALE END	TAKE OUT FEMALE END
1/4	0.81	1.19	0.84	0.26	0.32	0.40	1.19	0.81
3/8	1.01	1.44	1.01	0.37	0.36	0.41	1.03	0.60
1/2	1.20	1.63	1.20	0.51	0.43	0.53	1.10	0.67
3/4	1.31	1.89	1.46	0.69	0.50	0.55	1.34	0.76
1	1.50	2.14	1.77	0.91	0.58	0.68	1.45	0.81
1-1/4	1.75	2.45	2.15	1.19	0.67	0.71	1.74	1.04
*1-1/4 x 1 x 1-1/4	1.75	2.45	2.15	0.91	0.67	0.68	1.76	1.04
1-1/2	1.94	2.69	2.43	1.39	0.70	0.72	1.96	1.21
2	2.25	3.26	2.96	1.79	0.75	0.76	2.50	1.49

*Manufactured to Ward specifications



MALLEABLE IRON COUPLING CLASS 150

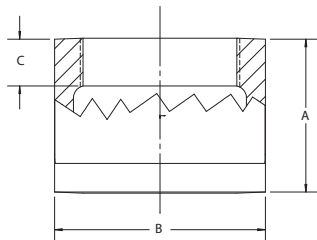

NPS	LENGTH COUPLING A	OUTSIDE DIA. BAND B (MIN)	LENGTH THREAD C (MIN)	TAKE OUT
+1/8	0.96	0.69	0.25	0.13
1/4	1.06	0.84	0.32	0.17
3/8	1.16	1.01	0.36	0.14
1/2	1.34	1.20	0.43	0.21
3/4	1.52	1.46	0.50	0.15
1	1.67	1.77	0.58	0.26
1-1/4	1.93	2.15	0.67	0.35
1-1/2	2.15	2.43	0.70	0.51
2	2.53	2.96	0.75	0.30
2-1/2	2.88	3.59	0.92	0.39
3	3.18	4.28	0.98	0.55
4	3.69	5.4	1.08	2.39

+Steel



MALLEABLE IRON COUPLING CLASS 150, Right & Left Thread Coupling

NPS	LENGTH COUPLING A	OUTSIDE DIA. BAND B (MIN)	LENGTH THREAD C (MIN)	TAKE OUT
1/2	1.34	1.20	0.43	0.14
3/4	1.52	1.46	0.5	0.21
1	1.67	1.77	0.58	0.15
1-1/4	1.93	2.15	0.67	0.26
1-1/2	2.15	2.43	0.70	0.35
2	2.53	2.96	0.75	0.51



**MALLEABLE IRON
REDUCING COUPLING
CLASS 150**

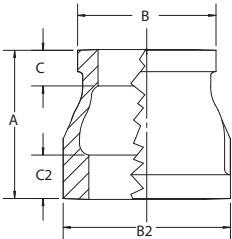

NPS	LENGTH COUPLING A	OUTSIDE DIA. SMALL BAND B (MIN)	OUTSIDE DIA. LARGE BAND B2 (MIN)	LENGTH THREADS SMALL END C (MIN)	LENGTH THREADS LARGE END C2 (MIN)	TAKE OUT	TAKE OUT
1/4 x 1/8	1.00	0.69	0.84	0.25	0.32	0.10	0.24
3/8 x 1/8	1.13	0.69	1.01	0.25	0.36	0.16	0.30
3/8 x 1/4	1.13	0.84	1.01	0.32	0.36	0.16	0.16
1/2 x 1/8	1.25	0.69	1.20	0.25	0.43	0.09	0.36
1/2 x 1/4	1.25	0.84	1.20	0.32	0.43	0.09	0.22
1/2 x 3/8	1.25	1.01	1.20	0.36	0.43	0.09	0.22
3/4 x 1/8	1.44	0.69	1.46	0.25	0.50	0.89	0.17
3/4 x 1/4	1.44	0.84	1.46	0.32	0.50	0.17	0.32
3/4 x 3/8	1.44	1.01	1.46	0.36	0.50	0.17	0.31
3/4 x 1/2	1.44	1.20	1.46	0.43	0.50	0.17	0.19
1 x 1/4	1.69	0.84	1.77	0.32	0.58	0.16	0.44
1 x 3/8	1.69	1.01	1.77	0.36	0.58	0.16	0.44
1 x 1/2	1.69	1.20	1.77	0.43	0.58	0.16	0.31
1 x 3/4	1.69	1.46	1.77	0.50	0.58	0.16	0.30
1-1/4 x 1/2	2.06	1.20	2.15	0.43	0.67	0.32	0.50
1-1/4 x 3/4	2.06	1.46	2.15	0.50	0.67	0.32	0.48
1-1/4 x 1	2.06	1.77	2.15	0.58	0.67	0.32	0.35
1-1/2 x 1/2	2.31	1.20	2.43	0.43	0.70	0.43	0.62
1-1/2 x 3/4	2.31	1.46	2.43	0.50	0.70	0.43	0.61
1-1/2 x 1	2.31	1.77	2.43	0.58	0.70	0.43	0.47
1-1/2 x 1-1/4	2.31	2.15	2.43	0.67	0.70	0.43	0.45
2 x 1/2	2.81	1.20	2.96	0.43	0.75	0.65	0.87
2 x 3/4	2.81	1.46	2.96	0.50	0.75	0.65	0.86
2 x 1	2.81	1.77	2.96	0.58	0.75	0.65	0.72
2 x 1-1/4	2.81	2.15	2.96	0.67	0.75	0.65	0.70
2 x 1-1/2	2.81	2.43	2.96	0.70	0.75	0.65	0.68
2-1/2 x 1	3.25	1.77	3.59	0.58	0.92	0.49	0.94
2-1/2 x 1-1/4	3.25	2.43	3.59	0.67	0.92	0.49	0.92
2-1/2 x 1-1/2	3.25	2.43	3.59	0.70	0.92	0.49	0.90
2-1/2 x 2	3.25	2.96	3.59	0.75	0.92	0.49	0.87
3 x 1	3.69	1.77	4.28	0.58	0.98	0.65	1.16
3 x 1-1/4	3.69	2.15	4.28	0.67	0.98	0.65	1.14
3 x 1-1/2	3.69	2.43	4.28	0.70	0.98	0.65	1.12
3 x 2	3.69	2.96	4.28	0.75	0.98	0.65	1.09
3 x 2-1/2	3.69	3.59	4.28	0.92	0.98	0.65	0.71
3-1/2 x 2	4.02	2.96	4.84	0.75	1.03	0.76	0.72
3-1/2 x 3	4.02	4.28	4.84	0.98	1.03	0.76	0.94
4 x 1-1/2	4.38	2.43	5.40	0.70	1.08	0.89	1.47
4 x 2	4.38	2.96	5.40	0.75	1.08	0.89	1.43
4 x 2-1/2	4.38	3.59	5.40	0.92	1.08	0.89	1.05
4 x 3	4.38	4.28	5.40	0.98	1.08	0.89	0.99
4 x 3-1/2	4.38	4.84	5.40	1.03	1.08	0.70	1.17
5 x 4	4.67	5.40	6.58	1.08	1.18	1.09	1.40
6 x 4	4.81	5.40	7.77	1.08	1.28	0.90	1.11



**MALLEABLE IRON
EXTENSION PIECES
CLASS 150**

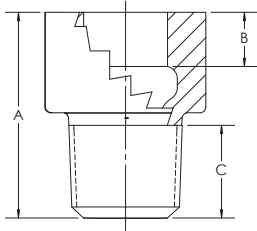

NPS	OVERALL HEIGHT A	LENGTH INTERNAL THREADS B (MIN)	LENGTH EXTERNAL THREADS C (MIN)	TAKE OUT FEMALE END	TAKE OUT MALE END
*1/2	1.95	0.43	0.53	1.41	1.41
*3/4	2.06	0.50	0.54	1.51	1.51
*1	2.23	0.58	0.68	1.54	1.54
*1-1/4	2.56	0.67	0.63	1.85	1.85

*Manufactured to Ward specifications

CLASS 150 FITTINGS

CLASS 300 FITTINGS

CLASS 150, 250, & 300 UNIONS



MALLEABLE IRON LOCKNUTS CLASS 150

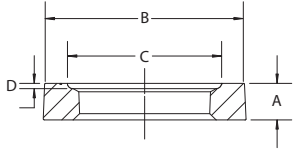

NPS	OVERALL HEIGHT A	LENGTH ACROSS FLAT B (MIN)	PACKING GROOVE WIDTH C	PACKING GROOVE DEPTH D
+1/8	0.19	0.69	0.50	0.04
+1/4	0.25	0.84	0.66	0.06
3/8	0.28	1.00	0.77	0.06
1/2	0.31	1.18	0.97	0.06
3/4	0.34	1.43	1.23	0.06
1	0.38	1.75	1.50	0.06
1-1/4	0.42	2.10	1.86	0.06
1-1/2	0.47	2.35	2.12	0.06
2	0.53	2.88	2.63	0.09

+Steel
All Locknuts listed above are made to ASME B16.14



MALLEABLE IRON RETURN BEND OPEN CLASS 150

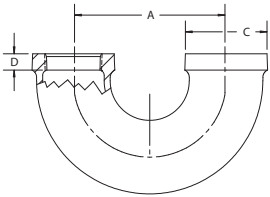

NPS	CENTER TO END A	OUTSIDE DIA. BAND C (MIN)	LENGTH THREADS D (MIN)
3/4	2.00	1.46	0.50
1	3.00	1.77	0.58



MALLEABLE IRON CROSS CLASS 150

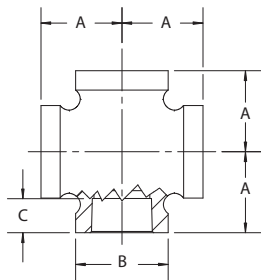

NPS	CENTER TO END A	OUTSIDE DIA. BAND B (MIN)	LENGTH THREADS C (MIN)	TAKE OUT
1/8	0.81	0.69	0.25	0.55
1/4	0.81	0.84	0.32	0.40
3/8	0.95	1.01	0.36	0.54
1/2	1.12	1.20	0.43	0.58
3/4	1.31	1.46	0.50	0.76
1	1.50	1.77	0.58	0.81
1-1/4	1.75	2.15	0.67	1.04
1-1/2	1.94	2.43	0.70	1.21
2	2.25	2.96	0.75	1.49
2-1/2	2.70	3.59	0.92	1.56
3	3.08	4.28	0.98	1.88
4	3.79	5.40	1.08	2.49



MALLEABLE IRON 45° Y CLASS 150

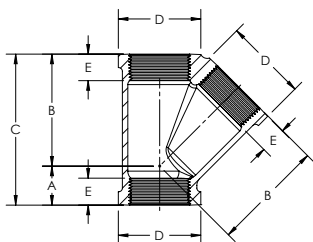

NPS	CENTER TO END INLET A	CENTER TO END OUTLET B	END TO END C	OUTSIDE DIA. BAND D (MIN)	LENGTH THREADS E (MIN)	TAKE OUT	TAKE OUT
3/8	0.50	1.43	1.93	1.01	0.36	0.09	1.20
1/2	0.61	1.71	2.32	1.20	0.43	0.08	1.18
3/4	0.72	2.05	2.77	1.46	0.50	0.17	1.50
1	0.85	2.43	3.28	1.77	0.58	0.17	1.75
1-1/4	1.02	2.92	3.94	2.15	0.67	0.67	2.21
1-1/2	1.10	3.28	4.38	2.43	0.70	0.38	2.56
2	1.24	3.93	5.17	2.96	0.75	0.48	3.17
2-1/2	1.52	4.73	6.25	3.59	0.92	0.38	3.59
3	1.71	5.55	7.26	4.28	0.98	0.46	4.35
4	2.00	7.00	9.00	5.40	1.08	0.70	5.70



MALLEABLE IRON 90° ELL CLASS 300

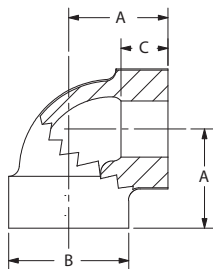

NPS	CENTER TO END A	OUTSIDE DIA. BAND B (MIN)	LENGTH THREADS C (MIN)	TAKE OUT
1/4	0.94	0.93	0.43	0.53
3/8	1.06	1.12	0.47	0.65
1/2	1.25	1.34	0.57	0.71
3/4	1.44	1.63	0.64	0.89
1	1.63	1.95	0.75	0.94
1-1/4	1.94	2.39	0.84	1.23
1-1/2	2.13	2.68	0.87	1.40
2	2.50	3.28	1.00	1.74
2-1/2	2.94	3.86	1.17	1.80
3	3.38	4.62	1.23	2.18
4	4.60	5.80	1.44	3.30



MALLEABLE IRON REDUCING 90° ELL CLASS 300

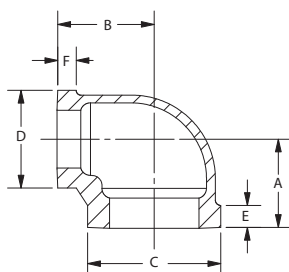

NPS	CENTER TO END A	CENTER TO END B	OUTSIDE DIA. BAND C (MIN)	OUTSIDE DIA. BAND D (MIN)	LENGTH THREADS E (MIN)	LENGTH THREADS F (MIN)	TAKE OUT	TAKE OUT
3/8 x 1/4	1.04	1.03	1.12	0.93	0.48	0.43	0.78	0.63
1/2 x 3/8	1.19	1.19	1.34	1.12	0.57	0.47	0.65	0.78
3/4 x 1/2	1.31	1.38	1.63	1.34	0.64	0.57	0.76	0.84
1 x 1/2	1.50	1.56	1.93	1.34	0.75	0.56	0.96	0.88
1 x 3/4	1.50	1.56	1.95	1.63	0.75	0.64	0.95	0.88
1-1/4 x 3/4	1.63	1.75	2.37	1.62	0.84	0.62	0.92	1.20
1-1/4 x 1	1.75	1.81	2.37	1.93	0.84	0.75	1.04	1.13
1-1/2 x 1	1.88	2.00	2.68	1.93	0.87	0.75	0.74	1.32
1-1/2 x 1-1/4	2.00	2.06	2.68	2.37	0.87	0.84	1.24	1.35
2 x 1-1/4	2.13	2.31	3.28	2.37	1.00	0.84	1.37	1.61
2 x 1-1/2	2.25	2.38	3.28	2.68	1.00	0.87	1.49	1.66



MALLEABLE IRON 90° STREET ELL CLASS 300

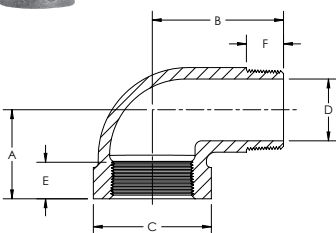

NPS	CENTER TO END A	CENTER TO MALE B	OUTSIDE DIA. BAND C (MIN)	PORT DIA. MALE END D (MAX)	LENGTH INTERNAL THREADS E (MIN)	LENGTH EXTERNAL THREADS F (MIN)	TAKE OUT MALE END	TAKE OUT FEMALE END
1/4	0.94	1.44	0.93	0.26	0.43	0.40	1.03	0.53
3/8	1.06	1.63	1.12	0.36	0.47	0.41	1.22	0.65
1/2	1.25	2.00	1.34	0.49	0.57	0.53	1.46	0.71
3/4	1.44	2.19	1.63	0.67	0.64	0.55	1.64	0.89
1	1.63	0.25	1.95	0.88	0.75	0.68	0.42	0.94
1-1/4	1.94	2.88	2.39	1.16	0.84	0.71	2.17	1.23
1-1/2	2.13	3.13	2.68	1.35	0.87	0.72	2.40	1.40
2	2.50	3.69	3.28	1.75	1.00	0.76	2.93	1.74
3	3.38	5.13	4.62	2.67	1.23	1.20	3.93	2.18



MALLEABLE IRON 45° ELL CLASS 300

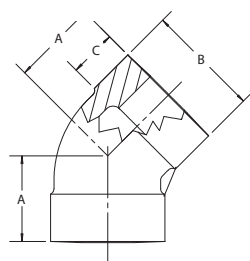

NPS	CENTER TO END A	OUTSIDE DIA. BAND B (MIN)	LENGTH THREADS C (MIN)	TAKE OUT
1/4	0.81	0.93	0.43	0.40
3/8	0.88	1.12	0.47	0.47
1/2	1.00	1.34	0.57	0.46
3/4	1.13	1.63	0.64	0.58
1	1.31	1.95	0.75	0.62
1-1/4	1.50	2.39	0.84	0.79
1-1/2	1.69	2.68	0.87	0.96
2	2.00	3.28	1.00	1.24
2-1/2	2.25	3.86	1.17	1.12
3	2.50	4.62	1.23	1.30
4	2.82	5.80	1.44	1.52



**MALLEABLE IRON
45° STREET ELL
CLASS 300**

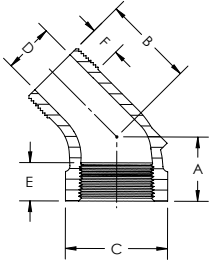

NPS	CENTER TO END A	CENTER TO END B	OUTSIDE DIA. BAND C (MIN)	PORT DIA. MALE D (MAX)	INTERNAL LENGTH THREADS E (MIN)	EXTERNAL LENGTH THREADS F (MIN)	TAKE OUT	TAKE OUT
1/2	1.25	2.00	1.34	0.49	0.56	0.53	0.72	1.47
3/4	1.44	2.19	1.62	0.67	0.62	0.55	0.89	1.64
1	1.63	2.56	1.93	0.88	0.75	0.68	0.95	1.88
1-1/4	1.50	2.13	2.39	1.16	0.84	0.71	1.42	0.79
1-1/2	2.13	3.13	2.68	1.35	0.87	0.72	1.41	2.41
2	2.50	3.69	3.28	1.75	1.00	0.76	1.74	2.93



**MALLEABLE IRON
TEE CLASS 300**

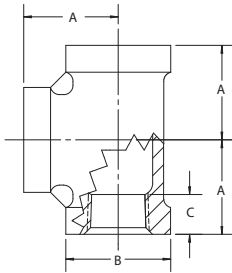

NPS	CENTER TO END A	OUTSIDE DIA. BAND B (MIN)	LENGTH THREADS C (MIN)	TAKE OUT
1/4	0.94	0.93	0.43	0.53
3/8	1.06	1.12	0.47	0.65
1/2	1.25	1.34	0.57	0.71
3/4	1.44	1.63	0.64	0.89
1	1.63	1.95	0.75	0.94
1-1/4	1.94	2.39	0.84	1.23
1-1/2	2.13	2.68	0.87	1.40
2	2.50	3.28	1.00	1.74
2-1/2	2.94	3.86	1.17	1.81
3	3.38	4.62	1.23	2.18
4	4.50	5.80	1.44	3.20



**MALLEABLE IRON
REDUCING TEES
CLASS 300**

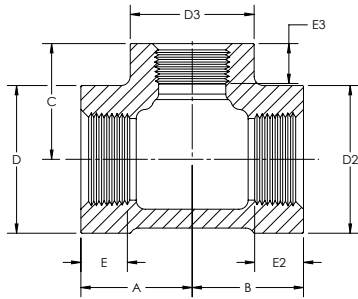

NPS	CENTER TO END A	CENTER TO END B	CENTER TO END C	OUTSIDE DIA. BAND D (MIN)	OUTSIDE DIA. BAND D2 (MIN)	OUTSIDE DIA. BAND D3 (MIN)	LENGTH THREADS E (MIN)	LENGTH THREADS E2 (MIN)	LENGTH THREADS E3 (MIN)	TAKE OUT	TAKE OUT	TAKE OUT
*3/8 x 3/8 x 1/4	1.02	1.02	1.02	1.12	1.12	0.93	0.47	0.47	0.43	0.61	0.61	0.62
*1/2 x 1/2 x 1/4	1.13	1.13	1.12	1.34	1.34	0.93	0.56	0.56	0.43	0.60	0.60	0.72
1/2 x 1/2 x 3/8	1.19	1.19	1.19	1.34	1.34	1.12	0.56	0.56	0.47	0.66	0.66	0.79
3/4 x 3/4 x 1/4	1.19	1.19	1.25	1.62	1.62	0.93	0.62	0.62	0.43	0.64	0.64	0.85
3/4 x 3/4 x 3/8	1.32	1.32	1.38	1.62	1.62	1.12	0.62	0.62	0.47	0.77	0.77	0.97
3/4 x 1/2 x 1/2	1.32	1.25	1.38	1.62	1.34	1.34	0.62	0.56	0.56	0.77	0.72	0.85
3/4 x 1/2 x 3/4	1.44	1.38	1.44	1.62	1.34	1.62	0.62	0.56	0.62	0.89	0.85	0.89
3/4 x 3/4 x 1/2	1.31	1.31	1.38	1.63	1.63	1.34	0.64	0.64	0.57	0.76	0.76	0.84
1 x 1/2 x 1	1.63	1.50	1.63	1.93	1.34	1.93	0.75	0.56	0.75	0.95	0.97	0.95
1 x 3/4 x 3/4	1.50	1.44	1.57	1.93	1.62	1.62	0.75	0.62	0.62	0.82	0.89	1.02
1 x 3/4 x 1	1.63	1.56	1.63	1.93	1.62	1.93	0.75	0.62	0.75	0.95	1.01	0.95
1 x 1 x 1/4	1.25	1.25	1.38	1.93	1.93	0.93	0.75	0.75	0.43	0.57	0.57	0.98
1 x 1 x 1/2	1.44	1.44	1.5	1.95	1.95	1.34	0.75	0.75	0.57	0.75	0.75	0.96
1 x 1 x 3/4	1.50	1.50	1.56	1.95	1.95	1.63	0.75	0.75	0.64	0.81	0.81	1.01
1-1/4 x 1 x 1	1.75	1.63	1.82	2.37	1.93	1.93	0.84	0.75	0.75	1.04	0.95	1.14
1-1/4 x 1-1/4 x 1/2	1.50	1.50	1.69	2.37	2.37	1.34	0.84	0.84	0.56	0.79	0.79	1.16
1-1/4 x 1-1/4 x 3/4	1.63	1.63	1.75	2.39	2.39	1.63	0.84	0.84	0.64	0.92	0.92	1.20
1-1/4 x 1-1/4 x 1	1.75	1.75	1.81	2.39	2.39	1.95	0.84	0.84	0.75	1.04	1.04	1.12
1-1/2 x 1-1/2 x 1/2	1.63	1.63	1.81	2.68	2.68	1.34	0.87	0.87	0.57	0.90	0.90	1.27
1-1/2 x 1-1/2 x 3/4	1.69	1.69	1.88	2.68	2.68	1.63	0.87	0.87	0.64	0.96	0.96	1.33
1-1/2 x 1-1/2 x 1	1.81	1.81	2.00	2.68	2.68	1.95	0.87	0.87	0.75	1.08	1.08	1.31
1-1/2 x 1-1/2 x 1-1/4	2.00	2.00	2.06	2.68	2.68	2.37	0.87	0.87	0.84	1.28	1.28	1.35
2 x 1-1/2 x 2	2.50	2.38	2.50	3.28	2.68	3.28	1.00	0.87	1.00	1.74	1.66	1.74
2 x 2 x 1/2	1.75	1.75	2.06	3.28	3.28	1.34	1.00	1.00	0.57	0.99	0.99	1.52
2 x 2 x 3/4	1.81	1.81	2.13	3.28	3.28	1.63	1.00	1.00	0.64	1.05	1.05	1.58
2 x 2 x 1	2.00	2.00	2.25	3.28	3.28	1.95	1.00	1.00	0.75	1.24	1.24	1.56
2 x 2 x 1-1/4	2.13	2.13	2.31	3.28	3.28	2.37	1.00	1.00	0.84	1.37	1.37	1.60
2 x 2 x 1-1/2	2.25	2.25	2.38	3.28	3.28	2.68	1.00	1.00	0.87	1.49	1.49	1.65
2-1/2 x 2-1/2 x 1-1/2	2.44	2.44	2.63	3.86	3.86	2.68	1.17	1.17	0.87	1.30	1.30	1.91
3 x 3 x 2	2.81	2.81	3.13	4.62	4.62	3.28	1.23	1.23	1.00	1.61	1.61	2.37
3 x 3 x 2	2.81	2.81	3.13	4.62	4.62	3.28	1.23	1.23	1.00	1.61	1.61	2.37

*Manufactured to Ward specifications



**MALLEABLE IRON
COUPLING CLASS 300**

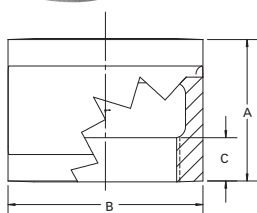

**MALLEABLE IRON
REDUCING COUPLING
CLASS 300**

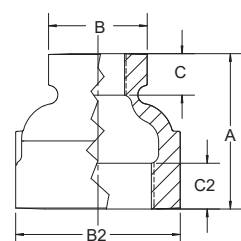

**MALLEABLE IRON
PIPE CAPS CLASS 300**

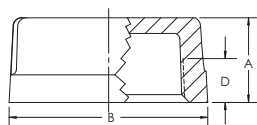

**MALLEABLE IRON
CROSS CLASS 300**

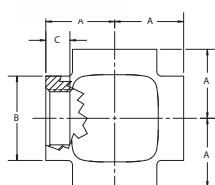

NPS	LENGTH COUPLING A (MIN)	OUTSIDE DIA. BAND B (MIN)	LENGTH THREADS C (MIN)	TAKE OUT
1/4	1.37	0.93	0.43	0.28
3/8	1.62	1.12	0.47	0.40
1/2	1.87	1.34	0.57	0.40
3/4	2.12	1.63	0.64	0.51
1	2.37	1.95	0.75	0.50
1-1/4	2.87	2.39	0.84	0.73
1-1/2	2.87	2.68	0.87	0.71
2	3.62	3.28	1.00	1.05
2-1/2	4.12	3.86	1.17	1.49
3	4.12	4.62	1.23	1.46

NPS	LENGTH COUPLING A	OUTSIDE DIA. BAND SMALL END B (MIN)	OUTSIDE DIA. LARGE END B2 (MIN)	LENGTH THREADS SMALL END C (MIN)	LENGTH THREADS LARGE END C2 (MIN)	TAKE OUT	TAKE OUT
3/8 x 1/4	1.44	0.93	1.20	0.43	0.47	0.31	0.32
1/2 x 1/4	1.69	0.93	1.34	0.43	0.57	0.31	0.44
1/2 x 3/8	1.69	1.12	1.34	0.47	0.57	0.31	0.44
3/4 x 1/4	1.75	0.93	1.62	0.43	0.62	0.33	0.47
3/4 x 3/8	1.75	1.12	1.62	0.48	0.62	0.33	0.47
3/4 x 1/2	1.75	1.34	1.63	0.57	0.64	0.33	0.34
1 x 1/4	2.00	0.93	1.93	0.43	0.75	0.32	0.6
1 x 3/8	2.00	1.12	1.93	0.48	0.75	0.32	0.59
1 x 1/2	2.00	1.34	1.95	0.57	0.75	0.32	0.47
1 x 3/4	2.00	1.63	1.95	0.64	0.75	0.32	0.45
1-1/4 x 1/2	2.38	1.34	2.37	0.56	0.84	0.48	0.66
1-1/4 x 3/4	2.38	1.63	2.39	0.64	0.84	0.48	0.64
1-1/4 x 1	2.38	1.95	2.39	0.75	0.84	0.48	0.51
1-1/2 x 1/2	2.69	1.34	2.68	0.56	0.87	0.62	0.81
1-1/2 x 3/4	2.69	1.63	2.68	0.64	0.87	0.62	0.80
1-1/2 x 1	2.69	1.95	2.68	0.75	0.87	0.62	0.66
1-1/2 x 1-1/4	2.69	2.39	2.68	0.84	0.87	0.62	0.64
2 x 1/2	3.19	1.34	3.28	0.56	1.00	0.84	1.06
2 x 3/4	3.19	1.62	3.28	0.62	1.00	0.84	1.05
2 x 1	3.19	1.95	3.28	0.75	1.00	0.84	0.91
2 x 1-1/4	3.19	2.39	3.28	0.84	1.00	0.84	0.89
2 x 1-1/2	3.19	2.68	3.28	0.87	1.00	0.84	0.87
2-1/2 x 1-1/2	3.96	2.68	3.86	0.87	1.17	0.84	1.26
2-1/2 x 2	3.96	3.28	3.86	1.00	1.17	0.84	1.22
3 x 1-1/2	4.06	2.68	4.62	0.87	1.93	0.83	1.31
3 x 2	4.06	3.28	4.62	1.00	1.93	0.83	1.27
3 x 2-1/2	4.06	3.86	4.62	1.17	1.93	0.83	0.89
4 x 2	4.38	3.28	5.80	1.00	1.44	0.89	1.43
4 x 3	4.38	4.62	5.80	1.93	1.44	0.89	0.99

NPS	OVERALL HEIGHT A	OUTSIDE DIA. BAND B (MIN)	LENGTH THREADS C (MIN)
1/4	0.78	0.93	0.43
3/8	0.83	1.12	0.47
1/2	0.98	1.34	0.57
3/4	1.08	1.63	0.64
1	1.26	1.95	0.75
1-1/4	1.38	2.39	0.84
1-1/2	1.43	2.68	0.87
2	1.68	3.28	1.00
2-1/2	2.06	3.86	1.17
3	2.17	4.62	1.23

NPS	CENTER TO END A (MIN)	OUTSIDE DIA. BAND B (MIN)	LENGTH THREAD C (MIN)	TAKE OUT
1/4	0.94	0.93	0.43	0.54
1/2	1.25	1.34	0.57	0.71
3/4	1.44	1.63	0.64	0.89
1	1.63	1.95	0.75	0.94
1-1/4	1.94	2.39	0.84	1.23
1-1/2	2.13	2.68	0.87	1.40
2	2.50	3.28	1.00	1.74

CLASS 150 FITTINGS

CLASS 300 FITTINGS

CLASS 150, 250, & 300 UNIONS

CLASS 150 FITTINGS



UNION BRASS-TO-IRON SEAT CLASS 150

NPS	OVERALL LENGTH A (MIN)	LENGTH THREADS B (MIN)	THRU HOLE C (MIN)	WIDTH NUT D (MIN)
1/8	1.26	0.30	0.21	0.93
1/4	1.44	0.40	0.36	1.10
3/8	1.61	0.41	0.52	1.26
1/2	1.72	0.53	0.61	1.45
3/4	1.94	0.55	0.80	1.71
3/4 x 1/2	1.94	0.50	0.80	1.71
1	2.06	0.68	1.00	2.07
1-1/4	2.26	0.71	1.31	2.50
1-1/2	2.41	0.72	1.55	2.82
2	2.75	0.76	2.03	3.41
2-1/2	3.22	0.92	2.38	4.12
3	3.50	0.98	3.00	4.75
*4	3.85	1.30	4.03	6.00

*UL Standards not applicable to 4" size union

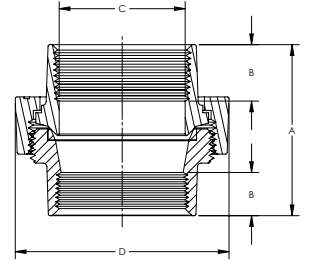

CLASS 300 FITTINGS



UNION BRASS-TO-IRON SEAT CLASS 250

NPS	OVERALL LENGTH A (MIN)	LENGTH THREADS B (MIN)	THRU HOLE C (MIN)	WIDTH NUT D (MIN)
1/8	1.26	0.30	0.21	0.93
1/4	1.55	0.43	0.30	1.11
3/8	1.71	0.47	0.42	1.26
1/2	1.18	0.57	0.54	1.45
3/4	2.07	0.64	0.74	1.71
1	2.31	0.75	0.95	2.07
1-1/4	2.62	0.84	1.27	2.57
1-1/2	2.78	0.87	1.50	2.89
2	3.31	1.00	1.93	3.48
2-1/2	3.52	1.17	2.32	4.15
3	3.84	1.23	2.90	4.69
*4	4.39	1.33	3.82	6.47

*UL Standards not applicable to 4" size union

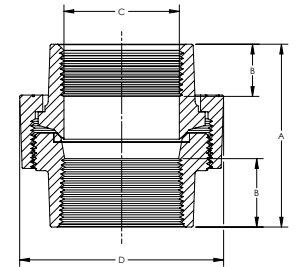

CLASS 150, 250, & 300 UNIONS



UNION BRASS-TO-IRON SEAT CLASS 300

NPS	OVERALL LENGTH A (MIN)	LENGTH THREADS B (MIN)	THRU HOLE C (MIN)	WIDTH NUT D (MIN)
1/8	1.26	0.3	0.21	0.93
1/4	1.55	0.43	0.30	1.33
3/8	1.71	0.47	0.42	1.50
1/2	1.81	0.57	0.54	1.76
3/4	2.12	0.64	0.74	2.15
1	2.31	0.75	0.95	2.48
1-1/4	2.66	0.84	1.27	3.02
1-1/2	2.85	0.87	1.50	3.28
2	2.23	1.00	1.93	3.96
2-1/2	3.33	1.17	2.32	4.72
3	4.09	1.23	2.90	5.37
4	4.47	1.33	3.82	7.00

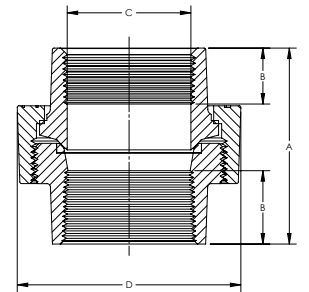

UNION IRON-TO-IRON SEAT CLASS 150

NPS	OVERALL LENGTH A (MIN)	LENGTH THREADS B (MIN)	THRU HOLE C (MIN)	WIDTH NUT D (MIN)
1/8	1.26	0.30	0.21	0.93
1/4	1.55	0.32	0.36	1.10
3/8	1.61	0.36	0.52	1.26
1/2	1.72	0.43	0.61	1.45
3/4	1.94	0.50	0.80	1.71
1	2.06	0.58	1.00	2.07
1-1/4	2.26	0.67	1.31	2.50
1-1/2	2.41	0.70	1.55	2.82
2	3.23	0.75	2.03	3.41
2-1/2	3.22	0.92	2.38	4.12
3	3.50	0.98	3.00	4.75

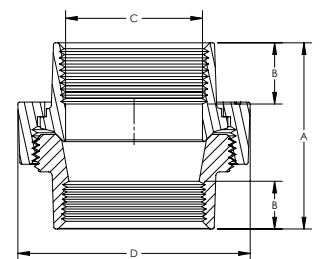



**UNION IRON-TO-IRON
SEAT CLASS 300**

NPS	OVERALL LENGTH A (MIN)	LENGTH THREADS B (MIN)	THRU HOLE C (MIN)	WIDTH NUT D (MIN)
1/8	1.26	0.30	0.21	0.93
1/4	1.55	0.43	0.30	1.33
3/8	1.71	0.47	0.42	1.50
1/2	1.81	0.57	0.54	1.76
3/4	2.12	0.64	0.74	2.15
1	2.31	0.75	0.95	2.48
1-1/4	2.66	0.84	1.27	3.02
1-1/2	2.85	0.87	1.50	3.28
2	3.23	1.00	1.93	3.96
2-1/2	3.33	1.17	2.32	4.72
3	4.09	1.23	2.90	5.37

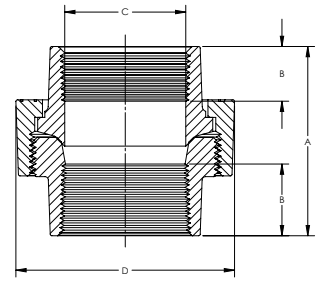

CLASS 150 FITTINGS



**UNION BRASS-TO-
BRASS SEAT
CLASS 300**

NPS	OVERALL LENGTH A (MIN)	LENGTH THREADS B (MIN)	THRU HOLE C (MIN)	WIDTH NUT D (MIN)
1/4	1.55	0.43	0.30	1.33
3/8	1.71	0.47	0.42	1.50
1/2	1.81	0.57	0.54	1.76
3/4	2.12	0.64	0.74	2.15
1	2.31	0.75	0.95	2.48
1-1/4	2.66	0.84	1.27	3.02
1-1/2	2.85	0.87	1.50	3.28
2	2.23	1.00	1.93	3.96
2-1/2	3.33	1.17	2.32	4.72
3	4.09	1.23	2.90	5.37
*4	4.47	1.33	3.82	7.00

*UL Standards not applicable to 4" size union

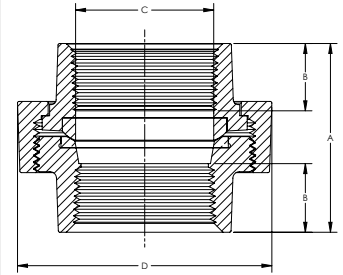

CLASS 300 FITTINGS



**GASKET TYPE UNION
MALLEABLE IRON**

NPS	OVERALL LENGTH A (MIN)	LENGTH THREADS B (MIN)	THRU HOLE C (MIN)	WIDTH NUT D (MIN)
3/8	1.61	0.36	0.52	1.26
1/2	1.72	0.43	0.61	1.45
3/4	1.94	0.50	0.80	1.71
1	2.06	0.58	1.00	2.07
1-1/4	2.26	0.67	1.31	2.50
1-1/2	2.41	0.70	1.55	2.82
2	2.75	0.75	2.03	3.41

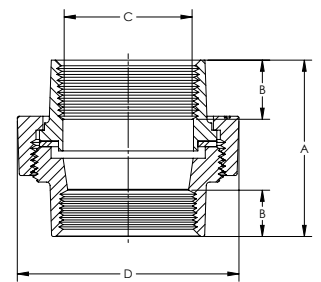

CLASS 150, 250, & 300 UNIONS



**DI-ELECTRIC UNION
IRON-TO-BRASS**

NPS	OVERALL LENGTH A (MIN)	LENGTH THREADS B (MIN)	THRU HOLE C (MIN)	WIDTH NUT D (MIN)
*1/2 x 1/2	1.99	0.50	0.54	1.68
*3/4 x 3/4	1.83	0.50	0.80	2.15

*Manufactured to Ward specifications

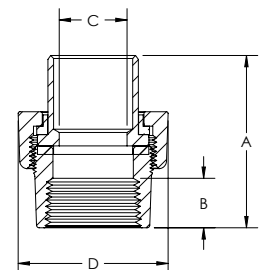

SECTION 2

CAST IRON



Ward Manufacturing ("Ward") Class 125 & 250 Cast Iron Pipe Fittings conform to ASME B16.4 specifications. Our close attention paid to formula control and the use of modern precision equipment, result in strong, rugged castings that have the ability to make a water-tight seal.

Ward Flange Components are designed per ASME 16.1 standards in order to handle the tough service that flange components normally experience. Our precision machining and thread chamfering process allow Ward flange components to be easily installed.

Ward Cast Iron Drainage Fittings are designed for drainage systems using wrought iron pipe. The inside diameter of the pipe fitting is the same as that of wrought pipe. Ward drainage fittings meet sanitary code requirements and are manufactured in strict accordance with ASME B16.12.

Excluding the street ells, Ward 90° ells are pitched to 1/4-inch per foot. Ward drainage fittings are made with an interior shoulder so that when the joint is made, the end of the pipe practically meets the shoulder. This forms a continuous unobstructed surface, providing smooth flow of the pipe components.

CLASS 125 & 250 CAST IRON PIPE FITTINGS SPECIFICATIONS

Material: ASTM A126 Class A Minimum
Dimensions: ASME B16.4
Threading: ASME B1.20.1
Pressure Ratings: ASME B16.4
Coatings: ASTM A153, ASTM B633
Additional Specifications: UL, ULC, FM, NSF 61 and NSF 372 where applicable

General Dimensions / In Inches

NPS	O.D. of Band (min)	Thread Length (min)	Metal Thickness (min)
1/4	0.97	0.36	0.11
3/8	1.16	0.40	0.12
1/2	1.38	0.47	0.13
3/4	1.67	0.54	0.15
1	1.99	0.62	0.17
1-1/4	2.43	0.71	0.18
1-1/2	2.72	0.74	0.20
2	3.32	0.79	0.22
2-1/2	3.90	0.96	0.24
3	4.66	1.02	0.26
3-1/2	5.24	1.07	0.28
4	5.83	1.12	0.31

Pressure / Temperature Ratings

Temp. F	PSI	
	CLASS 125	CLASS 250
-20 TO 150	175	400
200	165	370
250	150	340
300	140	310
350	125 (Note 1)	300
400	—	250 (Note 2)

NOTES:

1. Permissible for service temperature up to 360° F reflecting temperature of saturated steam at 125 psi.
2. Permissible for service temperature up to 406° F reflecting temperature of saturated steam at 250 psig.

CAST IRON DRAINAGE FITTINGS SPECIFICATIONS

Material: ASTM A126 Class A Minimum
Dimensions: ASME B16.12
Threading: ASME B.1.20.1
Pressure Ratings: ASME B16.12
Coatings: ASTM A153
Additional Specifications: UL, ULC and FM where applicable

NPS	Thread Length (min)	Total Length Chamber to Shoulder	I.D. Fittings	Wall Thickness (min)	O.D. Band (min)
1-1/4	0.42	0.71	1.38	0.18	2.39
1-1/2	0.42	0.72	1.61	0.20	2.68
2	0.44	0.76	2.07	0.22	3.28
2-1/2	0.68	1.14	2.47	0.24	3.86
3	0.77	1.20	3.07	0.26	4.62
4	0.84	1.30	4.03	0.31	5.79

CLASS 125 CAST IRON
PIPE FITTINGS

CLASS 250 CAST IRON
PIPE FITTINGS

FLANGES

DRAINAGE FITTINGS

FLANGE, FLANGE UNIONS, COMPANION FLANGES, FLANGED FITTINGS SPECIFICATIONS

Material: ASTM A126 Class A Minimum (Cast Iron)
 ASTM A197 (Malleable Iron)
Dimensions: ASME B16.1
Threading: ASME B1.20.1
Pressure Ratings: ASME B16.1
Coatings: ASTM A153, ASTM B633
Additional Specifications: UL, ULC, FM, NSF 61 and NSF 372 where applicable

NPS	FLANGES		HUB	BLIND FLANGES	BOLTING INFORMATION						
	Flange Dia.	Flange Thickness (min)	Hub Dia. (min)	Length Hub and Threads (min)	Dia. of Port	Wall Thickness	Dia. Bolt Circle	Dia. Bolt Holes	Number Bolt Holes	Dia. Bolts	Bolt Lengths
1	4.25	0.44	1.94	0.69	1.00	0.38	3.12	0.62	4	0.50	2.00
1-1/4	4.62	0.50	2.31	0.81	1.25	0.44	3.50	0.62	4	0.50	2.00
1-1/2	5.00	0.56	2.56	0.88	1.50	0.50	3.88	0.62	4	0.50	2.00
2	6.00	0.62	3.06	1.00	2.00	0.56	4.75	0.75	4	0.62	2.50
2-1/2	7.00	0.69	3.56	1.12	2.50	0.63	5.50	0.75	4	0.62	2.50
3	7.50	0.75	4.25	1.19	3.00	0.69	6.00	0.75	4	0.62	2.50
3-1/2	8.50	0.81	4.81	1.25	3.50	0.75	7.00	0.75	8	0.62	3.00
4	9.00	0.94	5.31	1.31	4.00	0.88	7.50	0.75	8	0.62	3.00
5	10.00	0.94	6.44	1.44	5.00	0.88	8.50	0.88	8	0.75	3.00
6	11.00	1.00	7.56	1.56	6.00	0.94	9.50	0.88	8	0.75	3.50
8	13.50	1.12	9.96	1.75	8.00	1.06	11.75	0.88	8	0.75	3.50
10	16.00	1.19	11.94	1.94	10.00	1.12	14.25	1.00	12	0.88	4.00
12	19.00	1.25	14.06	2.19	12.00	0.81	17.00	1.00	12	0.88	4.00

Flanged fittings made in North America.

CLASS 125 CAST IRON PIPE FITTINGS

CLASS 250 CAST IRON PIPE FITTINGS

FLANGES

DRAINAGE FITTINGS



**CAST IRON 90° ELL
CLASS 125**

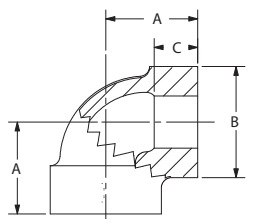

NPS	CENTER TO END A	OUTSIDE DIA. BAND B (MIN)	LENGTH THREAD C (MIN)	TAKE OUT
1/4	0.81	0.93	0.32	0.41
3/8	0.95	1.12	0.36	0.50
1/2	1.12	1.34	0.43	0.58
3/4	1.31	1.63	0.50	0.76
1	1.50	1.95	0.58	0.81
1-1/4	1.75	2.39	0.67	1.04
1-1/2	1.94	2.68	0.70	1.21
2	2.25	3.28	0.75	1.49
2-1/2	2.70	3.86	0.92	1.56
3	3.08	4.62	0.98	1.88
3-1/2	3.42	5.20	1.03	2.17
4	3.79	5.79	1.08	2.49
5	4.50	7.05	1.18	3.09
6	5.13	8.28	1.28	3.62
8	6.56	10.63	1.47	4.85



**CAST IRON 90°
REDUCING ELL
CLASS 125**

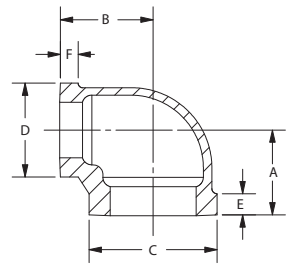

NPS	CENTER TO END A	CENTER TO END B	OUTSIDE DIA. BAND C (MIN)	OUTSIDE DIA. BAND D (MIN)	LENGTH THREAD E (MIN)	LENGTH THREAD F (MIN)	TAKE OUT	TAKE OUT
1/2 x 1/4	0.63	0.75	1.38	0.97	0.47	0.36	0.10	0.35
3/4 x 1/2	1.20	1.22	1.63	1.34	0.50	0.43	0.60	0.68
1 x 1/2	1.26	1.36	1.95	1.34	0.58	0.43	0.50	0.82
1 x 3/4	1.37	1.45	1.95	1.63	0.58	0.50	0.60	0.90
1-1/4 x 1/2	1.34	1.53	2.39	1.34	0.67	0.43	0.60	0.99
1-1/4 x 3/4	1.45	1.62	2.39	1.63	0.67	0.50	0.70	1.07
1-1/4 x 1	1.58	1.67	2.39	1.95	0.67	0.58	0.80	0.98
1-1/2 x 1/2	1.41	1.66	2.68	1.34	0.70	0.43	0.79	1.21
1-1/2 x 3/4	1.52	1.75	2.68	1.63	0.70	0.50	0.79	1.20
1-1/2 x 1	1.65	1.80	2.68	1.95	0.70	0.58	0.92	1.11
1-1/2 x 1-1/4	1.82	1.88	2.68	2.39	0.70	0.67	1.09	1.17
2 x 1/2	1.60	1.97	3.28	1.34	0.75	0.43	0.84	1.43
2 x 3/4	1.60	1.97	3.28	1.63	0.75	0.50	0.84	1.42
2 x 1	1.73	2.02	3.28	1.95	0.75	0.58	0.97	1.33
2 x 1-1/4	1.90	2.10	3.28	2.39	0.75	0.67	1.14	1.39
2 x 1-1/2	2.02	2.16	3.28	2.68	0.75	0.70	1.26	1.43
*2-1/2 x 3/4	1.87	2.37	3.86	1.63	0.92	0.50	0.73	1.82
2-1/2 x 1	1.87	2.37	3.86	1.95	0.92	0.58	0.73	1.68
2-1/2 x 1-1/4	2.04	2.45	3.86	2.39	0.92	0.67	0.90	1.74
2-1/2 x 1-1/2	2.16	2.51	3.86	2.68	0.92	0.70	1.02	1.78
2-1/2 x 2	2.39	2.60	3.86	3.28	0.92	0.75	1.25	1.84
*3 x 1	2.17	2.74	4.62	1.95	0.98	0.58	0.97	2.05
3 x 1-1/4	2.17	2.74	4.62	2.39	0.98	0.67	0.97	2.03
3 x 1-1/2	2.29	2.80	4.62	2.68	0.98	0.70	1.32	2.16
3 x 2	2.52	2.89	4.62	3.28	0.98	0.75	1.32	2.13
3 x 2-1/2	2.83	2.99	4.62	3.86	0.98	0.92	1.63	1.85
*4 x 1-1/2	2.74	3.41	5.79	2.68	1.08	0.70	1.44	2.68
4 x 2	2.74	3.41	5.79	3.28	1.08	0.75	1.44	2.65
4 x 2-1/2	3.05	3.51	5.79	3.86	1.08	0.92	2.00	2.46
4 x 3	3.30	3.60	5.79	4.62	1.08	0.98	2.00	2.40
5 x 4	4.00	4.41	7.05	5.83	1.18	1.12	2.59	3.11
6 x 3	3.64	4.75	8.28	4.66	1.28	0.98	2.13	3.55
6 x 4	4.13	4.94	8.28	5.83	1.28	1.12	2.62	3.64

*Manufactured to Ward specifications



CAST IRON 45° ELL CLASS 125

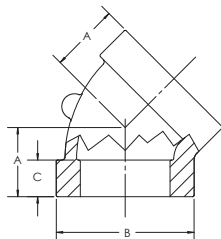

NPS	CENTER TO END A	OUTSIDE DIA. BAND B (MIN)	LENGTH THREAD C (MIN)	TAKE OUT
1/4	0.73	0.93	0.32	0.33
1/2	0.88	1.34	0.43	0.34
3/4	0.98	1.63	0.50	0.43
1	1.12	1.95	0.58	0.43
1-1/4	1.29	2.39	0.67	0.58
1-1/2	1.43	2.68	0.70	0.70
2	1.68	3.28	0.75	0.92
2-1/2	1.95	3.86	0.92	0.81
3	2.17	4.62	0.98	0.97
4	2.61	5.79	1.08	1.31
6	3.46	8.28	1.28	1.95



CAST IRON TEE CLASS 125

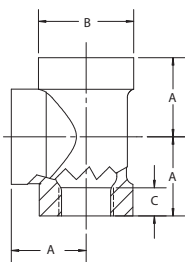

NPS	CENTER TO END A	OUTSIDE DIA. BAND B (MIN)	LENGTH THREAD C (MIN)	TAKE OUT
1/4	0.81	0.93	0.32	0.41
3/8	0.95	1.12	0.36	0.54
1/2	1.12	1.34	0.43	0.58
3/4	1.31	1.63	0.50	0.76
1	1.50	1.95	0.58	0.81
1-1/4	1.75	2.39	0.67	1.04
1-1/2	1.94	2.68	0.70	1.21
2	2.25	3.28	0.75	1.49
2-1/2	2.70	3.86	0.92	1.56
3	3.08	4.62	0.98	1.88
3-1/2	3.42	5.20	1.03	2.17
4	3.79	5.79	1.08	2.49
5	4.50	7.05	1.18	3.10
6	5.13	8.28	1.28	3.62



CAST IRON REDUCING TEE CLASS 125

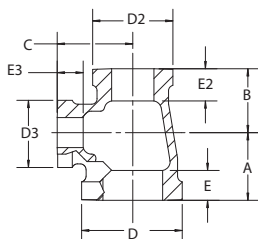

NPS	CENTER TO END A	CENTER TO END B	CENTER TO END C	OUTSIDE DIA. BAND D (MIN)	OUTSIDE DIA. BAND D2 (MIN)	OUTSIDE DIA. BAND D3 (MIN)	LENGTH THREADS E (MIN)	LENGTH THREADS E2 (MIN)	LENGTH THREADS E3 (MIN)	TAKE OUT	TAKE OUT	TAKE OUT
1/2 x 1/2 x 1/4	0.97	0.97	0.98	1.38	1.38	0.97	0.47	0.47	0.36	0.44	0.44	0.58
1/2 x 1/2 x 3/8	1.04	1.04	1.03	1.34	1.34	1.12	0.43	0.43	0.36	0.50	0.50	0.62
1/2 x 1/2 x 3/4	1.22	1.22	1.20	1.34	1.34	1.63	0.43	0.43	0.50	0.68	0.68	0.65
1/2 x 1/2 x 1	1.37	1.37	1.29	1.38	1.38	1.99	0.47	0.47	0.62	0.84	0.84	0.61
3/4 x 1/2 x 1/2	1.20	1.12	1.22	1.63	1.34	1.34	0.50	0.43	0.43	0.65	0.58	0.68
3/4 x 1/2 x 3/4	1.31	1.22	1.31	1.63	1.34	1.63	0.50	0.43	0.50	0.76	0.68	0.76
3/4 x 3/4 x 1/4	1.05	1.05	1.08	1.67	1.67	0.97	0.54	0.54	0.36	0.50	0.50	0.68
3/4 x 3/4 x 3/8	1.12	1.12	1.13	1.63	1.63	1.12	0.50	0.50	0.36	0.57	0.57	0.72
3/4 x 3/4 x 1/2	1.20	1.20	1.22	1.63	1.63	1.34	0.50	0.50	0.43	0.65	0.65	0.68
3/4 x 3/4 x 1	1.45	1.45	1.37	1.63	1.63	1.95	0.50	0.50	0.58	0.90	0.90	0.68
*1 x 1/4 x 1	1.50	1.20	1.50	1.95	0.93	1.95	0.58	0.32	0.58	0.81	0.79	0.81
1 x 1/2 x 1/2	1.26	1.12	1.36	1.99	1.38	1.38	0.62	0.47	0.47	0.58	0.59	0.83
1 x 1/2 x 3/4	1.37	1.22	1.45	1.95	1.34	1.63	0.58	0.43	0.50	0.68	0.68	0.90
1 x 1/2 x 1	1.50	1.36	1.50	1.95	1.34	1.95	0.58	0.43	0.58	0.81	0.82	0.81
*1 x 1/2 x 1-1/4	1.75	1.53	1.75	1.95	1.34	2.39	0.58	0.43	0.67	1.06	0.99	1.04
1 x 3/4 x 1/2	1.26	1.20	1.36	1.95	1.63	1.34	0.58	0.50	0.43	0.57	0.65	0.82
1 x 3/4 x 3/4	1.37	1.31	1.45	1.95	1.63	1.63	0.58	0.50	0.50	0.68	0.76	0.90
1 x 3/4 x 1	1.50	1.45	1.50	1.95	1.63	1.95	0.58	0.50	0.58	0.81	0.90	0.81
*1 x 3/4 x 1-1/4	1.75	1.62	1.75	1.95	1.63	2.39	0.58	0.50	0.67	1.06	1.07	1.04
1 x 1 x 1/4	1.12	1.12	1.25	1.99	1.99	0.97	0.62	0.62	0.36	0.44	0.44	0.85
1 x 1 x 3/8	1.18	1.18	1.27	1.95	1.95	1.12	0.58	0.58	0.36	0.49	0.49	0.86
1 x 1 x 1/2	1.26	1.26	1.36	1.95	1.95	1.34	0.58	0.58	0.43	0.57	0.57	0.82
1 x 1 x 3/4	1.37	1.37	1.45	1.95	1.95	1.63	0.58	0.58	0.50	0.68	0.68	
1 x 1 x 1-1/4	1.67	1.67	1.58	1.95	1.95	2.39	0.58	0.58	0.67	0.98	0.98	0.87
1 x 1 x 1-1/2	1.80	1.80	1.65	1.95	1.95	2.68	0.58	0.58	0.70	1.11	1.11	0.92

*Manufactured to Ward specifications



**CAST IRON
REDUCING TEE
CLASS 125, cont.**

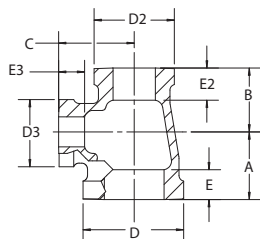

NPS	CENTER TO END A	CENTER TO END B	CENTER TO END C	OUTSIDE DIA. BAND D1 (MIN)	OUTSIDE DIA. BAND D2 (MIN)	OUTSIDE DIA. BAND D3 (MIN)	LENGTH THREADS E (MIN)	LENGTH THREADS E2 (MIN)	LENGTH THREADS E3 (MIN)	TAKE OUT	TAKE OUT	TAKE OUT
1 x 1 x 2	2.04	2.04	1.76	1.99	1.99	3.32	0.62	0.62	0.79	1.36	1.36	1.00
1-1/4 x 1/2 x 1-1/4	1.75	1.53	1.75	2.39	1.34	2.39	0.67	0.43	0.67	1.04	0.99	1.04
*1-1/4 x 1/2 x 1-1/2	1.94	1.66	1.94	2.39	1.34	2.68	0.67	0.43	0.70	1.23	1.12	1.21
1-1/4 x 1/2 x 1	1.58	1.36	1.67	2.39	1.34	1.95	0.67	0.43	0.58	0.87	0.82	0.98
*1-1/4 x 1/2 x 3/4	1.45	1.31	1.62	2.39	1.34	1.63	0.67	0.43	0.50	0.74	0.77	1.07
*1-1/4 x 1/2 x 1/2	1.34	1.12	1.53	2.39	1.34	1.34	0.67	0.43	0.43	0.63	0.58	0.99
*1-1/4 x 3/4 x 1/2	1.45	1.31	1.62	2.39	1.63	1.34	0.67	0.50	0.43	0.74	0.76	1.08
1-1/4 x 3/4 x 3/4	1.45	1.31	1.62	2.39	1.63	1.63	0.67	0.50	0.50	0.74	0.76	1.07
1-1/4 x 3/4 x 1	1.58	1.45	1.67	2.39	1.63	1.95	0.67	0.50	0.58	0.87	0.90	0.98
1-1/4 x 3/4 x 1-1/4	1.75	1.62	1.75	2.39	1.63	2.39	0.67	0.50	0.67	1.04	1.07	1.04
*1-1/4 x 3/4 x 1-1/2	1.94	1.75	1.94	2.39	1.63	2.68	0.67	0.50	0.70	1.23	1.20	1.21
1-1/4 x 1 x 1/2	1.34	1.26	1.53	2.39	1.95	1.34	0.67	0.58	0.43	0.63	0.57	0.99
1-1/4 x 1 x 3/4	1.45	1.37	1.62	2.39	1.95	1.63	0.67	0.58	0.50	0.74	0.68	1.07
1-1/4 x 1 x 1	1.58	1.50	1.67	2.39	1.95	1.95	0.67	0.58	0.58	0.87	0.81	0.98
1-1/4 x 1 x 1-1/4	1.75	1.67	1.75	2.39	1.95	2.39	0.67	0.58	0.67	1.04	0.98	1.04
1-1/4 x 1 x 1-1/2	1.88	1.80	1.82	2.39	1.95	2.68	0.67	0.58	0.70	1.17	1.11	1.09
1-1/4 x 1 x 2	2.03	2.03	1.97	2.43	1.99	3.32	0.71	0.62	0.79	1.35	1.32	1.21
1-1/4 x 1-1/4 x 1/2	1.34	1.34	1.53	2.39	2.39	1.34	0.67	0.67	0.43	0.63	0.63	0.99
1-1/4 x 1-1/4 x 3/4	1.45	1.45	1.62	2.39	2.39	1.63	0.67	0.67	0.50	0.74	0.74	1.07
1-1/4 x 1-1/4 x 1	1.58	1.58	1.67	2.39	2.39	1.95	0.67	0.67	0.58	0.87	0.87	0.98
1-1/4 x 1-1/4 x 1-1/2	1.88	1.88	1.82	2.39	2.39	2.68	0.67	0.67	0.70	1.17	1.17	1.09
1-1/4 x 1-1/4 x 2	2.10	2.10	1.90	2.43	2.43	3.32	0.71	0.71	0.79	1.39	1.39	1.14
*1-1/2 x 1/2 x 1/2	1.52	1.37	1.80	2.68	1.34	1.34	0.70	0.43	0.43	0.80	0.84	1.26
*1-1/2 x 1/2 x 3/4	1.52	1.37	1.80	2.68	1.34	1.63	0.70	0.43	0.50	0.80	0.84	1.25
*1-1/2 x 1/2 x 1-1/4	1.94	1.66	1.94	2.68	1.34	2.39	0.70	0.43	0.67	1.21	1.12	1.23
1-1/2 x 1/2 x 1-1/2	1.94	1.66	1.94	2.68	1.34	2.68	0.70	0.43	0.70	1.21	1.12	1.21
*1-1/2 x 3/4 x 1/2	1.52	1.37	1.80	2.68	1.63	1.34	0.70	0.50	0.43	0.80	0.82	1.26
*1-1/2 x 3/4 x 3/4	1.65	1.50	1.80	2.68	1.63	1.63	0.70	0.50	0.50	0.92	0.95	1.25
*1-1/2 x 3/4 x 1	1.65	1.50	1.80	2.68	1.63	1.95	0.70	0.50	0.58	0.92	0.95	1.11
1-1/2 x 3/4 x 1-1/4	1.82	1.62	1.88	2.68	1.63	2.39	0.70	0.50	1.09	1.21	1.07	1.17
1-1/2 x 3/4 x 1-1/2	1.94	1.75	1.94	2.68	1.63	2.68	0.70	0.50	0.70	1.21	1.20	1.21
*1-1/2 x 1 x 1/2	1.41	1.34	1.66	2.68	1.95	1.34	0.70	0.58	0.43	0.68	0.65	1.12
*1-1/2 x 1 x 3/4	1.65	1.50	1.80	2.68	1.95	1.63	0.70	0.58	0.50	0.92	0.81	1.25
1-1/2 x 1 x 1	1.65	1.50	1.8	2.68	1.95	1.95	0.70	0.58	0.58	0.92	0.81	1.11
1-1/2 x 1 x 1-1/4	1.94	1.80	1.94	2.68	1.95	2.39	0.70	0.58	0.67	1.21	1.11	1.23
1-1/2 x 1 x 1-1/2	1.94	1.80	1.94	2.68	1.95	2.68	0.70	0.58	0.70	1.21	1.11	1.21
1-1/2 x 1 x 2	2.16	2.02	2.02	2.68	1.95	3.28	0.70	0.58	0.75	1.43	1.33	1.26
1-1/2 x 1-1/4 x 1/2	1.41	1.34	1.66	2.68	2.39	1.34	0.70	0.67	0.43	0.68	0.63	1.12
1-1/2 x 1-1/4 x 3/4	1.52	1.45	1.75	2.68	2.39	1.63	0.70	0.67	0.50	0.79	0.74	1.20
1-1/2 x 1-1/4 x 1	1.65	1.58	1.80	2.68	2.39	1.95	0.70	0.67	0.58	0.92	0.87	1.11
1-1/2 x 1-1/4 x 1-1/4	1.82	1.75	1.88	2.68	2.39	2.39	0.70	0.67	0.67	1.09	1.04	1.17
1-1/2 x 1-1/4 x 1-1/2	1.94	1.88	1.94	2.68	2.39	2.68	0.70	0.67	0.70	1.21	1.17	1.21
1-1/2 x 1-1/4 x 2	2.16	2.10	2.02	2.68	2.39	3.28	0.70	0.67	0.75	1.43	1.39	1.26
1-1/2 x 1-1/2 x 1/2	1.41	1.41	1.66	2.68	2.68	1.34	0.70	0.70	0.43	0.68	0.68	1.12
1-1/2 x 1-1/2 x 3/4	1.52	1.52	1.75	2.68	2.68	1.63	0.70	0.70	0.5	0.79	0.79	1.2
1-1/2 x 1-1/2 x 1	1.65	1.65	1.80	2.68	2.68	1.95	0.70	0.70	0.58	0.92	0.92	1.11
1-1/2 x 1-1/2 x 1-1/4	1.82	1.82	1.88	2.68	2.68	2.39	0.70	0.70	0.67	1.09	1.09	1.17
1-1/2 x 1-1/2 x 2	2.16	2.16	2.02	2.68	2.68	3.28	0.70	0.70	0.75	1.43	1.43	1.26
1-1/2 x 1-1/2 x 2-1/2	2.51	2.51	2.16	2.68	2.68	3.86	0.70	0.70	0.92	1.78	1.78	1.02
*2 x 1/2 x 1/2	1.60	1.60	1.97	3.28	1.34	1.34	0.75	0.43	0.43	0.84	1.06	1.43
*2 x 1/2 x 1-1/4	2.02	1.66	2.16	3.28	1.34	2.39	0.75	0.43	0.67	1.26	1.12	1.45
*2 x 1/2 x 1-1/2	2.02	1.66	2.16	3.28	1.34	2.68	0.75	0.43	0.70	1.26	1.12	1.43
2 x 1/2 x 2	2.25	1.88	2.25	3.28	1.34	3.28	0.75	0.43	0.75	1.49	1.34	1.49
*2 x 3/4 x 1	1.73	1.94	2.02	3.28	1.63	1.95	0.75	0.50	0.58	0.97	1.39	1.33
*2 x 3/4 x 1-1/4	2.25	1.97	2.25	3.28	1.63	2.39	0.75	0.50	0.67	1.49	1.42	1.54
*2 x 3/4 x 1-1/2	2.25	1.97	2.25	3.28	1.63	2.68	0.75	0.50	0.70	1.49	1.42	1.52
2 x 3/4 x 2	2.25	1.97	2.25	3.28	1.63	3.28	0.75	0.50	0.75	1.49	1.42	1.49
*2 x 3/4 x 2-1/2	2.70	2.32	2.70	3.28	1.63	3.86	0.75	0.50	0.92	1.94	1.77	1.56
*2 x 1 x 3/4	1.73	1.94	2.02	3.28	1.95	1.63	0.75	0.58	0.5	0.97	1.25	1.47
*2 x 1 x 1	1.73	1.94	2.02	3.28	1.95	1.95	0.75	0.58	0.58	0.97	1.25	1.33
2 x 1 x 1-1/4	1.90	1.67	2.10	3.28	1.95	2.39	0.75	0.58	0.67	1.14	0.98	1.39
2 x 1 x 1-1/2	2.02	1.80	2.16	3.28	1.95	2.68	0.75	0.58	0.70	1.26	1.11	1.43

*Manufactured to Ward specifications

**CLASS 125 CAST IRON
PIPE FITTINGS**

**CLASS 250 CAST IRON
PIPE FITTINGS**

FLANGES

DRAINAGE FITTINGS



**CAST IRON
REDUCING TEE
CLASS 125, cont.**

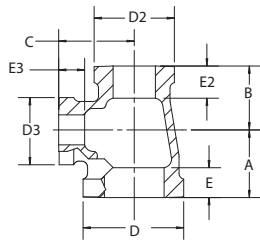

NPS	CENTER TO END A	CENTER TO END B	CENTER TO END C	OUTSIDE DIA. BAND D (MIN)	OUTSIDE DIA. BAND D2 (MIN)	OUTSIDE DIA. BAND D3 (MIN)	LENGTH THREADS E (MIN)	LENGTH THREADS E2 (MIN)	LENGTH THREADS E3 (MIN)	TAKE OUT	TAKE OUT	TAKE OUT
2 x 1 x 2	2.25	2.02	2.25	3.28	1.95	3.28	0.75	0.58	0.75	1.49	1.33	1.49
*2 x 1 x 2-1/2	2.70	2.45	2.70	3.28	1.95	3.86	0.75	0.58	0.92	1.94	1.76	1.56
*2 x 1-1/4 x 1/2	1.49	1.41	1.88	3.28	2.39	1.34	0.75	0.67	0.43	0.73	0.70	1.34
2 x 1-1/4 x 3/4	1.62	1.83	1.95	3.32	2.43	1.67	0.79	0.71	0.54	0.86	1.12	1.40
2 x 1-1/4 x 1	1.73	1.58	2.02	3.28	2.39	1.95	0.75	0.67	0.58	0.97	0.87	1.33
2 x 1-1/4 x 1-1/4	1.90	1.75	2.10	3.28	2.39	2.39	0.75	0.67	0.67	1.14	1.04	1.39
2 x 1-1/4 x 1-1/2	1.02	1.88	2.16	3.28	2.39	2.68	0.75	0.67	0.70	0.26	1.17	1.43
2 x 1-1/4 x 2	2.25	2.10	2.25	3.28	2.39	3.28	0.75	0.67	0.75	1.49	1.39	1.49
2 x 1-1/4 x 2-1/2	2.60	2.45	2.39	3.28	2.39	3.86	0.75	0.67	0.92	1.84	1.74	1.25
2 x 1-1/2 x 1/2	1.49	1.41	1.88	3.28	2.68	1.34	0.75	0.70	0.43	0.73	0.68	1.34
2 x 1-1/2 x 3/4	1.60	1.52	1.97	3.28	2.68	1.63	0.75	0.70	0.50	0.84	0.79	1.42
2 x 1-1/2 x 1	1.73	1.65	2.02	3.28	2.68	1.95	0.75	0.70	0.58	0.97	0.92	1.33
2 x 1-1/2 x 1-1/4	2.02	1.94	2.16	3.28	2.68	2.39	0.75	0.70	0.67	1.26	1.21	1.45
2 x 1-1/2 x 1-1/2	2.02	1.94	2.16	3.28	2.68	2.68	0.75	0.70	0.70	1.26	1.21	1.43
2 x 1-1/2 x 2	2.25	2.16	2.25	3.28	2.68	3.28	0.75	0.70	0.75	1.49	1.43	1.49
2 x 1-1/2 x 2-1/2	2.60	2.51	2.39	3.28	2.68	3.86	0.75	0.70	0.92	1.84	1.78	1.25
2 x 2 x 1/2	1.49	1.49	1.88	3.28	3.28	1.34	0.75	0.75	0.43	0.73	0.73	1.34
2 x 2 x 3/4	1.60	1.60	1.97	3.28	3.28	1.63	0.75	0.75	0.50	0.84	0.84	1.42
2 x 2 x 1	1.73	1.73	2.02	3.28	3.28	1.95	0.75	0.75	0.58	0.97	0.97	1.33
2 x 2 x 1-1/4	1.90	1.90	2.10	3.28	3.28	2.39	0.75	0.75	0.67	1.14	1.14	1.39
2 x 2 x 1-1/2	2.02	2.02	2.16	3.28	3.28	2.68	0.75	0.75	0.70	1.26	1.26	1.43
2 x 2 x 2-1/2	2.60	2.60	2.39	3.28	3.28	3.86	0.75	0.75	0.92	1.84	1.46	1.25
2 x 2 x 3	2.89	2.99	2.52	3.28	3.28	4.62	0.75	0.75	0.98	2.13	2.23	1.32
2-1/2 x 1/2 x 2-1/2	2.70	2.23	2.70	3.86	1.34	3.86	0.92	0.43	0.92	1.56	1.69	1.56
*2-1/2 x 3/4 x 2	2.70	2.32	2.70	3.86	1.63	3.28	0.92	0.50	0.75	1.56	1.77	1.94
2-1/2 x 3/4 x 2-1/2	2.70	2.32	2.70	3.86	1.63	3.86	0.92	0.50	0.92	1.56	1.77	1.56
*2-1/2 x 1 x 3/4	1.94	1.75	2.37	3.86	1.95	1.63	0.92	0.58	0.50	0.80	1.06	1.82
*2-1/2 x 1 x 1-1/4	2.14	2.12	2.51	3.86	1.95	2.39	0.92	0.58	0.67	1.00	1.43	1.80
2-1/2 x 1 x 2	2.39	2.02	2.60	3.86	1.95	3.28	0.92	0.58	0.75	1.25	1.33	1.84
2-1/2 x 1 x 2-1/2	2.70	2.37	2.70	3.86	1.95	3.86	0.92	0.58	0.92	1.56	1.68	1.56
*2-1/2 x 1-1/4 x 1	2.14	2.12	2.51	3.86	2.39	1.95	0.92	0.67	0.58	1.00	1.41	1.82
*2-1/2 x 1-1/4 x 1-1/4	2.04	1.90	2.45	3.86	2.39	2.39	0.92	0.67	0.67	0.90	1.19	1.74
2-1/2 x 1-1/4 x 2	2.70	2.45	2.70	3.86	2.39	3.28	0.92	0.67	0.75	1.56	1.74	1.94
2-1/2 x 1-1/4 x 2-1/2	2.70	2.45	2.70	3.86	2.39	3.86	0.92	0.67	0.92	1.56	1.74	1.56
*2-1/2 x 1-1/2 x 1/2	1.63	1.49	2.23	3.86	2.68	1.34	0.92	0.70	0.43	0.49	0.76	1.70
*2-1/2 x 1-1/2 x 1-1/4	2.04	1.90	2.45	3.86	2.68	2.39	0.92	0.70	0.67	0.90	1.17	1.74
2-1/2 x 1-1/2 x 1-1/2	2.16	1.94	2.51	3.86	2.68	2.68	0.92	0.70	0.70	1.02	1.21	1.79
2-1/2 x 1-1/2 x 2	2.39	2.16	2.60	3.86	2.68	3.28	0.92	0.70	0.75	1.25	1.43	1.84
2-1/2 x 1-1/2 x 2-1/2	2.70	2.51	2.70	3.86	2.68	3.86	0.92	0.70	0.92	1.56	1.78	1.56
2-1/2 x 2 x 1/2	1.63	1.49	2.23	3.86	3.28	1.34	0.92	0.75	0.43	0.49	0.73	1.70
2-1/2 x 2 x 3/4	1.74	1.60	2.32	3.86	3.28	1.63	0.92	0.75	0.50	0.60	0.84	1.77
2-1/2 x 2 x 1	1.87	1.73	2.37	3.86	3.28	1.95	0.92	0.75	0.58	0.73	0.97	1.68
2-1/2 x 2 x 1-1/4	2.04	1.90	2.45	3.86	3.28	2.39	0.92	0.75	0.67	0.90	1.14	1.74
2-1/2 x 2 x 1-1/2	2.16	2.02	2.51	3.86	3.28	2.68	0.92	0.75	0.70	1.02	1.26	1.78
2-1/2 x 2 x 2	2.39	2.25	2.60	3.86	3.28	3.28	0.92	0.75	0.75	1.25	1.49	1.84
2-1/2 x 2 x 2-1/2	2.70	2.60	2.70	3.86	3.28	3.86	0.92	0.75	0.92	1.56	1.84	1.56
2-1/2 x 2 x 3	2.99	2.89	2.83	3.86	3.28	4.62	0.92	0.75	0.98	1.85	2.13	1.63
2-1/2 x 2-1/2 x 1/2	1.87	1.87	2.23	3.86	3.86	1.34	0.92	0.92	0.43	0.73	0.73	1.69
2-1/2 x 2-1/2 x 3/4	1.87	1.87	2.32	3.86	3.86	1.63	0.92	0.92	0.50	0.73	0.73	1.77
2-1/2 x 2-1/2 x 1	1.87	1.87	2.37	3.86	3.86	1.95	0.92	0.92	0.58	0.73	0.73	1.68
2-1/2 x 2-1/2 x 1-1/4	2.04	2.04	2.45	3.86	3.86	2.39	0.92	0.92	0.67	0.90	0.90	1.74
2-1/2 x 2-1/2 x 1-1/2	2.16	2.16	2.51	3.86	3.86	2.68	0.92	0.92	0.70	1.02	1.02	1.78
2-1/2 x 2-1/2 x 2	2.39	2.39	2.60	3.86	3.86	3.28	0.92	0.92	0.75	1.25	1.25	1.84
2-1/2 x 2-1/2 x 3	2.99	2.99	2.83	3.86	3.86	4.62	0.92	0.92	0.98	1.85	1.85	1.63
3 x 1 x 3	3.08	2.66	3.08	4.62	1.95	4.62	0.98	0.58	0.98	1.88	1.97	1.88
3 x 1-1/4 x 3	3.08	2.74	3.08	4.62	2.39	4.62	0.98	0.67	0.98	1.88	2.03	1.88
*3 x 1-1/2 x 1-1/2	2.52	2.25	2.89	4.62	2.68	2.68	0.98	0.70	0.70	1.32	1.52	2.16
*3 x 1-1/2 x 2	2.52	2.25	2.89	4.62	2.68	3.28	0.98	0.70	0.75	1.32	1.52	2.13
3 x 1-1/2 x 3	3.08	2.80	3.08	4.62	2.68	4.62	0.98	0.70	0.98	1.88	2.07	1.88
3 x 2 x 1-1/2	2.29	2.02	2.80	4.62	3.28	2.68	0.98	0.75	0.70	1.09	1.26	2.07
3 x 2 x 2	2.52	2.25	2.89	4.62	3.28	3.28	0.98	0.75	0.75	1.32	1.49	2.13

*Manufactured to Ward specifications



**CAST IRON
REDUCING TEE
CLASS 125, cont.**

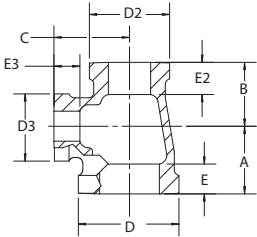

NPS	CENTER TO END A	CENTER TO END B	CENTER TO END C	OUTSIDE DIA. BAND D (MIN)	OUTSIDE DIA. BAND D2 (MIN)	OUTSIDE DIA. BAND D3 (MIN)	LENGTH THREADS E (MIN)	LENGTH THREADS E2 (MIN)	LENGTH THREADS E3 (MIN)	TAKE OUT	TAKE OUT	TAKE OUT
3 x 2 x 2-1/2	2.83	2.60	2.99	4.62	3.28	3.86	0.98	0.75	0.92	1.63	1.84	1.85
3 x 2 x 3	3.08	2.89	3.08	4.62	3.28	4.62	0.98	0.75	0.98	1.88	2.13	1.88
3 x 2-1/2 x 1-1/4	2.17	2.04	2.74	4.62	3.86	2.39	0.98	0.92	0.67	0.97	0.90	2.03
3 x 2-1/2 x 1-1/2	2.29	2.16	2.80	4.66	3.90	2.72	1.02	0.96	0.74	1.09	1.02	2.08
3 x 2-1/2 x 2	2.52	2.39	2.89	4.62	3.86	3.28	0.98	0.92	0.75	1.32	1.25	2.13
3 x 2-1/2 x 2-1/2	2.83	2.70	2.99	4.62	3.86	3.86	0.98	0.92	0.92	1.63	1.56	1.85
3 x 2-1/2 x 3	3.08	2.99	3.08	4.62	3.86	4.62	0.98	0.92	0.98	1.88	1.85	1.88
3 x 3 x 3/4	1.87	1.87	2.61	4.66	4.66	1.67	1.02	1.02	0.54	0.67	0.67	2.06
3 x 3 x 1	2.00	2.00	2.66	4.62	4.62	1.95	0.98	0.98	0.58	0.80	0.80	1.97
3 x 3 x 1-1/4	2.17	2.17	2.74	4.62	4.62	2.39	0.98	0.98	0.67	0.97	0.97	2.03
3 x 3 x 1-1/2	2.29	2.29	2.80	4.62	4.62	2.68	0.98	0.98	0.70	1.09	1.09	2.07
3 x 3 x 2	2.52	2.52	2.89	4.62	4.62	3.28	0.98	0.98	0.75	1.32	1.32	2.13
3 x 3 x 2-1/2	2.83	2.83	2.99	4.62	4.62	3.86	0.98	0.98	0.92	1.63	1.63	1.85
3 x 3 x 4	3.60	3.60	3.30	4.66	4.66	5.83	1.02	1.02	1.12	2.40	2.40	2.00
4 x 1 x 4	3.79	3.18	3.79	5.79	1.95	5.79	1.08	0.58	1.08	2.49	2.49	2.49
4 x 1-1/2 x 4	3.79	3.32	3.79	5.79	2.68	5.79	1.08	0.70	1.08	2.49	2.59	2.49
4 x 2 x 2	2.74	2.25	3.41	5.79	3.28	3.28	1.08	0.75	0.75	1.44	1.49	2.65
4 x 2 x 4	3.79	3.41	3.79	5.79	3.28	5.79	1.08	0.75	1.08	2.49	2.65	2.49
4 x 2-1/2 x 2-1/2	3.05	2.70	3.51	5.79	3.86	3.86	1.08	0.92	0.92	1.75	1.56	2.37
4 x 2-1/2 x 4	3.79	3.51	3.79	5.79	3.86	5.79	1.08	0.92	1.08	2.49	2.37	2.49
*4 x 3 x 1-1/2	2.51	2.39	3.32	5.79	4.62	2.68	1.08	0.98	0.70	1.21	1.19	2.59
4 x 3 x 2	2.74	2.52	3.41	5.79	4.62	3.28	1.08	0.98	0.75	1.44	1.32	2.65
4 x 3 x 2-1/2	3.05	2.83	3.51	5.79	4.62	3.86	1.08	0.98	0.92	1.75	1.63	2.37
4 x 3 x 3	3.30	3.08	3.60	5.79	4.62	4.62	1.08	0.98	0.98	2.00	1.88	2.40
4 x 3 x 4	3.79	3.60	3.79	5.79	4.62	5.79	1.08	0.98	1.08	2.49	2.40	2.49
4 x 3-1/2 x 4	3.79	3.69	3.79	5.79	5.20	5.79	1.08	1.03	1.08	2.49	2.44	2.49
4 x 4 x 1	2.22	2.22	3.18	5.83	5.83	1.99	1.12	1.12	0.62	0.92	0.92	2.50
4 x 4 x 1-1/4	2.39	2.39	3.26	5.83	5.83	2.43	1.12	1.12	0.71	1.09	1.09	2.55
4 x 4 x 1-1/2	2.51	2.51	3.32	5.79	5.79	2.68	1.08	1.08	0.70	1.21	1.21	2.59
4 x 4 x 2	2.74	2.74	3.41	5.79	5.79	3.28	1.08	1.08	0.75	1.44	1.44	2.65
4 x 4 x 2-1/2	3.05	3.05	3.51	5.79	5.79	3.86	1.08	1.08	0.92	1.75	1.75	2.37
4 x 4 x 3	3.30	3.30	3.60	5.79	5.79	4.62	1.08	1.08	0.98	2.00	2.00	2.40
5 x 5 x 3	3.51	3.51	4.22	7.05	7.05	4.66	1.18	1.18	1.02	2.10	2.10	3.02
5 x 5 x 4	4.00	4.00	4.41	7.05	7.05	5.83	1.18	1.18	1.12	2.60	2.60	3.11
6 x 6 x 3	3.64	3.64	4.75	8.28	8.28	4.66	1.28	1.28	1.02	2.13	2.13	3.55
6 x 6 x 4	4.13	4.13	4.94	8.28	8.28	5.83	1.28	1.28	1.12	2.62	2.62	3.64
6 x 6 x 5	4.63	4.63	5.03	8.28	8.28	7.05	1.28	1.28	1.18	3.12	3.12	3.62

*Manufactured to Ward specifications

**CLASS 125 CAST IRON
PIPE FITTINGS**

**CLASS 250 CAST IRON
PIPE FITTINGS**

FLANGES

DRAINAGE FITTINGS



**CAST IRON
CONCENTRIC
REDUCING
COUPLING
CLASS 125**

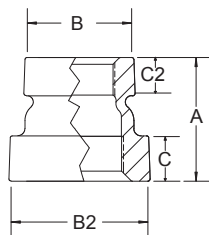

NPS	LENGTH COUPLING A	OUTSIDE DIA. BAND SMALL END B (MIN)	OUTSIDE DIA. LARGE END B2 (MIN)	LENGTH THREADS SMALL END C (MIN)	LENGTH THREADS LARGE END C2 (MIN)	TAKE OUT	TAKE OUT
3/4 x 1/2	1.50	1.31	1.62	0.43	0.50	0.20	0.22
1 x 1/2	1.70	1.31	1.99	0.43	0.58	0.85	0.85
1 x 3/4	1.70	1.63	1.99	0.50	0.58	0.85	0.85
1-1/4 x 1/2	2.13	1.34	2.39	0.43	0.67	0.36	0.14
1-1/4 x 3/4	2.13	1.95	2.39	0.50	0.67	0.17	0.32
1-1/4 x 1	2.13	1.95	2.39	0.58	0.67	0.17	0.30
1-1/2 x 1/2	2.25	1.34	2.68	0.43	0.70	0.40	0.14
1-1/2 x 3/4	2.25	1.63	2.68	0.50	0.70	0.40	0.27
1-1/2 x 1	2.25	2.39	2.68	0.58	0.70	0.40	0.44
1-1/2 x 1-1/4	2.25	2.39	2.68	0.67	0.70	0.36	0.52
2 x 1/2	2.32	1.63	3.28	0.43	0.75	0.40	0.48
2 x 3/4	2.32	1.63	3.28	0.50	0.75	0.40	0.45
2 x 1	2.32	1.95	3.28	0.58	0.75	0.40	0.44
2 x 1-1/4	2.32	2.39	3.28	0.67	0.75	0.40	0.45
2 x 1-1/2	2.32	2.68	3.28	0.70	0.75	0.40	0.44
2-1/2 x 1-1/2	2.63	1.95	3.28	0.58	0.75	0.40	0.44
2-1/2 x 2	2.63	2.39	3.28	0.67	0.75	0.40	0.45
3 x 1-1/2	2.88	1.63	3.28	0.43	0.75	0.40	0.48
3 x 2	2.88	1.63	3.28	0.50	0.75	0.40	0.45
3 x 2-1/2	2.88	3.86	4.62	0.92	0.98	0.24	0.79
4 x 2	2.63	3.28	3.86	0.75	0.92	0.18	0.56
4 x 2-1/2	2.32	1.63	3.28	0.43	0.75	0.40	0.48
4 x 3	2.32	1.63	3.28	0.50	0.75	0.40	0.45
6 x 4	2.32	1.63	3.28	0.43	0.75	0.40	0.48



**CAST IRON
ECCENTRIC
REDUCING
COUPLING
CLASS 125**

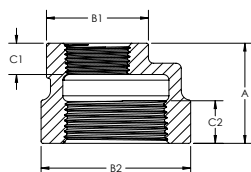

NPS	LENGTH COUPLING A	OUTSIDE DIA. BAND SMALL END B1 (MIN)	OUTSIDE DIA. LARGE END B2 (MIN)	LENGTH THREADS SMALL END C1 (MIN)	LENGTH THREADS LARGE END C2 (MIN)	TAKE OUT	TAKE OUT
3/4 x 1/2	1.52	1.34	1.63	0.43	0.58	0.21	0.23
1 x 1/2	1.59	1.34	1.95	0.43	0.58	0.11	0.26
1 x 3/4	1.60	1.63	1.95	0.50	0.58	0.12	0.25
1-1/4 x 1/2	1.58	1.34	2.39	0.43	0.67	0.08	0.26
1-1/4 x 3/4	1.65	1.63	2.39	0.50	0.67	0.12	0.28
1-1/4 x 1	1.75	1.95	2.39	0.58	0.67	0.17	0.19
1-1/2 x 1/2	2.12	1.34	3.28	0.70	0.75	0.09	0.28
1-1/2 x 3/4	1.68	1.63	2.68	0.50	0.70	0.12	0.29
1-1/2 x 1	1.78	1.95	2.68	0.58	0.70	0.17	0.21
1-1/2 x 1-1/4	1.85	2.39	2.68	0.67	0.70	0.20	0.22
2 x 1/2	1.94	1.34	3.28	0.43	0.75	0.42	0.21
2 x 3/4	1.79	1.63	3.28	0.50	0.75	0.36	0.14
2 x 1	1.79	1.63	3.28	0.50	0.75	0.24	0.31
2 x 1-1/4	1.99	1.95	3.28	0.58	0.75	0.30	0.35
2 x 1-1/2	2.12	2.39	3.28	0.67	0.75	0.30	0.34
2-1/2 x 1	2.26	1.95	3.86	0.58	0.75	0.09	0.45
2-1/2 x 1-1/4	2.30	2.39	3.86	0.67	0.75	0.07	0.44
2-1/2 x 1-1/2	2.49	2.68	3.86	0.70	0.92	0.52	0.11
2-1/2 x 2	2.56	3.28	3.86	0.75	0.92	0.52	0.14
3 x 1	2.44	1.95	4.62	0.58	0.98	0.19	0.71
3 x 1-1/4	2.52	2.39	4.62	0.67	0.98	0.18	2.48
3 x 1-1/2	2.57	2.68	4.62	0.70	0.98	0.56	0.09
3 x 2	2.75	3.86	4.62	0.92	0.98	0.24	0.18
3 x 2-1/2	2.82	3.86	4.62	0.92	0.98	0.27	0.21
4 x 1-1/4	2.71	2.39	5.79	0.67	1.08	0.30	0.65
4 x 1-1/2	2.75	3.28	5.79	0.70	1.08	0.21	0.65
4 x 2	2.94	3.28	5.79	0.75	1.08	0.71	0.17



**CAST IRON PIPE
CAP CLASS 125**

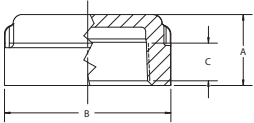

NPS	OVERALL HEIGHT A	OUTSIDE DIA. BAND B (MIN)	LENGTH THREADS C (MIN)
2-1/2	1.81	3.86	0.92
3	1.91	4.62	0.98
3-1/2	2.03	5.20	1.03
4	2.22	5.79	1.08
5	2.38	7.05	1.18
6	2.63	8.28	1.28
8	2.88	10.63	1.47



**CAST IRON
CROSS
CLASS 125**

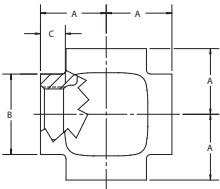

NPS	CENTER TO END A	OUTSIDE DIA. BAND B (MIN)	LENGTH THREADS C (MIN)	TAKE OUT
1/2	1.25	1.34	0.43	0.71
3/4	1.44	1.63	0.50	0.89
1	1.63	1.95	0.58	0.94
1-1/4	1.94	2.39	0.67	1.23
1-1/2	2.13	2.68	0.70	1.40
2	2.25	3.28	0.75	1.49
4	3.79	5.79	1.08	2.49



**CAST IRON
REDUCING CROSS
CLASS 125**

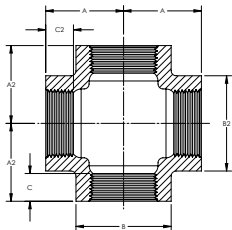

NPS	CENTER TO END A	CENTER TO END A2	OUTSIDE DIA. BAND B (MIN)	OUTSIDE DIA. BAND B2 (MIN)	LENGTH THREADS C (MIN)	LENGTH THREADS C2 (MIN)	TAKE OUT	TAKE OUT
1-1/4 x 1	1.67	1.58	2.39	1.95	0.67	0.58	0.96	0.89
1-1/2 x 1-1/4	1.86	1.82	2.68	2.51	0.70	0.67	1.14	1.11
1-1/2 x 1-1/4 x 1	1.88	1.82	2.68	2.43	0.70	0.58	1.16	1.11
1-1/2 x 1-1/4 x 1 x 1	1.78	1.60	2.68	1.95	0.70	0.58	1.06	0.92
1-1/2 x 1	1.80	1.65	2.68	1.95	0.70	0.58	1.07	0.96
1-1/2 x 1 x 1 x 1	1.79	1.72	2.68	1.95	0.70	0.58	1.07	1.04
2 x 1	2.02	1.73	3.28	1.95	0.75	0.58	1.26	1.04
2 x 1-1/4	2.11	2.02	3.28	2.42	0.75	0.67	1.35	1.31
2 x 1-1/2	2.17	2.03	3.28	2.71	0.75	0.70	1.41	1.31
2 x 1-1/2 x 1 x 1	1.72	2.04	3.28	1.97	0.75	0.58	0.96	0.68



**CAST IRON 90° ELL
CLASS 250**

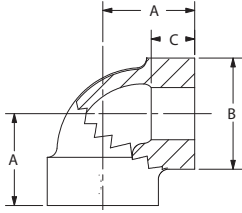

NPS	CENTER TO END A	OUTSIDE DIA. BAND B (MIN)	LENGTH THREADS C (MIN)	TAKE OUT
1/2	1.25	0.60	0.57	0.72
3/4	1.44	0.68	0.64	0.89
1	1.63	0.76	0.75	0.95
1-1/4	1.94	0.88	0.84	1.23
1-1/2	2.13	0.97	0.87	1.41
2	2.50	1.12	1.00	1.74
2-1/2	2.94	1.30	1.17	1.81



**CAST IRON 45° ELL
CLASS 250**

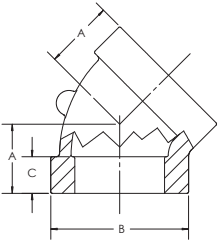

NPS	CENTER TO END A	OUTSIDE DIA. BAND B (MIN)	LENGTH THREADS C (MIN)	TAKE OUT
1/2	1.00	0.60	0.57	0.47
3/4	1.13	0.68	0.64	0.58
1	1.31	0.76	0.75	0.63
1-1/4	1.50	0.88	0.84	0.79
1-1/2	1.69	0.97	0.87	0.97
2	2.00	1.12	1.00	1.24
2-1/2	2.25	1.30	1.17	1.11



**CAST IRON TEE
CLASS 250**

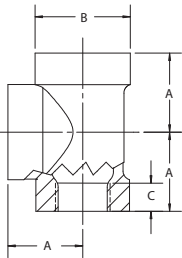

NPS	CENTER TO END A	OUTSIDE DIA. BAND B (MIN)	LENGTH THREADS C (MIN)	TAKE OUT
3/8	1.06	0.55	0.47	0.65
1/2	1.25	0.60	0.57	0.72
3/4	1.44	0.68	0.64	0.89
1	1.63	0.76	0.75	0.95
1-1/4	1.94	0.88	0.84	1.23
1-1/2	2.13	0.97	0.87	1.41
2	2.50	1.12	1.00	1.74
2-1/2	2.94	1.30	1.17	1.80



**CAST IRON REDUCING
TEE CLASS 250**

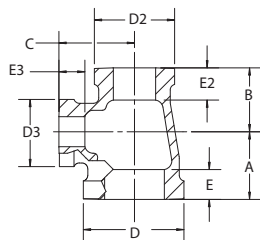

NPS	CENTER TO END A	CENTER TO END B	CENTER TO END C	TAKE OUT A	TAKE OUT B	TAKE OUT C
1-1/4 x 1-1/4 x 3/4	0.94	0.94	1.13	0.23	0.23	0.58
1-1/2 x 1-1/2 x 3/4	1.00	1.00	1.25	0.28	0.28	0.70
2 x 2 x 3/4	1.13	1.13	1.44	0.37	0.37	0.89
2 x 2 x 1-1/2	1.50	1.50	1.63	0.74	0.74	0.90



**CAST IRON FLANGE
UNION CLASS 125,
Working Pressure 175 PSI**

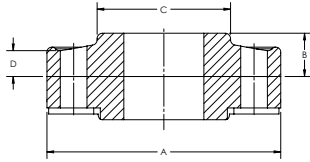

NPS	OUTSIDE FLANGE DIA. A	OVERALL HEIGHT B (MIN)	DIA. HUB C (MIN)	THICKNESS FLANGE D (MIN)	NUMBER BOLT HOLES	BOLT HOLE SIZE	BOLT CIRCLE DIA.	DIA. BOLTS	BOLT LENGTH
*1/2	2.81	0.62	1.31	0.43	3	0.44	1.69	0.44	1.75
*3/4	3.43	0.75	1.75	0.43	3	0.50	2.31	0.44	1.75
*1	3.50	0.75	1.88	0.43	3	0.50	2.50	0.44	1.75
*1-1/4	4.06	0.75	2.25	0.43	4	0.50	3.00	0.44	1.75
*1-1/2	4.37	0.81	2.50	0.43	4	0.50	3.38	0.44	1.75
*2	5.12	1.00	3.13	0.50	4	0.56	4.06	0.50	2.25
*2-1/2	6.62	1.25	3.56	0.62	4	0.69	4.63	0.63	2.75
*3	6.68	1.25	4.25	0.62	4	0.69	5.38	0.63	2.50
*3-1/2	7.25	1.25	4.75	0.62	4	0.69	5.88	0.63	2.50
*4	7.81	1.37	4.94	0.68	5	0.69	6.56	0.63	2.50
*5	9.43	1.43	6.69	0.75	5	0.69	8.06	0.63	2.75
*6	10.56	1.50	7.31	1.00	6	0.69	9.06	0.63	2.75
*8	13.50	1.75	9.25	1.18	7	0.88	11.88	0.75	3.75

*Manufactured to Ward specifications



**CAST IRON FLOOR
FLANGE**

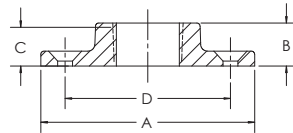

NPS	OUTSIDE FLANGE DIA. A	OVERALL HEIGHT B (MIN)	LENGTH THREADS C (MIN)	NUMBER BOLT HOLES	BOLT HOLE SIZE	BOLT CIRCLE DIA. D
*1/4	2.37	0.46	0.32	3	0.27	1.60
*3/8	2.93	0.52	0.36	4	0.27	1.93
*1/2	3.00	0.65	0.43	4	0.24	2.10
*3/4	3.25	0.65	0.50	4	0.25	2.31
*1	3.87	0.77	0.58	4	0.27	3.00
*1-1/4	3.87	0.77	0.67	4	0.27	3.00
*1-1/2	4.50	0.99	0.70	4	0.30	3.60
*2	5.50	1.00	0.75	4	0.39	4.25
*2-1/2	5.81	1.06	0.92	4	0.33	4.79
*3	6.37	1.10	0.98	6	0.31	5.18
*4	7.93	1.10	1.05	5	0.38	6.70

*Manufactured to Ward specifications



**MALLEABLE IRON
FLOOR FLANGE**

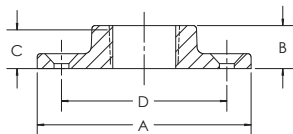

NPS	OUTSIDE FLANGE DIA. A	OVERALL HEIGHT B (MIN)	LENGTH THREADS C (MIN)	NUMBER BOLT HOLES	BOLT HOLE SIZE	BOLT CIRCLE DIA. D
*1/4	2.37	0.46	0.32	3	0.27	1.60
*3/8	2.93	0.52	0.36	4	0.27	1.93
*1/2	3.00	0.65	0.43	4	0.24	2.10
*3/4	3.25	0.65	0.5	4	0.25	2.31
*1	3.87	0.77	0.58	4	0.27	3.00
*1-1/4	3.87	0.77	0.67	4	0.27	3.00
*1-1/2	4.50	0.99	0.70	4	0.30	3.60
*2	5.50	1.00	0.75	4	0.39	4.25
*2-1/2	5.81	1.06	0.92	4	0.33	4.79
*3	6.37	1.10	0.98	6	0.31	5.18
*4	7.93	1.10	1.05	5	0.38	6.70

*Manufactured to Ward specifications

All Malleable Iron Floor Flanges listed above are made with ASTM A197 Malleable Iron



CAST IRON BLIND FLANGE

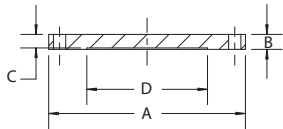

NPS	OUTSIDE FLANGE DIA. A	THICKNESS FLANGE D (MIN)	NUMBER BOLT HOLES	BOLT HOLE SIZE	BOLT CIRCLE DIA.	DIA. PORT D
1	4.25	0.44	4	0.62	3.12	1.00
1-1/4	4.62	0.50	4	0.62	3.50	1.25
1-1/2	5.00	0.56	4	0.62	3.88	1.50
2	6.00	0.62	4	0.75	4.75	2.00
2-1/2	7.00	0.69	4	0.75	5.5	2.50
3	7.50	0.75	4	0.75	6.00	3.00
3-1/2	8.50	0.81	8	0.75	7.00	3.50
4	9.00	0.94	8	0.75	7.50	4.00
5	10.00	0.94	8	0.88	8.50	5.00
6	11.00	1.00	8	0.88	9.50	6.00
8	13.50	1.12	8	0.88	11.75	8.00
10	16.00	1.19	12	1.00	14.25	10.00



CAST IRON COMPANION FLANGE

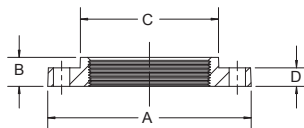

NPS	OUTSIDE FLANGE DIA. A	OVERALL LENGTH B (MIN)	DIA. HUB C (MIN)	THICKNESS FLANGE D (MIN)	NUMBER BOLT HOLES	BOLT HOLE SIZE	BOLT CIRCLE DIAMETER
1	4.25	0.69	1.94	0.44	4	0.62	3.12
1-1/4	4.62	0.81	2.31	0.50	4	0.62	3.50
1-1/2	5.00	0.88	2.56	0.56	4	0.62	3.88
2	6.00	1.00	3.06	0.62	4	0.75	4.75
2-1/2	7.00	1.12	3.56	0.69	4	0.75	5.50
3	7.50	1.19	4.25	0.75	4	0.75	6.00
3-1/2	8.50	1.25	4.81	0.81	8	0.75	7.00
4	9.00	1.31	5.31	0.94	8	0.75	7.50
5	10.00	1.44	6.44	0.94	8	0.88	8.50
6	11.00	1.56	7.56	1.00	8	0.88	9.50
8	13.50	1.75	9.69	1.12	8	0.88	11.75
10	16.00	1.94	11.94	1.19	12	1.00	14.25



CAST IRON REDUCING COMPANION FLANGE

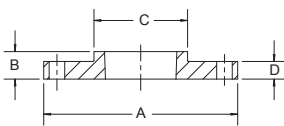

NPS	OUTSIDE FLANGE DIA. A	OVERALL HEIGHT B (MIN)	DIA. HUB C (MIN)	THICKNESS FLANGE D (MIN)	NUMBER BOLT HOLES	BOLT HOLE SIZE	BOLT CIRCLE DIAMETER
3/4 x 1-1/2	5.00	0.69	1.94	0.56	4	0.62	3.88
1 x 1-1/2	5.00	0.69	1.94	0.56	4	0.62	3.88
1 x 2	6.00	0.69	1.94	0.62	4	0.75	4.75
1 x 3	7.50	0.69	1.93	0.75	4	0.75	6.00
1-1/4 x 2	6.00	0.81	2.31	0.62	4	0.75	4.75
1-1/4 x 3	7.50	0.81	2.31	0.75	4	0.75	6.00
1-1/2 x 2	6.00	0.88	2.56	0.62	4	0.75	4.75
1-1/2 x 2-1/2	7.00	0.88	2.56	0.69	4	0.75	5.50
1-1/2 x 3	7.50	0.88	2.56	0.75	4	0.75	6.00
1-1/2 x 4	9.00	0.88	2.56	0.94	8	0.75	7.50
1-1/2 x 6	11.00	0.88	2.56	1.00	8	0.88	9.50
2 x 2-1/2	7.00	1	3.06	0.69	4	0.75	5.50
2 x 3	7.50	1	3.06	0.75	4	0.75	6.00
2 x 4	9.00	1	3.06	0.94	8	0.75	7.50
2 x 5	10.00	1	3.06	0.94	8	0.88	8.50
2 x 6	11.00	1	3.06	1.00	8	0.88	9.50
2 x 8	13.50	1	3.06	1.12	8	0.88	11.75
2-1/2 x 3	7.50	1.12	3.56	0.75	4	0.75	6.00
2-1/2 x 4	9.00	1.12	3.56	0.94	8	0.75	7.50
2-1/2 x 5	10.00	1.12	3.56	0.94	8	0.88	8.50
2-1/2 x 6	11.00	1.12	3.56	1.00	8	0.88	9.50
3 x 4	9.00	1.19	4.25	0.94	8	0.75	7.50
3 x 5	10.00	1.19	4.25	0.94	8	0.88	8.50
3 x 6	11.00	1.19	4.25	1.00	8	0.88	9.50
3 x 8	13.50	1.19	4.25	1.12	8	0.88	11.75
3-1/2 x 4	9.00	1.25	4.81	0.94	8	0.75	7.50
4 x 5	10.00	1.31	5.31	0.94	8	0.88	8.50
4 x 6	11.00	1.56	4.51	1.00	8	0.88	9.50
4 x 8	13.50	1.31	5.31	1.20	8	0.88	11.75
5 x 6	11.00	1.44	6.44	1.00	8	0.88	9.50
5 x 8	13.50	1.44	6.44	1.12	8	0.88	11.75
6 x 8	13.50	1.56	7.56	1.12	8	0.88	11.75



**CAST IRON FLANGED
90° ELL CLASS 125**

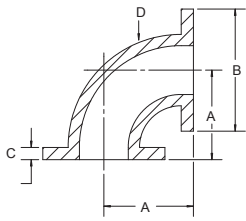

NPS	CENTER TO FACE A	OUTSIDE FLANGE DIA. B	THICKNESS FLANGE C (MIN)	WALL THICKNESS D	NUMBER BOLT HOLES	BOLT HOLE SIZE	BOLT CIRCLE DIA.	DIA. BOLTS	BOLT LENGTH
2	4.50	6.00	0.62	0.31	4	0.75	4.75	0.63	2.25
2-1/2	5.00	7.00	0.69	0.31	4	0.75	5.50	0.63	2.50
3	5.50	7.50	0.75	0.38	4	0.75	6.00	0.63	2.50
4	6.50	9.00	0.94	0.50	8	0.75	7.50	0.63	3.00
5	7.50	10.00	0.94	0.50	8	0.88	8.50	0.75	3.00
6	8.00	11.00	1.00	0.56	8	0.88	9.50	0.75	3.25
8	9.00	13.50	1.12	0.62	8	0.88	11.75	0.75	3.50
10	11.00	16.00	1.19	0.75	12	1.00	14.25	0.88	3.75
12	12.00	19.00	1.25	0.81	12	1.00	17.00	0.88	3.75

*Flanged ell made in North America



**CAST IRON FLANGED
REDUCING 90° ELL
CLASS 125**

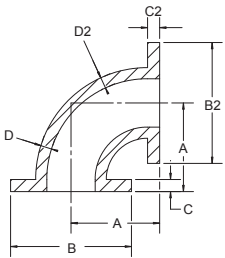

NPS	CENTER TO FACE A	OUTSIDE FLANGE DIA. B	OUTSIDE FLANGE DIA. B2	THICKNESS FLANGE C (MIN)	THICKNESS FLANGE C2 (MIN)	WALL THICKNESS	WALL THICKNESS D2
3 x 2	5.50	7.50	6.00	0.75	0.62	0.38	0.31
3 x 2-1/2	5.50	7.50	7.00	0.75	0.69	0.38	0.31
4 x 2	6.50	9.00	6.00	0.94	0.62	0.50	0.31
4 x 2-1/2	6.50	9.00	7.00	0.94	0.69	0.50	0.31
4 x 3	6.50	9.00	7.50	0.94	0.75	0.50	0.38
5 x 4	8.00	10.00	9.00	0.94	0.94	0.50	0.50
6 x 2-1/2	8.00	11.00	7.00	1.00	0.69	0.56	0.31
6 x 3	8.00	11.00	7.50	1.00	0.75	0.56	0.38
6 x 4	8.00	11.00	9.00	1.00	0.94	0.56	0.50
6 x 5	8.00	11.00	10.00	1.00	0.94	0.56	0.50
8 x 4	9.00	13.50	9.00	1.12	0.94	0.62	0.50
8 x 5	9.00	13.50	10.00	1.12	0.94	0.62	0.50
8 x 6	9.00	13.50	11.00	1.12	1.00	0.62	0.56
10 x 6	11.00	16.00	11.00	1.19	1.00	0.75	0.56
10 x 8	11.00	16.00	13.50	1.19	1.12	0.75	0.62
12 x 6	12.00	19.00	11.00	1.25	1.00	0.81	0.56
12 x 8	12.00	19.00	13.50	1.25	1.12	0.81	0.62
12 x 10	12.00	19.00	16.00	1.25	1.19	0.81	0.75

*Flanged reducing ell made in North America



**CAST IRON FLANGED
90° ELL LONG RADIUS
CLASS 125**

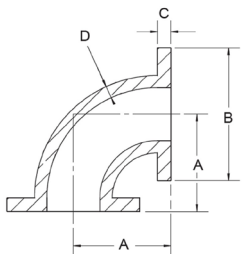

NPS	CENTER TO FACE A	OUTSIDE FLANGE DIA. B	THICKNESS FLANGE C (MIN)	WALL THICKNESS D	NUMBER BOLT HOLES	BOLT HOLE SIZE	BOLT CIRCLE SIZE	DIA. BOLTS	BOLT LENGTH
2	6.50	6.00	0.62	0.31	4	0.75	4.75	0.63	2.25
2-1/2	7.00	7.00	0.69	0.31	4	0.75	5.50	0.63	2.50
3	7.75	7.50	0.75	0.38	4	0.75	6.00	0.63	2.50
4	9.00	9.00	0.94	0.50	8	0.75	7.50	0.63	3.00
6	11.50	11.00	1.00	0.56	8	0.88	9.50	0.75	3.33
8	14.00	13.50	1.12	0.62	8	0.88	11.75	0.75	3.50
10	16.50	16.00	1.19	0.75	12	1.00	14.25	0.88	3.75
12	19.00	19.00	1.25	0.81	12	1.00	17.00	0.88	3.75

*Flanged ell made in North America



**CAST IRON FLANGED
90° REDUCING ELL
LONG RADIUS
CLASS 125**

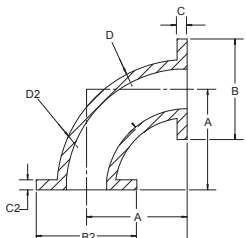

NPS	CENTER TO FACE A	OUTSIDE FLANGE DIA. B	OUTSIDE FLANGE DIA. B2	THICKNESS FLANGE C (MIN)	THICKNESS FLANGE C2 (MIN)	WALL THICKNESS D	WALL THICKNESS D2
4 x 3	9.00	9.00	7.50	0.94	0.75	0.50	0.38
6 x 4	11.50	11.00	9.00	1.00	0.94	0.56	0.50
8 x 6	14.00	13.50	11.00	1.12	1.00	0.62	0.56

*Flanged reducing ell made in North America



**CAST IRON FLANGED
45° ELL CLASS 125**

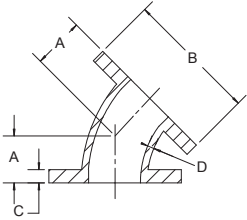

NPS	CENTER TO FACE A	OUTSIDE FLANGE DIA. B	THICKNESS FLANGE C (MIN)	WALL THICKNESS D	NUMBER BOLT HOLES	BOLT HOLE SIZE	BOLT CIRCLE DIA.	DIA. BOLTS	BOLT LENGTH
2	2.50	6.00	0.62	0.31	4	0.75	4.75	0.63	2.25
2-1/2	3.00	7.00	0.69	0.31	4	0.75	5.50	0.63	2.50
3	3.00	7.50	0.75	0.38	4	0.75	6.00	0.63	2.50
4	4.00	9.00	0.94	0.50	8	0.75	7.50	0.63	3.00
5	4.50	10.00	0.94	0.50	8	0.88	8.50	0.75	3.00
6	5.00	11.00	1.00	0.56	8	0.88	9.50	0.75	3.25
8	5.50	13.50	1.12	0.62	8	0.88	11.75	0.75	3.50
10	6.50	16.00	1.19	0.75	12	1.00	14.25	0.88	3.75
12	7.50	19.00	1.25	0.81	12	1.00	17.00	0.88	3.75

*Flanged ell made in North America



**CAST IRON FLANGED
22-1/2° ELL CLASS 125**

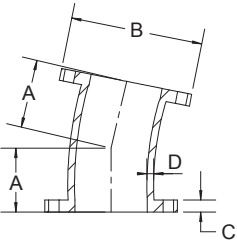

NPS	CENTER TO FACE A	OUTSIDE FLANGE DIA. B	THICKNESS FLANGE C (MIN)	WALL THICKNESS D	NUMBER BOLT HOLES	BOLT HOLE SIZE	BOLT CIRCLE DIA.	DIA. BOLTS	BOLT LENGTH
4	4.00	9.00	0.94	0.50	8	0.75	7.50	0.63	3.00
6	5.00	11.00	1.00	0.56	8	0.88	9.50	0.75	3.25
8	5.50	13.50	1.12	0.62	8	0.88	11.75	0.75	3.50
12	7.50	19.00	1.25	0.81	12	1.00	17.00	0.88	3.75

*Flanged ell made in North America



**CAST IRON FLANGED
TEE CLASS 125**

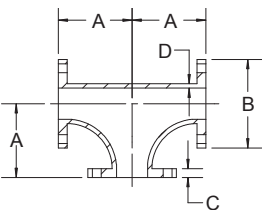

NPS	CENTER TO FACE A	OUTSIDE FLANGE DIA. B	THICKNESS FLANGE C (MIN)	WALL THICKNESS D	NUMBER BOLT HOLES	BOLT HOLE SIZE	BOLT CIRCLE DIA.	DIA. BOLTS	BOLT LENGTH
2	4.50	6.00	0.62	0.31	4	0.75	4.75	0.63	2.25
2-1/2	5.00	7.00	0.69	0.31	4	0.75	5.50	0.63	2.50
3	5.50	7.50	0.75	0.38	4	0.75	6.00	0.63	2.50
4	6.50	9.00	0.94	0.50	8	0.75	7.50	0.63	3.00
5	7.50	10.00	0.94	0.50	8	0.88	8.50	0.75	3.00
6	8.00	11.00	1.00	0.56	8	0.88	9.50	0.75	3.25
8	9.00	13.50	1.12	0.62	8	0.88	11.75	0.75	3.50
10	11.00	16.00	1.19	0.75	12	1.00	14.25	0.88	3.75
12	12.00	19.00	1.25	0.81	12	1.00	17.00	0.88	3.75

*Flanged tee made in North America



**CAST IRON FLANGED
REDUCING TEE
CLASS 125**

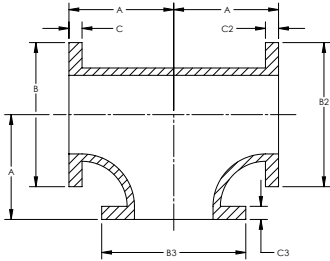

NPS	CENTER TO FACE A	OUTSIDE FLANGE DIA. B	OUTSIDE FLANGE DIA. B2	OUTSIDE FLANGE DIA. B3	THICKNESS FLANGE C (MIN)	THICKNESS FLANGE C2 (MIN)	THICKNESS FLANGE C3 (MIN)
3 x 3 x 2-1/2	5.50	7.50	7.50	7.00	0.75	0.75	0.69
3 x 3 x 2	5.50	7.50	7.50	6.00	0.75	0.75	0.62
4 x 4 x 2	6.50	9.00	9.00	6.00	0.94	0.94	0.62
4 x 4 x 2-1/2	6.50	9.00	9.00	7.00	0.94	0.94	0.69
4 x 4 x 3	6.50	9.00	9.00	7.00	0.94	0.94	0.75
4 x 3 x 4	6.50	9.00	7.50	9.00	0.94	0.75	0.94
4 x 4 x 6	8.00	9.00	9.00	11.00	0.94	0.94	1.00
6 x 4 x 3	8.00	11.00	9.00	7.00	1.00	0.94	0.75
6 x 4 x 4	8.00	11.00	9.00	9.00	1.00	0.94	0.94
6 x 4 x 6	8.00	11.00	9.00	11.00	1.00	0.94	1.00
6 x 6 x 2	8.00	11.00	11.00	6.00	1.00	1.00	0.62
6 x 6 x 2-1/2	8.00	11.00	11.00	7.00	1.00	1.00	0.69
6 x 6 x 3	8.00	11.00	11.00	7.50	1.00	1.00	0.75
6 x 6 x 4	8.00	11.00	11.00	9.00	1.00	1.00	0.94
6 x 6 x 8	9.00	11.00	11.00	13.50	1.00	1.00	1.12
8 x 4 x 8	9.00	13.50	9.00	13.50	1.12	0.94	1.12
8 x 6 x 4	9.00	13.50	11.00	9.00	1.12	1.00	0.94
8 x 6 x 6	9.00	13.50	11.00	11.00	1.12	1.00	1.00
8 x 6 x 8	9.00	13.50	11.00	13.50	1.12	1.00	1.12
8 x 8 x 4	9.00	13.50	13.50	9.00	1.12	1.12	0.94
8 x 8 x 6	9.00	13.50	13.50	11.00	1.12	1.12	1.00
10 x 8 x 8	11.00	16.00	13.50	13.50	1.19	1.12	1.12
10 x 8 x 10	11.00	16.00	13.50	16.00	1.19	1.12	1.19
10 x 10 x 4	11.00	16.00	16.00	9.00	1.19	1.19	0.94
10 x 10 x 6	11.00	16.00	16.00	11.00	1.19	1.19	1.00
10 x 10 x 8	11.00	16.00	16.00	13.50	1.19	1.19	1.12
10 x 10 x 12	12.00	16.00	16.00	19.00	1.19	1.19	1.25
12 x 10 x 10	12.00	19.00	16.00	16.00	1.25	1.19	1.19
12 x 12 x 4	12.00	19.00	19.00	9.00	1.25	1.25	0.94
12 x 12 x 6	12.00	19.00	19.00	11.00	1.25	1.25	1.00
12 x 12 x 8	12.00	19.00	19.00	13.50	1.25	1.25	1.12
12 x 12 x 10	12.00	19.00	19.00	16.00	1.25	1.25	1.19

*Flanged reducing tee made in North America

CLASS 125 CAST IRON
PIPE FITTINGS

CLASS 250 CAST IRON
PIPE FITTINGS

FLANGES

DRAINAGE FITTINGS



CAST IRON FLANGED CONCENTRIC REDUCING COUPLING CLASS 125

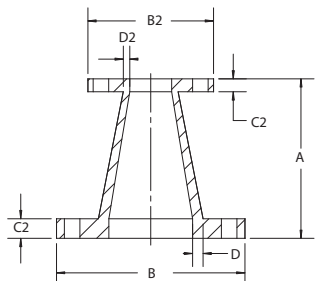

NPS	CENTER TO FACE A	OUTSIDE FLANGE DIA. B	OUTSIDE FLANGE DIA. B2	THICKNESS FLANGE C (MIN)	THICKNESS FLANGE C2 (MIN)	WALL THICKNESS D	WALL THICKNESS D2
2-1/2 x 2	5.50	7.00	6.00	0.69	0.62	0.31	0.31
3 x 2	6.00	7.50	6.00	0.75	0.62	0.38	0.31
3 x 2-1/2	6.00	7.50	7.00	0.75	0.69	0.38	0.31
4 x 2	7.00	9.00	6.00	0.94	0.62	0.50	0.31
4 x 2-1/2	7.00	9.00	7.00	0.94	0.69	0.50	0.31
4 x 3	7.00	9.00	7.50	0.94	0.75	0.50	0.38
5 x 3	8.00	10.00	7.50	0.94	0.75	0.50	0.38
5 x 4	8.00	10.00	9.00	0.94	0.94	0.50	0.50
6 x 2	9.00	11.00	6.00	1.00	0.62	0.56	0.31
6 x 2-1/2	9.00	11.00	7.00	1.00	0.69	0.56	0.31
6 x 3	9.00	11.00	7.50	1.00	0.75	0.56	0.38
6 x 4	9.00	11.00	9.00	1.00	0.94	0.56	0.50
6 x 5	9.00	11.00	10.00	1.00	0.94	0.56	0.50
8 x 3	11.00	13.50	7.50	1.12	0.75	0.62	0.38
8 x 4	11.00	13.50	9.00	1.12	0.94	0.62	0.50
8 x 5	11.00	13.50	10.00	1.12	0.94	0.62	0.50
8 x 6	11.00	13.50	11.00	1.12	1.00	0.62	0.56
10 x 6	12.00	16.00	11.00	1.19	1.00	0.75	0.56
10 x 8	12.00	16.00	13.50	1.19	1.12	0.75	0.62
12 x 6	12.00	19.00	11.00	1.25	1.00	0.81	0.56
12 x 8	12.00	19.00	13.50	1.25	1.12	0.81	0.62
12 x 10	12.00	19.00	16.00	1.25	1.19	0.81	0.75

*Flanged concentric reducing coupling made in North America



CAST IRON FLANGED ECCENTRIC REDUCING COUPLING CLASS 125

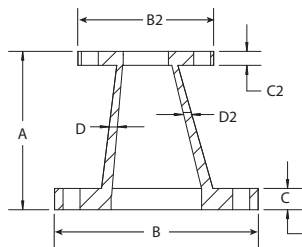

NPS	CENTER TO FACE A	OUTSIDE FLANGE DIA. B	OUTSIDE FLANGE DIA. B2	THICKNESS FLANGE C (MIN)	THICKNESS FLANGE C2 (MIN)	WALL THICKNESS D	WALL THICKNESS D2
3 x 2	6.00	7.50	6.00	0.75	0.62	0.38	0.31
3 x 2-1/2	6.00	7.50	7.00	0.75	0.69	0.38	0.31
4 x 2	7.00	9.00	6.00	0.94	0.62	0.50	0.31
4 x 2-1/2	7.00	9.00	7.00	0.94	0.69	0.50	0.31
4 x 3	7.00	9.00	7.50	0.94	0.75	0.50	0.38
6 x 3	9.00	11.00	7.50	1.00	0.75	0.56	0.38
6 x 4	9.00	11.00	9.00	1.00	0.94	0.56	0.50
6 x 5	9.00	11.00	10.00	1.00	0.94	0.56	0.50
8 x 4	11.00	13.50	9.00	1.12	0.94	0.62	0.50
8 x 5	11.00	13.50	10.00	1.12	0.94	0.62	0.50
8 x 6	11.00	13.50	11.00	1.12	1.00	0.62	0.56
10 x 6	12.00	16.00	11.00	1.19	1.00	0.75	0.56
10 x 8	12.00	16.00	13.50	1.19	1.12	0.75	0.62
12 x 6	12.00	19.00	11.00	1.25	1.00	0.81	0.56
12 x 8	14.00	19.00	13.50	1.25	1.12	0.81	0.62
12 x 10	14.00	19.00	16.00	1.25	1.19	0.81	0.75

*Flanged eccentric reducing coupling made in North America



CAST IRON FLANGED 45° LATERAL CLASS 125

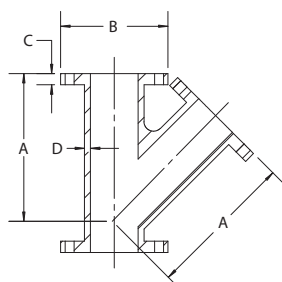

NPS	CENTER TO FACE A	OUTSIDE FLANGE DIA. B	THICKNESS FLANGE C (MIN)	WALL THICKNESS D	NUMBER BOLT HOLES	BOLT HOLE SIZE	BOLT CIRCLE DIA.	DIA. BOLTS	BOLT LENGTH
2-1/2	9.50	7.00	0.69	0.31	4	0.75	5.50	0.63	2.50
3	10.00	7.50	0.75	0.38	4	0.75	6.00	0.63	2.50
4	12.00	9.00	0.94	0.50	8	0.75	7.50	0.63	3.00
6	14.50	11.00	1.00	0.56	8	0.88	9.50	0.75	3.25
8	17.50	13.50	1.12	0.62	8	0.88	11.75	0.75	3.50
10	11.00	16.00	1.19	0.75	12	1.00	14.25	0.63	3.75
12	12.00	19.00	1.25	0.81	12	1.00	17.00	0.63	3.75

*Flanged lateral made in North America



**CAST IRON FLANGED
CROSS CLASS 125**

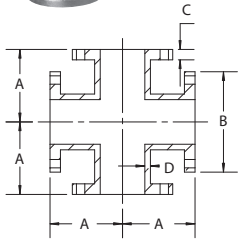

NPS	CENTER TO FACE A	OUTSIDE FLANGE DIA. B	THICKNESS FLANGE C (MIN)	WALL THICKNESS D	NUMBER BOLT HOLES	BOLT HOLE SIZE	BOLT CIRCLE DIA.	DIA. BOLTS	BOLT LENGTH
2	4.50	6.00	0.62	0.31	4	0.75	4.75	0.63	2.25
2-1/2	5.00	7.00	0.69	0.31	4	0.75	5.50	0.63	2.50
3	5.50	7.50	0.75	0.38	4	0.75	6.00	0.63	2.50
4	6.50	9.00	0.94	0.50	8	0.75	7.50	0.63	3.00
6	8.00	11.00	1.00	0.56	8	0.88	9.50	0.75	3.25
8	9.00	13.50	1.12	0.62	8	0.88	11.75	0.75	3.50
10	11.00	16.00	1.19	0.75	12	1.00	14.25	0.88	3.75
12	12.00	19.00	1.25	0.81	12	1.00	17.00	0.88	3.75

*Flanged cross made in North America



**CAST IRON FLANGED
REDUCING CROSS
CLASS 125**

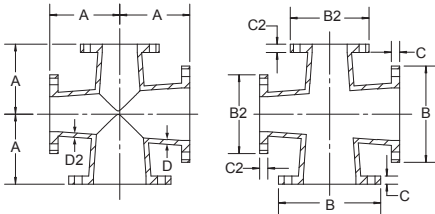

NPS	CENTER TO FACE A	OUTSIDE FLANGE DIA. B	OUTSIDE FLANGE DIA. B2	THICKNESS FLANGE C (MIN)	THICKNESS FLANGE C2 (MIN)	WALL THICKNESS D	WALL THICKNESS D2
6 x 4	8.00	11.00	9.00	1.00	0.94	0.56	0.50
8 x 6	9.00	13.50	11.00	1.12	1.00	0.62	0.56

*Flanged reducing cross made in North America



**CAST IRON FLANGED
BASE 90° ELL
CLASS 125**

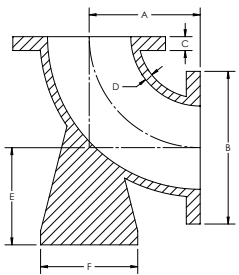

NPS	CENTER TO FACE A	OUTSIDE FLANGE DIA. B	THICKNESS FLANGE C (MIN)	WALL THICKNESS D	HEIGHT BASE E	ROUND & SQUARE BASE F	NUMBER BOLT HOLES	BOLT HOLE SIZE	BOLT CIRCLE DIA.	DIA. BOLTS	BOLT LENGTH
4	6.50	9.00	0.94	0.50	5.50	6.00	8	0.75	7.50	0.63	3.00
6	8.00	11.00	1.00	0.56	7.00	7.00	8	0.88	9.50	0.75	3.25
8	9.00	13.50	1.12	0.62	8.38	9.00	8	0.88	11.75	0.75	3.50
10	11.00	16.00	1.19	0.75	9.75	9.00	12	1.00	14.25	0.88	3.75
12	12.00	19.00	1.25	0.81	11.25	11.00	12	1.00	17.00	0.88	3.75

*Flanged standard base ell made in North America



**CAST IRON
FLANGED BASE
TEES CLASS 125**

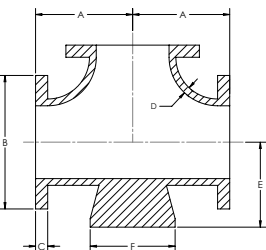

NPS	CENTER TO FACE A	OUTSIDE FLANGE DIA. B	THICKNESS FLANGE C (MIN)	WALL THICKNESS D	HEIGHT BASE E	ROUND & SQUARE BASE F	NUMBER BOLT HOLES	BOLT HOLE SIZE	BOLT CIRCLE DIA.	DIA. BOLTS	BOLT LENGTH
3	5.50	7.50	0.75	0.38	4.88	5.00	4	0.75	6.00	0.63	2.50
4	6.50	9.00	0.94	0.50	5.50	6.00	8	0.75	7.50	0.63	3.00
5	7.50	10.00	0.94	0.50	7.00	7.00	8	0.88	8.50	0.75	3.00
6	8.00	11.00	1.00	0.56	7.00	7.00	8	0.88	9.50	0.75	3.25
8	9.00	13.50	1.12	0.62	8.38	9.00	8	0.88	11.75	0.75	3.50
10	11.00	16.00	1.19	0.75	9.75	9.00	12	1.00	14.25	0.88	3.75
12	12.00	19.00	1.25	0.81	11.25	11.00	12	1.00	17.00	0.88	3.75

*Flanged standard base tee made in North America

**CLASS 125 CAST IRON
PIPE FITTINGS**



**CAST IRON DRAINAGE
45° ELL SHORT TURN**

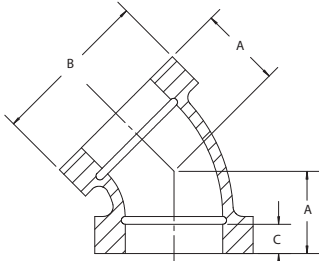

NPS	CENTER TO END A	OUTSIDE DIA. BAND B (MIN)	LENGTH THREADS C (MIN)	TAKE OUT
1-1/4	1.31	2.39	0.42	0.60
1-1/2	1.44	2.68	0.42	0.71
2	1.69	3.28	0.44	0.93
3	2.19	4.62	0.77	0.99
4	2.63	5.79	0.84	1.33

**CLASS 250 CAST IRON
PIPE FITTINGS**



**CAST IRON DRAINAGE
45° ELL LONG TURN**

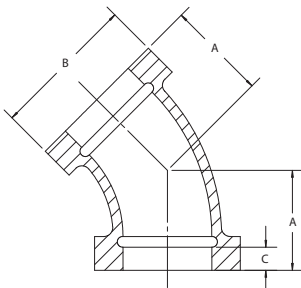

NPS	CENTER TO END A	OUTSIDE DIA. BAND B (MIN)	LENGTH THREADS C (MIN)	TAKE OUT
1-1/2	1.88	2.68	0.42	1.16
2	2.25	3.28	0.44	1.49

FLANGES



**CAST IRON DRAINAGE
90° ELL SHORT TURN**

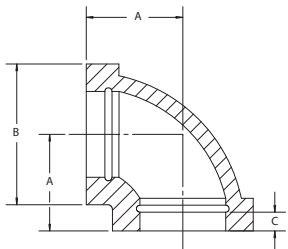

NPS	CENTER TO END A	OUTSIDE DIA. BAND B (MIN)	LENGTH THREADS C (MIN)	TAKE OUT
1-1/2	1.94	2.68	0.42	1.21
2	2.25	3.28	0.44	1.49
3	3.06	4.62	0.77	1.86
4	3.81	5.79	0.84	2.51
2 x 1-1/2	2.25	3.28	0.44	1.49



**CAST IRON DRAINAGE
90° ELL LONG TURN**

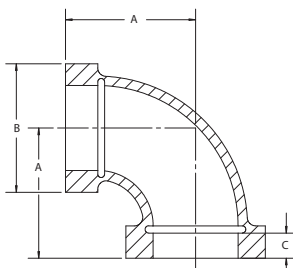

NPS	CENTER TO END A	OUTSIDE DIA. BAND B (MIN)	LENGTH THREADS C (MIN)	TAKE OUT
1-1/2	2.50	2.68	0.42	1.77
2	3.06	3.28	0.44	2.30
3	4.25	4.62	0.77	3.00

DRAINAGE FITTINGS



**CAST IRON DRAINAGE
90° ELL EXTRA LONG
TURN**

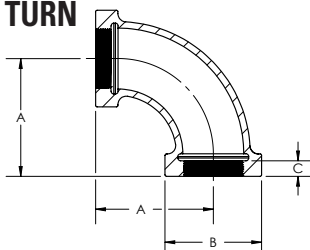

NPS	CENTER TO END A	OUTSIDE DIA. BAND B (MIN)	LENGTH THREADS C (MIN)	TAKE OUT
1-1/2	3.50	2.68	0.42	2.77
2	4.00	3.28	0.44	3.24



**CAST IRON
DRAINAGE 90°
STREET ELL**

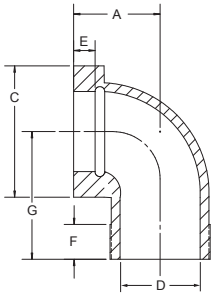

NPS	CENTER TO END A	CENTER TO MALE G	OUTSIDE DIA. BAND C (MIN)	PORT DIA. MALE END D (MAX)	LENGTH INTERNAL THREADS E (MIN)	LENGTH EXTERNAL THREADS F (MIN)	TAKE OUT MALE END	TAKE OUT FEMALE END
1-1/2	1.98	2.86	2.68	1.61	0.42	0.85	2.13	1.25
2	2.16	3.19	3.28	2.07	0.44	0.87	2.43	1.40



**CAST IRON
DRAINAGE 45°
STREET ELL**

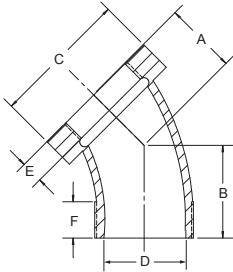

NPS	CENTER TO END A	CENTER TO MALE B	OUTSIDE DIA. BAND C (MIN)	PORT DIA. MALE END D (MAX)	LENGTH INTERNAL THREADS E (MIN)	LENGTH EXTERNAL THREADS F (MIN)	TAKE OUT MALE END	TAKE OUT FEMALE END
1-1/2	1.50	1.87	2.68	1.35	0.42	0.85	1.15	0.77
2	1.65	2.30	3.28	1.75	0.44	0.87	1.54	0.89



**CAST IRON
DRAINAGE
60° ELL SHORT
TURN**

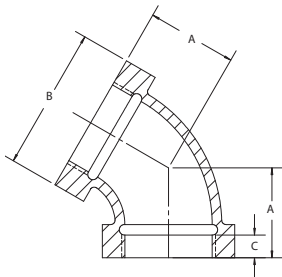

NPS	CENTER TO END A	OUTSIDE DIA. BAND B (MIN)	LENGTH THREADS C (MIN)	TAKE OUT
1-1/2	1.75	2.68	0.42	1.02
2	2.06	3.28	0.44	1.30



**CAST IRON
DRAINAGE
TEE**

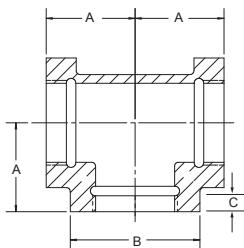

NPS	CENTER TO END A	OUTSIDE DIA. BAND B (MIN)	LENGTH THREADS C (MIN)	TAKE OUT
1-1/2	1.94	2.68	0.42	1.21
2	2.25	3.28	0.44	1.49
2 x 1-1/2	2.25	3.28	0.44	1.49

**CLASS 125 CAST IRON
PIPE FITTINGS**



**CAST IRON
DRAINAGE 90°
"TY" SHORT
TURN**

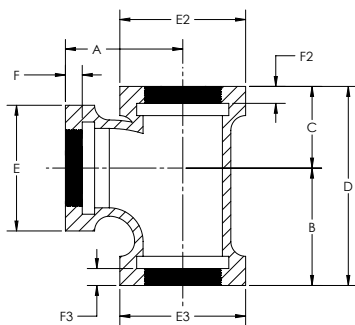

NPS	CENTER TO END INLET A	CENTER TO END OUTLET B	CENTER TO END C	END TO END D	OUTSIDE DIA. BAND E (MIN)	OUTSIDE DIA. BAND E2 (MIN)	OUTSIDE DIA. BAND E3 (MIN)	LENGTH THREADS F (MIN)	LENGTH THREADS F2 (MIN)	LENGTH THREADS F3 (MIN)	TAKE OUT	TAKE OUT
1-1/2	2.50	2.50	1.75	4.25	2.68	2.68	2.68	0.42	0.42	0.42	1.78	1.78
2	3.06	3.06	2.13	5.19	3.28	3.28	3.28	0.44	0.44	0.44	2.30	2.30
4	5.19	5.19	3.56	8.75	5.79	5.79	5.79	0.84	0.84	0.84	3.89	3.89
2 x 1-1/2	2.94	2.69	1.94	4.63	3.28	3.28	2.68	0.44	0.44	0.42	2.18	1.93
2 x 1-1/2 x 1-1/2	2.94	2.69	1.94	4.63	3.28	2.68	2.68	0.44	0.42	0.42	2.18	1.93
2 x 1-1/2 x 2	3.06	3.06	2.13	5.19	3.28	2.68	3.28	0.44	0.42	0.44	2.30	2.30

**CLASS 250 CAST IRON
PIPE FITTINGS**



**CAST IRON
DRAINAGE
22-1/2° ELLS
SHORT TURN**

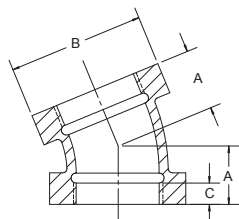

NPS	CENTER TO END A	OUTSIDE DIA. BAND B (MIN)	LENGTH THREADS C	TAKE OUT
1-1/2	1.25	2.68	0.42	0.52
2	1.44	3.28	0.44	0.68

FLANGES



**CAST IRON
DRAINAGE
11-1/4° ELLS
SHORT TURN**

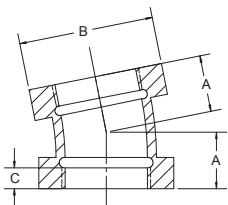

NPS	CENTER TO END A	OUTSIDE DIA. BAND B (MIN)	LENGTH THREADS C	TAKE OUT
1-1/2	1.25	2.68	0.42	0.52

DRAINAGE FITTINGS



**CAST IRON
DRAINAGE 90°
"TY" LONG
TURN**

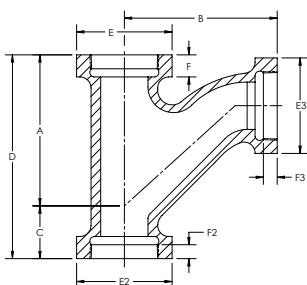

NPS	CENTER TO END INLET A	CENTER TO END OUTLET B	CENTER TO END C	END TO END D	OUTSIDE DIA. BAND E (MIN)	OUTSIDE DIA. BAND E2 (MIN)	OUTSIDE DIA. BAND E3 (MIN)	LENGTH THREADS F (MIN)	LENGTH THREADS F2 (MIN)	LENGTH THREADS F3 (MIN)	TAKE OUT	TAKE OUT
1-1/2	4.13	4.13	1.25	5.38	2.68	2.68	2.68	0.42	0.42	0.42	3.40	3.41
2	5.25	5.25	1.75	7.00	3.28	3.28	3.28	0.44	0.44	0.44	4.49	4.49
2 x 1-1/2	4.38	4.44	1.31	5.75	3.28	3.28	2.68	0.44	0.44	0.42	3.62	3.68
2 x 1-1/2 x 1-1/2	4.38	4.44	1.31	5.75	3.28	2.68	2.68	0.44	0.42	0.42	3.62	3.68
2 x 1-1/2 x 2	5.25	5.25	1.75	7.00	3.28	2.68	3.28	0.44	0.42	0.44	4.49	4.49



**CAST IRON
DRAINAGE 45°
"Y" SHORT
TURN**

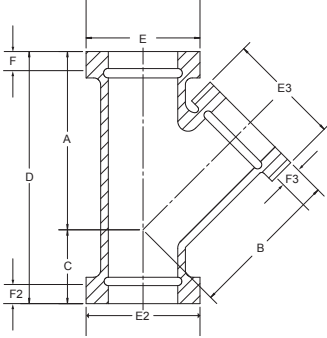

NPS	CENTER TO END INLET A	CENTER TO END OUTLET B	CENTER TO END C	END TO END D	OUTSIDE DIA. BAND E (MIN)	OUTSIDE DIA. BAND E2 (MIN)	OUTSIDE DIA. BAND E3 (MIN)	LENGTH THREADS F (MIN)	LENGTH THREADS F2 (MIN)	LENGTH THREADS F3 (MIN)	TAKE OUT	TAKE OUT
1-1/2	3.63	3.63	1.88	5.50	2.68	2.68	2.68	0.42	0.42	0.42	2.91	2.91
2	4.38	4.38	2.13	6.50	3.28	3.28	3.28	0.44	0.44	0.44	3.62	3.62
3	6.19	6.19	2.81	9.00	4.62	4.62	4.62	0.77	0.77	0.77	4.99	4.99
4	7.69	7.69	3.19	10.88	5.79	5.79	5.79	0.84	0.84	0.84	6.39	6.39
2 x 1-1/2 x 1-1/2	4.06	4.13	1.81	5.88	3.28	2.68	2.68	0.44	0.42	0.42	3.37	3.30
2 x 1-1/2 x 2	4.38	4.38	2.13	6.50	3.28	2.68	3.28	0.44	0.42	0.44	3.62	3.62
2 x 1-1/2	4.06	4.13	1.81	5.88	3.28	3.28	2.68	0.44	0.44	0.42	3.37	3.30
4 x 3	6.88	7.19	2.38	9.25	5.79	5.79	4.62	0.84	0.84	0.77	5.89	5.58



**CAST IRON
DRAINAGE 90°
DOUBLE "TY"
SHORT TURN**

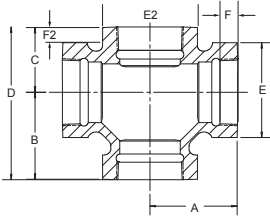

NPS	CENTER TO END INLET A	CENTER TO END OUTLET B	CENTER TO END C	END TO END D	OUTSIDE DIA. BAND E (MIN)	OUTSIDE DIA. BAND E2 (MIN)	LENGTH THREADS F (MIN)	LENGTH THREADS F2 (MIN)
1-1/2	2.50	2.50	1.75	4.25	2.68	2.68	0.42	0.42
2	3.06	3.06	2.13	5.19	3.28	3.28	0.44	0.44
2 x 1-1/2	2.90	2.69	1.94	4.63	3.28	2.68	0.44	0.42



**CAST IRON
DRAINAGE P
TRAP WITH
CLEANOUT**

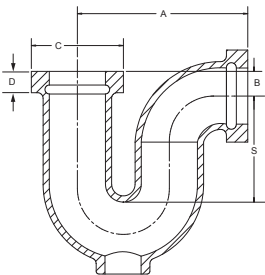

NPS	CENTER TO CENTER A	CENTER TO END B	OUTSIDE DIA. BAND C (MIN)	LENGTH THREADS D (MIN)	WATER SEAL S (MIN)
1-1/2	4.38	0.88	2.68	0.42	2.00
2	5.31	0.88	3.28	0.44	2.00



**CAST IRON
DRAINAGE P
TRAP WITHOUT
CLEANOUT**

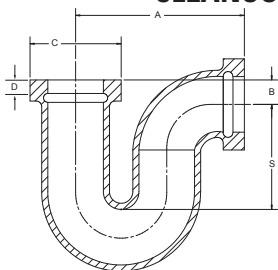

NPS	CENTER TO CENTER A	CENTER TO END B	OUTSIDE DIA. BAND C (MIN)	LENGTH THREADS D (MIN)	WATER SEAL S (MIN)
*1-1/2	4.38	0.25	2.68	0.42	2.00
*2	5.31	0	3.28	0.44	2.00

*Manufactured to Ward specifications

SECTION 3

CAPS, PLUGS, AND BUSHINGS



Ward Manufacturing ("Ward") Caps are produced in Class 150 malleable iron, and are manufactured to ASME B16.3 specifications.

Ward Plugs and Bushings are produced in both malleable and cast iron grades. All bushings and plugs produced by Ward are manufactured to ASME B16.14 specifications, and threaded to ASME B1.20.1 standards. Hex bushings and cored plugs can be used for Class 125 and Class 150 systems, while face bushings and solid plugs should be installed on Class 250 or Class 300 systems.

CAPS, PLUGS, AND BUSHINGS SPECIFICATIONS

Material:	ASTM A197 for malleable iron, ASTM A126 Class A Minimum for cast iron
Dimensions:	ASME B16.3 (Caps), ASME B16.14 (Plugs and Bushings)
Threading:	ASME B1.20.1
Pressure Ratings:	ASME B16.3 for malleable iron, ASME B16.4 for cast iron
Coatings:	ASTM A153, ASTM B633
Additional Specifications:	UL, ULC, FM, NSF 61 and NSF 372 where applicable



MALLEABLE IRON PIPE CAPS CLASS 150

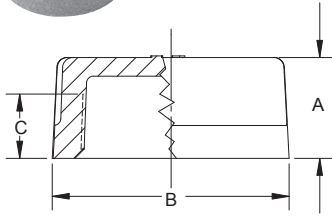

NPS	OVERALL HEIGHT A (MIN)	OUTSIDE DIA. BAND B (MIN)	LENGTH THREADS C (MIN)
*1/8	0.53	0.56	0.25
+1/4	0.63	0.84	0.32
+3/8	0.74	1.01	0.36
+1/2	0.87	1.20	0.43
+3/4	0.97	1.46	0.50
1	1.16	1.77	0.58
1-1/4	1.28	2.15	0.67
1-1/2	1.33	2.43	0.70
2	1.45	3.00	0.75
2-1/2	1.70	3.59	0.92
3	1.80	4.28	0.98
3-1/2	1.90	4.84	1.03
4	2.08	5.4	1.08
5	2.32	6.58	1.18
6	2.55	7.77	1.28

+Made in Malleable Iron and Steel
*Made in Steel



MALLEABLE IRON STEEL HEX CAPS CLASS 150

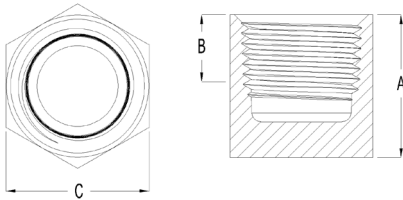

NPS	OVERALL HEIGHT A (MIN)	LENGTH THREADS B (MIN)	HEX WIDTH C (MIN)
1/8	0.55	0.25	0.55
1/4	0.67	0.32	0.68
3/8	0.80	0.36	0.80
1/2	0.99	0.43	0.99
3/4	1.11	0.50	1.18



CAST IRON SOLID PLUGS CLASS 125

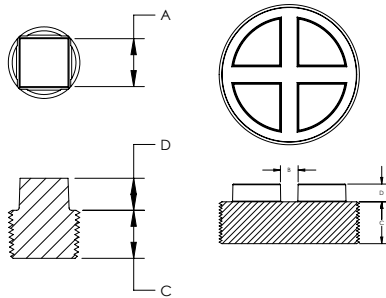

NPS	WIDTH ACROSS FLATS A	DISTANCE BETWEEN LUGS B (MIN)	LENGTH THREADS C (MIN)	HEIGHT SQUARE D (MIN)
*1/8	0.28	—	0.37	0.24
*1/4	0.38	—	0.44	0.28
*3/8	0.44	—	0.48	0.31
**1/2	0.38	—	0.56	0.38
**3/4	0.63	—	0.63	0.44
1	0.81	—	0.75	0.50
1-1/4	0.94	—	0.80	0.56
1-1/2	1.13	—	0.83	0.62
2	1.31	—	0.88	0.68
2-1/2	1.50	—	1.07	0.74
3	1.69	—	1.13	0.80
+4	—	0.88	1.22	1.00
+5	—	0.88	1.31	1.00

*Made in Steel.
**Made from Cast Iron or Steel. Specify your preference when ordering.
+Bar Head



CAST IRON CORED PLUGS CLASS 125

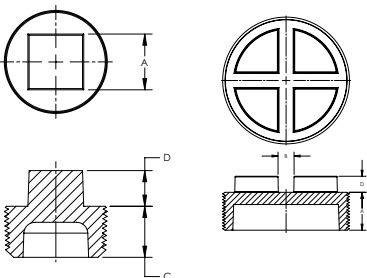

NPS	WIDTH ACROSS FLATS A	DISTANCE BETWEEN LUGS B (MIN)	LENGTH THREADS C (MIN)	HEIGHT SQUARE D (MIN)
1/2	0.56	—	0.56	0.28
3/4	0.63	—	0.63	0.44
1	0.81	—	0.75	0.50
1-1/4	0.94	—	0.80	0.56
1-1/2	1.13	—	0.83	0.62
2	1.31	—	0.88	0.68
2-1/2	1.50	—	1.07	0.74
3	1.69	—	1.13	0.80
3-1/2	1.88	—	1.18	0.86
4 SQUARE	2.06	—	1.22	0.92
+4	—	0.88	1.22	1.00
+5	—	0.88	1.31	1.00
+6	—	1.25	1.40	1.25

+Bar Head



**CAST IRON
COUNTERSUNK PLUGS
CLASS 125 & 150**

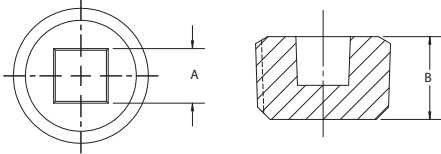

NPS	SQUARE A	LENGTH THREADS B (MIN)
+1/4	0.25	0.44
+3/8	0.31	0.48
*1/2	0.38	0.56
*3/4	0.50	0.63
*1	0.50	0.75
1-1/4	0.75	0.80
1-1/2	0.75	0.83
2	0.88	0.88
2-1/2	1.13	1.07
3	1.38	1.13
4	2.00	1.22

+Steel
*Made from Malleable Iron



**CAST IRON HEX HEAD
CLEANOUT PLUGS
CLASS 125**

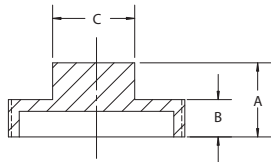

NPS	OVERALL HEIGHT A	LENGTH THREADS B (MIN)	WIDTH ACROSS FLATS C
1-1/4	1.03	0.53	1.01
4	1.40	0.77	1.54

*Manufactured to Ward specifications



**CAST IRON HEXAGON
BUSHINGS CLASS 125**

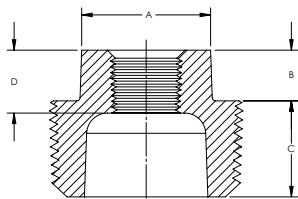
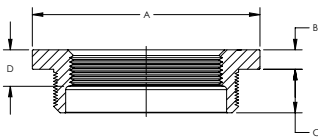

NPS	WIDTH HEAD A	HEIGHT HEAD B	LENGTH EXTERNAL THREADS C (MIN)	LENGTH INTERNAL THREADS D (MIN)	INSIDE OR OUTSIDE HEAD
*1-1/4 x 1/8	1.12	0.34	0.80	0.32	Inside
1-1/4 x 1/4	1.12	0.34	0.80	0.32	Inside
1-1/4 x 3/8	1.12	0.34	0.80	0.36	Inside
1-1/4 x 1/2	1.34	0.34	0.80	0.43	Inside
1-1/4 x 3/4	1.76	0.28	0.80	0.50	Outside
*1-1/2 x 1/8	1.12	0.37	0.83	0.32	Inside
1-1/2 x 1/4	1.12	0.37	0.83	0.32	Inside
1-1/2 x 3/8	1.12	0.37	0.83	0.36	Inside
1-1/2 x 1/2	1.34	0.37	0.83	0.43	Inside
1-1/2 x 3/4	1.63	0.37	0.83	0.50	Inside
1-1/2 x 1	2.00	0.31	0.83	0.58	Outside
2 x 1-1/4	2.48	0.34	0.88	0.67	Outside
2 x 1/4	1.12	0.41	0.88	0.32	Inside
2 x 3/8	1.12	0.41	0.88	0.36	Inside
2 x 1/2	1.34	0.41	0.88	0.43	Inside
2 x 3/4	1.63	0.41	0.88	0.50	Inside
2 x 1	1.95	0.41	0.88	0.58	Inside
2-1/2 x 1/2	1.34	0.44	1.07	0.43	Inside
2-1/2 x 3/4	1.63	0.44	1.07	0.50	Inside
2-1/2 x 1	1.95	0.44	1.07	0.58	Inside
2-1/2 x 1-1/4	2.39	0.44	1.07	0.67	Inside
2-1/2 x 1-1/2	2.68	0.44	1.07	0.70	Outside
*3 x 1/4	2.68	0.48	1.13	0.32	Inside
3 x 1/2	1.34	0.49	1.13	0.43	Inside
3 x 3/4	1.63	0.48	1.13	0.50	Inside
3 x 1	1.95	0.48	1.13	0.58	Inside
3 x 1-1/4	2.39	0.48	1.13	0.67	Inside
3 x 1-1/2	2.68	0.48	1.13	0.70	Inside
3 x 2	3.28	0.48	1.13	0.75	Outside
3 x 2-1/2	3.86	0.40	1.13	0.92	Outside
*3-1/2 x 3/4	1.95	0.52	1.18	0.50	Inside
3-1/2 x 1	1.95	0.52	1.18	0.58	Inside
3-1/2 x 1-1/4	2.39	0.52	1.18	0.67	Inside
3-1/2 x 1-1/2	3.28	0.52	1.18	0.70	Inside
3-1/2 x 2	3.28	0.52	1.18	0.75	Inside

*Manufactured to Ward specifications



CAST IRON HEXAGON BUSHINGS CLASS 125, Continued

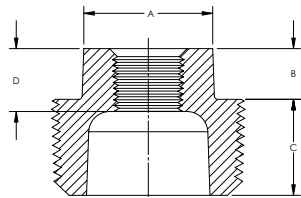
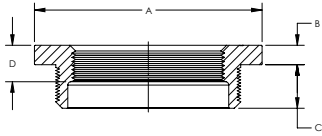

MALLEABLE IRON HEXAGON BUSHINGS CLASS 150

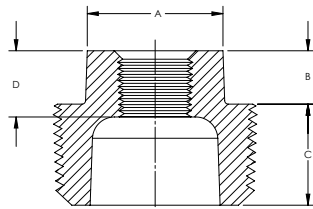
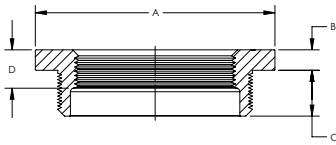

CAST IRON FLUSH BUSHINGS CLASS 125

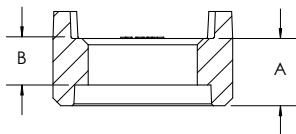

NPS	WIDTH HEAD A	HEIGHT HEAD B	LENGTH EXTERNAL THREADS C (MIN)	LENGTH INTERNAL THREADS D (MIN)	INSIDE OR OUTSIDE HEAD
3-1/2 x 2-1/2	3.86	0.52	1.18	0.92	Outside
*4 x 1/2	1.95	0.60	1.22	0.50	Inside
4 x 1	1.95	0.60	1.22	0.58	Inside
4 x 1-1/4	2.39	0.60	1.22	0.67	Inside
4 x 1-1/2	2.68	0.60	1.22	0.70	Inside
4 x 2	3.28	0.60	1.22	0.75	Inside
4 x 2-1/2	3.86	0.60	1.22	0.92	Inside
4 x 3	4.62	0.50	1.22	0.98	Outside
5 x 2	3.28	0.60	1.36	0.75	Inside
5 x 2-1/2	3.86	0.60	1.31	0.92	Inside
5 x 3	4.62	0.60	1.31	0.98	Inside
5 x 4	5.79	0.50	1.31	1.08	Outside
6 x 2	3.28	0.75	1.40	0.75	Inside
6 x 2-1/2	3.86	0.75	1.40	0.92	Inside
6 x 3	4.62	0.75	1.40	0.98	Inside
6 x 4	5.79	0.75	1.40	1.08	Inside
6 x 5	7.05	0.63	1.40	1.18	Outside
8 x 4	5.79	0.83	1.57	1.08	Inside
8 x 6	8.28	0.83	1.57	1.28	Outside

*Manufactured to Ward specifications

NPS	WIDTH HEAD A	HEIGHT HEAD B	LENGTH EXTERNAL THREADS C (MIN)	LENGTH INTERNAL THREADS D (MIN)	INSIDE OR OUTSIDE HEAD
+1/4 x 3/8	0.64	0.14	0.44	0.26	Outside
+3/8 x 1/8	0.68	0.16	0.48	0.25	Outside
*3/8 x 1/4	0.68	0.16	0.48	0.40	Outside
*1/2 x 1/8	0.87	0.19	0.56	0.25	Outside
*1/2 x 1/4	0.87	0.19	0.56	0.32	Outside
*1/2 x 3/8	0.87	0.19	0.56	0.36	Outside
*3/4 x 1/8	1.15	0.22	0.63	0.25	Outside
*3/4 x 1/4	1.15	0.22	0.63	0.32	Outside
*3/4 x 3/8	1.15	0.22	0.63	0.36	Outside
*3/4 x 1/2	1.15	0.22	0.63	0.53	Outside
*1 x 1/8	1.12	0.30	0.75	0.25	Inside
*1 x 1/4	1.12	0.30	0.75	0.32	Inside
*1 x 3/8	1.12	0.30	0.75	0.36	Inside
*1 x 1/2	1.42	0.25	0.75	0.43	Outside
*1 x 3/4	1.42	0.25	0.75	0.50	Outside
1-1/4 x 1	1.76	0.28	0.80	0.58	Outside
1-1/2 x 1-1/4	2.00	0.31	0.83	0.77	Outside
2 x 1-1/2	2.48	0.34	0.88	0.70	Outside
2-1/2 x 2	2.98	0.37	1.07	0.75	Outside
3-1/2 x 3	4.62	0.43	1.18	0.98	Outside
4 x 3-1/2	5.20	0.50	1.22	1.03	Outside

*Available in Malleable Iron or Steel. Specify your preference when ordering.

+Steel

NPS	LENGTH EXTERNAL THREADS A (MIN)	LENGTH INTERNAL THREADS B (MIN)
1-1/4 x 3/4	0.80	0.50
1-1/2 x 1/2	0.83	0.43
1-1/2 x 3/4	0.83	0.50
1-1/2 x 1	0.83	0.58
2 x 1/2	0.88	0.43
2 x 1	0.88	0.58
2-1/2 x 1-1/4	1.07	0.67
3 x 1-1/2	1.13	0.70
3 x 2	1.13	0.75
4 x 2	1.22	0.75
4 x 2-1/2	1.22	0.92
4 x 3	1.22	0.98
5 x 4	1.31	1.08
6 x 4	1.40	1.08
6 x 5	1.40	1.18
8 x 6	1.57	1.28



**MALLEABLE IRON
FLUSH BUSHINGS
CLASS 150**

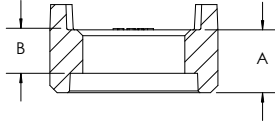

NPS	LENGTH EXTERNAL THREADS A (MIN)	LENGTH INTERNAL THREADS B (MIN)
1 x 1/2	0.75	0.43
1 x 3/4	0.75	0.50
1-1/4 x 1	0.80	0.58
1-1/2 x 1-1/4	0.83	0.77
2 x 1-1/2	0.88	0.70
2-1/2 x 2	1.07	0.75
3 x 2-1/2	1.13	0.92
4 x 3-1/2	1.22	1.03



**STEEL HEX
SOCKET PLUGS**

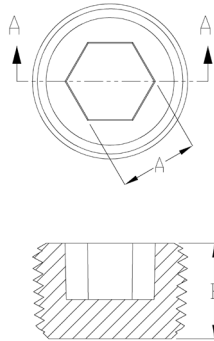

NPS	HEX A	LENGTH THREAD B (MIN)
1/8	0.19	0.37
1/4	0.25	0.44
3/8	0.31	0.48
1/2	0.38	0.56
3/4	0.56	0.63



**CAST IRON DOUBLE
TAP TANK BUSHINGS
(Heavy Type Only)**

NPS	OVERALL HEIGHT A	LENGTH EXTERNAL THREADS B (MIN)	WIDTH HEAD C	INSIDE OR OUTSIDE HEAD
*1 x 1/2 x 1/2	1.57	1.16	1.46	Outside
*1-1/2 x 1 x 1	1.58	1.16	2.02	Outside
*2 x 3/8 x 3/8	1.57	1.16	2.55	Outside
*2 x 1/2 x 1/2	1.57	1.16	2.55	Outside
*2 x 3/4 x 3/4	1.57	1.16	2.55	Outside
*2 x 1 x 1	1.57	1.16	2.55	Outside
*2 x 1-1/4 x 1-1/4	1.77	1.33	2.59	Outside
*2 x 1-1/2 x 1-1/2	1.74	1.33	2.59	Outside
*3 x 1 x 1	2.31	1.72	3.91	Outside
*3 x 2 x 2	2.31	1.72	3.91	Outside
*4 x 1 x 1	2.30	1.55	3.30	Inside
*4 x 1-1/2 x 1-1/2	2.30	1.55	3.30	Inside
*4 x 2 x 2	2.30	1.55	3.30	Inside
*4 x 2-1/2 x 2-1/2	2.30	1.55	3.30	Outside
*4 x 3 x 3	2.30	1.72	4.67	Outside

*Manufactured to Ward specifications

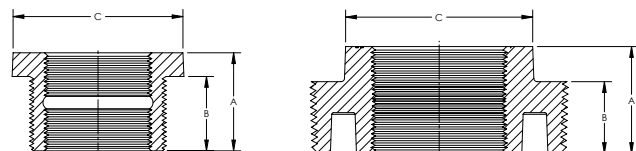

SECTION 4

WARDLOX™

The **WARDLOX™ Sprinkler Connect System** is a fast, safe and effective way to join schedule 10 and 40 plain end pipe without threading or welding. In addition to the performance benefits of threadless sprinkler connect systems, the WARDLOX™ system is 100% factory tested to prevent leaks and recalls. WARDLOX™ has also been thoroughly field tested in a variety of installations and is ideal for new construction and retrofit.

Designed to reduce the number of hands required to install a total fire protection system, WARDLOX™ features:

- Self-locking screws for quick and easy installation.
- Uniform 1/2 inch takeout dimensions for accurate onsite measurement and set screw placement engineered forward of the gasket to eliminate risk of leakage.

WARDLOX™ fittings and set screws are engineered to provide a more positive locking action when the set screw is tightened down to the boss on the fitting. Providing maximum contact in the pipe, the bottom of the set screw is convex and tapered. The 3/8 inch square head set screw can be tightened with the same tool used for affixing beam clamps.

The exclusive nylon “lock patch” on the cadmium-plated set screw prevents screws from loosening after fabrication and installation. The sprinkler system components can be fabricated in the machine shop, and the fittings will not shake loose during transport. Set screws are pre-set at the factory so that field assembly requires only one turn to tighten the head securely against the casting, installation in confined areas fast and easy.

Material Specifications Housing:

- Cast Iron to ASTM A126 Class A minimum.
- Galvanized finish also available for special applications or high corrosion areas.
- Set Screws: Carbon Steel, Cadmium-plated, Self-Locking
- Gaskets: E.P.D.M. to ASTM D-2000 with temperature range of -30 to 230°F
- Threaded Outlets: Conform to ASME B1.20.1 specifications
- Pressure Ratings: 175 psig

WARDLOX™ SPECIFICATIONS

Material:	ASTM A126 Class A Minimum
Threading:	ASME B1.20.1
Pressure Ratings:	175 psig
Coatings:	ASTM A153, ASTM B633
Additional Specifications:	UL, ULC and FM where applicable





**WARDLOX™ 90° ELBOW
(SLIP X SLIP)**

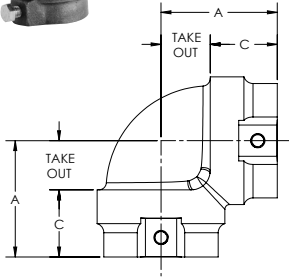

NPS	CENTER TO END A	PIPE ENGAGEMENT	TAKE OUT	SCHEDULE PIPE APPROVED
1	2.37	1.62	0.75	40, 10, XL, DT, D
1-1/4	2.56	1.62	0.94	40, 10, XL, DT, D
1-1/2	2.68	1.62	0.69	40, 10
2	3.06	1.75	0.94	40, 10



**WARDLOX™ ADAPTER
ELBOW (SLIP X
THREAD)**

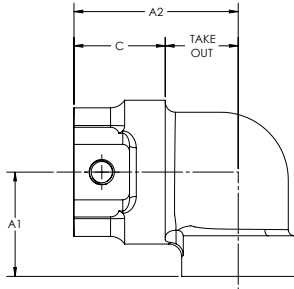

NPS	CENTER TO END A1	CENTER TO END A2	PIPE ENGAGEMENT	TAKE OUT	SCHEDULE PIPE APPROVED
1 x 1/2	1.56	2.44	1.62	0.81	40, 10, XL, DT, DF
1 x 3/4	1.56	2.44	1.62	0.81	40, 10, XL, DT, DF
1 x 1	1.56	2.56	1.62	0.93	40, 10, XL, DT, DF
1-1/4 x 1/2	1.81	2.56	1.62	0.81	40, 10, XL, DT, DF
1-1/4 x 3/4	1.81	2.56	1.62	0.81	40, 10, XL, DT, DF
1-1/4 x 1	1.81	2.56	1.62	0.81	40, 10, XL, DT, DF
1-1/2 x 1/2	1.93	2.56	1.62	0.81	40, 10
1-1/2 x 3/4	1.93	2.56	1.62	0.81	40, 10
1-1/2 x 1	1.93	2.56	1.62	0.81	40, 10
2 x 1/2	2.62	2.69	2.75	0.81	40, 10
2 x 3/4	2.62	2.69	2.75	0.81	40, 10
2 x 1	2.62	2.69	2.75	0.81	40, 10



**WARDLOX™ SLIP TEES
(SLIP X SLIP X SLIP)**

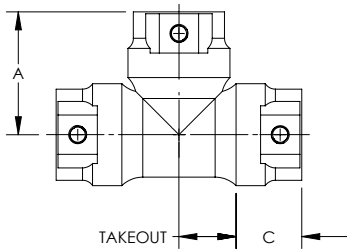

NPS	CENTER TO END A	PIPE ENGAGEMENT C	TAKE OUT	SCHEDULE PIPE APPROVED
1 x 1 x 1	2.56	1.62	0.93	40, 10, XL, DT, DF
1-1/4 x 1-1/4 x 1-1/4	2.75	1.62	1.13	40, 10, XL, DT, DF
1-1/2 x 1-1/2 x 1-1/2	2.87	1.62	1.25	40, 10
2 x 2 x 2	3.22	1.75	1.56	40, 10



**WARDLOX™ REDUCING
SLIP TEES (SLIP X SLIP
X SLIP)**

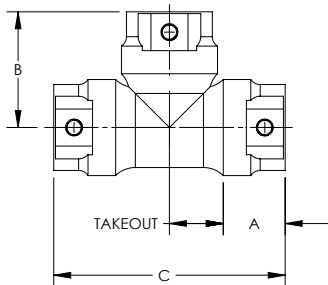

NPS	PIPE ENGAGEMENT A	PIPE ENGAGEMENT A2	CENTER TO OUTLET B	OVERALL LENGTH C	TAKE OUT	TAKE OUT 2	SCHEDULE PIPE APPROVED
2 x 2 x 1	1.79	1.64	3.09	5.38	1.30	1.45	40, 10
2 x 2 x 1-1/4	1.79	1.63	3.13	5.38	1.34	1.50	40, 10
2 x 2 x 1-1/2	1.79	1.63	3.13	5.97	1.34	1.50	40, 10



WARDLOX™ BULLHEAD TEES (SLIP X SLIP X SLIP)

NPS	CENTER TO END A	PIPE ENGAGEMENT C1	CENTER TO OUTLET C2	TAKE OUT 1	TAKE OUT 2	SCHEDULE PIPE APPROVED
1-1/2 x 1-1/2 x 2	3.00	1.62	1.75	1.43	1.12	40, 10

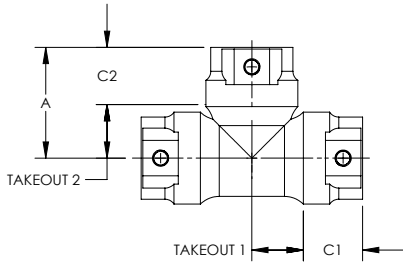

WARDLOX™ OUTLET TEES (SLIP X SLIP X THREAD)

NPS	CENTER TO END A	PIPE ENGAGEMENT	TAKE OUT	SCHEDULE PIPE APPROVED
1 x 1 x 1/2	1.56	1.62	0.50	40, 10, XL, DT, D
1 x 1 x 3/4	1.56	1.62	0.50	40, 10, XL, DT, D
1 x 1 x 1	1.56	1.62	0.50	40, 10, XL, DT, D
1-1/4 x 1-1/4 x 1/2	1.84	1.62	0.50	40, 10, XL, DT, D
1-1/4 x 1-1/4 x 3/4	1.84	1.62	0.50	40, 10, XL, DT, D
1-1/4 x 1-1/4 x 1	1.84	1.62	0.50	40, 10, XL, DT, D
1-1/2 x 1-1/2 x 1/2	1.96	1.62	0.50	40, 10
1-1/2 x 1-1/2 x 3/4	1.96	1.62	0.50	40, 10
1-1/2 x 1-1/2 x 1	1.96	1.62	0.50	40, 10
2 x 2 x 1/2	2.06	1.75	0.50	40, 10
2 x 2 x 3/4	2.06	1.75	0.50	40, 10
2 x 2 x 1	2.06	1.75	0.50	40, 10

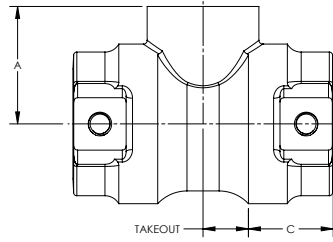

WARDLOX™ REDUCING OUTLET TEES (SLIP X SLIP X THREAD)

NPS	CENTER TO END A	PIPE ENGAGEMENT C1	PIPE ENGAGEMENT C1	TAKE OUT	SCHEDULE PIPE APPROVED
1-1/4 x 1 x 1/2	1.84	1.62	1.62	0.50	40, 10, XL, DT, D
1-1/4 x 1 x 3/4	1.84	1.62	1.62	0.50	40, 10, XL, DT, D
1-1/4 x 1 x 1	1.84	1.62	1.62	0.50	40, 10, XL, DT, D
1-1/2 x 1-1/4 x 1/2	1.96	1.62	1.62	0.50	40, 10
1-1/2 x 1-1/4 x 3/4	1.96	1.62	1.62	0.50	40, 10
1-1/2 x 1-1/4 x 1	1.96	1.62	1.62	0.50	40, 10
2 x 1-1/2 x 1/2	2.16	1.75	1.62	0.50	40, 10
2 x 1-1/2 x 3/4	2.16	1.75	1.75	0.50	40, 10
2 x 1-1/2 x 1	2.16	1.75	1.62	0.50	40, 10
2 x 2 x 1/2	2.16	1.75	1.62	0.50	40, 10
2 x 2 x 3/4	2.16	1.75	1.75	0.50	40, 10
2 x 2 x 1	2.16	1.75	1.75	0.50	40, 10

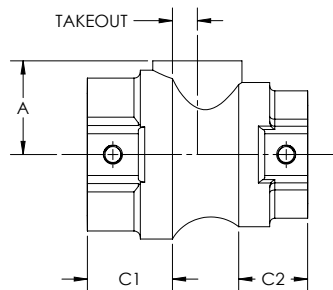

WARDLOX™ COUPLINGS (SLIP X SLIP)

NPS	LENGTH A	PIPE ENGAGEMENT C	TAKE OUT	SCHEDULE PIPE APPROVED
1 x 1	4.25	1.62	0.50	40, 10, XL, DT, D
1-1/4 x 1-1/4	4.25	1.62	0.50	40, 10, XL, DT, D
1-1/2 x 1-1/2	4.25	1.62	0.50	40, 10
2 x 2	4.25	1.75	0.50	40, 10

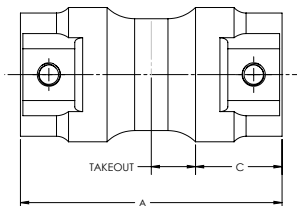

SECTION 5

TEELOX™



Designed for fast installation of bolted branch outlets, **TEELOX™ Mechanical Branch Connectors** are practical alternatives to existing branch connect systems. Made from high quality cast iron, TEELOX™ are known for long-lasting, maintenance-free performance.

KEY FEATURES:

- A high grade E.P.D.M. rubber gasket surrounds the locating collar for accurate, permanent installation and the best seal in the industry.
- The locating collar is an integral part of the casting.
- A zinc-plated high-tensile steel U-bolt ensures rust-free attachment.
- TEELOX™ is approved for conventional and arm-over installations.

TEELOX™ SPECIFICATIONS

Material:	Cast Iron ASTM A126 Class A Minimum
Gasket:	E.P.D.M. Rubber ASTM D-2000
U Bolt:	Zinc Plated High-Tensile Steel
Threading:	ASME B1.20.1
Pressure Ratings:	175 psi
Coatings:	ASTM B633, ASTM A153
Additional Specifications:	UL, ULC and FM where applicable
Torque Requirements:	20 ft.-lbs. maximum

NPS	Pipe Center to Outlet A	Hole Dia. C	Take Out
1-1/4 x 1/2	1.98	1.19	1.19
1-1/4 x 3/4	2.05	1.19	1.19
1-1/4 x 1	2.13	1.19	1.19
1-1/2 x 1/2	1.98	1.19	1.19
1-1/2 x 3/4	2.05	1.19	1.19
1-1/2 x 1	2.13	1.19	1.19
2 x 1/2	2.26	1.19	1.47
2 x 3/4	2.33	1.19	1.47
2 x 1	2.41	1.19	1.47
2-1/2 x 1/2	2.57	1.19	1.78
2-1/2 x 3/4	2.64	1.19	1.78
2-1/2 x 1	2.72	1.19	1.78

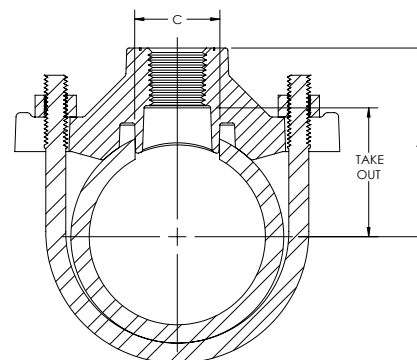

SECTION 6 MERCHANT COUPLINGS



Ward Manufacturing ("Ward") Standard Merchant Couplings are designed for general purpose, low-pressure piping, such as water, air, gas and oil lines. Material and dimensions conform to the requirements of ASTM A865.

FULL COUPLINGS

NPS	Length Coupling A	Outside Dia. B (min)
1/2	1.56	1.06
3/4	1.63	1.31
1	2.00	1.58
1-1/4	2.06	1.90
1-1/2	2.06	2.20
2	2.13	2.75
2-1/2	3.13	3.25
3	3.25	4.00
4	3.50	5.00
5	3.75	6.30
6	4.00	7.39

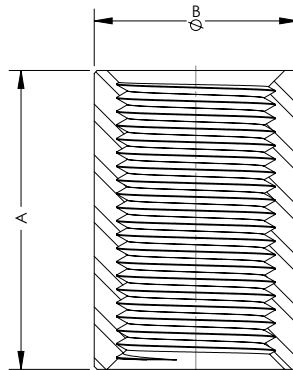

HALF COUPLINGS

NPS	Length Coupling A	Outside Dia. B (min)
1/2	0.75	1.06
3/4	0.78	1.31
1	0.97	1.58
1-1/4	1.00	1.90
1-1/2	1.00	2.20
2	1.06	2.75
2-1/2	1.56	3.25
3	1.59	4.00
4	1.72	5.00

Couplings in sizes 1/2 -2 NPS are supplied straight tapped. Couplings 2 NPS and larger are taper tapped.

SECTION 7 PIPE NIPPLES



Ward Manufacturing ("Ward") offers **Carbon-welded and Seamless Steel Pipe Nipples, as well as Stainless Steel, Aluminum, and Brass Pipe Nipples.** Different types of **Special End Pipe finishes** available at Ward include:

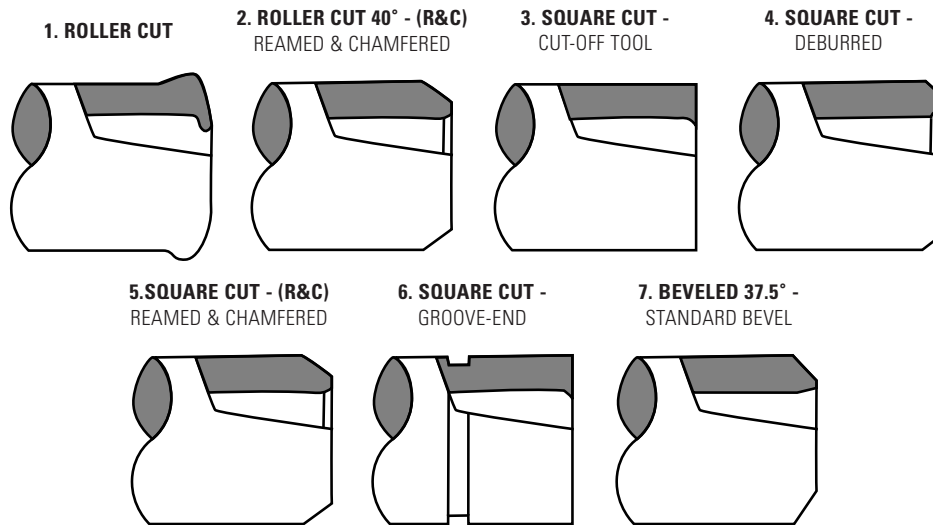

Ward also offers the following **Threading** options:

- TOE** - "Thread One End" which means one end is threaded. The customer must specify the other end finish.
- NPTF** - "Dry Seal" which means that the standard taper dry seal pipe threads are used.
- NPSL** - "Straight Locknut" which means the standard straight pipe threads are used for loose-fitting mechanical joints for locknuts.
- NPSM** - "Straight Mechanical" which means that standard straight pipe threads are used for free-fitting mechanical joints for fixtures.
- BSPT** - "British Standard Taper" which is from the BS21, ISO 7/1 specifications and is used for low pressure plumbing systems.
- Left Hand Threading** - This type of threading has counterclockwise threads on one side, and clockwise on the other.

PIPE NIPPLE SPECIFICATIONS

STEEL (Welded & Seamless)	STAINLESS STEEL (Grades T304 & T316)	BRASS
Material: ASTM A53 (Welded) A106 (Seamless)	Material: ASTM A312	Material: ASTM B43
Dimensions: ASTM A733	Dimensions: ASTM A733, ASME B36.19	Dimensions: ASTM B687
Threading: ASME B1.20.1	Threading: ASME B1.20.1	Threading: ASME B1.20.1
Coatings: ASTM A153 (Galvanized)		



PIPE NIPPLES

OFFERED IN SCHEDULE:

- 40 & 80 WELDED
- 40, 80, 160, & XXH (DOUBLE XH) SEAMLESS
- 304L & 316L SCHEDULE 40 & 80 STAINLESS STEEL
- 40 UP TO 4" IN BRASS
- 40 UP TO 2-1/2" IN ALUMINUM

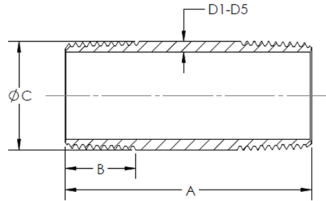

NPS	OVERALL LENGTHS A (INCHES)		*THREAD LENGTH B	OUTSIDE DIA C	THICKNESS (INCHES)				
	CLOSE	LENGTH			SCH 40 D1	SCH 80 D2	SCH 160 D3	DOUBLE XH D4	BRASS D5
1/8	3/4	UP TO 12	0.39	0.41	0.07	0.10	—	—	0.06
1/4	7/8	UP TO 12	0.59	0.54	0.08	0.12	—	—	0.08
3/8	1	UP TO 12	0.60	0.68	0.09	0.13	—	—	0.09
1/2	1-1/8	UP TO 12	0.78	0.84	0.10	0.14	0.19	0.29	0.10
3/4	1-3/8	UP TO 12	0.79	1.05	0.11	0.15	0.22	0.31	0.11
1	1-1/2	UP TO 12	0.98	1.31	0.13	0.18	0.25	0.36	0.13
1-1/4	1-5/8	UP TO 12	1.01	1.66	0.14	0.19	0.25	0.38	0.14
1-1/2	1-3/4	UP TO 12	1.03	1.90	0.15	0.20	0.28	0.40	0.15
2	2	UP TO 12	1.06	2.38	0.16	0.22	0.34	0.44	0.16
2-1/2	2-1/2	UP TO 12	1.57	2.88	0.20	0.28	0.38	0.55	0.19
3	2-5/8	UP TO 12	1.63	3.50	0.22	0.30	0.44	0.60	0.22
3-1/2	2-3/4	UP TO 12	1.68	4.00	0.23	0.32	—	—	0.25
4	2-7/8	UP TO 12	1.73	4.50	0.24	0.34	0.53	0.67	0.25
5	3	UP TO 12	1.84	5.56	0.26	0.38	—	—	—
6	3-1/8	UP TO 12	1.95	6.63	0.28	0.43	—	—	—
8	4-1/2	UP TO 12	2.15	8.63	0.32	0.50	—	—	—

*Thread length is equal to overall length for close nipples



READY-CUT PIPE NIPPLE RACKS

RACK WITH BLACK & GALVANIZED PIPE

NPS	LENGTH						
	18"	24"	30"	36"	48"	60"	72"
1/2	5	5	5	5	5	5	5
3/4	5	5	5	5	5	5	5
1	3	3	3	3	3	3	3
1-1/4	2	2	2	2	2	2	2
1-1/2	2	2	2	2	2	2	2

RACK WITH BLACK & GALVANIZED PIPE

NPS	LENGTH						
	18"	24"	30"	36"	48"	60"	72"
1/2	5	5	5	5	5	5	5
3/4	5	5	5	5	5	5	5
1	3	3	3	3	3	3	3

READY-CUT PIPE BUNDLING SCHEDULE

(ALL ITEMS OVER 12")

PIPE DIAMETER	BUNDLE
1/8" - 3/4"	5 PCS.
1" - 1-1/2"	3 PCS.
2" - 2-1/2"	2 PCS.
3"	THREADS WRAPPED & A LABEL



117 GULICK STREET, BLOSSBURG, PA 16912
PH: 800-248-1027 | WWW.WARDMFG.COM
orders@wardmfg.com | ward.technical@wardmfg.com

