

## For Health Hazard Applications

Job Name \_\_\_\_\_

Contractor \_\_\_\_\_

Job Location \_\_\_\_\_

Approval \_\_\_\_\_

Engineer \_\_\_\_\_

Contractor's P.O. No. \_\_\_\_\_

Approval \_\_\_\_\_

Representative \_\_\_\_\_

# LEAD FREE\*

## Series LF825Y

### Reduced Pressure Zone Assemblies

Size: ¾" - 2"

The FEBCO Series LF825Y Reduced Pressure Zone Assemblies are used to protect against high hazard (toxic) fluids in water services to industrial plants, hospitals, morgues, mortuaries, and chemical plants. They are also used in irrigation systems, boiler feed, water lines and other installations requiring maximum protection. The LF825Y features Lead Free\* construction to comply with Lead Free\* installation requirements.

#### Features

- Ultimate mechanical protection of potable water, against hazards of cross-connection contamination.
- Meets all specifications of AWWA, ASSE, CSA and approved by the Foundation for Cross-Connection Control and Hydraulic Research at the University of Southern California.
- Approved by the Foundation of Cross-Connection Control and Hydraulic Research at the University of Southern California.
- Modular relief valve for ease of maintenance.
- Simple Service procedures. All internal parts serviceable in line.
- Low head loss.
- Spring loaded "Y" type check valves.
- Internal relief valve pressure sensing passages.
- Replaceable seat rings on all sizes.
- End connection – NPT ANSI / ASME B1.20.1

#### Specifications

The reduced pressure zone assembly shall consist of two independently operating, spring loaded, "Y" pattern check valves and one hydraulically dependent differential relief valve. The assembly shall automatically reduce the pressure in the "zone" between the check valves to at least 5psi lower than inlet pressure. Should the differential between the upstream and the zone of the unit drop to 2psi, the differential relief valve shall open and maintain the proper differential.

Mainline valve body and caps including relief valve body and cover shall be Lead Free\* cast copper silicon alloy. Check valve moving member shall be center stem guided. All hydraulic sensing passages shall be internally located within the mainline and relief valve bodies and relief valve cover. Diaphragm to seat area ratio shall be 10:1 minimum. Relief valve shall have a removable seat ring. Check valve and relief valve components shall be constructed so they may be serviced without removing the valve body from the line. All seat discs shall be reversible. Shutoff valves and test cocks shall be full ported ball valves.



The assembly shall be rated to 175psi (12.1 bar) working pressure and water temperature range from 32°F to 140°F (0°C - 60°C). The Lead Free\* Reduced Pressure Zone Assemblies shall comply with state codes and standards, where applicable, requiring reduced lead content.

The assembly shall meet the requirements of ASSE Standard 1013; AWWA Standard Code C511; CSA Standard B64.4; and approved by the Foundation for Cross-Connection Control and Hydraulic Research at the University of Southern California.

#### Operation

In a flow condition the check valves are open with the pressure between the checks, called the zone, being maintained at least 5.0psi lower than the inlet pressure and the relief valve is maintained closed.

Should abnormal conditions arise under no flow or reversal of flow, the differential relief valve will open and discharge to maintain the zone at least 2psi lower than the supply.

When normal flow resumes, the zone's differential pressure will resume and the relief valve will close.

#### Typical Installation

Reduced pressure zone assemblies should be installed with minimum clearance of 12" (300mm) between relief valve discharge port and floor or grade. They must be installed where discharge will not be objectionable and can be positively drained away. They should be installed where easily accessible for testing and maintenance and must be protected from freezing. Thermal water expansion and/or water hammer downstream of the backflow preventer can cause excessive pressure. Excessive pressure situations should be eliminated to avoid possible damage to the system and assembly.

#### NOTICE

Refer to local codes for specific installation requirements. Some codes may prohibit vertical installation.

**\*The wetted surface of this product contacted by consumable water contains less than 0.25% of lead by weight.**

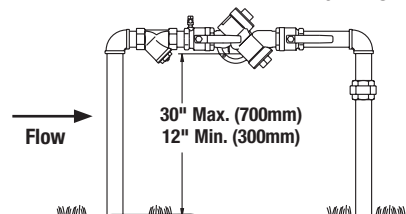

FEBCO product specifications in U.S. customary units and metric are approximate and are provided for reference only. For precise measurements, please contact FEBCO Technical Service. FEBCO reserves the right to change or modify product design, construction, specifications, or materials without prior notice and without incurring any obligation to make such changes and modifications on FEBCO products previously or subsequently sold.

**A WATTS Brand**

## Capacity

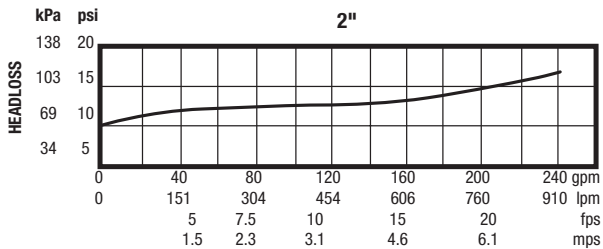
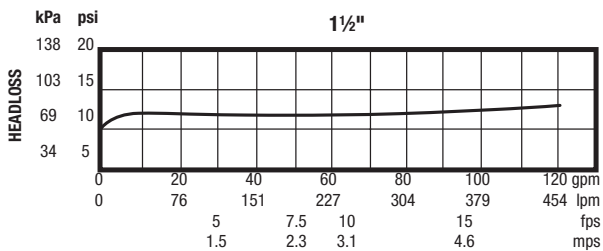
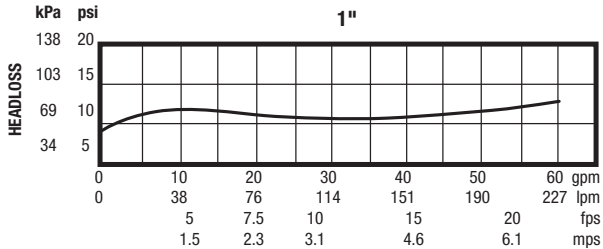
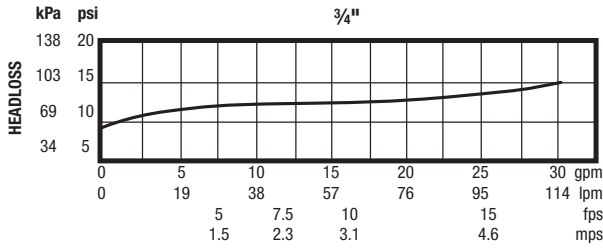

## Dimensions – Weights

Size: 3/4" - 2"

SIZE	DIMENSIONS										WEIGHT	
	A		B*		C		D		E		lbs.	kgs.
in.	mm	in.	mm	in.	mm	in.	mm	in.	mm			
3/4	12	305	7 3/4	197	3 1/4	83	3 1/4	83	4 1/8	105	11.5	5.2
1	12 3/4	324	7 3/4	197	3 1/4	83	3 1/4	83	4 1/8	105	12.5	5.7
1 1/2	17	432	10 1/2	267	4 1/2	114	4 1/2	114	5	127	26.5	12.0
2	17 3/4	451	10 1/2	267	4 1/2	114	4 1/2	114	5	127	29.0	13.0

\* B Dimension is less shutoffs

Weights shown are approximate. Dimensions shown are nominal, allowance must be made for normal manufacturing tolerances.

## Temperature – Pressure

Maximum working pressure: 175psi (12.1 bar)  
 Hydrostatic test pressure: 350psi (24.1 bar)  
 Temperature range: 32°F to 140°F (0°C to 60°C)

## Materials

Main valve body: Lead Free\* Cast Copper Silicon Alloy  
 Relief valve body: Lead Free\* Cast Copper Silicon Alloy  
 Elastomers: Nitrile Seat Discs  
 Diaphragms: Nitrile, fabric reinforced  
 Springs: Stainless Steel

## Approvals – Standards

- Approved by the Foundation for Cross-Connection Control and Hydraulic Research at the University of Southern California.
- AWWA C511 Conformance



### NOTICE

The information contained herein is not intended to replace the full product installation and safety information available or the experience of a trained product installer. You are required to thoroughly read all installation instructions and product safety information before beginning the installation of this product.

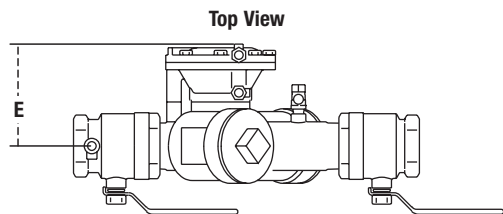
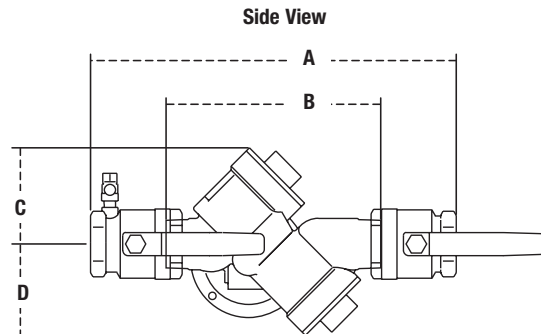

A WATTS Brand

USA: Tel: (800) 767-1234 • Fax: (800) 788-4491 • FEBCOonline.com

Canada: Tel: (905) 332-4090 • Fax: (905) 332-7068 • FEBCOonline.ca

Latin America: (52) 81-1001-8600 • Fax: (52) 81-8000-7091 • FEBCOonline.com