

Oatey[®]SCS

SUPPLY CHAIN SERVICES



CANADIAN PRODUCT CATALOGUE

TABLE OF CONTENTS

| | |
|--|-----|
| Plastic Pipe Cements and Primers..... | 5 |
| Thread Sealants and Leak Detectors..... | 19 |
| Copper Installation..... | 26 |
| Putty, Caulks, and Water Barriers..... | 34 |
| Oils, Lubricants, and Hand Cleaners..... | 38 |
| Drain and Waste System Cleaners..... | 40 |
| Heating Chemicals and Anti-Freeze..... | 45 |
| Bowl Setting Wax Gaskets and Bolts..... | 52 |
| Drains and Closet Flanges..... | 55 |
| Shower Systems..... | 72 |
| Supply Boxes..... | 76 |
| Flashings..... | 93 |
| Air Admittance Values (AAV)..... | 97 |
| Pipe Support..... | 101 |
| Brass/Plastic Tubular, Grab Bars & Pipe Wrap..... | 110 |
| Bath Waste and Overflow..... | 113 |
| Strainers..... | 120 |
| Pneumatic Pipe Plugs..... | 122 |
| Mechanical Pipe Plugs..... | 131 |
| Test Equipment, Drain Flushers, and Accessories..... | 137 |
| Pans and Stands..... | 143 |
| Commercial Drainage..... | 146 |
| Rough-In Products and Tools..... | 151 |



POWER OF ONE

The Power of One

The Oatey Company is the number one source for purchasing the leading brands in the plumbing and waterworks industries. You can purchase any of our brands easily and efficiently – on one invoice, in one shipment, with one phone call. Only Oatey brings you the plumbing industry's best brands in one source. That's why we're the choice for plumbing professionals. **Due to the dynamic nature of our broad product offering, please consult your price file for items stocked and supported in Canada.**

For more information on Oatey or our product offerings, please visit Oatey.ca or contact our customer service group at **800-321-9532**.

TRUSTED

- Comprehensive technical support
- Reputable leadership in the plumbing industry
- Experienced customer service professionals

STRONG

- Central distribution center in Brampton, ON
- Multiple manufacturing locations: Ohio, Nebraska, Minnesota and China
- ISO 9001 Certified
- Twenty-two categories with a broad range of products

EFFICIENT

- EDI - Paperless ordering, invoices and ship notices
- Automatic acknowledgements and confirmations of shipments
- Economical minimum orders for prepaid freight
- Multi-branded Promotional Opportunities

SAFE

- Compliant to hazmat policies
- Sustainable practices
- C-TPAT participant



Oatey® is the leading manufacturer of solvent cements, roof flashings, washing machine outlet boxes, air admittance valves, plumbing chemicals, wax bowl rings, and hundreds of other plumbing specialty products. Found in many residential and commercial applications, Oatey products have earned the trust of both plumbing professionals and consumers since 1916. Oatey Co. operates a comprehensive global manufacturing and distribution network, backed by experienced and responsive technical service professionals.



MASTERS® is Canada's leading brand of pipe thread sealants, copper installation products, and consumable plumbing goods. Founded by G.F. Thompson in 1947, we have been providing quality products under the MASTERS® brand name for over 70 years. Serving the Plumbing, HVAC, Industrial and Retail trades, we offer unparalleled product quality, industry-leading customer service and top-line representation in the field.



Cherne® is the recognized world leader in pipe plug and testing equipment manufacturing. In 1998, Cherne demonstrated its commitment to quality and continuous improvement by achieving ISO 9001 registration. Cherne is the only domestic pipe plug manufacturer to achieve this certification. Serving the plumbing and underground industries for more than 60 years, Cherne is dedicated to providing customers with unparalleled product quality in addition to the highest level of customer service. From plumbing to underground—we have your products in stock.



Hercules® brand plumbing chemicals have been found in plumber's tool collections for nearly 100 years. The company makes more than 100 different products including chemicals, putty, drain cleaners, hand towels and Megaloc® thread sealant and PTFE tapes.



Dearborn Brass® is the leading manufacturer of Brass and Plastic Tubular products for the plumbing industry. Included in our product offering are Commercial Tubular, Bath Waste and Overflow, Basket Strainers and Plumbing Specialties. Dearborn Brass has been successful for more than 100 years because of the commitment of our associates to provide superior quality products at competitive prices. The Dearborn Brass name has grown to become the preferred choice of plumbing professionals, widely recognized by its distinctive checkerboard packaging. Find the checkerboard and you've found assured quality and peace of mind.



Keeney® is a leading manufacturer and distributor of tubular drainage products. Founded in 1923, the Keeney and PlumbPak by Keeney families include coin air valves, under-sink drainage, quarter-turn valves, bath drains, toilet repair parts, Bélanger faucets, and more.



QuickDrain™ products are designed for the Hospitality, Healthcare and Residential Markets. The QuickDrain system can adapt to almost any existing plumbing condition, slashes construction time, saves on cost and minimizes impact on customers.



Harvey™ began in 1944, when Master Plumber William H. Harvey Sr. came up with the idea of a pre-formed wax gasket for setting toilet bowls. Nearly 70 years later, more than 3500 Harvey-brand plumbing specialty products are sold throughout North and South America.



Category 1

Plastic Pipe Cements and Primers

Oatey sells only Lo-VOC solvent cements, which means they are compliant with the South Coast Air Quality Management District (SCAQMD) Rule 1168 and the Ozone Transport Commission (OTC) standards. Plus they meet ASTM, NSF and UPC standards for a wide variety of applications, including potable water, DWV, industrial, pool/spa, turf/irrigation, sewer and many more. With Oatey you get more than just the strongest solvent welded joint – you get the confidence of the top selling brands, backed by years of extensive research and leadership in the plumbing industry. That’s why Oatey has been the choice of plumbing professionals for nearly 100 years.

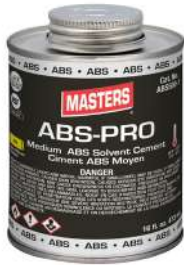

MASTERS® ABS-PRO Medium ABS Solvent Cement

- Ideal for joining all schedules and classes of ABS pipe and fittings up to 6" in diameter with interference fit.
- Low VOC and meets South Coast Quality Management District (SCAQMD) 1168/316A or BAAQMD Method 40, as well as ASTM D2235.
- ABS-PRO is recommended for use on potable water or DWV.

| Product No. | Size | Description | UPC | Ctn. Qty. |
|-------------|--------|---------------------------------------|--------------|-----------|
| ABS250-1 | 237 ml | MASTERS® ABS-PRO Medium Yellow Cement | 067001022400 | 24 |
| ABS500-1 | 473 ml | MASTERS® ABS-PRO Medium Yellow Cement | 067001022417 | 24 |
| ABS1L-1 | 946 ml | MASTERS® ABS-PRO Medium Yellow Cement | 067001022424 | 12 |
| ABS4L-1 | 3.78 L | MASTERS® ABS-PRO Medium Yellow Cement | 067001022431 | 6 |

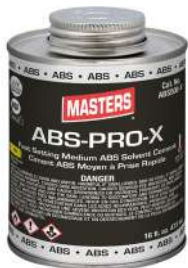

MASTERS® ABS-PRO-X Fast-Setting ABS Solvent Cement

- Ideal for joining all schedules and classes of ABS pipe and fittings up to 6" in diameter with interference fit.
- Low VOC and meets South Coast Quality Management District (SCAQMD) 1168/316A or BAAQMD Method 40, as well as ASTM D2235.
- ABS-PRO is recommended for use on potable water or DWV.

| Product No. | Size | Description | UPC | Ctn. Qty. |
|-------------|--------|--|--------------|-----------|
| ABS250-X | 237 ml | MASTERS® ABS-PRO-X Medium/Fast Yellow Cement | 067001022448 | 24 |
| ABS500-X | 473 ml | MASTERS® ABS-PRO-X Medium/Fast Yellow Cement | 067001022455 | 24 |
| ABS1L-X | 946 ml | MASTERS® ABS-PRO-X Medium/Fast Yellow Cement | 067001022462 | 12 |
| ABS4L-X | 3.78 L | MASTERS® ABS-PRO-X Medium/Fast Yellow Cement | 067001022479 | 6 |



Oatey® ABS Premium Yellow Cement

- Medium-bodied yellow coloured cement for ABS pipe and fittings. Up to 6" diameter.
- For all types and grades of ABS pipe and fittings for DWV.
- Lo-V.O.C. Solvent Cement meets SCAQMD 1168/316A or BAAQMD Method 40 and various environmental requirements.
- For all non-pressure applications.
- Recommended application temperature 40°F to 110°F / 4°C to 43°C.
- Meets ASTM D2235.

| Product No. | Size | Description | UPC | Ctn. Qty. |
|-------------|--------|---------------------------|--------------|-----------|
| 31500 | 118 ml | ABS Premium Yellow Cement | 038753315003 | 24 |
| 31501 | 237 ml | ABS Premium Yellow Cement | 038753315010 | 24 |
| 31502 | 473 ml | ABS Premium Yellow Cement | 038753315027 | 24 |
| 31503 | 946 ml | ABS Premium Yellow Cement | 038753315034 | 12 |
| 31504 | 3.78 L | ABS Premium Yellow Cement | 038753315041 | 6 |



Oatey® ABS Standard Yellow Cement

- Medium-bodied yellow coloured cement for use on ABS pipe and fittings. Up to 6" diameter.
- Lo-V.O.C. Solvent Cement meets SCAQMD 1168/316A or BAAQMD Method 40 and various environmental requirements.
- For all non-pressure applications.
- For all types and grades of ABS pipe and fittings for DWV.
- Recommended application temperature 40°F to 110°F / 4°C to 43°C.
- Meets ASTM D2235.

| Product No. | Size | Description | UPC | Ctn. Qty. |
|-------------|--------|----------------------------|--------------|-----------|
| 31540 | 118 ml | ABS Standard Yellow Cement | 038753315409 | 24 |
| 31541 | 237 ml | ABS Standard Yellow Cement | 038753315416 | 24 |
| 31542 | 473 ml | ABS Standard Yellow Cement | 038753315423 | 24 |
| 31543 | 946 ml | ABS Standard Yellow Cement | 038753315430 | 12 |
| 31544 | 3.78 L | ABS Standard Yellow Cement | 038753315447 | 6 |

PVC SOLVENT CEMENTS



MASTERS® PVC-PRO Fast-Setting Medium Grey Cement

- Ideal for joining all schedules and classes of PVC pipe and fittings up to 6" in diameter with interference fit.
- Low VOC and meets South Coast Quality Management District (SCAQMD) 1168/316A or BAAQMD Method 40 requirements, as well as ASTM D2564. Green Guard certified Low VOC.
- Recommended for use on potable water, pressure pipe, conduit or DWV.

| Product No. | Size | Description | UPC | Ctn. Qty. |
|-------------|--------|-------------------------------------|--------------|-----------|
| PVC250-G | 237 ml | MASTERS® PVC-PRO Medium Grey Cement | 067001022639 | 24 |
| PVC500-G | 473 ml | MASTERS® PVC-PRO Medium Grey Cement | 067001022677 | 24 |
| PVC1L-G | 946 ml | MASTERS® PVC-PRO Medium Grey Cement | 067001022615 | 12 |
| PVC4L-G | 3.78 L | MASTERS® PVC-PRO Medium Grey Cement | 067001022653 | 6 |



MASTERS® PVC-PRO Fast-Setting Medium Clear Cement

- Ideal for joining all schedules and classes of PVC pipe and fittings up to 6" in diameter with interference fit.
- Low VOC and meets South Coast Quality Management District (SCAQMD) 1168/316A or BAAQMD Method 40 requirements, as well as ASTM D2564.
- Recommended for use on potable water, pressure pipe, conduit or DWV.

| Product No. | Size | Description | UPC | Ctn. Qty. |
|-------------|--------|--------------------------------------|--------------|-----------|
| PVC250-C | 237 ml | MASTERS® PVC-PRO Medium Clear Cement | 067001022622 | 24 |
| PVC500-C | 473 ml | MASTERS® PVC-PRO Medium Clear Cement | 067001022660 | 24 |
| PVC1L-C | 946 ml | MASTERS® PVC-PRO Medium Clear Cement | 067001022608 | 12 |
| PVC4L-C | 3.78 L | MASTERS® PVC-PRO Medium Clear Cement | 067001022646 | 6 |



PVC Heavy Duty Clear Cement

- Heavy Duty Clear cement for use on all schedules and classes PVC pipe and fitting up to 12" diameter with interference fit, up to 18" for non-pressure.
- Lo-V.O.C. Solvent Cement meets California South Coast Air Quality Management District (SCAQMD) 1168/316A or BAAQMD Method 40 and various environmental requirements.
- Thick formula fills gaps in large diameter pipe and loose fitting joints.
- Recommended for potable water, pressure pipe, conduit and DWV.
- Recommended application temperature 40°F to 110°F / 4°C to 43°C.
- Meets ASTM D2564.

| Product No. | Size | Description | UPC | Ctn. Qty. |
|-------------|--------|--|--------------|-----------|
| 31476 | 118 ml | PVC Heavy Duty Clear Cement | 038753314761 | 24 |
| 31477 | 237 ml | PVC Heavy Duty Clear Cement | 038753314778 | 24 |
| 31478 | 473 ml | PVC Heavy Duty Clear Cement | 038753314785 | 24 |
| 31479 | 946 ml | PVC Heavy Duty Clear Cement | 038753314792 | 12 |
| 31463 | 3.78 L | PVC Heavy Duty Clear Cement – Wide Mouth Can | 038753310114 | 6 |



Oatey® EP13 Extra Heavy-Duty PVC Cement

- EP13 extra heavy-bodied, slow-setting, gray solvent cement for use on all classes and schedules of PVC pipe up to 30".
- Recommended for potable water, pressure pipe, drain, waste and vent systems.
- Builds up for large diameter installation to fill gaps.
- Ideal for fabrication.
- Recommended application temperature 40°F to 110°F / 4°C to 43°C.
- Complies with various environmental requirements and SCAQMD Rule 1168/316A or BAAQMD Method 40 for VOC.
- Formulated for warm weather application.
- Three year shelf life.
- Meets and exceeds ASTM D2564.

| Product No. | Size | Description | UPC | Ctn. Qty. |
|-------------|--------|---------------------------------------|--------------|-----------|
| 31779 | 946 ml | EP13 Extra Heavy Duty Gray PVC Cement | 083675018365 | 12 |
| 31780 | 3.78 L | EP13 Extra Heavy Duty Gray PVC Cement | 083675018242 | 6 |



Oatey® PVC Heavy Duty Gray Cement

- Heavy Duty Gray cement for use on all schedules and classes PVC pipe and fitting up to 12" diameter with interference fit, up to 18" for non-pressure.
- Lo-V.O.C. Solvent Cement meets California South Coast Air Quality Management District (SCAQMD) 1168/316A or BAAQMD Method 40 and various environmental requirements.
- Thick formula fills gaps in large diameter pipe and loose fitting joints.
- Recommended for potable water, pressure pipe, conduit and DWV.
- Recommended application temperature 40°F to 110°F / 4°C to 43°C.
- Meets ASTM D2564.

| Product No. | Size | Description | UPC | Ctn. Qty. |
|-------------|--------|----------------------------|--------------|-----------|
| 31510 | 118 ml | PVC Heavy Duty Gray Cement | 038753315102 | 24 |
| 31511 | 237 ml | PVC Heavy Duty Gray Cement | 038753315119 | 24 |
| 31512 | 473 ml | PVC Heavy Duty Gray Cement | 038753315126 | 24 |
| 31513 | 946 ml | PVC Heavy Duty Gray Cement | 038753315133 | 12 |
| 31514 | 3.78 L | PVC Heavy Duty Gray Cement | 038753315140 | 6 |



Oatey® PVC Heavy Duty Gray Fast Set Cement

- Very Heavy-bodied fast setting gray cement for use on all schedules and classes PVC pipe and fittings up to 18" diameter with interference fit.
- Lo-V.O.C. Solvent Cement meets California South Coast Air Quality Management District (SCAQMD) 1168/316A or BAAQMD Method 40 and various environmental requirements.
- Formulated for quick installation of irrigation pipe and fittings.
- Builds up for large diameter installations.
- Fills gaps in large diameter pipe and loose fitting joints.
- Recommended for potable water, pressure pipe, conduit and DWV.
- Recommended application temperature 40°F to 110°F / 4°C to 43°C.
- Meets ASTM D2564.

| Product No. | Size | Description | UPC | Ctn. Qty. |
|-------------|--------|------------------------------|--------------|-----------|
| 31467 | 473 ml | PVC Heavy Duty Gray Fast Set | 038753311210 | 24 |
| 31468 | 946 ml | PVC Heavy Duty Gray Fast Set | 038753311227 | 12 |



Oatey® PVC Heavy Duty Medium Set Gray Cement

- Very Heavy-bodied medium setting gray cement for use on all schedules and classes PVC pipe and fittings up to 18" diameter with interference fit.
- Lo-V.O.C. Solvent Cement meets California South Coast Air Quality Management District (SCAQMD) 1168/316A or BAAQMD Method 40 and various environmental requirements.
- Formulated for quick installation of irrigation pipe and fittings.
- Builds up for large diameter installations.
- Fills gaps in large diameter pipe and loose fitting joints.
- Recommended for potable water, pressure pipe, conduit and DWV.
- Recommended application temperature 40°F to 110°F / 4°C to 43°C.
- Meets ASTM D2564.

| Product No. | Size | Description | UPC | Ctn. Qty. |
|-------------|--------|----------------------------|--------------|-----------|
| 31446 | 237 ml | Heavy Duty Medium Set Gray | 038753314464 | 24 |
| 31772 | 473 ml | Heavy Duty Medium Set Gray | 038753317724 | 24 |
| 31773 | 946 ml | Heavy Duty Medium Set Gray | 038753317731 | 12 |
| 31774 | 3.78 L | Heavy Duty Medium Set Gray | 038753317748 | 6 |



Oatey® PVC Medium Clear Cement

- Medium-Bodied Clear cement for use on all schedules and classes of PVC pipe and fittings up to 6" diameter with interference fit.
- Lo-V.O.C. Solvent Cement meets California South Coast Air Quality Management District (SCAQMD) 1168/316A or BAAQMD Method 40 and various environmental requirements.
- Recommended for potable water, pressure pipe, conduit and DWV.
- Recommended application temperature 40°F to 110°F / 4°C to 43°C.
- Meets ASTM D2564.

| Product No. | Size | Description | UPC | Ctn. Qty. |
|-------------|--------|-------------------------|--------------|-----------|
| 31535 | 118 ml | PVC Medium Clear Cement | 038753315355 | 24 |
| 31536 | 237 ml | PVC Medium Clear Cement | 038753315362 | 24 |
| 31537 | 473 ml | PVC Medium Clear Cement | 038753315379 | 24 |
| 31538 | 946 ml | PVC Medium Clear Cement | 038753315386 | 12 |
| 31539 | 3.78 L | PVC Medium Clear Cement | 038753315393 | 6 |



Oatey® PVC Medium Gray Cement

- Medium-Bodied Gray cement for use on all schedules and classes of PVC pipe and fittings up to 6" diameter with interference fit.
- Lo-V.O.C. Solvent Cement meets California South Coast Air Quality Management District (SCAQMD) 1168/316A or BAAQMD Method 40 and various environmental requirements.
- Recommended for potable water, pressure pipe, conduit and DWV.
- Recommended application temperature 40°F to 110°F / 4°C to 43°C.
- Meets ASTM D2564.

| Product No. | Size | Description | UPC | Ctn. Qty. |
|-------------|--------|------------------------|--------------|-----------|
| 31505 | 118 ml | PVC Medium Gray Cement | 038753315058 | 24 |
| 31506 | 237 ml | PVC Medium Gray Cement | 038753315065 | 24 |
| 31507 | 473 ml | PVC Medium Gray Cement | 038753315072 | 24 |
| 31508 | 946 ml | PVC Medium Gray Cement | 038753315089 | 12 |
| 31509 | 3.78 L | PVC Medium Gray Cement | 038753315096 | 6 |



Oatey® PVC Medium Gray 1-Step Cement

- Medium-bodied gray coloured cement for use on PVC pipe and fittings. Up to 6" diameter for Sch. 40 and Sch. 80.
- This cement is specially formulated for use on all non-pressure PVC DWV piping systems up to 6" in diameter.
- Lo-V.O.C. Solvent Cement meets SCAQMD 1168/316A or BAAQMD Method 40 and various environmental requirements.
- Recommended application temperature 40F to 110F / 4C to 43C.
- Meets ASTM D2564.
- No primer needed on non-pressure DWV, up to 4" where local codes permit.

| Product No. | Size | Description | UPC | Ctn. Qty. |
|-------------|--------|-------------------------------|--------------|-----------|
| 31595 | 118 ml | PVC Medium Gray 1-Step Cement | 038753315959 | 24 |
| 31596 | 237 ml | PVC Medium Gray 1-Step Cement | 038753315966 | 24 |
| 31597 | 473 ml | PVC Medium Gray 1-Step Cement | 038753315973 | 24 |
| 31598 | 946 ml | PVC Medium Gray 1-Step Cement | 038753315980 | 12 |
| 31599 | 3.78 L | PVC Medium Gray 1-Step Cement | 038753315997 | 6 |



Oatey® PVC Regular Clear Cement

- Regular-Bodied Clear cement for use on all schedules and classes of PVC pipe and fittings up to 4" for Sch. 40 and up to 2" for Sch. 80.
- Lo-V.O.C. Solvent Cement meets California South Coast Air Quality Management District (SCAQMD) 1168/316A or BAAQMD Method 40 and various environmental requirements.
- Recommended for potable water, pressure pipe, conduit and DWV.
- Recommended application temperature 40°F to 110°F / 4°C to 43°C.
- Meets ASTM D2564.

| Product No. | Size | Description | UPC | Ctn. Qty. |
|-------------|--------|--------------------------|--------------|-----------|
| 31470 | 118 ml | PVC Regular Clear Cement | 038753314709 | 24 |
| 31471 | 237 ml | PVC Regular Clear Cement | 038753314716 | 24 |
| 31472 | 473 ml | PVC Regular Clear Cement | 038753314723 | 24 |
| 31464 | 946 ml | PVC Regular Clear Cement | 038753310152 | 12 |
| 31465 | 3.78 L | PVC Regular Clear Cement | 038753310169 | 6 |



Oatey® PVC Blue Lava Hot Cement

- Medium-bodied blue cement for use on all schedules and classes of PVC pipe and fittings up to 6" diameter with interference fit.
- Lo-V.O.C. Solvent Cement meets California South Coast Air Quality Management District (SCAQMD) 1168/316A or BAAQMD Method 40 and various environmental requirements.
- Very fast-setting "Hot" cement formulated for wet conditions and/or quick pressurization and fast installation.
- Recommended for potable water, sewer and DWV applications.
- Recommended application temperature 40°F to 110°F / 4°C to 43°C.
- No primer needed on non-pressure DWV, where local codes permit.
- Meets ASTM D2564.

| Product No. | Size | Description | UPC | Ctn. Qty. |
|-------------|--------|--------------------------|--------------|-----------|
| 31788 | 473 ml | PVC Blue Lava Hot Cement | 038753317885 | 24 |



Pool-Tite™ 2300 Series Medium Blue "Hot" PVC Cement

- Medium-bodied blue coloured cement for use on all schedules and classes of flexible and rigid PVC pipe and fittings up to 6" with interference fit.
- Lo-V.O.C. Solvent Cement meets California South Coast Air Quality Management District (SCAQMD) 1168/316A or BAAQMD Method 40 and various environmental requirements.
- No primer needed on non-pressure DWV, where local codes permit.
- Very fast setting cement formulated for wet conditions and/or quick pressurization and fast installation.
- Recommended application temperature 40°F to 110°F / 4°C to 43°C.
- Recommended for potable water, pressure pipe and DWV.
- Meets ASTM D2564.

| Product No. | Size | Description | UPC | Ctn. Qty. |
|-------------|--------|---------------------------------|--------------|-----------|
| 2366C | 118 ml | Pool-Tite PVC Medium "Hot" Blue | 083675023666 | 24 |
| 2346C | 473 ml | Pool-Tite PVC Medium "Hot" Blue | 083675023468 | 24 |
| 2336C | 946 ml | Pool-Tite PVC Medium "Hot" Blue | 083675023369 | 12 |
| 2324C | 3.78 L | Pool-Tite PVC Medium "Hot" Blue | 083675023246 | 6 |



Oatey® PVC Rain-R-Shine® Gray Cement

- Medium-bodied gray coloured cement for PVC pipe and fittings. Up to 6" diameter.
- Very fast-setting cement formulated for wet conditions and/or quick pressurization and fast installation.
- Recommended for ALL grades and types of PVC pipe and fittings, potable water and DWV.
- Lo-V.O.C. Solvent Cement meets SCAQMD 1168/316A or BAAQMD Method 40 and various environmental requirements.
- Both Schedule 40 and Schedule 80.
- Pool / Irrigation.
- Recommended application temperature 40°F to 110°F / 4°C to 43°C.
- No primer needed on non-pressure DWV, up to 4" where local codes permit.
- Meets ASTM D 2564.

| Product No. | Size | Description | UPC | Ctn. Qty. |
|-------------|--------|------------------------------|--------------|-----------|
| 31580 | 118 ml | PVC Rain-R-Shine Gray Cement | 038753315805 | 24 |
| 31581 | 237 ml | PVC Rain-R-Shine Gray Cement | 038753315812 | 24 |
| 31582 | 473 ml | PVC Rain-R-Shine Gray Cement | 038753315829 | 24 |
| 31583 | 946 ml | PVC Rain-R-Shine Gray Cement | 038753315836 | 12 |
| 31584 | 3.78 L | PVC Rain-R-Shine Gray Cement | 038753315843 | 6 |



Oatey® PVC Rain-R-Shine® Blue Cement

- Medium-bodied blue cement for use on all schedules and classes of PVC pipe and fittings up to 6" diameter with interference fit.
- Lo-V.O.C. Solvent Cement meets California South Coast Air Quality Management District (SCAQMD) 1168/316A or BAAQMD Method 40 and various environmental requirements.
- Very fast-setting "Hot" cement formulated for wet conditions and/or quick pressurization and fast installation.
- Recommended for pool, irrigation, potable water, pressure pipe, conduit and DWV.
- Recommended application temperature 40°F to 110°F / 4°C to 43°C.
- No primer needed on non-pressure DWV, where local codes permit.
- Meets ASTM D2564.

| Product No. | Size | Description | UPC | Ctn. Qty. |
|-------------|--------|------------------------|--------------|-----------|
| 31447 | 237 ml | PVC Rain-R-Shine® Blue | 038753314471 | 24 |
| 31786 | 946 ml | PVC Rain-R-Shine® Blue | 038753317861 | 12 |

SPECIALTY PVC SOLVENT CEMENTS



Oatey® PVC All Weather Clear Cement

- Medium-Bodied Clear cement for use on all schedules and classes of PVC pipe and fittings up to 6" diameter with interference fit.
- Lo-V.O.C. Solvent Cement meets California South Coast Air Quality Management District (SCAQMD) 1168/316A or BAAQMD Method 40 and various environmental requirements.
- Recommended application temperature -15°F to 110°F / -26°C to 43°C.
- Recommended for potable water, drain, waste and vent systems.
- No primer needed on non-pressure DWV, up through 4" diameter where local codes permit.
- Meets ASTM D2564.

| Product No. | Size | Description | UPC | Ctn. Qty. |
|-------------|--------|--|--------------|-----------|
| 31473 | 473 ml | PVC All Weather Clear Cement | 038753314730 | 24 |
| 31474 | 946 ml | PVC All Weather Clear Cement | 038753314747 | 12 |
| 31469 | 3.78 L | PVC All Weather Clear – Wide Mouth Can | 038753311357 | 6 |



Oatey® PVC Flexible Clear Cement

- Medium-Bodied Clear cement for use on flexible PVC pipe and rigid fittings up to 6" diameter with interference fit.
- Lo-V.O.C. Solvent Cement meets California South Coast Air Quality Management District (SCAQMD) 1168/316A or BAAQMD Method 40 and various environmental requirements.
- Formulated to withstand pressures and vibrations commonly associated with spa and swimming pool installations.
- Meets manufacturer's rated line pressure for flexible PVC pipe.
- Recommended application temperature 40°F to 110°F / 4°C to 43°C.
- Meets ASTM D2564.

| Product No. | Size | Description | UPC | Ctn. Qty. |
|-------------|--------|---------------------------|--------------|-----------|
| 31444 | 118 ml | PVC Flexible Clear Cement | 038753314440 | 24 |
| 31445 | 237 ml | PVC Flexible Clear Cement | 038753314457 | 24 |
| 31758 | 473 ml | PVC Flexible Clear Cement | 038753317588 | 24 |
| 31475 | 946 ml | PVC Flexible Clear Cement | 038753314754 | 12 |

CPVC SOLVENT CEMENTS

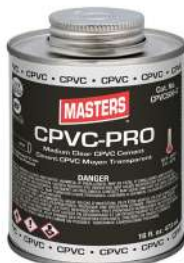

MASTERS® CPVC-PRO Medium Bodied Clear CPVC Solvent Cement

- Ideal for joining CPVC pipe and fittings up to 6" in diameter with interference fit.
- Low VOC and meets South Coast Quality Management District (SCAQMD) 1168/316A or BAAQMD Method 40 requirements, as well as ASTM F493.
- Recommended for use on potable water, pressure pipe, conduit or DWV.

| Product No. | Size | Description | UPC | Ctn. Qty. |
|-------------|--------|--|--------------|-----------|
| CPVC500-C | 473 ml | MASTERS® CPVC-PRO Clear Solvent Cement | 067001022578 | 24 |



Oatey® All Weather CPVC FlowGuard Gold®* 1-Step Yellow Cement

- For copper tube size (CTS) CPVC hot and cold potable water pipe and fittings up to 2" diameter interference fit.
- Lo-V.O.C. Solvent Cement meets California South Coast Air Quality Management District (SCAQMD) 1168/316A or BAAQMD Method 40 and various environmental requirements.
- For cold water systems and hot water systems up to 200°F / 93°C.
- May be used without primer where local coders permit.
- Recommended application temperature 0°F to 110°F / -18°C to 43°C.
- Meets ASTM F493.

| Product No. | Size | Description | UPC | Ctn. Qty. |
|-------------|--------|------------------------------------|--------------|-----------|
| 31448 | 237 ml | CPVC Flowguard Gold® 1-Step Yellow | 038753314488 | 24 |
| 31547 | 473 ml | CPVC Flowguard Gold® 1-Step Yellow | 038753315478 | 24 |

*FlowGuard Gold is a registered trademark of The Lubrizol Corporation.



Oatey® CPVC Heavy Duty Orange Solvent Cement

- Heavy-bodied orange cement for use on all schedules and classes of CPVC pipe and fittings up to 12" diameter with interference fit.
- Lo-V.O.C. Solvent Cement meets California South Coast Air Quality Management District (SCAQMD) 1168/316A or BAAQMD Method 40 and various environmental requirements.
- For Commercial hot and cold water systems up to 200°F / 93°C.
- Recommended application temperature 40°F to 110°F / 4°C to 43°C.
- Approved for Corzan® CPVC Piping Systems.
- Meets ASTM F493 and ASTM D2846.

*Corzan is a registered trademark of The Lubrizol Corporation.

| Product No. | Size | Description | UPC | Ctn. Qty. |
|-------------|--------|------------------------|--------------|-----------|
| 31776 | 473 ml | CPVC Heavy Duty Orange | 038753317762 | 24 |
| 31777 | 946 ml | CPVC Heavy Duty Orange | 038753317779 | 12 |



Oatey® CPVC Medium Clear Cement

- Medium-bodied clear coloured cement for use on CPVC pipe and fittings. Up to 6" diameter.
- Lo-V.O.C. Solvent Cement meets SCAQMD 1168 / 316A or BAAQMD Method 40 and various environmental requirements.
- Recommended application temperature 40°F to 110°F / 4°C to 38°C.
- Meets ASTM F493.
- For C.T.S. (copper tube size) and Sch. 80, potable water pressure pipe.

| Product No. | Size | Description | UPC | Ctn. Qty. |
|-------------|--------|--------------------------|--------------|-----------|
| 31515 | 118 ml | CPVC Medium Clear Cement | 038753315157 | 24 |
| 31516 | 237 ml | CPVC Medium Clear Cement | 038753315164 | 24 |
| 31517 | 473 ml | CPVC Medium Clear Cement | 038753315171 | 24 |



Oatey® CPVC Heavy Duty Gray Cement

- Heavy-bodied gray cement for use on all schedules and classes of CPVC pipe and fittings up to 12" diameter with interference fit.
- Lo-V.O.C. Solvent Cement meets California South Coast Air Quality Management District (SCAQMD) 1168/316A or BAAQMD Method 40 and various environmental requirements.
- For Commercial hot and cold water systems up to 200°F / 93°C.
- Recommended application temperature 40°F to 110°F / 4°C to 43°C.
- Approved for Corzan® CPVC Piping Systems.
- Meets ASTM F493 and ASTM D2846.

*Corzan is a registered trademark of The Lubrizol Corporation.

| Product No. | Size | Description | UPC | Ctn. Qty. |
|-------------|--------|----------------------|--------------|-----------|
| 31775 | 473 ml | CPVC Heavy Duty Gray | 038753317755 | 24 |
| 31466 | 946 ml | CPVC Heavy Duty Gray | 038753314662 | 12 |



Oatey® EP42 CPVC HD Gray Industrial Cement

- Heavy-bodied industrial gray solvent cement specifically designed for use on PVC and CPVC piping systems requiring chemical resistance to caustics including hypochlorite, mineral acids and aqueous salt solutions.
- For Schedules 40 and 80 CPVC and PVC up to 12" diameter, as well as other classes and schedules with interference fit.
- Resistant to caustics and hypochlorites up to 15 percent solution. Refer to EP 42 Chemical Resistance Chart for compatibility prior to using with chemical solutions.
- For use with all CPVC materials including Corzan® Industrial Piping Systems.
- Ultra violet indicator allows for quick and easy inspection of dry fit joints with any UV light source.
- Recommended application temperature 40°F to 110°F / 4°C to 43°C.
- Complies with various environmental requirements and SCAQMD Rule 1168/316A or BAAQMD Method 40 for VOC.
- Two year shelf life.
- Meets and exceeds ASTM F493.

| Product No. | Size | Description | UPC | Ctn. Qty. |
|-------------|--------|-------------------------------------|--------------|-----------|
| 31781 | 473 ml | EP42 CPVC HD Gray Industrial Cement | 038753317816 | 24 |
| 31459 | 946 ml | EP42 CPVC HD Gray Industrial Cement | 038753303291 | 12 |
| 31782 | 3.78 L | EP42 CPVC HD Gray Industrial Cement | 038753317823 | 6 |



MASTERS® TRANSITION-PRO PVC to ABS White Transition Cement

- Ideal for joining PVC to ABS in non-pressure transition joints up to 6" in diameter.
- Low VOC and meets South Coast Quality Management District (SCAQMD) 1168/316A or BAAQMD Method 40 requirements, as well as ASTM D-3138.

| Product No. | Size | Description | UPC | Ctn. Qty. |
|-------------|--------|---|--------------|-----------|
| TR500-W | 473 ml | MASTERS® Transition-Pro PVC to ABS White Cement | 067001022486 | 24 |



Oatey® ABS To PVC Transition White Cement

- Medium-Bodied white coloured cement for use in joining ABS to PVC in non-pressure transition joints up to 6" diameter.
- Lo-V.O.C. Solvent Cement meets California South Coast Air Quality Management District (SCAQMD) 1168/316A or BAAQMD Method 40 and various environmental requirements.
- Recommended application temperature 40°F to 110°F / 4°C to 43°C.
- Meets ASTM D3138.

| Product No. | Size | Description | UPC | Ctn. Qty. |
|-------------|--------|------------------------------------|--------------|-----------|
| 31532 | 118 ml | ABS To PVC Transition White Cement | 038753315324 | 24 |
| 31531 | 237 ml | ABS To PVC Transition White Cement | 038753315317 | 24 |
| 31530 | 473 ml | ABS To PVC Transition White Cement | 038753315300 | 24 |

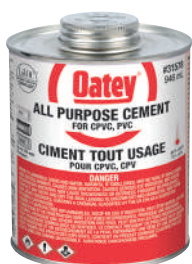

Oatey® All Purpose Cement

- Medium-bodied milky-clear cement for use on all schedules and classes of ABS, PVC and CPVC pipe and fittings up to 6" diameter with interference fit.
- Lo-V.O.C. Solvent Cement meets California South Coast Air Quality Management District (SCAQMD) 1168/316A or BAAQMD Method 40 and various environmental requirements.
- Recommended for potable water, pressure pipe, conduit and DWV.
- Recommended application temperature 40°F to 110°F / 4°C to 43°C.
- Meets performance requirements of ASTM D2564, D-2235, F-493.
- Always check local codes for acceptability of this product.

| Product No. | Size | Description | UPC | Ctn. Qty. |
|-------------|--------|--------------------|--------------|-----------|
| 31575 | 118 ml | All Purpose Cement | 038753315751 | 24 |
| 31576 | 237 ml | All Purpose Cement | 038753315768 | 24 |
| 31577 | 473 ml | All Purpose Cement | 038753315775 | 24 |
| 31578 | 946 ml | All Purpose Cement | 038753315782 | 12 |





MASTERS® PRIMER-PRO Purple Primer – NSF Listed

- Aggressive purple primer for use on PVC and CPVC pipe and fittings.
- Low VOC and meets South Coast Quality Management District (SCAQMD) 1168/316A or BAAQMD Method 40, as well as ASTM F656.
- Removes surface dirt, grease and grime as well as softens the pipe and fitting to allow a fast, secure solvent weld.
- For use in areas where plumbing code calls for verification that a primer has been used.
- NSF and IAPMO Listed.

| Product No. | Size | Description | UPC | Ctn. Qty. |
|-------------|--------|-----------------------------------|--------------|-----------|
| PR250-P | 237 ml | MASTERS® Primer-Pro Purple Primer | 067001022530 | 24 |
| PR500-P | 473 ml | MASTERS® Primer-Pro Purple Primer | 067001022547 | 24 |
| PR1L-P | 936 ml | MASTERS® Primer-Pro Purple Primer | 067001022554 | 12 |
| PR4L-P | 3.78 L | MASTERS® Primer-Pro Purple Primer | 067001022561 | 6 |



MASTERS® PRIMER-PRO Clear Primer – NSF Listed

- Clear aggressive primer for use on PVC and CPVC pipe and fittings.
- Low VOC and meets South Coast Quality Management District (SCAQMD) 1168/316A or BAAQMD Method 40, as well as ASTM F656.
- Removes surface dirt, grease and grime as well as softens the pipe surface to allow a fast, secure solvent weld.
- For use in areas where plumbing code calls for verification that a primer has been used.
- NSF and IAPMO listed.

| Product No. | Size | Description | UPC | Ctn. Qty. |
|-------------|--------|----------------------------------|--------------|-----------|
| PR250-C | 237 ml | MASTERS® Primer-Pro Clear Primer | 067001022493 | 24 |
| PR500-C | 473 ml | MASTERS® Primer-Pro Clear Primer | 067001022509 | 24 |
| PR1L-C | 946 ml | MASTERS® Primer-Pro Clear Primer | 067001022516 | 12 |
| PR4L-C | 3.78 L | MASTERS® Primer-Pro Clear Primer | 067001022523 | 6 |



Oatey® Industrial Grade Purple Primer – NSF Listed

- Very Aggressive Purple-tinted primer for use on CPVC pipe and fittings.
- Lo-V.O.C. Solvent Cement meets California South Coast Air Quality Management District (SCAQMD) 1168/316A or BAAQMD Method 40 and various environmental requirements.
- Recommended for Commercial and Large diameter thermoplastic piping systems, specifically CPVC Sch. 40 / 80.
- Ideal for use in cold weather applications.
- Removes surface dirt, grease and grime as well as softens the pipe surface to allow a fast, secure solvent weld.
- For use in areas where plumbing code calls for verification that a primer has been used.
- NSF and IAPMO Listed.
- Meets ASTM F656.

| Product No. | Size | Description | UPC | Ctn. Qty. |
|-------------|--------|----------------------------------|--------------|-----------|
| 31764 | 473 ml | Purple Primer – Industrial Grade | 038753317649 | 24 |
| 31765 | 946 ml | Purple Primer – Industrial Grade | 038753317656 | 12 |
| 31766 | 3.78 L | Purple Primer – Industrial Grade | 038753317663 | 6 |



Oatey® Industrial Grade Clear Primer – NSF Listed

- Very Aggressive Clear primer for use on PVC and CPVC pipe and fittings.
- Lo-V.O.C. Solvent Cement meets California South Coast Air Quality Management District (SCAQMD) 1168/316A or BAAQMD Method 40 and various environmental requirements.
- Recommended for Commercial and Large diameter thermoplastic piping systems, specifically CPVC Sch. 40 / 80.
- Ideal for use in cold weather applications.
- Removes surface dirt, grease and grime as well as softens the pipe surface to allow a fast, secure solvent weld.
- NSF Listed.
- Meets ASTM F656.

| Product No. | Size | Description | UPC | Ctn. Qty. |
|-------------|---------|---------------------------------|--------------|-----------|
| 31760 | 473 ml | Clear Primer – Industrial Grade | 038753317601 | 24 |
| 31761 | 946 ml | Clear Primer – Industrial Grade | 038753317618 | 12 |
| 31762 | 3.78 ml | Clear Primer – Industrial Grade | 038753317625 | 6 |



Oatey® Clear Primer – NSF Listed

- Clear aggressive primer for use on PVC and CPVC pipe and fittings.
- Lo-V.O.C. Solvent Cement meets California South Coast Air Quality Management District (SCAQMD) 1168/316A or BAAQMD Method 40 and various environmental requirements.
- Removes surface dirt, grease and grime as well as softens the pipe surface to allow a fast, secure solvent weld.
- NSF listed.
- Meets ASTM F656.

| Product No. | Size | Description | UPC | Ctn. Qty. |
|-------------|--------|--------------|--------------|-----------|
| 31525 | 118 ml | Clear Primer | 038753315256 | 24 |
| 31526 | 237 ml | Clear Primer | 038753315263 | 24 |
| 31527 | 473 ml | Clear Primer | 038753315270 | 24 |
| 31528 | 946 ml | Clear Primer | 038753315287 | 12 |
| 31461 | 3.78 L | Clear Primer | 038753307541 | 6 |



Oatey® Purple Primer – NSF Listed

- Purple-tinted aggressive primer for use on PVC and CPVC pipe and fittings.
- Lo-V.O.C. Primer meets California South Coast Air Quality Management District (SCAQMD) 1168/316A or BAAQMD Method 40 and various environmental requirements.
- Removes surface dirt, grease and grime as well as softens the pipe surface to allow a fast, secure solvent weld.
- For use in areas where plumbing code calls for verification that a primer has been used.
- NSF Listed.
- Meets ASTM F656.

| Product No. | Size | Description | UPC | Ctn. Qty. |
|-------------|--------|--------------------------------|--------------|-----------|
| 31480 | 118 ml | Purple Primer – NSF Listed | 038753314808 | 24 |
| 31481 | 237 ml | Purple Primer – NSF Listed | 038753314815 | 24 |
| 31482 | 473 ml | Purple Primer – NSF Listed | 038753314822 | 24 |
| 31483 | 946 ml | Purple Primer – NSF Listed | 038753314839 | 12 |
| 31462 | 3.78 L | Purple Primer – Wide Mouth Can | 038753307596 | 6 |



Oatey® Purple Primer/Cleaner

- Purple-tinted all purpose primer/cleaner for PVC and CPVC pipe and fittings.
- Meets California South Coast Air Quality Management District (SCAQMD) 1171/M24 or BAAQMD Method 40 and various environmental requirements.
- Less aggressive than clear primer and purple primer.
- Removes surface dirt, grease and grime for preparation before solvent cementing.
- Always check local codes for acceptability of this product.

| Product No. | Size | Description | UPC | Ctn. Qty. |
|-------------|--------|-----------------------|--------------|-----------|
| 31585 | 118 ml | Purple Primer/Cleaner | 038753315850 | 24 |
| 31586 | 237 ml | Purple Primer/Cleaner | 038753315867 | 24 |
| 31587 | 473 ml | Purple Primer/Cleaner | 038753315874 | 24 |
| 31588 | 946 ml | Purple Primer/Cleaner | 038753315881 | 12 |
| 31589 | 3.78 L | Purple Primer/Cleaner | 038753315898 | 6 |



Oatey® Clear Cleaner

- Clear Cleaner for ABS, PVC and CPVC pipe and fittings.
- Lo-V.O.C. Solvent Cement meets (SCAQMD) 1171/M24 or BAAQMD Method 40 and various environmental requirements.
- All schedules and all diameters.
- Flows freely and evaporates quickly.
- Fast acting cleaner removes surface dirt, grease and grime.

| Product No. | Size | Description | UPC | Ctn. Qty. |
|-------------|--------|--------------------------------|--------------|-----------|
| 31520 | 118 ml | Clear Cleaner | 038753315201 | 24 |
| 31521 | 237 ml | Clear Cleaner | 038753315218 | 24 |
| 31522 | 473 ml | Clear Cleaner | 038753315225 | 24 |
| 31523 | 946 ml | Clear Cleaner | 038753315232 | 12 |
| 31767 | 3.78 L | Clear Cleaner – Wide Mouth Can | 038753317670 | 6 |

ACCESSORIES



Oatey® Solvent Cement And Primer Accessories

- Standard replacement daubers specifically sized for 4 oz., 8 oz., 16 oz. and 32 oz. cement/primer cans.
- Brush applicator for 16 & 32 oz. cans.
- Standard replacement cans.

| Product No. | Size | Description | UPC | Ctn. Qty. |
|-------------|------------|--|--------------|-----------|
| 31299 | 118 ml | Dauber 3/4" | 038753312996 | 48 |
| 31309 | 237 ml | Dauber 3/4" | 038753313092 | 48 |
| 31310 | 473 ml | Dauber 1-1/2" | 038753313108 | 48 |
| 31312 | 946 ml | Dauber 1-1/2" | 038753313122 | 48 |
| 31313 | 473/946 ml | Dauber For CPVC Cement 3/4" | 038753313139 | 48 |
| 31257 | 473/946 ml | Brush Top Dauber 1-1/2" Length | 038753312576 | 50 |
| 31275 | 300 mm | Gallon Can Roller Applicator – Fits Wide And Standard Mouth Size | 038753312750 | 12 |
| 31276 | 300 mm | Gallon Can Swab Applicator – Fits Wide And Standard Mouth Size | 038753312767 | 12 |
| 31304 | 118 ml | Cement Can | 038753313047 | 24 |
| 31305 | 237 ml | Cement Can | 038753313054 | 24 |
| 31306 | 473 ml | Cement Can | 038753313061 | 24 |
| 31307 | 946 ml | Cement Can | 038753313078 | 12 |
| 30901 | 3.78 L | Wide Mouth Can | 038753309019 | 6 |



MASTERS® Brush-In-Can

- Reusable HDPE container with brush

| Product No. | Size | Description | UPC | Ctn. Qty. |
|-------------|--------|-----------------------------|--------------|-----------|
| BIC500 | 500 mL | Empty 500 mL can with brush | 067001022585 | 12 |
| BIC1L | 1 L | Empty 1L can with brush | 067001022592 | 12 |



Oatey® Adjustable Daubers

- For applying solvent cement and primers.
- Fits can sizes 236 ml to 946 ml.
- Specially constructed easy open, easy close sealing controls evaporation of solvents and prevents spillage.
- Dauber is unbreakable.
- Designed to adjust to various can dimensions and allows application of the proper amount of cement to ensure a good solvent weld.

| Product No. | Size | Description | UPC | Ctn. Qty. |
|-------------|------|--|--------------|-----------|
| 31300 | 1/2" | Adjustable Plastic Dauber w/ 1/2" Ball | 038753313009 | 100 |
| 31301 | 1" | Adjustable Plastic Dauber w/ 1" Ball | 038753313016 | 100 |
| 31302 | 1" | Adjustable Plastic Dauber w/ 1" Ball | 038753313023 | 50 |



Oatey® Cement Carrier

- Designed to make it easier to keep cement and cleaner ready for use on the job.
- Caddy holds two 946 ml cans.
- Patented.

| Product No. | Size | Description | UPC | Ctn. Qty. |
|-------------|------------|----------------|--------------|-----------|
| 31250 | 946 ml can | Cement Carrier | 038753312507 | 12 |



MASTERS® Utility Brush

- Multi-purpose pure bristle brush.

| Product No. | Size | Description | UPC | Ctn. Qty. |
|-------------|------|-----------------------|--------------|-----------|
| UB100 | 1" | MASTERS Utility Brush | 067001000712 | 20 |
| UB200 | 2" | MASTERS Utility Brush | 035162002333 | 24 |



HOW TO SOLVENT WELD



Pipe Types

CPVC: Chlorinated Polyvinyl Chloride – Typically used for pressure piping applications, including hot and cold potable water distribution. Can also be used for corrosive fluid handling in industrial or chemical applications.

ABS: Acrylonitrile Butadiene Styrene – Typically used for non-pressure piping applications.

PVC: Polyvinyl Chloride – Typically used for pressure or non-pressure piping applications.

Solvent Cements for any Application

If you need to solvent weld one pipe joint or one thousand, Oatey® is the solvent cement more professionals choose than any other brand. From hot to cold, wet to dry, Oatey has the solvent cement to meet your exact requirement for any plastic pipe installation.

Solvent Cement Cure Times

The cure time of solvent cements is dependent on several factors. The pipe size, socket fit, ambient temperature, relative humidity, solvent cements and the system operating pressure should all be considered when determining cure times.

Oatey continues to work hard to provide you peace of mind and confidence when using Oatey brand solvent cements and products.

Cure chart see page 18

How To Solvent Weld

PRIOR TO USE: Read all product labels carefully.

Stir or shake cement before using. If jelly-like, do not use. Keep container closed when not in use. Avoid eye and skin contact. Wear safety glasses with side shields and wear rubber gloves.

1. Square pipe ends, chamfer and remove all dirt.
2. Check dry fit of pipe and fitting. Pipe should easily go 1/3 of the way into the fitting. If pipe bottoms, it should be snug.
3. Use a suitable applicator at least 1/2 the size of the pipe diameter. For larger size pipe systems use a natural bristle brush or roller.
4. Clean pipe and fitting with a listed primer. (Do not use primer on ABS pipe and fittings. Use Clear Cleaner only!)
5. Apply liberal coat of cement to pipe to the depth of the socket, leave no uncoated surface.
6. Apply a thin coat of cement to inside of fitting, avoid puddling of cement. Puddling can cause weakening and premature failure of pipe or fitting. Apply a second coat of cement to the pipe.
7. Assemble parts QUICKLY. Cement must be fluid. If cement surface has dried, recoat both parts.
8. Push pipe FULLY into fitting using a 1/4 turning motion until pipe bottoms.
9. Hold pipe and fitting together for 30 seconds to prevent pipe push-out – longer at low temperatures. Wipe off excess.
10. Allow 15 minutes for good handling strength and 2 hours cure time at temperatures above 60°F (15.5°C) before pressure testing up to 180 psi. Longer cure times may be required at temperatures below 60°F (15.5°C) or with pipe above 3". **Testing a plumbing system with air, regardless of the type of solvent cement used, is dangerous and not recommended.** For specialty cements and chemical applications, please see specific product label instructions.

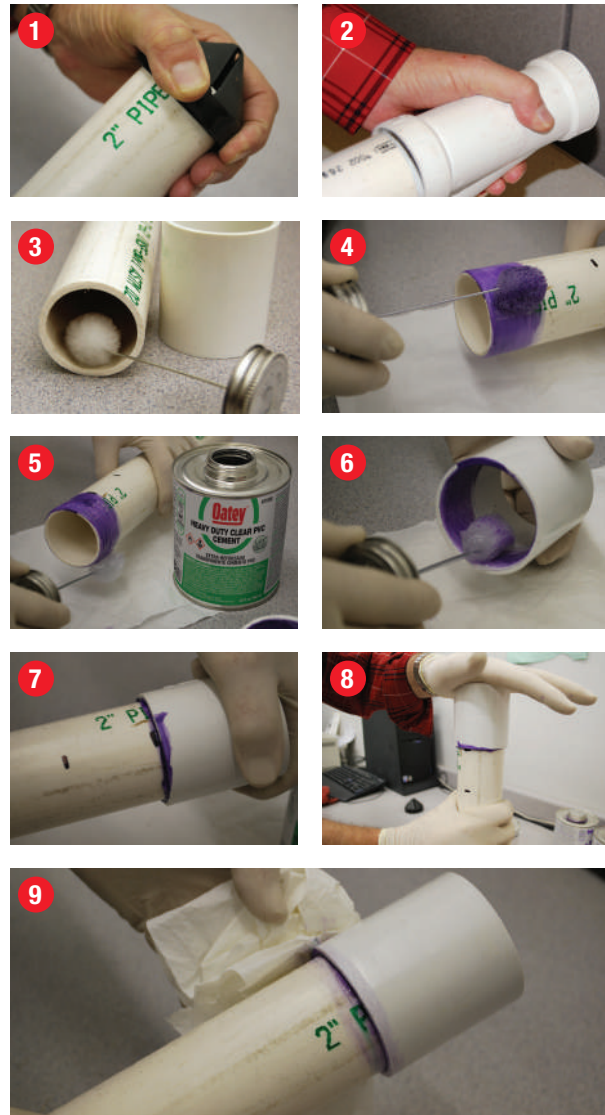

SET UP/CURING TIMES

The set up/cure time is dependent on several factors. The pipe size, socket fit, ambient temperature, relative humidity, solvent cement used and the system operating pressure should all be considered when determining set up/cure times.

PVC & ABS

| Pipe Diameter | Temperature during assembly and cure period | | | |
|-------------------------------------|---|---------------------|---------------------|-----------------------|
| | 60°-100°F 16°-38°C | 40°-60°F 4°-16°C | 20°-40°F -7°-4°C | 0°-20°F -18°- -7°C |
| 1/2" to 1-1/4" 13 to 32mm | 2 min | 5 min | 8 min | 10 min |
| 1-1/2" to 3" 40 to 80mm | 5 min | 10 min | 12 min | 15 min |
| 4" to 5" 100 to 125mm | 15 min | 30 min | 60 min | 2 hrs |
| 6" to 8" 150 to 200mm | 30 min | 90 min | 3 hrs | 6 hrs |

Average Handling/Set Up Times for PVC/CPVC Solvent Cements

Handling/Set Up Time is the time required prior to handling the joint. In damp or humid weather, allow 50% additional time.

These figures should only be used as a general guide. Conditions in the field may vary.

Contact Oatey Technical Services for set up times for pipe larger than 8" diameter.

| Pipe Diameter | 1/2" | 3/4" | 1" | 1-1/4" | 1-1/2" | 2" | 3" | 4" | 6" | 8" |
|------------------|------|------|-----|--------|--------|----|----|----|----|----|
| Number Of Joints | 325 | 250 | 150 | 125 | 90 | 70 | 50 | 30 | 10 | 8 |

Average Number of Joints Per Quart of Solvent Cement

These figures are estimates based on laboratory testing. Conditions in the field may vary.

PVC & ABS

| Pipe Diameter | | Temperature during assembly and cure period | | | |
|-------------------------------------|---------------|---|---------------------|---------------------|---|
| | | 60°-100°F 16°-38°C | 40°-60°F 4°-16°C | 20°-40°F -7°-4°C | 0°-20°F -18°- -7°C |
| 1/2" to 1-1/4" 13 to 32mm | Up to 180 psi | 15 min | 20 min | 30 min | Please contact Oatey Technical Services for cure time information |
| | 180 psi + | 4 hrs | 8 hrs | 36 hrs | |
| 1-1/2" to 3" 40 to 80mm | Up to 180 psi | 30 min | 45 min | 60 min | |
| | 180 psi + | 8 hrs | 16 hrs | 72 hrs | |
| 4" to 5" 100 to 125mm | Up to 180 psi | 2 hrs | 4 hrs | 36 hrs | |
| | 180 psi + | 12 hrs | 24 hrs | 4 days | |
| 6" to 8" 150 to 200mm | Up to 180 psi | 8 hrs | 16 hrs | 3 days | |
| | 180 psi + | 24 hrs | 48 hrs | 9 days | |

Average Joint Cure Times for PVC/CPVC Solvent Cements

Joint cure time is the time required before pressure testing the system. In damp or humid weather allow 50% additional cure time.

Contact Oatey Technical Services for cure times for pipe larger than 8" diameter.

This data is applicable only for new piping installations and not recommended for repair or cut-ins on hot and cold water distribution systems. Please contact Oatey Technical Service for recommendations on Cure Times for such applications.

DO NOT test PVC and CPVC piping systems with compressed air or gas.

Notes: Cure schedule is the time required before pressure testing the system

- This chart can be used as a guideline to determine joint cure
- Cure times stated are for conditions with relative humidity of 60% or less
- + In damp or humid weather allow 50% additional cure time

CPVC

| Pipe Diameter | | Temperature during assembly and cure period | | | |
|-------------------------------------|---------------|---|---------------------|---|-----------------------|
| | | 60°-100°F 16°-38°C | 40°-60°F 4°-16°C | 20°-40°F -7°-4°C | 0°-20°F -18°- -7°C |
| 1/2" to 1-1/4" 13 to 32mm | Up to 180 psi | 1 hr | 2 hrs | Please contact Oatey Technical Services for cure time information | |
| | 180 psi + | 6 hrs | 12 hrs | | |
| 1-1/2" to 3" 40 to 80mm | Up to 180 psi | 2 hrs | 4 hrs | | |
| | 180 psi + | 12 hrs | 24 hrs | | |
| 4" to 5" 100 to 125mm | Up to 180 psi | 6 hrs | 12 hrs | | |
| | 180 psi + | 18 hrs | 36 hrs | | |
| 6" to 8" 150 to 200mm | Up to 180 psi | 8 hrs | 16 hrs | | |
| | 180 psi + | 24 hrs | 48 hrs | | |



Category 2

Thread Sealants and Leak Detectors

When it comes to Thread Sealants, nobody does it better than Masters®, Oatey® and Hercules®. Together we have formulated and manufactured thread sealants for more than 150 years. We continuously respond to professional plumbers' changing needs with new technology, new ideas, and new products. From low-pressure to high-pressure piping demands, from plastics to metals, as well as the market's need for PTFE – we lead the industry with Thread Sealants and Pipe Joint Compounds that provide solutions.

CATEGORY 2 THREAD SEALANTS AND LEAK DETECTORS

PIPE THREAD SEALANT CERTIFICATION OVERVIEW

CATEGORY 2 THREAD SEALANTS AND LEAK DETECTORS

CERTIFICATIONS

| PRODUCT | NATURAL GAS | | SANITATION | | ECO | | COMPATIBILITY | | |
|------------------------|-------------|-----|------------|------|---------|------|---------------|---------|-----|
| | ULC | CSA | NSF | CFIA | LOW VOC | LEED | METALS | PLASTIC | FBC |
| PRO-DOPE® | ✓ | | ✓ | ✓ | ✓ | ✓ | ✓ | ✓ | |
| METALLIC COMPOUND™ | ✓ | | | | ✓ | | ✓ | ✓ | |
| PRO-BLUE® | ✓ | | ✓ | | ✓ | ✓ | ✓ | ✓ | |
| NON-METALLIC COMPOUND™ | ✓ | | | ✓ | ✓ | | ✓ | ✓ | |
| A-PLUS® | ✓ | | | ✓ | ✓ | | ✓ | | |
| MEGALOC® | | ✓ | ✓ | | ✓ | | ✓ | ✓ | |
| GREAT WHITE® | | | ✓ | | ✓ | | ✓ | ✓ | ✓ |





MASTERS® Pro-Dope Pipe Thread Sealant

- PTFE pipe thread sealant
- Effectively seals both metal and plastic threaded connections against leaks of most liquids and gases* up to 10,000 psi
- Will not dry out, stain, harden or separate
- Lubricates during assembly and disassembles easily even after years of service
- ULC Listed for Natural Gas (CAN/ULC - S642) and NSF/ANSI 61G/372 listed for potable water
- MAS Green Certified
- Low VOC
- CFIA Letter of No Objection Available

| Product No. | Size | Description | UPC | Ctn. Qty. |
|-------------|--------|--|--------------|-----------|
| PD250BT | 250 ml | Pro-Dope Pipe Thread Sealant Brush Top Can | 067001000071 | 25 |
| PD500BT | 500 ml | Pro-Dope Pipe Thread Sealant Brush Top Can | 067001000170 | 12 |
| PD1L | 1 L | Pro-Dope Pipe Thread Sealant Flat Top Can | 067001000408 | 4 |
| PD20L | 20 L | MASTERS Pro-Dope Pipe Thread Sealant Pail | 067001000422 | 1 |



MASTERS® Pro-Blue Pipe Thread Sealant

- PTFE pipe thread sealant
- Effectively seals both metal and plastic threaded connections against leaks of most liquids and gases* up to 10,000 psi
- Will not dry out, stain, harden or separate
- Lubricates during assembly and disassembles easily even after years of service
- ULC Listed for Natural Gas ((CAN/ULC - S642) and NSF/ANSI 61G/372 listed for potable water
- MAS Green certified
- Low VOC

| Product No. | Size | Description | UPC | Ctn. Qty. |
|-------------|--------|--|--------------|-----------|
| PB250BT | 250 ml | MASTERS Pro-Blue Pipe Thread Sealant Brush Top Can | 067001001504 | 25 |
| PB500BT | 500 ml | MASTERS Pro-Blue Pipe Thread Sealant Brush Top Can | 067001001511 | 12 |
| NM20L | 20 L | MASTERS Non-Metallic Pipe Thread Sealant Pail | 067001000392 | 1 |



MASTERS® Non-Metallic Pipe Thread Sealant

- General purpose pipe thread sealant
- Effectively seals both metal and plastic threaded connections against leaks of most liquids and gases* at commonly used temperatures and pressures
- All weather, non-corrosive product contains no metal so it is not a conductor of electricity
- Lubricates during assembly, will not harden or separate and disassembles easily even after years of service
- ULC Listed for Natural Gas (CAN/ULC - S642)
- Low VOC
- CFIA Letter of No Objection available

| Product No. | Size | Description | UPC | Ctn. Qty. |
|-------------|--------|--|--------------|-----------|
| NM250BT | 250 ml | MASTERS Non-Metallic Pipe Thread Sealant Brush Top Can | 067001000217 | 25 |
| NM1L | 1 L | MASTERS Non-Metallic Pipe Thread Sealant Flat Top Can | 067001000378 | 4 |
| NM20L | 20 L | MASTERS Non-Metallic Pipe Thread Sealant Pail | 067001000392 | 1 |



MASTERS® Metallic Pipe Thread Sealant

- Heavy-duty pipe thread sealant
- Effectively seals both metal and plastic threaded connections against leaks of most liquids and gases* up to 6,000 psi
- Will not dry out, harden or separate
- Lubricates during assembly and disassembles easily even after years of service
- ULC Listed for Natural Gas (CAN/ULC-S642)
- Low VOC

| Product No. | Size | Description | UPC | Ctn. Qty. |
|-------------|--------|---|--------------|-----------|
| CP250BT | 250 ml | MASTERS Pipe Thread Sealant Brush Top Can | 067001000347 | 25 |
| CP1L | 1 L | MASTERS Pipe Thread Sealant Flat Top Can | 067001000354 | 4 |



Hercules™ Megaloc®

- Made with DuPont™ Kevlar®.
- Wipes easily from hands and tools with dry rag; grit-free.
- No odor - Soft setting - Non Flammable.
- High performing thread sealant for use on metal or plastic pipe - including ABS.
- Safe for potable water lines, approved for use with natural gas and LP gases.
- Withstands hydraulic pressure to 12,000 psi and gas pressure to 2600 psi at temperatures from -50° to +400°F (-46 to 204°C) (on steel pipe).

| Product No. | Size | Description | UPC | Ctn. Qty. |
|-------------|--------|---|--------------|-----------|
| 15820 | 29 ml | Megaloc Thread Sealant – Squeeze Tube | 032628158207 | 24 |
| 15821 | 118 ml | Megaloc Thread Sealant – Screw Cap With Brush | 032628158214 | 24 |
| 158069 | 237 ml | Megaloc Thread Sealant – Screw Cap With Brush | 032628958067 | 24 |
| 158089 | 473 ml | Megaloc Thread Sealant – Screw Cap With Brush | 032628958081 | 12 |
| 158119 | 946 ml | Megaloc Thread Sealant – Screw Cap With Brush | 032628958111 | 12 |



Oatey® Great White™ Pipe Joint Compound with PTFE

- Lubricates and seals all threaded joints
- White, non-hardening, non-separating, non-toxic paste
- Withstands up to 3,000 psi on gases from -50° to +400°F (-46 to 204°C), and 10,000 psi on liquids from -50° to +500°F (-46 to 260°C).
- For use with water, steam, caustics or dilute acid lines of PVC, CPVC, ABS, cyclocac, polypropylene, iron, steel, or copper
- Can be used on plastic or metal threads

| Product No. | Size | Description | UPC | Ctn. Qty. |
|-------------|--------|--|--------------|-----------|
| 48007 | 29 ml | Great White Pipe Joint Compound w/PTFE | 038753480077 | 12 |
| 48008 | 118 ml | Great White Pipe Joint Compound w/PTFE | 038753480084 | 12 |
| 48009 | 237 ml | Great White Pipe Joint Compound w/PTFE | 038753480091 | 12 |



MASTERS® A-PLUS Anaerobic Pipe Thread Sealant

- General purpose anaerobic pipe thread sealant for sealing metal threads
- Superior sealing and locking properties especially effective where vibrations are prevalent, making it suitable for production lines
- Lubricates during assembly and hardens in threads, with excellent performance on stainless steel
- Seals moderate pressure almost instantly and up to 250 psi steam pressure in approximately 24 hours
- ULC Listed for Natural Gas (CAN/ULC-S642)
- CFIA letter of No Objection available
- Low VOC

| Product No. | Size | Description | UPC | Ctn. Qty. |
|-------------|--------|--|--------------|-----------|
| MAP250 | 250 ml | MASTERS A-PLUS Anaerobic Pipe Thread Sealant Sqze Tube | 067001001672 | 1 |



MASTERS® Orange **T**-Tape

- Non-corrosive, non-flammable, clean, easy to use premium quality thread sealing tape
- Because it is chemically inert, it seals all metal and plastic threaded connections against leakage of virtually everything at temperatures between -400°F & +600°F (-240°C & +316°C)
- Allows for easy disassembly of joints, even after years of service
- Meets MIL SPEC A-A-58092 (superseding T-27730A)
- For use on potable water systems
- ULC Listed for Natural Gas (CAN/ULC-S642)

| Product No. | Size | Description | UPC | Ctn. Qty. |
|-------------|---------------|---|--------------|-----------|
| ULC260 | 0.50" x 260" | MASTERS T-Tape Orange ULC Listed Roll | 067001000828 | 12 |
| ULC540 | 0.50" x 540" | MASTERS T-Tape Orange ULC Listed Roll | 067001000873 | 12 |
| ULC540V | 0.50" x 540" | MASTERS T-Tape Orange Bulk PK ULC Listed Roll | 067001000873 | 100 |
| ULC260V | 0.50" x 260" | MASTERS T-Tape Orange Bulk PK ULC Listed Roll | 067001000828 | 100 |
| ULC1296 | 0.50" x 1296" | MASTERS T-Tape Orange ULC Listed Roll | 067001000880 | 12 |
| ULC1296V | 0.50" x 1296" | MASTERS T-Tape Orange Bulk PK ULC Listed Roll | 067001000880 | 100 |
| TOC540 | 0.75" x 540" | MASTERS T-Tape Orange ULC Listed Roll | 067001000859 | 12 |



MASTERS® Orange **T**-Tape

- Non-corrosive, non-flammable, clean, easy to use premium quality thread sealing tape
- Because it is chemically inert, it seals all metal and plastic threaded connections against leakage of virtually everything at temperatures between -400°F & +600°F (-240°C & +316°C)
- Allows for easy disassembly of joints, even after years of service
- Meets MIL SPEC A-A-58092 (superseding T-27730A)
- For use on potable water systems

| Product No. | Size | Description | UPC | Ctn. Qty. |
|-------------|--------------|----------------------------|--------------|-----------|
| TOA260 | 0.25" x 260" | MASTERS T-Tape Orange Roll | 067001000811 | 12 |
| TOD540 | 1.00" x 540" | MASTERS T-Tape Orange Roll | 067001000866 | 12 |



MASTERS® Yellow **T**-Tape

- Non-corrosive, non-flammable, clean, easy to use gas seal tape
- Because it is chemically inert, it seals all metal and plastic threaded connections against leakage of virtually everything at temperatures between -400°F & +600°F (-240°C & +316°C)
- Allows for easy disassembly of joints, even after years of service
- Coloured yellow for easy identification during inspection
- Meets MIL SPEC A-A-58092 (superseding T-27730A)
- For use on potable water systems
- ULC Listed for Natural Gas (CAN/ULC-S642)

| Product No. | Size | Description | UPC | Ctn. Qty. |
|-------------|--------------|---|--------------|-----------|
| TYB480 | 0.50" x 480" | MASTERS T-Tape Yellow ULC Listed Roll | 067001000897 | 24 |
| TYB260V | 0.50" x 260" | MASTERS T-Tape Yellow Bulk PK ULC Listed | 067001000798 | 100 |
| TYB480V | 0.50" x 480" | MASTERS T-Tape Yellow Bulk PK ULC Listed Roll | 067001000897 | 100 |

THREAD SEALANTS AND LEAK DETECTORS



Hercules™ Megatape

- Use on any threaded pipe carrying dilute acids, compressed air, aliphatic solvents, dilute caustics, cutting oils, diesel fuel oil, hydraulic fluids, L.P. Gas, natural gas, petroleum solvents, steam, vegetable oils, water and more.
- High density gray tape, 3.5 mils thick.
- Recommended by professionals.
- Safe for use on stainless steel, cast iron, brass and chrome.
- ULC Listed for Natural Gas (CAN/ULC-S642)

| Product No. | Size | Description | UPC | Ctn. Qty. |
|-------------|--------------|--|--------------|-----------|
| 15050D | 1/2" x 260" | Megatape – Gray PTFE Tape, display box | 032628151901 | 120 |
| 15100 | 1/2" x 1000" | Megatape – Gray PTFE Tape, display box | 032628151918 | 63 |
| 15110 | 3/4" x 1000" | Megatape – Gray PTFE Tape, display box | 032628151925 | 45 |
| 15120 | 1" x 1000" | Megatape – Gray PTFE Tape, display box | 032628151932 | 36 |



Thompsons Industrial Pink Tape

- Seals all metal and plastic threaded connections against leakage at commonly used temperatures and pressures.
- Non-corrosive, non-flammable, clean, and easy to use. Joints disassemble easily, even after years of service.
- Impervious to virtually all chemicals and gases.

| Product No. | Size | Description | UPC | Ctn. Qty. |
|-------------|--------------------------------------|--------------------------------|--------------|-----------|
| TOIB1296V | 0.50" x 1296" (1.27 cm x 32.94 m) | THOMPSONS Industrial Tape Pink | 067001000989 | 100 |
| TOIB540V | 0.50" x 540" (1.27 cm x 13.72 m) | THOMPSONS Industrial Tape Pink | 067001000972 | 100 |



Oatey® Pink Water Line Thread Seal Tape With PTFE

- Provides fast positive seal for water lines, sewage lines and sprinkler systems.
- Effective on metal or plastic threads.
- High density, multi-purpose pink tape.
- Packaged on spools in a display carton.
- ULC Listed

| Product No. | Size | Description | UPC | Ctn. Qty. |
|-------------|-------------|--|--------------|-----------|
| 31402D | 1/2" x 260" | PTFE Pink Thread Seal Tape – Display Box | 038753314020 | 50 |



MASTERS® White Tape

- Non-corrosive, non-flammable, clean, easy to use thread sealing tape
- Because it is chemically inert, it seals all metal and plastic threaded connections against leakage of virtually everything at temperatures between -400°F & +600°F (-240°C & +316°C)
- Allows for easy disassembly of joints, even after years of service

| Product No. | Size | Description | UPC | Ctn. Qty. |
|-------------|--------------|----------------------------|--------------|-----------|
| TWB480G | 0.50" x 480" | MASTERS White Tape | 067001000941 | 200 |
| TWC480G | 0.75" x 480" | MASTERS White Tape | 067001000958 | 12 |
| TWB480P | 0.50" x 480" | MASTERS White Economy Tape | 067001000934 | 200 |



MASTERS® Leak Detector

- Bubble type non-freezing (to -35°F/-37°C) liquid quickly locates pin hole leaks even at low pressures
- Will detect leaks of various gases in appliances, air & gas lines, cylinders, pipe & fittings, pressure vessels, tanks, tubing and valves
- Not for use on oxygen systems
- Available in clear or pink liquid
- Non-corrosive

| Product No. | Size | Description | UPC | Ctn. Qty. |
|-------------|-----------|--|--------------|-----------|
| LD059 | 59 ml | MASTERS Leak Detector, Spray Bottle | 067001000590 | 20 |
| LD227HD | 227 ml HD | MASTERS Leak Detector, Dauber Top Bottle | 067001000125 | 20 |
| LD500 | 500 ml | MASTERS Leak Detector, Spray Bottle | 067001001658 | 12 |
| LD4L | 4 L | MASTERS Leak Detector, Jug | 067001000187 | 4 |
| LD20L | 20 L | MASTERS Leak Detector, Pail | 067001000521 | 1 |
| LD4LP | 4 L | MASTERS Pink Leak Detector, Jug | 067001001993 | 4 |
| LD20LP | 20 L | MASTERS Pink Leak Detector, Pail | 067001022264 | 1 |



#45802 shown



Hercules™ Megabubble® Leak Detector

- Detects even the smallest gas leaks.
- Produces long-lasting bubbles.
- Clings, even to vertical surfaces.
- Non-toxic, non-corrosive formula.
- Won't freeze.

| Product No. | Size | Description | UPC | Ctn. Qty. |
|-------------|--------|--|--------------|-----------|
| 45801 | 237 ml | Megabubble® – Leak Detector with Dauber | 032628458017 | 24 |
| 45804 | 473 ml | Megabubble® – Leak Detector with Sprayer | 032628458048 | 12 |
| 45802 | 946 ml | Megabubble® – Leak Detector with Sprayer | 032628458024 | 12 |
| 45803 | 3.78 L | Megabubble® – Leak Detector Jug | 032628458031 | 4 |



Category 3

Copper Installation

The best soldered joints come from the best cleaning and fluxing tools, as well as a careful and professional technique. Our solder, flux and cleaning tools are designed for the professional who takes pride in knowing just how to do the job right and chooses the highest quality products.

Application:



1. Assemble all material you will need.
2. Cut the copper pipe squarely using a tubing cutter or hacksaw.
3. Ream the pipe ends.
4. Clean copper fitting with manual or power fitting brush or sand grit cloth.
- 4.a) Avoid touching cleaned surface or leaving it exposed to air for a prolonged period of time.
5. Clean copper pipe/tubing with sand or grit cloth.
- 5.a) Avoid touching cleaned surface or leaving it exposed to air for a prolonged period of time.
6. Apply tinning or paste flux to the inside of the copper fitting and outside of the copper pipe.
7. Assemble the joint.
8. Heat the joint evenly, tapping wire solder against joint to check if it's hot enough to melt the solder. This indicates proper temperature has been reached.
9. Build up joint around perimeter of pipe/fitting. Remove heat and solder wire once a bead has formed around the fitting.
10. Allow the solder to cool before wiping away excess with a damp cloth.
- 10.a) It is a known practice to apply the flux to the last joint to help remove scorching marks. Be sure to wipe thoroughly afterwards to prevent future corrosion.

PLUMBING WIRE SOLDER



Oatey® 95/5 Lead Free Plumbing Wire Solder

- Lead Free Alloy of 95% Tin and 5% Antimony.
- 232°C - 240°C melting range.
- Meets the requirements of the U.S. Safe Drinking Water Act.
- Most commonly used where frequent and extreme temperature changes and vibrations occur.

| Product No. | Size | Description | Gauge | UPC | Ctn. Qty. |
|-------------|----------------|-------------------------|-------|--------------|-----------|
| 22004 | 1/2 lb / 226 g | 95/5 Wire Solder - Bulk | .117" | 038753220048 | 10 |
| 22017 | 1 lb / 453 g | 95/5 Wire Solder - Bulk | .117" | 038753220178 | 25 |



Oatey® Safe Flo® Lead Free Plumbing Wire Solder

- Copper, bismuth, tin and silver alloy.
- 215°C - 237°C melting range.
- Meets ASTM Standard B-32 and the requirements of the Safe Water Drinking Act.
- Formulated for plumbing/potable water line applications.

| Product No. | Size | Description | Gauge | UPC | Ctn. Qty. |
|-------------|-----------------|------------------------------|-------|--------------|-----------|
| 23000 | 1/2 lb / 226 g | Silver Lead Free Wire Solder | .117" | 038753230009 | 10 |
| 23001 | 1 lb / 453 g | Silver Lead Free Wire Solder | .117" | 038753230016 | 25 |
| 23002 | 5 lb / 2.267 kg | Silver Lead Free Wire Solder | .117" | 038753230023 | 10 |



Oatey® 97/3 Lead Free Plumbing Wire Solder

- Lead free alloy of 97% tin and 3% copper.
- 440°F - 572°F melting range.
- Meets the requirements of the Safe Drinking Water Act.
- Formulated for plumbing/potable water line applications.

| Product No. | Size | Description | Gauge | UPC | Ctn. Qty. |
|-------------|--------------|------------------------|-------|--------------|-----------|
| 20973 | 1 lb / 453 g | Copper/Tin Wire Solder | .117" | 038753209739 | 25 |

SPECIALTY WIRE SOLDER



Oatey® Wire Solder

- 50/50 Alloy of 50% Tin and 50% Lead.
- 182°C - 216°C melting range for 50/50 Alloy.
- Commonly used for tin plating, seaming joints, copper DWV systems and sheet metal repair.
- Contains lead. Not for use on drinking water lines.

| Product No. | Size | Description | Gauge | UPC | Ctn. Qty. |
|-------------|----------------|--------------------------|-------|--------------|-----------|
| 20019 | 1 lb / 453 g | 50/50 Wire Solder - Bulk | .125" | 038753200194 | 50 |
| 50192 | 1/2 lb / 226 g | 50/50 Wire Solder - Bulk | .125" | 038753501925 | 10 |



Oatey® Acid Core Wire Solder

- 40/60 Alloy of 40% Tin and 60% Lead.
- 50/50 Alloy of 50% Tin and 50% Lead.
- 182°C - 216°C melting range for 50/50 Alloy.
- 182°C - 237°C melting range for 40/60 Alloy.
- General purpose solder for repairing galvanized gutters, filling metal seams and other general repairs.
- Contains lead. Not for use on drinking water lines.

| Product No. | Size | Description | Gauge | UPC | Ctn. Qty. |
|-------------|----------------|------------------------------------|-------|--------------|-----------|
| 21115 | 1 lb / 453 g | 40/60 Acid Core Wire Solder - Bulk | .125" | 038753211152 | 10 |
| 50193 | 1/2 lb / 226 g | 40/60 Acid Core Wire Solder - Bulk | .081" | 038753501932 | 10 |

SPECIALTY WIRE SOLDER



Oatey® Rosin Core Wire Solder

- 40/60 Alloy of 40% Tin and 60% Lead.
- 182°C - 237°C melting range for 40/60 Alloy.
- Can be used for electrical applications including wiring and other fine electronic work.
- Contains lead. Not for use on drinking water lines.

| Product No. | Size | Description | Gauge | UPC | Ctn. Qty. |
|-------------|--------------|-------------------------|-------|--------------|-----------|
| 21212 | 1 lb / 453 g | 40/60 Rosin Core - Bulk | .125" | 038753212128 | 10 |



Oatey® Bar Solder

- 50/50 Alloy of 50% Tin and 50% Lead.
- 182°C - 237°C melting range.
- Contains lead. Not for use on drinking water lines.
- For use with copper drain piping, tin plating, seaming joints and sheet metal.

| Product No. | Size | Description | UPC | Ctn. Qty. |
|-------------|------------------|------------------------|--------------|-----------|
| 20307 | 1-1/4 lb / 566 g | 50% Tin / 50% Lead Bar | 038753203072 | 50 |
| 21305 | 1-1/4 lb / 566 g | 50% Tin / 50% Lead Bar | 038753213057 | 10 |

FLUX



MASTERS® All Condition Soldering Paste

- Petrolatum based paste for typical sweat soldering with excellent wetting properties that allow for smooth flow and reduced voiding
- Paste is lead-free and NSF61G listed for use on potable water systems
- Works well on frozen, cold and wet pipe

| Product No. | Size | Description | UPC | Ctn. Qty. |
|-------------|---------|--|--------------|-----------|
| SP057 | 57 g | MASTERS Soldering Paste, Jar | 067001000088 | 12 |
| SP227 | 227 g | MASTERS Soldering Paste, Brush Top Jar | 067001006211 | 24 |
| SP454 | 454 g | MASTERS Soldering Paste, Tub | 067001000118 | 12 |
| SP20L | 20 L | MASTERS Soldering Paste, Pail | 067001000156 | 1 |
| SP450 | 450 lbs | MASTERS Soldering Paste, Drum | 067001022271 | 1 |



MASTERS® Tinning Flux

- Specially formulated for use on lead-free valves and fittings
- Petrolatum based paste for typical sweat soldering with excellent wetting properties that allow for smooth flow and lead-free tin powder to draw solder in for reduced voiding
- Paste is lead-free and NSF61G listed for use on potable water systems
- Works well on frozen, cold and wet pipe

| Product No. | Size | Description | UPC | Ctn. Qty. |
|-------------|-------|-------------------------------------|--------------|-----------|
| TF227 | 227 g | MASTERS Tinning Flux, Brush Top Jar | 067001000103 | 24 |
| TF454 | 454 g | MASTERS Tinning Flux, Tub | 067001006202 | 12 |

FLUX



Oatey H-20[®] Water Soluble Paste Flux

- Effective on most metals, excluding aluminum and stainless steel
- Compatible with all common plumbing solder alloys
- Helps prevent copper pipe corrosion related to flux contamination
- Good for large diameter copper piping
- 100% lead-free paste cleans and fluxes copper piping to provide uniform solder flow
- Meets ASTM Standard B-813
- NSF Standard 14 (Performance) and Standard 61 (Health Effects) certified
- Safe for use in potable water applications

| Product No. | Size | Description | UPC | Ctn. Qty. |
|-------------|-------|--|--------------|-----------|
| 48362 | 454 g | H-20 [®] Water Soluble Paste Flux | 038753483627 | 12 |

CLEANING TOOLS



Oatey[®] Acid Brushes

- Perfect brush for applying liquid or paste fluxes.
- Approximately 3" long, 1/2" wide.

| Product No. | Size | Description | UPC | Ctn. Qty. |
|-------------|------|---------------------------|--------------|-----------|
| 30710 | 1/2" | Acid Brush – Carded | 038753307107 | 12 |
| 30712 | 1/2" | Acid Brush – with Barcode | 038753307121 | 144 |



MASTERS[®] Heavy Duty Fitting Brushes

- High quality, heavy-duty brush for cleaning copper fittings
- Heavy gauge galvanized double-wound stem wire with double-spiral construction
- High carbon level fill wire

| Product No. | Size | Description | UPC | Ctn. Qty. |
|-------------|-------|----------------------------------|--------------|-----------|
| FB50HD | 0.50" | MASTERS Heavy Duty Fitting Brush | 067001000644 | 10 |
| FB75HD | 0.75" | MASTERS Heavy Duty Fitting Brush | 067001000651 | 10 |
| FB100HD | 1.00" | MASTERS Heavy Duty Fitting Brush | 067001000668 | 10 |
| FB125HD | 1.25" | MASTERS Heavy Duty Fitting Brush | 067001000736 | 1 |
| FB150HD | 1.50" | MASTERS Heavy Duty Fitting Brush | 067001000743 | 1 |
| FB200HD | 2.00" | MASTERS Heavy Duty Fitting Brush | 067001000750 | 1 |



Oatey[®] Economy Fitting Brush

- Easy to use, contoured, heavy duty handle is perfect for cleaning copper and brass fittings fast and effectively.
- High carbon twisted steel shaft and brush gives long life and durability.

| Product No. | Size | Description | UPC | Ctn. Qty. |
|-------------|--------|--|--------------|-----------|
| 31327 | 1/2" | ID Fitting Brush w/ Heavy Duty Handle | 038753313276 | 12 |
| 31328 | 3/4" | ID Fitting Brush w/ Heavy Duty Handle | 038753313283 | 12 |
| 31329 | 1" | ID Fitting Brush w/ Heavy Duty Handle | 038753313290 | 12 |
| 31330 | 1-1/4" | ID Fitting Brush w/ Heavy Duty Handle | 038753313306 | 12 |
| 31331 | 1-1/2" | ID Fitting Brush w/ Heavy Duty Handle | 038753313313 | 6 |
| 31332 | 2" | ID Fitting Brush w/ Heavy Duty Handle | 038753313320 | 6 |
| 31404 | 1/2" | ID Fitting Brush w/ Heavy Duty Handle Carded | 038753314044 | 10 |
| 31405 | 3/4" | ID Fitting Brush w/ Heavy Duty Handle Carded | 038753314051 | 10 |



Oatey® 4-In-1 Brush

- Includes long lasting high carbon steel brushes for cleaning the I.D. and O.D. of 1/2" and 3/4" copper tube and fittings.

| Product No. | Size | Description | UPC | Ctn. Qty. |
|-------------|-------------|-----------------------|--------------|-----------|
| 31348 | 1/2" & 3/4" | 4-in-1 brush | 038753313481 | 12 |
| 31407 | 1/2" & 3/4" | 4-in-1 brush – Carded | 038753314075 | 10 |



Oatey® O.D. Tube Cleaning Brush

- Cleans the outside of copper and plastic tubing fast and effectively.
- The easy-to-grip brush ensures a clean surface and prepares the pipe for soldering or solvent welding.

| Product No. | Size | Description | UPC | Ctn. Qty. |
|-------------|------|--------------------------|--------------|-----------|
| 31345 | 1/2" | O.D. tube brush | 038753313450 | 12 |
| 31346 | 3/4" | O.D. tube brush | 038753313467 | 12 |
| 31347 | 1" | O.D. tube brush | 038753313474 | 12 |
| 31412 | 1/2" | O.D. tube brush – Carded | 038753314129 | 10 |
| 31413 | 3/4" | O.D. tube brush – Carded | 038753314136 | 10 |



MASTERS® 2-In-1 Power Fitting-Tube Cleaning Brushes

- Heavy duty bristles inside and out for cleaning both the ID of copper fittings & OD of copper tubing
- Fits on all power drills for a fast and efficient clean

| Product No. | Size | Description | UPC | Ctn. Qty. |
|-------------|-------|--|--------------|-----------|
| PFB50 | 0.50" | MASTERS 2-in-1 Power Fitting-Tube Cleaning Brush | 067001003780 | 1 |
| PFB75 | 0.75" | MASTERS 2-in-1 Power Fitting-Tube Cleaning Brush | 067001003799 | 1 |

MASTERS® Power Fitting Brushes

- Heavy duty bristle brushes
- Fits all power drills for a fast clean of the inside diameter of copper fittings

| Product No. | Size | Description | UPC | Ctn. Qty. |
|-------------|-------|--|--------------|-----------|
| PFB25HD | 0.25" | MASTERS Heavy Duty Fitting Brush for Power Drill | 067001003829 | 1 |
| PFB50HD | 0.50" | MASTERS Heavy Duty Fitting Brush for Power Drill | 067001003706 | 1 |
| PFB75HD | 0.75" | MASTERS Heavy Duty Fitting Brush for Power Drill | 067001003713 | 1 |
| PFB100HD | 1.00" | MASTERS Heavy Duty Power Fitting for Power Drill | 067001003720 | 1 |
| PFB125HD | 1.25" | MASTERS Heavy Duty Fitting Brush for Power Drill | 067001003737 | 1 |
| PFB150HD | 1.50" | MASTERS Heavy Duty Fitting Brush for Power Drill | 067001003744 | 1 |
| PFB200HD | 2.00" | MASTERS Heavy Duty Fitting Brush for Power Drill | 067001003751 | 1 |
| PFB250HD | 2.50" | MASTERS Heavy Duty Fitting Brush for Power Drill | 067001003768 | 1 |
| PFB300HD | 3.50" | MASTERS Heavy Duty Fitting Brush for Power Drill | 067001003775 | 1 |
| PFB400HD | 4.00" | MASTERS Heavy Duty Fitting Brush for Power Drill | 067001003812 | 1 |





MASTERS® Grit Cloth

- Water-proof 180 grit open mesh cloth
- Open mesh allows debris to fall through screen rather than building up on surface
- High tensile strength that resists tearing

| Product No. | Size | Description | UPC | Ctn. Qty. |
|-------------|---------------|--|--------------|-----------|
| GC5HD | 5 Yd x 1 3/8" | MASTERS Gritcloth Heavy Duty Premium Grade | 067001001573 | 25 |



Oatey® Open Mesh Cloth

- Water-proof 180 grit open mesh cloth
- Open mesh allows debris to fall through screen rather than building up on surface

| Product No. | Size | Description | UPC | Ctn. Qty. |
|-------------|--------------|---------------------|--------------|-----------|
| 31320 | 1.5" x 5 yd | 180 Open Mesh Cloth | 038753313207 | 24 |
| 31321 | 1.5" x 10 yd | 180 Open Mesh Cloth | 038753313214 | 24 |



MASTERS® Sand Cloth

- Water resistant 120 grit plumbers roll for abrasive metal cleaning of all types
- High tensile strength that resists tearing

| Product No. | Size | Description | UPC | Ctn. Qty. |
|-------------|------------|-------------------|--------------|-----------|
| SC2 | 2 Yd Roll | MASTERS Sandcloth | 067001000583 | 50 |
| SC5 | 5 Yd Roll | MASTERS Sandcloth | 067001000552 | 100 |
| SC25 | 25 Yd Roll | MASTERS Sandcloth | 067001000569 | 20 |



Oatey/MASTERS® Flame Protector Pads

- 9" x 12" woven ceramic (non asbestos) heat shield.
- Protects work areas from torches up to 2000°F.
- Packaged in a polybag.

| Product No. | Size | Description | UPC | Ctn. Qty. |
|-------------|----------|--|--------------|-----------|
| FPPHD912 | 9" x 12" | MASTERS Heavy Duty Flame Protector Pad | 067001000729 | 1 |
| 31400 | 9" x 12" | Bagged Flame Protector | 038753314006 | 5 |



MASTERS® Pipeslice

- Self adjusting copper pipe cutter with a replaceable blade
- Ideal for confined spaces, especially where there is a minimal pipe to wall clearance

| Product No. | Size | Description | UPC | Ctn. Qty. |
|-------------|-------|--|--------------|-----------|
| KPX100 | 0.50" | MASTERS Pipeslice Tool | 067001001757 | 1 |
| KPX103 | 0.75" | MASTERS Pipeslice Tool | 067001001764 | 1 |
| KPX101 | 1.00" | MASTERS Pipeslice Tool | 067001001740 | 1 |
| KPX200 | 0.50" | MASTERS Pipeslice Replacement Wheel for Tool | 067001001771 | 1 |
| KPX234 | 0.75" | MASTERS Pipeslice Replacement Wheel for Tool | 067001001788 | 1 |
| KPX300 | 1.00" | MASTERS Pipeslice Replacement Wheel for Tool | 067001001801 | 1 |



MASTERS® Pipe Plug

- "Plumber's Bread"
- Stops the flow of water without draining down the system, allowing for soldering to be done without water getting into the soldering weld
- Plug slides through fittings, most gate valves and some ball valves with full bore
- Replacement parts available upon request

| Product No. | Size | Description | UPC | Ctn. Qty. |
|-------------|--------------|---|--------------|-----------|
| B6001 | 0.5" to 2.5" | MASTERS Pipe Plug (Plumbers Bread) Complete Kit | 067001003027 | 1 |



Category 4

Putty, Caulks and Water Barriers

Whether installing a faucet or strainer, resetting tile, sealing roof flashing, or repairing a pipe, professional plumbers can't afford a leak. They demand a watertight seal and they know that MASTERS®, Oatey® and Hercules® products are formulated to do the job right every time. Oatey caulks and putties are trusted and synonymous with high quality and top performance.



MASTERS® Silicone Sealant

- Rated for interior and exterior use from -50°F to +450°F (-45°C to +232°C)
- Creates a mildew resistant and watertight seal when fully cured
- Ideal for tub/shower surrounds, sinks, siding, window frames, tiling and countertops
- Comes with a re-sealable cap to keep product from drying out
- NSF-51 listed for food preparation surfaces

| Product No. | Size | Description | UPC | Ctn. Qty. |
|-------------|--------|--|--------------|-----------|
| SS300-C | 300 ml | MASTERS Silicone Sealant Cartridge CLEAR | 067001003119 | 12 |
| SS300-T | 300 ml | MASTERS Silicone Sealant Cartridge TRANSLUCENT | 067001003133 | 12 |
| SS300-W | 300 ml | MASTERS Silicone Sealant Cartridge WHITE | 067001003102 | 12 |
| SS80-C | 80 ml | MASTERS Silicone Sealant Squeeze Tube CLEAR | 067001000040 | 12 |
| SS80-W | 80 ml | MASTERS Silicone Sealant Squeeze Tube WHITE | 067001000164 | 12 |



MASTERS® High Temperature Silicone Sealant

- Rated for interior and exterior use from -85°F to +500°F (-65°C to +260°C) consistent or up to 600°F (316°C) intermittent and is oxygen sensor safe
- Creates a mildew resistant and watertight seal when fully cured and comes with a re-sealable cap to keep product from drying out
- Can be used to replace cork, felt, rubber or asbestos gaskets and is ideal for sealing around ovens, flues on gas appliances, metal stacks and ductwork
- RED 302 is NSF-51 listed for food preparation surfaces

| Product No. | Size | Description | UPC | Ctn. Qty. |
|-------------|--------|---|--------------|-----------|
| BLACK-302 | 300 ml | MASTERS® Silicone Sealant Cartridge HIGH TEMP BLACK | 067001002051 | 12 |
| RED-302 | 300 ml | MASTERS® Silicone Sealant Cartridge HIGH TEMP RED | 067001001924 | 12 |



#MPS162-C shown

MASTERS® Paintable Silicone

- Available in White or Clear - rated for interior and exterior use from -20°F to 180°F (-29°C to 82°C) once cured
- For caulking around showers, tubs, lavatories, window frames, siding, backsplashes, and sinks
- Cleans up with soap and water prior to curing. White product dries clear after 2 hours. Dries to touch and latex paintable in approx. 2 hours (24 hours for oil-based paint)

| Product No. | Size | Description | UPC | Ctn. Qty. |
|-------------|--------|---|--------------|-----------|
| MPS162-W | 162 ml | MASTERS® Paintable Silicone Squeeze Tube - White- 162 mL | 067001004512 | 12 |
| MPS162-C | 162 ml | MASTERS® Paintable Silicone Squeeze Tube - Clear - 162 mL | 067001004505 | 12 |



MASTERS® Trim Plus

- Interior/Exterior Acrylic Painter's Caulk rated for use from -18°C to 71°C (0°F to 160°F) once cured.
- Leaves a professional finish between walls and cabinetry, baseboards, wainscoting, door casing, window casing, crown moulding, and mitred joints
- Cleans up with soap and water. Flexible material won't crack or peel and adheres tightly
- Dries to the touch and paintable in approximately 2 hours (24 hours for oil-based paints)

| Product No. | Size | Description | UPC | Ctn. Qty. |
|-------------|--------|--|--------------|-----------|
| MTP300-W | 300 ml | MASTERS® Trim Plus Painter's Caulk Cartridge - White- 300 mL | 067001004529 | 12 |



MASTERS® Silicone Tooling Foam

- Provides professional tooling results with no tools and less mess
- Virtually evaporates after use
- For best results, use with MASTERS® SILICONE SEALANT

| Product No. | Size | Description | UPC | Ctn. Qty. |
|-------------|-------|---|--------------|-----------|
| MSTF-370 | 370 g | MASTERS Silicone Tooling Foam Spray Can | 067001003157 | 12 |



Oatey® Plumber's Putty

- Fixture setting compound for setting frames, faucets, strainer baskets, etc.
- Stays flexible, will not crack or shrink. Easily workable, soft, pliable material.
- Not for use on marble, granite, plastic or any other dimensional stone.
- Meets Military Spec TTP-1536A.

| Product No. | Size | Description | UPC | Ctn. Qty. |
|-------------|-------|---------------------------|--------------|-----------|
| 48003 | 397 g | Putty – Plastic Container | 038753480039 | 24 |
| 48004 | 2 kg | Putty – Plastic Container | 038753480046 | 6 |



Oatey® Stain-Free Plumber's Putty

- Safe for most surfaces including: Granite, Marble, Quartz, Sandstone, Corian® or any natural, porous surface.
- Oil Free, NON-STAINING formula. Cleans up quickly.
- Great for sinks, bowls, faucets, strainers and shower bases.
- Stays flexible; will not crack or shrink. Not for use on ABS.

| Product No. | Size | Description | UPC | Ctn. Qty. |
|-------------|-------|------------------|--------------|-----------|
| 48336 | 255 g | Stain-Free Putty | 038753483368 | 18 |



MASTERS® Emergency Repair Tape

- Non-adhesive, environmentally safe and non-toxic emergency repair tape
- Temporarily stops leaks of up to 150 PSI (water, air, steam) even without turning off the system
- UV and tear resistant to allow for maximum stretch and tension to form silicone mass through compression, preventing leakage from damaged pipe, valves or fittings

| Product No. | Size | Description | UPC | Ctn. Qty. |
|-------------|------------|-------------------------------------|--------------|-----------|
| RI-5-8A12 | 1" x 12 ft | MASTERS Emergency Repair Tape, Roll | 890160001104 | 9 |
| RI-5-8K12M | 2" x 12 ft | MASTERS Emergency Repair Tape, Roll | 890160001333 | 6 |
| RI-5-8K40 | 2" x 36 ft | MASTERS Emergency Repair Tape, Roll | 890160001173 | 1 |



Oatey® Fix-It™ Stick Epoxy Putty

- Convenient multi-purpose sealing, patching and mending compound.
- Steel filled material, mixes in your hand and hardens in minutes.
- May be drilled, tapped, filed, sanded, sealed and painted when hardened.
- Non-toxic material contains no solvents and will not shrink.

| Product No. | Size | Description | UPC | Ctn. Qty. |
|-------------|-------|--------------------------|--------------|-----------|
| 31270 | 113 g | Fix-It Stick Epoxy Putty | 038753312705 | 12 |



MASTERS® Porc-A-Fix

- Porcelain touch up paint used to fill chips, scratches and other imperfections in porcelain fixtures
- Non-yellowing, high gloss finish available in a variety of colours*
- Easy one step process with brush-top applicator included

| Product No. | Size | Description | UPC | Ctn. Qty. |
|-------------|-------|--|--------------|-----------|
| AQ-01 | 15 ml | MASTERS Porcafix Aquasource White | 067001022318 | 4 |
| AS-01 | 15 ml | MASTERS Porcafix American Standard White | 067001020017 | 4 |
| AS-07 | 15 ml | MASTERS Porcafix American Standard Bone | 067001020079 | 4 |
| AS-11 | 15 ml | MASTERS Porcafix American Standard Fawn Beige | 067001020116 | 4 |
| AS-23 | 15 ml | MASTERS Porcafix American Standard Dresden Blue | 067001020239 | 4 |
| AS-33 | 15 ml | MASTERS Porcafix American Standard Sterling Silver | 067001020338 | 4 |
| BR-01 | 15 ml | MASTERS Porcafix Briggs White | 067001020659 | 4 |
| BS-01 | 15 ml | MASTERS Porcafix Basic White | 067001020642 | 4 |
| CA-01 | 15 ml | MASTERS Porcafix Crane White | 067001020802 | 4 |
| CA-13 | 15 ml | MASTERS Porcafix Crane Antique White | 067001020925 | 4 |
| CA-23 | 15 ml | MASTERS Porcafix Crane Platinum Gray | 067001021021 | 4 |
| CA-28 | 15 ml | MASTERS Porcafix Crane Warm White | 067001021076 | 4 |
| CA-29 | 15 ml | MASTERS Porcafix Crane Antique Bone | 067001021083 | 4 |
| EM-01 | 15 ml | MASTERS Porcafix Eljer Murray White | 067001021151 | 4 |
| EM-14 | 15 ml | MASTERS Porcafix Eljer Murray Natural | 067001021274 | 4 |
| GB-01 | 15 ml | MASTERS Porcafix Glacier Bay White | 067001022301 | 4 |
| GE-05 | 15 ml | MASTERS Porcafix General Electric White | 067001021519 | 4 |
| GE-10 | 15 ml | MASTERS Porcafix General Electric Almond | 067001021526 | 4 |



Hercules™ Roof & Flashing Sealant

- Long-lasting sealant. No separation; no stirring time; no objectionable odor.
- Forms durable, flexible, weatherproof coating.
- Can be applied on cold or wet surfaces. Not for use on rubber boot of flashings.

| Product No. | Size | Description | UPC | Ctn. Qty. |
|-------------|--------|-------------------------|--------------|-----------|
| 25410 | 3.78 L | Roof & Flashing Sealant | 032628254107 | 6 |



Category 5

Oils, Lubricants and Hand Cleaners

Oatey and MASTERS® offer an extensive line of oils, lubricants and hand cleaners.



MASTERS® Cutting Oil

- Heavy duty sulphurized, paraffinic oil specially blended for pipe threading, tapping, drilling, milling, broaching and general machine use
- Recommended for use on high carbon and alloy steels, stainless steel, many ferrous and non-ferrous metals as well as aluminum

| Product No. | Size | Description | UPC | Ctn. Qty. |
|-------------|-------------------|-----------------------------------|--------------|-----------|
| C0500 | 500 ml | MASTERS Cutting Oil, Spray Bottle | 067001001962 | 12 |
| C01L | 1 L | MASTERS Cutting Oil, Spout Bottle | 067001000484 | 12 |
| C04L | 4 L | MASTERS Cutting Oil, Jug | 067001000491 | 4 |
| C020L | 20 L (5 gal) | MASTERS Cutting Oil, Pail | 067001000507 | 1 |
| C0205L | 205 L (55 gal) | MASTERS Cutting Oil, Drum | 067001000514 | 1 |



MASTERS® Hand Cleaner

- Industrial strength, lanolin-enriched pumice emulsion removes grease, grime, paint, carbon, soot, ink, cement and much more
- Contains no acids or other caustic chemicals and is biodegradable

| Product No. | Size | Description | UPC | Ctn. Qty. |
|-------------|-------|--|--------------|-----------|
| HC455 | 455ml | MASTERS Hand Cleaner Squeeze Bottle | 067001001115 | 24 |
| HC4L | 4 L | MASTERS Hand Cleaner with Dispensing Pump, Jug | 067001001122 | 6 |



MASTERS® Lubricating Oiler

- Premium grade, petroleum based, high viscosity, non-detergent general purpose lubricating oil
- Provides superior anti-wear protection and reduces sludge/sticking in close-tolerance components
- Dispenses upside down or right side up

| Product No. | Size | Description | UPC | Ctn. Qty. |
|-------------|--------|--|--------------|-----------|
| L0113HD | 113 ml | MASTERS Lubricating Oiler, Sqz Bottle w Flex Spout | 067001000132 | 20 |



MASTERS® Pro-Grit Towels

- Waterless hand cleaning with shop-sized and durable pre-moistened towels
- Heavy-duty towels clean with pumice scrubbing power
- Remove dirt and grime from hands, equipment, tools, work surfaces, etc.

| Product No. | Description | UPC | Ctn. Qty. |
|-------------|-------------------------------------|--------------|-----------|
| MS72 | MASTERS Pro-Grit Towels - 72 Towels | 067001001108 | 6 |



Oatey® Pipe/Gasket Lube

- Non-toxic, soft, paste like material for lubricating bell joint pipe gaskets.
- Will not deteriorate natural or synthetic rubber.
- Will not support bacteria.
- Dissolves in hot water.

| Product No. | Size | Description | UPC | Ctn. Qty. |
|-------------|--------|----------------|--------------|-----------|
| 30599 | 473 ml | Pipe Lubricant | 038753305998 | 24 |
| 30600 | 946 ml | Pipe Lubricant | 038753306001 | 12 |
| 30601 | 3.78 L | Pipe Lubricant | 038753306018 | 4 |



Certified to NSF/ANSI 61



Hercules® Plumber's Grease

- Unique grease formula to lubricate and prevent corrosion on valve stems, faucets, ballcock linkage, and other places where a water-resistant grease is needed.

| Product No. | Size | Description | UPC | Ctn. Qty. |
|-------------|-------|---|--------------|-----------|
| 40601 | 2 oz. | 300 Degree Plumber's Grease - petroleum based | 032628406018 | 24 |
| 40610 | 2 oz. | Plumber's Silicone Grease | 032628406100 | 24 |



Category 6

Drain and Waste System Cleaners

When plumbing professionals need to use drain and waste system cleaners, they turn to Hercules for the best quality and highest performing products available. Two trusted brands, Hercules® and Cherne®, offer a variety of solutions for the toughest of drain cleaning challenges. These include emergency drain openers, drain system maintenance including unique clog-specific formulations, septic system care and repair, root controls, and unique grease management products.



The Right Drainage Product for the Right Job!

Identifying your drainage trouble is the first step towards correcting it.

Once you have selected the right drain opener to unclog your system, the next step is to decide on a preventative maintenance product to assure that blockages do not occur again.

Use these charts to select the correct products for your system.

| DRAIN OPENERS | SOLUTIONS | | | PREVENTION | | |
|-----------------------|-----------|----------|-------|------------|-------|----------|
| | PROBLEM | Clobber® | Glug® | Sizzle® | PT-4™ | PT-BI01™ |
| Grease, Fats, Oils | • | • | | • | • | • |
| Soaps, Detergents | • | • | | • | • | • |
| Sludge | • | • | | • | • | • |
| Paper, Cloth, Lint | • | | | | | |
| Hair | | • | | | | |
| Rust, Scale, Minerals | | | • | | | |
| Concrete Grout | | | • | | | |
| Slime | | | • | • | • | • |

| SEPTIC SYSTEMS | SOLUTIONS | | PREVENTION | | |
|------------------------------|-----------|---------|------------|--------------|-------------|
| | PROBLEM | Aid-Ox® | PT-4™ | Septic-Flow™ | Bacta-Life® |
| Sluggishness/Ponding | • | • | • | | • |
| Drywell/Seepage Pit Back-Ups | • | • | • | • | • |
| Odors | • | • | • | | • |
| Compacted Solids | | • | • | | |
| Tank Back-Up | | • | • | | |

| GREASE TRAPS | SOLUTIONS | | PREVENTION | |
|----------------------|-----------|-------|------------|-------|
| | PROBLEM | PT-4™ | PT-BI01™ | PT-4™ |
| Frequent Pumping | | | • | • |
| Back-Ups | | | • | • |
| Discharge Violations | | • | | • |
| Odors | • | • | • | • |
| Greasy Lines | • | • | • | • |

Due to the dangerous nature of these products, GLUG, CLOBBER and SIZZLE should only be used by licensed plumbers.

CATEGORY 6 DRAIN AND WASTE SYSTEM CLEANERS

NON ACID DRAIN OPENERS



Hercules™ Glug® Crystals

- Works fast on sluggish drains.
- Leaves no offensive after odor.
- Non-acid crystals clear sluggish drains, prevents clogs.
- Harmless to most metal and plastic pipe, valves and fittings.
- Not for use with garbage disposal.

| Product No. | Size | Description | UPC | Ctn. Qty. |
|-------------|--------|------------------|--------------|-----------|
| 20412 | 543 g | Glug® – Crystals | 032628204126 | 24 |
| 20413 | 907 g | Glug® – Crystals | 032628204133 | 12 |
| 20415 | 2.7 kg | Glug® – Crystals | 032628204157 | 4 |



Hercules™ Glug® Liquid

- Kitchen - attacks clogs caused by buildup of fats, grease and foodstuffs.
- Bath - attacks clogs caused by hair and soap products.

| Product No. | Size | Description | UPC | Ctn. Qty. |
|-------------|--------|--------------------------|--------------|-----------|
| 20450 | 946 ml | Glug® – Bath – Liquid | 032628204508 | 10 |
| 20455 | 1.9 L | Glug® – Bath – Liquid | 032628204553 | 6 |
| 20470 | 946 ml | Glug® – Kitchen – Liquid | 032628204706 | 10 |
| 20475 | 1.9 L | Glug® – Kitchen – Liquid | 032628204751 | 6 |

ACID DRAIN OPENERS



#20211 shown

Hercules™ Clobber®

- Fastest method for clearing emergency waste line stoppages.
- Rapidly disintegrates paper, rags, food and all organic matter.
- Not for retail use or sale; for professional use only.

| Product No. | Size | Description | UPC | Ctn. Qty. |
|-------------|--------|-------------|--------------|-----------|
| 20205 | 940 ml | Clobber® | 032628202054 | 12 |
| 20211 | 1.89 L | Clobber® | 032628202115 | 6 |



Hercules™ Sizzle®

- Triple action formula.
- Effective removal of urinary salts, lime, rust, scale, etc.
- Not for retail sale or use; for professional use only.

| Product No. | Size | Description | UPC | Ctn. Qty. |
|-------------|--------|-------------|--------------|-----------|
| 20305 | 940 ml | Sizzle® | 032628203051 | 12 |
| 20310 | 3.78 L | Sizzle® | 032628203105 | 4 |

FLOW IMPROVERS



Hercules™ Wham®

- Powerful, multi-use, concentrated chemical emulsifier and waste system cleaner.
- Environmentally safe and biodegradable.
- Liquefies and disperses grease, soap, detergents and other organic waste.
- Will not harm digestive bacteria.
- Floral scent.
- Dissolves and controls build up - deodorizes.
- Safe to use in metal or PVC plastic plumbing.
- NOT RECOMMENDED FOR USE ON ABS

| Product No. | Size | Description | UPC | Ctn. Qty. |
|-------------|--------|-------------|--------------|-----------|
| 20110 | 946 ml | Wham® | 032628201101 | 12 |
| 20115 | 3.78 L | Wham® | 032628201156 | 6 |



Hercules™ Iron Ike® Rust Remover

- Dissolves and removes rust stains on contact.
- Contains no dangerous phosphoric acid, phosphates or chlorine.

| Product No. | Size | Description | Ctn. Qty. |
|-------------|--------|------------------------|-----------|
| 45400 | 591 ml | Iron Ike® Rust Remover | 12 |



#137503 shown

Hercules™ PT-4™

- Unique pine-scented, solvent-based, non-acid, non-caustic formulation that emulsifies grease.
- Safely liquefies and disperses grease, soap scum, food residue, sludge and other build-ups.
- Biodegradable.

| Product No. | Size | Description | UPC | Ctn. Qty. |
|-------------|--------|-----------------------|--------------|-----------|
| 137501 | 940 ml | Hercules PT-4™ | 661000010712 | 12 |
| 137503 | 3.78 L | Hercules PT-4™ | 661000010729 | 4 |
| 137504 | 18.9 L | Hercules PT-4™ – Pail | 661000010972 | 1 |
| 137507 | 56.7 L | Hercules PT-4™ – Drum | 661000010743 | 1 |
| 137509 | 208 L | Hercules PT-4™ – Drum | 661000010767 | 1 |



#137301 shown

Hercules™ PT-BIO1™

- Concentrated liquid blend of fast acting grease and waste digesting bacteria.
- Safe, biodegradable grease and soil modifiers.
- Contains no acids, caustics, solvents or other harsh chemicals.

| Product No. | Size | Description | UPC | Ctn. Qty. |
|-------------|--------|--------------------------|--------------|-----------|
| 137301 | 940 ml | Hercules PT-BIO1™ | 661000010415 | 12 |
| 137303 | 3.78 L | Hercules PT-BIO1™ | 661000010422 | 4 |
| 137304 | 18.9 L | Hercules PT-BIO1™ - Pail | 661000010989 | 1 |
| 137307 | 56.7 L | Hercules PT-BIO1™ - Drum | 661000010439 | 1 |

SEPTIC PRODUCTS



Hercules™ Aid-Ox®

- Oxygen-based foaming porosity restorer and cleaner.
- Frequently used on seasonal rentals.
- Non-acid, non-caustic formulation.

| Product No. | Size | Description | UPC | Ctn. Qty. |
|-------------|--------|------------------|--------------|-----------|
| 252034 | 4.08 L | Hercules Aid-Ox® | 661000010347 | 4 |

SEPTIC PRODUCTS



Hercules™ Septic-Flow™

- Concentrated liquid bacterial additives.
- Keeps septic systems in peak condition.

| Product No. | Size | Description | UPC | Ctn. Qty. |
|-------------|--------|-----------------------|--------------|-----------|
| 139302 | 1.89 L | Hercules Septic-Flow™ | 661000020018 | 6 |



Hercules™ Bacta-Life®

- A concentrated powdered product.
- Replaces beneficial bacteria.
- Use immediately after pumping your septic or cesspool system.

| Product No. | Size | Description | UPC | Ctn. Qty. |
|-------------|--------|----------------------|--------------|-----------|
| 222031 | 473 ml | Hercules Bacta-Life® | 661000010323 | 12 |



Hercules™ Cesspool Cleaner

- Usage: Emergencies to temporarily eliminate back-ups and overflows.
- Dissolves all organic material including: hair, grease, paper, etc.
- Removes grease and sludge from baffles, pump floats, distribution boxes and lateral lines.
- Pump system within a few hours of adding this product.
- Add Bacta-Life® 5 days after treatment to restore microbial activity.

| Product No. | Size | Description | UPC | Ctn. Qty. |
|-------------|---------------|---------------------------|--------------|-----------|
| 20715 | 25 lb / 11 kg | Hercules Cesspool Cleaner | 032628207158 | 1 |

DRAIN FLUSHERS



Cherne® Clog-Buster® Drain Flusher

- Unclogs drain pipes in seconds.
- Simply remove aerator from faucet spigot and attach faucet adapter to garden hose.
- Attaches to standard garden hose fitting.
- Natural rubber body provides excellent seal.

| Product No. | Size | Description | Ctn. Qty. |
|-------------|-----------|-----------------------------|-----------|
| 303127 | 1"-2" | Clog-Buster® Drain Flusher | 1 |
| 303135 | 1-1/2"-3" | Clog-Buster® Drain Flusher | 1 |
| 303143 | 4"- 6" | Clog-Buster® Drain Flusher | 1 |
| 006193 | | Clog-Buster® Faucet Adapter | 1 |



MASTERS® Plunger

- Accordion style plunger with more push power than any other style
- Funnel-nose design ensures perfect fit in toilet bowls and kitchen sinks preventing slippage and splash back

| Product No. | Size | Description | UPC | Ctn. Qty. |
|-------------|------|-----------------|--------------|-----------|
| MP100 | | MASTERS Plunger | 077115100000 | 1 |



Category 7

Heating Chemicals and Anti-Freeze

A well-maintained hydronic heating system provides reliable performance even during the harshest winters. Heating maintenance professionals know that top quality materials are critical to achieve superior performance. That's why contractors depend on Hercules™ and MASTERS®. They are formulated for high performance and developed with both the user and the environment in mind.

How to Maintain a Boiler System

Prior to Use: Read all product labels carefully.

Keep container closed when not in use. Avoid eye and skin contact. Wear safety glasses with side shields and wear rubber gloves.

1. Turn off the gas and autofeeder and disconnect the electrical supply.
2. Bleed a small amount of fluid from hydronic loop to inspect for rust, sediment or mucus-like sludge to determine if system restorer is required.
3. If sludge and sediment are present, drain system completely until water runs clear.
4. Flush system with Sludgehammer System Restorer by mixing 1 quart System Restorer with 1 gallon of water in a bucket and pumping into the system.
5. Without breaking suction, add enough water to completely fill the system. Close valve. Remove pump. Reconnect the power and circulate for 4 hours.
6. Completely drain and flush the system.
7. Recharge system with Sludgehammer Corrosion Inhibitor and Cryo-Tek.
8. Reconnect power supply and circulate for two hours.
9. Recheck inhibitor and propylene glycol (PG) levels using Cryo-Tek test strips, pH meter, or refractometer.

For Regular Maintenance

- a. Open drain valve and remove a small amount of liquid (close valve).
- b. Use Cryo-Tek Test Strips to check the corrosion inhibitor and PG levels.
- c. Add Sludgehammer Corrosion Inhibitor if system is low.
 - i. To add Inhibitor: open drain valve and remove 2 gallons of water. Mix one quart of Sludgehammer and two gallons of water.
 - ii. Attach pump hose to drain valve, prime the pump, and turn it on.
 - iii. Without breaking suction, pump one gallon of water to ensure all Inhibitor gets into the system.
 - iv. Close drain valve, and turn pump off.
 - v. Reconnect the power supply and circulate for two hours before rechecking the Inhibitor and anti-freeze levels.
10. Add PG if the system is low.
 - a. Properly dilute Anti-Freeze in water.
 - b. Attach pump hose to drain valve, prime the pump, and turn it on.
 - c. Close drain valve, and turn pump off.
 - d. Reconnect the power supply, and circulate for two hours before rechecking the inhibitor and anti-freeze levels.



Cryo-Tek™ Products Keep Systems Clean and Operating Efficiently.

Improves heat transfer and minimizes wear to moving parts.



| | Original | -100 | AG | Universal |
|--------------------------------------|----------|---------|--------|-----------|
| PG Ratio | 45% | 55% | 95% | 97% |
| PG Quality | Virgin | Virgin | Virgin | Virgin |
| Color | Blue | Red | Blue | Purple |
| Freeze Point | -22 | -70 | -70 | <-60 |
| Flow Point | -27 | -80 | -80 | <-70 |
| Burst Point | -80 | -100 | -100 | -100 |
| pH | 8.5-100 | 9.0-100 | 9.0-10 | 7.5-8.5 |
| Viscosity (At 50% - 100°F) | 5 cps | 7 cps | 37 cps | 35 cps |
| Boiling Point | 220°F | 230°F | 370°F | 320°F |
| Temperature Rating | 300°F | 300°F | 300°F | 300°F |
| Heat Transfer | .908 | .843 | .681 | .600 |



#353319

Hercules™ Universal Cryo-Tek™

Our triple-protection inhibitor package stabilizes pH to prevent corrosion, chelates, hard water minerals, and inhibits the formation of scale and sediment.

- Concentrated universal solution with 97% virgin propylene glycol.
- Triple Protection Inhibitor stabilizes pH to prevent corrosion, chelates, hard water minerals, and inhibits scale and sediment formation.
- Approved for use with **all metals, PEX and elastomeric tubing** (not for use with CPVC)
- Meets and exceeds the corrosion protection requirements of ASTM D1384.

| Product No. | Size | Description | Ctn. Qty. |
|-------------|-----------------|--------------------|-----------|
| 353330 | 3.78 L / Gallon | Universal Cryo-Tek | 6 |
| 353319 | 18.9 L / 5 gal. | Universal Cryo-Tek | 1 |
| 353327 | 208 L / 55 gal. | Universal Cryo-Tek | 1 |

For application, freeze protection and specific dilutions, view submittal sheet at herchem.com



#352859

Hercules™ Cryo-Tek™ AG

- Concentrated Arctic Grade solution with **95% Virgin Propylene Glycol**.
- Triple Protection Inhibitor stabilizes pH to prevent corrosion, chelates, hard water minerals, and inhibits scale and sediment formation.
- Approved for use with **copper, steel, iron, brass, PEX and elastomeric tubing** (not for use with galvanized, CPVC and aluminum).

| Product No. | Size | Description | UPC | Ctn. Qty. |
|-------------|-----------------|-------------|--------------|-----------|
| 352859 | 18.9 L / 5 gal. | Cryo-Tek AG | 032628352858 | 1 |
| 352899 | 208 L / 55 gal. | Cryo-Tek AG | 032628352896 | 1 |



#352849

Hercules™ Cryo-Tek™-100

- Pre-Mixed: Ready to use formula with **55% Virgin Propylene Glycol**.
- Triple Protection Inhibitor stabilizes pH to prevent corrosion, chelates, hard water minerals and inhibits scale and sediment formation.
- Approved for use with **copper, steel, iron, brass, PEX and elastomeric tubing** (not for use with galvanized, CPVC, and aluminum).

| Product No. | Size | Description | UPC | Ctn. Qty. |
|-------------|-----------------|--------------|--------------|-----------|
| 352819 | 3.78 L / Gallon | Cryo-Tek-100 | 032628952812 | 6 |
| 352849 | 18.9 L / 5 gal. | Cryo-Tek-100 | 032628952843 | 1 |
| 352879 | 208 L / 55 gal. | Cryo-Tek-100 | 032628952874 | 1 |



#352609

Hercules™ Cryo-Tek™ Original

- Pre-Mixed: Ready to use formula with **45% Virgin Propylene Glycol**.
- Triple Protection Inhibitor stabilizes pH to prevent corrosion, chelates, hard water minerals and inhibits scale and sediment formation.
- Approved for use with **copper, steel, iron, brass, PEX and elastomeric tubing** (not for use with galvanized, CPVC, and aluminum).

| Product No. | Size | Description | UPC | Ctn. Qty. |
|-------------|-----------------|-------------------|--------------|-----------|
| 352609 | 18.9 L / 5 gal. | Cryo-Tek Original | 032628352605 | 1 |
| 352679 | 208 L / 55 gal. | Cryo-Tek Original | 032628352674 | 1 |

SYSTEM TESTING



Hercules™ Cryo-Tek™ Test Strips

- Contains 10 color-coded disposable test strips.
- Each checks levels of propylene glycol and corrosion protection.
- Check glycol and inhibitor levels annually; add Hercules Sludgehammer Universal Corrosion Inhibitor if level is low.

| Product No. | Size | Description | UPC | Ctn. Qty. |
|-------------|------|------------------------|-----|-----------|
| 35271 | | Test Kit, 6 - 10 Packs | | 6 |



Hercules™ pH Test Meter

- Ideal for checking acidity or alkalinity of heating or potable water systems.

| Product No. | Size | Description | UPC | Ctn. Qty. |
|-------------|------|---------------|--------------|-----------|
| 35272 | | pH Test Meter | 032628352728 | 1 |



Hercules™ Refractometer

- Fastest and easiest method for ensuring accurate ethylene and propylene glycol levels.

| Product No. | Size | Description | UPC | Ctn. Qty. |
|-------------|------|---------------|--------------|-----------|
| 35290 | | Refractometer | 032628352902 | 1 |

MAINTENANCE PRODUCTS



Hercules™ Sludgehammer™ Universal Corrosion Inhibitor

- Multi-purpose formula controls scale, corrosion, boiler noise and hydrogen gassing.
- Helps restore efficiency to hydronic heating systems.
- Safe for all metals including aluminum and stainless steel.
- Compatible and for use with all Cryo-Tek antifreezes..

| Product No. | Size | Description | UPC | Ctn. Qty. |
|-------------|-----------------|-------------------------------|--------------|-----------|
| 35297 | 946 ml / 32 oz. | Universal Corrosion Inhibitor | 032628352674 | 6 |



MASTERS® Pro-Tek 922

- Oxygen inhibiting boiler treatment to protect aluminum, brass, copper, iron and steel equipment from corrosion and scale build up
- Recommended by major boiler manufacturers for system use
- Environmentally friendly and non-hazardous
- Concentrated formula (mix 1 part chemical to 50 parts water)

| Product No. | Size | Description | UPC | Ctn. Qty. |
|-------------|------|--|--------------|-----------|
| MPT1L-C | 1 L | MASTERS Pro-Tek 922 Concentrated Inhibitor, Bottle | 067001001641 | 12 |
| MPT4L-C | 4 L | MASTERS Pro-Tek 922 Concentrated Inhibitor, Jug | 067001002037 | 4 |

SYSTEM REPAIR PRODUCTS



Hercules™ Base Hit™ II Sealant & Lubricant

- Seals and prevents leaks.
- Remedies most squeaking pumps.
- Will not form sludge or precipitates or impede normal operation.

| Product No. | Size | Description | UPC | Ctn. Qty. |
|-------------|-----------------|-------------|--------------|-----------|
| 30213 | 354 ml / 12 oz. | Base Hit II | 032628302013 | 12 |



Hercules™ Boiler Liquid

- Seals and repairs cracks or leaks in hot water or steam boilers.*
- Makes a strong lasting repair on difficult leaks.
- Resists pressure and is not affected by boiler cleaners.
- Prevents surging and will not clog or coat heating coils controls, vents or valves.

| Product No. | Size | Description | UPC | Ctn. Qty. |
|-------------|-----------------|---------------|--------------|-----------|
| 30115 | 946 ml / 32 oz. | Boiler Liquid | 032628301153 | 12 |

*Hot water portion of steam boiler

SYSTEM CLEANING PRODUCTS



Hercules™ Sludgehammer™ System Restorer & Noise Reducer

- Combination formula removes sludge and corrosion while reducing boiler noise.
- Helps restore efficiency to hydronic heating systems.
- Compatible with aluminum and stainless steel heat exchangers.
- Flush from system after use.

| Product No. | Size | Description | UPC | Ctn. Qty. |
|-------------|-----------------|---------------------------------|--------------|-----------|
| 35298 | 946 ml / 32 oz. | System Restorer & Noise Reducer | 032628352988 | 6 |



Hercules™ Boiler and Heating System Cleaner

- Formulated to clean and condition steam and hot water systems.
- Protects pumps by lubricating seals and zone valves.
- Prevents clogging of valves and prevents corrosion.
- Safe and easy to use.

| Product No. | Size | Description | UPC | Ctn. Qty. |
|-------------|-----------------|-----------------------------------|--------------|-----------|
| 35206 | 946 ml / 32 oz | Boiler and Heating System Cleaner | 032628352063 | 12 |
| 35211 | 3.78 L / Gallon | Boiler and Heating System Cleaner | 032628352117 | 6 |

#35211 shown



MASTERS® Hydro-Solv 9100

- Safely and effectively cleans aluminum, brass, copper, iron and steel boiler components in new and used systems
- Environmentally friendly, non-hazardous and contains no acid or TSP
- Helps recover lost efficiency and removes scale, corrosion, bacteria, solder/flux, cutting oil, dirt and rust
- Concentrated formula (mix 1 part chemical to 50 parts water)

| Product No. | Size | Description | UPC | Ctn. Qty. |
|-------------|------|--|--------------|-----------|
| MHS1L-C | 1 L | MASTERS Hydro-Solv 9100 Concentrated Cleaner, Bottle | 067001001719 | 12 |
| MHS4L-C | 4 L | MASTERS Hydro-Solv 9100 Concentrated Cleaner, Jug | 067001002044 | 4 |



#35245



Haymaker™ Tankless Water Heater Descaler

- Non-corrosive, effectively removes scale - Professional grade formula
- Clear liquid allows you to see the results of the descaling - Clear, citric acid-based formula
- Safe for potable water. NSF 60 listed
- Will not harm the environment. VOC free, biodegradable
- *Users have everything they need to descale a tankless water heater. Available in a kit with everything needed to descale a system - 946 ml Haymaker solution, 13 L pail, two hoses, electric pump with 3m cord.

| Product No. | Size | Description | UPC | Ctn. Qty. |
|-------------|-----------------|---------------|--------------|-----------|
| 35240 | 946 ml / 32 oz. | Descaler | 032628352407 | 6 |
| 35231 | 3.78 L / Gallon | Descaler | 032628352315 | 6 |
| 35245 | | Descaler Kit* | | 1 |

The Haymaker solution dissolves 3 times the amount of scale as a gallon of white vinegar, without the foul odor! The concentration of acetic acid in vinegar is relatively low (5%), whereas Haymaker is 50% by weight concentrate that is mixed with water before use.



MASTERS® HVAC Cleaner

- Heavy-duty, multi-purpose liquid cleaner
- Removes grease, inorganic soils, smoke deposits, etc

| Product No. | Size | Description | UPC | Ctn. Qty. |
|-------------|--------|---|--------------|-----------|
| HVLC946 | 946 ml | MASTERS Heavy Duty HVAC Cleaner, Spray Bottle | 067001001153 | 12 |



Category 8

Bowl Setting Wax Gaskets and Bolts

For generations of professional plumbers, Oatey® has set the standard for the highest quality and best performing toilet-setting products.



Oatey® Heavy Duty Wax Bowl Ring

- 100% pure petroleum wax gasket for setting any floor type closet bowl.
- Fits 3" or 4" waste lines and meets Military Spec. TT-P-1536A.
- Provides a permanent seal impervious to vermin, odors, gases and acids.

| Product No. | Size | Description | UPC | Ctn. Qty. |
|-------------|----------|--------------------------|--------------|-----------|
| 31190 | 3" or 4" | Heavy Duty Wax Bowl Ring | 038753311906 | 48 |



Oatey® Heavy Duty Wax Bowl Ring w/ Sleeve

- 100% pure petroleum wax gasket for setting any floor type closet bowl.
- Provides a permanent seal impervious to vermin, odors, gases and acids.
- Fits 3" or 4" waste lines and meets Military Spec. TT-P-1536A.
- Polyethylene sleeve extends discharge opening for a more positive seal assuring proper bowl alignment.

| Product No. | Size | Description | UPC | Ctn. Qty. |
|-------------|----------|---|--------------|-----------|
| 31193 | 3" or 4" | Wax Bowl Ring With Plastic Sleeve with Hardware | 038753311937 | 24 |
| 31194 | 3" or 4" | Wax Bowl Ring With Plastic Sleeve | 038753311944 | 24 |



Oatey® MaxWax® Wax Bowl Ring

- 40% thicker wax ring with a polyethylene sleeve to assure a tight seal.
- 100% pure petroleum wax gasket for setting any floor type closet bowl.
- Fits 3" to 4" waste lines and meets Military Spec. TT-P-1536A.
- Polyethylene sleeve extends discharge opening for a more positive seal assuring proper bowl alignment.
- Provides a permanent seal impervious to vermin, odors, gases and acids.

| Product No. | Size | Description | UPC | Ctn. Qty. |
|-------------|----------|------------------------------|--------------|-----------|
| 31188 | 3" or 4" | MaxWax Bowl Ring with Sleeve | 038753311883 | 12 |



Harvey® No-Seep® 3 in. or 4 in. No 2 Reinforced Wall Mount Gasket

- Maximum seal on wall hung toilets
- Fits 3" and 4" waste lines.
- Reinforced with urethane ring and fibers embedded into wax

| Product No. | Size | Description | UPC | Ctn. Qty. |
|-------------|----------|---------------------------------|--------------|-----------|
| 004005 | 3" or 4" | Specialty reinforced wax gasket | 078864040050 | 24 |



Oatey® Wax Free Gasket

- For repairs and new installations.
- 3" diameter hole.
- No wax needed.

| Product No. | Size | Description | UPC | Ctn. Qty. |
|-------------|------|-----------------|--------------|-----------|
| 42759 | 3" | Wax Free Gasket | 038753427591 | 12 |



Oatey® Urinal Wax Ring

- Urinal wax ring has a urethane sponge to provide resiliency.

| Product No. | Size | Description | UPC | Ctn. Qty. |
|-------------|--------------|-----------------|--------------|-----------|
| 31187 | 1-1/2" or 2" | Urinal Wax Ring | 038753311876 | 12 |

BOWL SETTING WAX GASKETS AND BOLTS



Hercules™ Johni Quick Bolts

- Unique new bolting system for mounting toilets.
- Fast and easy; just push down and twist to tighten in one quick motion.
- Eliminates "fall-through" and wobble.

| Product No. | Size | Description | UPC | Ctn. Qty. |
|-------------|----------------|------------------------|--------------|-----------|
| 90905 | 5/16" x 2-1/4" | Johni Quick Bolts Pair | 032628909052 | 100 |



#051158D shown

Harvey™ Nylon Bol-Bolts

- Universal application fits all flanges and material types.
- Increased head size so bolts won't fall through the drain pipe.
- More threads and specified design create a secure fit so the nut will stay in place and reduce backing out.

| Product No. | Size | Description | UPC | Ctn. Qty. |
|-------------|----------------|---|--------------|-----------|
| 051158 | 2-1/2" x 5/16" | Nylon Bolt Bulk Pack (2 bolts and 2 nuts per bag) | 078864511581 | 50 |
| 051158-D | 2-1/2" x 5/16" | Nylon Bolt Display Bucket of Bolts (2 bolts and 2 nuts per bag) | 078864511581 | 50 |
| 051159 | 3-1/2" x 5/16" | Nylon Bolt Bulk Pack (2 bolts and 2 nuts per bag) | 078864511598 | 50 |



Oatey® Liquilock™

- Solidifies water for easy toilet removal.
- Prevents water spills.
- Gel forms in 4 minutes. Simply flush gel away once toilet is re-set.
- Non-toxic, Lo-V.O.C.

| Product No. | Size | Description | UPC | Ctn. Qty. |
|-------------|------|-------------------------------|--------------|-----------|
| 31418 | | 0.6 oz. Liquilock Single Pack | 038753314181 | 50 |
| 31420 | | 16 oz. Liquilock Bulk Pack | 038753314204 | 6 |



Category 9

Drains and Closet Flanges

Oatey drains and closet flanges come in the widest variety of sizes, materials and configurations. PVC, cast iron, ABS, no matter what your shower drain or closet flange need, Oatey has the part you need to do the job right.

CLOSET FLANGES



Oatey® Level-Fit Closet Flange With Plastic Ring

- 3" or 4" all plastic flange solvent welds inside of 4" or over 3" Schedule 40 DWV pipe.
- 3" inside fit flange fits inside 3" Schedule 40 DWV pipe.
- Four mounting slots.
- Four countersunk holes for secure attachment to the floor.

| Product No. | Size | Description | UPC | Ctn. Qty. |
|-------------|----------|-----------------------------------|--------------|-----------|
| 43502 | 3" or 4" | ABS closet flange w/ plastic ring | 038753435022 | 12 |
| 43503 | 3" or 4" | PVC closet flange w/ plastic ring | 038753435039 | 12 |

Inside Fit Closet Flange With Plastic Ring

| | | | | |
|-------|----|--|--------------|----|
| 43506 | 3" | ABS closet flange w/ plastic ring and w/ test cap | 038753435060 | 12 |
| 43508 | 3" | ABS closet flange w/ plastic ring and w/o test cap | 038753435084 | 12 |



Oatey® Level-Fit Closet Flange With Stainless Steel Ring

- Corrosion resistant stainless steel ring.
- 3" x 4" flange fits inside of 4" or over 3" Sch. 40 DWV pipe.
- 4" flange fits over 4" Sch. 40 DWV pipe.
- Meets ASTM D2661 and D2665.
- Adjustable ring for alignment of bolts and screws, sits flush on floor.

| Product No. | Size | Description | UPC | Ctn. Qty. |
|-------------|----------|--|--------------|-----------|
| 43494 | 3" or 4" | ABS closet flange w/SS ring w/o test cap | 038753434940 | 12 |
| 43495 | 3" or 4" | PVC closet flange w/SS ring w/o test cap | 038753434957 | 12 |

Over 4" Fit Flange

| | | | | |
|-------|----|--|--------------|----|
| 43498 | 4" | ABS closet flange w/SS ring w/o test cap | 038753434988 | 12 |
| 43499 | 4" | PVC closet flange w/SS ring w/o test cap | 038753434995 | 12 |



Oatey® Level Fit 45° Closet Flange With Plastic Ring

- 45° bend, 360° rotation allows wide range of plumbing connections in tight spaces.
- Design allows flange to set flush.
- Fits over 3" or inside 4" pipe.

| Product No. | Size | Description | UPC | Ctn. Qty. |
|-------------|----------|---|--------------|-----------|
| 43815 | 3" or 4" | ABS 45° Closet Flange w/plastic ring w/o test cap | 038753438153 | 6 |
| 43816 | 3" or 4" | PVC 45° Closet Flange w/plastic ring w/o test cap | 038753438160 | 6 |



Oatey® Level Fit 45° Closet Flange With Stainless Steel Ring

- Solvent weld connection for Sch. 40, 3" outside or 4" inside fit
- Durable and corrosion resistant 430 stainless steel ring
- Ring provides adjustability with 360° swivel
- No restriction throat complies with IAPMO IGC 67-2014el flow requirements

| Product No. | Size | Description | UPC | Ctn. Qty. |
|-------------|----------|---------------------------------------|--------------|-----------|
| 43607 | 3" or 4" | PVC 45° Bend Closet Flange w/ SS Ring | 038753436074 | 12 |
| 43608 | 3" or 4" | ABS 45° Bend Closet Flange w/ SS Ring | 038753436081 | 12 |



Oatey® Over 4" Level-Fit Closet Flange

- Fits over 4" Schedule 40 DWV pipe.
- With plastic ring.

| Product No. | Size | Description | UPC | Ctn. Qty. |
|-------------|------|----------------------------|--------------|-----------|
| 43548 | 4" | ABS Over Pipe w/o Test Cap | 038753007267 | 12 |



Oatey® Level Fit Closet Flange With Plastic Ring, Long Mounting Slots

- All plastic flange solvent welds inside of 4" or over 3" Schedule 40 DWV pipe.
- Four countersunk holes for secure attachment to the floor.
- Radial slots extend 130° to allow exact alignment of the water closet.

| Product No. | Size | Description | UPC | Ctn. Qty. |
|-------------|-------|--|--------------|-----------|
| 43510 | 3"-4" | ABS closet flange w/plastic ring, long mounting slots – w/o test cap | 038753435107 | 12 |
| 43511 | 3"-4" | PVC closet flange w/plastic ring, long mounting slots – w/o test cap | 038753435114 | 12 |

CLOSET FLANGES



Oatey® Fast Set® Closet Flange With Plastic Ring or Stainless Steel Ring

- Patent-pending Bolt Shelf designed to keep bolts in track that is molded into the flange-eliminates bolt fall-through
- 3 strike points make test cap knockout effortless.

| Product No. | Size | Description | UPC | Ctn. Qty. |
|-------------|--------|---|--------------|-----------|
| 48470 | 3" hub | Fast Set® Testable ABS Closet Flange w/plastic ring | 038753484709 | 12 |
| 48471 | 3" hub | Fast Set® Testable ABS Closet Flange w/SS ring | 038753484716 | 12 |



Oatey® Level Fit Offset Closet Flange With Stainless Steel/Metal Ring

- The metal ring provides added strength and cracking resistance to the flange and can be rotated to allow precise alignment of bolts and screws.
- Solvent welds inside of 4" or over 3" Schedule 40 DWV pipe.
- 2" offset allows a margin of error for drain pipe/flange alignment.

| Product No. | Size | Description | UPC | Ctn. Qty. |
|-------------|-------|--------------------------------------|--------------|--|
| 43500 | 3"-4" | Offset Metal Ring - ABS w/Metal Ring | 038753435008 | 12  |
| 43501 | 3"-4" | Offset Metal Ring - PVC w/Metal Ring | 038753435015 | 12  |
| 43605 | 3"-4" | PVC Offset Closet Flange w/ SS Ring | 038753436050 | 12 |
| 43606 | 3"-4" | ABS Offset Closet Flange w/ SS Ring | 038753436067 | 12 |



Oatey® Spigot Fit Closet Flange

- For use in hub-end of fitting.
- Fits on inside of fitting.
- Eight countersunk holes and two closet bolt slots for secure attachment to the floor.

| Product No. | Size | Description | UPC | Ctn. Qty. |
|-------------|------|---|--------------|-----------|
| 43584 | 3" | Spigot Fit Closet Flange, ABS, w/plastic ring | 038753435848 | 12 |
| 43585 | 3" | Spigot Fit Closet Flange, PVC, w/plastic ring | 038753435855 | 12 |
| 43586 | 4" | Spigot Fit Closet Flange, ABS, w/plastic ring | 038753435862 | 12 |
| 43587 | 4" | Spigot Fit Closet Flange, PVC, w/plastic ring | 038753435879 | 12 |



#42253 shown

Oatey® Cast Iron Closet Flange

- Cast iron closet flange, no caulking.
- Complete with body, brass ring, bolts and gasket.
- To be used on plastic or heavy weight, no hub or service weight soil pipe.

| Product No. | Size | Description | UPC | Ctn. Qty. |
|-------------|------|-------------------------------|--------------|-----------|
| 42253 | 3" | Cast iron flange w/o test cap | 038753422534 | 6 |
| 42255 | 4" | Cast iron flange w/o test cap | 038753422558 | 6 |
| 42256 | 4" | Cast iron flange w/ test cap | 038753422565 | 6 |



Oatey® Replacement Closet Flange

- Slides inside of 4" cast iron or Sch. 40 DWV plastic pipe.
- 3" stainless steel bolts are tightened from the finished floor.
- No caulking required.
- Compression joint allows up to 6.2 cm of adjustment to the riser.

| Product No. | Size | Description | UPC | Ctn. Qty. |
|-------------|------|-------------------------------|--------------|-----------|
| 43538 | 4" | ABS Closet Flange Replacement | 038753435381 | 2 |
| 43539 | 4" | PVC Closet Flange Replacement | 038753435398 | 2 |

CLOSET FLANGE REPAIR



Oatey® Twist-N-Set® Replacement Closet Flange

- Replaces broken cast iron closet flanges.
- Installs easily without tools.
- Smooth unrestricted flow design.
- Gasket expands to fit inside service weight, heavy weight and no hub pipe.

| Product No. | Size | Description | UPC | Ctn. Qty. |
|-------------|------|-------------------------------------|--------------|-----------|
| 43650 | 4" | ABS Twist-N-Set closet flange | 038753436500 | 2 |
| 43651 | 4" | PVC Twist-N-Set closet flange | 038753436517 | 2 |
| 43653 | 4" | Cast Iron Twist-N-Set closet flange | 038753436531 | 2 |
| 43654 | 3" | PVC Twist-N-Set closet flange | 038753436548 | 2 |
| 43655 | 3" | ABS Twist-N-Set closet flange | 038753436555 | 2 |



Oatey® Horizontal Adjustable Urinal Flange Kit

- Horizontal mounting slots accommodate urinals with 3-1/2" to 7" mount centers.
- Kit includes all bolts, nuts, washers and gaskets.
- The flange fits over 2" Sch. 40 DWV pipe (Prod No. 43540 and 43541).

| Product No. | Size | Description | UPC | Ctn. Qty. |
|-------------|------|---|--------------|-----------|
| 43540 | 2" | ABS Horizontal Adjustable Urinal Flange Kit | 038753435404 | 10 |
| 43541 | 2" | PVC Horizontal Adjustable Urinal Flange Kit | 038753435411 | 10 |
| 43542 | 2" | ABS Horizontal Spigot Urinal Flange Kit | 038753435428 | 10 |
| 43543 | 2" | PVC Horizontal Spigot Urinal Flange Kit | 038753435435 | 10 |

Oatey® Set-Rite® Toilet Flange Extension System

Stop double stacking wax rings! Double stacking may lead to uneven compression, which could cause potential leak paths. Long term undetected leak paths would require costly water damage restoration.

Use the Set-Rite® System instead for an air tight and leak free seal, every time!

- The only patented and UPC listed flange extension product acceptable for repair and remodels.
- Set-Rite eliminates improper double stacking of wax with spacers to raise the height and a gasket to seal the system.
- Set-Rite can be used on existing PVC, ABS, Cast Iron and Stainless Steel ringed flanges.



| Product No. | Size | Description | UPC | Ctn. Qty. |
|-------------|-------------|--|--------------|-----------|
| 43440C | 1/8"-2-1/4" | Toilet Flange Extension Kit - Extender, 1/8", 1/4", 1/2", 3/4" Spacers, Gasket, 3-1/2" Self-Tapping Screws | 038753434407 | 5 |
| 43401 | 1/8"-1-1/2" | Toilet Flange Extension Kit - Extender, 1/8", 1/4", 1/2" Spacers, Gasket, 2-1/2" Self-Tapping Screws | 038753434018 | 5 |
| 43402 | 1/8"-2" | Toilet Flange Extension Kit - Extender, 1/8", 3/4" Spacers, Gasket, 2-1/2" Self-Tapping Screws | 038753434025 | 5 |
| 43403 | 1/8"-1-1/4" | Toilet Flange Extension Kit - Extender, 1/8", 1/2" Spacers, Gasket, 2-1/2" Self-Tapping Screws | 038753434032 | 5 |
| 43404 | 1/4"-3/8" | Toilet Flange Extension Kit - Extender, 1/8", 1/4" Spacers, Gasket, 2-1/2" Self-Tapping Screws | 038753434049 | 5 |
| 43405 | | Toilet Flange Extension Only | 038753434056 | 6 |

Oatey® Fix-It™ Repair Ring

- Securely repairs broken, cracked or worn out mounting flanges without replacing the current toilet flange.
- 10 mounting holes for wide range of installation options on all flooring types.
- 4 slotted mounting tabs fit under all toilets. The elongated slots allow for angled screws to grab flooring.
- Perfect length bolt slot prevents bending during installation for secure, level and leak-free repairs.

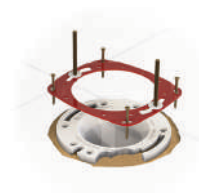

| Product No. | Size | Description | UPC | Ctn. Qty. |
|-------------|------|--|--------------|-----------|
| 42775C | | Fix-It Repair Ring Toilet Flange Mounting Repair Unit | 038753905839 | 10 |

CLOSET FLANGE REPAIR

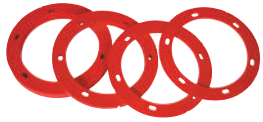

Set-Rite® Toilet Flange Spacers

| Product No. | Size | Description | UPC | Ctn. Qty. |
|-------------|-------------|---|--------------|-----------|
| 43446C | 1/8"-1-5/8" | Set-Rite Spacer Kit containing 1/8", 1/4", 1/2", 3/4" spacers | 038753434469 | 12 |
| 43410 | 3/4" | Set-Rite Spacer | 038753434100 | 12 |
| 43411 | 1/2" | Set-Rite Spacer | 038753434117 | 18 |
| 43412 | 1/4" | Set-Rite Spacer | 038753434124 | 36 |
| 43413 | 1/8" | Set-Rite Spacer | 038753434131 | 72 |



Closet Flange Spacer Kit

- For use when overlaying, replacing or tiling bathroom floors.
- Kit includes gaskets, 1/2" spacer, closet bolts and shims.

| Product No. | Size | Description | UPC | Ctn. Qty. |
|-------------|------|--------------------------|--------------|-----------|
| 43645 | | Closet Flange Spacer Kit | 038753436456 | 12 |



Closet Flange Spacer

- Builds up an existing closet flange when new flooring is installed.
- Can be stacked to desired height.

| Product No. | Size | Description | UPC | Ctn. Qty. |
|-------------|------|----------------------------|--------------|-----------|
| 43519 | 1/4" | Closet Flange Spacer – PVC | 038753435190 | 12 |
| 43646 | 1/2" | Closet Flange Spacer – PVC | 038753436463 | 12 |



Galvanized Wood Support Kit

- For repairing wobbly toilets or loose closet flanges without replacing the floor.
- Includes two heavy gauge pre-slotted flange plates, six floor attaching screws and 4 large flathead flange assembly screws.
- Use for holes cut too large, rotting floors or screws that pulled loose.
- Easy-to-use floor and flange support.

| Product No. | Size | Description | UPC | Ctn. Qty. |
|-------------|------|-----------------------------|--------------|-----------|
| 43555 | | Galvanized Wood Support Kit | 038753435558 | 12 |



Stainless Steel Closet Flange Replacement Ring

- For use on 3" or 4" closet flanges.
- Six countersunk holes and two closet bolt slots for secure attachment to the floor.

| Product No. | Size | Description | UPC | Ctn. Qty. |
|-------------|----------|-------------------------------|--------------|-----------|
| 42778 | 3" or 4" | Stainless Steel Closet Flange | 038753427782 | 12 |

CLOSET FLANGE REPAIR



Oatey® Moss Bay Replacement Flange

- For rusted or corroded metal closet flange rings.
- For use on PVC or ABS closet flanges.
- Includes 1/4" closet bolt.

| Product No. | Size | Description | UPC | Ctn. Qty. |
|-------------|------|-----------------------------|--------------|-----------|
| 42777 | | Moss Bay Replacement Flange | 038753427775 | 12 |



Oatey® Brass Closet Flange Replacement Ring

- For use 4" closet flanges.
- Three countersunk holes and three closet bolt slots for secure attachment to the floor.

| Product No. | Size | Description | UPC | Ctn. Qty. |
|-------------|----------|--------------------------------------|--------------|-----------|
| 43551 | 3" or 4" | Brass Closet Flange Replacement Ring | 038753007281 | 12 |

SHOWER DRAINS FOR PREFORMED BASES



Oatey® No-Calk Shower Base Drain

- Made of Cast Brass or Plastic.
- Designed for use with all preformed shower stall bases.
- Mechanically attaches over 2" Schedule 40 DWV pipe. The drain is fixed to the drain pipe from above the shower base, ideal for slab construction.
- Can be used with 1-1/2" Schedule 40 DWV pipe and 1-1/2" or 2" Copper DWV pipe when caulking gasket is replaced.
- Fiber and rubber gasket provide a tight seal to the base.
- Available with 4-1/4" Stainless Steel Snap-Tite Strainer.

| Product No. | Size | Description | UPC | Ctn. Qty. |
|--|------|--|--------------|-----------|
| 140 Series Brass No-Calk Shower Drain | | | | |
| 42150 | 2" | 140 NC Brass NO-CALK shower drain w/stainless steel strainer | 038753421506 | 12 |



101 PNC Series Plastic No-Calk Shower Drain

| | | | | |
|-------|----|--|--------------|----|
| 42075 | 2" | 101 PNC PVC NO-CALK shower drain w/plastic strainer | 038753420752 | 12 |
| 42077 | 2" | 101 PNC ABS NO-CALK shower drain w/plastic strainer | 038753420776 | 12 |
| 42084 | 2" | 101 PNC ABS NO-CALK shower drain w/stainless steel strainer | 038753420844 | 12 |
| 42099 | 2" | 101 PNC PVC NO-CALK shower drain w/stainless steel strainer | 038753420998 | 12 |
| 42180 | 2" | 101 PNC PVC NO-CALK shower drain w/stainless steel square strainer | | |
| 42181 | 2" | 101 PNC ABS NO-CALK shower drain w/stainless steel square strainer | | |



No-Calk Shower Drain Accessories

| | | | | |
|-------|--------|--|--------------|----|
| 42156 | 2" | Rubber caulking gasket to fit 2" Sch. 40 DWV drain pipe in the NO-CALK shower drains | 038753421568 | 12 |
| 42157 | 2" | Rubber caulking gasket to fit 2" No-hub cast iron pipe in the NO-CALK shower drains | 038753421575 | 12 |
| 42158 | 2" | Rubber caulking gasket to fit 2" copper DWV drain pipe in the NO-CALK shower drains | 038753421582 | 12 |
| 42159 | 1-1/2" | Rubber caulking gasket to fit 1-1/2" copper DWV drain pipe in the NO-CALK shower drains | 038753421599 | 12 |
| 42163 | 1-1/2" | Rubber caulking gasket to fit 1-1/2" Sch. 40 DWV drain pipe in the NO-CALK shower drains | 038753421636 | 12 |
| 42239 | | NO-CALK shower drain wrench – carded | 038753422398 | 4 |



SOLVENT WELD SHOWER DRAINS



#42093 shown

Oatey® 101 PS Series Solvent Weld Shower Drain

- Solvent weld over 2" Sch. 40 DWV pipe.
- Universal 4-1/4" Snap-Tite Strainer.
- Drain body is sealed to shower base with rubber gasket and fiber slip washer.

| Product No. | Size | Description | UPC | Ctn. Qty. |
|-------------|------|---|--------------|-----------|
| 42086 | 2" | 101 PS ABS Solvent Weld Shower Drain w/plastic strainer | 038753420868 | 12 |
| 42089 | 2" | 101 PS PVC Solvent Weld Shower Drain w/plastic strainer | 038753420899 | 12 |
| 42093 | 2" | 101 PS ABS Solvent Weld Shower Drain w/stainless steel strainer | 038753420936 | 12 |
| 42097 | 2" | 101 PS PVC Solvent Weld Shower Drain w/stainless steel strainer | 038753420974 | 12 |



Oatey® 102 Series Solvent Weld Shower Drain With Receptor Base

- Solvent weld over 2" Sch. 40 DWV pipe.
- Universal 4-1/4" Snap-Tite Strainer.
- Drain body is sealed to shower base with rubber gasket and fiber slip washer.

| Product No. | Size | Description | UPC | Ctn. Qty. |
|-------------|------|--|--------------|-----------|
| 42033 | 2" | 2-part ABS Solvent Weld Shower Drain w/brushed nickel square strainer | 038753420332 | 12 |
| 42034 | 2" | 2-part ABS Solvent Weld Shower Drain w/stainless steel square strainer | 038753420448 | 12 |
| 42035 | 2" | 2-part PVC Solvent Weld Shower Drain w/brushed nickel square strainer | 038753420356 | 12 |
| 42036 | 2" | 2-part PVC Solvent Weld Shower Drain w/stainless steel square strainer | 038753420363 | 12 |
| 42044 | 2" | 2-part ABS Solvent Weld Shower Drain w/stainless steel strainer | 038753420448 | 12 |
| 42045 | 2" | 2-part PVC Solvent Weld Shower Drain w/stainless steel strainer | 038753420455 | 12 |
| 42049 | 2" | 2-part PVC Solvent Weld Shower Drain w/plastic strainer | 038753420493 | 12 |
| 42052 | 2" | 2-part ABS Solvent Weld Shower Drain w/matte black round strainer | 038753420523 | 12 |
| 42053 | 2" | 2-part ABS Solvent Weld Shower Drain w/matte black square strainer | 038753420530 | 12 |



Oatey® 103 Series Offset Solvent Weld Shower Drain With Receptor Base

- Designed for use with preformed shower stall bases.
- Solvent weld over 2" Sch. 40 DWV pipe.
- Universal 4-1/4" Snap-Tite Strainer.
- Drain body provides 1-1/2" offset to work around joists and imperfect slab penetrations.
- Drain body is sealed to shower base with rubber gasket and fiber slip washer.

| Product No. | Size | Description | UPC | Ctn. Qty. |
|-------------|------|---------------------|--------------|-----------|
| 42787 | | 2" PVC Offset Drain | 038753427874 | 8 |
| 42788 | | 2" ABS Offset Drain | 038753427881 | 8 |

CAULKING AND THREADING SHOWER DRAINS



Oatey® 101 Series Brass NPT And Caulking Drain

- Drain body is sealed to shower base with rubber gasket and fiber slip washer.
- Three DWV connection methods for metallic pipe.
- Universal 4-1/4" Snap-Tite Strainer.

| Product No. | Size | Description | UPC | Ctn. Qty. |
|-------------|--------|--------------------------------|--------------|-----------|
| 42070 | 1-1/2" | 101NPT1.5-BRASS DRN w/FMLE IPS | 038753420707 | 6 |

SHOWER DRAINS FOR BUILT-UP SHOWERS

Oatey® 130 Series Shower Drain For Tile Shower Bases

- Designed for use on built-up shower bases of tile or marble, where a shower pan liner is used.
- Quarter turn reusable test plug available
- Base features four countersunk holes to secure to the substrate/deck
- Low profile design for use in tight spaces.
- Solvent welds over 2" or inside 3" Schedule 40 DWV pipe.
- Reversible clamping collar is secured with stainless steel bolts into brass inserts to prevent stripping.
- Tile ring helps preserve grout lines



130 Series ABS Complete Drain Assemblies

| Product No. | Size | Description | UPC | Ctn. Qty. |
|-------------|----------|--|--------------|-----------|
| 42267 | 2" or 3" | Square Low Profile Drain Polished SS Screw-In Strainer w/Ring | 038753422671 | 12 |
| 42274 | 2" or 3" | Square Low Profile Drain Polished SS Screw-In Strainer w/Ring w/Plug | 038753422749 | 12 |
| 42265 | 2" or 3" | Square Low Profile Drain Polished SS Snap-In Strainer w/Ring | 038753422657 | 12 |
| 42262 | 2" or 3" | Round Low Profile Drain Polished SS Screw-In Strainer w/Ring | 038753422626 | 12 |
| 42272 | 2" or 3" | Round Low Profile Drain Polished SS Screw-In Strainer w/Ring w/ Plug | 038753422725 | 12 |
| 42260 | 2" or 3" | Round Low Profile Drain Polished SS Snap-In Strainer w/Ring | 038753422602 | 12 |

130 Series ABS Barrel With Strainer (to be used with drain base)

| Product No. | Size | Description | UPC | Ctn. Qty. |
|-------------|----------|---|--------------|-----------|
| ABS | | | | |
| 42276 | 2" or 3" | Square Barrel With Polished SS Screw-In Strainer w/Ring | 038753422763 | 12 |
| 42278 | 2" or 3" | Square Barrel With Brushed Nickel Screw-In Strainer w/Ring | 038753422787 | 12 |
| 42280 | 2" or 3" | Square Barrel With Oil Rubbed Bronze Screw-In Strainer w/Ring | 038753422800 | 12 |
| 42288 | 2" or 3" | Square Barrel With Polished SS Snap-In Strainer w/Ring | 038753422886 | 12 |
| 42290 | 2" or 3" | Square Barrel With Brushed Nickel Snap-In Strainer w/Ring | 038753422909 | 12 |
| 42292 | 2" or 3" | Square Barrel With Oil Rubbed Bronze Snap-In Strainer w/Ring | 038753422923 | 12 |
| 42282 | 2" or 3" | Round Barrel With Polished SS Screw In Strainer w/Ring | 038753422824 | 12 |
| 42284 | 2" or 3" | Round Barrel With Brushed Nickel Screw-In Strainer w/Ring | 038753422848 | 12 |
| 42286 | 2" or 3" | Round Barrel With Oil Rubbed Bronze Screw-In Strainer w/Ring | 038753422862 | 12 |
| 42294 | 2" or 3" | Round Barrel With Polished SS Snap-In Strainer w/Ring | 038753422947 | 12 |
| 42296 | 2" or 3" | Round Barrel With Brushed Nickel Snap-In Strainer w/Ring | 038753422961 | 12 |
| 42298 | 2" or 3" | Round Barrel With Oil Rubbed Bronze Snap-In Strainer w/Ring | 038753422985 | 12 |
| 42261 | 2" or 3" | Round Low Profile Drain Polished SS Snap-In Strainer w/Ring | 038753422619 | 12 |



SHOWER DRAINS FOR BUILT-UP SHOWERS



Gray PVC Shown

130 Series PVC Complete Drain Assemblies

| Product No. | Size | Description | UPC | Ctn. Qty. |
|-------------|----------|--|--------------|-----------|
| 42266 | 2" or 3" | Square Low Profile Drain Polished SS Screw-In Strainer w/Ring | 038753422664 | 12 |
| 42273 | 2" or 3" | Square Low Profile Drain Polished SS Screw-In Strainer w/Ring w/Plug | 038753422732 | 12 |
| 42264 | 2" or 3" | Square Low Profile Drain Polished SS Snap-In Strainer w/Ring | 038753422640 | 12 |
| 42263 | 2" or 3" | Round Low Profile Drain Polished SS Screw-In Strainer w/Ring | 038753422633 | 12 |
| 42271 | 2" or 3" | Round Low Profile Drain Polished SS Screw-In Strainer w/Ring w/Plug | 038753422718 | 12 |
| 42260 | 2" or 3" | Round Low Profile Drain Polished SS Snap-In Strainer w/Ring | 038753422602 | 12 |

Oatey® 130 Series PVC Barrel with Strainer (to be used with drain base)

| Product No. | Size | Description | UPC | Ctn. Qty. |
|-------------|----------|---|--------------|-----------|
| 42275 | 2" or 3" | Square Barrel With Polished SS Screw-In Strainer w/Ring | 038753422756 | 12 |
| 42277 | 2" or 3" | Square Barrel With Brushed Nickel Screw-In Strainer w/Ring | 038753422770 | 12 |
| 42279 | 2" or 3" | Square Barrel With Oil Rubbed Bronze Screw-In Strainer w/Ring | 038753422794 | 12 |
| 42287 | 2" or 3" | Square Barrel With Polished SS Snap-In Strainer w/Ring | 038753422879 | 12 |
| 42289 | 2" or 3" | Square Barrel With Brushed Nickel Snap-In Strainer w/Ring | 038753422893 | 12 |
| 42291 | 2" or 3" | Square Barrel With Oil Rubbed Bronze Snap-In Strainer w/Ring | 038753422916 | 12 |
| 42281 | 2" or 3" | Square Barrel With Oil Rubbed Bronze Snap-In Strainer w/Ring | 038753422817 | 12 |
| 42283 | 2" or 3" | Round Barrel With Brushed Nickel Screw-In Strainer w/Ring | 038753422831 | 12 |
| 42285 | 2" or 3" | Round Barrel With Oil Rubbed Bronze Screw-In Strainer w/Ring | 038753422855 | 12 |
| 42293 | 2" or 3" | Round Barrel With Polished SS Snap-In Strainer w/Ring | 038753422930 | 12 |
| 42295 | 2" or 3" | Round Barrel With Brushed Nickel Snap-In Strainer w/Ring | 038753422954 | 12 |
| 42297 | 2" or 3" | Round Barrel With Oil Rubbed Bronze Snap-In Strainer w/Ring | 038753422978 | 12 |



130 Series ABS/PVC Drain Base

| Product No. | Size | Description | UPC | Ctn. Qty. |
|-------------|------|--|--------------|-----------|
| 42268 | | PVC Low Profile Drain Base Clamping Collar And Fasteners | 038753422688 | 12 |
| 42269 | | ABS Low Profile Drain Base Clamping Collar And Fasteners | 038753422695 | 40 |

130 Series Test Plug

| Product No. | Size | Description | UPC | Ctn. Qty. |
|-------------|------|----------------------|--------------|-----------|
| 42270 | | 130 Series Test Plug | 038753422701 | 12 |



SHOWER DRAINS FOR BUILT-UP SHOWERS



#42201 shown

Oatey® 151 Series Cast Iron And Plastic Two Part Shower Drain

- Designed for use with tile and marble showers.
- Cast iron or plastic variations with threaded, No-Calk or solvent weld connections.
- 3-1/4" Crown Ring Set.

| Product No. | Size | Description | UPC | Ctn. Qty. |
|-------------|--------|--|--------------|-----------|
| 42192 | 1-1/2" | 151 cast iron w/ 1-1/2" NPT connection | 038753421926 | 6 |
| 42197 | 2" | 151 cast iron w/ 2" NPT connection | 038753421971 | 6 |
| 42201 | 2" | 151 cast iron w/ 2" Sch. 40 No-calk connection | 038753422015 | 6 |
| 42206 | 2" | 151 cast iron w/ 2" No Hub connection | 038753422060 | 6 |
| 42211 | 2" | 151 ABS drain w/ 2" solvent weld connection | 038753422114 | 6 |
| 42215 | 2" | 151 cast iron drain top & ABS bottom w/ 2" solvent weld connection | 038753422152 | 6 |



Oatey® Designline Decorative Shower Drains

- Designline by Oatey offers rugged dependability under the seamless sophistication of the latest, tasteful, graceful flair in plumbing.
- Made of 304 grade stainless steel construction.
- Every drain channel comes fully assembled and ready to install. Accessories included, provide compatibility with both PVC and CPE waterproofing liners.



#DLS2360R2 shown

| Product No. | Description | UPC | Ctn. Qty. |
|-------------|--|--------------|-----------|
| DSS2040R2 | 4" X 4" Square Shower Drain (Square) SS | 038753905402 | 3 |
| DS32040 | 4" X 4" Square Shower Drain (Square) Matte Black | 038753905518 | 3 |
| DSS1040R2 | 4" X 4" Square Shower Drain (Tile-In) SS | 038753905396 | 3 |
| DSS2060R2 | 6" X 6" Square Shower Drain (Square) SS | 038753905433 | 3 |
| DS32060 | 6" X 6" Square Shower Drain (Square) Matte Black | 038753905631 | 3 |
| DSS1060R2 | 6" X 6" Square Shower Drain (Tile-In) SS | 038753905426 | 3 |
| DS32060 | 6" x 6" Square Shower Drain (Square) Matte Black | 038753905631 | 3 |
| DLS2240R2 | 24" Linear Shower Drain (Square) SS | 038753905310 | 2 |
| DL32240 | 24" Linear Shower Drain (Square) Matte Black | 038753905730 | 2 |
| DLS1240R2 | 24" Linear Shower Drain (Tile-In) SS | 038753905303 | 2 |
| DLS2280R2 | 28" Linear Shower Drain (Square) SS | 038753905334 | 2 |
| DL32280 | 28" Linear Shower Drain (Square) Matte Black | 038753905822 | 2 |
| DLS2360R2 | 36" Linear Shower Drain (Square) SS | 038753905389 | 2 |
| DLS1360R2 | 36" Linear Shower Drain (Tile-In) SS | 038753905372 | 2 |

- use with 130 Series Drain Base

REPLACEMENT STRAINERS

Oatey® 130 Series Carded Replacement Strainers



| Product No. | Size | Description | UPC | Ctn. Qty. |
|-------------|----------|--|--------------|-----------|
| 42330 | 2" or 3" | Square Screw-In Shower Strainer w/Ring - Polished SS | 038753423302 | 4 |
| 42331 | 2" or 3" | Square Screw-In Shower Strainer w/Ring - Brushed Nickel | 038753423319 | 4 |
| 42332 | 2" or 3" | Square Screw-In Shower Strainer w/Ring - Oil Rubbed Bronze | 038753423326 | 4 |
| 42336 | 2" or 3" | Square Snap-In Shower Strainer w/Ring - Polished SS | 038753423364 | 4 |
| 42337 | 2" or 3" | Square Snap-In Shower Strainer w/Ring - Brushed Nickel | 038753423371 | 4 |
| 42338 | 2" or 3" | Square Snap-In Shower Strainer w/Ring - Oil Rubbed Bronze | 038753423388 | 4 |
| 42333 | 2" or 3" | Round Screw-In Shower Strainer w/Ring - Polished SS | 038753423333 | 4 |
| 42334 | 2" or 3" | Round Screw-In Shower Strainer w/Ring - Brushed Nickel | 038753423340 | 4 |
| 42335 | 2" or 3" | Round Screw-In Shower Strainer w/Ring - Oil Rubbed Bronze | 038753423357 | 4 |
| 42339 | 2" or 3" | Round Snap-In Shower Strainer w/Ring - Polished SS | 038753423395 | 4 |
| 42340 | 2" or 3" | Round Snap-In Shower Strainer w/Ring - Brushed Nickel | 038753423401 | 4 |
| 42341 | 2" or 3" | Round Snap-In Shower Strainer w/Ring - Oil Rubbed Bronze | 038753423418 | 4 |

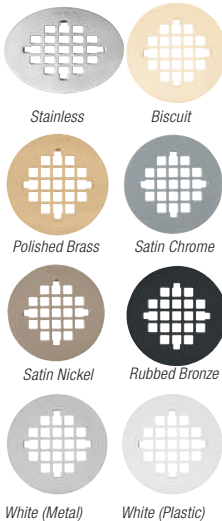

Oatey® 4-1/4" Snap-Tite Strainer

- For 101BR, 101PNC, 101NPT, 101PS, 102, 103, and 131 Series Shower Drains with round strainers.
- UltraShine® PVD lifetime finish where noted.
- For series 101BR, 101PNC, 101NPT, 101PS, 102, 103, 13D, 140 NC Series Shower Drains.

| Product No. | Size | Description | UPC | Ctn. Qty. |
|-------------|--------|---|--------------|-----------|
| 42003 | 4-1/4" | Carded White Plastic – carded - Round | 038753420035 | 12 |
| 42004 | 4-1/4" | UltraShine® PVD Polished Brass – carded - Round | 038753420042 | 12 |
| 42005 | 4-1/4" | Stainless Steel – carded - Round | 038753420059 | 12 |
| 42014 | 4-1/4" | UltraShine® PVD Satin Nickel – carded - Round | 038753420141 | 4 |
| 42015 | 4-1/4" | UltraShine® PVD Satin Chrome – carded - Round | 038753420158 | 4 |
| 42016 | 4-1/4" | Biscuit – carded - Round | 038753420165 | 4 |
| 42017 | 4-1/4" | Rubbed Bronze – carded - Round | 038753420172 | 4 |
| 42018 | 4-1/4" | Brushed Nickel – carded - Round | 038753420189 | 4 |
| 42019 | 4-1/4" | White Metal – carded - Round | 038753420196 | 4 |
| 42140 | 4-1/4" | Brushed Nickel - Square | 038753421407 | 66 |

Oatey® 4" Screw-Tite Strainer

- For screw-on tile shower drains and 2" x 3" slab shower drains.
- Polished brass strainers have PVD lifetime finish.
- For 130 and 131 Series Shower Drains and 43566, 43567, 43578, 43579, 43580, 43581.

| Product No. | Size | Description | UPC | Ctn. Qty. |
|-------------|------|---|--------------|-----------|
| 43862 | 4" | UltraShine® PVD Polished Brass – carded | 038753438627 | 12 |

Oatey® Stainless Steel Snap-In Strainer

- Fits inside Schedule 40 DWV pipe.

| Product No. | Size | Description | UPC | Ctn. Qty. |
|-------------|------|----------------------------------|--------------|-----------|
| 42730 | 2" | Snap-In Stainless Steel Strainer | 038753427300 | 12 |
| 42731 | 3" | Snap-In Stainless Steel Strainer | 038753427317 | 12 |
| 42732 | 4" | Snap-In Stainless Steel Strainer | 038753427324 | 12 |

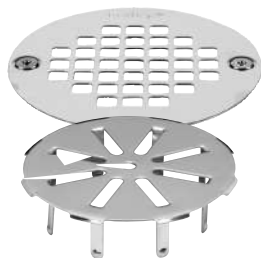

GENERAL PURPOSE DRAINS



Oatey® Short General Purpose Drain

- Fits over 2" or inside of 3" Sch. 40 DWV pipe.
- Only 3 cm high for tight spaces.
- Removable 4" stainless steel strainer.

| Product No. | Size | Description | UPC | Ctn. Qty. |
|-------------|----------|---|--------------|-----------|
| 43580 | 2" or 3" | ABS short general purpose drain w/ 4" stainless steel Screw-Tite strainer | 038753435800 | 12 |
| 43581 | 2" or 3" | PVC short general purpose drain w/ 4" stainless steel Screw-Tite strainer | 038753435817 | 12 |



#43579 shown

Oatey® General Purpose Drain

| Product No. | Size | Description | UPC | Ctn. Qty. |
|-------------|----------|---|--------------|-----------|
| 43578 | 2" or 3" | ABS general purpose drain w/ 4" stainless steel Screw-Tite strainer | 038753435787 | 12 |
| 43579 | 2" or 3" | PVC general purpose drain w/ 4" stainless steel Screw-Tite strainer | 038753435794 | 12 |
| 43582 | 3" or 4" | ABS general purpose drain w/ 5" stainless steel Screw-Tite strainer | 038753435824 | 12 |
| 43583 | 3" or 4" | PVC general purpose drain w/ 5" stainless steel Screw-Tite strainer | 038753435831 | 12 |



#43599 shown

Oatey® Light Duty Utility Drains

| | | | | |
|-------|----------|--|--------------|----|
| 43598 | 3" or 4" | ABS general purpose drain w/ 5" brass grate and metal ring | 038753435985 | 12 |
| 43599 | 3" or 4" | PVC general purpose drain w/ 5" brass grate and ring | 038753435992 | 12 |
| 43600 | 3" or 4" | ABS general purpose drain w/ 5" nickel alloy grate | 038753436005 | 12 |
| 43601 | 3" or 4" | PVC general purpose drain w/ 5" nickel grate | 038753436012 | 12 |

Oatey® All Plastic Drain

- Also suitable for use as a vent stack or air inlet strainer.



| Product No. | Size | Description | UPC | Ctn. Qty. |
|-------------|------|-------------------|--------------|-----------|
| 43560 | 2" | ABS Snap-In Drain | 038753435602 | 12 |
| 43561 | 2" | PVC Snap-In Drain | 038753435619 | 12 |
| 43564 | 3" | ABS Snap-In Drain | 038753435640 | 12 |
| 43565 | 3" | PVC Snap-In Drain | 038753435657 | 12 |
| 43568 | 4" | ABS Snap-In Drain | 038753435688 | 12 |
| 43569 | 4" | PVC Snap-In Drain | 038753435695 | 12 |

GENERAL PURPOSE DRAINS



Plastic Drain With Removable Stainless Steel Strainer

- Strainer can be removed to allow access to the pipe.

| Product No. | Size | Description | UPC | Ctn. Qty. |
|-------------|------|--|--------------|-----------|
| 43562 | 3" | ABS Snap-In Drain w/ 3-1/2" Stainless Steel Strainer | 038753435626 | 12 |
| 43563 | 3" | PVC Snap-In Drain w/ 3-1/2" Stainless Steel Strainer | 038753435633 | 12 |
| 43566 | 4" | ABS Snap-In Drain w/ 4" Stainless Steel Strainer | 038753435664 | 12 |
| 43567 | 4" | PVC Snap-In Drain w/ 4" Stainless Steel Strainer | 038753435671 | 12 |



All Plastic Outlet Cover

- For covering an open pipe.
- Protects piping from dirt and debris.

| Product No. | Size | Description | UPC | Ctn. Qty. |
|-------------|------|--------------------------------|--------------|-----------|
| 43572 | 3" | ABS Snap-In Drain Outlet Cover | 038753435725 | 12 |
| 43573 | 3" | PVC Snap-In Drain Outlet Cover | 038753435732 | 12 |



Bell Trap Drain

- Fits over 1-1/2" Sch. 40 DWV pipe or into 2" coupling.
- Fits over 3" or inside of 4" Sch. 40 DWV pipe.

| Product No. | Size | Description | UPC | Ctn. Qty. |
|-------------|----------|-----------------------------|--------------|-----------|
| 43632 | 3" or 4" | ABS 9" x 9" Bell Trap Drain | 038753436326 | 4 |
| 43633 | 3" or 4" | PVC 9" x 9" Bell Trap Drain | 038753436333 | 4 |
| 43636 | 1-1/2" | ABS 6" x 6" Bell Trap Drain | 038753436364 | 4 |
| 43637 | 1-1/2" | PVC 6" x 6" Bell Trap Drain | 038753436371 | 10 |



Utility Drain

- Fits over 1-1/2" Sch. 40 DWV pipe or into 2" coupling.

| Product No. | Size | Description | UPC | Ctn. Qty. |
|-------------|--------|---------------------------|--------------|-----------|
| 43640 | 1-1/2" | ABS 6" x 6" Utility Drain | 038753436401 | 10 |
| 43641 | 1-1/2" | PVC 6" x 6" Utility Drain | 038753436418 | 10 |



Four-Way Area Drain

- Fits over 2" or 3" Schedule 40 DWV pipe.
- General purpose drain for use in garages and utility rooms.
- Sump for large capacity.

| Product No. | Size | Description | UPC | Ctn. Qty. |
|-------------|----------|--------------------------|--------------|-----------|
| 43596 | 2" or 3" | Four-Way Area Drain, PVC | 038753435961 | 10 |



Integral Trap Drain

- One piece trap drain/cleanout design molded from PVC or ABS plastic.
- 3-3/4" deep sump bowl.
- Solvent weld over 2" Sch. 40 DWV pipe.
- Built in 2" FIP threadway for backwater device.
- ASTM 2665 and ASTM D2661.
- Internal 1-1/2" – 14 NPT – cleanout.

| Product No. | Size | Description | UPC | Ctn. Qty. |
|-------------|------|--|--------------|-----------|
| 42723 | 2" | ABS Floor Drain with P-Trap and Cleanout | 038753427232 | 2 |
| 42724 | 2" | PVC Floor Drain with P-Trap and Cleanout | 038753427249 | 2 |
| 42725 | 2" | Backwater Valve Device | 038753427256 | 6 |

CLEANOUT ASSEMBLIES



Oatey® All Plastic 2" x 3" Snap-In Cleanout Assemblies

| Product No. | Size | Description | UPC | Ctn. Qty. |
|-------------|----------|-------------------------------|--------------|-----------|
| 43710 | 2" or 3" | ABS Snap-In Cleanout Assembly | 038753437101 | 12 |
| 43711 | 2" or 3" | PVC Snap-In Cleanout Assembly | 038753437118 | 12 |



#43733 shown

Oatey® All Plastic Snap-In Cleanout Assemblies

• Fits inside of Sch. 40 DWV pipe fitting.

| Product No. | Size | Description | UPC | Ctn. Qty. |
|-------------|--------|--|--------------|-----------|
| 43730 | 3" | ABS Snap-In Cleanout Assembly | 038753437309 | 12 |
| 43731 | 3" | PVC Snap-In Cleanout Assembly | 038753437316 | 12 |
| 43732 | 4" | ABS Snap-In Cleanout Assembly | 038753437323 | 12 |
| 43733 | 4" | PVC Snap-In Cleanout Assembly | 038753437330 | 12 |
| 43764 | 2-1/3" | ABS Replacement Plug for the 3" and the 2" or 3" cleanout assemblies | 038753437644 | 6 |
| 43765 | 2-1/3" | PVC Replacement Plug for the 3" and the 2" or 3" cleanout assemblies | 038753437651 | 6 |
| 43766 | 3-1/2" | ABS Replacement Plug for the 4" regular and the 3" Hub cleanout assemblies | 038753437668 | 1 |
| 43767 | 3-1/2" | PVC Replacement Plug for the 4" regular and the 3" Hub cleanout assemblies | 038753437675 | 6 |



#42745 shown

Oatey® Brass Cleanout Plug With Recessed Head

• All sizes are countersunk and tapped.

| Product No. | Size | Description | UPC | Ctn. Qty. |
|-------------|--------|---------------------|--------------|-----------|
| 42740 | 1-1/2" | Brass Cleanout Plug | 038753427409 | 12 |
| 42741 | 2" | Brass Cleanout Plug | 038753427416 | 12 |
| 42742 | 2-1/2" | Brass Cleanout Plug | 038753427423 | 12 |
| 42743 | 3" | Brass Cleanout Plug | 038753427430 | 12 |
| 42744 | 3-1/2" | Brass Cleanout Plug | 038753427447 | 12 |
| 42745 | 4" | Brass Cleanout Plug | 038753427454 | 12 |

CLEANOUT ASSEMBLIES



Oatey® Cover Plate

- Cover plates conceal the clean-out plug access hole.
- Packaged with 1/4" screw.

| Product No. | Size | Description | UPC | Ctn. Qty. |
|-------------|--------------|-------------------------|--------------|-----------|
| 34405 | 4" (10.2 cm) | Flat Chrome Cover Plate | 038753344058 | 25 |
| 34406 | 5" (12.7 cm) | Flat Chrome Cover Plate | 038753344065 | 25 |
| 34410 | 4" (10.2 cm) | Flat White Cover Plate | 038753344102 | 25 |
| 34411 | 5" (12.7 cm) | Flat White Cover Plate | 038753344119 | 25 |
| 34415 | 4" (10.2 cm) | Bell Chrome Cover Plate | 038753344157 | 25 |
| 34416 | 5" (12.7 cm) | Bell Chrome Cover Plate | 038753344164 | 25 |
| 34420 | 4" (10.2 cm) | Bell White Cover Plate | 038753344201 | 25 |
| 34421 | 5" (12.7 cm) | Bell White Cover Plate | 038753344218 | 25 |



Oatey® Stainless Steel Cover Plate

- Stainless steel cover plates conceal the clean-out plug access hole.
- Protective film cover.
- 1/4" – 20 screw included.

| Product No. | Size | Description | UPC | Ctn. Qty. |
|-------------|--------------|-----------------------------|--------------|-----------|
| 42780 | 3" (7.6 cm) | Stainless steel cover plate | 038753427805 | 12 |
| 42781 | 4" (10.2 cm) | Stainless steel cover plate | 038753427812 | 12 |
| 42782 | 5" (12.7 cm) | Stainless steel cover plate | 038753427829 | 12 |
| 42783 | 6" (15.2 cm) | Stainless steel cover plate | 038753427836 | 12 |
| 42784 | 8" (20.3 cm) | Stainless steel cover plate | 038753427843 | 12 |

MASTERS® Urinal Cleanout Covers

- Round stainless steel cover attached with tightening screw to expandable test plug in various sizes
- Includes hex key for easy installation
- Total unit depth is 1-3/4"



| Product No. | Plug Size | Description | UPC | Ctn. Qty. |
|-------------|-----------|--|--------------|-----------|
| UC150 | 1.5" | MASTERS Urinal Cleanout Cover with 1.5" plug, 4.5" cover | 067001002013 | 1 |
| UC200 | 2.0" | MASTERS Urinal Cleanout Cover with 2.0" plug, 4.5" cover | 067001002020 | 1 |
| UC300 | 3.0" | MASTERS Urinal Cleanout Cover with 3.0" plug, 4.5" cover | 067001002068 | 1 |
| UC400 | 4.0" | MASTERS Urinal Cleanout Cover with 4.0" plug, 4.5" cover | 067001002082 | 1 |
| UC300-L | 3.0" | MASTERS Urinal Cleanout Cover with 3.0" plug, 8.0" cover | 067001002075 | 1 |
| UC400-L | 4.0" | MASTERS Urinal Cleanout Cover with 4.0" plug, 8.0" cover | 067001002099 | 1 |

BACKWATER VALVES



Oatey® Backwater Valves

- Protects low areas or basements from backflow or waste from street sewers.
- Elastomeric seal in quick action flapper ensures a water tight seal.
- Threaded access cap incorporates a neoprene seal for positive sealing and can be tightened or removed by hand.
- Valve hub fits DWV pipe and can be adapted for sewer and drain pipe.

| Product No. | Size | Description | UPC | Ctn. Qty. |
|-------------|------|---------------------|--------------|-----------|
| 43900 | 3" | PVC backwater valve | 038753439006 | 4 |
| 43901 | 3" | ABS backwater valve | 038753439013 | 4 |
| 43904 | 4" | PVC backwater valve | 038753439044 | 2 |
| 43905 | 4" | ABS backwater valve | 038753439051 | 2 |
| 43908 | 6" | PVC backwater valve | 038753439082 | 1 |
| 43909 | 6" | ABS backwater valve | 038753439099 | 1 |

Oatey® Backwater Accessories

| Product No. | Size | Description | UPC | Ctn. Qty. |
|-------------|------|----------------------|--------------|-----------|
| 43915 | 3" | PVC threaded cap | 038753439150 | 1 |
| 43918 | 4" | PVC threaded cap | 038753439181 | 1 |
| 43919 | 4" | ABS threaded cap | 038753439198 | 1 |
| 43924 | 3" | PVC flapper w/O-ring | 038753439242 | 1 |
| 43927 | 4" | PVC flapper w/O-ring | 038753439273 | 1 |
| 43929 | 6" | PVC flapper w/O-ring | 038753439297 | 1 |

ACCESSORIES



Oatey® Traps

- One-piece design.
- Made from 3/4" PVC Schedule 40 DWV pipe.

| Product No. | Size | Description | UPC | Ctn. Qty. |
|-------------|------|-----------------------------|--------------|-----------|
| 42757 | 3/4" | PVC Condensate "P"-trap | 038753427577 | 24 |
| 42758 | 3/4" | PVC Condensate Running Trap | 038753427584 | 24 |



Oatey® Mushroom Vent Cap

- Fits either 3" or 4" vent stacks.
- Shipped fully assembled.
- Includes 3 hex-head bolts.
- Made of high-impact PVC.

| Product No. | Size | Description | UPC | Ctn. Qty. |
|-------------|----------|-------------------|--------------|-----------|
| 43805 | 3" or 4" | Mushroom Vent Cap | 038753438054 | 12 |



Oatey® Mystic Rainwater Diverter

- Rainwater collection system.
- Directs rainwater from downspouts into collection barrels for re-use in lawn/garden watering.
- Can be painted.
- Includes 1.2 m hi-flo hose.

| Product No. | Size | Description | UPC | Ctn. Qty. |
|-------------|------|------------------------|--------------|-----------|
| 14211 | 3" | Rainwater Diverter Kit | 038753142111 | 4 |



designline[®]

Designline by Oatey offers rugged dependability under the seamless sophistication of the latest, tasteful, graceful flair in plumbing.



CATEGORY **9** DRAINS AND CLOSET FLANGES



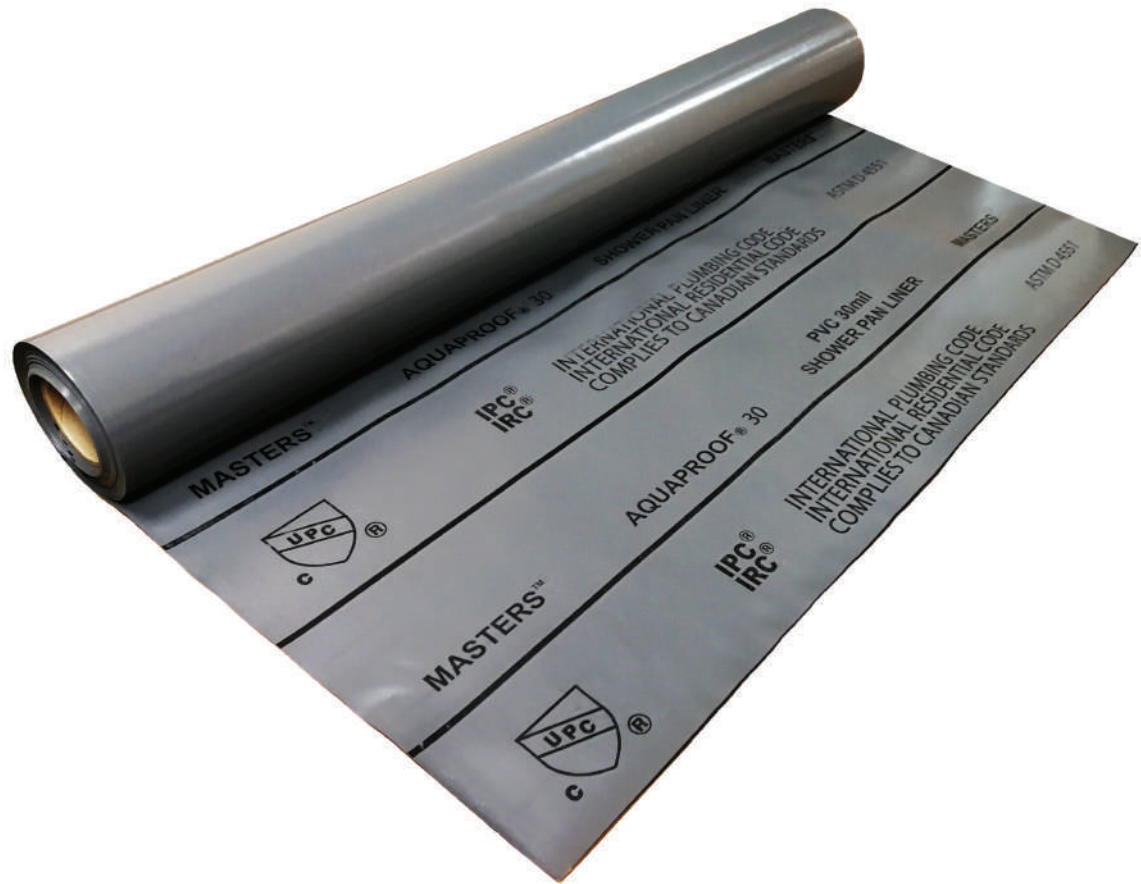

Category 10

Shower Systems

MASTERS® and Oatey® Shower systems and accessories are designed as an economical, flexible pan liner for use in tile shower and other concealed water-proofing applications. Shower systems are available in 30 mil or 40 mil thickness, and widths of 4' (1.2 m), 5' (1.5 m) or 6' (1.8 m). Liner is marked every 6" (15.2 cm) to allow for easy measuring of material.

SHOWER SYSTEMS

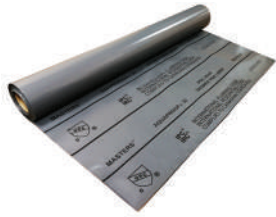

MASTERS® Aquaproof

- 30 mil thick grey PVC shower pan liner marked every 6" for easy cutting
- Creates permanent waterproofing under tile, concrete, etc.
- Meets ASTM D 4551, cUPC listed, IPC & IRC Compliant

| Product No. | Size | Description | UPC | Roll |
|-------------|---------------------------|------------------------------------|--------------|------|
| AQ430 | 30 mil 4' x 50' Roll | MASTERS Aquaproof Shower Pan Liner | 067001000194 | 1 |
| AQ530 | 30 mil 5' x 40' Roll | MASTERS Aquaproof Shower Pan Liner | 067001000200 | 1 |
| AQ630 | 30 mil 6' x 33.3' Roll | MASTERS Aquaproof Shower Pan Liner | 067001001528 | 1 |



Oatey® Shower Systems

- Economical, time-tested flexible pan liner.
- 40 mil thick gray PVC Shower System
- Liner marked in 15.2 cm (6 in) increments for ease of measuring.
- Dam corners available.
- Meets ASTM Standard D4551.
- Superior cold weather characteristics.

| Product No. | Size | Description | UPC | Linear Ft. |
|-------------|------------------------------|---|--------------|------------|
| 41594 | 5' x 40 ft. / 12.7 x 12.2 m | 40 mil Gray – Linear Foot – Roll | 038753415949 | 40 |
| 41619 | 6' x 50 ft. / 15.2 x 12.2 m | 40 mil Gray – Linear Foot – Roll | 038753416199 | 50 |
| 41626 | 5' x 40 ft. / 12.7 x 12.2 m | 40 mil Gray – Linear Foot – Roll | 038753416267 | 40 |
| 41627 | 5' x 100 ft. / 12.7 x 30.5 m | 40 mil Gray – Linear Foot – Roll | 038753416274 | 100 |
| 41628 | 6' x 100 ft. / 15.2 x 30.5 m | 40 mil Gray – Linear Foot – Roll | 038753416281 | 100 |
| 41620 | 5' x 6 ft. / 12.7 x 1.8 m | 40 mil Gray – Liner Kit: Includes (2) 40 mil Corner Dams | 038753416205 | 4 Ctn.Qty. |

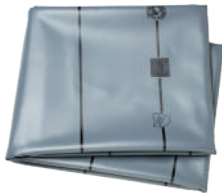

#41620 shown

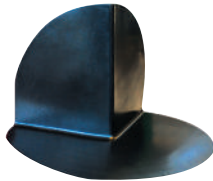

Oatey® Corner Dam

- Corner dams have universal design for right or left corners.
- Corner dams for use at junction of curb and door jamb.
- Made of 40 mil PVC.

| Product No. | Size | Description | UPC | Ctn. Qty. |
|-------------|------|--------------------------|--------------|-----------|
| 41602 | | Corner Dams – 40 mil PVC | 038753416021 | 48 |



Oatey® Perfect Slope

- Creates a code required slope under shower systems
- Install a perfect shower slope that requires half the mortar

| Product No. | Size | Description | UPC | Ctn. Qty. |
|-------------|---------|--------------------------------------|--------------|-----------|
| 41644 | 40 x 40 | Tile Shower Pre-Slope Base | 038753416441 | 2 |
| 41646 | 40 x 20 | Tile Shower Pre-Slope Base Extension | 038753416465 | 2 |



Oatey® LO-VOC X-15™ PVC Solvent

- X-15 PVC solvent is specially formulated for extended working times.
- Meets California and other environmental district rules.
- X-15 PVC solvent provides exceptional sheet to sheet bonding.
- Use ONLY on PVC shower systems.

| Product No. | Size | Description | UPC | Ctn. Qty. |
|-------------|---------------|--------------------|--------------|-----------|
| 48034 | 16 oz./473 ml | X-15 Bond Adhesive | 038753480343 | 6 |



Dura Pro Contact Cement

- For joining PVC to sub floor

| Product No. | Size | Description | UPC | Ctn. Qty. |
|-------------|--------|--------------------------------------|--------------|-----------|
| CC-24 | 946 ml | DURA PRO Contact Cement Flat Top Can | 058751241005 | 6 |

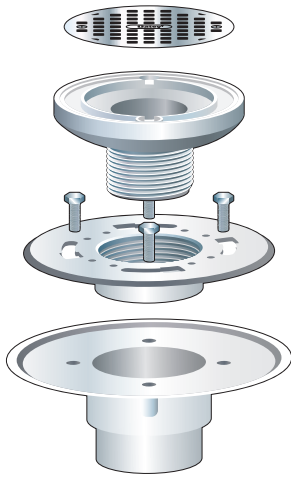

Oatey® provides several products needed for tile shower installations. Choose from the list below before you start your project:

PVC or CPE Pan Liner – referred to as pan liner or membrane in our instructions.

Tile Shower Drain – PVC for PVC drain pipe or ABS for ABS drain pipe. Each is available with stainless steel, polished brass or white plastic strainer.

X-15 or CPE (Oateyweld) bonding adhesive – For use on dam corners or seaming use X-15 for PVC and Oateyweld for CPE.

PVC or ABS solvent cement – PVC solvent cement and primer for PVC drainage systems or ABS solvent cement for ABS drainage systems. Use the appropriate cement (and primer for PVC) to solvent weld tile shower drain to the drain pipe.

Dam Corners – For outside corners and over the curb preformed dam corners are available, which can be used for PVC or CPE pan liner applications.

NOTE: Oatey pan liner instructions assume the shower framing has been constructed and the flooring is plywood. Generally the same principles apply to concrete flooring where the sloped mortar bed is applied beneath the pan liner. Also the instructions apply to either PVC pan liner or CPE pan liner which are installed the same with the exception of the bonding adhesive used for seaming and dam corner applications. If you have questions regarding pan liner installation that are not covered in these instructions, contact Oatey customer service at 800-321-9532 and you will be referred to someone who can assist you.

Shower Pan Installation

1. For typical wood subfloor cut a 11.4 cm diameter hole in the center of the shower floor where the tile shower drain would normally be positioned. Disassemble the tile shower drain. Lay the tile shower drain base in the opening so the flange of the drain base rests on top of the subfloor. Solvent weld the drain base to the drain pipe using the appropriate solvent cement. See Figure A.
2. Cover the drain base opening with duct tape to keep debris from entering the drain. Begin by applying Portland Sand/Cement mixture mortar bed over the subfloor at 1/4" per foot slope from the wall framing to the top of, but not over, the drain base. After this step the sloped mortar bed should be flush with the top surface of the drain base.

Figure A

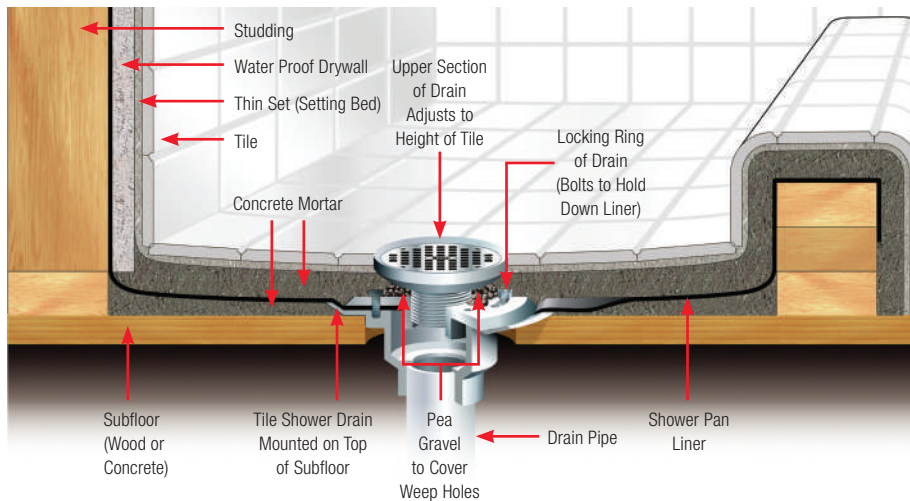

3. After the sloped mortar bed has cured, the pan liner dimensions need to be determined. Pan liner dimensions should be sufficient to completely cover the floor, turn up all sidewalls at least 5 cm above the finished curb height, and adequately cover the curb. Lay the pan liner on a clean floor surface, measure, and cut to the appropriate dimensions. **NOTE: Seaming may be required in larger showers. See Figure B. Follow instructions on bonding adhesive.**

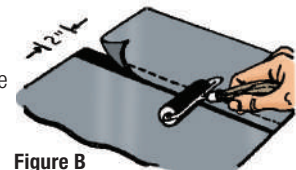
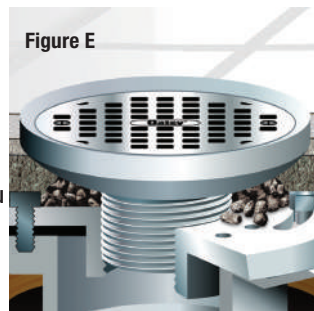
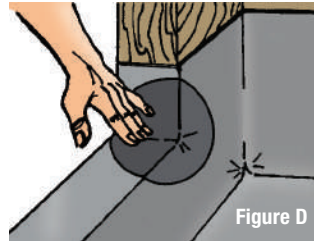
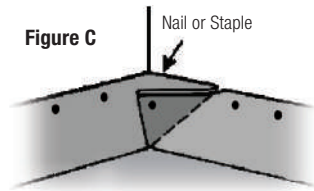

Figure B

4. Before installing the pan liner remove the tape from the drain base and apply a .63-.95 cm bead of 100% silicone caulk around the upper surface of the drain base approximately 2.54 cm in from the outside edge. This will provide a seal between the underside of the pan liner and the drain base surface. Screw the clamping ring bolts into the drain base to 2-3 thread depth. Before the caulk dries lay the premeasured pan liner on the floor and over the drain body. At the top of each bolt slit an "X" so the pan liner slides over the bolts and down to the drain base surface. Press pan liner firmly into place to ensure a seal between the drain base and the bottom surface of the pan liner.

SHOWER PAN LINER – APPLICATION INSTRUCTIONS

5. Work the pan material from the drain body to the sidewall framing and curb threshold so it lays flat on the floor surface. If desired an adhesive can be used to bond pan liner to the floor and curb. Prior to use of adhesive, confirm compatibility of adhesive to the pan liner. Fold corners and nail or staple pan liner to the sidewall framing or wall studs 1.27 cm below the upper edge of the material to hold it in place. Nail or staple the remainder of the pan liner to the sidewall framing or wall studs 1.27 cm below the upper edge of the material. See Figure C.
6. For outside corners or curbs where it's necessary to cut the pan liner use a dam corner to cover the cut area. To bond dam corners in the cut area use **Oatey brand X-15 for PVC liner installations or Oateyweld for CPE liner installations.** See Figure D.
7. Locate where the drain hole is on the drain base and cut out the pan liner material to the dimension of the drain hole on the drain base. Place clamping ring over the bolts and slide the ring counter clockwise so it's locked in place. Tighten the bolts so they're snug. Make sure the weep holes are clear of any residual pan liner material or silicone. **NOTE: The clamping ring can increase the height of the finished shower floor by approximately 1.9 cm. You will see the extension if you turn the ring upside down. Simply tighten it to the drain base the way you normally would, only inverted.**
8. Water test the installation by closing off the drain pipe opening with a pneumatic or mechanical Cherne® test plug. Fill the shower floor with water just below the top of the curb and let it sit for four (4) hours. Observe for leaks and repair if necessary. Retest the installation. Repeat until the installation is leak free. Completely drain the water before proceeding to Step 9.
9. A reinforcement bed of mortar needs to be applied over the membrane (see step 11) but before doing so nail water impervious drywall to the wall studs to approximately 1" above the pan liner surface. **NOTE: The use of mortar vs. drywall for the curb should be considered because you can avoid the use of nails as you construct this part of your installation.**
10. The clamping ring has an inner thread pattern that will accept the drain barrel and strainer assembly. Once you determine the finished height of the shower thread the drain barrel into the inside clamping ring thread so the finished floor will be flush with the top of the drain barrel. As mentioned in step 7 you can increase the shower drain height by inverting the clamping ring.
11. Before the final mortar application place some pea gravel over the weep holes so the mortar doesn't completely cover them. Now lay the minimum 3.8 cm reinforcement mortar bed of concrete over the pan liner from the wall to the drain barrel, leaving enough room for the final thinset and tile application. See Figure E.



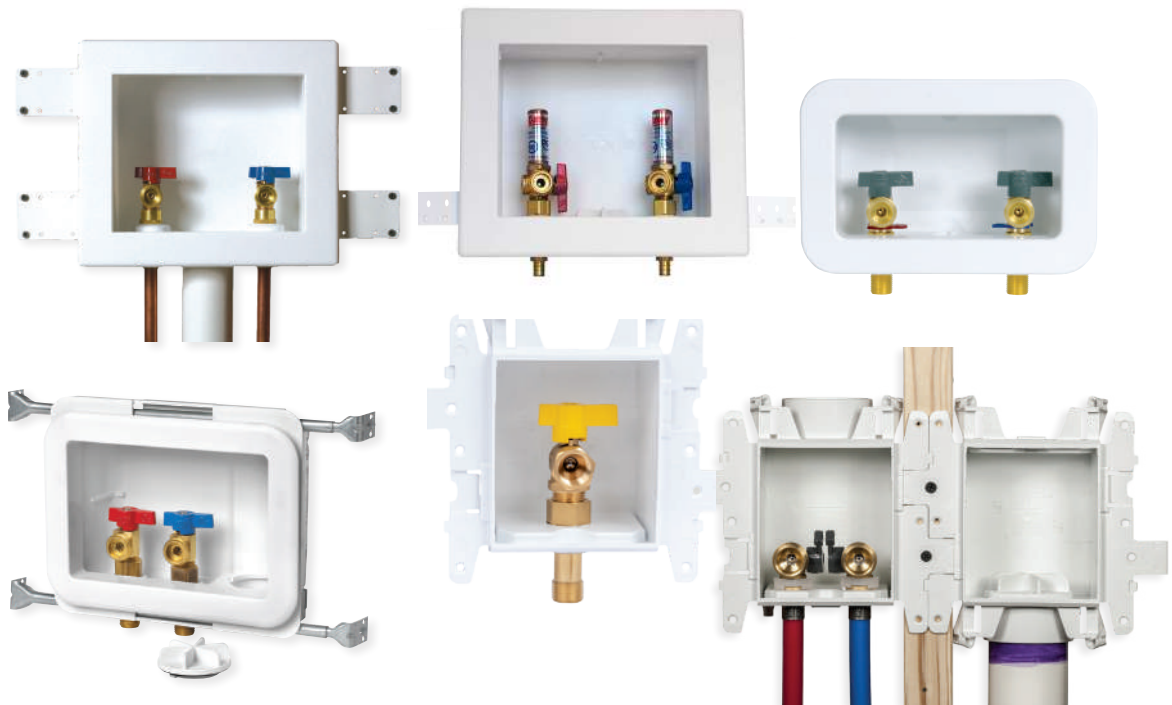

Category 11

Supply Boxes

Oatey® supply boxes can be used in commercial or residential applications that require supply valves and waste drains recessed into the wall. Available water hammer arrestor option provides water pressure shock arrestors required for installation on supply lines to quick closing valves. Available in fire-rated and other configurations.

Oatey® MODA™ Washing Machine Outlet Boxes

- One universal faceplate is compatible with all box types.
- All boxes can snap to one another, and common brackets can be used on any MODA supply box.
- Unique interlocking wing flanges accommodate on-stud, straddle-stud and three-box installations.
- Two piece valve design makes valve replacement easy to repair, without damaging drywall.

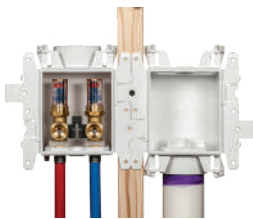

| Product No. | Description | UPC | Ctn. Qty. |
|--|---|--------------|-----------|
| Two Valve Box + Standard Drain Box without Hammer | | | |
| 37601 | MODA, Copper (Male) – Standard Pack | 038753376011 | 12 |
| 37617 | MODA, Copper (Male) – Contractor Pack | 038753376172 | 12 |
| 37350 | 🔥 MODA, Copper (Male) – Standard Pack | 038753373508 | 1 |
| 37603 | MODA, F1807 PEX (Brass) – Standard Pack | 038753376035 | 12 |
| 37619 | MODA, F1807 PEX (Brass) – Contractor Pack | 038753376196 | 12 |
| 37351 | 🔥 MODA, F1807 PEX (Brass) – Standard Pack | 038753373515 | 1 |
| 37605 | MODA, F1960 PEX (Brass) – Standard Pack | 038753376059 | 12 |
| 37621 | MODA, F1960 PEX (Brass) – Contractor Pack | 038753376219 | 12 |
| 37353 | 🔥 MODA, F1960 PEX (Brass) – Standard Pack | 038753373539 | 1 |
| 37602 | MODA, CPVC (Male) – Standard Pack | 038753376028 | 12 |
| 37618 | MODA, CPVC (Male) – Contractor Pack | 038753376189 | 12 |
| 37355 | 🔥 MODA, CPVC (Male) – Standard Pack | 038753373553 | 1 |
| 37608 | MODA, Push Connect – Standard Pack | 038753376080 | 12 |
| 37356 | 🔥 MODA, Push Connect – Standard Pack | 038753373560 | 1 |
| Two Valve Box + Standard Drain Box with Hammer | | | |
| 37609 | MODA, Copper (Male), Hammer – Standard Pack | 038753376097 | 12 |
| 37625 | MODA, Copper (Male), Hammer – Contractor Pack | 038753376257 | 12 |
| 37357 | 🔥 MODA, Copper (Male), Hammer – Standard Pack | 038753373577 | 1 |
| 37611 | MODA, F1807 PEX (Brass), Hammer – Standard Pack | 038753376110 | 12 |
| 37627 | MODA, F1807 PEX (Brass), Hammer – Contractor Pack | 038753376271 | 12 |
| 37358 | 🔥 MODA, F1807 PEX (Brass), Hammer – Standard Pack | 038753373584 | 1 |
| 37613 | MODA, F1960 PEX (Brass), Hammer – Standard Pack | 038753376134 | 12 |
| 37629 | MODA, F1960 PEX (Brass), Hammer – Contractor Pack | 038753376295 | 12 |
| 37360 | 🔥 MODA, F1960 PEX (Brass), Hammer – Standard Pack | 038753373607 | 1 |
| 37610 | MODA, CPVC (Male), Hammer – Standard Pack | 038753376103 | 12 |
| 37626 | MODA, CPVC (Male), Hammer – Contractor Pack | 038753376264 | 12 |
| 37362 | 🔥 MODA, CPVC (Male), Hammer – Standard Pack | 038753373621 | 1 |
| 37616 | MODA, Push Connect, Hammer – Standard Pack | 038753376165 | 12 |
| 37363 | 🔥 MODA, Push Connect, Hammer – Standard Pack | 038753373638 | 1 |
| Single Box (Two Valve + Drain) without Hammer | | | |
| 37540 | MODA, Copper (Male) – Standard Pack | 038753375403 | 12 |
| 37541 | MODA, F1807 PEX (Brass) – Standard Pack | 038753375410 | 12 |
| 37543 | MODA, F1960 PEX (Brass) – Standard Pack | 038753375434 | 12 |
| 37545 | MODA, CPVC (Male) – Standard Pack | 038753375458 | 12 |
| 37546 | MODA, Push Connect – Standard Pack | 038753375465 | 12 |
| Single Box (Two Valve + Drain) with Hammer | | | |
| 37550 | MODA, Copper (Male), Hammer – Standard Pack | 038753375502 | 12 |
| 37551 | MODA, F1807 PEX (Brass), Hammer – Standard Pack | 038753375519 | 12 |
| 37553 | MODA, F1960 PEX (Brass), Hammer – Standard Pack | 038753375533 | 12 |
| 37555 | CPVC (Male), Hammer – Standard Pack | 038753375557 | 12 |
| 37556 | MODA, Push Connect, Hammer – Standard Pack | 038753375564 | 12 |

🔥 Denotes Fire-Rated

SUPPLY BOXES





11 SUPPLY BOXES



| Product No. | Description | UPC | Ctn. Qty. |
|--|--|--------------|-----------|
| Single Box (Two Valve + Drain) without Hammer | | | |
| 37540 | MODA, Copper (Male) – Standard Pack | 038753375403 | 12 |
| 37541 | MODA, F1807 PEX (Brass) – Standard Pack | 038753375410 | 12 |
| 37542 | MODA, F2159/F1807 PEX (PPSU) – Standard Pack | 038753375427 | 12 |
| 37543 | MODA, F1960 PEX (Brass) – Standard Pack | 038753375434 | 12 |
| 37544 | MODA, F1960 PEX (PPSU) – Standard Pack | 038753375441 | 12 |
| 37545 | MODA, CPVC (Male) – Standard Pack | 038753375458 | 12 |
| 37546 | MODA, Push Connect – Standard Pack | 038753375465 | 12 |
| Single Box (Two Valve + Drain) with Hammer | | | |
| 37550 | MODA, Copper (Male), Hammer – Standard Pack | 038753375502 | 12 |
| 37551 | MODA, F1807 PEX (Brass), Hammer – Standard Pack | 038753375519 | 12 |
| 37552 | MODA, F2159/F1807 PEX (PPSU), Hammer – Standard Pack | 038753375526 | 12 |
| 37553 | MODA, F1960 PEX (Brass), Hammer – Standard Pack | 038753375533 | 12 |
| 37554 | MODA, F1960 PEX (PPSU), Hammer – Standard Pack | 038753375540 | 12 |
| 37555 | CPVC (Male), Hammer – Standard Pack | 038753375557 | 12 |
| 37556 | MODA, Push Connect, Hammer – Standard Pack | 038753375564 | 12 |

Oatey® MODA™ Ice Maker Supply Boxes

- One universal faceplate is compatible with all box types.
- All boxes can snap to one another, and common brackets can be used on any MODA supply box.
- Unique interlocking wing flanges accommodate on-stud, straddle-stud and three-box installations.
- Two piece valve design makes valve replacement easy to repair, without damaging drywall.

| Product No. | Description | UPC | Ctn. Qty. |
|-------------------------------------|--|--------------|-----------|
| One Valve Box without Hammer | | | |
| 37679 | MODA, Copper (Male) – Standard Pack | 038753376790 | 12 |
| 37695 | MODA, Copper (Male) – Contractor Pack | 038753376950 | 12 |
| 37378 |  MODA, Copper (Male) – Standard Pack | 038753373782 | 1 |
| 37681 | MODA, F1807 PEX (Brass) – Standard Pack | 038753376813 | 12 |
| 37697 | MODA, F1807 PEX (Brass) – Contractor Pack | 038753376974 | 12 |
| 37379 |  MODA, F1807 PEX (Brass) – Standard Pack | 038753373799 | 1 |
| 37683 | MODA, F1960 PEX (Brass) – Standard Pack | 038753376837 | 12 |
| 37699 | MODA, F1960 PEX (Brass) – Contractor Pack | 038753376998 | 12 |
| 37381 |  MODA, F1960 PEX (Brass) – Standard Pack | 038753373812 | 1 |
| 37680 | MODA, CPVC (Male) – Standard Pack | 038753376806 | 12 |
| 37696 | MODA, CPVC (Male) – Contractor Pack | 038753376967 | 12 |
| 37383 |  MODA, CPVC (Male) – Standard Pack | 038753373836 | 1 |
| 37686 | MODA, Push Connect – Standard Pack | 038753376868 | 12 |
| 37384 |  MODA, Push Connect – Standard Pack | 038753373843 | 1 |

 Denotes Fire-Rated



Oatey® MODA™ Ice Maker Supply Boxes (continued)

| Product No. | Description | UPC | Ctn. Qty. |
|----------------------------------|---|--------------|-----------|
| One Valve Box with Hammer | | | |
| 37687 | MODA, Copper (Male), Hammer – Standard Pack | 038753376875 | 12 |
| 37703 | MODA, Copper (Male), Hammer – Contractor Pack | 038753377032 | 12 |
| 37385 | MODA, Copper (Male), Hammer – Standard Pack | 038753373850 | 1 |
| 37689 | MODA, F1807 PEX (Brass), Hammer – Standard Pack | 038753376899 | 12 |
| 37705 | MODA, F1807 PEX (Brass), Hammer – Contractor Pack | 038753377056 | 12 |
| 37386 | MODA, F1807 PEX (Brass), Hammer – Standard Pack | 038753373867 | 1 |
| 37691 | MODA, F1960 PEX (Brass), Hammer – Standard Pack | 038753376912 | 12 |
| 37707 | MODA, F1960 PEX (Brass), Hammer – Contractor Pack | 038753377070 | 12 |
| 37388 | MODA, F1960 PEX (Brass), Hammer – Standard Pack | 038753373881 | 1 |
| 37688 | MODA, CPVC (Male), Hammer – Standard Pack | 038753376882 | 12 |
| 37704 | MODA, CPVC (Male), Hammer – Contractor Pack | 038753377049 | 12 |
| 37390 | MODA, CPVC (Male), Hammer – Standard Pack | 038753373904 | 1 |
| 37694 | MODA, Push Connect, Hammer – Standard Pack | 038753376943 | 12 |
| 37391 | MODA, Push Connect, Hammer – Standard Pack | 038753373911 | 1 |

Oatey® MODA™ Toilet or Dishwasher Supply Boxes

- One universal faceplate is compatible with all box types.
- All boxes can snap to one another, and common brackets can be used on any MODA supply box.
- Unique interlocking wing flanges accommodate on-stud, straddle-stud and three-box installations.
- Two piece valve design makes valve replacement easy to repair, without damaging drywall.



| Product No. | Description | UPC | Ctn. Qty. |
|-------------------------------------|---|--------------|-----------|
| One Valve Box without Hammer | | | |
| 37897 | MODA, Copper (Male) – Standard Pack | 038753378978 | 12 |
| 37420 | MODA, Copper (Male) – Standard Pack | 038753374208 | 1 |
| 37899 | MODA, F1807 PEX (Brass) – Standard Pack | 038753378992 | 12 |
| 37421 | MODA, F1807 PEX (Brass) – Standard Pack | 038753374215 | 1 |
| 37901 | MODA, F1960 PEX (Brass) – Standard Pack | 038753379012 | 12 |
| 37423 | MODA, F1960 PEX (Brass) – Standard Pack | 038753374239 | 1 |
| 37898 | MODA, CPVC (Male) – Standard Pack | 038753378985 | 12 |
| 37425 | MODA, CPVC (Male) – Standard Pack | 038753374253 | 1 |
| 37904 | MODA, Push Connect – Standard Pack | 038753379043 | 12 |
| 37426 | MODA, Push Connect – Standard Pack | 038753374260 | 1 |



| | | | |
|----------------------------------|---|--------------|----|
| One Valve Box with Hammer | | | |
| 37905 | MODA, Copper (Male), Hammer – Standard Pack | 038753379050 | 12 |
| 37427 | MODA, Copper (Male), Hammer – Standard Pack | 038753374277 | 1 |
| 37907 | MODA, F1807 PEX (Brass), Hammer – Standard Pack | 038753379074 | 12 |
| 37428 | MODA, F1807 PEX (Brass), Hammer – Standard Pack | 038753374284 | 1 |
| 37909 | MODA, F1960 PEX (Brass), Hammer – Standard Pack | 038753379098 | 12 |
| 37430 | MODA, F1960 PEX (Brass), Hammer – Standard Pack | 038753374307 | 1 |
| 37906 | MODA, CPVC (Male), Hammer – Standard Pack | 038753379067 | 12 |
| 37432 | MODA, CPVC (Male), Hammer – Standard Pack | 038753374321 | 1 |
| 37912 | MODA, Push Connect, Hammer – Standard Pack | 038753379128 | 12 |
| 37433 | MODA, Push Connect, Hammer – Standard Pack | 038753374338 | 1 |

Denotes Fire-Rated

Oatey® MODA™ Lavatory Supply Boxes

- One universal faceplate is compatible with all box types.
- All boxes can snap to one another, and common brackets can be used on any MODA supply box.
- Unique interlocking wing flanges accommodate on-stud, straddle-stud and three-box installations.
- Two piece valve design makes valve replacement easy to repair, without damaging drywall.



| Product No. | Description | UPC | Ctn. Qty. |
|-------------------------------------|---|--------------|-----------|
| Two Valve Box without Hammer | | | |
| 37741 | MODA, Copper (Male) – Standard Pack | 038753377414 | 12 |
| 37757 | MODA, Copper (Male) – Contractor Pack | 038753377575 | 12 |
| 37392 | 🔥 MODA, Copper (Male) – Standard Pack | 038753373928 | 1 |
| 37743 | MODA, F1807 PEX (Brass) – Standard Pack | 038753377438 | 12 |
| 37759 | MODA, F1807 PEX (Brass) – Contractor Pack | 038753377599 | 12 |
| 37393 | 🔥 MODA, F1807 PEX (Brass) – Standard Pack | 038753373935 | 1 |
| 37745 | MODA, F1960 PEX (Brass) – Standard Pack | 038753377452 | 12 |
| 37761 | MODA, F1960 PEX (Brass) – Contractor Pack | 038753377612 | 12 |
| 37395 | 🔥 MODA, F1960 PEX (Brass) – Standard Pack | 038753373959 | 1 |
| 37742 | MODA, CPVC (Male) – Standard Pack | 038753377421 | 12 |
| 37758 | MODA, CPVC (Male) – Contractor Pack | 038753377582 | 12 |
| 37397 | 🔥 MODA, CPVC (Male) – Standard Pack | 038753373973 | 1 |
| 37748 | MODA, Push Connect – Standard Pack | 038753377483 | 12 |
| 37398 | 🔥 MODA, Push Connect – Standard Pack | 038753373980 | 1 |
| Two Valve Box with Hammer | | | |
| 37749 | MODA, Copper (Male), Hammer – Standard Pack | 038753377490 | 12 |
| 37765 | MODA, Copper (Male), Hammer – Contractor Pack | 038753377650 | 12 |
| 37399 | 🔥 MODA, Copper (Male), Hammer – Standard Pack | 038753373997 | 1 |
| 37751 | MODA, F1807 PEX (Brass), Hammer – Standard Pack | 038753377513 | 12 |
| 37767 | MODA, F1807 PEX (Brass), Hammer – Contractor Pack | 038753377674 | 12 |
| 37400 | 🔥 MODA, F1807 PEX (Brass), Hammer – Standard Pack | 038753374000 | 1 |
| 37753 | MODA, F1960 PEX (Brass), Hammer – Standard Pack | 038753377537 | 12 |
| 37769 | MODA, F1960 PEX (Brass), Hammer – Contractor Pack | 038753377698 | 12 |
| 37402 | 🔥 MODA, F1960 PEX (Brass), Hammer – Standard Pack | 038753374024 | 1 |
| 37750 | MODA, CPVC (Male), Hammer – Standard Pack | 038753377506 | 12 |
| 37766 | MODA, CPVC (Male), Hammer – Contractor Pack | 038753377667 | 12 |
| 37404 | 🔥 MODA, CPVC (Male), Hammer – Standard Pack | 038753374048 | 1 |
| 37756 | MODA, Push Connect, Hammer – Standard Pack | 038753377568 | 12 |
| 37405 | 🔥 MODA, Push Connect, Hammer – Standard Pack | 038753374055 | 1 |

🔥 Denotes Fire-Rated

Oatey® MODA™ Kitchen Supply Boxes

- One universal faceplate is compatible with all box types.
- All boxes can snap to one another, and common brackets can be used on any MODA supply box.
- Unique interlocking wing flanges accommodate on-stud, straddle-stud and three-box installations.
- Two piece valve design makes valve replacement easy to repair, without damaging drywall.

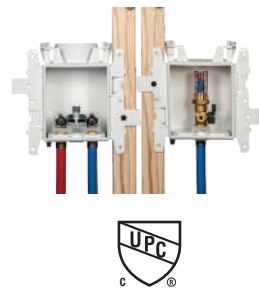
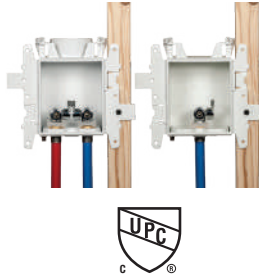

| Product No. | Description | UPC | Ctn. Qty. |
|---|---|--------------|-----------|
| Two Valve Box + One Valve Box (Lavatory – w/o Hammer, Dishwasher – w/o Hammer) | | | |
| 37819 | MODA, Copper (Male) – Standard Pack | 038753378190 | 12 |
| 37406 | MODA, Copper (Male) – Standard Pack | 038753374062 | 1 |
| 37821 | MODA, F1807 PEX (Brass) – Standard Pack | 038753378213 | 12 |
| 37407 | MODA, F1807 PEX (Brass) – Standard Pack | 038753374079 | 1 |
| 37823 | MODA, F1960 PEX (Brass) – Standard Pack | 038753378237 | 12 |
| 37409 | MODA, F1960 PEX (Brass) – Standard Pack | 038753374093 | 1 |
| 37820 | MODA, CPVC (Male) – Standard Pack | 038753378206 | 12 |
| 37411 | MODA, CPVC (Male) – Standard Pack | 038753374116 | 1 |
| 37826 | MODA, Push Connect – Standard Pack | 038753378268 | 12 |
| 37412 | MODA, Push Connect – Standard Pack | 038753374123 | 1 |
| Two Valve Box + One Valve Box (Lavatory – w/o Hammer, Dishwasher – w Hammer) | | | |
| 37827 | MODA, Copper (Male), Hammer – Standard Pack | 038753378275 | 12 |
| 37413 | MODA, Copper (Male), Hammer – Standard Pack | 038753374130 | 1 |
| 37829 | MODA, F1807 PEX (Brass), Hammer – Standard Pack | 038753378299 | 12 |
| 37414 | MODA, F1807 PEX (Brass), Hammer – Standard Pack | 038753374147 | 1 |
| 37831 | MODA, F1960 PEX (Brass), Hammer – Standard Pack | 038753378312 | 12 |
| 37416 | MODA, F1960 PEX (Brass), Hammer – Standard Pack | 038753374161 | 1 |
| 37828 | MODA, CPVC (Male), Hammer – Standard Pack | 038753378282 | 12 |
| 37418 | MODA, CPVC (Male), Hammer – Standard Pack | 038753374185 | 1 |
| 37834 | MODA, Push Connect, Hammer – Standard Pack | 038753378343 | 12 |
| 37419 | MODA, Push Connect, Hammer – Standard Pack | 038753374192 | 1 |

Oatey® MODA™ Plain Boxes

- All plain boxes come with faceplate
- Valve ports are easily knocked-out



| Product No. | Description | UPC | Ctn. Qty. |
|-------------|---|--------------|-----------|
| 37971 | MODA, 1 Valve Port Plain Box – Standard Pack | 038753379715 | 12 |
| 37972 | MODA, 2 Valve Port Plain Box – Standard Pack | 038753379722 | 12 |
| 37970 | MODA, Standard Drain (supplied with Test Cap) – Standard Pack | 038753379708 | 12 |
| 37973 | MODA, Drain + Aux Port – Standard Pack | 038753379739 | 12 |
| 37974 | MODA, Drain + 2 Aux Port – Standard Pack | 038753379746 | 12 |

🔥 Denotes fire-rated



Oatey® MODA™ Secondary Drain Kits

- Includes Aux Drain Box and Funnel, 1 inlet correction plus drain and test plug
- Designed to be paired with single MODA washing machine box
- Inlet and funnel design creates air gap
- Rated for high flow applications - i.e. water softener (10 GPM)

| Product No. | Description | UPC | Ctn. Qty. |
|--|--|--------------|-----------|
| Aux Drain Box + Funnel + 1 Inlet Connection + Drain Test Plug | | | |
| 37557 | MODA, Copper (Male) 1/2" Kit – Standard Pack | 038753375571 | 12 |
| 37985 | MODA, F1807 PEX (Brass) 1/2" Kit – Standard Pack | 038753379852 | 12 |
| 37986 | MODA, F1960 PEX (Brass) 1/2" Kit – Standard Pack | 038753379869 | 12 |
| 37558 | MODA, CPVC (Male) 1/2" Kit – Standard Pack | 038753375588 | 12 |
| 37559 | MODA, Copper (Male) 3/4" Kit – Standard Pack | 038753375595 | 12 |
| 37987 | MODA, F1807 PEX (Brass) 3/4" Kit – Standard Pack | 038753379876 | 12 |
| 37988 | MODA, F1960 PEX (Brass) 3/4" Kit – Standard Pack | 038753379883 | 12 |

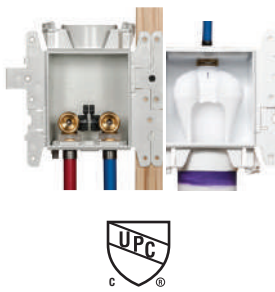

Oatey® MODA™ Secondary Drain Boxes

- Includes WMOB, Aux Drain Box and funnel, plus 1 inlet connection and drain test plug
- Ideal for ventless/condensing dryer
- Inlet and funnel design creates air gap
- Rated for high flow applications - i.e. water softener (10 GPM)

| Product No. | Description | UPC | Ctn. Qty. |
|-------------|--|--------------|-----------|
| 37796 | MODA, WMOB1, BR F1960, HAM and DRN BOX, 1/2 IN, BR, F1960 - Contractor Pack | 038753377964 | 12 |
| 37797 | MODA, WMOB1, BR F1960, NO HAM and DRN BOX, 1/2 IN, BR, F1960 - Contractor Pack | 038753377971 | 12 |
| 37798 | MODA, WMOB1, BR F1807, HAM and DRN BOX, 1/2 IN, BR, F1807 - Contractor Pack | 038753377988 | 12 |
| 37799 | MODA, WMOB1, BR F1807, NO HAM and DRN BOX, 1/2 IN, BR, F1807 - Contractor Pack | 038753377995 | 12 |

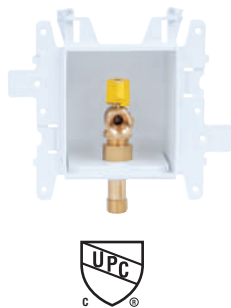

Oatey® MODA™ Gas Supply Boxes

- Residential or commercial applications
- Mounting direct-to-stud or between studs with supply line from top or bottom
- Valves available with yellow handle, with or without brass shank, and plastic brackets for between stud configuration
- 1/2" or 3/4" outlet with 1/4 turn valve.
- Valves certified to ANSI Z.21.15/CSA 9.1-2009

| Product No. | Description | UPC | Ctn. Qty. |
|-----------------------|---|--------------|-----------|
| Gas Supply Box | | | 1 |
| 37560 | NPT Valve + Test Plug 1/2" – Single | 038753375601 | 1 |
| 37446 |  NPT Valve + Test Plug 1/2" – Single | 038753374468 | 1 |
| 37561 | NPT Valve + Test Plug 3/4" – Single | 038753375618 | 1 |
| 37447 |  NPT Valve + Test Plug 3/4" – Single | 038753374475 | 1 |
| 37562 | NPT Valve + Adapter + Test Plug + Locknut Only 1/2" – Single | 038753375625 | 1 |
| 37563 | NPT Valve + Adapter + Test Plug + Locknut Only 3/4" – Single | 038753375637 | 1 |
| 37564 | Plain Box, No Valves – Single | 038753375649 | 1 |

 Denotes Fire-Rated



Oatey® MODA™ Accessories

- One universal faceplate is compatible with all box types.
- All boxes can snap to one another, and common brackets can be used on any MODA supply box.
- Unique interlocking wing flanges accommodate on-stud, straddle-stud and three-box installations.
- Two piece valve design makes valve replacement easy to repair, without damaging drywall.

| Product No. | Description | UPC | Ctn. Qty. |
|-------------|------------------------------------|--------------|-----------|
| 37531 | MODA Faceplate | 038753375311 | 12 |
| 37532 | MODA Faceplate Insert - Solid | 038753375328 | 12 |
| 37533 | MODA Faceplate Insert - Semi-Cover | 038753375335 | 12 |
| 37534 | MODA Faceplate Insert - Louvered | 038753375342 | 12 |
| 37535 | MODA Plastic Bracket | 038753375359 | 12 |
| 38576 | DWV Quarter Turn Test Plug | 038753385761 | 12 |
| 37536 | MODA Secondary Drainage Funnel | 038753375336 | 12 |
| 37537 | MODA Sure-Vent Adapter | 038753375373 | 12 |
| 37538 | MODA Valve Clip Cover | 038753375380 | 12 |
| 37539 | MODA Center Support | 038753375397 | 12 |
| 37529 | MODA Debris Cover Sticker | 038753375298 | 12 |

Oatey® MODA™ Valves

- One universal faceplate is compatible with all box types.
- All boxes can snap to one another, and common brackets can be used on any MODA supply box.
- Unique interlocking wing flanges accommodate on-stud, straddle-stud and three-box installations.
- Two piece valve design makes valve replacement easy to repair, without damaging drywall.



| Product No. | Description | UPC | Ctn. Qty. |
|-------------|---|--------------|-----------|
| 37500 | MODA, Valve Top + Clip, WMOB, No Hammer, Gray Handle, Cold | 038753375007 | 1 |
| 37501 | MODA, Valve Top + Clip, WMOB, No Hammer, Gray Handle, Hot | 038753375014 | 1 |
| 37502 | MODA, Valve Top + Clip, WMOB, Hammer, Gray Handle, Cold | 038753375021 | 1 |
| 37503 | MODA, Valve Top + Clip, WMOB, Hammer, Gray Handle, Hot | 038753375038 | 1 |
| 37504 | MODA, Valve Top + Clip, Utility, No Hammer, Gray Handle, Cold | 038753375045 | 1 |
| 37505 | MODA, Valve Top + Clip, Utility, No Hammer, Gray Handle, Hot | 038753375052 | 1 |
| 37506 | MODA, Valve Top + Clip, Utility, Hammer, Gray Handle, Cold | 038753375069 | 1 |
| 37507 | MODA, Valve Top + Clip, Utility, Hammer, Gray Handle, Hot | 038753375076 | 1 |
| 37508 | MODA, Valve Top + Clip, IMOB, No Hammer | 038753375083 | 1 |
| 37509 | MODA, Valve Top + Clip, IMOB, Hammer | 038753375090 | 1 |
| 37510 | 1/2" Copper Tailpiece Adapter Male | 038753375106 | 1 |
| 37511 | 1/2" Brass F1807 Tailpiece Adapter | 038753375113 | 1 |
| 37512 | 1/2" Brass F1960 Tailpiece Adapter | 038753375120 | 1 |
| 37515 | 1/2" CPVC Tailpiece Adapter Male | 038753375151 | 1 |
| 37516 | 3/4" Copper Tailpiece Adapter Male | 038753375168 | 1 |
| 37517 | 3/4" Brass F1807 Tailpiece Adapter | 038753375175 | 1 |
| 37518 | 3/4" Brass F1960 Tailpiece Adapter | 038753375182 | 1 |



Oatey® Quadro® Washing Machine Outlet Boxes

- 2" drain opening fits PVC or ABS Sch. 40 DWV pipe.
- Easy to remove knockout, Patent Pending Hammer Valves.
- Snap-on Faceplate Frame accommodates up to 1" drywall.
- Box made of high impact polystyrene.
- Top or Bottom Valve Mount.
- 4 support brackets included for mounting.
- Dimensions: Box: 8-3/4" W x 7-1/2" H x 3-5/8" D
Faceplate: 11-3/4" W x 10-1/8" H

| Product No. | Description | UPC | Ctn. Qty. |
|------------------|---|--------------|-----------|
| No Hammer | | | |
| 38530 | Quadro, 1/4 Turn, Copper – Standard Pack | 038753385303 | 12 |
| 48201 | Quadro, 1/4 Turn, Copper – Display Box | 038753482019 | 4 |
| 38535 | Quadro, Single Lever, Copper – Standard Pack | 038753385358 | 12 |
| 38552 | Quadro, Brass Boiler Drain, Copper – Standard Pack | 038753385525 | 12 |
| 38531 | Quadro, 1/4 Turn, CPVC – Standard Pack | 038753385310 | 12 |
| 38532 | Quadro, 1/4 Turn, F1807 – Standard Pack | 038753385327 | 12 |
| 38562 | Quadro, 1/4 Turn, F1807 – Contractor Pack | 038753385624 | 12 |
| 48200 | Quadro, 1/4 Turn, F1807 – Display Box | 038753482002 | 4 |
| 38537 | Quadro, Single Lever, F1807 – Standard Pack | 038753385372 | 12 |
| 38533 | Quadro, 1/4 Turn, F1960 – Standard Pack | 038753385334 | 12 |
| 38563 | Quadro, 1/4 Turn, F1960 – Contractor Pack | 038753385631 | 12 |
| 38538 | Quadro, Single Lever, F1960 – Standard Pack | 038753385389 | 12 |
| 48207 | Quadro, 1/4 Turn, Push Connect, Unassembled | 038753482071 | 4 |
| 38330 | Quadro, 1/4 Turn, Viega PEX Press, Unassembled, Standard Pack | 038753383309 | 12 |
| 38350 | Quadro, Single Lever, Viega PEX Press, Unassembled, Standard Pack | 038753383507 | 12 |
| Hammer | | | |
| 38540 | Quadro, 1/4 Turn, Copper, Hammer – Standard Pack | 038753385402 | 12 |
| 48203 | Quadro, 1/4 Turn, Copper, Hammer – Display Pack | 038753482033 | 2 |
| 38545 | Quadro, Single Lever, Copper, Hammer – Standard Pack | 038753385457 | 12 |
| 38541 | Quadro, 1/4 Turn, CPVC, Hammer – Standard Pack | 038753385419 | 12 |
| 38542 | Quadro, 1/4 Turn, F1807, Hammer – Standard Pack | 038753385426 | 12 |
| 38547 | Quadro, Single Lever, F1807, Hammer – Standard Pack | 038753385471 | 12 |
| 48202 | Quadro, 1/4 turn, F1807, Hammer - Display Pack | 038753482026 | 4 |
| 38543 | Quadro, 1/4 Turn, F1960, Hammer – Standard Pack | 038753385433 | 12 |
| 38548 | Quadro, Single Lever, F1960, Hammer – Standard Pack | 038753385488 | 12 |
| 38551 | Quadro, 1/4 Turn, Compression – Standard Pack | 038753385518 | 12 |
| 48208 | Quadro, 1/4 Turn, Push Connect, Hammer, Unassembled | 038753482088 | 4 |
| 38331 | Quadro, 1/4 Turn, Viega PEX Press, Hammer, Unassembled, Standard Pack | 038753383316 | 12 |
| 38351 | Quadro, Single Lever, Viega PEX Press, Hammer, Unassembled, Standard Pack | 038753383514 | 12 |

STANDARD PACK: Faceplates are pre-assembled on box.

CONTRACTOR PACK: Faceplates are NOT pre-assembled on box (but comes separately packed with the box).

SUPPLY BOXES



39343 & #39356 shown



#39347 & #39360 shown



#38460 shown

| Product No. | Description | UPC | Ctn. Qty. |
|-------------|-------------|-----|-----------|
|-------------|-------------|-----|-----------|

Quadro Replacement Valves - No Hammer

| | | | |
|-------|---|--------------|---|
| 39340 | Quadro Valve- 1/4 Turn- Copper- No Hammer Left/Blue | 038753393407 | 1 |
| 39353 | Quadro Valve- 1/4 Turn- Copper- No Hammer Right/Red | 038753393537 | 1 |
| 39130 | Quadro Valve- 1/4 Turn- CPVC- No Hammer Left/Blue | 038753393414 | 1 |
| 39354 | Quadro Valve- 1/4 Turn- CPVC- No Hammer Right/Red | 038753393544 | 1 |
| 39342 | Quadro Valve- 1/4 Turn- F1807- No Hammer Left/Blue | 038753393421 | 1 |
| 39355 | Quadro Valve- 1/4 Turn- F1807- No Hammer Right/Red | 038753393551 | 1 |
| 39343 | Quadro Valve- 1/4 Turn- F1960 No Hammer Left/Blue | 038753393438 | 1 |
| 39356 | Quadro Valve- 1/4 Turn- F1960 No Hammer Right/Red | 038753393568 | 1 |

Quadro Replacement Valves - Hammer

| | | | |
|-------|--|--------------|---|
| 39344 | Quadro Valve- 1/4 Turn- Copper- Hammer Left/Blue | 038753393445 | 1 |
| 39357 | Quadro Valve- 1/4 Turn- Copper- Hammer Right/Red | 038753393575 | 1 |
| 39345 | Quadro Valve- 1/4 Turn- Cpvc- Hammer Left/Blue | 038753393452 | 1 |
| 39358 | Quadro Valve- 1/4 Turn- Cpvc- Hammer Right/Red | 038753393582 | 1 |
| 39346 | Quadro Valve- 1/4 Turn- F1807- Hammer Left/Blue | 038753393469 | 1 |
| 39359 | Quadro Valve- 1/4 Turn- F1807- Hammer Right/Red | 038753393599 | 1 |
| 39347 | Quadro Valve- 1/4 Turn- F1960- Hammer Left/Blue | 038753393476 | 1 |
| 39360 | Quadro Valve- 1/4 Turn- F1960- Hammer Right/Red | 038753393605 | 1 |

Quadro Accessories

| | | | |
|-------|--|--------------|----|
| 38550 | Quadro, Plain Box, No Valves - Standard Pack | 038753385501 | 12 |
| 38576 | Quadro Testcap | 038753385761 | 12 |
| 38577 | Quadro Hub/O-Ring | 038753385778 | 24 |
| 38941 | Quadro, Plastic Faceplate | 038753389417 | 12 |
| 38829 | Plastic Locknut 1/2" | 038753388298 | 12 |

SUPPLY BOXES - CENTRO II



#38100 shown



Oatey® Centro II Washing Machine Outlet Boxes

- Takes up less space and will fit almost anywhere.
- Made of high impact polystyrene.
- Knockout drain cap.
- 3 knockouts on box top.
- Two piece valves come installed.
- Two support brackets.
- Available in a wide-variety of tailpiece configurations and packaging options.
- Dimensions: Box: 8" W x 4-3/4" x 3" D
Faceplate: 10" W x 6-3/4" H

| Product No. | Description | UPC | Ctn. Qty. |
|-------------|-------------|-----|-----------|
|-------------|-------------|-----|-----------|

No Hammer

| | | | |
|-------|---|--------------|----|
| 38100 | Centro II, 1/4 Turn, Copper – Assembled – Standard Pack | 038753381008 | 12 |
| 38104 | Centro II, 1/4 Turn, ASTM F1807 – Assembled – Standard Pack | 038753381046 | 12 |
| 38151 | Centro II, 1/4 Turn, ASTM F1807 – Assembled – Contractor Pack | 038753381510 | 12 |
| 38106 | Centro II, 1/4 Turn, ASTM F1960 – Assembled – Standard Pack | 038753381060 | 12 |
| 38152 | Centro II, 1/4 Turn, ASTM F1960 – Assembled – Contractor Pack | 038753381527 | 12 |

Hammer

| | | | |
|-------|--|--------------|----|
| 38101 | Centro II, 1/4 Turn, Copper – Assembled – Standard Pack | 038753381015 | 12 |
| 38105 | Centro II, 1/4 Turn, F1807 – Assembled – Standard Pack | 038753381053 | 12 |
| 38155 | Centro II, 1/4 Turn, F1807 – Assembled – Contractor Pack | 038753381558 | 12 |
| 38107 | Centro II, 1/4 Turn, F1960 – Assembled – Standard Pack | 038753381077 | 12 |
| 38156 | Centro II, 1/4 Turn, F1960 – Assembled – Contractor Pack | 038753381565 | 12 |

SUPPLY BOXES



#39337 shown

Centro II Replacement Vales - No Hammer - Top Handle

| Product No. | Description | UPC | Ctn. Qty. |
|-------------|--|--------------|-----------|
| 39322 | WMOB Valve- 1/4 Turn- Copper- No Hammer- Gray Top Handle | 038753393223 | 1 |
| 39327 | WMOB Valve- 1/4 Turn- Cpvc- No Hammer- Gray Top Handle | 038753393278 | 1 |
| 39332 | WMOB Valve- 1/4 Turn- F1807- No Hammer- Gray Top Handle | 038753393322 | 1 |
| 39337 | WMOB Valve- 1/4 Turn- F1960- No Hammer- Gray Top Handle | 038753393377 | 1 |



#39325 & #39326 shown

Centro II Replacement Vales - No Hammer - Side Handle

| | | | |
|-------|--|--------------|---|
| 39320 | WMOB Valve- 1/4 Turn- Copper- No Hammer- Side HdL- Left | 038753393209 | 1 |
| 39321 | WMOB Valve- 1/4 Turn- Copper- No Hammer- Side HdL- Right | 038753393216 | 1 |
| 39325 | WMOB Valve- 1/4 Turn- Cpvc- No Hammer- Side HdL- Left | 038753393254 | 1 |
| 39326 | WMOB Valve- 1/4 Turn- Cpvc- No Hammer- Side HdL- Right | 038753393261 | 1 |
| 39330 | WMOB Valve- 1/4 Turn- F1807- No Hammer- Side HdL- Left | 038753393308 | 1 |
| 39331 | WMOB Valve- 1/4 Turn- F1807- No Hammer- Side HdL- Right | 038753393315 | 1 |
| 39335 | WMOB Valve- 1/4 Turn- F1960- No Hammer- Side HdL- Left | 038753393353 | 1 |
| 39336 | WMOB Valve- 1/4 Turn- F1960- No Hammer- Side HdL- Right | 038753393360 | 1 |



#39323 & #39324 shown

Centro II Replacement Vales - Hammer - Side Handle

| | | | |
|-------|--|--------------|---|
| 39323 | WMOB Valve- 1/4 Turn- Copper- Hammer- Side HdL- Left | 038753393230 | 1 |
| 39324 | WMOB Valve- 1/4 Turn- Copper- No Hammer- Side HdL- Right | 038753393216 | 1 |
| 39328 | WMOB Valve - 1/4 Turn-Cpvc-Hammer-Side HdL-Left | 038753393285 | 1 |
| 39329 | WMOB Valve- 1/4 Turn- Cpvc- Hammer- Side HdL- Right | 038753393292 | 1 |
| 39333 | WMOB Valve- 1/4 Turn- F1807- Hammer- Side HdL- Left | 038753393339 | 1 |
| 39334 | WMOB Valve- 1/4 Turn- F1807- Hammer- Side HdL- Right | 038753393346 | 1 |
| 39338 | WMOB Valve- 1/4 Turn- F1960- Hammer- Side HdL- Left | 038753393384 | 1 |
| 39339 | WMOB Valve- 1/4 Turn- F1960- Hammer- Side HdL- Right | 038753393391 | 1 |



#39349 shown

Centro II Replacement Vales - Top Only

| | | | |
|-------|--|--------------|---|
| 39349 | WMOB Valve- Top Only- 1/4 Turn- No Hammer- Top HdL | 038753393490 | 1 |
| 39348 | WMOB Valve- Top Only- 1/4 Turn- Hammer- Side HdL | 038753393483 | 1 |



#38829 shown

Centro II Accessories

| | | | |
|-------|------------------------------|--------------|----|
| 38381 | Centro II, Plastic Faceplate | 038753383811 | 12 |
| 38383 | Brackets 12" Long Plastic | 038753383835 | 12 |
| 38829 | Locknut 1/2" Plastic | 038753388298 | 1 |



Oatey® Fire-Rated Washing Machine Outlet Boxes

- Warnock Hersey certified, for 1-hour and 2-hour fire-rated walls.
- 2" drain opening fits PVC or ABS Sch. 40 DWV pipe.
- Box made of Bulk Molding Compound (BMC) with UL-classified intumescent pads and UL-classified insulating material.
- Adjustable metal mounting brackets, easy to remove test cap.
- Flexible valve/drain arrangement capabilities.
- Dimensions: Box: 8-1/3" W x 5-1/2" H x 3-3/4" D
Faceplate: 10-1/5" W x 7-2/5" H

| Product No. | Description | UPC | Ctn. Qty. |
|--------------------|--|--------------|-----------|
| No Hammer | | | |
| 38470 | 🔥 Fire Rated, 1/4 Turn, Copper – Standard Pack | 038753384702 | 1 |
| 38474 | 🔥 Fire Rated, Single Lever, Copper – Standard Pack | 038753384740 | 1 |
| 38471 | 🔥 Fire Rated, 1/4 Turn, CPVC – Standard Pack | 038753384719 | 1 |
| 38472 | 🔥 Fire Rated, 1/4 Turn, F1807 – Standard Pack | 038753384726 | 1 |
| 38473 | 🔥 Fire Rated, 1/4 Turn, F1960 – Standard Pack | 38753384733 | 1 |
| Hammer | | | |
| 38478 | 🔥 Fire Rated, 1/4 Turn, Copper, Hammer – Standard Pack | 038753384788 | 1 |
| 38482 | 🔥 Fire Rated, Single Lever, Copper, Hammer – Standard Pack | 038753384825 | 1 |
| 38479 | 🔥 Fire Rated, 1/4 Turn, CPVC, Hammer – Standard Pack | 038753384795 | 1 |
| 38480 | 🔥 Fire Rated, 1/4 Turn, F1807, Hammer – Standard Pack | 038753384801 | 1 |
| 38484 | 🔥 Fire Rated, Single Lever, F1807, Hammer – Standard Pack | 038753384849 | 1 |
| 38481 | 🔥 Fire Rated, 1/4 Turn, F1960, Hammer – Standard Pack | 038753384818 | 1 |
| 38485 | 🔥 Fire Rated, Single Lever, F1960, Hammer – Standard Pack | 038753384818 | 1 |
| Accessories | | | |
| 38494 | 🔥 Fire Rated, Plain Box, No Valves, Faceplate, or Bracket | 038753384948 | 6 |
| 38496 | 🔥 Fire Rated, Faceplate | 038753384962 | 6 |
| 38576 | Quadro Testcap | 038753385761 | 12 |



Oatey® Metal Washing Machine Outlet Boxes

- Allows left or right hand drain. 2 metal support brackets.
- 2" drain opening – rubber coupling, solvent weld or threaded.
- Box made of 20 gauge steel.
- Dimensions: Box: 9" W x 6-1/8" H x 3-1/16" D
Faceplate: 10-7/8" W x 7-3/4" H

| Product No. | Description | UPC | Ctn. Qty. |
|--------------------|--|--------------|-----------|
| No Hammer | | | |
| 38979 | Metal, 1/4 Turn, CPVC, 2" Rubber Tailpiece – Standard Pack | 038753389790 | 1 |
| 38981 | Metal, 1/4 Turn, Copper, 2" PVC Tailpiece – Standard Pack | 38753389813 | 1 |
| 38983 | Metal, 1/4 Turn, Copper, 2" ABS Tailpiece – Standard Pack | 038753389837 | 1 |
| 38984 | Metal, Single Lever, Copper, 2" ABS Tailpiece – Standard Pack | 038753389844 | 1 |
| 38985 | Metal, 1/4 Turn, Copper, 2" Rubber Tailpiece – Standard Pack | 038753389851 | 1 |
| 38986 | Metal, Single Lever, Copper, 2" Rubber Tailpiece – Standard Pack | 038753389868 | 1 |
| 38993 | Metal, 1/4 Turn, Copper, 2" NPT Tailpiece – Standard Pack | 038753389936 | 1 |
| Hammer | | | |
| 38995 | Metal, 1/4 Turn, Copper, Hammer, 2" Rubber Tailpiece – Standard Pack | 038753389950 | 1 |
| 38996 | Metal, 1/4 Turn, CPVC, Hammer, 2" Rubber Tailpiece – Standard Pack | 038753389967 | 1 |
| Accessories | | | |
| 38975 | Metal, Faceplate | 038753389752 | 1 |
| 38980 | Metal, Plain Box, No Valves, or Tailpiece – Standard Pack | 038753389806 | 1 |
| 38987 | Metal, 2" PVC Tailpiece | 038753389875 | 1 |

🔥 Denotes fire-rated



#38401 shown

Oatey® Fire-Rated and Metal WMOB Replacement Valves

| Product No. | Description | UPC | Ctn. Qty. |
|---|---|--------------|-----------|
| Fire-Rated and Metal WMOB Replacement Valves - No Hammer | | | |
| 38871 | Valve 1/4 Turn Copper 3/4" No Hammer Blue | 038753388717 | 1 |
| 38870 | Valve 1/4 Turn Copper 3/4" No Hammer Red | 038753388700 | 1 |
| 38969 | Valve 1/4 Turn Cpvc 3/4" No Hammer Blue | 038753389691 | 1 |
| 38880 | Valve 1/4 Turn F1960 3/4" No Hammer Blue | 038753388809 | 1 |
| 38881 | Valve 1/4 Turn F1960 3/4" No Hammer Red | 038753388816 | 1 |
| 38978 | Valve 1/4 Turn F1807 3/4" No Hammer Blue | 038753389783 | 1 |
| 38977 | Valve 1/4 Turn F1807 3/4" No Hammer Red | 038753389776 | 1 |
| Fire-Rated and Metal WMOB Replacement Vales - Hammer | | | |
| 38401 | Valve 1/4 Turn Copper Hammer Blue | 038753384016 | 1 |
| 38400 | Valve 1/4 Turn Copper Hammer Red | 038753384009 | 1 |
| 38403 | Valve 1/4 Turn Cpvc Hammer Blue | 038753384030 | 1 |
| 38402 | Valve 1/4 Turn Cpvc Hammer Red | 038753384023 | 1 |
| 38409 | Valve 1/4 Turn F1807 Hammer Blue | 038753384092 | 1 |
| 38408 | Valve 1/4 Turn F1807 Hammer Red | 038753384085 | 1 |



#39176 shown



Oatey® Fire-Rated Ice Maker Outlet Boxes

- Warnock Hersey certified, for 1-hour and 2-hour fire-rated walls.
- Box made of Bulk Molding Compound (BMC) with UL-classified insulating material.
- Adjustable metal mounting brackets.
- Dimensions: Box: 5-9/10" W x 5-4/5" H x 3-3/4" D
Faceplate: 8-1/8" W X 8-1/16" H

| Product No. | Description | UPC | Ctn. Qty. |
|---------------------------|--|--------------|-----------|
| No Hammer Low Lead | | | |
| 39117 | 🔥 Fire Rated, 1/4 Turn, Copper, Low Lead – Standard Pack | 038753391175 | 1 |
| 39119 | 🔥 Fire Rated, 1/4 Turn, F1807, Low Lead – Standard Pack | 038753391199 | 1 |
| 39120 | 🔥 Fire Rated, 1/4 Turn, F1960, Low Lead – Standard Pack | 038753391205 | 1 |
| Hammer Low Lead | | | |
| 39121 | 🔥 Fire Rated, 1/4 Turn, Copper, Hammer, Low Lead – Standard Pack | 038753391212 | 1 |
| 39123 | 🔥 Fire Rated, 1/4 Turn, F1807, Hammer, Low Lead – Standard Pack | 038753391236 | 1 |
| 39124 | 🔥 Fire Rated, 1/4 Turn, F1960, Hammer, Low Lead – Standard Pack | 038753391243 | 1 |
| Accessories | | | |
| 38495 | 🔥 Fire Rated, Plain Box, No Valves – Standard Pack | 038753384955 | 6 |
| Replacement Valves | | | |
| 39166 | Valve-1/4 Turn IMB Hammer Copper LL | 038753391663 | 1 |
| 39167 | Valve-1/4 Turn IMB Hammer CPVC LL | 038753391670 | 1 |
| 39168 | Valve-1/4 Turn IMB Hammer Pex LL | 038753391687 | 1 |
| 39169 | Valve-1/4 Turn IMB Hammer Wirsbo LL | 038753391694 | 1 |
| 39173 | Valve-1/4 Turn F1960 1/4 In. LL | 038753391731 | 1 |
| 39175 | Valve-1/4 Turn CPVC 1/4 In. LL | | 1 |
| 39176 | Valve-1/4 Turn Copper 1/4 In. LL | 038753391762 | 1 |



#39169 shown

🔥 Denotes fire-rated



Oatey® Metal Ice Maker Outlet Boxes

- Made of 20 gauge steel.
- Nailplate support brackets.
- Dimensions: Box: 5-1/2" W x 5" H x 2-1/2" D
Faceplate Interior: 5" W x 5" H
Faceplate Exterior: 6-3/4" W x 6-3/4" H

| Product No. | Description | UPC | Ctn. Qty. |
|---|---|--------------|-----------|
| No Hammer Low Lead | | | |
| 39141 | Valve 1/4 Turn, Copper, IMB, No Hammer | 038753391410 | 1 |
| 39166 | Valve 1/4 Turn, Copper, IMB, Hammer | 038753391663 | 1 |
| Hammer Low Lead | | | |
| 39140 | Metal, 1/4 Turn, Copper, Hammer, Low Lead – Standard Pack | 038753391403 | 1 |
| Accessories | | | |
| 38686 | Metal Faceplate | 038753386867 | 1 |
| 38687 | Metal, Plain Box, No Valves – Standard Pack | 038753386874 | 1 |
| Metal Ice Maker Replacement Valves | | | |
| 39141 | Valve 1/4 Turn Copper IMB - No Hammer | 038753391410 | 1 |
| 39166 | Valve 1/4 Turn Copper IMB Hammer | 038753391663 | 1 |



Oatey® Square Ice Maker Outlet Boxes

- 2 support brackets. Provides quick, safe water supply and shut off for refrigerator ice maker and water dispenser.
- High impact polystyrene. Valves comply with requirements of NSF 61, Section 9.
- Available in several box and valve configurations.
- Dimensions: Box: 6" W x 6" H x 3-3/8" D
Faceplate: 8-1/4" W x 8-1/4" H

| Product No. | Description | UPC | Ctn. Qty. |
|---------------------------|---|--------------|-----------|
| No Hammer Low Lead | | | |
| 39158 | Square, 1/4 Turn, F1807, Low Lead – Standard Pack | 038753391588 | 6 |
| 39160 | Square, 1/4 Turn, F1807, Low Lead – Contractor Pack | 038753391601 | 12 |
| 39161 | Square, 1/4 Turn, F1960 Low Lead – Standard Pack | 083753391618 | 6 |
| 39156 | Square, 1/4 Turn, Copper, Low Lead – Standard Pack | 038753391564 | 6 |
| 39157 | Square, 1/4 Turn, Copper, Low Lead – Contractor Pack | 038753391571 | 12 |
| 38326 | Square, 1/4 Turn, Push Connect, Assembled | 038753383262 | 6 |
| 38346 | Square, 1/4 Turn, 1/2" Viega PEX Press, Assembled, Standard Pack | 038753383460 | 6 |
| Hammer Low Lead | | | |
| 39149 | Square, 1/4 Turn, F1807, Hammer, Low Lead – Standard Pack | 038753391496 | 6 |
| 39150 | Square, 1/4 Turn, F1960, Hammer, Low Lead – Standard Pack | 038753391502 | 6 |
| 39152 | Square, 1/4 Turn, Copper, Hammer, Low Lead – Standard Pack | 038753391526 | 6 |
| 38327 | Square IMOB, 1/4 Turn, Push Connect, Hammer, Assembled | 038753383279 | 6 |
| 38347 | Square IMOB, 1/4 Turn, 1/2" Viega PEX Press, Hammer, Assembled, Standard Pack | 038753383477 | 6 |
| Accessories | | | |
| 38806 | Square, Plain Box, No Valves, With Grommet – Standard Pack | 038753388069 | 6 |
| 38810 | Square, Plain Box, No Valves – Standard Pack | 038753388106 | 6 |
| 38942 | Square, Plastic Faceplate | 038753389424 | 24 |

STANDARD PACK: Faceplates are pre-assembled on box.

CONTRACTOR PACK: Faceplates are NOT pre-assembled on box (but comes separately packed with the box).



#39130 shown



STANDARD PACK: Faceplates are pre-assembled on box.

CONTRACTOR PACK: Faceplates are NOT pre-assembled on box (but comes separately packed with the box).

Oatey® I2K® Ice Maker Outlet Boxes

- Nails preloaded.
- Right or left hand installation.
- Provides quick, safe water supply and shut-off for refrigerator ice maker and water dispenser.
- Valves comply with requirements of NSF 61, Section 9.
- No support bracket needed.
- Dimensions: Box: 3-1/4" W x 4" H x 2-1/2" D
Faceplate: 5" W x 6" H

| Product No. | Description | UPC | Ctn. Qty. |
|---------------------------|--|--------------|-----------|
| No Hammer Low Lead | | | |
| 39134 | I2K, 1/4 Turn, Copper, Low Lead - Standard Pack | 038753391342 | 6 |
| 39135 | I2K, 1/4 Turn, Copper, Low Lead - Contractor Pack | 038753391359 | 12 |
| 39130 | I2K, 1/4 Turn, Copper, Low Lead - Display Pack | 038753391304 | 4 |
| 39133 | I2K, 1/4 Turn, CPVC, Low Lead - Standard Pack | 038753391335 | 6 |
| 39137 | I2K, 1/4 Turn, CPVC, Low Lead - Contractor Pack | 038753391373 | 12 |
| 39136 | I2K, 1/4 Turn, F1807, Low Lead - Standard Pack | 038753391366 | 6 |
| 39138 | I2K, 1/4 Turn, F1807, Low Lead - Contractor Pack | 038753391380 | 12 |
| 39114 | I2K, 1/4 Turn, F1807, Low Lead - Display Pack | 038753391144 | 4 |
| 39132 | I2K, 1/4 Turn, F1960, Low Lead - Contractor Pack | 038753391328 | 12 |
| 39139 | I2K, Boiler Drain, Copper, Low Lead, NAFTA - Standard Pack | 038753391397 | 6 |
| 38332 | I2K, 1/4 Turn, Viega PEX Press – Standard Pack | 038753383323 | 6 |
| 38340 | I2K, 1/4 Turn, Viega PEX Press – Contractor Pack | 038753383408 | 12 |
| 38312 | I2K, 1/4 Turn, Push Connect – Standard Pack | 038753383125 | 6 |
| 38320 | I2K, 1/4 Turn, Push Connect – Contractor Pack | 038753383200 | 12 |
| Hammer Low Lead | | | |
| 39125 | I2K, 1/4 Turn, Copper, Hammer, Low Lead - Contractor Pack | 038753391250 | 12 |
| 39126 | I2K, 1/4 Turn, CPVC, Hammer, Low Lead - Contractor Pack | 038753391267 | 12 |
| 39127 | I2K, 1/4 Turn, F1807, Hammer, Low Lead - Contractor Pack | 038753391274 | 12 |
| 39128 | I2K, 1/4 Turn, F1960, Hammer, Low Lead - Contractor Pack | 038753391281 | 12 |
| 38333 | I2K, 1/4 Turn, Viega PEX Press – Standard Pack | 38753383330 | 6 |
| 38341 | I2K, 1/4 Turn, Viega PEX Press – Contractor Pack | 038753383415 | 12 |
| 38313 | I2K, 1/4 Turn, Push Connect – Standard Pack | 038753383132 | 6 |
| 38321 | I2K, 1/4 Turn, Push Connect – Contractor Pack | 038753383217 | 12 |
| Accessories | | | |
| 38619 | I2K, Plain Box, No Valves - Standard Pack | 038753386195 | 6 |
| 38621 | I2K, Plastic Faceplate 1/2" Deep | 038753386218 | 12 |
| 38622 | I2K, Plastic Faceplate 1" Deep | 038753386225 | 12 |

Oatey® Square and I2K® Ice Maker Outlet Box Replacement Valves and Accessories



#39174 shown



#39169 shown

| Product No. | Description | UPC | Ctn. Qty. |
|---------------------------|--|--------------|-----------|
| No Hammer Low Lead | | | |
| 39176 | IMOB Valve, 1/4 Turn, Copper, Low Lead | 038753391762 | 1 |
| 39175 | IMOB Valve, 1/4 Turn, CPVC, Low Lead | 038753391755 | 1 |
| 39173 | IMOB Valve, 1/4 Turn, F1960 Low Lead | 038753391731 | 1 |
| 39174 | IMOB Valve, 1/4 Turn, F1807, Low Lead | 038753391748 | 1 |
| 39171 | IMOB Valve, Boiler Drain, Copper, Low Lead | 038753391717 | 1 |
| Hammer Low Lead | | | |
| 39166 | IMOB Valve, 1/4 Turn, Copper, Hammer, Low Lead | 038753391663 | 1 |
| 39167 | IMOB Valve, 1/4 Turn, CPVC, Hammer, Low Lead | 038753391670 | 1 |
| 39168 | IMOB Valve, 1/4 Turn, F1807, Hammer, Low Lead | 038753391687 | 1 |
| 39169 | IMOB Valve, 1/4 Turn, F1960, Hammer, Low Lead | 038753391694 | 1 |
| Accessories | | | |
| 38779 | Adapter 1/2" Female NPT X 1/2" Copper | 038753387796 | 1 |
| 38829 | Locknut 1/2" Plastic | 038753388298 | 1 |
| 38769 | Grommets 1/2" | 038753387697 | 12 |

SUPPLY BOXES



#34015 shown

Oatey® Pex Water Supply Tubes

- Meets performance requirements of ASME A122.18.6 ASTM F876 and ASTM F877.
- Fast and easy to install.
- One-piece ready to use.

| Product No. | Description | UPC | Ctn. Qty. |
|-------------|--------------------------------------|--------------|-----------|
| 34015 | PEX Water Supply Kit with 1/4" Valve | 038753340159 | 6 |
| 34312 | PEX Sink Supply 20" | 038753343129 | 48 |
| 34313 | PEX Sink Supply 30" | 038753343136 | 48 |
| 34314 | PEX Sink Supply 36" | 038753343143 | 48 |
| 34317 | PEX Toilet Riser 20" | 038753343174 | 48 |

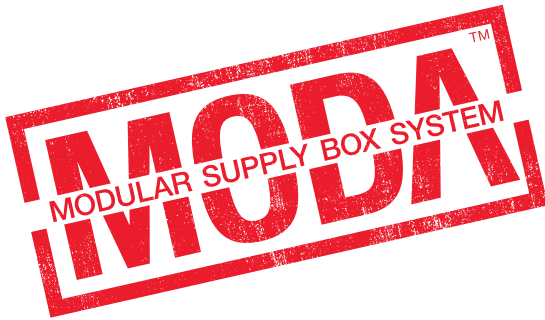

SECONDARY DRAIN BOX



Old Method

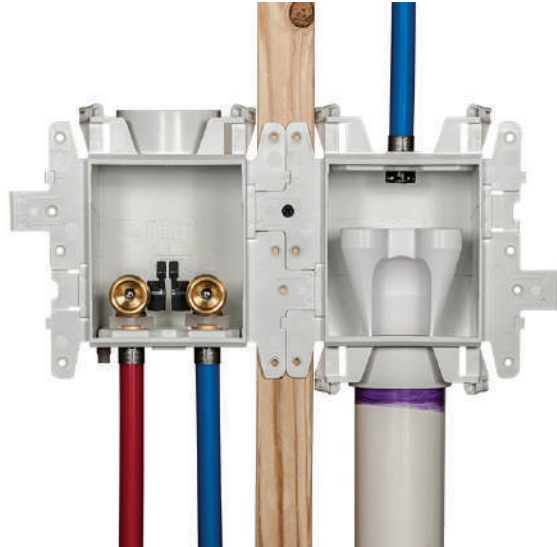

New Method

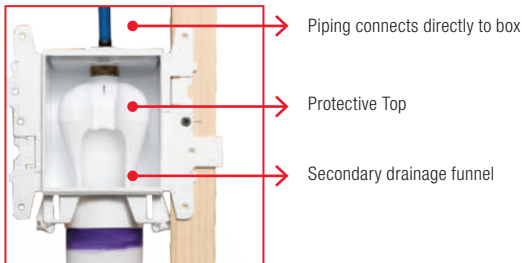

FEATURES AND BENEFITS

- Seamless connection from inlet pipe to drain (including air gap)
- Rated for high-flow applications, i.e. water softener (10GPM)
- No additional bracing or supports required for inlet supply
- No need to transition pipe type
- Available in F1807 PEX and F1960 PEX

Accessory Components Included:

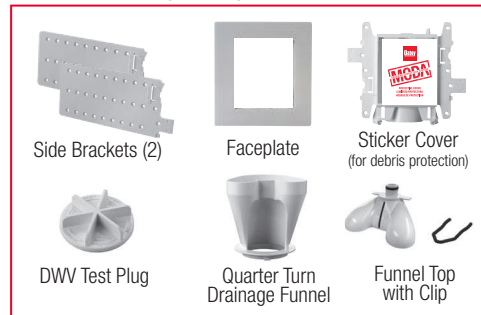

| Part # | Description | Pack Type | UPC | Ctn Qty |
|--------|--|------------|--------------|---------|
| 37796 | MODA, WMOB1, BR F1960, HAM and DRN BOX, 1/2 IN, BR, F1960 | Contractor | 038753377964 | 12 |
| 37797 | MODA, WMOB1, BR F1960, NO HAM and DRN BOX, 1/2 IN, BR, F1960 | Contractor | 038753377971 | 12 |
| 37798 | MODA, WMOB1, BR F1807, HAM and DRN BOX, 1/2 IN, BR, F1807 | Contractor | 038753377988 | 12 |
| 37799 | MODA, WMOB1, BR F1807, NO HAM and DRN BOX, 1/2 IN, BR, F1807 | Contractor | 038753377995 | 12 |

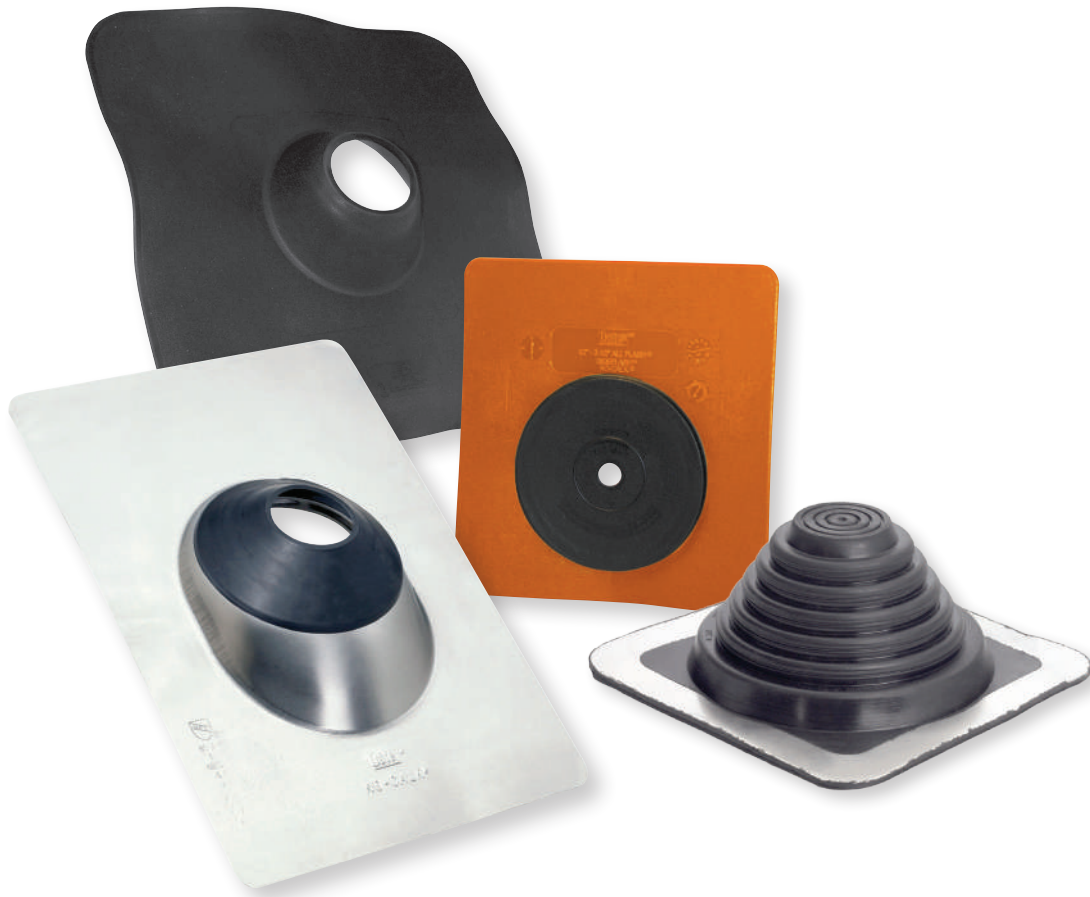

Category 12

Flashings

Oatey® created the plumbing vent flashing industry nearly 100 years ago. Today Oatey flashings are used in commercial and residential applications where a water-tight seal around plumbing vent pipe or outside wall penetrations is required. Flashings are available in a variety of thermoplastic, aluminum, galvanized and copper materials. All Oatey flashings are rated for a minimum of 82°C continuous heat and approved for Type B Installations.



Thermoplastic No-Calk® Colour Roof Flashings

- Non-fading, non-cracking, thermoplastic base.
- Self-sealing collar slides over pipe and requires no caulking.
- Do not use petroleum based products or paint on flashing collar or plastic base.
- Not for hot-mopped or built-up roofs.
- Plastic base for pitch from 0-45 degrees or up to 12/12 roof.
- Rated 82°C continuous heat and approved for Type B installations.
- Colours come in Black, Brown, Gray, and Weatherwood.

| Product No. | Size | Description | UPC | Ctn. Qty. |
|-------------|--------------|-----------------------------------|--------------|-----------|
| 48100 | 1.25" – 1.5" | NC-1" Plastic 14" x 16" Black | 038753481005 | 12 |
| 48101 | 2" | NC-2" Plastic 14" x 16" Black | 038753481012 | 12 |
| 48102 | 3" | NC-3" Plastic 14" x 16" Black | 038753481029 | 12 |
| 48103 | 4" | NC-4" Plastic 14" x 16" Black | 038753481036 | 12 |
| 481051 | 1.5 – 3" | NC-1-2-3" Plastic 14" x 16" Black | 038753481050 | 6 |
| 481061 | 3 - 4" | NC-3-4" Plastic 14" x 16" Black | 038753481067 | 6 |



Galvanized No-Calk® Roof Flashings

- Galvanized Base.
- Self-sealing collar slides over pipe and requires no caulking.
- Metal base for pitch from 0-40° or up to 10/12 roof.
- Do not use petroleum based products or paint on flashing collar. Not for hot-mopped or built-up roofs.
- Rated 82°C continuous heat and approved for Type B installations.

| Product No. | Size | Description | UPC | Ctn. Qty. |
|-------------------------------|--------------|-----------------------------|--------------|-----------|
| SOLAR FLASHING | | | | |
| 11830 | .5" – 1" | Galvanized 9" x 12.5" base | 038753118307 | 12 |
| STANDARD BASE FLASHING | | | | |
| 11840 | 1.25" – 1.5" | Galvanized 9" x 12.5" base | 038753118406 | 12 |
| 11855 | 2" | Galvanized 9" x 12.5" base | 038753118550 | 12 |
| 11866 | 3" | Galvanized 11" x 14.5" base | 038753118666 | 12 |
| 11879 | 4" | Galvanized 12" x 15" base | 038753118796 | 12 |



Flex-Flash™ No-Calk® Roof Flashings

- 100% flexible, foldable plastic base.
- Self-sealing collar slides over pipe and requires no caulking.
- Do not use petroleum based products or paint on flashing collar or plastic base. Not for hot-mopped or built-up roofs.
- Plastic base for pitch from 0-45° or up to 12/12 roof.
- Rated 82°C continuous heat and approved for Type B installations.

| Product No. | Size | Description | UPC | Ctn. Qty. |
|-------------|--------------|------------------------|--------------|-----------|
| 14017 | 1.25" – 1.5" | NC-1.5" Flex 20" x 20" | 038753140179 | 12 |
| 14018 | 2" | NC-2" Flex 20" x 20" | 038753140186 | 12 |
| 14046 | 3" | NC-3" Flex 20" x 20" | 038753140469 | 12 |
| 14047 | 4" | NC-4" Flex 20" x 20" | 038753140476 | 12 |

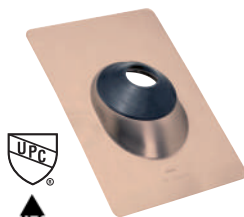

U.S. Patent No. 5,588,267

All-Flash® No-Calk® Roof Flashings/Copper Base

- Patented All-Flash® design allows use on multiple pipe sizes.
- Copper base. Rated 82°C continuous heat and approved for Type B installations.
- Metal base for pitch from 0-40°.
- Self-sealing collar slides over pipe and requires no caulking.
- Do not use petroleum based products or paint on flashing collar or plastic base. Not for hot-mopped or built-up roofs.

| Product No. | Size | Description | UPC | Ctn. Qty. |
|-------------|---------|----------------------------------|--------------|-----------|
| 12404 | 3" – 4" | Copper No-Calk® 11" x 14.5" base | 750405124046 | 12 |

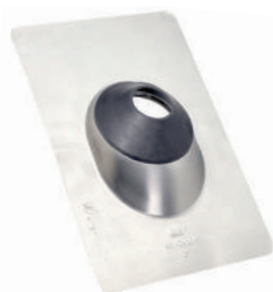

Aluminum No-Calk® Roof Flashings/18" X 18" Base

- Rustproof stamped aluminum base allows for easy shaping of flashing.
- Rated 82°C continuous heat and approved for Type B installations.
- Metal base for pitch from 0-40° or up to 10/12 roof.
- Self-sealing collar slides over pipe and requires no caulking.
- Do not use petroleum based products or paint on flashing collar. Not for hot-mopped or built-up roofs.

| Product No. | Size | Description | UPC | Ctn. Qty. |
|-------------|--------------|------------------------------|--------------|-----------|
| 12836 | 1.25" – 1.5" | Soft Aluminum 18" x 18" base | 038753128368 | 12 |
| 12849 | 2" | Soft Aluminum 18" x 18" base | 038753128498 | 12 |
| 48142 | 3" | Soft Aluminum 18" x 18" base | 038753481425 | 12 |
| 48143 | 4" | Soft Aluminum 18" x 18" base | 038753481432 | 12 |



Sideflash™ Vertical Flashings

- Maintains a constant seal in commercial and residential pipe penetration applications through outside walls.
- Designed with a tear out collar to accommodate pipe size use from ½" to 2½" or 3" to 6".
- Rated 82°C continuous heat and approved for type B installations.

| Product No. | Size | Description | UPC | Ctn. Qty. |
|-------------|------------|-----------------------------|--------------|-----------|
| 12805 | .5" – 2.5" | Sideflash Vertical Flashing | 038753128054 | 12 |
| 12806 | 3" – 6" | Sideflash Vertical Flashing | 038753128061 | 12 |



High-Rise® Thermoplastic All-Flash® No-Calk® Roof Flashings

- Roof Flashing slides over DWV pipe for pitch to 60°.
- Patented All-Flash collar has tear-away ring allowing flashing to seal various pipe diameters.
- Non-fading, non-cracking rigid black thermoplastic base.
- Non-fading sealing collar.
- Rated 82°C continuous heat and approved for type B installations.
- Not for hot-mopped or built-up roofs.
- Do not use paint or petroleum based products on plastic bases or rubber collars.

| Product No. | Size | Description | UPC | Ctn. Qty. |
|-------------|-----------|--------------------------------------|--------------|-----------|
| 11930 | 1.5" – 3" | All-Flash® High-Rise® 11" x 19" base | 038753119304 | 6 |
| 11931 | 3" – 4" | All-Flash® High-Rise® 13" x 20" base | 038753119311 | 6 |



Rain Collar For No-Calk® Roof Flashings

- Use as a protective water shield (slides over existing flashing). No caulking needed.
- Do not use petroleum based products on rubber collars.
- Non-fading collar material.

| Product No. | Size | Description | UPC | Ctn. Qty. |
|-------------|--------------|------------------|--------------|-----------|
| 14122 | 1.25" – 1.5" | Collar | 038753141220 | 36 |
| 14135 | 2" | Collar | 038753141350 | 24 |
| 14137 | 3" – 4" | All Flash Collar | 038753141374 | 12 |
| 14193 | 3" | Collar | 038753141930 | 24 |
| 14203 | 4" | Collar | 038753142036 | 12 |



Master Flash® Roof Flashings

- Slides over pipe - for pitch to 45 degrees.
- Use silicone sealant between base and surface, and secure with sheet metal screws.
- Multi-size pipe sealing range.
- Molds to metal, plastic, etc.
- Non-fading EPDM collar.
- Rated 100°C continuous heat and approved for Type B installations.

MASTER FLASH® is a Registered Trademark of the Aztec Washer Company, Inc.

| Product No. | Size | Description | UPC | Ctn. Qty. |
|-------------|--------------|--------------------------------|--------------|-----------|
| 14050 | .25" – 2" | Master Flash® 4.5" x 4.5" base | 038753140506 | 6 |
| 14051 | 1.25" – 3" | Master Flash® 6" x 6" base | 038753140513 | 6 |
| 14052 | .25" – 5.75" | Master Flash® 8" x 8" base | 038753140520 | 6 |
| 14053 | 3" – 6" | Master Flash® 10" x 10" base | 038753140537 | 6 |
| 14054 | 4" – 7" | Master Flash® 11" x 11" base | 038753140544 | 2 |
| 14055 | 5" – 9" | Master Flash® 12" x 12" base | 038753140551 | 2 |
| 14056 | 6" – 11" | Master Flash® 14" x 14" base | 038753140568 | 2 |
| 14057 | 7" – 13" | Master Flash® 17" x 17" base | 038753140575 | 2 |
| 14059 | 10" – 18" | Master Flash® 25" x 25" base | 038753140599 | 5 |



Universal Master Flash® Roof Flashings

- Engineered for profiled roofing systems at any pitch.
- Rated 212°F continuous heat and approved for Type B installations.
- Easily customized to accommodate a broad range of pipe diameters.

| Product No. | Size | Description | UPC | Ctn. Qty. |
|-------------|-----------|-------------------------------------|--------------|-----------|
| 14743 | 1/4" – 5" | Universal Master Flash® 7-3/4" base | 750405147434 | 5 |

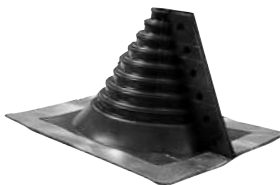

Retro Master Flash® Roof Flashings

- Split collar design easily installs on pipe with limited over the top access.
- Easily customized to accommodate a broad range of pipe diameters.
- Engineered for profiled roofing systems at any pitch.
- Rated 100°C continuous heat and approved for Type B installations.

| Product No. | Size | Description | UPC | Ctn. Qty. |
|-------------|-------------|----------------------------------|--------------|-----------|
| 14049 | .25" – 4" | Retro Master Flash® 8" x 8" base | 038753140490 | 1 |
| 14751 | .5" – 4" | Retro Master Flash® 8" x 8" base | 750405147519 | 10 |
| 14752 | 4" – 9.25" | Retro Master Flash® 8" x 8" base | 750405147526 | 5 |
| 14753 | 9.25" – 16" | Retro Master Flash® 8" x 8" base | 750405147533 | 5 |

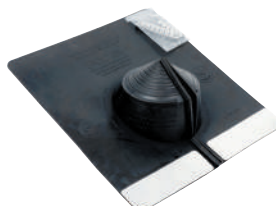

Electrical Service Mast (ESM) Master Flash® Roof Flashings

- Galvanized base.
- Self-sealing collar slides over pipe and requires no caulking.
- Collar unattached from flashing base for Electrical Service Mast applications.
- Do not use petroleum based products or paint on flashing collar or plastic base. Not for hot-mopped or built-up roofs.

| Product No. | Size | Description | UPC | Ctn. Qty. |
|-------------|------------|--------------------------------------|--------------|-----------|
| 14090 | 0 – 5-3/8" | EPDM ESM Master Flash 15" x 15" base | 038753140902 | 4 |

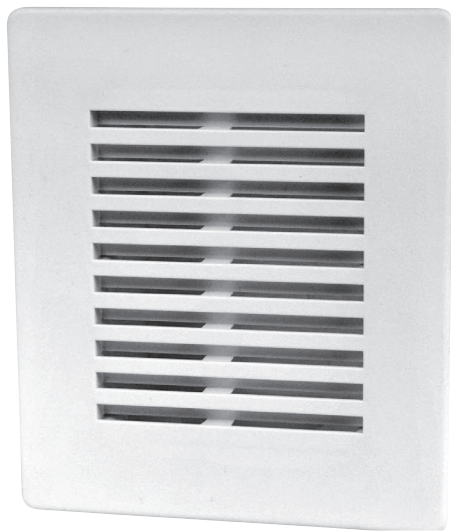

Category 13

Air Admittance Valves (AAV)

Sensitivity to pressure changes, combined with its ability to consistently open and close, is what distinguishes the Oatey® Sure-Vent® AAV from all others. Superior engineering along with stringent quality standards ensure a lifetime of unmatched performance. Available in multiple DFU capacities to meet various applications (8, 24, 72 and 500 DFU).

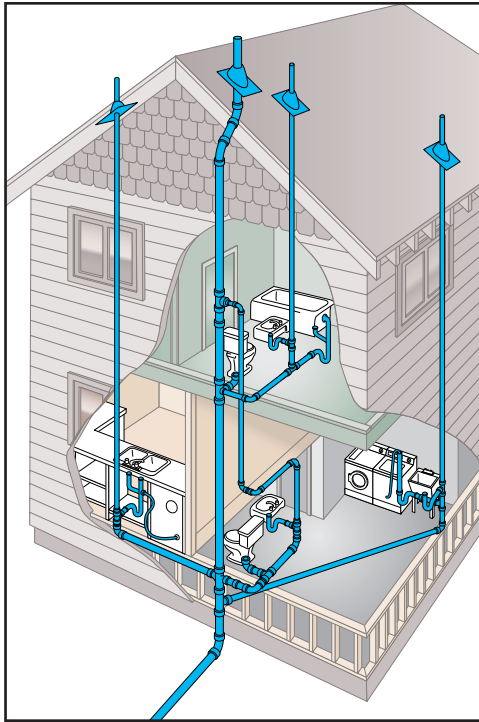

Traditional Vented House

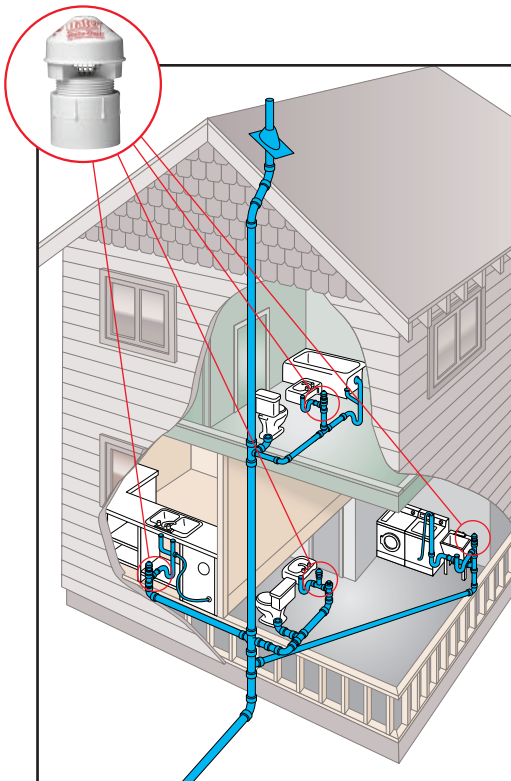

AAV Vented House

Plumbing Drain, Waste and Vent systems, known as DWV, consist of the DRAIN pipes that provide a network for the removal of WASTE and the VENT pipes that prevent traps from siphoning and maintain an equalized pressure. The DWV system uses gravity and air displacement throughout the piping network to function and breathe. In a simplified example, water in an inverted bottle without an air hole will glug and gasp when emptied. Adding an opening to the bottom of the bottle will turn the process into an efficient, steady flow because the bottle “breathes.”

Every Drain Needs a Trap. Every Trap Needs a Vent.

To prevent sewer gases from being released into the structure, plumbing code requires a trap to be installed at every fixture. A trap is a U-shaped bend of pipe filled with water that acts as a barrier between the structure and the sewer system. Trap seals can only be compromised under two conditions – high sewer pressures and water siphons, in both cases vents prevent this from happening.

Under high sewer pressures without a vent, trap seals will allow sewer gases to escape and enter the structure. This happens when the sewer pressure is greater than the pressure from the column of water in the trap. A vent will keep the sewer and atmospheric pressures equalized to maintain the trap seal.

Water moving through pipes can create a negative pressure or a siphon. The siphon will pull the water from a trap, leaving a clear path for sewer gases to enter the structure. A vent will prohibit siphoning, maintaining the trap seal.

Why Use a Sure-Vent® Air Admittance Valve?

Air Admittance Valves (AAVs) open and close in conjunction with normal DWV system operation, effectively eliminating the need for secondary vent pipes. An AAV provides an alternative to secondary venting when utilized within the scope of model plumbing codes, referenced standards and Oatey® installation instructions.

AAVs provide the ideal venting solution for island sinks, remote bathroom groups and remodeling jobs by eliminating the need to tie into a stack vent.

AAVs are often more economical than running vent pipe in new construction because they reduce the added need for supplies and labor.

The Oatey Sure-Vent offers UNMATCHED PERFORMANCE by opening and closing under the smallest pressures, multiple sizes for OPTIMIZED DFUs and SUPERIOR SEALING technology, providing a lifetime of reliability.

AIR ADMITTANCE VALVES (AAV)



Oatey® Sure-Vent® Air Admittance Valve – 20 Branch, 8 Stack DFU Capacity

- Complies to ASSE Standard 1050 and 1051.
- For use as a secondary vent.
- One size approved to handle up to 2" vent pipe.
- Opens/closes as needed by building's plumbing system.

| Product No. | Adapter Size | Description | UPC | Ctn. Qty. |
|-------------|--------------|--|--------------|-----------|
| 39225 | 1.5" | 20 Branch, 8 Stack DFU Sure-Vent AAV 1-1/2" Tubular adapter (white) | 038753392257 | 6 |
| 39239 | 1.5" | 20 Branch, 8 Stack DFU AAV Installation Kit 1-1/2" P-trap, 6" extension tube, PVC threaded adapter & deep box flange | 038753392394 | 6 |
| 39228 | 1.5" | 20 Branch, 8 Stack DFU Sure-Vent AAV w/ PVC Adapter | 038753392288 | 6 |
| 39229 | 1.5" | 20 Branch, 8 Stack DFU Sure-Vent AAV w/ ABS Adapter | 038753392295 | 6 |
| 39256 | 1.5" – 2" | 6 DFU Sure-Vent AAV ABS Schedule 40 adapter | 038753392561 | 6 |



Oatey® Sure-Vent® Air Admittance Valve – 160 Branch, 24 Stack DFU Capacity

- Complies to ASSE Standard 1050 and 1051.
- For use as a secondary vent.
- One size approved to handle up to 3" vent pipe.
- Opens/closes as needed by building's plumbing system.

| Product No. | Adapter Size | Description | UPC | Ctn. Qty. |
|-------------|--------------|--|--------------|-----------|
| 39016 | 1.5" – 2" | 160 Branch, 24 Stack DFU Sure-Vent AAV 1-1/2" x 2" Sch. 40 PVC Adapter | 038753390161 | 6 |
| 39017 | 1.5" – 2" | 160 Branch, 24 Stack DFU Sure-Vent AAV 1-1/2" x 2" Sch. 40 PVC Adapter (Bulk) | 038753390178 | 50 |
| 39018 | 1.5" – 2" | 160 Branch, 24 Stack DFU Sure-Vent AAV 1-1/2" x 2" Sch. 40 ABS Adapter | 038753390185 | 6 |
| 39019 | 1.5" – 2" | 160 Branch, 24 Stack DFU Sure-Vent AAV 1-1/2" x 2" Sch. 40 ABS Adapter (Bulk) | 038753390192 | 50 |
| 39238 | 1.5" – 2" | 160 Branch, 24 Stack DFU Sure-Vent AAV with mechanical adaptor | 038753392387 | 12 |



Oatey® Sure-Vent® Air Admittance Valve – 160 Branch, 72 Stack DFU Capacity

- Complies to ASSE Standard 1050 and 1051.
- For use as a secondary vent.
- One size approved to handle up to 4" vent pipe.
- Opens/closes as needed by building's plumbing system.

| Product No. | Adapter Size | Description | UPC | Ctn. Qty. |
|-------------|--------------|--|--------------|-----------|
| 39220 | 2" – 3" | 160 Branch, 72 Stack DFU Sure-Vent AAV 2" x 3" Sch. 40 PVC adapter | 038753392202 | 6 |
| 39221 | 2" – 3" | 160 Branch, 72 Stack DFU Sure-Vent AAV 2" x 3" Sch. 40 ABS adapter | 038753392219 | 6 |

AIR ADMITTANCE VALVES (AAV)



Oatey® Sure-Vent® Air Admittance Valve – 160 Branch, 500 Stack DFU Capacity

- Complies to ASSE Standard 1050 and 1051.
- For use as a secondary vent.
- One size approved to handle up to 4" vent pipe.
- Opens/closes as needed by building's plumbing system.

| Product No. | Adapter Size | Description | UPC | Ctn. Qty. |
|-------------|--------------|---|--------------|-----------|
| 39223 | 3" – 4" | 160 Branch, 500 Stack DFU Sure-Vent AAV 3" x 4" Sch. 40 PVC adapter | 038753392233 | 6 |
| 39224 | 3" – 4" | 160 Branch, 500 Stack DFU Sure-Vent AAV 3" x 4" Sch. 40 ABS adapter | 038753392240 | 6 |



Oatey® MODA™ Sure-Vent® Air Admittance Valve Box

- Includes 160 branch, 24 stack DFU AAV with louvered faceplate
- Louvered, solid and semi-cover faceplate inserts available. See MODA Accessories

| Product No. | Description | UPC | Ctn. Qty. |
|-------------|--|--------------|-----------|
| 37981 | MODA, Sure-Vent AAV Standard Drain – Standard Pack | 038753379814 | 12 |



Oatey® Sure-Vent® Access Panel

- Allows access to Sure-Vent air admittance valve.
- Meets code requirements for recessing an air admittance valve in a wall.

| Product No. | Size | Description | UPC | Ctn. Qty. |
|-------------|---------|------------------------------|--------------|-----------|
| 34247 | 6" x 9" | Louvered Design Access Panel | 038753342474 | 6 |



Oatey® Sure-Vent® Wall Box

- New, smaller size: 4-1/2" x 5-3/4".
- High-impact polystyrene construction.
- Accommodates 20 branch/8 stack, 160 branch/24 stack DFU AAVs with 1-1/2" or 2" adapters.

| Product No. | Size | Description | UPC | Ctn. Qty. |
|-------------|------|---|--------------|-----------|
| 39260 | | Box Kit | 038753392608 | 6 |
| 39261 | | Louvered Faceplate | 038753392615 | 6 |
| 39262 | | Box Kit with PVC Adapter and 24 DFU AAV | 038753392622 | 6 |
| 39263 | | Box Kit with ABS Adapter and 24 DFU AAV | 038753392639 | 6 |



Oatey® In-Line Vent

- Mechanical vent installs on the drain line and vents the line without allowing sewer gas to enter the home.
- Available in either chrome or ABS & packaged in polybag.
- For venting sinks, tubs, showers, washing machines, etc.
- Eliminates the need for secondary stacks.

| Product No. | Size | Description | UPC | Ctn. Qty. |
|-------------|------|---------------------|--------------|-----------|
| 39000 | | Chrome In-Line Vent | 038753390000 | 6 |
| 39012 | | ABS In-Line Vent | 038753390123 | 6 |



Category 14

Pipe Support

Oatey® and MASTERS® offer a complete range of pipe support products for all of your application needs. Whether it's securing supply lines, DWV pipe or supporting your work with brackets and bars, you can count on Oatey for quality, performance and innovation.

Oatey® Full Clamp

Easy installation.
Easy removal when you need it.

FEATURES AND BENEFITS

- Push on installation — lead in edge automatically opens up clamp
- Patented removal wedge and notch allows for clamp removal
- Complete stand-off from surface
- 360° pipe protection — allows tube to expand and contract

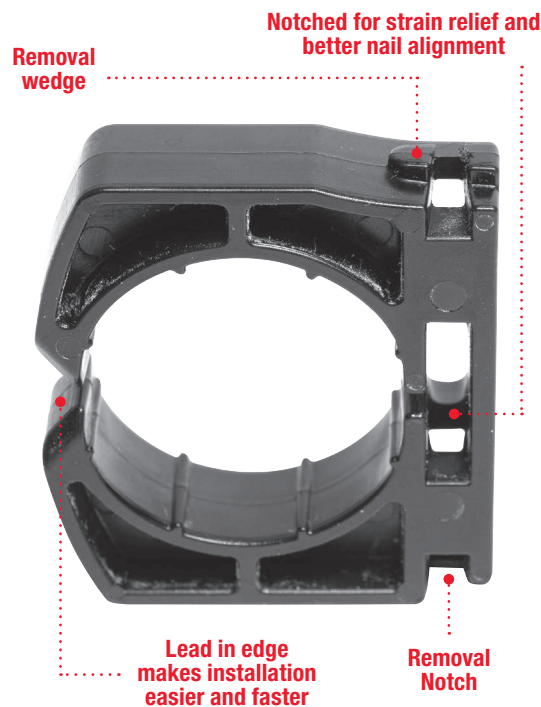

Clamps by the Bucket

No need to break the bank when buying a bucket of clamps from Oatey®. You can now get your favorite clamps, including the new Duo-Fit and Stand-Off, in a handy 2.1 gallon Oatey bucket. The bucket holds 300-900 clamps depending on the size and type. And each bucket features a unique reclosable lid. No need to cut a hole in the lid like other buckets force you to do, tearing your hand up in the process of grabbing a handful of clamps. Better yet, when the bucket is empty, it makes a great storage container, or is useful when working on plumbing under sinks and tight areas where bigger buckets just can't fit.

- **Smaller size bucket saves you money, more versatile.**
- **Reclosable lid is easy on the hands.**





Oatey® DuoFit™ Pipe Clamps

- One clamp fits both 1/2" and 3/4" size pipe.
- Use on copper, CPVC and PEX.
- Move pre-loaded nail to keep pipe off of stud.
- Temperature range: -17°C – 110°C.
- Constructed of black polypropylene.
- UPC listed.
- Available in 2 gallon buckets.

| Product No. | Size | Description | UPC | Ctn. Qty. |
|-------------|-------------|--|--------------|-----------|
| 34285 | 1/2" – 3/4" | DuoFit Pipe Support System with Nail (100 in polybag) | 038753342856 | 500 Pcs |
| 34295 | 1/2" – 3/4" | DuoFit Pipe Support System with Nail (12 in polybag) | 038753342955 | 6 Bags |
| 34297 | 1/2" – 3/4" | DuoFit Pipe Support System with Nail - 400 in 2 gallon bucket | 038753342979 | 1 |



Oatey® Stand-Off™ Half Clamps

- Clamps keep pipe completely off of the stud.
- Pre-loaded nail provides fast and easy installation.
- Made of high-impact polypropylene.
- Temperature range: -51°C – 71°C.
- UPC listed.
- Available in 2 gallon buckets.

| Product No. | Size | Description | UPC | Ctn. Qty. |
|-------------|------|--|--------------|-----------|
| 34286 | 1/2" | Stand-Off Pipe Clamp with Nail (100 in polybag) | 038753342863 | 500 Pcs |
| 34287 | 3/4" | Stand-Off Pipe Clamp with Nail (100 in polybag) | 038753342870 | 500 Pcs |
| 34288 | 1" | Stand-Off Pipe Clamp with Nail (50 in polybag) | 038753342887 | 250 Pcs |
| 34298 | 1/2" | Stand-Off Pipe Clamp with Nail – 500 in 2.1 gallon bucket | 038753342986 | 1 |
| 34299 | 3/4" | Stand-Off Pipe Clamp with Nail – 300 in 2.1 gallon bucket | 038753342993 | 1 |



Oatey® Pipe Clamps With Nail

- Pre-loaded nail feature provides fast and easy installation.
- Ribbed design insulates against water line noise.
- No corrosion – made of high impact polypropylene.
- Rust resistant nails.
- Can be used on hydronic systems.
- UPC listed.

| Product No. | Size | Description | UPC | Ctn. Qty. |
|-------------------|------|--|--------------|-----------|
| HALF CLAMP | | | | |
| 33900 | 1/2" | Half Clamp w/barbed nail (100 in polybag) | 038753339009 | 500 Pcs |
| 33901 | 3/4" | Half Clamp w/barbed nail (100 in polybag) | 038753339016 | 500 Pcs |
| 33902 | 1" | Half Clamp w/barbed nail (50 in polybag) | 038753339023 | 250 Pcs |
| 33910 | 1/2" | Half Clamp w/barbed nail (12 in polybag) | 038753339108 | 6 Bags |
| 33911 | 3/4" | Half Clamp w/barbed nail (12 in polybag) | 038753339115 | 6 Bags |
| 34290 | 1/2" | Half Clamp w/barbed nail – 900 in 2.1 gallon bucket | 038753342900 | 1 |
| 34291 | 3/4" | Half Clamp w/barbed nail – 500 in 2.1 gallon bucket | 038753342917 | 1 |
| 34292 | 1" | Half Clamp w/barbed nail – 300 in 2.1 gallon bucket | 038753342924 | 1 |
| 34900 | 1/2" | Half Clamp w/barbed nail (100 in polybag) | 038753349008 | 5 Bags |
| 34901 | 3/4" | Half Clamp w/barbed nail (100 in polybag) | 038753349015 | 5 Bags |
| FULL CLAMP | | | | |
| 33905 | 1/2" | Full Clamp w/barbed nail (100 in polybag) | 038753339054 | 500 Pcs |
| 33906 | 3/4" | Full Clamp w/barbed nail (50 in polybag) | 038753339061 | 250 Pcs |
| 33907 | 1" | Full Clamp w/barbed nail (25 in polybag) | 038753339078 | 250 Pcs |
| 33912 | 1/2" | Full Clamp w/barbed nail (12 in polybag) | 038753339122 | 6 Bags |
| 33913 | 3/4" | Full Clamp w/barbed nail (12 in polybag) | 038753339139 | 6 Bags |





Oatey® Suspension Pipe Clamps/Half Clamp

- Eliminates contact between the pipe and framing surface thereby reducing transmission of water line noise.
- No corrosion – made of durable polypropylene.
- Ribbed design allows faster cooling and pipe expansion and contraction.
- Can be used on hydronic systems.
- UPC listed.

| Product No. | Size | Description | UPC | Ctn. Qty. |
|-------------|--------|--|--------------|-----------|
| 33914 | 1/2" | Suspension Pipe Clamp (6 in polybag) | 038753339146 | 6 Bags |
| 33915 | 3/4" | Suspension Pipe Clamp (6 in polybag) | 038753339153 | 6 Bags |
| 33935 | 1/2" | Suspension Pipe Clamp (100 in polybag) | 038753339351 | 500 Pcs |
| 33936 | 3/4" | Suspension Pipe Clamp (100 in polybag) | 038753339368 | 500 Pcs |
| 33937 | 1" | Suspension Pipe Clamp (50 in polybag) | 038753339375 | 250 Pcs |
| 33956 | 1-1/4" | Suspension Pipe Clamp (25 in polybag) | 038753339566 | 250 Pcs |
| 33957 | 1-1/2" | Suspension Pipe Clamp (25 in polybag) | 038753339573 | 250 Pcs |
| 33958 | 2" | Suspension Pipe Clamp (25 in polybag) | 038753339580 | 250 Pcs |
| 34293 | 1/2" | Suspension Pipe Clamp – 325 in 2.1 gallon bucket | 038753342931 | 250 Pcs |
| 34294 | 3/4" | Suspension Pipe Clamp – 250 in 2.1 gallon bucket | 038753342948 | 250 Pcs |



Oatey® Insulating Pipe Clamps

- Designed to eliminate notching and wrapping of pipe when running water lines through framing.
- Reduces water line noise and vibration.
- No corrosion – made of durable, low-density polypropylene (gray colour).
- UPC listed.

| Product No. | Size | Description | UPC | Ctn. Qty. |
|-------------|------|---------------------------------------|--------------|-----------|
| 33950 | 1/2" | Insulating Pipe Clamp (50 in polybag) | 038753339504 | 250 Pcs |
| 33953 | 1/2" | Insulating Pipe Clamp (6 in polybag) | 038753339535 | 6 Bags |
| 33951 | 3/4" | Insulating Pipe Clamp (50 in polybag) | 038753339511 | 250 Pcs |
| 33954 | 3/4" | Insulating Pipe Clamp (6 in polybag) | 038753339542 | 6 Bags |
| 33952 | 1" | Insulating Pipe Clamp (25 in polybag) | 038753339528 | 250 Pcs |



Oatey® Standard Pipe Clamps

- Clamp design allows pipe to be flush mounted to walls and joists.
- Minimizes the transmission of water line noise.
- No corrosion – made of durable polypropylene (gray colour).
- Ribbed design allows pipe to cool faster and expand/contract freely.
- Can be used on hydronic systems.
- UPC listed.

| Product No. | Size | Description | UPC | Ctn. Qty. |
|-------------|--------|--------------------------------------|--------------|-----------|
| 33916 | 1/2" | Standard Pipe Clamp (6 in polybag) | 038753339160 | 6 Bags |
| 33917 | 3/4" | Standard Pipe Clamp (6 in polybag) | 038753339177 | 6 Bags |
| 33940 | 1/2" | Standard Pipe Clamp (100 in polybag) | 038753339405 | 500 Pcs |
| 33941 | 3/4" | Standard Pipe Clamp (100 in polybag) | 038753339412 | 500 Pcs |
| 33942 | 1" | Standard Pipe Clamp (50 in polybag) | 038753339429 | 250 Pcs |
| 33943 | 1-1/4" | Standard Pipe Clamp (25 in polybag) | 038753339436 | 250 Pcs |
| 33944 | 1-1/2" | Standard Pipe Clamp (25 in polybag) | 038753339443 | 250 Pcs |
| 33946 | 2" | Standard Pipe Clamp (25 in polybag) | 038753339467 | 250 Pcs |

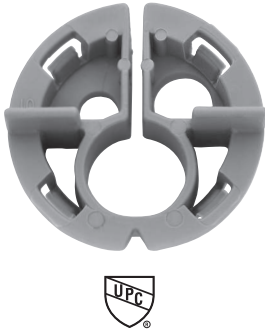

Oatey® Metal Stud Insulating Pipe Clamps

- Reduces water line noise and vibration when running water lines through metal studs.
- Hand tighten into place.
- 1/2" size has 1/4" and 3/8" holes.
- Use on 18 gauge or lighter weight metal studs.
- No corrosion – made of durable polypropylene.
- Can be used on hydronic systems.
- Tabs for easy adjustment.
- Patent #6,598,835 and UPC listed.

| Product No. | Size | Description | UPC | Ctn. Qty. |
|-------------|------|--|--------------|-----------|
| 33856 | 1/2" | Metal Stud Insulating Pipe Clamp (50 in polybag) | 038753338569 | 250 Pcs |
| 33857 | 3/4" | Metal Stud Insulating Pipe Clamp (50 in polybag) | 038753338576 | 250 Pcs |
| 33858 | 1" | Metal Stud Insulating Pipe Clamp (25 in polybag) | 038753338583 | 250 Pcs |



Oatey® Holdrite® Pipe Support Bracket

- Supports any water supply lines penetrating the wall.
 - Holes on 2" centers for 1/2" pipe and 4" centers for 3/4" and 1" copper pipe.
 - Nail in place and solder pipe to copper plated bracket for secure installation.
- Holdrite® is a registered trademark of Securus, Inc.

| Product No. | Size | Description | UPC | Ctn. Qty. |
|-------------|------|----------------------|--------------|-----------|
| 33980 | | Pipe Support Bracket | 038753339801 | 25 Pcs |



Oatey® Hyco Bar

- Multi-purpose Galvanized Strap.

| Product No. | Size | Description | UPC | Ctn. Qty. |
|-------------|------------|-------------------|--------------|-----------|
| 33982 | 5/8" x 18" | Hyco-Bar – 14 Ga. | 038753339825 | 100 |
| 33983 | 5/8" x 26" | Hyco-Bar – 14 Ga. | 038753339832 | 100 |



Oatey® Flat Tube Nailers

- Copper plated tube nailers provide quick nail support.
- Use with copper, PVC, CPVC, galvanized, PEX and other piping systems.

| Product No. | Size | Description | UPC | Ctn. Qty. |
|-------------|-------------|--|--------------|-----------|
| 33965 | 1/2" – 3/4" | Copper Coated Tube Nailers (12 in polybag) | 038753339658 | 36 Bags |
| 33966 | 1/2" – 3/4" | Copper Coated Steel Nailers (100 in polybag) | 038753339665 | 1000 Pcs |



MASTERS® Copper And Copper Clad Clips

- Dimples to lock in pipe
- Nails included

| Product No. | Size | Description | UPC | Ctn. Qty. |
|-------------|------|---|--------------|-----------|
| CLCC50 | .50" | MASTERS Clips Copper Clad - 10 per bag | 067001004413 | 1000 |
| CLCC50V | .50" | MASTERS Clips Copper Clad - 100 per bag | 067001004420 | 2000 |
| CLCC75 | .75" | MASTERS Clips Copper Clad - 10 per bag | 067001004437 | 1000 |
| CLCC75V | .75" | MASTERS Clips Copper Clad - 100 per bag | 067001004444 | 1500 |
| CLC50V | .50" | MASTERS Clips Copper - 100 per bag | 067001004383 | 2000 |
| CLC75V | .75" | MASTERS Clips Copper - 100 per bag | 067001004406 | 1500 |



Oatey® Copper and Steel Pipe Hooks

- Use with copper, PVC, CPVC, galvanized, PEX and other piping systems.
- Support pipe from rafters or joists.
- Self-nailing.

| Product No. | Size | Description | UPC | Ctn. Qty. |
|-------------|-----------|-------------------------------|--------------|-----------|
| 33971 | 1/2" x 6" | Copper Pipe Hook – 50 per Box | 038753339719 | 500 Pcs |
| 33973 | 3/4" x 6" | Copper Pipe Hook – 50 per Box | 038753339733 | 500 Pcs |
| 33972 | 3/4" x 6" | Copper Pipe Hook – 12 per Bag | 038753339726 | 10 Bags |
| 33975 | 1" x 6" | Copper Pipe Hook – 50 per Box | 038753339757 | 500 Pcs |
| 33969 | 1" x 6" | Copper Pipe Hook – 6 per Bag | 038753339696 | 12 Bags |
| 33974 | 1" x 6" | Copper Pipe Hook – 12 per Bag | 038753339740 | 10 Bags |
| 33997 | 1" x 6" | Steel Pipe Hook – 50 per Box | 038753339979 | 500 Pcs |
| 33998 | 1/2" x 6" | Steel Pipe Hook – 50 per Box | 038753339986 | 500 Pcs |
| 33955 | 1/2" x 6" | Steel Pipe Hook – 6 per Bag | 038753339559 | 6 Bags |
| 33964 | 1/2" x 6" | Steel Pipe Hook – 12 per Bag | 038753339641 | 12 Bags |
| 33999 | 3/4" x 6" | Steel Pipe Hook – 50 per Box | 038753339993 | 500 Pcs |



Oatey® DWV J-Hook

- Pre-loaded nails in stem.
- Diagonal nail path for use in tight applications.
- Locking finger for tight hold at any angle, including inverted.
- Additional holes allow securing with cable ties or other fasteners.
- Made of black and white ABS. Temperature range: -40°C - 82°C.

| Product No. | Size | Description | UPC | Ctn. Qty. |
|-------------|-----------------|------------------------------------|--------------|-----------|
| 33740 | 1-1/2" x 7-1/2" | DWV J-Hook – White (25 In Polybag) | 038753337401 | 300 Pcs |
| 33741 | 2" x 7-1/2" | DWV J-Hook – White (25 In Polybag) | 038753337418 | 300 Pcs |
| 33742 | 3" x 7-1/2" | DWV J-Hook – White (25 In Polybag) | 038753337425 | 300 Pcs |
| 33743 | 4" x 7-1/2" | DWV J-Hook – White (25 In Polybag) | 038753337432 | 300 Pcs |
| 33755 | 1-1/2" x 7" | DWV J-Hook – Black (25 In Polybag) | 038753337555 | 300 Pcs |
| 33756 | 2" x 7" | DWV J-Hook – Black (25 In Polybag) | 038753337562 | 300 Pcs |
| 33757 | 3" x 7" | DWV J-Hook – Black (25 In Polybag) | 038753337579 | 300 Pcs |
| 33758 | 4" x 7" | DWV J-Hook – Black (25 In Polybag) | 038753337586 | 300 Pcs |
| 33760 | 1-1/2" x 7-1/2" | DWV J-Hook – White (4 In Polybag) | 038753337609 | 6 Bags |
| 33761 | 2" x 7- 1/2" | DWV J-Hook – White (4 In Polybag) | 038753337616 | 6 Bags |
| 33762 | 3" x 7-1/2" | DWV J-Hook – White (4 In Polybag) | 038753337623 | 6 Bags |
| 33763 | 4" x 7-1/2" | DWV J-Hook – White (4 In Polybag) | 038753337630 | 6 Bags |



Oatey® CTS J-Hook

- Support copper and CPVC water supply lines from joists and rafters.
- J-Hook nails flush against a wall or stud.
- Made of high impact ABS for increased load capacity.
- UPC listed.

| Product No. | Size | Description | UPC | Ctn. Qty. |
|-------------|---------------|--------------------------------------|--------------|-----------|
| 33745 | 1/2" x 4" | CTS Baby J-Hook (25 in polybag) | 038753337456 | 300 Pcs |
| 33764 | 1/2" x 4" | CTS Baby J-Hook (6 in polybag) | 038753337647 | 6 Bags |
| 33746 | 3/4" x 4" | CTS Baby J-Hook (25 in polybag) | 038753337463 | 300 Pcs |
| 33765 | 3/4" x 4" | CTS Baby J-Hook (6 in polybag) | 038753337654 | 6 Bags |
| 33747 | 1" x 4" | CTS Baby J-Hook (25 in polybag) | 038753337470 | 200 Pcs |
| 33766 | 1" x 4" | CTS Baby J-Hook (6 in polybag) | 038753337661 | 6 Bags |
| 33750 | 1/2" x 7-1/2" | CTS Long Baby J-Hook (25 in polybag) | 038753337500 | 200 Pcs |
| 33751 | 3/4" x 7-1/2" | CTS Long Baby J-Hook (25 in polybag) | 038753337517 | 200 Pcs |

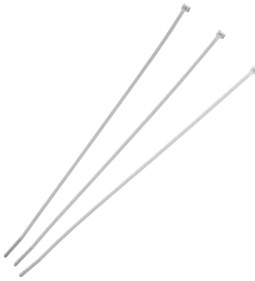

Oatey® Cable, Conduit & Duct Ties

- Enables cables, tubing, etc. to be secured together.
- Special locking device provides a positive, non-slip grip.
- Made of nylon.

| Product No. | Size | Description | UPC | Ctn. Qty. |
|-------------|--------|--|--------------|-----------|
| 33850 | 7-1/2" | Ties for 1-3/4" diameter (25 in polybag) | 038753338507 | 12 Bags |
| 33851 | 11" | Ties for 3" diameter (25 in polybag) | 038753338514 | 12 Bags |
| 33852 | 14" | Ties for 4" diameter (25 in polybag) | 038753338521 | 12 Bags |
| 33853 | 24" | Ties for 7" diameter (6 in polybag) | 038753338538 | 12 Bags |
| 33854 | 34" | Ties for 10" diameter (6 in polybag) | 038753338545 | 12 Bags |
| 33855 | 48" | Ties for 15" diameter (6 in polybag) | 038753338552 | 12 Bags |



#33930 shown



#33932 shown

Oatey® Stud Guards and FHA Plates

- Provide protection for pipes and wiring installations.
- Stud guards have special self-nailing feature.
- Made of 16 or 18 gauge steel.

| Product No. | Size | Description | UPC | Ctn. Qty. |
|-------------|-------------|--|--------------|-----------|
| 33893 | 1-1/2" x 3" | 16 Gauge Self-Nailing Stud Guard – 2-1/2" between points | 038753338934 | 100 Pcs |
| 33894 | 1-1/2" x 5" | 16 Gauge Self-Nailing Stud Guard – 4-1/2" between points | 038753338941 | 100 Pcs |
| 33895 | 1-1/2" x 6" | 16 Gauge Self-Nailing Stud Guard – 5-1/2" between points | 038753338958 | 100 Pcs |
| 33897 | 5" x 8" | 16 Gauge BOCA Plate Meets BOCA Code P-309.2 | 038753338972 | 25 Pcs |
| 33919 | 1-1/2" x 6" | 18 Gauge Self-Nailing Stud Guard – 5-1/2" between points | 038753339191 | 100 Pcs |
| 33930 | 1-1/2" x 3" | 18 Gauge Self-Nailing Stud Guard – 2-1/2" between points | 038753339306 | 100 Pcs |
| 33931 | 1-1/2" x 5" | 18 Gauge Self-Nailing Stud Guard – 4-1/2" between points | 038753339313 | 100 Pcs |
| 33932 | 1-1/2" x 9" | 18 Gauge FHA Plate -Barcoded | 038753339320 | 25 Pcs |
| 33933 | 1-1/2" x 3" | 18 Gauge Self-Nailing Stud Guard – Barcoded | 038753339337 | 25 Pcs |



Oatey® Copper Plated Bell Hangers

- Designed with 13/16" standoff from mounting surface.
- Mounting screw has pierce point for use on metal studs.
- Recessed mounting screw does not contact the piping.
- Includes two clamp screws and one 2-1/2" screws.

| Product No. | Size | Description | UPC | Ctn. Qty. |
|-------------|------|---------------------------|--------------|-----------|
| 33691 | 1/2" | Copper Plated Bell Hanger | 038753336916 | 25 |
| 33692 | 3/4" | Copper Plated Bell Hanger | 038753336923 | 25 |
| 33693 | 1" | Copper Plated Bell Hanger | 038753336930 | 25 |



Oatey® Copper Plated Milford Hangers

- Hang copper tube size piping.
- Top set plate swivels and locks into place.

| Product No. | Size | Description | UPC | Ctn. Qty. |
|-------------|------------|------------------------------|--------------|-----------|
| 33694 | 1/2" x 6" | Copper Plated Milford Hanger | 038753336947 | 25 |
| 33695 | 3/4" x 6" | Copper Plated Milford Hanger | 038753336954 | 25 |
| 33696 | 1" x 6" | Copper Plated Milford Hanger | 038753336961 | 25 |
| 33697 | 1/2" x 12" | Copper Plated Milford Hanger | 038753336978 | 25 |
| 33698 | 3/4" x 12" | Copper Plated Milford Hanger | 038753336985 | 25 |
| 33699 | 1" x 12" | Copper Plated Milford Hanger | 038753336992 | 25 |



Oatey® Universal Pipe Support

- Meets ASTM Requirements.
- IAPMO Approved.
- Strap adjusts to accommodate 1"-6" diameter pipe.
- Available in white and black color plastic.
- Orientation of the strap can be reversed based on installation need.
- Straight and angled nail hole patterns to accommodate tough installation angles.

| Product No. | Size | Description | UPC | Ctn. Qty. |
|-------------|------|-----------------------------------|--------------|-----------|
| 33664 | 14" | Universal DWV Pipe Hanger - Black | 038753336640 | 25 |
| 33665 | 14" | Universal DWV Pipe Hanger - White | 038753336657 | 25 |



Oatey® Plastic Hanger Strap

- Nail holes are 1/8" in diameter and spaced 3/4" apart.
- Non-corrosive, non-conductive, polyethylene.
- Quick and inexpensive way to hang pipe from joists or rafters.

| Product No. | Size | Description | UPC | Ctn. Qty. |
|-------------|-------------|-------------------------------|--------------|-----------|
| 33925 | 3/4" x 25' | Plastic Hanger Strap – Bagged | 038753339252 | 20 Pcs |
| 33926 | 3/4" x 50' | Plastic Hanger Strap – Bagged | 038753339269 | 20 Pcs |
| 33927 | 3/4" x 100' | Plastic Hanger Strap – Bagged | 038753339276 | 20 Pcs |
| 33928 | 3/4" x 10' | Plastic Hanger Strap – Bagged | 038753339283 | 12 Pcs |



MASTERS® Suspension Strapping

- Wavy design for easy bending.
- Available in various gauges, lengths and materials.

| Product No. | Size | Description | UPC | Ctn. Qty. |
|-------------------------------|-----------------------|--------------------------------|--------------|-----------|
| COPPER | | | | |
| SC222550 | 22 gauge 25' x 0.50" | MASTERS Strapping Copper | 067001004116 | 20 |
| SC241075 | 24 gauge 10' x 0.75" | MASTERS Strapping Copper | 067001004123 | 34 |
| SC242575 | 24 gauge 25' x 0.75" | MASTERS Strapping Copper | 067001004130 | 20 |
| COPPER CLAD | | | | |
| SCC242575 | 24 gauge 25' x 0.75" | MASTERS Strapping Copper Clad | 067001004154 | 20 |
| STRAPPING GALVANIZED | | | | |
| SG202575 | 20 gauge 25' x 0.75" | MASTERS Strapping Galvanized | 067001004178 | 20 |
| SG241075 | 24 gauge 10' x 0.75" | MASTERS Strapping Galvanized | 067001004192 | 34 |
| SG242550 | 24 gauge 25' x 0.50" | MASTERS Strapping Galvanized | 067001004208 | 20 |
| SG242575 | 24 gauge 25' x 0.75" | MASTERS Strapping Galvanized | 067001004215 | 20 |
| SG2410075 | 24 gauge 100' x 0.75" | MASTERS Strapping Galvanized | 067001004185 | 12 |
| STRAPPING NYLON COATED | | | | |
| ST221050COATED | 22 gauge 10' x 0.50" | MASTERS Strapping Nylon Coated | 067001004499 | 20 |
| STEEL | | | | |
| ST202575 | 20 gauge 25' x 0.75" | MASTERS Strapping Steel | 67001004277 | 20 |
| ST222550 | 22 gauge 25' x 0.50" | MASTERS Strapping Steel | 067001004307 | 20 |
| ST241075 | 24 gauge 10' x 0.75" | MASTERS Strapping Steel | 067001004338 | 34 |
| ST242575 | 24 gauge 25' x 0.75" | MASTERS Strapping Steel | 067001004345 | 20 |
| ST2410075 | 24 gauge 100' x 0.75" | MASTERS Strapping Steel | 067001004321 | 12 |





SAFETY SERIES

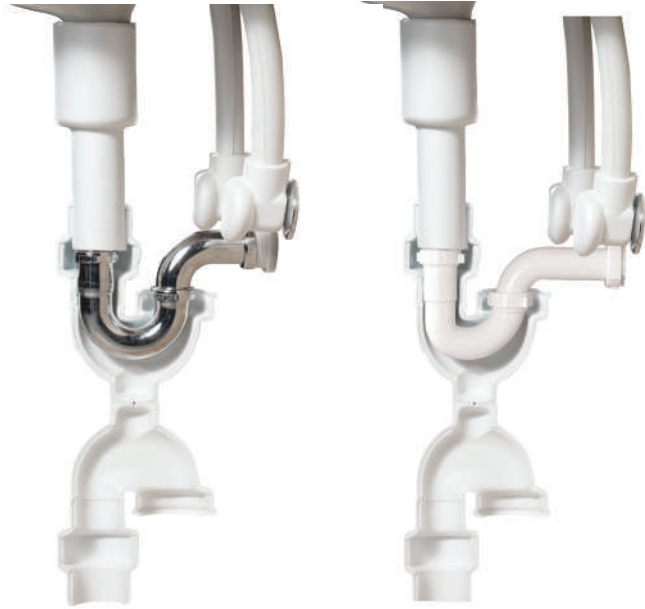

Category 15

Brass/Plastic Tubular, Grab Bars & Pipe Wrap

Known for tubular throughout North America, Dearborn Brass has been a recognized brand in the commercial and residential market for over a century, and offers an extensive line of grab bars in Peened – textured for better grip – and Satin finishes.

BRASS TUBULAR



Dearborn® Tubular Low-Inlet P-Traps

| Product No. | Size | Description | UPC | Ctn. Qty. |
|-------------|--------|---------------------------------|--------------|-----------|
| 711A-1 | 1-1/4" | Low-Inlet P-Trap 17 gauge brass | 041193123992 | 10 |
| 714A-1 | 1-1/2" | Low-Inlet P-Trap 17 gauge brass | 041193124005 | 10 |



Dearborn® Extension Tubes

| Product No. | Size | Description | UPC | Ctn. Qty. |
|-------------|--------------|---|--------------|-----------|
| 793A-17BN-1 | 1-1/2" x 12" | Extension Tube with Slip Joint 17 gauge brass w/Nut | 041193125835 | 10 |
| 793A-20-1 | 1-1/2" x 12" | Extension Tube with Slip Joint 20 gauge brass | 041193125842 | 10 |
| 793A-17-1 | 1-1/2" x 12" | Extension Tube with Slip Joint 17 gauge brass | 041193055248 | 10 |



Dearborn® Semi-Cast Grid Patent Outlet Plugs With Overflow

| Product No. | Size | Description | UPC | Ctn. Qty. |
|-------------|------|---|--------------|-----------|
| 760-1 | | Semi-Cast Grid Patent Overflow Plug w/ 1-1/4" x 6" - 17 Ga. Tailpiece | 041193124777 | 25 |
| 760W-1 | | Semi-Cast Grid Wheelchair Patent Overflow Plug w/ 1-1/4" - 17 Ga. Tailpiece | 041193124821 | 10 |

BARRIER-FREE LAVATORY TUBULAR COVERS

Dearborn® Safety Series Lavatory Tubular Covers

- For under-lavatory exposed plumbing in bathrooms.
- Universal offering to cover brass, plastic, and Schedule 40 tubular.
- Hook and loop fasteners make installation fast and simple.
- EVA Foam is easy to cut, size, and measure to fit.
- Easily accommodates offset supply lines.
- Clean appearance and aesthetics.
- Accommodates trap with and without cleanouts.
- Securely fits both 1-1/4" and 1-1/2" tubular systems.



| Product No. | Description | UPC | Ctn. Qty. |
|-------------|---|--------------|-----------|
| ADA094 | Single Supply Line and Valve Cover (1 each) | 041193000927 | 10 |
| ADA095 | Extension Tube Cover | 041193000903 | 10 |
| ADA097 | Offset Grid Drain Covers | 041193000897 | 10 |
| ADA098 | Two Supply Line and Valve Covers (2 each) | 041193000880 | 10 |
| ADA099 | Universal Plastic & Brass P-Trap and Straight Grid Drain Cover Kit | 041193000873 | 10 |
| ADA100 | Universal P-Trap Full Cover Kit, Offset Grid Drain, Two Supply Line and Valve Covers | 041193000859 | 10 |
| ADA101 | Universal P-Trap Full Cover Kit. Straight Grid Drain. Two Supply Lines and Valve Covers | 041193000866 | 10 |
| ADA103 | Schedule 40 P-Trap and Straight Grid Drain Cover Kit | 041193000743 | 10 |
| ADA104 | Schedule 40 P-Trap Full Cover Kit, Single Supply Line and Valve Cover | 041193000828 | 10 |
| ADA105 | Schedule 40 P-Trap Full Cover Kit, Two Supply Line & Valve Cover | 041193000835 | 10 |
| ADA106 | Universal Plastic and Brass Offset Waste Arm Cover Kit | 041193000958 | 10 |
| ADA107 | Universal Plastic and Brass Center and End Outlet Waste Cover Kit | 041193000965 | 10 |
| ADA108 | Universal Plastic and Sink Trap (Mass Code) and Straight Grid Drain Cover Kit | 041193000972 | 10 |
| ADA110 | Universal P-Trap Full Cover Kit Straight Grid Drain, Single Supply Line and Valve Cover | 041193001047 | 10 |

BRASS GRAB BARS



Dearborn® Grab Bars with Concealed Flanges, Peened Finish

| Product No. | Size | Description | UPC | Ctn. Qty. |
|-------------|--------------|--|--------------|-----------|
| DB8712P | 1-1/4" x 12" | Stainless Steel Grab Bar w/Concealed Flange, Peened Finish | 041193013538 | 4 |
| DB8716P | 1-1/4" x 16" | Stainless Steel Grab Bar w/Concealed Flange, Peened Finish | 041193013545 | 4 |
| DB8736P | 1-1/4" x 36" | Stainless Steel Grab Bar w/Concealed Flange, Peened Finish | 041193013637 | 4 |
| DB8924P | 1-1/2" x 24" | Stainless Steel Grab Bar w/Concealed Flange, Peened Finish | 041193013798 | 4 |
| DB8936P | 1-1/2" x 36" | Stainless Steel Grab Bar w/Concealed Flange, Peened Finish | 041193013828 | 4 |
| DB8948P | 1-1/2" x 48" | Stainless Steel Grab Bar w/Concealed Flange, Peened Finish | 041193013859 | 4 |



Dearborn® Grab Bars with Concealed Flanges, Satin Finish

| Product No. | Size | Description | UPC | Ctn. Qty. |
|-------------|--------------|--|--------------|-----------|
| DB8712 | 1-1/4" x 12" | Stainless Steel Grab Bar w/ Concealed Flange, Satin Finish | 041193008732 | 4 |
| DB8718 | 1-1/4" x 18" | Stainless Steel Grab Bar w/ Concealed Flange, Satin Finish | 041193008800 | 4 |
| DB8724 | 1-1/4" x 24" | Stainless Steel Grab Bar w/ Concealed Flange, Satin Finish | 041193008862 | 4 |
| DB8736 | 1-1/4" x 36" | Stainless Steel Grab Bar w/ Concealed Flange, Satin Finish | 041193008947 | 4 |
| DB8742 | 1-1/4" x 42" | Stainless Steel Grab Bar w/ Concealed Flange, Satin Finish | 041193008954 | 4 |
| DB8912 | 1-1/2" x 12" | Stainless Steel Grab Bar w/ Concealed Flange, Satin Finish | 041193009005 | 4 |
| DB8918 | 1-1/2" x 18" | Stainless Steel Grab Bar w/ Concealed Flange, Satin Finish | 041193009029 | 4 |
| DB8924 | 1-1/2" x 24" | Stainless Steel Grab Bar w/ Concealed Flange, Satin Finish | 041193009043 | 4 |
| DB8936 | 1-1/2" x 36" | Stainless Steel Grab Bar w/ Concealed Flange, Satin Finish | 041193009128 | 4 |
| DB8942 | 1-1/2" x 42" | Stainless Steel Grab Bar w/ Concealed Flange, Satin Finish | 041193009135 | 4 |
| DB8948 | 1-1/2" x 48" | Stainless Steel Grab Bar w/ Concealed Flange, Satin Finish | 041193009142 | 4 |



Category 16

Bath Waste and Overflow

True Blue was thoughtfully designed for pros with a variety of cutting-edge features, like integrated locking components that simplify installation, and quarter-turn test plugs that make testing quick and painless.



#F16P9860CP shown



#F16P9860CPD shown

Dearborn® True Blue™ Full Kit

| Product No. | Description | UPC | Ctn. Qty |
|-------------|---|--------------|----------|
| PVC | | | |
| P9850CP | True Blue PVC Full Kit, Touch Toe Stopper, w/ Test Kit CHR | 041193104908 | 10 |
| P9850BNPS | True Blue PVC Full Kit, Touch Toe Stopper, w/ Test Kit BN | 041193104915 | 10 |
| P9850RBPS | True Blue PVC Full Kit, Touch Toe Stopper, w/ Test Kit ORB | 041193104922 | 10 |
| P9840BNPS | True Blue PVC Full Kit, Push & Pull Stopper w/ Test Kit BN | 041193462220 | 10 |
| P9840RBPS | True Blue PVC Full Kit, Push & Pull Stopper w/ Test Kit ORB | 041193462244 | 10 |
| P9860CP | True Blue PVC Full Kit, Uni-Lift Stopper, w/ Test Kit CHR | 041193104939 | 10 |
| P9860BNPS | True Blue PVC Full Kit, Uni-Lift Stopper, w/ Test Kit BN | 041193104946 | 10 |
| P9860RBPS | True Blue PVC Full Kit, Uni-Lift Stopper, w/ Test Kit ORB | 041193104953 | 10 |

| | | | |
|------------|---|--------------|----|
| ABS | | | |
| A9850CP | True Blue ABS Full Kit, Touch Toe Stopper, w/ Test Kit CHR | 041193104847 | 10 |
| A9850BNPS | True Blue ABS Full Kit, Touch Toe Stopper, w/ Test Kit BN | 041193104854 | 10 |
| A9850RBPS | True Blue ABS Full Kit, Touch Toe Stopper, w/ Test Kit ORB | 041193104861 | 10 |
| A9840BNPS | True Blue ABS Full Kit, Push & Pull Stopper w/ Test Kit BN | 041193462107 | 10 |
| A9840RBPS | True Blue ABS Full Kit, Push & Pull Stopper w/ Test Kit ORB | 041193462121 | 10 |
| A9860CP | True Blue ABS Full Kit, Uni-Lift Stopper, w/ Test Kit CHR | 041193104878 | 10 |
| A9860BNPS | True Blue ABS Full Kit, Uni-Lift Stopper, w/ Test Kit BN | 041193104885 | 10 |
| A9860RBPS | True Blue ABS Full Kit, Uni-Lift Stopper, w/ Test Kit ORB | 041193104892 | 10 |

Dearborn® True Blue™ Flexible Neck Bathwaste Kit - Full

| Product No. | Description | UPC | Ctn. Qty |
|-------------|--|--------------|----------|
| F16P9850CP | 16" True Blue FLEX PVC Full Kit, Touch Toe Stopper, w/ Test, CHR | 041193462923 | 10 |
| F16P9850BN | 16" True Blue FLEX PVC Full Kit, Touch Toe Stopper, w/ Test, BN | 041193462930 | 10 |
| F16P9850RB | 16" True Blue FLEX PVC Full Kit, Touch Toe Stopper, w/ Test, ORB | 041193462947 | 10 |
| F16P9850CPD | 16" True Blue FLEX PVC Full Kit, Touch Toe Stopper, w/ Test, CHR, Direct Drain | 041193463104 | 10 |
| F16P9850CPZ | 16" True Blue FLEX PVC Full Kit, Touch Toe Stopper, w/ Test, CHR, Zinc | 041193462954 | 10 |
| F24P9850CP | 24" True Blue FLEX PVC Full Kit, Touch Toe Stopper, w/ Test, CHR | 041193463036 | 10 |
| F24P9850BN | 24" True Blue FLEX PVC Full Kit, Touch Toe Stopper, w/ Test, BN | 041193463043 | 10 |
| F24P9850RB | 24" True Blue FLEX PVC Full Kit, Touch Toe Stopper, w/ Test, ORB | 041193463050 | 10 |
| F16P9860CP | 16" True Blue FLEX PVC Full Kit, Uni-Lift Stopper, w/ Test, CHR | 041193462886 | 10 |
| F16P9860BN | 16" True Blue FLEX PVC Full Kit, Uni-Lift Stopper, w/ Test, BN | 041193462893 | 10 |
| F16P9860RB | 16" True Blue FLEX PVC Full Kit, Uni-Lift Stopper, w/ Test, ORB | 041193462909 | 10 |
| F16P9860CPD | 16" True Blue FLEX PVC Full Kit, Uni-Lift Stopper, w/ Test, CHR, Direct Drain | 041193463098 | 10 |
| F16P9860CPZ | 16" True Blue FLEX PVC Full Kit, Uni-Lift Stopper, w/ Test, CHR, Zinc | 041193462916 | 10 |
| F24P9860CP | 24" True Blue FLEX PVC Full Kit, Uni-Lift Stopper, w/ Test, CHR | 041193463005 | 10 |
| F24P9860BN | 24" True Blue FLEX PVC Full Kit, Uni-Lift Stopper, w/ Test, BN | 041193463012 | 10 |
| F24P9860RB | 24" True Blue FLEX PVC Full Kit, Uni-Lift Stopper, w/ Test, ORB | 041193463029 | 10 |

BATH WASTE AND OVERFLOW

Dearborn® True Blue™ Half Kit

| Product No. | Description | UPC | Ctn. Qty |
|-------------|-------------|-----|----------|
|-------------|-------------|-----|----------|

PVC

| | | | |
|-----------|--|--------------|----|
| P9950 | True Blue PVC Half Kit, Touch Toe Stopper, no Test Kit, CHR | 041193105042 | 10 |
| P9950CP | True Blue PVC Half Kit, Touch Toe Stopper, w/ Test Kit, CHR | 041193105059 | 10 |
| P9950BNPS | True Blue PVC Half Kit, Touch Toe Stopper, w/ Test Kit, BN | 041193105066 | 10 |
| P9950RBPS | True Blue PVC Half Kit, Touch Toe Stopper, w/ Test Kit, ORB | 041193105073 | 10 |
| P9950RB | True Blue PVC Half Kit, Touch Toe Stopper, w/ Test Kit, ORB | 041193105073 | 10 |
| P9950WHPS | True Blue PVC Half Kit, Touch Toe Stopper, w/ Test Kit, WH | 041193343314 | 10 |
| P9950MBPS | True Blue PVC Half Kit, Touch Toe Stopper, w/ Test Kit, MB | 041193462725 | 10 |
| P9940BNPS | True Blue PVC Half Kit, Push & Pull Stopper, w/ Test Kit, BN | 041193462589 | 10 |
| P9940RBPS | True Blue PVC Half Kit, Push & Pull Stopper, w/ Test Kit, ORB | 041193462602 | 10 |
| P9940WHPS | True Blue PVC Half Kit, Push & Pull Stopper, w/ Test Kit, WH | 041193462626 | 10 |
| P9940MBPS | True Blue PVC Half Kit, Push & Pull Stopper, w/ Test Kit, MB | 041193462640 | 10 |
| P9960 | True Blue PVC Half Kit, Uni-Lift Stopper, no Test Kit, CHR | 041193105080 | 10 |
| P9960CP | True Blue PVC Half Kit, Uni-Lift Stopper, w/ Test Kit, CHR | 041193105097 | 10 |
| P9960CPC | True Blue PVC Half Kit, Uni-Lift Stopper, w/ Test Kit, CHR, Condensate Elbow | 041193105332 | 10 |
| P9960CPD | True Blue PVC Half Kit, Uni-Lift Stopper, w/ Test Kit, CHR, Direct Drain | 041193105356 | 10 |
| P9960BNPS | True Blue PVC Half Kit, Uni-Lift Stopper, w/ Test Kit, BN | 041193105103 | 10 |
| P9960RBPS | True Blue PVC Half Kit, Uni-Lift Stopper, w/ Test Kit, ORB | 041193105110 | 10 |
| P9960CPZ | True Blue PVC Half Kit, Uni-Lift Stopper, w/ Test Kit, Zinc CHR | 041193105233 | 10 |
| P9960WHPS | True Blue PVC Half Kit, Uni-Lift Stopper, w/ Test Kit, WH | 041193343338 | 10 |
| P9960MBPS | True Blue PVC Half Kit, Uni-Lift Stopper, w/ Test Kit, MB | 041193343345 | 10 |

ABS

| | | | |
|-----------|--|--------------|----|
| A9950 | True Blue ABS Half Kit, Touch Toe Stopper, no Test Kit, CHR | 041193104960 | 10 |
| A9950CP | True Blue ABS Half Kit, Touch Toe Stopper, w/ Test Kit, CHR | 041193104977 | 10 |
| A9950BNPS | True Blue ABS Half Kit, Touch Toe Stopper, w/ Test Kit, BN | 041193104984 | 10 |
| A9950RBPS | True Blue ABS Half Kit, Touch Toe Stopper, w/ Test Kit, ORB | 041193104991 | 10 |
| A9950WHPS | True Blue ABS Half Kit, Touch Toe Stopper, w/ Test Kit, WH | 041193343215 | 10 |
| A9950MBPS | True Blue ABS Half Kit, Touch Toe Stopper, w/ Test Kit, MB | 041193343222 | 10 |
| A9940BNPS | True Blue ABS Half Kit, Push & Pull Stopper, w/ Test Kit, BN | 041193462343 | 10 |
| A9940RBPS | True Blue ABS Half Kit, Push & Pull Stopper, w/ Test Kit, ORB | 041193462367 | 10 |
| A9940WHPS | True Blue ABS Half Kit, Push & Pull Stopper, w/ Test Kit, WH | 041193462381 | 10 |
| A9940MBPS | True Blue ABS Half Kit, Push & Pull Stopper, w/ Test Kit, MB | 041193462404 | 10 |
| A9960 | True Blue ABS Half Kit, Uni-Lift Stopper, no Test Kit CHR | 041193105004 | 10 |
| A9960CP | True Blue ABS Half Kit, Uni-Lift Stopper, w/ Test Kit CHR | 041193105011 | 10 |
| A9960CPC | True Blue ABS Half Kit, Uni-Lift Stopper, w/ Test Kit, CHR, Condensate Elbow | 041193105325 | 10 |
| A9960CPD | True Blue ABS Half Kit, Uni-Lift Stopper, w/ Test Kit, CHR, Direct Drain | 041193105349 | 10 |
| A9960BNPS | True Blue ABS Half Kit, Uni-Lift Stopper, w/ Test Kit BN | 041193105028 | 10 |
| A9960RBPS | True Blue ABS Half Kit, Uni-Lift Stopper, w/ Test Kit ORB | 041193105035 | 10 |
| A9960CPZ | True Blue ABS Half Kit, Uni-Lift Stopper, w/ Test Kit Zinc CHR | 041193105226 | 10 |
| A9960WHPS | True Blue ABS Half Kit, Uni-Lift Stopper, w/ Test Kit WH | 041193343239 | 10 |
| A9960MBPS | True Blue ABS Half Kit, Uni-Lift Stopper, w/ Test Kit Zinc MB | 041193343246 | 10 |



#P9960CP
shown



#A9950CP
shown

CATEGORY 16 BATH WASTE AND OVERFLOW



#P9975 shown



#A9975 shown



#F16P9975 shown

Dearborn® True Blue™ Rough Kit

| Product No. | Description | UPC | Ctn. Qty |
|-------------|---|--------------|----------|
| PVC | | | |
| P9970 | True Blue PVC Rough Kit, No Test Kit, CHR | 041193105141 | 10 |
| P9975 | True Blue PVC Rough Kit, w/ Test Kit, CHR | 041193105158 | 10 |
| P9975Z | True Blue PVC Rough Kit, w/ Test Kit, Zinc CHR | 041193105257 | 10 |
| P9975C | True Blue PVC Rough Kit, w/ Test Kit, CHR, Zinc, Condensate Elbow | 041193105264 | 10 |
| P9975C | True Blue PVC Rough Kit, w/ Test Kit, CHR, Zinc Condensate Elbow | 041193105288 | 10 |
| P9975D | True Blue PVC Rough Kit, w/ Test Kit, CHR, Direct Drain | 041193105295 | 10 |
| P9975ZD | True Blue PVC Rough Kit, w/ Test Kit, CHR, Zinc, Direct Drain | 041193105318 | 10 |
| ABS | | | |
| A9970 | True Blue ABS Rough Kit, No Test Kit, CHR | 041193105127 | 10 |
| A9975 | True Blue ABS Rough Kit, w/ Test Kit, CHR | 041193105134 | 10 |
| A9975Z | True Blue ABS Rough Kit, w/ Test Kit, Zinc CHR | 041193105240 | 10 |
| A9975C | True Blue ABS Rough Kit, w/ Test Kit, CHR, Condensate Elbow | 041193105271 | 10 |
| A9975D | True Blue ABS Rough Kit, w/ Test Kit, CHR, Direct Drain | 041193105301 | 10 |

Dearborn® True Blue™ Flexible Neck Bathwaste Kits - Rough

| Product No. | Description | UPC | Ctn. Qty |
|-------------|---|--------------|----------|
| F16P9975 | 16" True Blue FLEX PVC Rough Kit w/ Test, CHR | 041193463128 | 10 |
| F24P9975 | 24" True Blue FLEX PVC Rough Kit w/ Test, CHR | 041193463135 | 10 |
| F16P9975Z | 16" True Blue FLEX PVC Rough Kit w/ Test, CHR, Zinc | 041193463142 | 10 |
| F24P9975Z | 24" True Blue FLEX PVC Rough Kit w/ Test, CHR, Zinc | 041193463159 | 10 |
| F16P9975D | 16" True Blue FLEX PVC Rough Kit w/ Test, CHR, Direct Drain | 041193463166 | 10 |
| F24P9975D | 24" True Blue FLEX PVC Rough Kit w/ Test, CHR, Direct Drain | 041193463173 | 10 |
| F16P9975ZD | 16" True Blue FLEX PVC Rough Kit w/ Test, CHR, Direct Drain, Zinc | 041193463180 | 10 |
| F24P9975ZD | 24" True Blue FLEX PVC Rough Kit w/ Test, CHR, Direct Drain, Zinc | 041193463197 | 10 |
| F25P9975D | 25" True Blue FLEX PVC Rough Kit w/Test, CHR, Direct Drain | 041193463203 | 10 |



#K97BN shown

Dearborn® True Blue™ Touch Toe Trim Kit

| Product No. | Description | UPC | Ctn. Qty |
|-------------|--|--------------|----------|
| K97CP | True Blue Trim Kit, Touch Toe, CHR, No Veneer Included | 041193105165 | 10 |
| K97BN | True Blue Trim Kit, Touch Toe, BN | 041193105172 | 10 |
| K97RB | True Blue Trim Kit, Touch Toe, ORB | 041193105189 | 10 |
| K97WH | True Blue Trim Kit, Touch Toe, WH | 041193343413 | 10 |
| K97MB | True Blue Trim Kit, Touch Toe, MB | 041193343420 | 10 |



#K98CP shown

Dearborn® True Blue™ Uni-Lift Trim Kit

| Product No. | Description | UPC | Ctn. Qty |
|-------------|---|--------------|----------|
| K98CP | True Blue Trim Kit, Uni-Lift, CHR, No Veneer Included | 041193105196 | 10 |
| K98BN | True Blue Trim Kit, Uni-Lift, BN | 041193105202 | 10 |
| K98RB | True Blue Trim Kit, Uni-Lift, ORB | 041193105219 | 10 |
| K98WH | True Blue Trim Kit, Uni-Lift, WH | 041193343437 | 10 |
| K98MB | True Blue Trim Kit, Uni-Lift, MB | 041193343444 | 10 |



#4516-1 shown



4516-3 shown



#4516-4 shown



#4516-6 shown



#4516-10 shown

Dearborn® True Blue™ Replacement Parts

| Product No. | Description | UPC | Ctn. Qty. |
|-------------|---------------------------------------|--------------|----------------------|
| 4516-1 | True Blue Brass Drain Spud | 041193115874 | 10 |
| 4516-2 | True Blue Drain Elbow Gasket | 041193115805 | 100 (10 per bag) |
| 4516-3 | True Blue Overflow Washer | 041193115423 | 120 (20 per bag) |
| 4516-4 | True Blue Drain & Overflow Test Plugs | 041193115867 | 100 (5 each per bag) |
| 4516-5 | True Blue Zinc Drain Spud | 041193115850 | 10 |
| 4516-6 | True Blue Trim Veneer, BN | 041193115843 | 10 |
| 4516-7 | True Blue Trim Veneer, ORB | 041193115836 | 10 |
| 4516-8 | True Blue Overflow Faceplate, BN | 041193115829 | 10 |
| 4516-9 | True Blue Overflow Faceplate, ORB | 041193115812 | 10 |
| 4516-10 | True Blue Overflow Faceplate, CHR | 041193115881 | 10 |



#P7224B shown

Dearborn® Schedule 40 Bath Waste Touch Toe Half Kits

| Product No. | Description | UPC | Ctn. Qty. |
|-------------|---|--------------|-----------|
| P7725 | DBlue Half Kit, Schedule 40 - PVC Touch-Toe Stopper w/ Chrome Finish Trim and Test Plug | 041193006844 | 20 |
| A7725BN | DBlue Half Kit, Schedule 40 - ABS Touch-Toe Stopper w/ Brushed Nickel Finish Trim and Test Plug | 041193007162 | 20 |



#A7725B shown

Dearborn® Schedule 40 Bath Waste Uni-Lift Half Kits

| Product No. | Size | Description | UPC | Ctn. Qty. |
|-------------|------|---|--------------|-----------|
| A7225B | | DBlue Half Kit, Schedule 40 - ABS Uni-Lift Stopper w/ Chrome Finish Trim | 041193095183 | 20 |
| P7325 | | DBlue Half Kit, Schedule 40 - PVC Uni-Lift Stopper w/ Chrome Finish Trim and Test Plug | 041193006783 | 20 |
| A7325 | | DBlue Half Kit, Schedule 40 - ABS Uni-Lift Stopper w/ Chrome Finish Trim and Test Plug | 041193006820 | 20 |
| A7325RB | | DBlue Half Kit, Schedule 40 - ABS Uni-Lift Stopper w/ Oil Rubbed Bronze Finish Trim And Test Plug | 041193006899 | 20 |
| A7325BN | | DBlue Half Kit, Schedule 40 - ABS Uni-Lift Stopper w/ Brushed Nickel Finish Trim And Test Plug | 041193007056 | 20 |
| A7325BZ | | DBlue Half Kit, Schedule 40 - ABS Uni-Lift Stopper w/ Chrome Finish Trim w/ Zinc Spud and Test Plug | 041193732545 | 20 |



#P7223RK shown

Dearborn® Schedule 40 Bath Waste Rough-In Kits

| Product No. | Size | Description | UPC | Ctn. Qty. |
|-------------|------|---------------------------------------|--------------|-----------|
| A7223RK | | DBlue Rough-In Kit, Schedule 40 - ABS | 041193016652 | 30 |



Dearborn® Schedule 40 Bath Waste Quarter Kit

| Product No. | Size | Description | UPC | Ctn. Qty. |
|-------------|------|--|--------------|-----------|
| P3225D | | DBlue Quarter Kit, Schedule 40 - PVC Uni-Lift Stopper w/ Chrome Finish Trim Direct Drain | 041193005885 | 20 |

Dearborn® Bath Waste DBlue Trim Kits - Coarse Thread



K22BN shown

| Product No. | Size | Description | UPC | Ctn. Qty. |
|-------------|------|--|--------------|-----------|
| K22TB | | DBLue Trim Kit, for Schedule 40 - Rough-In Kit Uni-Lift Stopper w/ Chrome Finish Trim | 041193006745 | 10 |
| K22BN | | DBLue Trim Kit, for Schedule 40 - Rough-In Kit Uni-Lift Stopper w/ Brushed Nickel Finish Trim | 041193007308 | 10 |
| K22WH | | DBLue Trim Kit, for Schedule 40 - Rough-In Kit Uni-Lift Stopper w/ White Finish Trim | 041193007032 | 10 |
| K23TB | | DBLue Trim Kit, for Schedule 40 - Rough-In Kit Touch-Toe Stopper w/ Chrome Finish Trim | 041193006776 | 10 |
| K23BN | | DBLue Trim Kit, for Schedule 40 - Rough-In Kit Touch-Toe Stopper w/ Brushed Nickel Finish Trim | 041193007315 | 10 |



Chrome Finish Trim Kits do not include spud

Dearborn® Bath Waste Trim Kits - Coarse Thread

| Product No. | Size | Description | UPC | Ctn. Qty. |
|-------------|------|--|--------------|-----------|
| K25TB | | DBLue Trim Kit, for Schedule 40 - Rough-In Kit Uni-Lift Stopper w/ Chrome Finish Trim, Plug Only | 041193026330 | 10 |



Dearborn® Cable Bath Waste Conversion Kit

| Product No. | Size | Description | UPC | Ctn. Qty. |
|-------------|------|--|--------------|-----------|
| K20 | | DBLue Conversion Kit, Cable Stopper w/Chrome Finish Trim | 041193026149 | 2 |



Dearborn® Bath Waste Conversion Kits

| Product No. | Size | Description | UPC | Ctn. Qty. |
|-------------|------|---|--------------|-----------|
| K27 | | DBLue Conversion Kit, Uni-Lift Stopper w/ Chrome Finish Trim | 041193026477 | 2 |
| K27BN | | DBLue Conversion Kit, Uni-Lift Stopper w/ Brushed Nickel Finish Trim | 041193026545 | 2 |
| K27PB | | DBLue Conversion Kit, Uni-Lift Stopper w/ UltraShine® Polished Brass Finish Trim | 041193026484 | 2 |
| K27RB | | DBLue Conversion Kit, Uni-Lift Stopper w/ Rubbed Bronze Finish Trim | 041193026521 | 2 |
| K27SC | | DBLue Conversion Kit, Uni-Lift Stopper w/ UltraShine® Satin Chrome Finish Trim | 041193026538 | 2 |
| K27SN | | DBLue Conversion Kit, Uni-Lift Stopper w/ UltraShine® Satin Nickel Finish Trim | 041193026514 | 2 |
| K28BN | | Conversion Kit, w/ Two-Hole Cover Plate, Uni-Lift Stopper w/ Brushed Nickel Finish Trim | 041193004253 | 2 |



Category 17

Strainers

Dearborn® Brass offers the widest variety of Basket and Sink Strainers in the industry. These include Standard and Economy; Locking Cup; Easy Mount; Threaded Body and Bar Sink Strainers. Available in chrome plated brass, stainless steel and decorative plastic materials.



Dearborn® Rubber Neck Escutcheon

- Fits comfortably 1/2" and 3/4" pipe.
- Durable material that is non-corrosive and mold resistant.
- Hide blemishes from your customer and add a layer of protection against critters from entering the structure.

| Product No. | Size | Description | UPC | Ctn. Qty. |
|-------------|------------|------------------------|--------------|-----------|
| 1101R | 1/2 – 3/4" | Rubber Neck Escutcheon | 041193007179 | 25 |



Dearborn® Chrome Plated Plastic Sleeve

| Product No. | Size | Description | UPC | Ctn. Qty. |
|-------------|------|---|--------------|-----------|
| 1119 | 1/2" | Chrome Plated Plastic Sleeve (4 in Bag) | 041193007186 | 25 Bags |



Dearborn® Shallow Locking Cup Sink Basket Strainer

- Shallow Locking Cup Sink Basket Strainer is ideal for use on deep cast iron sinks. Features a stainless steel body and basket.
- Locking cup included.
- 4" Chrome plated stainless steel tailpiece. Neoprene rubber stopper.

| Product No. | Size | Description | UPC | Ctn. Qty. |
|-------------|--------|---|--------------|-----------|
| 14T | 2-3/4" | Shallow Cup Basket Strainer, Stainless Steel Body | 041193102140 | 24 |



Dearborn® Spin-N-Lock Sink Basket Strainer

- Ideal for a 4" commercial sink drain.
- Extra thick washer and wide locknut.
- Heavy duty stainless steel body and basket.

| Product No. | Size | Description | UPC | Ctn. Qty. |
|-------------|------|---|--------------|-----------|
| 17 | | Spin-N-Lock Sink Basket Strainer, Stainless Steel Body w/ Stainless Steel Screw-In Basket | 041193050823 | 24 |



Category 18

Pneumatic Pipe Plugs

Cherne® pneumatic Test-Ball® and Muni-Ball® pipe plugs have been the contractor's choice for more than 60 years. Used in residential DWV systems and sanitary/storm sewers, Cherne® pneumatic pipe plugs do it all! Larger sizes are available with our patented Rupture Disc Technology, which prevents over-inflation. This eliminates plug damage due to over-inflation and enhances user safety.

THE GLOBAL LEADER IN PIPE PLUG & TESTING



Cherne Industries recently completed an historic move into a newly constructed, 130,000-square-foot facility located in Shakopee, MN. Situated 25 miles southwest of downtown Minneapolis, this state-of-the-art facility features integrated robotic manufacturing with a new R&D lab for product testing, and extensive customer training facilities. The move to Shakopee also taps into a wide cross-section of skilled technical personnel. The new building fortifies Cherne's capabilities as a world-class, industry-leading solution for our end users.



test with the best

CATEGORY **18** PNEUMATIC PIPE PLUGS



Cherne® Single-Size Test-Ball® Plugs (Plumbing)

Designed to test DWV systems, Cherne Test-Ball® plugs can be used in any type of pipe.

- Made of natural rubber for excellent expansion and memory.
- Seals both round and out-of-round pipe.
- Zinc-plated steel chain and ring handle acts as an anchor to prevent plug from sliding down a line.
- Fits easily through test tees, sanitary tees, floor drains, and other “tight” situations.
- Broader expansion range than mechanical plugs.

| Product No. | Size | Description | Ctn. Qty. | Back Pressure P.S.I. | Feet of Head |
|-------------|---------------|-----------------|-----------|----------------------|--------------|
| 270008 | 3/4"-1-1/4" | Test-Ball® Plug | 6 | 17 PSI | 40 FT |
| 270016 | 1-1/4"-1-1/2" | Test-Ball® Plug | 6 | 13 PSI | 30 FT |
| 270024 | 2" | Test-Ball® Plug | 6 | 13 PSI | 30 FT |
| 270108 | 2-1/2" | Test-Ball® Plug | 6 | 13 PSI | 30 FT |
| 270032 | 3" | Test-Ball® Plug | 6 | 13 PSI | 30 FT |
| 270040 | 4" | Test-Ball® Plug | 6 | 13 PSI | 30 FT |
| 270059 | 5" | Test-Ball® Plug | 1 | 13 PSI | 30 FT |
| 270067 | 6" | Test-Ball® Plug | 1 | 13 PSI | 30 FT |



#240028 Bulk Pack shown



#240018 shown

Cherne® Bulk Test-Ball® Plugs – Individual Display Bags*

- Same great Test-Ball® plug in bulk packaging.
- Preprinted bag designed for use with peg hook displays.

* Bulk Test-Ball® Plugs MUST be ordered in quantities of 24 plugs.

| Product No. | Size | Description | Ctn. Qty. | Back Pressure P.S.I. | Feet of Head |
|-------------|---------------|-----------------|-----------|----------------------|--------------|
| 240018 | 1-1/4"-1-1/2" | Test-Ball® Plug | 24 | 13 PSI | 30 FT |
| 240028 | 2" | Test-Ball® Plug | 24 | 13 PSI | 30 FT |
| 240038 | 3" | Test-Ball® Plug | 24 | 13 PSI | 30 FT |
| 240048 | 4" | Test-Ball® Plug | 24 | 13 PSI | 30 FT |



Cherne® Multi-Size Test-Ball® Plugs (Plumbing)

The multi-size yellow-top Test-Ball(R) plugs have the same great features as the original and are ideal for multiple pipe sizes.

- One size fits multiple pipe diameters, doing the job of 2+ single-size plugs.
- Use to block flow (water DWV test) or as a back plug for sewer air testing.
- Seals both round and out-of-round pipe.
- Zinc-plated steel chain and ring handle acts as an anchor to prevent plug from sliding down a line.

| Product No. | Size | Description | Ctn. Qty. | Back Pressure P.S.I. | Feet of Head |
|-------------|-----------|-----------------|-----------|----------------------|--------------|
| 276128 | 1-1/4"-2" | Test-Ball® Plug | 6 | 17 PSI | 40 FT |
| 276238 | 2"- 3" | Test-Ball® Plug | 6 | 17 PSI | 40 FT |
| 276348 | 3"- 4" | Test-Ball® Plug | 6 | 17 PSI | 40 FT |
| 276468 | 4"- 6" | Test-Ball® Plug | 1 | 17 PSI | 40 FT |



#271047 shown

Cherne® Long Test-Ball® Plugs

- Designed for waste stack testing from floor drain to sewer pipe.
- Long enough to seal wye vertical riser and sewer run.
- Includes 3' extension hose.
- Ring and chain assembly prevents plug from sliding down a line.

| Product No. | Size | Description | Ctn. Qty. | Back Pressure P.S.I. | Feet of Head |
|-------------|---------|----------------------|-----------|----------------------|--------------|
| 271020 | 2" | Long Test-Ball® Plug | 1 | 13 PSI | 30 FT |
| 271039 | 3" | Long Test-Ball® Plug | 1 | 13 PSI | 30 FT |
| 271047 | 4" | Long Test-Ball® Plug | 1 | 13 PSI | 30 FT |
| 271063 | 6" | Long Test-Ball® Plug | 1 | 13 PSI | 30 FT |
| 271098 | 4" - 6" | Long Test-Ball® Plug | 1 | 13 PSI | 30 FT |



#274526 shown

Cherne® MS2® Long Test-Ball® Plugs

Multi-size design for use in various pipe diameters.

- Designed for waste stack testing from floor drain to sewer pipe.
- Long enough to seal wye vertical riser and sewer run.
- Multi-stage deflation eliminates backsplash.
- Works in multiple pipe diameters.
- Pressure relief valve to safeguard against over-inflation.
- Nylon strap and safety handle prevents plug from sliding down a line.
- Includes 5' extension hose.

| Product No. | Size | Description | Ctn. Qty. | Back Pressure P.S.I. | Feet of Head |
|-------------|---------|-------------|-----------|----------------------|--------------|
| 274518 | 2" - 3" | MS2® Plug | 1 | 13 PSI | 30 FT |
| 274526 | 3" - 4" | MS2® Plug | 1 | 13 PSI | 30 FT |
| 274534 | 4" - 6" | MS2® Plug | 1 | 13 PSI | 30 FT |



Cherne® Clean-Seal® Plugs

Designed for stack testing of drain, waste, and vent plumbing systems.

- Threads into test tee, eliminating water backsplash.
- Removable snifter valve inflation fitting is replaceable.
- Made from long-lasting natural rubber.
- Seals both cast-iron and plastic pipe

| Product No. | Size | Description | Ctn. Qty. | Back Pressure P.S.I. | Feet of Head |
|-------------|--------|------------------|-----------|----------------------|--------------|
| 271508 | 1-1/2" | Clean-Seal® Plug | 6 | 13 PSI | 30 FT |
| 271705 | 2" | Clean-Seal® Plug | 6 | 13 PSI | 30 FT |
| 271713 | 3" | Clean-Seal® Plug | 6 | 13 PSI | 30 FT |
| 271721 | 4" | Clean-Seal® Plug | 6 | 13 PSI | 30 FT |
| 271758 | 6" | Clean-Seal® Plug | 1 | 13 PSI | 30 FT |



#262010 shown

Cherne® Single-Size Original Muni-Ball® Plugs

Muni-Ball® plugs offer a full bypass allowing both testing and monitoring of pipe systems. Ideal for installation and repair of residential, commercial, or municipal infrastructure including sanitary and storm sewer systems.

- Works in all types of pipe.
- Easily converts to an air test plug with use of a conversion kit.
- Durable natural rubber construction seals the roughest of surfaces.
- 8", 10", 12" and 15"-16" plugs include two port plug for easy use in sewer air tests.
- Threaded aluminum bypass.

| Product No. | Size | Description | Ctn. Qty. | Back Pressure P.S.I. | Feet of Head |
|-------------|---------|---------------------------------|-----------|----------------------|--------------|
| 262008 | 1-1/2" | Muni-Ball® Plug - 1/4" Bypass | 1 | 22 PSI | 50 FT |
| 262010 | 2" | Muni-Ball® Plug - 1/8" Bypass | 1 | 22 PSI | 50 FT |
| 262258 | 3" | Muni-Ball® Plug - 1/2" Bypass | 1 | 22 PSI | 50 FT |
| 262048 | 4" | Muni-Ball® Plug - 3/4" Bypass | 1 | 22 PSI | 50 FT |
| 262064 | 6" | Muni-Ball® Plug - 1-1/2" Bypass | 1 | 13 PSI | 30 FT |
| 262080 | 8" | Muni-Ball® Plug - 3" Bypass | 1 | 13 PSI | 30 FT |
| 262110 | 10" | Muni-Ball® Plug - 3" Bypass | 1 | 13 PSI | 30 FT |
| 262129 | 12" | Muni-Ball® Plug - 3" Bypass | 1 | 13 PSI | 30 FT |
| 262137 | 15"-16" | Muni-Ball® Plug - 3" Bypass | 1 | 13 PSI | 30 FT |
| 262188 | 18" | Muni-Ball® Plug - 4" Bypass | 1 | 13 PSI | 30 FT |



#262080 shown

Cherne® Multi-Size Original Muni-Ball® Plugs

- Work in all types of pipe.
- Durable natural rubber construction seals the roughest of surfaces.
- Threaded aluminum bypass.
- Easily converts to an air test plug with the use of a conversion kit.
- One plug fits multiple pipe diameters.

| Product No. | Size | Description | Ctn. Qty. | Back Pressure P.S.I. | Feet of Head |
|-------------|----------|-------------------------------|-----------|----------------------|--------------|
| 265048 | 4" - 6" | Muni-Ball® Plug 3/4" Bypass | 1 | 17 PSI | 40 FT |
| 265068 | 6" - 8" | Muni-Ball® Plug 1-1/2" Bypass | 1 | 17 PSI | 40 FT |
| 265078 | 8" - 10" | Muni-Ball® Plug 2" Bypass | 1 | 17 PSI | 40 FT |



#265068 shown

Cherne® Multi-Size Test-Ball® Plugs (Underground)

- One plug fits multiple pipe diameters.
- Made of natural rubber for excellent expansion and memory.
- Seals both round and out-of-round pipe.
- Removable inflation valve can be replaced if damaged or replaced with quick disconnect fitting.
- Use to block flow or as a back plug for sewer air testing.

| Product No. | Size | Description | Ctn. Qty. | Back Pressure P.S.I. | Feet of Head |
|-------------|----------|-----------------|-----------|----------------------|--------------|
| 275048 | 4" - 6" | Test-Ball® Plug | 1 | 17 PSI | 40 FT |
| 275058 | 6" - 8" | Test-Ball® Plug | 1 | 17 PSI | 40 FT |
| 275088 | 8" - 12" | Test-Ball® Plug | 1 | 11 PSI | 25 FT |





Cherne® Single-Size Test-Ball® Plugs (Underground)

Cherne's single and multi-size test-ball® plugs are our most economical pneumatic plugs for blocking flow to do maintenance in sanitary and storm sewer systems.

- Designed to block sewer flow or for use as a back plug for sewer air testing.
- Natural rubber material for excellent expansion and memory.
- Seals both round and out-of-round pipe.
- Removable inflation valve can be replaced if damaged or replaced with quick disconnect fitting.
- Features an eye-bolt for use with a poly-lift line.

| Product No. | Size | Description | Ctn. Qty. | Back Pressure P.S.I. | Feet of Head |
|-------------|---------|-----------------|-----------|----------------------|--------------|
| 041386 | 8" | Test-Ball® Plug | 1 | 17 PSI | 40 FT |
| 041394 | 10" | Test-Ball® Plug | 1 | 17 PSI | 40 FT |
| 041408 | 12" | Test-Ball® Plug | 1 | 17 PSI | 40 FT |
| 041416 | 15"-16" | Test-Ball® Plug | 1 | 13 PSI | 30 FT |



Cherne® AIR-LOC® PLUG

- Industry leading quality, consistency and durability
- Mechanical bonding of premium natural rubber and end plates eliminates failures from chemical bonding
- Improved performance and safety through optimized design
- Superior back pressure (15 psi, 1 bar)
- Premium aesthetics and performance
- Industry first Pressure Relieve Valve engineered specifically for pipe plugs (12"–18" and larger diameter plugs)
- Lightweight, short and flexible

| Product No. | Size | Usage Range | Max Back Pressure | Inflation Pressure | Weight (lbs) | Length (in) |
|-------------|--------|--------------|-------------------|--------------------|--------------|-------------|
| 317128 | 6-12" | 5.5-12.25" | 15 PSI (1 Bar) | 45 PSI (3 Bar) | 8 | 25 |
| 217128 | 8-12" | 7-12.25" | 15 PSI (1 Bar) | 45 PSI (3 Bar) | 10.4 | 18.5 |
| 217188 | 12-18" | 10.75-18.75" | 15 PSI (1 Bar) | 45 PSI (3 Bar) | 23 | 25 |



Cherne® REMO® PLUG

- Industry leading quality, consistency and durability
- Mechanical bonding of premium natural rubber and end plates eliminates failures from chemical bonding
- Improved performance and safety through optimized design
- Superior back pressure (15 psi, 1 bar)
- Premium aesthetics and performance
- Industry first Pressure Relieve Valve engineered specifically for pipe plugs (12"–18" and larger diameter plugs)
- Lightweight, short and flexible

| Product No. | Size | Usage Range | Max Back Pressure | Inflation Pressure | Weight (lbs) | Length (in) |
|-------------|--------|--------------|-------------------|--------------------|--------------|-------------|
| 319128 | 6-12" | 5.5-12.25" | 15 PSI (1 Bar) | 45 PSI (3 Bar) | 8.5 | 25 |
| 219128 | 8-12" | 7-12.25" | 15 PSI (1 Bar) | 45 PSI (3 Bar) | 11 | 18.5 |
| 219188 | 12-18" | 10.75-18.75" | 15 PSI (1 Bar) | 45 PSI (3 Bar) | 25 | 25 |



Cherne® Multi-Size High Pressure Plugs

Cherne's multi-size high pressure plugs are ideal for use in force mains, water mains, industrial lines, or sealing the host pipe up to 150 psi back pressure.

- Multi size use (6 plugs will cover pipe sizes from 4" to 32")
- Unlike single sized products, Cherne's new HP plug has the rubber and metal bonded eliminating fears of separation or rolling off resulting from high backpressures
- Aramid fiber construction
- Optimized design using steel, aramid and natural rubber to ensure longevity and robust construction
- High pressure plugs are designed to be pressurized with water for maximum safety
- Removable and field repairable hardware. Safety/Over-inflation device
- Made in USA

| Product No. | Size | Description | Ctn. Qty. | Back Pressure P.S.I. |
|-------------|--------|---------------------------------------|-----------|----------------------|
| 511088 | 4-8" | High Pressure Plug with 3/8" bypass | 1 | 150 |
| 511128 | 8-12" | High Pressure Plug with 1-1/2" bypass | 1 | 150 |
| 512168 | 12-16" | High Pressure Plug with 2" bypass | 1 | 150 |
| 512208 | 16-20" | High Pressure Plug with 2" bypass | 1 | 150 |
| 512268 | 20-26" | High Pressure Plug with 2" bypass | 1 | 150 |
| 512328 | 26-32" | High Pressure Plug with 2" bypass | 1 | 150 |

WARNING: This product is only designed for use in water and wastewater applications. If it comes into contact with oil, gas, petroleum, or certain other chemicals, it may rupture, resulting in bodily injury, death, and/or property damage. If there is any question about whether the product is appropriate for your intended application, call Cherne at (800) 843-7584 before using.



Cherne® I-Series® Plugs

Cherne's I-Series plugs were designed to meet the needs of both the US and International markets in terms of size and expansion range. Our I-Series plugs have full body cording for added durability.

- Super expansion ranges.
- Small deflated diameters. Plugs through 24"-60" size easily fit through a 24" manhole frame. 48"-72" and 54"-96" plugs fit through 36" openings.
- Bypass opening ranges from 3/4" to 8" diameters.
- Flexible bypass hoses - plugs can bend 90 degrees.
- Protective sleeves available for 12"-24" and plugs 15"-32" and larger.
- Aluminum end plates - minimize corrosion.
- 3/4" eyebolts for improved holding strength.
- Field replaceable rupture disc protect against over inflation.



| Product No. | Size | Description | Ctn. Qty. |
|-------------|--------|--------------------------------|-----------|
| 310088 | 4-8" | Test Ball® plug | 1 |
| 310128 | 6-12" | Test Ball® plug | 1 |
| 310168 | 8-16" | Test Ball® plug | 1 |
| 210188 | 12-18" | Test Ball® plug | 1 |
| 310248 | 12-24" | Test Ball® plug | 1 |
| 310328 | 15-32" | Test Ball® plug | 1 |
| 310488 | 24-48" | Test Ball® plug | 1 |
| 310600 | 24-60" | Test Ball® plug | 1 |
| 310728 | 48-72" | Test Ball® plug | 1 |
| 310968 | 54-96" | Test Ball® plug | 1 |
| 311088 | 4-8" | Muni-Ball® plug w/ 3/4" Bypass | 1 |
| 311128 | 6-12" | Muni-Ball® plug w/ 1" Bypass | 1 |
| 212128 | 8-12" | Muni-Ball® plug w/ 2" Bypass | 1 |
| 312168 | 8-16" | Muni-Ball® plug w/ 2" Bypass | 1 |
| 214188 | 12-18" | Muni-Ball® plug w/ 3" Bypass | 1 |
| 312248 | 12-24" | Muni-Ball® plug w/ 3" Bypass | 1 |
| 312328 | 15-32" | Muni-Ball® plug w/ 2" Bypass | 1 |
| 314328 | 15-32" | Muni-Ball® plug w/ 4" Bypass | 1 |
| 316328 | 15-32" | Muni-Ball® plug w/ 6" Bypass | 1 |
| 312418 | 20-40" | Muni-Ball® plug w/ 2" Bypass | 1 |
| 314418 | 20-40" | Muni-Ball® plug w/ 4" Bypass | 1 |
| 316418 | 20-40" | Muni-Ball® plug w/ 6" Bypass | 1 |
| 314488 | 24-48" | Muni-Ball® plug w/ 4" Bypass | 1 |
| 316488 | 24-48" | Muni-Ball® plug w/ 6" Bypass | 1 |
| 314728 | 48-72" | Muni-Ball® plug w/ 4" Bypass | 1 |
| 316728 | 48-72" | Muni-Ball® plug w/ 6" Bypass | 1 |
| 318728 | 48-72" | Muni-Ball® plug w/ 8" Bypass | 1 |
| 314968 | 54-96" | Muni-Ball® plug w/ 4" Bypass | 1 |
| 316968 | 54-96" | Muni-Ball® plug w/ 6" Bypass | 1 |

Air Loc® plug versions also available. Consult factory.

BACK PRESSURE DATA: I-Series Plugs

| PLUG SIZE | PIPE DIAMETER | | | | | | | | | | | | | | | | | | | |
|-----------|---------------|----------|----------|----------|----------|----------|----------|----------|----------|----------|----------|----------|----------|----------|---------|---------|---------|---------|---------|---------|
| | 4" | 6" | 8" | 12" | 15" | 18" | 19.35" | 21" | 24" | 30" | 36" | 42" | 48" | 54" | 60" | 66" | 72" | 84" | 96" | |
| 4"-8" | 16.7 psi | 14.4 psi | 13.0 psi | | | | | | | | | | | | | | | | | |
| 6"-12" | | 23.6 psi | 20.9 psi | 18.2 psi | - | - | - | - | - | - | - | - | - | - | - | - | - | - | - | - |
| 8"-16" | | | 18.2 psi | 14.8 psi | 13.4 psi | - | - | - | - | - | - | - | - | - | - | - | - | - | - | - |
| 12"-24" | | | | 18.7 psi | 16.8 psi | 15.2 psi | 12.4 psi | 14.0 psi | 13.0 psi | - | - | - | - | - | - | - | - | - | - | - |
| 15"-32" | | | | | 18.6 psi | 17.6 psi | 17.2 psi | 16.6 psi | 15.4 psi | 12.2 psi | - | - | - | - | - | - | - | - | - | - |
| 20"-40" | | | | | | | | 13.6 psi | 12.5 psi | 11.2 psi | 10.2 psi | 8.7 psi | - | - | - | - | - | - | - | - |
| 24"-48" | | | | | | | | | 15.2 psi | 13.9 psi | 12.8 psi | 11.4 psi | 10.1 psi | - | - | - | - | - | - | - |
| 24"-60" | | | | | | | | | 15.6 psi | 15.2 psi | 14.8 psi | 14.0 psi | 12.6 psi | 9.6 psi | 6.0 psi | - | - | - | - | - |
| 40"-60" | | | | | | | | | | - | - | 15.0 psi | 13.0 psi | 11.0 psi | 8.7 psi | - | - | - | - | - |
| 48"-72" | | | | | | | | | | | | - | 7.2 psi | 6.8 psi | 6.4 psi | 6.2 psi | 6.0 psi | - | - | - |
| 54"-96" | | | | | | | | | | | | | | - | 7.3 psi | 7.2 psi | 6.9 psi | 6.8 psi | 6.6 psi | 6.4 psi |

Point Repair Carriers

Features

- **New expanded multi-size line** covers pipe sizes from 4"–36" diameters and lengths up to 15' (Custom lengths available).
- **Maximum pipe Contact** guides to ensure proper placement of the repair medium to minimize waste of materials and increase productivity.
- **1/4" NPT Inflation Port** with male quick disconnect for ease of connection.
- Durable, flexible natural **corded rubber**.
- **Bypass design** allows sewage bypass during repair – no need to shut down the line.
- The **flexible design** allows all units to be folded in half for transport.
- **Redesigned integrated caster wheel assembly** optimized for ease of movement along the pipe.



| Product No. | For Pipe Size / Diameter | Usage Range (w/o wheels) | Length | Inflation Pressure | Bypass Diameter | Weight (lbs.) | Deflated Diameter (Inside wheel location) | Deflated Diameter (Outside wheel location) |
|-------------|--------------------------|--------------------------|--------|--------------------|-----------------|---------------|---|--|
| 279058 | 4"-6" | 2.9" - 6.25" | 5' | 45 PSI | NA | 10 | NA | NA |
| 279108 | 4"-6" | 2.9" - 6.25" | 10' | 45 PSI | NA | 13.5 | NA | NA |
| 279158 | 4"-6" | 2.9" - 6.25" | 15' | 45 PSI | NA | 17.5 | NA | NA |
| 280058 | 6"-10" | 5" - 10.25" | 5' | 25 PSI | 2" | 22 | 5.13" | 5.6" |
| 281058 | 8"-12" | 6.48" - 12.25" | 5' | 15 PSI | 2" | 33 | 7.22" | 7.71" |
| 282158 | 12"-18" | 10.33" - 18.25" | 15' | 15 PSI | 2" | 81 | 10.68" | 12.61" |
| 283108 | 18"-24" | 16.33" - 24.25" | 10' | 15 PSI | 2" | 113 | 16.57" | 19.28" |
| 283158 | 18"-24" | 16.33" - 24.25" | 15' | 15 PSI | 2" | 138 | 16.57" | 19.28" |
| 284058 | 24"-36" | 19.3" - 36.25" | 5' | 15 PSI | 4" | 107 | 19.56" | 22.28" |
| 284108 | 24"-36" | 19.3" - 36.25" | 10' | 15 PSI | 4" | 140.5 | 19.56" | 22.28" |
| 284158 | 24"-36" | 19.3" - 36.25" | 15' | 15 PSI | 4" | 182 | 19.56" | 22.28" |



Category 19

Mechanical Pipe Plugs

Cherne® mechanical test plugs can be used in a wide variety of applications including DWV and stack testing. With a variety of end-of-pipe and in-pipe options available, it's easy to find the right mechanical test plug for the job.

MECHANICAL PIPE PLUGS



Cherne® Gripper® Mechanical Plugs

- Ideal for plumbing system tests.
- Easy to install with extra-large wing nut.
- Inside-of-Pipe Gripper Plug seals inside pipe as far as needed.
- Made with glass-reinforced ABS plastic and natural rubber O-Ring.
- End-of-pipe seals only at the end of a pipe, preventing plug from falling into stack.

| Product No. | Size | Description | Ctn. Qty. | Back Pressure P.S.I. | Feet of Head |
|-------------|--------|------------------------------|-----------|----------------------|--------------|
| 270210 | 1-1/2" | End of Pipe Gripper® Plug | 10 | 17 PSI | 40FT |
| 270229 | 2" | End of Pipe Gripper® Plug | 10 | 17 PSI | 40FT |
| 270237 | 3" | End of Pipe Gripper® Plug | 10 | 17 PSI | 40FT |
| 270245 | 4" | End of Pipe Gripper® Plug | 10 | 17 PSI | 40FT |
| 270261 | 6" | End of Pipe Gripper® Plug | 5 | 17 PSI | 40FT |
| 270270 | 8" | End of Pipe Gripper® Plug | 1 | 17 PSI | 40FT |
| 270296 | 4" | Inside of Pipe Gripper® Plug | 10 | 17 PSI | 40FT |
| 270253 | 6" | Inside of Pipe Gripper® Plug | 5 | 17 PSI | 40FT |
| 270288 | 8" | Inside of Pipe Gripper® Plug | 1 | 17 PSI | 40FT |



Cherne® Hub-Fit Gripper® Plugs

- Ideal for use in hub fittings and in bell-end pipe.
- Pressure rated for conducting DWV tests.
- Yellow color enhances visibility in pipe.
- Made with glass-reinforced ABS plastic and natural rubber O-ring.

| Product No. | Size | Description | Ctn. Qty. | Back Pressure P.S.I. | Feet of Head |
|-------------|------|-----------------------|-----------|----------------------|--------------|
| 270528 | 2" | Hub-Fit Gripper® Plug | 10 | 13 PSI | 30FT |
| 270538 | 3" | Hub-Fit Gripper® Plug | 10 | 13 PSI | 30FT |
| 270548 | 4" | Hub-Fit Gripper® Plug | 10 | 13 PSI | 30FT |



Cherne® Clean-Out Gripper® Plugs

- Patented threaded O-ring ensures airtight seal.
- Stainless steel hardware prevents corrosion.
- Black color blends well with cast-iron pipe.
- NPT-sized, including hard-to-find 3-1/2".
- Guaranteed to seal most damaged threads.
- Made with glass-reinforced ABS plastic and natural rubber O-ring.

| Product No. | Size | Description | Ctn. Qty. | Back Pressure P.S.I. | Feet of Head |
|-------------|--------|------------------------------------|-----------|----------------------|--------------|
| 270168 | 2" | Plug Seals 2-1/2" Threaded Opening | 10 | 17 PSI | 40FT |
| 270178 | 3" | Plug Seals 3-1/2" Threaded Opening | 10 | 17 PSI | 40FT |
| 270138 | 3-1/2" | Plug Seals 4" Threaded Opening | 10 | 17 PSI | 40FT |
| 270188 | 4" | Plug Seals 4-1/2" Threaded Opening | 10 | 17 PSI | 40FT |



Cherne® T-Handle Aluminum Gripper® Plugs (Underground)

- Can be used in long-term applications.
- Chemical-resistant neoprene O-ring.
- Made of heavy-duty aluminum body and zinc plated steel T-handle.
- Bypass can be used to conduct sewer air pressure test.

| Product No. | Size | Description | Ctn. Qty. | Back Pressure P.S.I. | Feet of Head |
|-------------|------|---------------------------------|-----------|----------------------|--------------|
| 272949 | 6" | Gripper® Plug 1/4" with Bypass | 1 | 17 PSI | 40FT |
| 272957 | 8" | Gripper® Plug 3/4" with Bypass | 1 | 17 PSI | 40FT |
| 272965 | 10" | Gripper® Plug 3/4" with Bypass | 1 | 17 PSI | 40FT |
| 272973 | 12" | Gripper® Plug 3/4" with Bypass | 1 | 13 PSI | 30FT |
| 272981 | 15" | Gripper® Plug 3/4" with Bypass* | 1 | 13 PSI | 30FT |
| 272998 | 18" | Gripper® Plug 3/4" with Bypass* | 1 | 8.7 PSI | 20FT |

*Concrete and clay pipe sizes only.



Cherne® T-Handle Aluminum Gripper® Plugs (Underground)

- Can be used in long-term applications.
- Chemical-resistant neoprene O-ring.
- Made of heavy-duty aluminum body and zinc plated steel T-handle.

| Product No. | Size | Description | Ctn. Qty. | Back Pressure P.S.I. | Feet of Head |
|-------------|------|------------------------------|-----------|----------------------|--------------|
| 272892 | 6" | Gripper® Plug (Non By-Pass) | 1 | 17 PSI | 40FT |
| 272906 | 8" | Gripper® Plug (Non By-Pass) | 1 | 17 PSI | 40FT |
| 272914 | 10" | Gripper® Plug (Non By-Pass) | 1 | 17 PSI | 40FT |
| 272922 | 12" | Gripper® Plug (Non By-Pass) | 1 | 13 PSI | 30FT |
| 272930 | 15" | Gripper® Plug (Non By-Pass)* | 1 | 13 PSI | 30FT |
| 272888 | 18" | Gripper® Plug (Non By-Pass)* | 1 | 8.7 PSI | 20FT |

*Concrete and clay pipe sizes only.



Cherne® Econ-O-Grip® Plugs

- Cost-effective method for plugging open-ended pipe.
- Natural rubber O-ring.
- Effective pipe dust cover.
- Not recommended for pressure tests.

| Product No. | Size | Description | Ctn. Qty. | Back Pressure P.S.I. | Feet of Head |
|-------------|--------|-------------------|-----------|----------------------|--------------|
| 271519 | 1-1/2" | Econ-O-Grip® Plug | 10 | 2 PSI | 5FT |
| 271527 | 2" | Econ-O-Grip® Plug | 10 | 2 PSI | 5FT |
| 271535 | 3" | Econ-O-Grip® Plug | 10 | 2 PSI | 5FT |
| 271543 | 4" | Econ-O-Grip® Plug | 10 | 2 PSI | 5FT |
| 271551 | 5" | Econ-O-Grip® Plug | 5 | 1 PSI | 2FT |
| 271578 | 6" | Econ-O-Grip® Plug | 5 | 1 PSI | 2FT |



Cherne® Petro Econ-O-Grip® Plugs (Chemical Resistant)

- Chemical-resistant Nitrile rubber and stainless steel hardware.
- Not recommended for pressure tests.

| Product No. | Size | Description | Ctn. Qty. | Back Pressure P.S.I. | Feet of Head |
|-------------|--------|-----------------------------------|-----------|----------------------|--------------|
| 273318 | 1-1/2" | Stainless Steel Econ-O-Grip® Plug | 2 | 2 PSI | 5FT |
| 273328 | 2" | Stainless Steel Econ-O-Grip® Plug | 2 | 2 PSI | 5FT |
| 273338 | 3" | Stainless Steel Econ-O-Grip® Plug | 2 | 2 PSI | 5FT |
| 273348 | 4" | Stainless Steel Econ-O-Grip® Plug | 2 | 2 PSI | 5FT |
| 273358 | 5" | Stainless Steel Econ-O-Grip® Plug | 1 | 1 PSI | 2FT |
| 273368 | 6" | Stainless Steel Econ-O-Grip® Plug | 1 | 1 PSI | 2FT |



Cherne® Sure-Grip® Plugs

- Polypropylene construction with natural rubber O-ring.
- Can be used as a permanent or temporary plug.
- Fits all type(s) of pipe at nominal sizes.

| Product No. | Size | Description | Ctn. Qty. | Back Pressure P.S.I. | Feet of Head |
|--------------------|--------|-----------------------------|-----------|----------------------|--------------|
| 271158 | 1-1/2" | Sure-Grip® Plug | 10 | 22 PSI | 50FT |
| 271208 | 2" | Sure-Grip® Plug | 10 | 22 PSI | 50FT |
| 271308 | 3" | Sure-Grip® Plug | 10 | 13 PSI | 30FT |
| 271408 | 4" | Sure-Grip® Plug | 10 | 13 PSI | 30FT |
| Schedule 40 | | | | | |
| 271228 | 2" | Schedule 40 Sure-Grip® Plug | 10 | 22 PSI | 50FT |
| 271338 | 3" | Schedule 40 Sure-Grip® Plug | 10 | 13 PSI | 30FT |
| 271448 | 4" | Schedule 40 Sure-Grip® Plug | 10 | 13 PSI | 30FT |

Cherne® Kwik 'N Sure® Plugs

- Works in all types of pipe.
- Wing nut on 3/8" – 1-1/4" sizes.
- Hex nut on 1.5" through 5" sizes.
- Works well for plugging water line stub-outs.
- Natural rubber O-ring.



| Product No. | Size | Description | Ctn. Qty. | Back Pressure P.S.I. | Feet of Head |
|-------------|--------|--------------------|-----------|----------------------|--------------|
| 269832 | 0.39" | Kwik 'n Sure® Plug | 1 | 185 PSI | 428FT |
| 269840 | 1/2" | Kwik 'n Sure® Plug | 1 | 180 PSI | 415FT |
| 269867 | 3/4" | Kwik 'n Sure® Plug | 1 | 180 PSI | 415FT |
| 269875 | 1" | Kwik 'n Sure® Plug | 1 | 40 PSI | 92FT |
| 269883 | 1-1/4" | Kwik 'n Sure® Plug | 1 | 112 PSI | 258FT |
| 269891 | 1-1/2" | Kwik 'n Sure® Plug | 1 | 88 PSI | 203FT |
| 269905 | 2" | Kwik 'n Sure® Plug | 1 | 112 PSI | 258FT |
| 269913 | 2-1/2" | Kwik 'n Sure® Plug | 1 | 72 PSI | 166FT |
| 269921 | 3" | Kwik 'n Sure® Plug | 1 | 28 PSI | 65FT |
| 269948 | 4" | Kwik 'n Sure® Plug | 1 | 24 PSI | 55FT |
| 269956 | 5" | Kwik 'n Sure® Plug | 1 | 8 PSI | 18FT |

Cherne® Monitor Well™ Locking Plugs

- Designed to seal monitor wells.
- Sized to seal Schedule 40 piping.
- 2" and 4" sizes can also seal schedule 5 plastic and stainless steel pipe.
- Yellow chromate-coated locking latch accepts Cherne's solid brass padlock or No. 2 Master® padlock.
- Meets all EPA requirements for locking plugs.
- Made with chemical-/petroleum-resistant Estaloc® plastic top/bottom plates and Nitrile sealing O-ring.
- Comes with stainless steel carriage bolt.



| Product No. | Size | Description | Ctn. Qty. | Back Pressure P.S.I. | Feet of Head |
|-------------|-----------|----------------------------|-----------|----------------------|--------------|
| 271648 | 1"-1-1/4" | Monitor Well™ Locking Plug | 12 | 6.5 PSI | 15FT |
| 271675 | 2" | Monitor Well™ Locking Plug | 50 | 6.5 PSI | 15FT |
| 271669 | 3" | Monitor Well™ Locking Plug | 75 | 6.5 PSI | 15FT |
| 271683 | 4" | Monitor Well™ Locking Plug | 25 | 6.5 PSI | 15FT |
| 271691 | 6" | Monitor Well™ Locking Plug | 10 | 6.5 PSI | 15FT |
| 271735 | 8" | Monitor Well™ Locking Plug | 8 | 6.5 PSI | 15FT |
| 112941 | | Padlock with Key | 1 | | |



Cherne® Iron Grip™ Plugs

- The sturdy design is perfect for a variety of low-pressure, water/air testing or blocking applications.
- Large wing nut design allows for easy, tool-free installation and superior sealing.
- Can be used as either a temporary or permanent plug.
- Cast iron construction is both economical yet rugged.
- Bypass allows for easy pressure relief.
- Now available in most popular sizes.

| Product No. | Description | Ctn. Qty. | Back Pressure P.S.I. | Feet of Head |
|-------------|--|-----------|----------------------|--------------|
| 268028 | 2" Iron Grip Bypass Plug w/ 3/8" bypass | 1 | 13 PSI | |
| 268038 | 3" Iron Grip Bypass Plug w/ 1/2" bypass | 1 | 11 PSI | |
| 268048 | 4" Iron Grip Bypass Plug w/ 1/2" bypass | 1 | 8.7 PSI | |
| 268068 | 6" Iron Grip Bypass Plug w/ 1/2" bypass | 1 | 4.3 PSI | |
| 268088 | 8" Iron Grip Bypass Plug w/ 1/2" bypass | 1 | 4.3 PSI | |
| 268108 | 10" Iron Grip Bypass Plug w/ 1/2" bypass | 1 | 3.5 PSI | |
| 268128 | 12" Iron Grip Bypass Plug w/ 1/2" bypass | 1 | 2.6 PSI | |

Cherne® Mechanical Cleanout Plugs

- Quick & Easy – Mechanical Operation.
- High Test Pressures - Up to 150 ft head/ 65 psi / 15 floors*.
- No Tools Required - Install / Remove in seconds.
- Fits PVC, ABS, & Cast Iron Cleanout Tees.
- Durable & Replaceable Rubber Pads.
- 2 Stage Locking Mechanism - Locks into test & drain positions.



#271058 shown



#271148 shown

| Product No. | Description | Ctn. Qty. | Maximum Back Pressure P.S.I. | Flow Rate |
|-------------|--|-----------|-----------------------------------|---------------|
| 271128 | 2" Mechanical Cleanout Plug | 1 | 150 ft head / 65 psi / 15 floors* | |
| 271038 | 3" Mechanical Cleanout Plug | 1 | 150 ft head / 65 psi / 15 floors* | |
| 271048 | 4" Mechanical Cleanout Plug | 1 | 100 ft head / 44 psi / 10 floors* | |
| 271058 | 4" Mechanical Cleanout Plug with Hose | 1 | 100 ft head / 44 psi / 10 floors* | Up to 9 GPM** |
| 270308 | 2" Replacement Pad Kit | 1 | | |
| 270318 | 3" Replacement Pad Kit | 1 | | |
| 270328 | 4" Replacement Pad Kit | 1 | | |
| 270338 | 4" Replacement Pad Kit with Hose | 1 | | |
| 271148 | Shut off Valve, Mechanical Cleanout Plug | 1 | | |

*calculated using 10 ft head per floor

**calculated with pressure at 80 psi



Category 20

Test Equipment, Drain Flushers, and Accessories

Everything from replacement chains and extension hoses to poly lift lines and gauges. Innovation and quality has made Cherne the contractor's choice since 1953, for Hand Pumps, Hose Assemblies, Drain Flushers, Test Gauges, and Manometers!

TEST EQUIPMENT, DRAIN FLUSHERS, AND ACCESSORIES



Cherne® Hi-Flow™ Air-Loc® Panel

- Panel includes gauges to monitor compressor pressure, plug pressure and test pressure.
- Stored in a sturdy case.
- Can be used with either 3/8" or 3/4" fill hose, accomplished by simply turning a valve.
- Designed to work with air compressors fitted with either crow's foot or standard quick disconnect fittings.

| Product No. | Description |
|-------------|---|
| 304718 | Control Panel |
| 026358 | 0-10 PSI Test Pressure Gauge – Retarded increments from 11-30 PSI |
| 014828 | 0-60 PSI Ball Pressure Gauge |
| 014848 | 0-160 PSI Compressor Gauge |
| 0430480A | 3-Way Valve |
| 296643 | Regulator |



Cherne® Triple Hose

- The 3/8" diameter hose assembly is used to connect the Air-Loc Panel to the front plug.
- Triple hose is color-coded, making connections easy to understand.
- Hose features locking quick disconnects for safety and includes strain relief to protect hose from damage.
- Available with 3/4 blue test pressure hose for quick exhausting.

| Product No. | Description |
|-------------|-------------------------|
| 035268 | 25' Triple Hose |
| 257038 | 50' Triple Hose |
| 257188 | 400' Triple Hose |
| 257108 | 25' Hi-Flow Triple Hose |
| 257098 | 50' Hi-Flow Triple Hose |



Cherne® 22' Interconnect Hose

- Used to attach the front and back air test plugs when conducting a leak location test.
- Includes a cable for attaching to the pipe plugs to take strain off the hose during the leak location process.

| Product No. | Description |
|-------------|-----------------------|
| 043338 | 22' Interconnect Hose |



Cherne® Air-Loc® Line Acceptance Kit

- Used to perform low pressure air tests on newly installed sewer lines.
- Includes all items needed to conduct the test except an air compressor and two pipe plugs.

| Product No. | Description |
|-------------|------------------------------|
| 253398 | Air-Loc® Line Acceptance Kit |



Cherne® Smoke Blowers

| Product No. | Description | Ctn. Qty. |
|-------------|---|-----------|
| 303008 | Smoke Fluid Smoke Blower Kit: Briggs & Stratton Engine | 1 |
| 303550 | Smoke Candle Smoke Blower Kit: Briggs & Stratton Engine | 1 |

Cherne® Residential Smoke Blower

- Honda engine; 122CC, 3.5 HP, 4 Stroke, >700 CFM
- 5' heavy duty hose with 4" diameter
- Vibration damping – minimize excess movement
- Can be used indoors – exhaust is pumped through plumbing
- Long lasting, dense smoke



| Product No. | Size | Description | UPC | Ctn. Qty. |
|-------------|------|---------------------------------------|--------------|-----------|
| 303078 | | Plumbing Smoke Blower | 675115034587 | 1 |
| 036488 | | Fluid Smoke Pressure Container & Hose | 675115036482 | 1 |

Cherne® Smoke Fluid



| Product No. | Description | UPC | Ctn. Qty. |
|-------------|-------------------------------------|--------------|-----------|
| 065808 | Smoke Fluid: One Gallon | 675115065802 | 1 |
| 065818 | Smoke Fluid: Five Gallons | 675115065819 | 1 |
| 065828 | Smoke Fluid: Fifty-Five Gallon Drum | 675115065826 | 1 |

Cherne® Smoke Generators (Candles)



| Product No. | Description | UPC | Ctn. Qty. |
|-------------|-------------------------------------|--------------|-----------|
| 072608 | Smoke Candle: 30 Seconds | 675115034341 | 12 |
| 072618 | Smoke Candle: 60-Seconds | 675115072619 | 12 |
| 072628 | Smoke Candle: 3 Minutes | 675115072626 | 12 |
| 072638 | Smoke Candle: 3 Minutes Double Wick | 675115072633 | 12 |

Cherne® Econ-O-Pump™ Test Pump

- Low cost version for the infrequent user.
- 0-140 PSI gauge.
- Traditional thumb lock.
- All metal construction.



| Product No. | Size | Description | UPC | Ctn. Qty. |
|-------------|------|------------------------|--------------|-----------|
| 273888 | | Econ-O-Pump™ Test Pump | 675115273887 | 1 |

Cherne® Air-Max® Test Pumps

- Gauge raised from base for protection.
- 0-100 PSI gauge.
- Durable steel barrel.
- Textured steel base prevents feet from slipping.
- Durable, no-kink hose.



| Product No. | Size | Description | UPC | Ctn. Qty. |
|-------------|------|--|--------------|-----------|
| 034588 | | Replacement Hose Assembly w/Thumb Lock | 675115034587 | 1 |
| 273958 | | Air-Max® Test Pump | 675115273955 | 1 |

Cherne® Air-Max® Pro HV Test Pumps

- Large barrel for maximum volume means fewer strokes to inflate plug.
- 0-60 PSI gauge for most accurate plug pressure readings.
- All-metal thumb lock for durability.
- Hose strain relief to transfer tension from hose to the barrel.
- Forged steel barrel for extra toughness.
- Large, three-point base for maximum stability.
- Rubber cover to protect gauge from damage.
- Solid wood handle for greater comfort and durability.
- Durable, no-kink hose.



| Product No. | Size | Description | UPC | Ctn. Qty. |
|-------------|------|--|--------------|-----------|
| 055728 | | Replacement Hose Assembly w/Thumb Lock | 675115055728 | 1 |
| 273968 | | Air-Max® Test Pump | 675115273962 | 1 |

TEST EQUIPMENT, DRAIN FLUSHERS AND ACCESSORIES



Cherne® Manometer

- Used for final test of DWV pipe and to test gas lines.
- Reads in 1/10" increments
- Measures water columns from 0" to 16".

| Product No. | Size | Description | Ctn. Qty. |
|-------------|------|-------------|-----------|
| 010205 | | Manometer | 1 |



Cherne® Replacement Chains

- Replacement assemblies for Test-Ball plugs.
- Rings prevent test plugs from sliding down a line.
- Includes a safety tag.

| Product No. | Description | Ctn. Qty. |
|-------------|------------------------|-----------|
| 059708 | 2" Ring With 12" Chain | 1 |
| 059718 | 3" Ring With 12" Chain | 1 |
| 059728 | 4" Ring With 12" Chain | 1 |
| 059748 | 6" Ring With 12" Chain | 1 |
| 059758 | 2" Ring With 24" Chain | 1 |
| 059768 | 3" Ring With 24" Chain | 1 |
| 059778 | 4" Ring With 24" Chain | 1 |
| 059798 | 6" Ring With 24" Chain | 1 |



Cherne® Gauges

- Features 2" plastic face.
- High-quality brass 1/4" connection.

| Product No. | Description | Ctn. Qty. |
|-------------|---|-----------|
| 000698 | 0-15 psi Gauge 2" Face 0.1 psi Increments | 1 |
| 000628 | 0-30 psi Gauge 2" Face 0.5 psi Increments | 1 |
| 000638 | 0-60 psi Gauge 2" Face 1 psi Increments | 1 |
| 000648 | 0-100 psi Gauge 2" Face 2 psi Increments | 1 |



Cherne® Gauges With 3/4" FNPT Test Body

- Features 2" plastic face.
- Chrome plated body.
- 1/8" Schrader valve and 3/4" NPT(F) pipe connection.

| Product No. | Description | Ctn. Qty. |
|-------------|---|-----------|
| 024568 | 0-15 psi Gauge 2" Face 0.1 psi Increments | 1 |
| 019698 | 0-30 psi Gauge 2" Face 0.5 psi Increments | 1 |
| 019708 | 0-60 psi Gauge 2" Face 1 psi Increments | 1 |
| 019718 | 0-100 psi Gauge 2" Face 2 psi Increments | 1 |
| 000658 | Hex Test Body 1/8" Tap | 1 |
| 068527 | Replacement Schrader Valve 1/8" | 1 |



Cherne® Hose - 3/16" ID

- Recommended for use with plugs up to 15" in diameter.
- Ideal for plumbing applications.
- Standard Schrader air valve connections.
- 3/16" ID hose.

| Product No. | Description | Ctn. Qty. |
|-------------|-----------------------------------|-----------|
| 274011 | 2' Hose, 3/16" ID | 6 |
| 274038 | 3' Hose, 3/16" ID | 6 |
| 274008 | 2' Hose, 3/16" ID Bagged Bulk Pak | 24 |
| 274018 | 3' Hose, 3/16" ID Bagged Bulk Pak | 24 |
| 274054 | 5' Hose, 3/16" ID | 1 |
| 274100 | 10' Hose, 3/16" ID | 1 |
| 274208 | 20' Hose, 3/16" ID | 1 |
| 055816 | Deflator With Clamp (Female End) | 1 |
| 055808 | Inflator With Clamp (Male End) | 1 |
| 277048 | Replacement O-rings (Pack of 10) | 1 |



Cherne® Extension Hose With Gauge, 3/16" ID

- Recommended for use with plugs up to 15" in diameter.
- Ideal for plumbing applications
- Standard Schrader valve connections.
- 3/16" ID hose.
- 0-100 PSIG gauge.

| Product No. | Description | Ctn. Qty. |
|-------------|-------------------------------|-----------|
| 274218 | 5' Hose With Gauge 3/16" ID | 1 |
| 274228 | 10' Hose With Gauge 3/16" ID | 1 |
| 274238 | 20' Hose With Gauge 3/16" ID | 1 |
| 274248 | 30' Hose with Gauge 3/16" ID | 1 |
| 274268 | 50' Hose with Gauge 3/16" ID | 1 |
| 274298 | 100' Hose with Gauge 3/16" ID | 1 |



Cherne® Hi-Flow Poly Lift Line with and without Gauge

- Greater Lifting Strength.
- Recommended for plugs 6" to 48".
- Retard gauge: helps prevent "peg-out" damage.
- Heavy-duty rubber gauge cover protects gauge.
- 3/8" heavy-duty ID hose for quick inflate/deflate.
- Quick-dump valve for easy deflation.
- Industrial quick disconnect.
- Designed for use with plugs with removable inflator valve.

| Product No. | Description | Ctn. Qty. |
|-------------|---|-----------|
| 380108 | 10' Hi-Flow Hose, w/o Gauge, 3/8" ID | 1 |
| 380208 | 20' Hi-Flow Hose, w/o Gauge, 3/8" ID | 1 |
| 380308 | 30' Hi-Flow Hose, w/o Gauge, 3/8" ID | 1 |
| 380408 | 40' Hi-Flow Hose, w/o Gauge, 3/8" ID | 1 |
| 380508 | 50' Hi-Flow Hose, w/o Gauge, 3/8" ID | 1 |
| 048468 | 0-60 psi, 2.5" Dial, Plug Pressure Gauge With Retarded Increments To 160 Psi With Cover | 1 |
| 053458 | 0-60 psi, 2.5" Dial, Plug Pressure Gauge With Retarded Increments To 160 Psi | 1 |



Cherne® Super-Flow Hose with Gauge

- Designed for large diameter multi-size plugs - (24"-48" to 54"-96").
- 3/4" Heavy-duty hose for both durability and faster deflation.
- Retard gauge: Helps prevent gauge "peg-out".
- Heavy-duty rubber gauge cover protects gauge.
- Utilizes traditional "crow's foot" air compressor fittings.
- Quick dump valve for easy deflation.

| Product No. | Description | Ctn. Qty. |
|-------------|--|-----------|
| 341208 | 20' Super-Flow Hose, w/ Gauge, 3/4" ID | 1 |
| 341308 | 30' Super-Flow Hose, w/ Gauge, 3/4" ID | 1 |
| 341408 | 40' Super-Flow Hose, w/ Gauge, 3/4" ID | 1 |



Cherne® Poly Lift Line - 3/16" ID

- Schrader valve connections.
- Poly rope designed for raising and lowering plug.
- Ideal for plugs 8" and up.
- 3/16" ID hose.
- Snap hook connects to plug eyebolt.

| Product No. | Description | Ctn. Qty. |
|-------------|--|-----------|
| 261076 | 10' Hose With Poly Lift Line, 3/16" ID | 1 |
| 261084 | 20' Hose With Poly Lift Line, 3/16" ID | 1 |
| 261106 | 30' Hose With Poly Lift Line, 3/16" ID | 1 |
| 261114 | 40' Hose With Poly Lift Line, 3/16" ID | 1 |



Category 21

Pans and Stands

Oatey® Aluminum and Plastic Water Heater Pans can be installed under gas or electric water heaters to protect from water damage. Pans are manufactured from prime aluminum or semi-flexible, tough and durable .0625" plastic polymer and are expertly worked to exact specifications under strict quality control. Available with 1" PVC, 1½" PVC or 1" CPVC drain fittings to allow for connection to indirect drain.



Oatey® Aluminum Water Heater Pan

- Manufactured from prime aluminum and are expertly worked to exact specifications under strict quality control.
- Recommended for gas or electric water heaters.
- Exposed edges have been rolled to protect the installer from injury.

| Product No. | Size | Description | UPC | Ctn. Qty. |
|--|------|-------------------------------------|--------------|-----------|
| Aluminum Water Heater Pans - 1" To 1-1/2" PVC Adapter (1-1/2" inside) | | | | |
| 34081 | 20" | Aluminum Pan | 038753340814 | 6 |
| 34082 | 22" | Aluminum Pan | 038753340821 | 6 |
| 34083 | 24" | Aluminum Pan | 038753340838 | 6 |
| 34084 | 26" | Aluminum Pan | 038753340845 | 6 |
| 34103 | 28" | Aluminum Pan | 038753341033 | 6 |
| 34107 | 30" | Aluminum Pan | 038753341071 | 6 |
| 34191 | 32" | Aluminum Pan | 038753341910 | 6 |
| Aluminum Water Heater Pans with 1" CPVC Adapter | | | | |
| 34170 | 18" | Aluminum Pan | 038753341705 | 6 |
| 34171 | 20" | Aluminum Pan | 038753341712 | 6 |
| 34172 | 22" | Aluminum Pan | 038753341729 | 6 |
| 34173 | 24" | Aluminum Pan | 038753341736 | 6 |
| 34174 | 26" | Aluminum Pan | 038753341743 | 6 |
| 34176 | 28" | Aluminum Pan | 038753341767 | 6 |
| 34175 | 30" | Aluminum Pan | 038753341750 | 6 |
| 34193 | 32" | Aluminum Pan | 038753341934 | 6 |
| Aluminum Water Heater Pans - Without Adapter | | | | |
| 34092 | 22" | Aluminum Pan Without Hole / Adapter | 038753340920 | 6 |
| 34093 | 24" | Aluminum Pan Without Hole / Adapter | 038753340937 | 6 |
| 34094 | 26" | Aluminum Pan Without Hole / Adapter | 038753340944 | 6 |
| 34192 | 32" | Aluminum Pan Without Hole / Adapter | 038753341927 | 6 |



Oatey® Water Heater Pan Adapters

- Available in PVC or CPVC.
- 1" & 1-1/2".

| Product No. | Size | Description | UPC | Ctn. Qty. |
|-------------|-------------|--|--------------|-----------|
| 34086 | 1" & 1-1/2" | PVC Adapter (1" inside adapter / 1-1/2" inside adapter) | 038753340869 | 12 |
| 34088 | 1" & 1-1/2" | PVC Adapter (1" inside adapter / 1-1/2" over adapter) | 038753340883 | 12 |
| 34089 | 1" | CPVC Adapter | 038753340890 | 12 |



Oatey® Plastic Water Heater Pan

- Manufactured from semi-flexible, tough and durable .0625" plastic polymer.
- Recommended for electric water heaters.

| Product No. | Size | Description | UPC | Ctn. Qty. |
|---|------|-------------|--------------|-----------|
| Plastic Water Heater Pans with 1"-1-1/2" PVC Adapter (1-1/2" inside) | | | | |
| 34140 | 18" | Plastic Pan | 038753341408 | 12 |
| 34142 | 22" | Plastic Pan | 038753341422 | 12 |
| 34143 | 24" | Plastic Pan | 038753341439 | 12 |
| 34144 | 26" | Plastic Pan | 038753341446 | 12 |
| 34146 | 28" | Plastic Pan | 038753341460 | 6 |
| 34145 | 30" | Plastic Pan | 038753341453 | 12 |
| Plastic Water Heater Pans With 1" CPVC Adapter | | | | |
| 34160 | 18" | Plastic Pan | 038753341606 | 12 |
| 34161 | 20" | Plastic Pan | 038753341613 | 12 |
| 34162 | 22" | Plastic Pan | 038753341620 | 12 |
| 34163 | 24" | Plastic Pan | 038753341637 | 12 |
| 34164 | 26" | Plastic Pan | 038753341644 | 12 |



Oatey® Washing Machine Pan

- Provides protection from washing machine overflow or hose failure.
- Made from high impact plastic.
- Will not rust or corrode.
- Pans have formed hole to punch out for the furnished, 1" PVC plastic fitting.

| Product No. | Size | Description | UPC | Ctn. Qty. |
|-------------|-----------|-------------------------------|--------------|-----------|
| 34051 | 28" x 30" | Plastic Pan – Bagged | 038753340517 | 4 |
| 34052 | 28" x 30" | Plastic Pan – Without Fitting | 038753340524 | 6 |
| 34067 | 28" x 30" | Plastic Pan | 038753340678 | 12 |



Harvey® Water Heater Stand

- Constructed of 18 gauge spangeld galvanized sheet metal.
- Allows placement of water heater tanks 18-in above ground as required by most model plumbing and fuel codes.
- Holds up to 50 gallon water heaters.

| Product No. | Size | Description | UPC | Ctn. Qty. |
|-------------|-----------|--|--------------|-----------|
| 013900 | 21" x 18" | HV Water Heater Stand 21" Square x 18" | 078864139006 | 4 |



Category 22

Commercial Drainage

Oatey® commercial drains are designed to stand up to heavy traffic areas. Preformed anchor positions are included in each base design and drain barrels include internal thread that accepts clean-out plugs. Four grate finishes are available: Stainless Steel, Nickel, Chrome and Brass.



Oatey® General Purpose Brass Strainer

- Features a barrel assembly that is completely adjustable to meet the finished floor height.
- PVC Barrel.

| Product No. | Size | Description | UPC | Ctn. Qty. |
|-------------|-------------------|------------------------|--------------|-----------|
| 72017 | 3" Pipe or 4" Hub | 5" Strainer - PVC Base | 038753720173 | 1 |
| 72018 | 4" Pipe Fit | 5" Strainer - PVC Base | 038753780139 | 1 |
| 72019 | 4" Hub Fit | 5" Strainer - PVC Base | 038753720197 | 1 |
| 82017 | 3" Pipe or 4" Hub | 5" Strainer - ABS Base | 038753820170 | 1 |
| 82019 | 4" Hub | 5" Strainer - ABS Base | 038753820194 | 1 |
| 72117 | 3" Pipe or 4" Hub | 6" Strainer - PVC Base | 038753721170 | 1 |
| 72119 | 4" Hub Fit | 6" Strainer - PVC Base | 038753721194 | 1 |

Oatey® General Purpose Nickel Strainer

- Uses an easy-leveling strainer mount to correct tilted drains
- PVC Barrel



#72167 shown

| Product No. | Size | Description | UPC | Ctn. Qty. |
|-------------|-------------------|--|--------------|-----------|
| 72067 | 3" Pipe or 4" Hub | 5" Strainer - PVC Base - Round with Ring | 038753720678 | 1 |
| 72068 | 4" Pipe Fit | 5" Strainer - PVC Base - Round with Ring | 038753720685 | 1 |
| 72077 | 3" Pipe or 4" Hub | 5" Strainer - PVC Base - Round with Sq. Ring | 038753720777 | 1 |
| 72079 | 4" Hub Fit | 5" Strainer - PVC Base - Round with Sq. Ring | 038753720791 | 1 |
| 82067 | 3" Pipe or 4" Hub | 5" Strainer - ABS Base - Round with Ring | 038753820675 | 1 |
| 82068 | 4" Pipe Fit | 5" Strainer - ABS Base - Round with Ring | 038753820682 | 1 |
| 72167 | 3" Pipe or 4" Hub | 6" Strainer - PVC Base - Round with Ring | 038753721675 | 1 |
| 72168 | 4" Pipe Fit | 6" Strainer - PVC Base - Round with Ring | 038753721682 | 1 |
| 72169 | 4" Hub Fit | 6" Strainer - PVC Base - Round with Ring | 038753721699 | 1 |
| 72177 | 3" Pipe or 4" Hub | 6" Strainer - PVC Base - Round with Sq. Ring | 038753721774 | 1 |

Oatey® General Purpose Cleanout Items

- Easily converts a drain to a cleanout or vice versa, even after the concrete is poured.



#74168 shown

| Product No. | Size | Description | UPC | Ctn. Qty. |
|-------------|-------------------|--|--------------|-----------|
| 74167 | 3" Pipe or 4" Hub | 6" Cleanout - PVC Barrel and PVC Flange Base | 038753741673 | 1 |
| 74168 | 4" Pipe Fit | 6" Cleanout - PVC Barrel and PVC Flange Base | 038753741680 | 1 |
| 74169 | 4" Hub Fit | 6" Cleanout - PVC Barrel and PVC Flange Base | 038753741697 | 1 |
| 74177 | 3" Pipe or 4" Hub | 6" Cleanout - PVC Barrel and PVC Flange - Round with Sq. Ring | 038753741772 | 1 |
| 74178 | 4" Pipe Fit | 6" Cleanout - PVC Barrel and PVC Flange - Round with Sq. Ring | 038753741789 | 1 |
| 74179 | 4" Hub Fit | 6" Cleanout - PVC Barrel and PVC Flange - Round with Sq. Ring | 038753741796 | 1 |
| 84167 | 3" Pipe or 4" Hub | 6" Cleanout - PVC Barrel and ABS Flange - Round with Ring | 038753841670 | 1 |
| 84179 | 4" Hub Fit | 6" Cleanout - PVC Barrel and ABS Flange Base - Round with Sq. Ring | 038753841793 | 1 |

COMPONENTS



Oatey® Replacement Grates

- Uses an easy-leveling strainer mount to correct tilted drains.
- Solves the problem of drain installs knocked out of plumb after concrete is poured.

| Product No. | Size | Description | UPC | Ctn. Qty. |
|-------------|------|----------------------------------|--------------|-----------|
| 80010 | 5" | Stainless Steel Grate | 038753800103 | 1 |
| 80020 | 5" | Round Brass Grate | 038753800202 | 1 |
| 80040 | 5" | Round Brass Grate with Sq. Ring | 038753800400 | 1 |
| 80050 | 5" | Round Brass Grate | 038753800509 | 1 |
| 80060 | 5" | Round Nickel Grate and Ring | 038753800608 | 1 |
| 80080 | 5" | Round Chrome Grate | 038753800806 | 1 |
| 80120 | 6" | Round Brass Grate | 038753801209 | 1 |
| 80130 | 6" | Round Brass Grate and Ring | 038753801308 | 1 |
| 80140 | 6" | Round Brass Grate with Sq. Ring | 038753801407 | 1 |
| 80150 | 6" | Round Brass Grate | 038753801506 | 1 |
| 80170 | 6" | Round Nickel Grate with Sq. Ring | 038753801704 | 1 |
| 80190 | 6" | Round Chrome Grate and Ring | 038753801902 | 1 |
| 80200 | 6" | Round Chrome Grate with Sq. Ring | 038753802008 | 1 |



Oatey® Replacement Covers

- Uses an easy-leveling strainer mount to correct tilted drains.
- Solves the problem of drain installs knocked out of plumb after concrete is poured.

| Product No. | Size | Description | UPC | Ctn. Qty. |
|-------------|------|------------------------------------|--------------|-----------|
| 81120 | 6" | Round Cover - Brass | 038753811208 | 1 |
| 81130 | 6" | Round Cover & Ring - Brass | 038753811307 | 1 |
| 81140 | 6" | Round Cover & Square Ring - Brass | 038753811406 | 1 |
| 81150 | 6" | Round Cover - Nickel | 038753811505 | 1 |
| 81160 | 6" | Round Cover & Ring - Nickel | 038753811604 | 1 |
| 81170 | 6" | Round Cover & Square Ring - Nickel | 038753811703 | 1 |

SEDIMENT DRAINS



Oatey® Sediment Drains

- Multipurpose drain for effective effluent removal in any application.
- Optional removable sediment bucket will keep drain lines free of all debris.

| Product No. | Size | Description | UPC | Ctn. Qty. |
|-------------|---------------|---|--------------|-----------|
| 76012 | 2" Pipe | PVC Sediment Drain, Plastic Grate w/ Bucket | 038753760124 | 1 |
| 76022 | 2" Pipe | PVC Sediment Drain, Plastic Grate w/o Bucket | 038753760223 | 1 |
| 76013 | 3" or 4" Pipe | PVC Sediment Drain, Plastic Grate w/ Bucket | 038753760131 | 1 |
| 76023 | 3" or 4" Pipe | PVC Sediment Drain, Plastic Grate w/o Bucket | 038753760230 | 1 |
| 76033 | 3" or 4" Pipe | PVC Sediment Drain, Cast Iron Grate w/ Bucket | 038753760339 | 1 |
| 76014 | 4" Pipe | PVC Sediment Drain, Plastic Grate w/ Bucket | 038753760148 | 1 |
| 76024 | 4" Pipe | PVC Sediment Drain, Plastic Grate w/o Bucket | 038753760247 | 1 |
| 76034 | 4" Pipe | PVC Sediment Drain, Cast Iron Grate w/ Bucket | 038753760346 | 1 |
| 76016 | 6" Pipe | PVC Sediment Drain, Plastic Grate w/ Bucket | 038753760162 | 1 |
| 76026 | 6" Pipe | PVC Sediment Drain, Plastic Grate w/o Bucket | 038753760261 | 1 |
| 76036 | 6" Pipe | PVC Sediment Drain, Cast Iron Grate w/ Bucket | 038753760360 | 1 |
| 86012 | 2" Pipe | ABS Sediment Drain, Plastic Grate w/Bucket | 038753860121 | 1 |
| 86032 | 2" Pipe | ABS Sediment Drain, Cast Iron Grate W/Bucket | 038753860329 | 1 |
| 86034 | 4" Pipe | ABS Sediment Drain, Cast Iron Grate w/ Bucket | 038753860343 | 1 |
| 86036 | 6" Pipe | ABS Sediment Drain, Cast Iron Grate W/Bucket | 038753860367 | 1 |

SEDIMENT DRAINS



Oatey® General Purpose Brass Strainer

| Product No. | Size | Description | UPC | Ctn. Qty. |
|-------------|------|---------------|--------------|-----------|
| 71740 | | Grate | 038753717401 | 1 |
| 71750 | | Grate Collar | 038753717500 | 1 |
| 71760 | | Debris Bucket | 038753717609 | 1 |

ROOF DRAINS



Oatey® Roof Drain with Dome

- Superior drainage with robust debris protection.
- Available in cast iron or plastic domes with 2 inch water dam collar.

| Product No. | Size | Description | UPC | Ctn. Qty. |
|-------------|---------------|---|--------------|-----------|
| 78012 | 2" Pipe | PVC Roof Drain w/ Plastic Dome | 038753780122 | 1 |
| 78022 | 2" Pipe | PVC Roof Drain w/ Cast Iron Dome | 038753780221 | 1 |
| 78032 | 2" Pipe | PVC Roof Drain w/ ABS Dome & Dam Collar | 038753780320 | 1 |
| 78042 | 2" Pipe | PVC Roof Drain w/ Cast Iron Dome & Dam Collar | 038753780429 | 1 |
| 78013 | 3" or 4" Pipe | PVC Roof Drain w/ Plastic Dome | 038753780139 | 1 |
| 78023 | 3" or 4" Pipe | PVC Roof Drain w/ Cast Iron Dome | 038753780238 | 1 |
| 78033 | 3" or 4" Pipe | PVC Roof Drain w/ ABS Dome & Dam Collar | 038753780337 | 1 |
| 78043 | 3" or 4" Pipe | PVC Roof Drain w/ Cast Iron Dome & Dam Collar | 038753780436 | 1 |
| 78014 | 4" Pipe | PVC Roof Drain w/ Plastic Dome | 038753780146 | 1 |
| 78024 | 4" Pipe | PVC Roof Drain w/ Cast Iron Dome | 038753780245 | 1 |
| 78034 | 4" Pipe | PVC Roof Drain w/ ABS Dome & Dam Collar | 038753780344 | 1 |
| 78044 | 4" Pipe | PVC Roof Drain w/ Cast Iron Dome & Dam Collar | 038753780443 | 1 |
| 78016 | 6" Pipe | PVC Roof Drain w/ Plastic Dome | 038753780160 | 1 |
| 78026 | 6" Pipe | PVC Roof Drain w/ Cast Iron Dome | 038753780269 | 1 |
| 78036 | 6" Pipe | PVC Roof Drain w/ ABS Dome & Dam Collar | 038753780368 | 1 |
| 78046 | 6" Pipe | PVC Roof Drain w/ Cast Iron Dome & Dam Collar | 038753780467 | 1 |
| 88012 | 2" Pipe | ABS Roof Drain w/ Plastic Dome Guard | 038753880129 | 1 |
| 88022 | 2" Pipe | ABS Roof Drain w/ Cast Iron Dome Guard | 038753880228 | 1 |
| 88032 | 2" Pipe | ABS Roof Drain w/ ABS Dome Dam Collar | 038753880327 | 1 |
| 88042 | 2" Pipe | ABS Roof Drain w/ Cast Iron Dome Dam Collar | 038753880426 | 1 |
| 88013 | 3" or 4" Pipe | ABS Roof Drain w/ Plastic Dome Guard | 038753880136 | 1 |
| 88033 | 3" or 4" Pipe | ABS Roof Drain w/ ABS Dome & Dam Collar | 038753880334 | 1 |
| 88043 | 3" or 4" Pipe | ABS Roof Drain w/ Cast Iron Dome & Dam Collar | 038753880433 | 1 |
| 88014 | 4" Pipe | ABS Roof Drain w/ Plastic Dome | 038753880143 | 1 |
| 88034 | 4" Pipe | ABS Roof Drain w/ ABS Dome Dam Collar | 038753880341 | 1 |
| 88044 | 4" Pipe | ABS Roof Drain w/ Cast Iron Dome & Dam Collar | 038753880440 | 1 |
| 88016 | 6" Pipe | ABS Roof Drain w/ Plastic Dome | 038753880167 | 1 |
| 88026 | 6" Pipe | ABS Roof Drain w/ Cast Iron Dome | 038753880266 | 1 |
| 88036 | 6" Pipe | ABS Roof Drain w/ ABS Dome & Dam Collar | 038753880365 | 1 |
| 88046 | 6" Pipe | ABS Roof Drain w/ Cast Iron Dome Dam Collar | 038753880464 | 1 |



Oatey® Roof Drain Components

- Drain Components include plastic cover plates and brass floor grates for use with bath drains.

| Product No. | Size | Description | UPC | Ctn. Qty. |
|-------------|------|----------------------|--------------|-----------|
| 71970 | | Plastic Gravel Guard | 038753719702 | 1 |
| 71960 | | Dam Collar | 038753719603 | 1 |



Oatey® PVC Floor Sinks

- Allows easy access for cleaning and debris removal caused by indirect waste sources such as sinks, lavatories and condensate drains.

| Product No. | Size | Description | UPC | Ctn. Qty. |
|-------------|------|----------------|--------------|-----------|
| 42720 | 2" | PVC Floor Sink | 038753427201 | 1 |
| 42721 | 3" | PVC Floor Sink | 038753427218 | 1 |
| 42722 | 4" | PVC Floor Sink | 038753427225 | 1 |

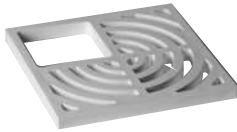

Oatey® Top Grate for Floor Sinks

- Allows easy access for cleaning and debris removal caused by indirect waste sources such as sinks, lavatories and condensate drains.

| Product No. | Size | Description | UPC | Ctn. Qty. |
|-------------|------|--|--------------|-----------|
| 42751 | | Half Top Grate For Floor Sink | 038753427515 | 1 |
| 42752 | | Three-Quarter Top Grate For Floor Sink | 038753427522 | 1 |
| 42753 | | Full Top Grate for Floor Sink | 038753427539 | 1 |



Oatey® Cast Iron Drain Funnels

| Product No. | Size | Description | UPC | Ctn. Qty. |
|-------------|------|--------------------|--------------|-----------|
| 71720 | | Round Drain Funnel | 038753717203 | 1 |
| 71730 | | Oval Drain Funnel | 038753717302 | 1 |



Oatey® Reversible Dome Strainers/Buckets

- Allows easy access for cleaning and debris removal caused by indirect waste sources such as sinks, lavatories and condensate drains.

| Product No. | Size | Description | UPC | Ctn. Qty. |
|-------------|------|-------------------------------|--------------|-----------|
| 42754 | 2" | Bottom Aluminum Dome Strainer | 038753427546 | 1 |
| 42755 | 3" | Bottom Aluminum Dome Strainer | 038753427553 | 60 |
| 42756 | 4" | Bottom Aluminum Dome Strainer | 038753427560 | 48 |



Category 23

Rough-In Products and Tools

Count on Oatey® and MASTERS® rough-in products when you're tackling any plumbing job. Access Panels are great for allowing access to service areas for plumbing, electrical, security systems, telephone, computer cables, sprinkler systems and more. Can be flush or surface mounted. Tub protectors protect tub surfaces from debris during remodel or construction jobs. A wide variety of test caps are also available.

CATEGORY **23** ROUGH-IN PRODUCTS AND TOOLS



ROUGH-IN PRODUCTS



#38600 shown

Oatey® Quiet Pipes® STRAIGHT & WASHING MACHINE

- Eliminates water pipe banging caused by quick closing valves.
- Can be installed without opening any walls.
- Can be installed upside down or sideways.

| Product No. | Description | UPC | Ctn. Qty. |
|-------------|---|--------------|-----------|
| 34498 | Quiet Pipes Hammer Arrestor, 1/2" Male Sweat, Straight, AA | 038753344577 | 30 |
| 34458 | Quiet Pipes Hammer Arrestor, 1/2" CPVC Female, Straight, AA | 038753391779 | 30 |
| 34459 | Quiet Pipes Hammer Arrestor, 1/2" CPVC Male, Straight, AA | 038753344591 | 30 |
| 34460 | Quiet Pipes Hammer Arrestor, 1/2" F1960, Straight, AA | 038753344607 | 30 |
| 34461 | Quiet Pipes Hammer Arrestor, 1/2" F1807, Straight, AA | 038753344614 | 30 |
| 34463 | Quiet Pipes Hammer Arrestor, 3/4" Male Sweat, Straight, AA | 038753344638 | 30 |
| 39177 | Quiet Pipes Hammer Arrestor, 1/2" MIP, Straight, AA | 038753391779 | 6 |
| 38600 | Quiet Pipes Washing Machine Supply Line Shock Absorber, AA | 038753386003 | 6 |



Oatey® Quiet Pipes® PEX TEE

| Product No. | Description | UPC | Ctn. Qty. |
|-------------|---|--------------|-----------|
| 34472 | Quiet Pipes Hammer Arrestor, 1/2" PEX F1807 Tee, AA | 038753344720 | 30 |



Oatey® Quiet Pipes® COMPRESSION TEE

| Product No. | Description | UPC | Ctn. Qty. |
|-------------|--|--------------|-----------|
| 34473 | Quiet Pipes Hammer Arrestor, 1/4" O.D. Compression Tee, AA | 038753344737 | 30 |
| 34474 | Quiet Pipes Hammer Arrestor, 3/8" O.D. Compression Tee, AA | 038753344744 | 30 |



Oatey® Quiet Pipes® FEMALE COMPRESSION TEE

| Product No. | Description | UPC | Ctn. Qty. |
|-------------|---|--------------|-----------|
| 34475 | Quiet Pipes Hammer Arrestor, 1/4" O.D. Compression x Female Tee, AA | 038753344751 | 30 |
| 34465 | Quiet Pipes Hammer Arrestor, 3/8" O.D. Compression x Female Tee, AA | 038753344652 | 30 |
| 34467 | Quiet Pipes Hammer Arrestor, 5/8" O.D. Compression x Female Tee, AA | 038753344676 | 30 |

ROUGH-IN PRODUCTS



Oatey® Quiet Pipes® STRAIGHT MALE IRON PIPE

| Product No. | Description | UPC | Ctn. Qty. |
|-------------|--|--------------|-----------|
| 34481 | Quiet Pipes Hammer Arrestor, 1/2" MIP, Straight, A | 038753344812 | 12 |
| 34484 | Quiet Pipes Hammer Arrestor, 3/4" MIP, Straight, B | 038753344843 | 30 |
| 34485 | Quiet Pipes Hammer Arrestor, 1" MIP, Straight, C | 038753344850 | 24 |
| 34479 | Quiet Pipes Hammer Arrestor, 1" MIP, Straight, E | 038753344799 | 6 |
| 34480 | Quiet Pipes Hammer Arrestor, 1" MIP, Straight, F | 038753344805 | 6 |



Oatey® Quiet Pipes® STRAIGHT MALE SWEAT/PRESS FITTING

| Product No. | Description | UPC | Ctn. Qty. |
|-------------|---|--------------|-----------|
| 34499 | Quiet Pipes Hammer Arrestor, 1/2" Male Sweat/Press, Straight, A | 038753344867 | 30 |
| 34500 | Quiet Pipes Hammer Arrestor, 3/4" Male Sweat/Press, Straight, B | 038753344836 | 30 |
| 34501 | Quiet Pipes Hammer Arrestor, 1" Male Sweat/Press, Straight, C | 038753344874 | 24 |
| 34502 | Quiet Pipes Hammer Arrestor, 1" Male Sweat/Press, Straight, D | 038753344881 | 6 |
| 34503 | Quiet Pipes Hammer Arrestor, 1" Male Sweat/Press, Straight, E | 038753344898 | 6 |
| 34504 | Quiet Pipes Hammer Arrestor, 1" Male Sweat/Press, Straight, F | 038753344904 | 6 |



Oatey® Quiet Pipes® CPVC SOCKET ASTM D 2846

| Product No. | Description | UPC | Ctn. Qty. |
|-------------|--|--------------|-----------|
| 34491 | Quiet Pipes Hammer Arrestor, 1/2" CPVC Socket, Straight, A | 038753344911 | 24 |
| 34492 | Quiet Pipes Hammer Arrestor, 3/4" CPVC Socket, Straight, B | 038753344928 | 24 |
| 34477 | Quiet Pipes Hammer Arrestor, 1" CPVC Socket, Straight, C | 038753344775 | 12 |



Oatey® Quiet Pipes® ASTM PEX F1807 CRIMP & ASTM PEX F1960 GRIP

| Product No. | Description | UPC | Ctn. Qty. |
|-------------|--|--------------|-----------|
| 34482 | Quiet Pipes Hammer Arrestor, 1/2" F1807, Straight, A | 038753344829 | 12 |
| 34493 | Quiet Pipes Hammer Arrestor, 3/4" F1807, Straight, B | 038753344935 | 30 |
| 34494 | Quiet Pipes Hammer Arrestor, 1" F1807, Straight, C | 038753344942 | 24 |
| 34476 | Quiet Pipes Hammer Arrestor, 1/2" F1960, Straight, A | 038753344768 | 12 |
| 34495 | Quiet Pipes Hammer Arrestor, 3/4" F1960, Straight, B | 038753344959 | 30 |
| 34496 | Quiet Pipes Hammer Arrestor, 1" F1960, Straight, C | 038753344966 | 24 |



MASTERS® Inside Pipe Cutter

- Fast cutting of ABS & PVC pipe, closet flanges, tub waste & overflows, shower drains and sink rims (wood)
- Can be used with any drill and comes with a replacement blade for longer tool use
- Replacements blades also sold separately

| Product No. | Size | Description | UPC | Ctn. Qty. |
|-------------|------|--|--------------|-----------|
| PS-100 | 1.5" | MASTERS Inside Pipe Cutter Including Replacement Blade | 067001001795 | 60 |
| PS-102 | 1.5" | MASTERS Inside Pipe Cutter Replacement blade | 067001001917 | 60 |



MASTERS® Clamp or Cut

- Stainless steel cinch ring crimper - clamps (cinch) rings and cuts. Cutting feature activates with the spin of the activator pin so you don't have to search for another tool. Makes F1807 PEX connections fast.
- Ideal for new and re-routed supply lines or salvaging valves and fittings

| Product No. | Size | Description | UPC | Ctn. Qty. |
|-------------|--------------|----------------------|--------------|-----------|
| COC3810 | 0.375" to 1" | MASTERS Clamp or Cut | 067001003546 | 1 |



MASTERS® Crimpers

- Impact offset crimper with an 8" handle and a GO-NOGO gauge
- Can be used with Brass, Copper and Plastic fittings
- Adjustable for wear

| Product No. | Size | Description | UPC | Ctn. Qty. |
|-------------|-----------------|--|--------------|-----------|
| CM12 | 0.50" | MASTERS Crimper for F1807 Pex Pipe | 067001003508 | 1 |
| CM34 | 0.75" | MASTERS Crimper for F1807 Pex Pipe | 067001003515 | 1 |
| CM10 | 1.00" | MASTERS Crimper for F1807 Pex Pipe | 067001003522 | 1 |
| CM1234 | 0.50" and 0.75" | MASTERS Combo Crimper for F1807 Pex Pipe | 067001003539 | 1 |



MASTERS® Ringbuster

- Heavy duty PEX ring de-crimping tool will cut 1/2", 3/4" & 1" copper, brass and poly alloy/plastic fittings and tube
- Rounded anvil head doesn't fully close/connect allowing for fast cutting without damaging the inside or outside of the fitting, making the fittings reusable

| Product No. | Size | Description | UPC | Ctn. Qty. |
|-------------|---------------|--|--------------|-----------|
| 73015 | 0.50" to 1.0" | MASTERS Ringbuster for F1807 Pex Rings | 067001000767 | 1 |



MASTERS® Pliers

- Zinc plated, rubber gripped water pump pliers with a 2-1/8" jaw opening
- Grip tight clip keeps jaws in line, preventing unwanted locking and seizing

| Product No. | Size | Description | UPC | Ctn. Qty. |
|-------------|--------|--------------------|--------------|-----------|
| G253 | 2 1/8" | MASTERS Pliers 10" | 067001022172 | 10 |

ROUGH-IN PRODUCTS



Oatey® Access Panel

- Provides a service area for plumbing, electrical, security systems, telephone, TV, computer cables and sprinkler system applications.
- Eliminates costly repair.
- Special designed drill guides for cable or wire.
- Paint and wallpaper compatible.
- No lumber framing required. Ideal for new construction.
- Reversible outer frame allows for flush mounting.

| Product No. | Size | Description | UPC | Ctn. Qty. |
|-------------|----------------------------|--------------------------------|--------------|-----------|
| 34045 | 8" x 8" / 20.3 x 20.3 cm | Plastic Access Panel | 038753340456 | 6 |
| 34053 | 6" x 9" / 15.2 x 22.9 cm | Plastic Access Panel – Display | 038753340531 | 6 |
| 34055 | 6" x 9" / 15.2 x 22.9 cm | Plastic Access Panel | 038753340555 | 6 |
| 34056 | 14" x 14" / 35.6 x 35.6 cm | Plastic Access Panel | 038753340562 | 6 |
| 34059 | 14" x 14" / 35.6 x 35.6 cm | Plastic Access Panel – Display | 038753340593 | 4 |
| 34044 | 14" x 29" / 35.6 x 73.7 cm | Plastic Access Panel | 038753340449 | 6 |



Oatey® Foam Closet Spacer/Wrap

- Used to keep cement away from pipe penetrations during rough-in.
- Allows easy fitting installation after cement pour.

| Product No. | Size | Description | UPC | Ctn. Qty. |
|-------------|--------------------------|--------------------|--------------|-----------|
| 38711 | 4" x 4" / 10.2 x 10.2 cm | Foam Closet Spacer | 038753387116 | 60 |



Oatey® Toilet Base Plate

- Cover damaged and missing tile when replacing toilet.
- Manufactured from high impact ABS.

| Product No. | Size | Description | UPC | Ctn. Qty. |
|-------------|------|-------------------------------|--------------|-----------|
| 31258 | | Square Nose Toilet Base Plate | 038753312583 | 12 |
| 31259 | | Round Nose Toilet Base Plate | 038753312590 | 12 |



Oatey® Bath Tub Protector

- Offers protection against tub damage during home construction.
- A semi-flexible, heavy, high-impact plastic with deep-fluted sidewalls.
- Includes a non-skid foam pad to absorb shock and prevent scratched and dented tub finish.
- Nests for space-saving storage.

| Product No. | Size | Description | UPC | Ctn. Qty. |
|-------------|----------------------------|--|--------------|-----------|
| 34068 | 15" / 38.1 cm | 38.1 cm Deep/144.8 cm Long Fits 36.6 cm Tubs | 038753340685 | 35 |
| 34069 | 14" / 35.6 cm | Bath Tub Protector | 038753340692 | 35 |
| 34070 | 16" / 40.6 cm | Bath Tub Protector | 038753340708 | 35 |
| 34076 | 16" / 40.6 cm | Bath Tub Protector – Oval | 038753340760 | 25 |
| 34125 | 14" – 16" / 35.6 - 40.6 cm | Multi-Size Adjustable Bath Tub Protector | 038753341255 | 35 |



Oatey® Tub Box

- Provides a quick, economical and clean method of installing tub waste and drain.
- Built in cut-out for up to 2" Schedule 40 drain.
- Enables installer to form a clean cavity in a concrete slab so a trap can be easily connected to the drain system.
- Manufactured from semi-flexible, very durable, plastic polymer.
- Bottom I.D.: 11.5" x 11.5" / 29.2 x 29.2 cm. Top I.D.: 13" x 13", Depth 6.5" / 33 x 33 cm, Depth 16.5 cm.

| Product No. | Size | Description | UPC | Ctn. Qty. |
|-------------|------|------------------|--------------|-----------|
| 34080 | | Standard Tub Box | 038753340807 | 12 |



Oatey® TB-2000® Tub Box

- Provides a quick, economical and clean method of installing tub waste and drain.
- Built in cut-out for up to 2" Schedule 40 drain.
- Enables installer to form a clean cavity in a concrete slab so a trap can be easily connected to the drain system.
- Manufactured from semi-flexible, very durable, plastic polymer.
- Bottom I.D.: 11.5" x 11.5" / 29.2 x 29.2 cm. Top I.D.: 13" x 13", Depth 6.5" / 33 x 33 cm, Depth 16.5 cm.

| Product No. | Size | Description | UPC | Ctn. Qty. |
|-------------|------|-----------------|--------------|-----------|
| 34087 | | TB 2000 Tub Box | 038753340876 | 5 |



Oatey® Knock-Out™ Test Cap

- Solvent cements to Sch. 40 ABS and PVC DWV pipe.
- Deeper design provides stronger leak-free connections.
- "Tab" feature keeps hands free of solvent cement.
- Will withstand 10 PSI or 30' head pressure.

| Product No. | Size | Description | UPC | Ctn. Qty. |
|-------------|--------|------------------------------|--------------|-----------|
| 33460 | 1.5" | Knock Out Plug, ABS | 038753334608 | 100 |
| 33461 | 2" | Knock Out Plug, ABS | 038753334615 | 100 |
| 33462 | 3" | Knock Out Plug, ABS | 038753334622 | 50 |
| 33463 | 4" | Knock Out Plug, ABS | 038753334639 | 25 |
| 39100 | 1-1/2" | Knock Out Test Cap w/Barcode | 038753391007 | 20 |
| 39101 | 2" | Knock Out Test Cap w/Barcode | 038753391014 | 20 |
| 39102 | 3" | Knock Out Test Cap w/Barcode | 038753391021 | 15 |
| 39103 | 4" | Knock Out Test Cap w/Barcode | 038753391038 | 15 |



Oatey® End-Cap™ Test Cap

- Solvent cements to end of Sch. 40 ABS and PVC DWV pipe.
- Deep design provides extra sealing strength.
- Heavy duty design allows testing to 15 PSI or 40' head pressure.

| Product No. | Size | Description | UPC | Ctn. Qty. |
|-------------|--------|-------------------|--------------|-----------|
| 33468 | 1-1/2" | End-Cap™ Test Cap | 038753334684 | 100 |
| 33469 | 1-1/2" | End-Cap™ Test Cap | 038753334691 | 100 |
| 33470 | 2" | End-Cap™ Test Cap | 038753334707 | 100 |
| 33472 | 3" | End-Cap™ Test Cap | 038753334721 | 50 |
| 33473 | 3" | End-Cap™ Test Cap | 038753334738 | 50 |

ROUGH-IN PRODUCTS



Cherne® PVC Test-Kap® Plugs

- Stainless steel hose clamp won't corrode.
- For use on plastic, steel, copper and cast-iron pipe.
- Reinforced cross-molded top increases strength.
- Tighten clamp with torque wrench or screwdriver to 60 inch pounds.

| Product No. | Size | Description | UPC | Ctn. Qty. |
|-------------|--------|----------------|--------------|-----------|
| 270725 | 1-1/2" | Test-Kap® Plug | 675115270725 | 1 |
| 270733 | 2" | Test-Kap® Plug | 675115270732 | 1 |
| 270741 | 3" | Test-Kap® Plug | 675115270749 | 1 |
| 270768 | 4" | Test-Kap® Plug | 675115270763 | 1 |
| 270776 | 5" | Test-Kap® Plug | 675115270770 | 1 |
| 270784 | 6" | Test-Kap® Plug | 675115270787 | 1 |

Oatey SCS® Canada
145 Walker Dr. Unit #3, Brampton, Ontario, L6T 5P5 Canada
Phone: 800.321.9532
Fax: 800.321.9535
Oatey.ca