



CONNECT AND PROTECT

Fire Sprinkler Hanging & Bracing Products

Innovative Hanging & Bracing Fire Protection Solutions

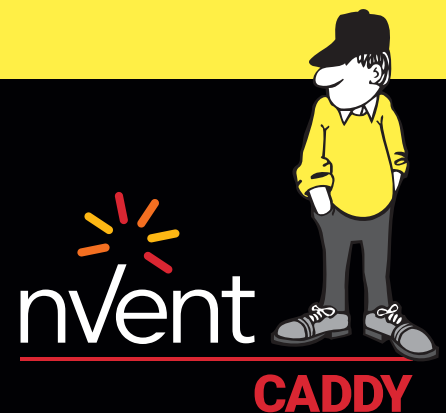





Table of Contents

nVent CADDY Fire Sprinkler and Seismic Bracing Solutions	4
Specifying a Trusted Solution – nVent CADDY Seismic Bracing Software	5
Building a Complete Solution with Engineering Support Services.....	5
What's New to nVent CADDY Rigid Seismic Bracing.....	6
What's New to nVent CADDY Cable Seismic Bracing	7
nVent CADDY Rigid Bracing System.....	8
nVent CADDY Branch Line Restraint System	9
nVent CADDY Cable Bracing System.....	10
Cable Bracing Accessories and Tools	11
What's New in Pipe Hanging and Support Solutions from nVent CADDY.....	12
nVent CADDY CPVC Hanging System	14
nVent CADDY Rod Lock	16
nVent CADDY Structural Attachments, Hardware and Anchors	20

See how easy it is to install our nVent CADDY products.

Watch videos on our fire and seismic applications.



nVent CADDY Fire Sprinkler and Seismic Bracing Solutions

To help ensure the availability and operation of safety systems after an earthquake event, many building and industry codes now include requirements for the design and installation of seismic sway bracing for non-structural components, such as fire sprinkler, mechanical, electrical and plumbing systems. The innovative line of nVent CADDY Bracing Systems was developed to help keep fire sprinkler systems intact after a seismic event and to minimize water damage resulting from leaks or ruptures.

Bracing Systems provide contractors with high-quality, engineered solutions, which include rigid bracing, cable bracing and rod stiffeners.

FEATURES:

- Quick and easy installation
- Lower total installed cost
- OSHPD® Pre-Approved
- cULus® Listed
- Meets NFPA® 13
- FM® Approved

Buy American Compliant Solutions are available.



Specifying a Trusted Solution – nVent CADDY Seismic Bracing Software



Now it's easier than ever to select the correct bracing products for use in fire protection applications. nVent CADDY Bracing Systems Calculator is a web-based calculator which allows users to create and save designs for multiple projects while providing the necessary submittal forms. This time-saving calculator simplifies the selection of products and provides the necessary engineering calculations – providing a complete solution to support rigid bracing, cable bracing and branch line restraints.

FEATURES:

- 3D models
- North American and European product lines
- No installation needed – access via a current web browser
- Offers dynamic design preview and uses visual design tools
- Generates a complete submittal for NFPA® or FM designs
- Create, manage, and re-use designs
- Supports NFPA® 13 including 2013 ed., IBC® and other building codes
- Ability to generate a material list (bill of material) with nVent CADDY products as well as other required materials (pipe, anchors, etc.)

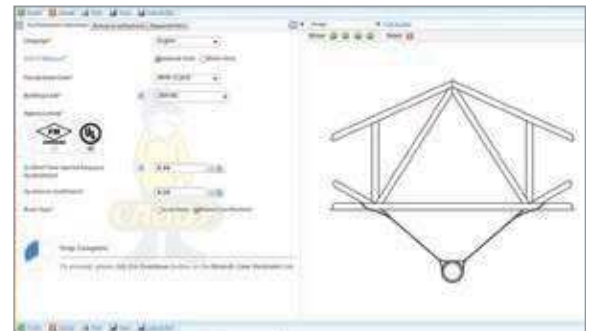

Building a Complete Solution with Engineering Support Services

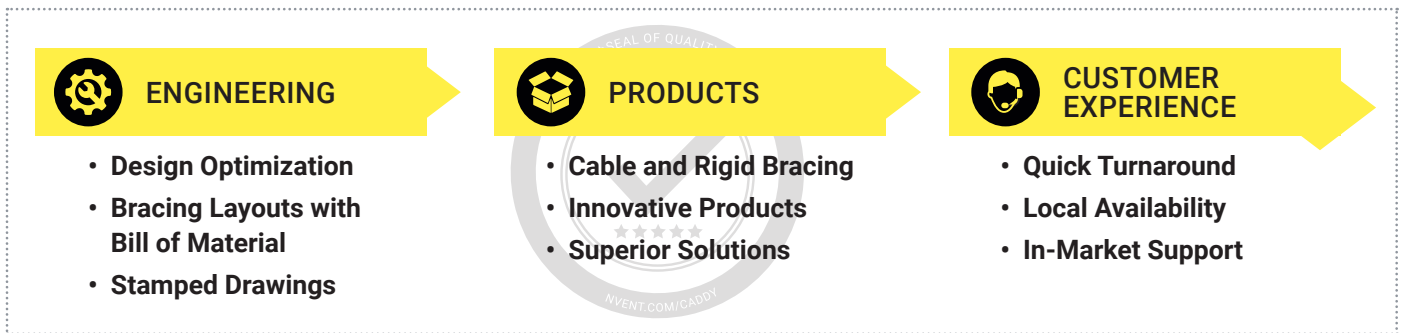

The nVent CADDY team makes seismic simple by:

- Working with you to design a turn-key, fully engineered, complete bracing system that meets your needs
- Identifying the appropriate products from the broad offering
- Offering compatible fixing, fastening and support products
- Explaining installation techniques and tips to meet the evolving codes and standards requirements

From design to construction to inspection, we keep our process transparent to ensure a full understanding of the final bracing installation, whether it requires cable or rigid bracing solutions.



What's New to nVent CADDY Rigid Seismic Bracing

nVent CADDY is the industry leader in seismic bracing solutions. From our clamps and brackets to innovations with telescoping solutions that fit any size application.

CSBS - STEEL FLANGE ADAPTER



Low profile easily fits into tight spaces



Includes spring retainer clip



Pre-assembled version available

CSB UNIVERSAL SWAY BRACE

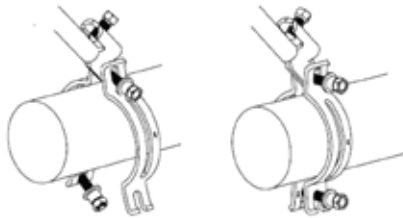

Used in both lateral and longitudinal sway brace applications, the unique slotted holes provide for an easy slip-on installation that eliminates loose hardware. Now featuring both snap-off nuts and bolt head, making installation and inspection of seismic sway braces a breeze.

CSBU UNIVERSAL STRUCTURAL BRACKET

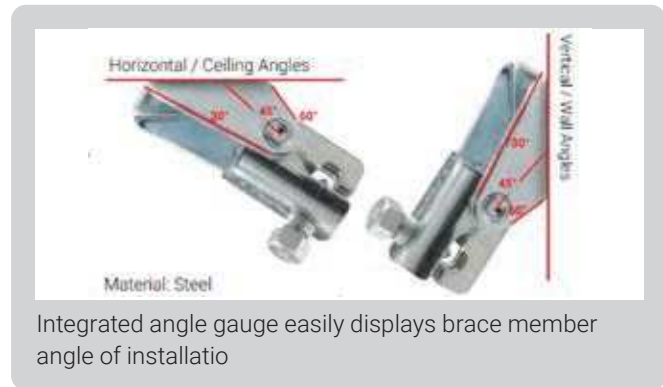

CSBT TELESCOPING LATERAL BRACE

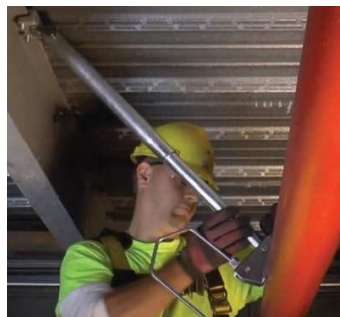

Learn how to reduce install time.

Watch our Lateral Telescoping Brace Assembly video.



This is a complete lateral brace solution that works with 1" to 4" service pipe, including CPVC. A telescoping brace member eliminates the need to measure and cut pipe and combines with a push-to-install v-bolt head making installations up to 80% faster than standard bracing.

CSBQG AND CSBIK QUICK GRIP LATERAL SWAY BRACES



These lateral braces feature an easy two-step installation that minimizes extra trips between structure and the service pipe. The unique quick attachment eliminates the need of cutting brace pipe to exact dimensions and accommodates both 1" and 1 ¼" brace pipe sizes in a single product.

Learn more about our Rigid Bracing Solutions on page 8.

What's New to nVent CADDY Cable Seismic Bracing

Cable Seismic Bracing is a NFPA® 13 approved solution that offers added design flexibility in instances where there are long drops from structure, a congested ceiling where access to structure is limited, and where a more visually integrated solution is needed in open ceiling construction.

- Effective end of branch line restraint to meet these newer requirements
- Compact, space saving solution, that is easy to move around job site

BATTERY OPERATED TOOL



Speeds and eases both bracing and branch line restraint installation. Provides consistent swaging and reduces the number of swages per sleeve compared to manual tools.



NO PRY CLIP



A structural attachment that maximizes the load capacity on a post-installed concrete anchor by neutralizing the prying effect from the cable load. This increases the allowable design load per anchor and results in the need for fewer bracing locations.

QUICK CLIP ROD STIFFENER

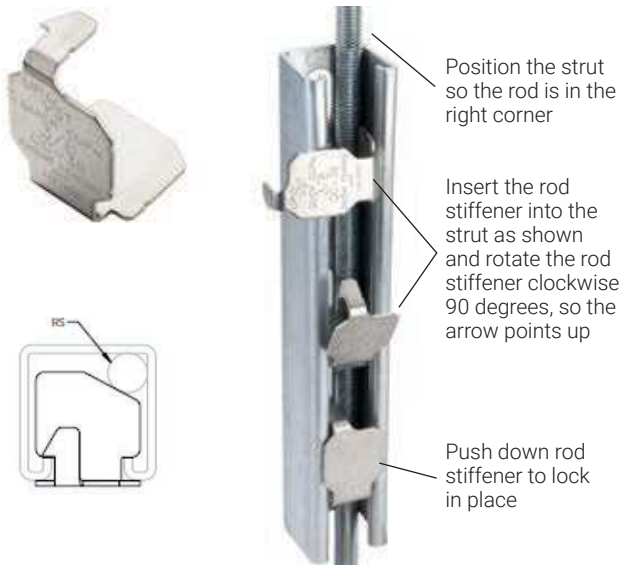

A tool-free rod stiffener that quickly and easily snaps into place, securing a threaded rod to a strut channel to prevent buckling from up thrust forces.

**Learn about our bracing tools.
Watch our Quick Clip Rod Stiffener video.**

Watch our Quick Clip Rod Stiffener video.



Learn more about our Cable Bracing Solutions on page 10.

nVent CADDY Rigid Bracing System

The nVent CADDY line of innovative rigid bracing products was designed to provide superior performance and meet the highest seismic load requirements. The products have been designed with the end user in mind and provide contractors with labor-saving features to promote quick and easy installation. The adjustable design can be used with different brace pipe sizes, providing flexibility on the jobsite and reducing contractor inventory. The system of products supports lateral and longitudinal bracing and offers a wide range of structural and pipe attachments.

FEATURES:

- Patent-pending lateral braces eliminate need for multiple trips up and down ladders
- Snap-off bolt heads help make installation and inspection quick and easy
- Single wrench size installs all products
- cULus® Listed and FM® Approved
- OSHPD® Pre-Approved (OPA-2629-10) to the 2010 California Building Code and (OPM-0062-13) to the 2013 California Building Code



Steel Flange Adapter
CSBS# (1,2)



Steel Flange Adapter Assembly
CSBS1A



Adjustable I-Beam Adapter
CSBS# (3,4,5)



Multi Attachment
CSBMA#####**



Universal Structural Bracket
CSBU# (1,2)



Universal Sway Brace
CSB#####



Lateral Telescoping Brace Assembly
CSBT#



Quick Grip Jr. Lateral Sway Brace
CSBQIKCL###EG



Quick Grip Lateral Sway Brace ("QG")
CSBQG###EG

= Sprinkler pipe size
** = Finish - ie EG
CSBQG**0400**EG = 4" pipe size,
Electrogalvanized

Buy American Compliant Solutions are available.



nVent CADDY Branch Line Restraint System

Traditional methods for installing branch line restraints in fire sprinkler systems are cumbersome and time-consuming. Contractors often cut (and re-cut) threaded rod to precise measurements to restrain the sprinkler pipe with a loop hanger and surge restraint. Traditional methods also commonly require five or more parts per restraint.

To avoid these labor-intensive methods, nVent CADDY has streamlined the process and developed the Branch Line Restraint System, part of the line of hanging and bracing solutions for the fire protection market. Ideal for restraining 1" through 2" branch lines, this innovative system is significantly faster and easier to install than current methods. It attaches directly to steel bar joists, I-beams or purlins, as well as concrete and wood structures. The hardware is installed with only one tool, a 5/16" socket drill driver, which provides significant labor savings and convenience. It features a simple, two-step installation process, allowing a time savings of up to 80% compared to other methods.

Unlike most solutions that only accept 3/8" threaded rod, the versatile Branch Line Restraint System features a swivel

attachment that can be rotated to accept 3/8" or 1/2" threaded rod. This allows greater restraint distances from the pipe to structure with 1/2" threaded rod.

The system meets the requirements of NFPA® 13, making it ideal for new construction applications. The total system is cULus® Listed and FM® Approved, and has been pre-approved by the state of California (OSHPD OPA-2629-10 & OPM-0062-13).

FEATURES:

- Complete restraint system includes structure and pipe attachments
- Works with 3/8" and 1/2" rod
- Quick and easy installation
- Meets NFPA® 13
- cULus® Listed and FM® Approved
- Pipe attachment includes snap-off heads help make installation and inspection quick and easy
- OSHPD® Pre-approved



WIDE RANGE OF STRUCTURAL ATTACHMENTS:



PIPE ATTACHMENT:



Branch Line Restraint
Pipe Attachment
CSBBRP####EG



Branch Line Restraint Structure
Attachment to Steel
CSBBS1EG



Branch Line Restraint Structure
Attachment to Wood/Concrete
(No seismic approval in concrete)
CSBBS2EG



Branch Line Restraint Structure
Attachment to Threaded Hole
(Concrete anchor, beam clamp,
through bolt steel)
CSBBS3EG

= Sprinkler pipe size

** = Finish - ie EG

CSBBRP**0150**EG = 1 1/2" pipe size, ElectroGalvanized

nVent CADDY Cable Bracing System

nVent CADDY Cable Bracing is an alternative to rigid bracing and branch line restraint for fire sprinkler systems and is very effective when bracing is required on long drops or when confined/crowded spaces make rigid systems difficult to install. The system includes pre-stretched steel cable, attachment fittings, crimping sleeves and related tools. The system can also be used to brace electrical, mechanical and plumbing systems.

FEATURES:

- Color-coated cable conforms to NFPA® 13 requirements and makes it highly visible and easier to identify cable sizes
- UL® Listed
- OSHPD® Pre-Approved (OPA-0619)
- Made in the USA



#12 CABLE



Cable Spool
CSB12CBL**



URC Attachment Kit
CSB2W12URC38L12 ##



Wire Rope Cutter
SLWC

#18 CABLE



Cable Spool
CSB18CBL**



URC Attachment Kit
CSB2W12URC38L18 ##



Wire Rope Cutter
SLWC

Stainless steel options are available in cable bracing for high corrosion and outdoor applications.

#36 CABLE



Cable Spool
CSB36CBL**



URC Attachment Kit
CSB2W12URC38L36 ##



Cable Cutter
CSBC48

Cable Bracing Accessories and Tools

Install with confidence when you complete any cable bracing product offering with our supporting line of tools and accessories. Knowing you are using the right tools eliminates guesswork and rework on any project.

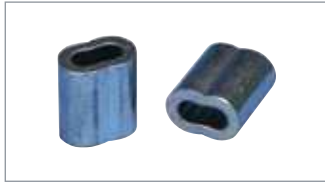

Crimping Sleeve
CSB##SLVB**



No Pry Clip
CSBNPC##



Universal Restraint Clip
CSBURC###**



Universal Restraint Clip, Retrofit
CSBURCR##



Strut Seismic Hinge
CSBSH#####**



Pipe Rod Stiffener
CSBRS1



Strut Rod Stiffener
CSBRS37EG



Quick Clip Rod Stiffener
CSBRS#



Shear Bolt
**CSBBARJSB50EG,
CSBIBSB50EG,
CSBUNIVSB62EG**



Shear Nut
**CSBQIKCLSN37EG,
CSBIBSN37EG**



Self Drilling Screw
CSBTS1

= pipe size with multiple sizes available
****** = Finish - ie EG, SS for Stainless
CSBSH**00500**EG = 9/16 hole size, Electrogalvanized

CUTTING AND SWAGING TOOLS



Manual Swaging Tool
CSB12SBHS

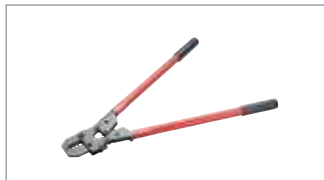

Multi-Size Manual Swaging Tool
CSB3346SB



Battery-Operated Swaging Tool
CSBB121836

Works with Brace
Size 12

Works with Brace
Size 12, 18, 36

Works with Brace
Size 12, 18, 36

Learn more about nVent CADDY cable bracing accessories by visiting our YouTube Channel.

Watch our Single Pipe Cable Bracing video.

Watch our Quick Clip Rod Stiffener video.



What's New in Pipe Hanging and Support Solutions from nVent CADDY

Pipe hangers have often been difficult to differentiate between brands, historically. Products on the market adequately hold pipe, but have not undergone any innovation in decades. However, the nVent CADDY product development team is always working to make products faster, safer and easier to install. Our family of products offers unique benefits to the installer and together they are designed to be the most comprehensively innovative offering on the market.



100T HEAVY DUTY TRAPEZE LOOP HANGER

- Provides flexibility for installation in tight spaces and adaptability in system design
- NFPA®-compliant as a trapeze solution
- UL® Listed and FM® approved as both hanger and structural attachment
- Supports up to 8" diameter pipe
- Ideal for suspending stationary non-insulated lines from existing services
- Perfect for when you have limited or no access to traditional structural members
- Installs easily in orientations such as parallel to an I-beam or bar joist



DROP-IN LOOP HANGER

- Next generation loop hanger revolutionizes the installation of pipe
- Once on the guide arm, the weight of the pipe opens the self-closing latch and effortlessly guides the pipe into place
- Integrated rubber sleeve is designed to provide additional grip when adjusting hanger height and reduce hanger rotation around the barrel nut
- Eliminates the need to disassemble the hanger during installation

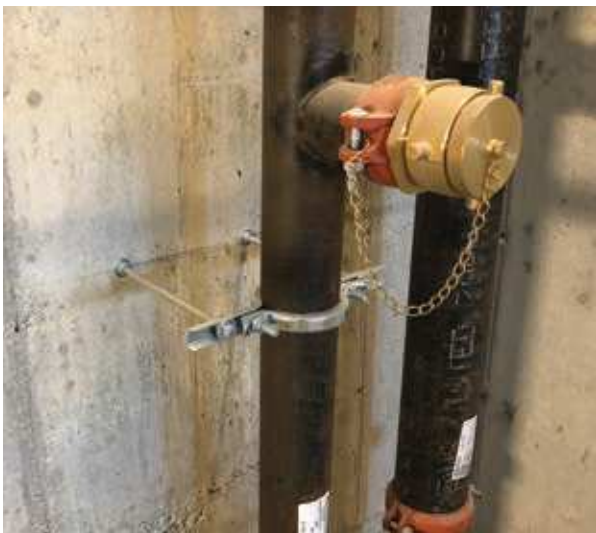

EZ RISER

- Support vertical pipe quickly and easily by combining three parts into one: a standard riser; a short ear riser; and a stand-off support
- Ready to install out of the box with patented hinge single-piece design
- Single tool installation made possible by carriage bolts eliminating the need for multiple tools when tightening
- Installs up to 60% faster than standard riser clamps (5 EZR's for every 2 traditional riser)
- MSS SP58 compliant and UL® Listed for fire protection applications
- Easily modified to short ear riser for use in tight spaces while retaining UL® listing
- Independent set of bolt holes allow for safer and easier installation in stand-off applications by separating clamping force from offset adjustment

nVent CADDY Pipe Hangers

nVent CADDY Pipe Hangers make any installation job easier with select products compatible with our surge restraint system and that feature contractor-requested finishing techniques, including rolled edges and adjustable drop clearance.



115 Standard Duty Loop Hanger
115####**



100T Heavy Duty Trapeze Loop Hanger
100TXXXEG



Drop In Loop Hanger
DH####EG



Surge Restraint
SR6



DH Surge Restraint
SR####EG



Insert Nut For Loop Hanger
100X00XX**100**



Yook Hanger
135####**



105 Stainless Steel Loop Hanger
105####S*



401 Galvanized Clevis Hanger
401####**



410 Light Duty Clevis Hanger
410####EG



EZ Riser
EZR####



512 EZ RISER for Close Quarters
512####EG



510 EZ RISER
510####**



455 Malleable Split Ring Hanger
455####**



456 Malleable Split Ring Hanger for Copper Tube
456####CP

= pipe size
** = Finish - ie EG
115**0400**EG = 4" pipe size, Electrogalvanized



Learn more about nVent CADDY pipe hanging and support solutions by visiting our YouTube Channel.

Watch our Drop-In Loop Hanger video.
Watch our EZ Riser video.



nVent CADDY CPVC Hanging System

nVent CADDY provides multiple options for hanging CPVC pipe. We provide mounting screws with all straps and restraints to save you time on the job.



SOSR TWO HOLE STAND OFF STRAP

- Includes flared edges to protect piping
- Rated for use with CPVC fire sprinkler pipe
- Positions pipe 1-1/2" off the mounting surface eliminating the need for wooden spacer blocks
- Can be mounted in both vertical and horizontal positions on concrete, steel and wood
- Meets the UL® 203 stringent upward thrust requirement
- UL® Listed as both a hanger and pipe restrainer
- Complies with static load requirements of NFPA® 13
- Includes mounting screws
- Can be used with 3TW backing nut on composite wood joist installations



DOSR DOUBLE OFFSET SURGE RESTRAINT

- Provides quick and easy snap-in installation of pipe
- Built-in nail tab allows for fast, temporary mounting to any surface
- Rated for use with CPVC fire sprinkler pipe
- Positions pipe 1-1/2" out and up from the mounting surface eliminating the need for wooden spacer blocks
- Meets the UL® 203 stringent upward thrust requirement
- UL® Listed as both a hanger and restraint in the double offset orientation
- Complies with static load requirements of NFPA® 13
- Includes mounting screws
- Can be used with 3TW backing nut on composite wood joist installations



MACROFIX PLUS NI EZ WITH EASY CLOSURE

- Contains easy closing mechanism
- Plastic washers help prevent crushing the CPVC or plastic pipe and assure a floating fit
- Flared edges and specially designed welding area help protect CPVC piping
- Ideal for installations where space is limited and require services to be ran close to the attachment surface
- Suitable for 3/4" - 2" steel sprinkler pipe
- Eliminates the need to seismically brace when drops are kept within 6" of the attachment surface
- Combo head bolt works with slotted, hex, or Phillips drivers
- Conforms with Manufacturers Standardization Society (MSS) SP-58 (Type 12)
- Meets the UL® 203 stringent upward thrust requirement
- UL® Listed as both a hanger and pipe restrainer



107 Wraparound Strap for CPVC Pipe
107####EG



108 2-Hole Strap for CPVC Pipe
108####EG



109 Side Mount Strap for CPVC Pipe
109####EG



SOSR Stand Off 2-Hole Strap for CPVC Pipe
SOSR###



DOSR Double Offset Surge Restraint for CPVC Pipe
DOSRXXX

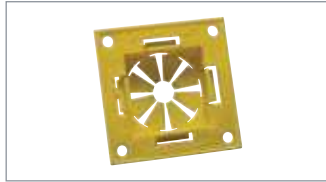

Easy Snap Grommet for Factory Punched Holes
ESGFP

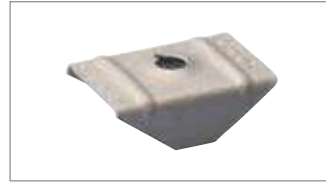

3TW Fastener for SOSR Series wood screw backing nut
3TW



Snap-On Nail Plate
304B2



Macrofix Plus NI with Easy Closure
429####EG



Easy Snap Grommet
ESG1

= pipe size ** = Finish - ie EG
SOSR100 = 1" pipe size, ElectroGalvanized



nVent CADDY provides Seismic Bracing Solutions for CPVC pipe.

Register for access to our Bracing Systems Calculator to configure and plan for all your bracing needs.



nVent CADDY Rod Lock

The Rod Lock family of products allows contractors to prefabricate complex assemblies at ground level or offsite, and then easily lift and lock them into place by pushing the threaded rod supports into the Rod Lock device. This ingenious technology works with threaded rod with burrs or imperfections, helping to eliminate clean-up time or the need to replace damaged threaded rod.

The most unique feature of the system is its breakthrough “push-to-install” design, which dramatically reduces the installation time of threaded rod support structures when compared to conventional fasteners. Simply speaking – Rod Lock is revolutionizing how contractors support conduit, cable tray, lights, ductwork and pipe by helping to make installations faster, easier and more secure.

FEATURES:

- Ideal for complex, multi-tier and multi-service applications
- Lift and lock into place without turning threaded rods
- Available for prefab assemblies





Rod Lock Beam Clamp
CRLB37EG



Rod Lock Beam Clamp,
Thick Flange
CRLB50EG



Rod Lock Metal Decking
Preset Anchor
CRLM##EG

= threaded rod size
** = Finish - ie EG
CRLB37EG = 3/8 rod size,
ElectroGalvanized



Rod Lock Metal Decking Preset
Anchor Insert
CRLMIP



SNSW Flanged Nut
SNSW##



Rod Lock Anchor Screw
CRLA37EG



Rod Lock Plywood
Form Preset Anchor
CRLW##EG



Rod Lock Nut
CRLN##EG



SN Series Nut
SN##



Rod Lock Channel Nut
CRLS37EG



Rod Lock L-Bracket
CRLL37EG



Rod Lock Strut, Perforated
CRLP##L##



Rod Lock Telescoping
Strut Replacement
TSR200##RL



Rod Lock Height-Adjustable
Strut Nut
CRLSL37EG



Rod Lock Coupler
CRLC37EG

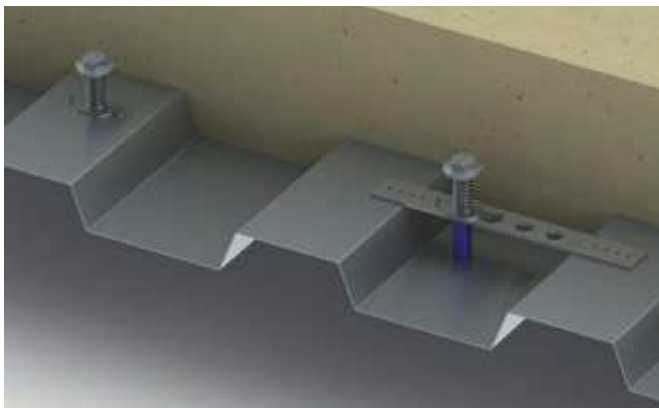

Learn more about nVent CADDY Rod Lock by visiting our
YouTube Channel.

Watch our Rod Lock videos.



nVent CADDY Truss-T Hanger / Joist Hangers

Adapt – with just a twist. The nVent CADDY Truss-T Hanger is an innovative solution that increases jobsite efficiency by quickly adapting to recommendations of bar joist manufacturers. Easily hang with top or bottom chord configuration and replace the use of fender washers and hex nuts typically used today.

Quickly attach threaded rod to a top or bottom chord of engineered open web bar joists with the nVent CADDY Truss-T Hanger. The attachment easily slides through the middle of the bar joist and quickly locks into place when put under load, limiting overhead work.

FEATURES:

- Installation of the complete, self-contained system can be accomplished with one hand and requires no additional special tools
- The unique design of the nVent CADDY Truss-T hanger does not need to be tightened like a traditional beam clamp, providing greater adjustability and speed during system alignment
- Meets the UL® 203 requirement
- Centrally loading the bar joist chord eliminates torsion and/or distortion, adhering to the strict rules established by the Steel Joist Institute (SJI)

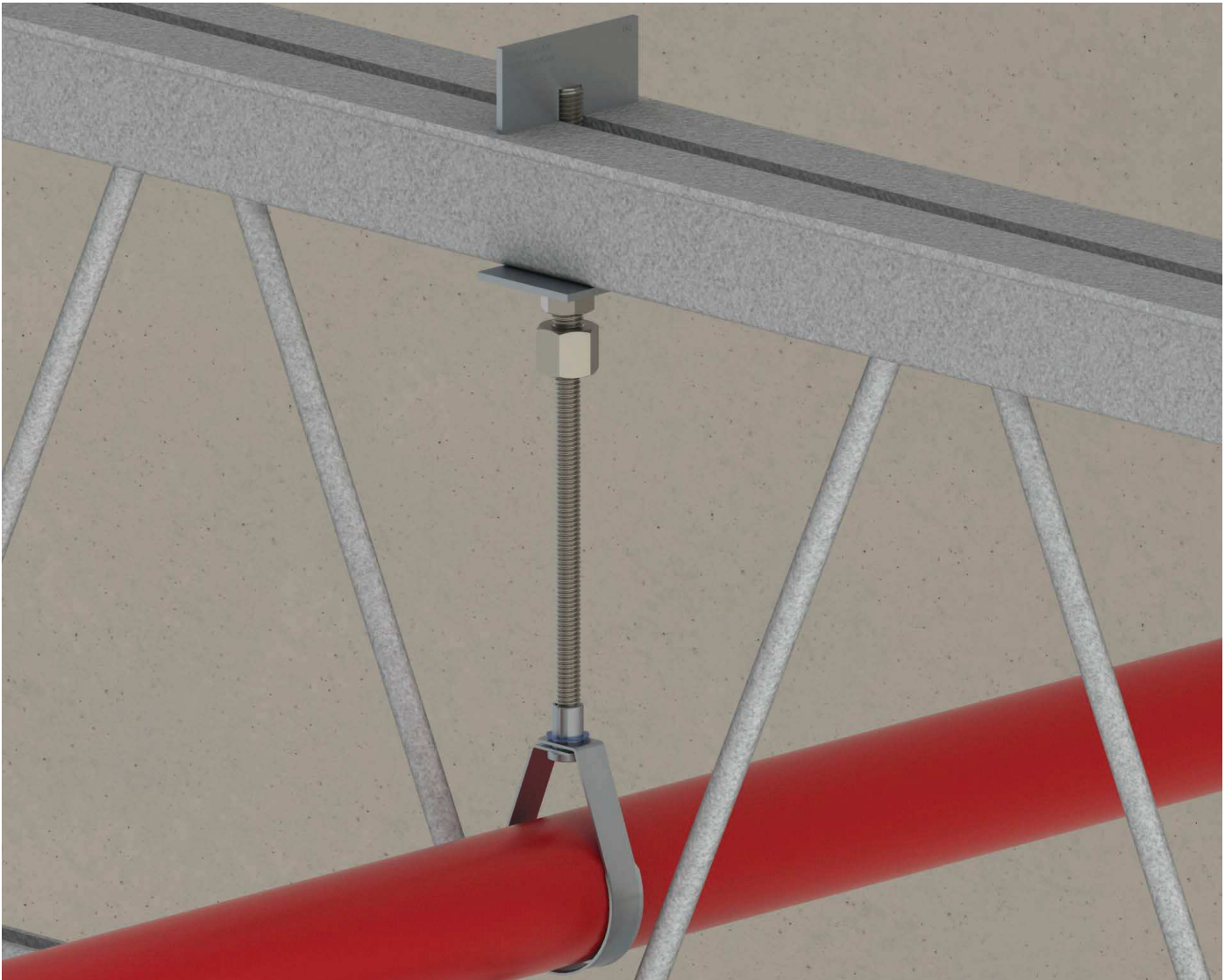

Truss-T Bottom Chord
CTH###BC



Truss-T Top Chord
CTH###TC



Rod Lock Hanger
CRLJ37EG

nVent CADDY Telescoping Pipe Stand

Reduce fabrication and install time with the nVent CADDY Telescoping Pipe Stand. The V-Head design supports pipe diameter of 1" through 24" and can easily adjust up to 16" in height, allowing you to quickly adapt to support needs in the field.

FEATURES:

- Ideal for the support of pipe in back flow preventers and pump rooms
- Push to install V-bolt fastener accommodates multiple pipe sizes (1" to 10")
 - CTS04 supports 1" to 8" Pipe if the v-bolt is not used
 - CTS10 supports 5" to 24" Pipe if the v-bolt is not used
- Electro-galvanized finish is standard and provides corrosion protection
- Two methods of height adjustment for both large and fine changes



Telescoping Pipe Stand
CTS04



Telescoping Pipe Stand
CTS10



For applications where the pipe diameter is larger than the v-bolt, a combination of strut and strut clamps/standard U-bolt can be used to secure the pipe.



Learn more about our innovative hanger solutions.

Watch our Truss-T Hanger video.
Watch our Telescoping Pipe Stand video.



nVent CADDY Structural Attachments, Hardware and Anchors



SBC STAMPED BEAM CLAMP, TOP MOUNT

- Allows structural attachment to metal beams, bar joist, channel, or angle iron in top mount position only unless used on a parallel flange
- Superior pre galvanized finish available at cost comparable to plain finish cast beam clamp
- Lightweight, one-piece stamped body provides superior strength and eliminates deficiencies associated with castings
- Spins onto threaded rod and allows for easy adjustment
- Made in the USA



PHSW MULTI-PURPOSE PURLIN CLAMP WITH SWIVEL

- Attachment to bottom of purlins and beams to support threaded rod
- Swivel feature option for attachment to purlins under sloped roofs



RS RETROFIT RETAINER STRAP

- Can be installed without disassembly of the hanging system and/or removing the clamp
- Large teardrop-shaped opening is compatible with multiple threaded rod diameters, reducing inventory by 50%
- Coined edge on teardrop-shaped opening locks into rod, eliminating shifting during install
- Complies with NFPA® requirements and meets the UL® load test for retainer straps (3/8" and 1/2" rod sizes)



SBC Stamped Beam Clamp,
Top Mount
SBC037 / SBCM10



300 Universal Beam Clamp
300####**



310 Universal Beam Clamp,
Wide Mouth
310####**



305 Stainless Steel
Top-Mount Beam Clamp
305####S*



PH Multi-Purpose
Purlin Clamp
PH6FP



PHSW Multi-Purpose
Purlin Clamp with Swivel
PHSW6FP



315 Malleable Iron
Purlin Clamp
315####**



Truss-T Top Cord
CTH##TC



35RS Two Hole
Retainer System
035RS####EG



RS Retrofit Retainer Strap
RS##



Rod Lock Coupler
CRLC37EG



Rod Lock Coupler with Rox
CRLC##L#

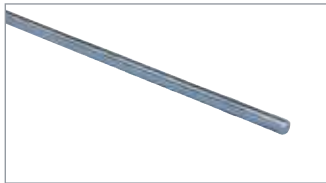

Threaded Rod
050####**



EM-HEX Rod Coupler
025####EG



25R Hex Rod Reducer
025R####EG



150M Standard U-Bolt
150M####**



42 Hex Head Lag Screw
042####EG



43 Wood Drive Screw
043####EG



80 Tie Bolt
080####PL

= Multiple sizes available,
** = Finish - ie EG
050**3710**EG = 3/8 rod size, 10'
length, ElectroGalvanized
150M**040**PL = 4" pipe size



nVent CADDY Structural Attachments, Hardware and Anchors

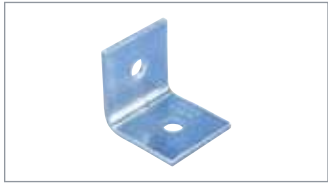

325 Steel Side Beam Attachment
325####**



327 Malleable Iron Side Beam Attachment
327####**

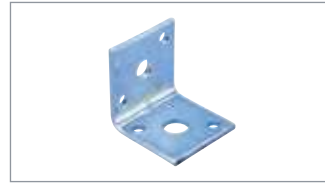

326 Universal Steel Side Beam Attachment
326####**



329 Side Beam Attachment
3290037EG

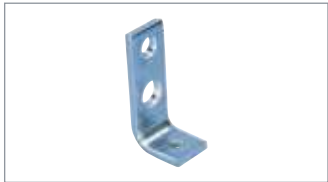

328 Threaded Steel Side Beam Attachment
328####**



Rod Lock L-Bracket
CRL37EG



37 Steel Eye Socket Rod Hanger
037####**



38 Offset Steel Eye Socket Rod Hanger
0380037EG



365 Steel Wall or Ceiling Plate
365####**



365M Malleable Iron Wall or Ceiling Plate
365M####**



352 Standard Duty Welded Wall Bracket
352####**



353 Heavy Duty Welded Wall Bracket
353####**



370A Single Concrete Insert Plate and Rod
370A####**



355 Concrete Insert Plate
355####**

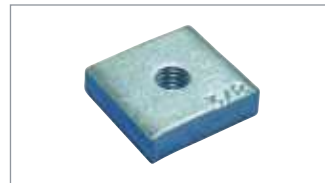

355N Nut for 355 Series
355N####**



Rod Lock Metal Decking Preset Anchor,
CRLM##EG



Rod Lock Plywood Form Preset Anchor,
CRLW##EG



Rod Lock Metal Decking Preset Anchor Insert,
CRLMIP



SWFF Swivel Female-Female
SWFF####EG



SWMF Swivel Male-Female
SWMF####EG

= Multiple sizes available,
** = Finish - i.e. EG
3280037EG = 3/8" rod size, EG finish



Rod Lock Anchor Screw
CRLA37EG

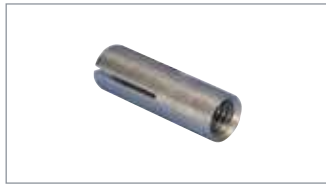

Drop-In Anchor
CA####EG



Flanged Drop-in Anchor
LA####EG



Spike Anchor
RAWL####



Wedge Expansion
Anchor Bolt
CSBCAB#####EG



Concrete Anchor Screw
CSBCAS#####EG



Screw Drill Bits
CSBCASDB#####



HangerMate® Vertical
Mount Screw for Steel
HMZG###



HangerMate® Vertical Mount
Screw for Steel with Lock Nut
HMZG471



HangerMate® Horizontal
Mount Screw for Steel
HMZH###



HangerMate® Horizontal Mount
Screw for Steel with Lock Nut
HMZH476



HangerMate® Vertical Mount
Screw for Wood
HMZG###



HangerMate® Horizontal
Mount Screw for Wood
HMZH665



HangerMate® Vertical Mount
Screw for Concrete
HMZG###



HangerMate® SDS Drill Bit
for Hammer Drills
HMZE###



HangerMate® Drill Bit Adaptor
HMZE240



HangerMate® Tanged Drill Bit for
Hammer Drills
HMZE340



HangerMate® Hex Drive Socket
HMZE215



HangerMate® Drive Sleeve
HMZE220

= Multiple sizes available
CA**0025**EG = 1/4" rod size
CSBCAB**060062**EG = 6" length,
5/8" screw dia.

Built for Projects, Designed for People

FOUNDED IN THE USA, SUPPORTED WORLDWIDE



Founded in 1956
in Solon, Ohio

With a commitment to serving the customer with the best products on the market, the nVent CADDY team maintains visibility into the manufacturing process from start to finish.

nVent CADDY was founded and is based in the United States, but has a wide global footprint with manufacturing plants throughout the United States, the Netherlands, France, and other regional hubs.

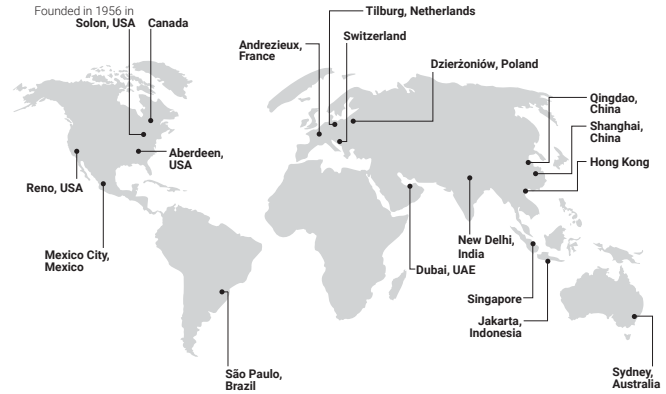

YOUR TEAM IS OUR TEAM

For decades, our product development team has worked with contractors on job sites to understand their challenges and frustrations. The team then applies these observations, developing solutions fitting contractor needs, including ways to reduce time, increase ease of and overall installation. Once a product is developed, the team validates it in the field with our customers. Over the years, nVent CADDY has created a unique relationship with our customers, even creating products named for our most loyal.

nVent CADDY application engineers and product developers spent over 330 days (and counting!) in the field identifying new ways to create efficiencies and end-user value.

THE BEST TRAINING FOR THE BEST PRODUCTS

nVent CADDY has opportunities for customers to participate in nVent CADDY School, a training session that takes place several times a year, walking users through product installation and benefits. nVent CADDY is also investing in the future by supporting new apprentices as well as those with many years in the field. The nVent CADDY team gets out of the office and into the field to do on-site training and demos for customers as well.



See what gear you can earn through the nVent CADDY Stuff Contractor Appreciation program!

Visit the Partners section on erico.com or contact your sales rep to get started.



Customer-Inspired Solutions



nVent CADDY's team of experts take the time to create solutions with the customer and their challenges in mind, as well as trends in the current market. Hours of research, product development and engineering goes into the nVent CADDY products customers know and love.

nVent CADDY products help customers solve problems by creating solutions for their biggest obstacles.



BUILDING CODE REQUIREMENTS



PROJECT CHALLENGES



ENVIRONMENTAL FACTORS



FIRE SAFETY



CRITICAL EQUIPMENT PROTECTION

nVent CADDY products solve for these challenges and more, while being engineered to be:



SAFE

Many injuries on the job site are the result of falls. nVent CADDY products are designed to move a significant amount of the work previously completed on lifts and ladders to ground level, greatly reducing the risk of injury. Tool-free components also limit the use of potentially dangerous power tools.



FAST

Every part of an nVent CADDY product is meticulously designed to reduce the amount of total installation time. This is done by making the product install quicker than its traditional counterpart as well as creating products that make it easy to prefabricate complex assemblies on the ground or offsite. Limit rework after installation and meet jobsite deadlines using innovative nVent CADDY products.



EASY

nVent CADDY products are designed to incorporate features that make installation easier. nVent CADDY products are designed to have fewer parts, secure hardware and require fewer tools. The benefits of individual products are multiplied when used together as a system solution.

Products to fit most applications including:

**ELECTRICAL • DATACOM • FIRE SPRINKLER • MECHANICAL
HVAC • PLUMBING • ROOFTOP • SEISMIC BRACING**

Learn More About nVent CADDY

Contact your sales representative for our product catalogs and additional resources, in print and online!

OUR PRODUCT CATALOGS



Fixing, Fastening & Support Products

For Electrical Installation and Datacom & Telecom Applications

Find our largest product offering in our pocket guide.

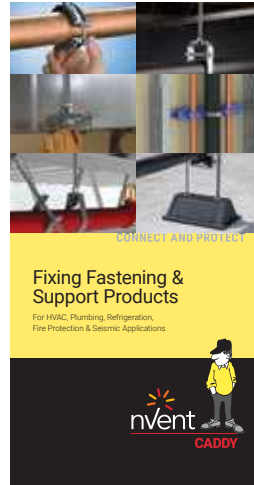

Fixing, Fastening & Support Products

For HVAC, Plumbing, Refrigeration, Fire Protection & Seismic Applications

Find our largest product offering in our pocket guide.

FIND OUR ONLINE RESOURCES



Visit our online resources to learn more about nVent CADDY solutions and products. The website houses brochures, catalogs, product specifics, videos and more.

Additional resources available include:

- Product information
- Specifications
- Project calculators
- Installation resources
- Product installation videos and more



Find us on LinkedIn



Find us on Facebook



Find us on YouTube

Find us online at:

www.erico.com

Visit our blog:

blog.nVent.com/category/caddy/

Ready to get started with nVent CADDY?

Contact your local sales rep or visit the [Contact Us](#) page on erico.com.

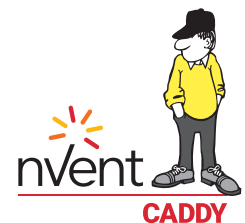



Our powerful portfolio of brands:

CADDY ERICO HOFFMAN RAYCHEM SCHROFF TRACER



[nVent.com/CADDY](https://www.nVent.com/CADDY)