



801 STANDARD PIPE STAY, 0.921" OD, 1/2" PIPE, 3/4" COPPER TUBE

CATALOG NUMBER

801050075EP



FEATURES

Used for water, heat or gas lines

PRODUCT ATTRIBUTES

Material: Steel

Finish: Epoxy Powder Coated

Outer Diameter: 0.921"

Pipe Size: 1/2"

Copper Tube Size: 3/4"

Hole Size: 5/16"

A: 2 1/4"

B: 1 3/4"

DIAGRAMS

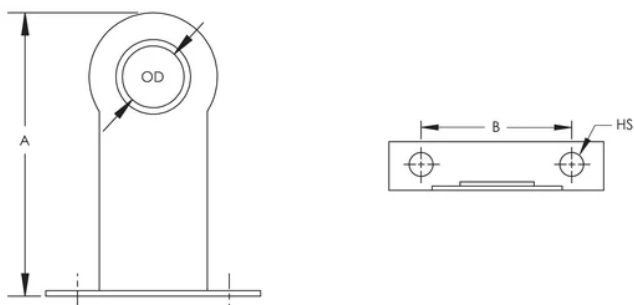

WARNING

nVent products shall be installed and used only as indicated in nVent's product instruction sheets and training materials. Instruction sheets are available at www.nvent.com and from your nVent customer service representative. Improper installation, misuse, misapplication or other failure to completely follow nVent's instructions and warnings may cause product malfunction, property damage, serious bodily injury and death and/or void your warranty.

North America

+1.800.753.9221

Option 1 – Customer Care

Option 2 – Technical Support

Europe

Netherlands:

+31 800-0200135

France:

+33 800 901 793

Europe

Germany:

800 1890272

Other Countries:

+31 13 5835404

APAC

Shanghai:

+ 86 21 2412 1618/19

Sydney:

+61 2 9751 8500



Our powerful portfolio of brands:
nVent.com **CADDY ERICO HOFFMAN RAYCHEM SCHROFF**
TRACER