



NVENT CADDY SPEED LINK SLK WITH THREADED STUD END, 1.5 MM WIRE, 9.9' LENGTH, 1/4" ROD

CATALOG NUMBER

SLK15L3SE250



CERTIFICATIONS



FEATURES

- Complete system includes wire, locking device and pre-assembled threaded stud end fitting
- Attaches to structures with threaded anchors or devices with threaded hole
- Connects directly to threaded devices in trapeze assemblies, light fixtures, HVAC assemblies or signage

PRODUCT ATTRIBUTES

- Material: Steel;Polypropylene;Zinc Alloy
- Finish: Electrogalvanized
- Static Load Safety Factor: 5:1
- Complies With: SMACNA HVAC-DCS
- Wire Rope Diameter: 1.5 mm
- Wire Rope Length: 9.9'
- Rod Size: 1/4"

Screw Length: 1"

Height: 2.150"

Width: 3/4"

Thickness: 1/2"

Angle: 90° Max

Static Load: 44 lb

DIAGRAMS

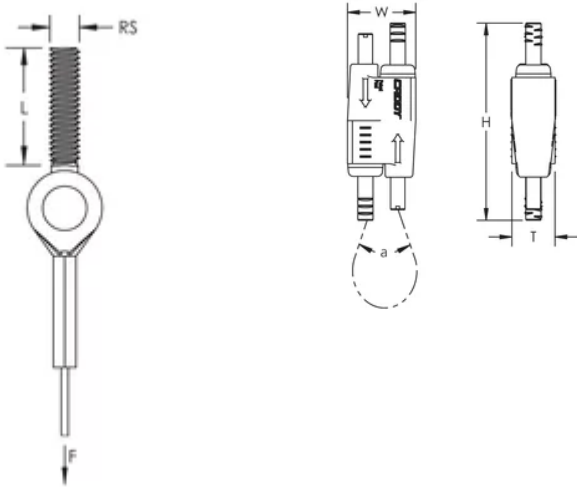

WARNING

nVent products shall be installed and used only as indicated in nVent's product instruction sheets and training materials. Instruction sheets are available at www.nvent.com and from your nVent customer service representative. Improper installation, misuse, misapplication or other failure to completely follow nVent's instructions and warnings may cause product malfunction, property damage, serious bodily injury and death and/or void your warranty.

North America

+1.800.753.9221

Option 1 – Customer Care

Option 2 – Technical Support

Europe

Netherlands:

+31 800-0200135

France:

+33 800 901 793

Europe

Germany:

800 1890272

Other Countries:

+31 13 5835404

APAC

Shanghai:

+ 86 21 2412 1618/19

Sydney:

+61 2 9751 8500



Our powerful portfolio of brands:
nVent.com **CADDY ERICO HOFFMAN RAYCHEM SCHROFF**
TRACER