



THE FURNACE

OWNER'S MANUAL

SFE | SFEX | SFECM | ELECTRIC FURNACE



INS-SFE-0520

THANK YOU FOR YOUR PURCHASE!
NEED ASSISTANCE? CONTACT STELPRO CUSTOMER SERVICE.

WWW.STELPRO.COM
CONTACT@STELPRO.COM
1-844-STELPRO



IMPORTANT INSTRUCTIONS

TAKE A FEW MINUTES TO READ THE FURNACE'S INSTALLATION GUIDE
TO ENSURE AN EASY AND SAFE INSTALLATION.

WARNING

If these instructions are not followed, the warranty will be considered null and void and the manufacturer deems no further responsibility for this product.

This product must be installed by a qualified person and connected by a **certified electrician**, according to the **electrical and building codes** effective in your region.

The following instructions must be adhered to in order to avoid personal injuries or property damages, serious injuries and potentially fatal electric shocks.

1. Make sure that all screws and electrical terminal connections are tightly secured before operating the unit in case they would have loosened during transportation.
2. Protect the heating unit with the appropriate circuit breaker or fuse, in accordance with the nameplate.
3. Make sure the line voltage (volt) is consistent with that indicated on the unit's nameplate.
4. This unit must be **grounded**.
5. Switch off the power at the circuit breaker/fuse before installing, repairing and cleaning the unit.
6. Make sure the unit is appropriate for the intended use (if needed, refer to the product catalog or a representative).
7. If the unit's capacity is insufficient for the size of the house, it will be in operation continuously, and may become prematurely defective.
8. **Respect distances and positions** indicated in the installation section.
9. If the installer or the user modifies the unit, they will be held responsible for any damage resulting from this modification, and the CSA certification could be void.
10. This unit must not come into contact with a water source and must be protected from splashes (e.g. a wet mop). Do not use it if any part has been immersed. Moreover, do not turn it on or off when standing in water or if your hands are wet.
11. When cutting a piece of steel for the installation of the return duct, do not damage electrical wiring of the unit.
12. Because this unit is hot when in use, it may pose risks even in normal operation. Therefore, be **careful** and **responsible** when using it. To avoid burns, do not let bare skin touch hot surfaces. Let the unit cool down for a few minutes before handling it (it stays warm for some time after shut-down).
13. Never block air vents. This obstruction could lead to overheating, which could result in a fire.
14. Do not insert or allow foreign objects to enter any air vent as this may cause electric shocks, fires, or damages to the unit.
15. This unit has hot and arcing or sparking parts inside. It is not designed to be used or stored in wet areas or areas containing flammable liquids, combustible materials or corrosive, abrasive, chemical, explosive and flammable substances such as, but not limited to, gasoline, paint, chlorine and cleaning products.
16. Some areas are dustier than others. Thus, it is the user's responsibility to evaluate if the **filter must be changed** based on it. Accumulated dirt can lead to a component malfunction or discoloration (yellowing). It may cause a fire hazard if not installed and maintained in accordance with these instructions.
17. Thermal protection activation indicates that the unit has been subjected to abnormal operating conditions. If the thermal protection remains activated or activates and deactivates repeatedly, it is recommended that a qualified electrician or a certified repair centre examine the unit in order to make sure it is not damaged. (Refer to the limited warranty).
18. If the unit is damaged or defective, cut off power supply at circuit breaker/fuse and call a certified repair centre. (Refer to the limited warranty).
19. Label all wires prior to disconnection when servicing controls. Wiring errors can cause improper and dangerous operation.

Note: When a part of the product specification must be changed to improve operability or other functions, priority is given to the product specification itself. In such instances, the instruction manual may not entirely match all the functions of the actual product. Therefore, the actual product and packaging, as well as the name and illustration, may differ from the manual.

Please note that each furnace is factory inspected before shipping in order to ensure that every component is operating efficiently.

SAVE THESE INSTRUCTIONS

INSTALLING THE FURNACE

1 FURNACE LOCATION

The electric furnace is available in several models with various heating capacities (from 10 to 30 kW). All these models adapt easily to many applications and are suitable for **horizontal**, **upflow** and **downflow** operations (see the figures below). When installed in vertical downflow position, use only an “L” or “T” shaped plenum without openings or registers directly below the unit.

You must install the furnace on a dry and solid base, in an area free of flammable liquids or vapors and combustible materials. You must indicate to the furnace user the location of the switches and disconnects. They must be able to quickly identify them in case of an emergency. Moreover, the furnace should be located as centrally as possible in the area to heat in order to optimize air dissipation in all the rooms.

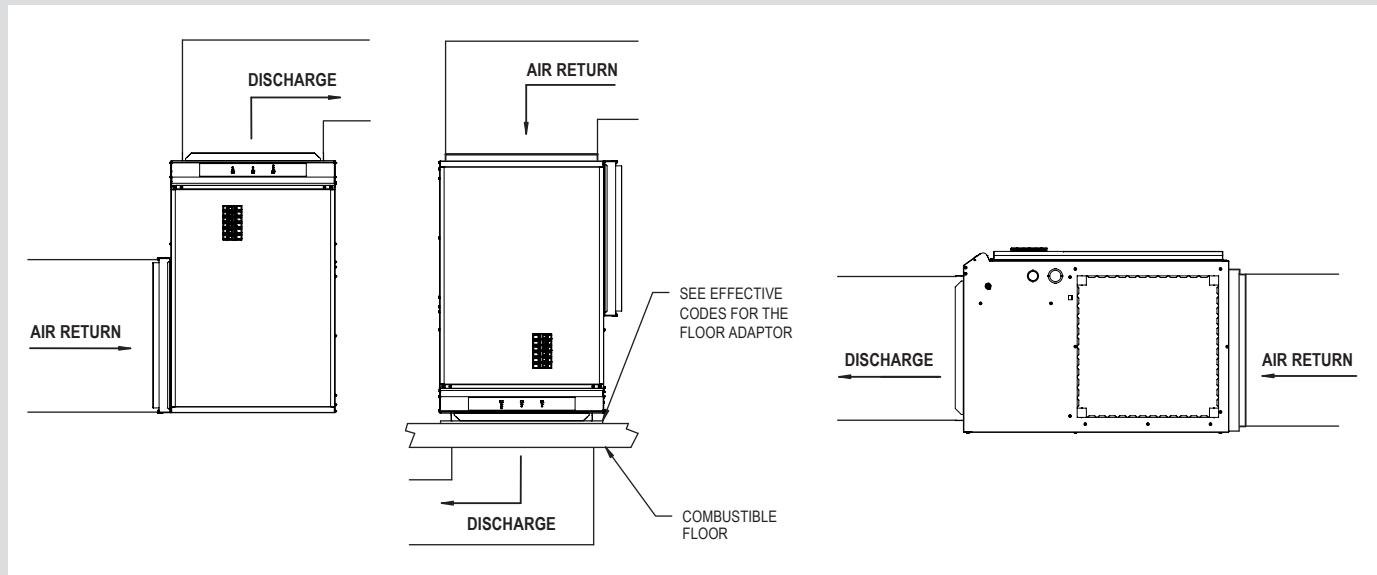

2 FURNACE CLEARANCE

This furnace is approved for **“zero inch” clearance**. Meaning that you can install it directly against a wall. Ducts for models of 22.5 kW and less can also be installed with a zero-inch clearance (0 inch). However, ducts for models of 27.5 kW and more must have a 1-inch clearance for the first 36 inches of duct. From 37 inches, this clearance can be reduced to 0 inch. Please refer to the codes effective in your region if you have any questions concerning clearances.

Since it is necessary to open the door in the front to perform the furnace maintenance inspection, you must leave at least a 24-inch clearance in front of this door.

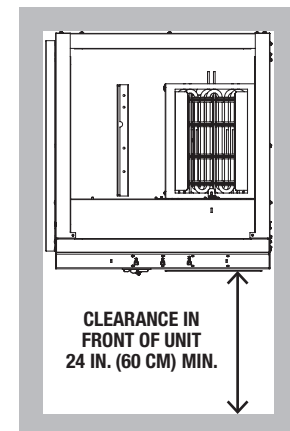

3

DUCTS AND FILTERS

Ducts must be designed to deliver the correct airflow at the specified external static pressure . You should insulate the ducts crossing non-heated areas. Moreover, use flexible return and supply connectors in order to avoid vibrations as much as possible. To make your furnace even quieter, follow these instructions:

1. Cover the vertical return and supply ducts with soundproofing material;
2. Install at most one or two elbows between registers and the return and supply connectors;
3. Install flexible hangers to suspend the ducts;
4. Install baffles in elbows with a small curvature radius.

All models are equipped with a standard size filter rack that you will find on the top of the furnace. You can install this rack on one of the three external sides of the furnace or at its bottom. Using snips, cut the selected rack opening following the slots and holes, and screw the filter rack on it.

4

PLENUM TEMPERATURE CONTROL POTENTIOMETER

The Stelpro electric furnace is equipped with a plenum temperature sensor. You can select the plenum temperature setpoint with a potentiometer installed on the control card. The default factory setpoint is 60°C (140°F). You can select the setpoint from a temperature range between 40°C (104°F) and 70°C (158°F).

OPTIONAL ACCESSORIES

The furnace is equipped with all the devices required for the addition of an air-conditioner or a heat pump (except the heat-cool thermostat). The refrigerant and drainage pipes must be installed either in the furnace supply or return duct and should not prevent you from removing the door in front of the furnace.

You can also install a thermostat with an outdoor sensor or a two-stage thermostat to control your furnace. To do so, you must refer to the instructions supplied with the thermostat as well as the furnace wiring diagram.

When the electric furnace is used in combination with a wood heating unit, you must connect the thermostat of the wood heating unit across low voltage terminals R and G of the furnace. This thermostat will automatically turn the blower of the furnace on.

N.B. Please note that if one of these accessories is installed, you must refer to the appropriate guide.

ELECTRICAL CONNECTIONS

WARNING: This product must be connected by a qualified electrician according to the electrical and building codes effective in your region. For 240 VAC connection, you can use copper or aluminum wire (75 °C [165 °F]), except for 27.5 kw and 30 kw models where only copper wire is allowed.

1 TURNING OFF THE POWER SUPPLY

To protect yourself against the risk of electric shock, disconnect the power supply to the cables at the electrical panel.

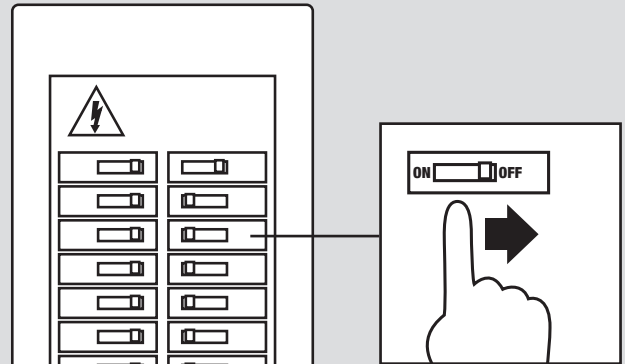

2 ELECTRICAL CONNECTIONS OF THE FURNACE

This furnace must be connected to a 240 or 208 VAC power source. If you want to energize the furnace at 208 VAC, you must change a connection on the 24 V terminal board of the transformer (see the illustration below). Refer to the local and national electrical codes to know which wire size, fuses and circuit breakers are required.

TRANSFORMER PRIMARY VOLTAGE SELECTION

The transformer primary is connected in factory to operate on 240 VAC (black and white wires)

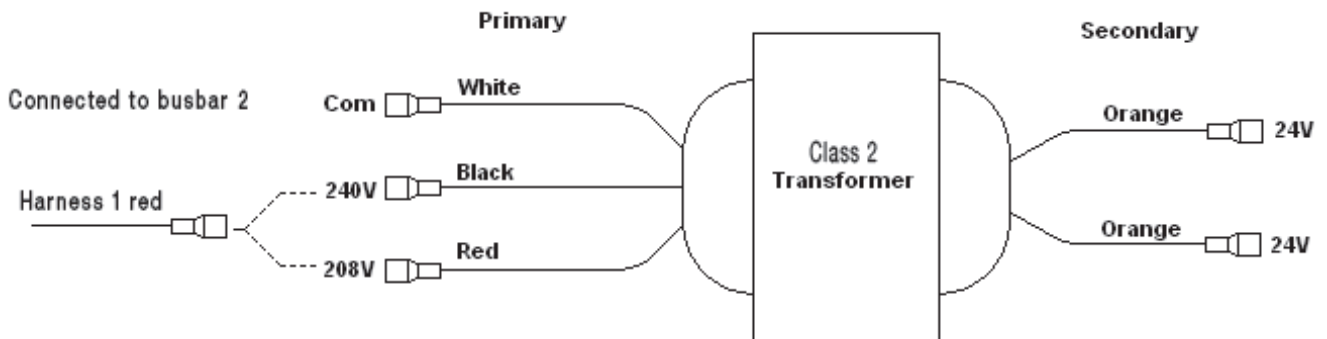

An optional neutral terminal junction (SCOND) can be installed in the electrical compartment of the furnace. It is used to connect a neutral line conductor at the entrance. Some auxiliary devices, like a dehumidifier, are supplied by a 120 VAC power source. The neutral connector allows to supply auxiliary devices with a 120 VAC power source from the furnace.

3

ELECTRICAL CONNECTION OF THE THERMOSTAT

1. Install the thermostat according to the manufacturer's recommendations.
2. Do not install the thermostat in a location where temperature measurements could be altered. For example:
 - close to a window, on an external wall, or close to a door leading outside;
 - exposed directly to the light or heat of the sun, a lamp, a fireplace or any other heat source;
 - close or in front of an air outlet;
 - close to concealed ducts or a chimney; and
 - in a location with poor air flow (e.g. behind a door), or with frequent air draft conditions (e.g. head of stairs).

3. Seal the wall openings in order to minimize the drafts which can alter temperature measurements. Read the user's guide of the thermostat carefully and refer to the following illustrations to connect the thermostat.

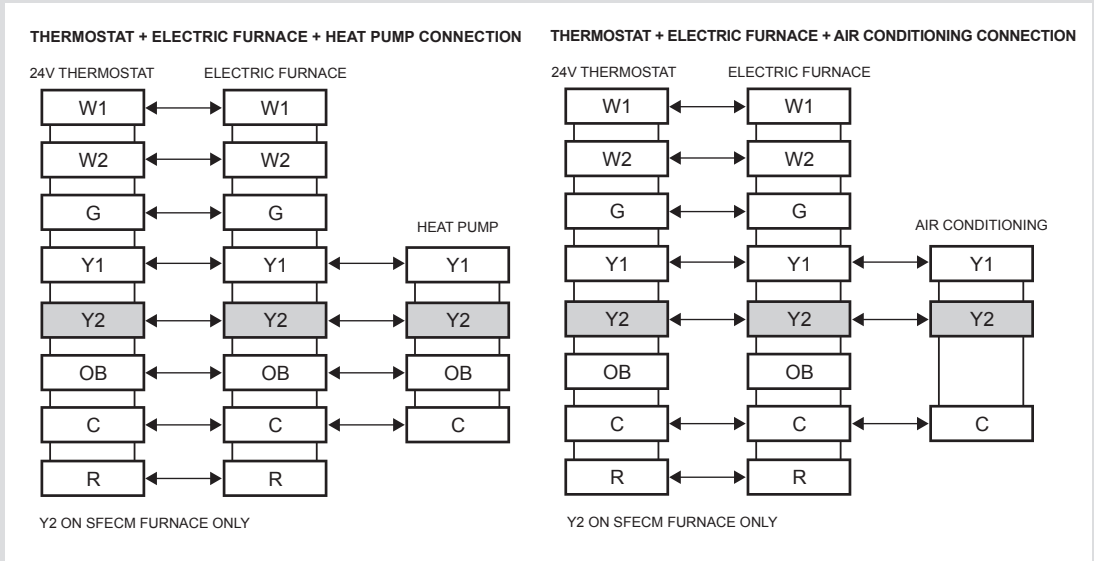

4

ELECTRICAL CONNECTION OF AN ELECTRONIC FILTER AND A HUMIDIFIER SFECM MODELS ONLY

A humidifier and an electronic filter can be controlled directly from the furnace. There is a terminal block for this purpose in the furnace as shown here in the diagram. The terminal block is connected to an internal relay that activates the auxiliary devices when the blower of the furnace is in operation.

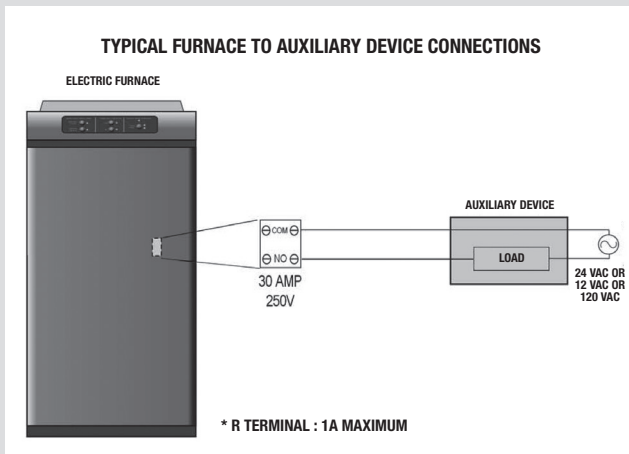

5

TURNING THE POWER BACK ON

Restore power to the furnace and make sure the furnace works by raising the temperature until the unit starts to heat.

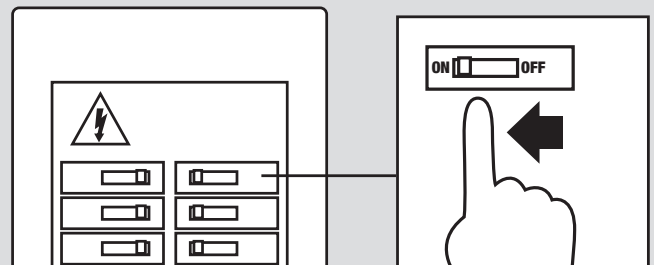

OPERATION

CONTROL PANEL

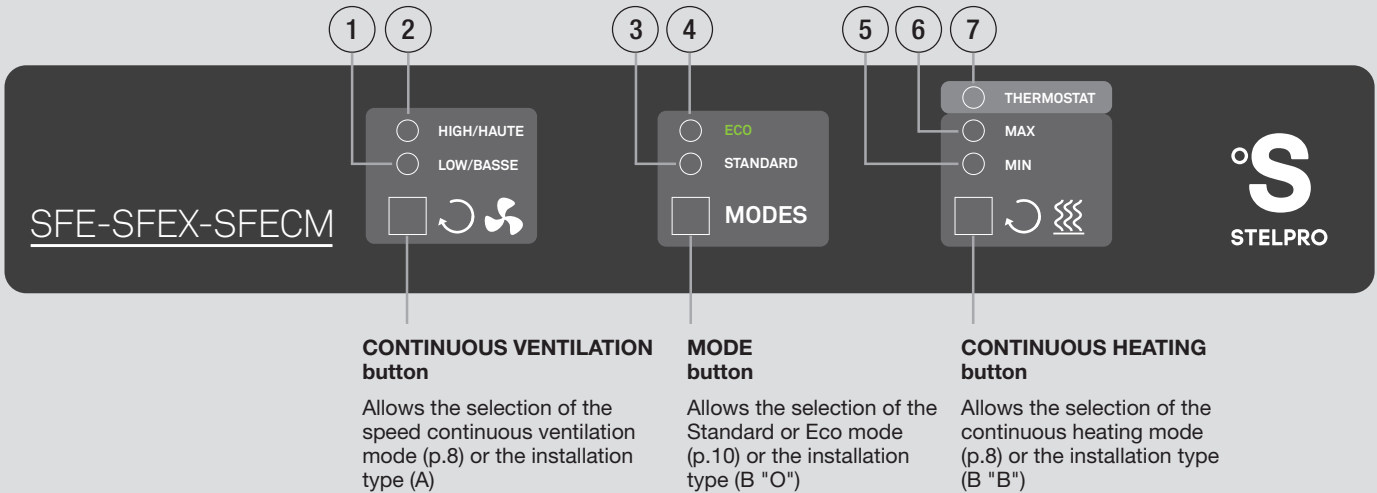

LED LEGEND

- 1. LOW SPEED CONTINUOUS VENTILATION (GREEN)**
Indicates that the low speed continuous ventilation mode is activated.
- 2. HIGH SPEED CONTINUOUS VENTILATION (GREEN)**
Indicates that the high speed continuous ventilation mode is activated.
- 3. STANDARD MODE (GREEN)**
Indicates Standard mode is activated.
- 4. ECO MODE (GREEN)**
Indicates that the Eco mode is activated.
- 5. MIN CONTINUOUS HEATING (GREEN)**
Indicates that the minimum of heating capacity is activated.
- 6. MAX CONTINUOUS HEATING (GREEN)**
Indicates that the maximum of continuous heating mode is activated.
- 7. THERMOSTAT (YELLOW)**
Indicates that the furnace is receiving a heating demand from the thermostat.

HEATING DEMAND

ONE-STAGE THERMOSTAT

W1 The thermostat closes the R-W1 circuit, which activates 100% of the heating sequence. The blower starts up at medium speed and the furnace elements are activated one by one to reach the adjustable temperature limit set on the potentiometer of the furnace control card.

If there is still a W1 heating demand after 30 minutes, the heating sequence continues as per the W2 sequence.

OR

W2 The blower switches to the medium speed and all the furnace elements are activated one by one (100% heating). The plenum temperature is still limited by the potentiometer of the control card.

TWO-STAGE THERMOSTAT

The control card of the furnace auto-detects the two stages of the thermostat.

W1 The thermostat closes the R-W1 circuit, which activates the first stage of the heating sequence ($\pm 50\%$ heating). The blower starts up at low speed and the furnace elements are activated one by one to reach the adjustable temperature limit set by the potentiometer on the furnace control card.

If there is still a W1 heating demand after 30 minutes, the heating sequence continues as per the W2 sequence.

AND/OR

W2 If the thermostat closes the R-W2 circuit, the sequence continues as follows: the blower switches to the medium speed and all the furnace elements are activated

one by one (100% heating). The plenum temperature is still limited by the potentiometer of the control card.

HEATING DEMAND, STANDARD MODE (WITH T-STAT INTELLIGENCE)

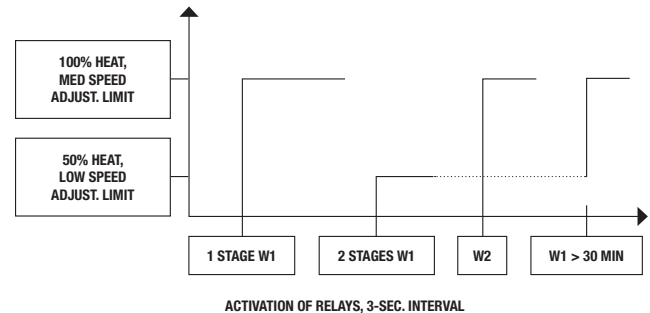

CONTINUOUS VENTILATION

Two ventilation speeds can be selected on the furnace control panel: LOW SPEED CONTINUOUS VENTILATION or HIGH SPEED CONTINUOUS VENTILATION. The user can select the ventilation speed by pressing the **CONTINUOUS VENTILATION** button.

The SFECM series allows to adjust the continuous ventilation airflows independently from the ventilation airflow in heating mode. Note that it also allows airflows as low as 300 cfm in continuous ventilation.

CONTINUOUS HEATING

The continuous heating option allows one or two heating elements to operate continuously. The user can select min (one element) or max (two elements) continuous heating by pressing the **CONTINUOUS HEATING** button.* The continuous heating mode is useful from the beginning to the end of the heating season since it reduces temperature variations into the house. If the minimum or maximum continuous heating option is activated by the user, the furnace will deactivate it when the heating season ends (more than two hours without any heating demand). Moreover, it will reactivate it when a new heating season begins.

Note that the pilot light indicating the heating option will blink if the furnace deactivates this option because the heating season is over. This indicates that the continuous heating will be activated again at the start of the next heating season.

*Please note that for model #1021, the minimum and maximum continuous heating are the same (one element).

AIR CONDITIONING

The furnace supplies the necessary 24V power for the thermostat relay (R-Y terminals) to control the air-conditioner compressor relay. When the R-Y terminals are activated, the blower starts-up at high speed. See the connection diagram page 6.

HEAT PUMP

If a heat pump is installed in your central heating system, the Stelpro electric furnace offers the installer two types of installations: type "A" or type "B". Installation "A" must be selected when the heat pump is installed **A**fter the furnace (air supply), and installation "B" must be selected when the heat pump is installed **B**efore the furnace (air return), as shown in the next picture. Once again, when the R-Y terminals are activated, the blower starts-up at high speed.

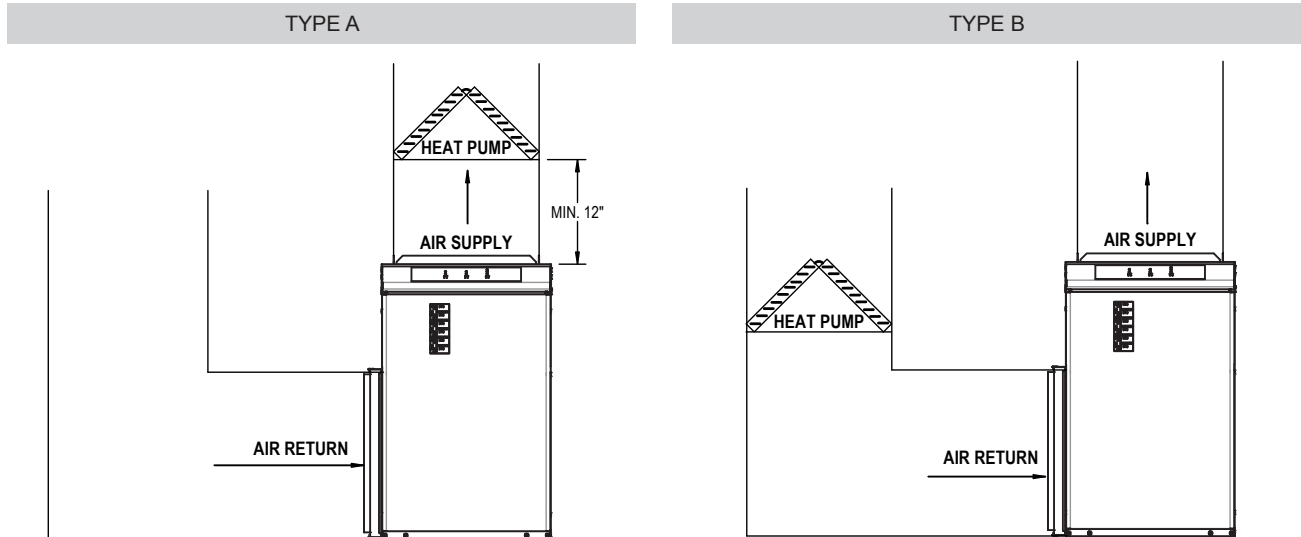

TYPE A

For Type A installation, whenever the heat pump is in operation (Y demand from the thermostat), no electric heating will be supplied by the furnace. Type A is the **factory default** installation type.

TYPE B

The installer must change the furnace installation type to set the default-powered side of the heat pump's reversible valve to "O" for priority heating or "B" for priority air conditioning. To change the type of installation, set the lowest circuit breaker on the furnace door to OFF. Press one of the three buttons on the control panel following the diagram below. While keeping the selected button pressed, reset the circuit breaker to ON. The indicator light above the selected button will blink to indicate the type of installation programmed.

INSTALLATION TYPE SELECTION

CONTINUOUS VENTILATION button	MODE button	CONTINUOUS HEATING button
Type A factory setting	Type B – valve "O" normally open (priority heating)	Type B – valve "B" normally open (priority air conditioning)

TYPE "B", STANDARD MODE WITH TEMPERATURE COMPENSATION (WITH T-STAT INTELLIGENCE)

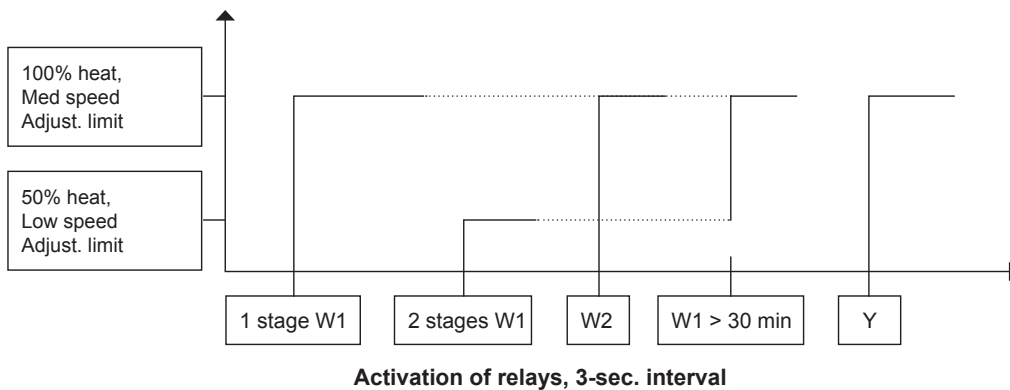

OPERATING LOGIC TABLE WITH A THERMOSTAT

FUNCTION	TYPE	CONNECTION – INPUT						FURNACE – OUTLET			PRIORITY	
		VENTILATION	SINGLE-STAGE THERMOSTAT	TWO-STAGE THERMOSTAT		COMPRESSOR	HEAT PUMP REVERSING VALVE	HEATING	TEMPERATURE LIMIT IN THE PLENUM	FAN SPEED**		
		G	W1	W1	W2	Y1 OR Y2*	0/B	%	°C/°F			
FAN ONLY	ALL	1	0	0	0	0	x	0	none	low	–	
HEATING	ALL	x	1	–	–	0	x	100	adjustable	medium	–	
		x	–	1	0	0	x	50	adjustable	low	–	
		x	–	x	1	0	x	100	adjustable	medium	–	
COMPENSATION (HEAT PUMP/AIR CONDITIONING)	A	x	0	0	0	1	x	0	none	high	–	
		x	1	1	0	1	x	100	35°C/95°F	high	–	
		x	–	x	1	1	x	100	35°C/95°F	high	–	
	B	x	x	x	x	1	1	0	0	none	high	heating "O"
		x	x	x	x	1	0	100	40°C/104°F	high		
		x	x	x	x	1	1	100	40°C/104°F	high	air conditioning "B"	
		x	x	x	x	1	0	0	none	high		

x = signal status not important (0 or 1), 1 = signal present, 0 = no signal, – = not applicable

* Y2 = maximum flow rate only (not adjustable), ** = Speed adjustable for the SFECM model

The indicator light above the selected button will blink to indicate the type of installation programmed.

A heat pump can operate year round and save you money on heating costs thanks to the Stelpro furnace's unique plenum air temperature control function. This function always maintains equal air temperature in the plenum and ducts. In cold weather, the heat pump loses some of its heating capacity, but it is still more economical than electric heating. The furnace will therefore compensate for the heat pump's loss of output in cold weather. Even when the heat pump is in defrost mode and tends to cool the air in the house, the furnace will itself increase the heating power quickly to compensate the heat pump's defrosting cooling effect. In this case, the temperature in the plenum is limited to the temperature indicated in the table above.

ECO MODE

The user can select two different heating modes by pressing the button located in the middle of the control panel (**MODE** button). The two modes affect the heating demand and the functions when used with the heat pump and the STANDARD mode described previously. When ECO mode is selected, the heating sequence is longer than STANDARD and the heating power will ramp-up to 50% heating for five (5) minutes. If a heating demand lasts 30 minutes, a second sequence of five (5) minutes activates a ramp-up of the elements to 100% heating at medium speed. For a two-stage thermostat, when the W2 is in demand, the furnace waits another five (5) minutes before ramping-up for five (5) minutes until 100% of heating capacity is reached. Also, the temperature compensation option explained previously in installation type "B" does not operate in ECO mode. Thus, whenever the heat pump is activated (Y demand), no electric heating will be supplied by the furnace.

HEATING DEMAND, ECO MODE, W1 DEMAND (WITH FURNACE INTELLIGENCE)

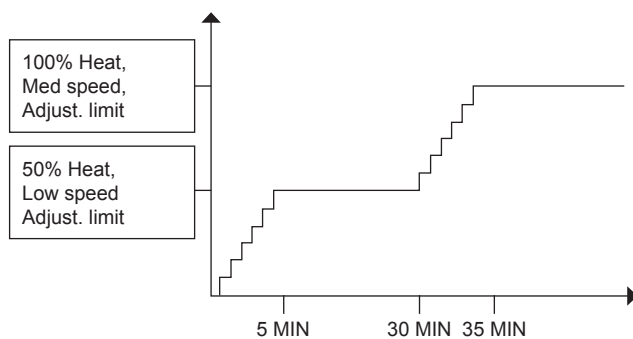

HEATING DEMAND, ECO MODE, W2 DEMAND (WITH FURNACE INTELLIGENCE)

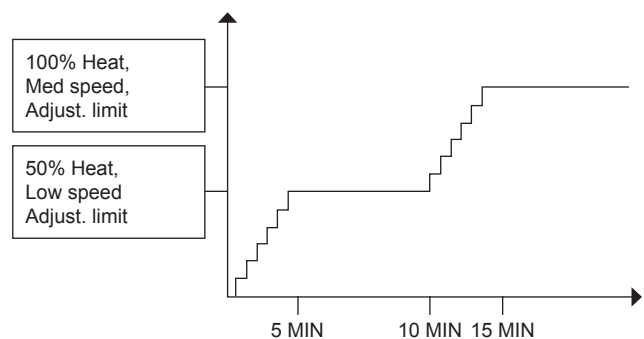

PLENUM TEMPERATURE ADJUSTMENT IN HEATING MODE

Adjusting the output temperature when the thermostat is controlled by a W command.

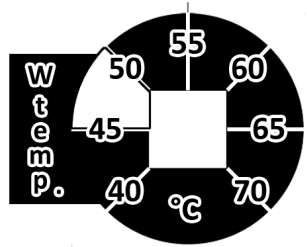

HEATING TEMPERATURE

AIRFLOW CHANGES FOR THE SFE MODEL

The blower speeds can be modified by changing the connection of the three motor relays.

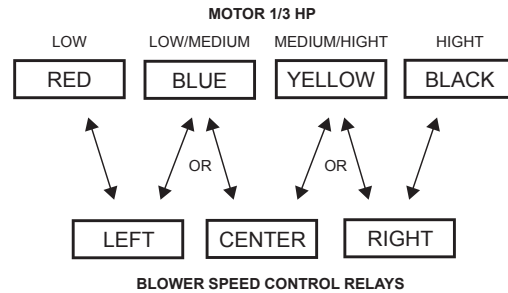

AIRFLOW TABLE (SFE)

1/3 HP MOTOR											
POWER	ESP	LOW		MEDIUM/LOW		MEDIUM/HIGH		HIGH		POWER CONTINUOUS HEATING MODE	
		CFM	Δ T (°F)	CFM	Δ T (°F)	CFM	Δ T (°F)	CFM	Δ T (°F)	MIN (KW)	MAX (KW)
KW	IWC										
10	0.2	900	35	925	34	960	33	1000*	32*	2.5	2.5
15	0.2	930	51	1000	47	1100*	43*	1200	40	2.5	5
17.5	0.2	930	60	1000	55	1100*	50*	1200	46	2.5	5
20	0.2	1125	56	1150*	55*	1300	49	1360	47	2.5	5
22.5	0.2	1125*	63*	1150	62	1300	55	1360	52	2.5	5
10	0.5	725	44	775	41	800	40	900*	35*	2.5	2.5
15	0.5	800	59	860	55	930*	51*	1000	47	2.5	5
17.5	0.5	800	69	860	64	930*	60*	1000	55	2.5	5
20	0.5	900	70	950*	67*	1110	57	1200	53	2.5	5
22.5	0.5	900*	79*	950	75	1110	64	1200	59	2.5	5

1 HP MOTOR									
POWER	ESP	LOW		MEDIUM		HIGH		POWER CONTINUOUS HEATING MODE	
		CFM	Δ T (°F)	CFM	Δ T (°F)	CFM	Δ T (°F)	MIN (KW)	MAX (KW)
KW	IWC								
20	0.2	1650	38	1800	35	1900	33	2.5	5
22.5	0.2	1650	43	1800	40	1900	37	2.5	5
27.5	0.2	1600	54	1775	49	1850	47	2.5	7.5
30	0.2	1600	59	1775	53	1850	51	5	10
20	0.5	1600	40	1650	38	1800	35	2.5	5
22.5	0.5	1600	45	1650	43	1800	40	2.5	5
27.5	0.5	1525	57	1600	54	1750	50	2.5	7.5
30	0.5	1525	62	1600	59	1750	54	5	10

The Continuous mode is set at low speed.

* Optional speed, not connected at the factory.

AIRFLOW TABLE (SFEX)

1/3 HP MOTOR									
POWER	ESP	LOW		MEDIUM		HIGH		POWER CONTINUOUS HEATING MODE	
		CFM	ΔT (°F)	CFM	ΔT (°F)	CFM	ΔT (°F)	MIN (KW)	MAX (KW)
10	0.2	700	45	950	33	1025	31	2.5	2.5
15	0.2	775	61	1150	41	1325	36	2.5	5
17.5	0.2	775	71	1150	48	1325	42	2.5	5
20	0.2	775	82	1150	55	1325	48	2.5	5
22.5	0.2	775	92	1150	62	1325	54	2.5	5
10	0.5	575	55	875	36	900	35	2.5	2.5
15	0.5	630	75	1000	47	1225	39	2.5	5
17.5	0.5	630	88	1000	55	1225	45	2.5	5
20	0.5	630	100	1000	63	1225	52	2.5	5
22.5	0.5	630	113	1000	71	1225	58	2.5	5

3/4 HP MOTOR									
POWER	ESP	LOW		MEDIUM		HIGH		POWER CONTINUOUS HEATING MODE	
		CFM	ΔT (°F)	CFM	ΔT (°F)	CFM	ΔT (°F)	MIN (KW)	MAX (KW)
20	0.2	960	66	1800	35	2000	32	2.5	5
22.5	0.2	960	74	1800	40	2000	36	2.5	5
27.5	0.2	960	91	1800	48	2000	44	2.5	7.5
30	0.2	960	99	1800	53	2000	47	5	10
20	0.5	725	87	1650	38	1700	37	2.5	5
22.5	0.5	725	98	1650	43	1700	42	2.5	5
27.5	0.5	725	120	1650	53	1700	51	2.5	7.5
30	0.5	725	131	1650	58	1700	56	5	10

The Continuous mode is set at low speed.

AIRFLOW SETTINGS

SFECM MODELS ONLY

The SFECM furnace is equipped with an efficient ECM motor that can maintain constant airflow regardless of the static pressure variation in the ducts. It also ensures an easy setting of the airflows related to each operation mode of the furnace blower. The blower has four adjustments:

A potentiometer allowing to adjust the airflow corresponds to each of these four modes. The potentiometers are located on the furnace control card. The adjustment scales vary from one model to the other according to the capacity of the unit and are represented on the table below. The airflows can be adjusted while the furnace is running. To adjust airflows, you must set the potentiometers to the desired values.

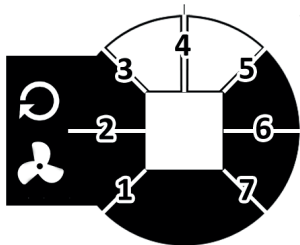

CONTINUOUS VENTILATION

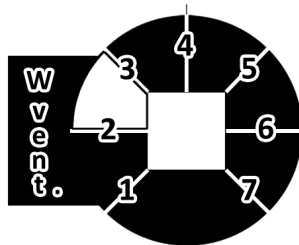

HEATING VENTILATION

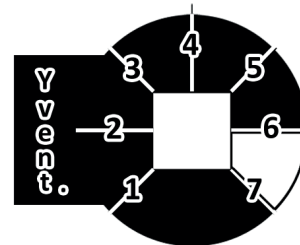

AIR CONDITIONING FLOW RATE

AIRFLOW SETTINGS TABLE (SFECM)

	CONTINUOUS VENTILATION CONT. VENT.		HEATING VENTILATION W VENT.		AIR CONDITIONING FLOW RATE Y1* VENT.
	LOW	HIGH	W1	W2	
1021 MODEL					
1	300	700	300	700	400
2	366	766	400	800	575
3	433	833	500	900	750
4	500	900	600	1000	925
5	566	966	700	1100	1100
6	633	1033	800	1200	1275
7	700	1100	900	1300	1450
1521, 1821 MODEL					
1	300	700	350	850	600
2	366	766	530	1030	742
3	433	833	710	1210	884
4	500	900	900	1400	1025
5	566	966	1080	1450	1167
6	633	1033	1260	1450	1309
7	700	1100	1450	1450	1450
2021, 2321 MODEL					
1	300	700	450	1150	800
2	366	766	615	1315	908
3	433	833	785	1450	1016
4	500	900	950	1450	1125
5	566	966	1115	1450	1234
6	633	1033	1285	1450	1342
7	700	1100	1450	1450	1450
2021-1, 2321-1 MODEL					
1	400	1200	450	1150	800
2	533	1333	710	1410	1033
3	666	1466	965	1665	1266
4	800	1600	1225	1925	1500
5	933	1733	1485	2000	1733
6	1066	1866	1740	2000	1966
7	1200	2000	2000	2000	2200
2721, 3021 MODEL					
1	400	1200	750	1500	800
2	533	1333	992	1742	1033
3	666	1466	1233	1983	1266
4	800	1600	1475	2200	1500
5	933	1733	1717	2200	1733
6	1066	1866	1740	2200	1966
7	1200	2000	2200	2200	2200

= Factory setting

*Y2 = maximum flow rate only (not adjustable)

VERIFYING THE HIGH LIMIT THERMAL PROTECTIONS

When the furnace has run at full capacity for 10 minutes, block the supply and return air openings and measure the supply air temperature at a point that is not exposed to heat radiation from the elements. The elements are supposed to shut down one by one before the temperature exceeds 95°C-200°F.

MAINTENANCE AND TROUBLESHOOTING

N.B. In order for the warranty to be valid, the unit must be cleaned regularly.

Cut off power supply at circuit breaker/fuse before cleaning the unit. Use a soft rag for dusting. When cleaning, use only a damp rag and non-abrasive dish soap. Do not use abrasive or chemical cleaners because they may damage the finishing. If the unit is used in a very dusty location, use a vacuum brush to remove dust and other foreign objects from the grilles. Note that cigarette smoke could yellow the discharge grille and that the best way to prevent it is to clean the unit on a regular basis.

Do not use cleaning products identified with these symbols:



N.B. Note that there is electrical current linked to the unit even if the thermostat is set off. This means that there is a risk of electric shock as long as the unit is energized.

PREVENTIVE MAINTENANCE

Do not try to repair your furnace yourself. Call a qualified technician. However, before calling a technician, check the following points.

1. Make sure fuses or circuit breakers are activated.
2. Adjust the temperature set point of the thermostat above the ambient temperature. If heating does not start, cut off the power supply and call a technician.

N.B. When calling a technician for maintenance or to order a replacement part, specify the model of your furnace as well as its serial number.

AIR FILTER

Excessive dust or dirt accumulation can block the airflow, forcing the unit to work harder to maintain the desired temperature. Therefore, it uses more energy and increases heating costs.

Since the air filter supplied is disposable, you should replace it two to four times a year, according to the model used and the installation area. Dirtier areas can require more than four filter changes.

To replace a dirty filter, open the access door to the filter, remove the old filter and insert the new one inside the rack. Make sure the new filter has the same technical specifications and size as the previous one.

N.B. Never operate the unit without a filter in place.

Every time a filter is changed, you should check the following points.

- Excessive accumulation of dirt or dust on furnace components.
- Damaged components or surfaces.
- Presence of water inside or outside the furnace.

If you encounter any of these problems, do not operate the furnace. Call a qualified technician.

BLOWER

The blower motor is sealed and permanently lubricated, so it is not necessary to lubricate it.

Even if you change the filter frequently, the blower's blades and motors will become dust laden after a few months. The entire blower assembly should be inspected annually. If needed, vacuum out the dust. If you cannot clean the blower without removing it from the furnace, this service must be performed by a qualified technician.

CONTROL CARD AUTODIAGNOSTIC

The control card of the furnace is equipped with a pilot LED that allow easy and quick diagnostic of its essential functions. The yellow LED is located at the top right side of the control panel (item #10 of the control panel picture).

The pilot LED will start to blink continuously when an electrical problem occurs.

PROBLEM	DEFECTIVE PART OR PART TO CHECK
The unit does not work	<ul style="list-style-type: none"> • Defective thermostat, wrong thermostat setting or positioning • Open circuit breaker or fuse • Faulty connections • Faulty motor or condensator • Faulty blower control switch • Faulty transformator • See above: CONTROL CARD AUTODIAGNOSTIC
The unit runs continuously	<ul style="list-style-type: none"> • Defective thermostat, wrong thermostat setting or positioning • Heat losses greater than the unit capacity • Faulty relay • Thermostat wire incorrectly connected to the furnace • See above: CONTROL CARD AUTODIAGNOSTIC
The unit cycles under control of the thermal protection (overheat indicator)	<ul style="list-style-type: none"> • Blocked air vents • Defective motor
Overheating	<ul style="list-style-type: none"> • Defective thermostat, wrong thermostat setting or positioning • Defective motor
The breaker trips when the heater is turned on	<ul style="list-style-type: none"> • Faulty connections • Voltage higher than that indicated on the nameplate
Elements are on, but the motor does not work	<ul style="list-style-type: none"> • Defective motor or condensator • Faulty relay
The desired room temperature cannot be reached	<ul style="list-style-type: none"> • One or more defective elements • Defective thermostat or wrong thermostat setting • Voltage lower than that indicated on the nameplate • Heat losses greater than the unit capacity • Faulty relay

The following table lists the most common problems and alerts you may encounter with your unit heater.

If your issue isn't listed in this table or if the proposed solution does not solve the problem, please turn off the unit and contact our customer service team.

WWW.STELPRO.COM
 CONTACT@STELPRO.COM
1-844-STELPRO

STELPRO LIMITED WARRANTY

This limited warranty is offered by STELPRO Design Inc. ("STELPRO") and applies to the following product made by STELPRO: models **SFE, SFEX, SFECM**.

Please read this limited warranty carefully. Subject to the terms of this warranty, STELPRO warrants its products and their components against defects in workmanship and/or materials for the following periods from the date of purchase: **5 years**. This warranty applies only to the original purchaser; it is non-transferable and cannot be extended.

CLAIM PROCEDURE

If at any time during the warranty period the unit becomes defective, you must cut off the power supply at the main electrical panel and contact 1) your installer or distributor, 2) your service center or 3) STELPRO's customer service department. In all cases, you must have a copy of the invoice and provide the information written on the product nameplate. STELPRO reserves the right to examine or to ask one of its representatives to examine the product itself or any part of it before honoring the warranty. STELPRO reserves the right to replace the entire unit, refund its purchase price or repair a defective part. Please note that repairs made within the warranty period must be authorized in advance in writing by STELPRO and carried out by persons authorized by STELPRO.

Before returning a product to STELPRO, you must have a STELPRO authorization number (RMA). To obtain it, call the customer service department at: 1-844-STELPRO. The authorization number must be clearly written on the parcel or it will be refused.

CONDITIONS, EXCLUSIONS AND DISCLAIMER OF LIABILITY

This warranty is exclusive and in lieu of all other representations and warranties (except of title), expressed or implied, and STELPRO expressly disclaims and excludes any implied warranty of merchantability or implied warranty of fitness for a particular purpose.

STELPRO's liability with respect to products is limited as provided above. STELPRO shall not be subject to any other obligations or liabilities whatsoever, whether based on contract, tort or other theories of law, with respect to goods or services furnished by it, or any undertakings, acts or omissions relating thereto. Without limiting the generality of the foregoing, STELPRO expressly disclaims any liability for property or personal injury damages, penalties, special or punitive damages, damages for lost profits, loss of use of equipment, cost of capital, cost of substitute products, facilities or services, shutdowns, slowdowns, or for other types of economic loss or for claims of a dealer's customers or any third party for such damages. STELPRO specifically disclaims all consequential, incidental and contingent damages whatsoever.

This warranty does not cover any damages or failures resulting from: 1) a faulty installation or improper storage; 2) an abusive or abnormal use, lack of maintenance, improper maintenance (other than that prescribed by STELPRO) or a use other than that for which the unit was designed; 3) a natural disaster or an event out of STELPRO's control, including, but not limited to, hurricanes, tornadoes, earthquakes, terrorist attacks, wars, overvoltage, flooding, water damages, etc. This warranty does not cover any accidental or intentional losses or damages, nor does it cover damages caused by negligence of the user or owner of the product. Moreover, it does not cover the cost of disconnection, transport, and installation.

The warranty is limited to the repair or the replacement of the unit or the refund of its purchase price, at the discretion of STELPRO. Any parts replaced or repaired within the warranty period with the written authorization of STELPRO will be warranted for the remainder of the original warranty period. This warranty will be considered null and void and STELPRO will have the right to refuse any claims if products have been altered without the written authorization of STELPRO and if the nameplate numbers have been removed or modified. This warranty does not cover scratches, dents, corrosion or discoloration caused by excessive heat, chemical cleaning products and abrasive agents. It does not cover any damage that occurred during the shipping.

Some states and provinces do not allow the exclusion or limitation of incidental or consequential damages and some of them do not allow limitations on how long an implied warranty lasts, so these exclusions or limitations may not apply to you. This warranty gives you specific legal rights and you may have other rights which vary from state to state or from province to province.