



Complete Manual for

RoboSHOT HDBT High-Performance PTZ Cameras

Including RoboSHOT 12 HDBT, RoboSHOT 30 HDBT,
RoboSHOT 12E HDBT, and RoboSHOT 30E HDBT

Document 411-0003-30 Rev. F
May 2019

Contents

Overview	1
What's in this Guide	2
Camera Features	2
Unpacking the Camera	3
A Quick Look at the Camera	8
Front of the Camera	8
Back of the Camera – RoboSHOT 12E HDBT and RoboSHOT 30E HDBT	9
Back of the Camera – RoboSHOT 12 HDBT and RoboSHOT 30 HDBT	10
Installing the Camera	11
Don't Void Your Warranty!	11
Before You Start	11
Installing the Wall Mount	12
About Ceiling-Mounted Cameras	12
Video Resolution Setting	13
Camera Behavior Settings – RoboSHOT 12 HDBT and RoboSHOT 30 HDBT	14
RS-232 Serial Communication Settings	15
Cabling Notes	15
Connecting the Camera	16
Basic Connections – RoboSHOT 12E HDBT or RoboSHOT 30E HDBT	16
Basic Connections – RoboSHOT 12 HDBT or RoboSHOT 30 HDBT	17
Basic Connections – RoboSHOT HDBT with Camera Extension	18
Basic Connections – RoboSHOT HDBT Basic Conference Setup	19
Basic Connections – RoboSHOT HDBT Camera with Third-Party Control and Power	20
Options for Power and Other Connections – RoboSHOT 12 HDBT and RoboSHOT 30 HDBT	20
Installing the Camera	21
Powering Up the Camera	22
Status Light	22
Using the IR Remote	23
IR Remote Cheat Sheet	23
IR Remote Details	24
Storing a Preset Using the Remote	24
Clearing a Preset Using the Remote	24
Web Interface	25
Getting the Camera's IP Address	25
Accessing the Web Interface	25
Browser Support	25
User Access	26
Administrative Access	27
Compact Menu View	27
Web Interface Cheat Sheet	28

System Administration	30
For Non-DHCP Environments: Configuring the Device with a Static IP Address for Initial Installation	30
Changing the Camera's Hostname	32
Optional For DHCP Environments: Changing from a DHCP Address to a Static IP Address	33
Specifying Time Zone and NTP Server	34
Managing Access and Passwords	35
Disabling Telnet Access	35
Enabling or Requiring HTTPS	36
Adding Room Information to the Camera's Web Interface	37
Saving (Exporting) or Restoring (Importing) a Camera Configuration	38
Installing a Camera Firmware Update	39
Rebooting the Camera	40
Contacting Vaddio Technical Support	41
Accessing the Diagnostic Logs	41
Configuring Camera Behavior	42
Setting the Custom Home Position and Other Preset Shots	42
Renaming Presets and Custom CCU Scenes	43
Initial Lighting and Color Settings	44
Lighting Adjustments	45
Fine-Tuning Image Quality and Color	45
Lighting and Image Quality Cheat Sheet	46
Color Adjustment Cheat Sheet	47
Saving Color and Lighting Settings	47
Adjusting the Focus	48
Configuring IP Streaming	49
About IP Streaming	49
Stopping the IP Stream	50
Setting up Streaming in Easy Mode	51
Setting up Streaming in Custom Mode	52
RTSP Streaming Protocol and URL	53
Configuring RTMP Streaming	54
Advanced: Changing MTU	55
Speed Adjustments	56
About Tri-Synchronous Motion	56
Setting the Speed for Manual Movements	56
Setting the Speed of Movements to Presets	57
Adjusting Tri-Synchronous Motion Speed	58
Setting the Direction for Camera Movements	59
Reading the Camera's Switches	60
Basic Camera Settings for RoboSHOT 12E HDBT and RoboSHOT 30E HDBT	61

Software-Controlled Video Output Resolution Setting	62
Additional Camera Behavior Settings	62
Operating the Camera from the Web Interface	64
Switching the Camera Off or On (Standby)	64
Stop or Resume Sending Video (Mute)	64
Moving the Camera	65
Zooming In or Out	65
Moving the Camera to a Preset Position	65
Adjusting the Color and Lighting	65
Telnet Command Reference	66
camera home	67
camera pan	67
camera tilt	68
camera zoom	69
camera focus	70
camera preset	71
camera ccu get	72
camera ccu set	73
camera ccu scene	74
camera led	74
camera standby	75
streaming ip enable	75
streaming settings get	76
network settings get	76
network ping	77
system reboot	77
system factory-reset	78
history	79
version	79
help	80
exit	80
RS-232 Serial Command Reference	81
Camera Movement, Zoom, and Focus Commands	81
Movement, Zoom, and Focus Inquiry Commands	83
Color and Light Management Commands	84
Shutter Speed Values (CAM_Shutter)	86
Iris Values (CAM_Iris)	87
Iris Gain and Gain Limit Values (CAM_Gain)	87
Color and Light Management Inquiry Commands	88
Other Commands	88
Other Inquiry Commands	89

Specifications	90
Troubleshooting and Care	91
Check the Status Light First	91
Check the Cables Next	91
Power/Responsiveness Issues	92
Video and Streaming Issues	93
Camera Control and Other Issues	93
Restoring Factory Settings from the Web Interface	94
Restoring Factory Default Settings Via Hardware	94
Operation, Storage, and Care	95
Compliance and Conformity Statements	96
FCC Part 15 Compliance	96
ICES-003 Compliance	96
European Compliance	97
Warranty and Return Policy	98
Photo Credits	102
Index	103

Overview



This guide covers the RoboSHOT® HDBT cameras:

- RoboSHOT 12 HDBT, North America – 999-9960-000 (silver/black)
- RoboSHOT 12 HDBT, Europe/UK – 999-9960-001 (silver/black)
- RoboSHOT 12 HDBT, Australia/New Zealand – 999-9960-009 (silver/black)
- RoboSHOT 12E HDBT, North America – 999-99600-000 (black); 999-99600-000W (white)
- RoboSHOT 12E HDBT, Europe/UK – 999-99600-001 (black); 999-99600-001W (white)
- RoboSHOT 12E HDBT, Australia/New Zealand – 999-99600-009 (black); 999-99600-009W (white)
- RoboSHOT 30 HDBT, North America – 999-9963-000 (black); 999-9963-000W (white)
- RoboSHOT 30 HDBT, Europe/UK – 999-9963-001 (black), 999-9963-001W (white)
- RoboSHOT 30 HDBT, Australia/New Zealand – 999-9963-009 (black); 999-9963-009W (white)
- RoboSHOT 30E HDBT, North America – 999-99630-000 (black); 999-99630-000W (white)
- RoboSHOT 30E HDBT, Europe/UK – 999-99630-001 (black); 999-99630-001W (white)
- RoboSHOT 30E HDBT, Australia/New Zealand – 999-99630-009 (black); 999-99630-009W (white)

It is also applicable to OneLINK® systems and codec bundles featuring RoboSHOT HDBT cameras:

- RoboSHOT 12 OneLINK HDMI System for Cisco Codecs, North America – 999-9575-400 (silver/black)
- RoboSHOT 12 OneLINK HDMI System for Cisco Codecs, Europe/UK – 999-9575-401 (silver/black)
- RoboSHOT 12E HDBT OneLINK HDMI System for Cisco Codecs, North America – 999-95750-400 (black), 999-95750-400W (white)
- RoboSHOT 12E HDBT OneLINK HDMI System for Cisco Codecs, Europe/UK – 999-95750-401 (black), 999-95750-401W (white)
- RoboSHOT 12 OneLINK Bridge System for Cisco Codecs, North America – 999-9675-400 (silver/black)
- RoboSHOT 12 OneLINK Bridge System for Cisco Codecs, Europe/UK – 999-9675-401 (silver/black)
- RoboSHOT 12E HDBT OneLINK Bridge System for Cisco Codecs, North America – 999-96750-400 (black), 999-96750-400W (white)
- RoboSHOT 12E HDBT OneLINK Bridge System for Cisco Codecs, Europe/UK – 999-96750-401 (black), 999-96750-401W (white)
- RoboSHOT 12 OneLINK HDMI System for Polycom Codecs, North America – 999-9545-500 (silver/black)
- RoboSHOT 12 OneLINK HDMI System for Polycom Codecs, Europe/UK – 999-9545-501 (silver/black)
- RoboSHOT 12E HDBT OneLINK HDMI System for Polycom Codecs, North America – 999-95450-500 (black), 999-95450-500W (white)
- RoboSHOT 12E HDBT OneLINK HDMI System for Polycom Codecs, Europe/UK – 999-95450-501 (black), 999-95450-501W (white)
- RoboSHOT 12 OneLINK Bridge System for Polycom Codecs, North America – 999-9645-500 (silver/black)
- RoboSHOT 12 OneLINK Bridge System for Polycom Codecs, Europe/UK – 999-9645-501 (silver/black)
- RoboSHOT 12E HDBT OneLINK Bridge System for Polycom Codecs, North America – 999-96450-500 (black), 999-96450-500W (white)
- RoboSHOT 12E HDBT OneLINK Bridge System for Polycom Codecs, Europe/UK – 999-96450-501 (black), 999-96450-501W (white)

What's in this Guide

This guide covers:

- Unpacking
- Physical features
- Switch settings
- Installation
- Controlling the camera using the IR remote
- Web interface: system administration and performance/behavior configuration
- Telnet and RS-232 API references
- Specifications
- Troubleshooting
- Warranty and compliance/conformity information

For your convenience, the information you need to install this product is also available in the smaller, stand-alone **Installation Guide for RoboSHOT HDBT High-Performance PTZ Cameras**, which covers unpacking, physical features, switch settings, installation, and initial power-up.

Download manuals, dimensional drawings, and other information from www.vaddio.com/support.

Camera Features

- HDBaseT camera with simultaneous HDMI and H.264 IP streaming (RTSP or RTMP)
- View the RTSP stream from the camera using any standards-based media viewer
- RoboSHOT 12 HDBT: Exmor[®] 1/2.8 type image sensor
- RoboSHOT 30 HDBT: Exmor R[™] back-lit 1/2.8 type, high-speed, low-noise image sensor
- RoboSHOT 12E HDBT and RoboSHOT 30E HDBT: Exmor R back-lit 1/2.5 type, high-speed, low-noise image sensor
- RoboSHOT 12 HDBT and RoboSHOT 12E HDBT: 12x optical zoom – perfect for small to medium rooms
- RoboSHOT 30 HDBT and RoboSHOT 30E HDBT: 30x optical zoom – for medium to large venues such as houses of worship, lecture theaters, IMAG systems
- Tri-Synchronous Motion[™] simultaneous 3-axis pan/tilt/zoom movement between presets
- Smooth, silent direct-drive motors – ultra-accurate positioning, from 120° per second down to 0.35° per second
- Designed for use with Vaddio OneLINK[®] camera extension devices
- Web interface for remote administration and operation, integration-ready Telnet or serial RS-232 control, presenter-friendly IR remote control

Unpacking the Camera

Make sure you received all the items you expected. Here are the packing lists for the RoboSHOT HDBT cameras.

Download manuals, dimensional drawings, and other information from www.vaddio.com/support.



Caution

Always support the camera's base when picking it up. Lifting the camera by its head or mounting arm will damage it.

RoboSHOT 12E HDBT, North America – 999-99600-000 (black), 999-99600-000W (white)

RoboSHOT 12E HDBT, Europe/UK – 999-99600-001 (black), 999-99600-001W (white)

RoboSHOT 12E HDBT, Australia/New Zealand – 999-99600-009 (black), 999-99600-009W (white)

- RoboSHOT 12E HDBT camera, black or white
- Thin Profile Wall Mount with mounting hardware, black or white, depending on camera color
- Vaddio IR Remote Commander
- PoE+ mid-span power injector with AC cord set(s)
- Quick-start guide



RoboSHOT 12 HDBT, North America – 999-9960-000 (silver/black)

RoboSHOT 12 HDBT, Europe/UK – 999-9960-001 (silver/black)

RoboSHOT 12 HDBT, Australia/New Zealand – 999-9960-009 (silver/black)

- RoboSHOT 12 HDBT camera
- Thin Profile Wall Mount with mounting hardware, black
- Vaddio IR Remote Commander
- 12 VDC, 3.0 A switching power supply with AC cord set(s)
- Quick-start guide



RoboSHOT 30E HDBT, North America – 999-99630-000 (black), 999-99630-000W (white)
RoboSHOT 30E HDBT, Europe and UK – 999-99630-001 (black), 999-99630-001W (white)
RoboSHOT 30E HDBT, Australia and New Zealand – 999-99630-009 (black), 999-99630-009W (white)

- RoboSHOT 30E HDBT camera (black or white)
- Thin Profile Wall Mount with mounting hardware, black or white, depending on camera color
- Vaddio IR Remote Commander
- PoE+ mid-span power injector with AC cord set(s)
- Quick-start guide



RoboSHOT 30 HDBT, North America – 999-9963-000 (black), 999-9963-000W (white)
RoboSHOT 30 HDBT, Europe and UK – 999-9963-001 (black), 999-9963-001W (white)
RoboSHOT 30 HDBT, Australia and New Zealand – 999-9963-009 (black), 999-9963-009W (white)

- RoboSHOT 30 HDBT camera, black or white
- Thin Profile Wall Mount with mounting hardware, black or white, depending on camera color
- Vaddio IR Remote Commander
- 12 VDC, 3.0 A switching power supply with AC cord set(s)
- Quick-start guide



RoboSHOT 12E HDBT OneLINK HDMI System for Cisco Codecs, North America – 999-95750-400 (black), 999-95750-400W (white)
RoboSHOT 12E HDBT OneLINK HDMI System for Cisco Codecs, Europe/UK – 999-95750-401 (black), 999-95750-401W (white)

- RoboSHOT 12E HDBT camera, black or white
- Thin Profile Wall Mount with mounting hardware, black or white, depending on camera color
- Vaddio IR Remote Commander
- OneLINK HDMI interface
- 48V power supply with AC cord set(s)
- 10.25 in. (26 cm) Cisco CAB-PHD4XS2-SPLIT cable
- 3 ft. (0.9 m) cat-5 cable, black
- 1 ft. (0.3 m) directional cat-5 cable for Cisco SX20
- 3 ft. (0.9 m) HDMI cable
- EZCamera RS-232 Control Adapter
- EZCamera RS-232 Control Adapter 998-1002-232 for Cisco codec serial 9-pin ports
- Application Note: Using RoboSHOT Series Cameras with Cisco Codecs
- Quick-start guides

RoboSHOT 12 OneLINK HDMI System for Cisco Codecs, North America – 999-9575-400 (silver/black)

RoboSHOT 12 OneLINK HDMI System for Cisco Codecs, Europe/UK – 999-9575-401 (silver/black)

- RoboSHOT 12 HDBT camera
- Thin Profile Wall Mount with mounting hardware, black
- Vaddio IR Remote Commander
- OneLINK HDMI interface
- 48V power supply with AC cord set(s)
- 10.25 in. (26 cm) Cisco CAB-PHD4XS2-SPLIT cable
- 3 ft. (0.9m) cat-5 cable, black
- 1 ft. (0.3m) directional cat-5 cable for Cisco SX20
- 3 ft. (0.9m) HDMI cable
- EZCamera RS-232 Control Adapter
- EZCamera RS-232 Control Adapter 998-1002-232 for Cisco codec serial 9-pin ports
- Application Note: Using RoboSHOT Series Cameras with Cisco Codecs
- Quick-start guides

RoboSHOT 12E HDBT OneLINK Bridge System for Cisco Codecs, North America – 999-96750-400 (black), 999-96750-400W (white)

RoboSHOT 12E HDBT OneLINK Bridge System for Cisco Codecs, Europe/UK – 999-96750-401 (black), 999-96750-401W (white)

- RoboSHOT 12E HDBT camera
- Thin Profile Wall Mount with mounting hardware, black or white, depending on camera color
- Vaddio IR Remote Commander
- OneLINK Bridge interface
- 48V power supply with AC cord set(s)
- Phoenix-style connectors, qty. 4
- 10.25 in. (26 cm) Cisco CAB-PHD4XS2-SPLIT cable
- 3 ft. (0.9 m) cat-5 cable, black
- 1 ft. (0.3 m) directional cat-5 cable for Cisco SX20
- 3 ft. (0.9 m) HDMI cable
- 6 ft. (1.8 m) USB 3.0 cable, type A to type B
- EZCamera RS-232 Control Adapter
- EZCamera RS-232 Control Adapter 998-1002-232 for Cisco codec serial 9-pin ports
- Application Note: Using RoboSHOT Series Cameras with Cisco Codecs
- Quick-start guides

RoboSHOT 12 OneLINK Bridge System for Cisco Codecs, North America – 999-9675-400 (silver/black)

RoboSHOT 12 OneLINK Bridge System for Cisco Codecs, Europe/UK – 999-9675-401 (silver/black)

- RoboSHOT 12 HDBT camera
- Thin Profile Wall Mount with mounting hardware, black
- Vaddio IR Remote Commander
- OneLINK Bridge interface
- 48V power supply with AC cord set(s)
- Phoenix-style connectors, qty. 4
- 10.25 in. (26 cm) Cisco CAB-PHD4XS2-SPLIT cable
- 3 ft. (0.9 m) cat-5 cable, black
- 1 ft. (0.3 m) directional cat-5 cable for Cisco SX20
- 3 ft. (0.9 m) HDMI cable
- 6 ft. (1.8 m) USB 3.0 cable, type A to type B
- EZCamera RS-232 Control Adapter
- EZCamera RS-232 Control Adapter 998-1002-232 for Cisco codec serial 9-pin ports
- Application Note: Using RoboSHOT Series Cameras with Cisco Codecs
- Quick-start guides

RoboSHOT 12E HDBT OneLINK HDMI System for Polycom Codecs, North America – 999-95450-500 (black), 999-95450-500W (white)

RoboSHOT 12E HDBT OneLINK HDMI System for Polycom Codecs, Europe/UK – 999-95450-501 (black), 999-95450-501W (white)

- RoboSHOT 12E HDBT camera
- Thin Profile Wall Mount with mounting hardware, black or white, depending on camera color
- Vaddio IR Remote Commander
- OneLINK HDMI interface
- 48V power supply with AC cord set(s)
- 2 ft. (0.6 m) fan-out cable for Polycom, codec side
- 3-position Phoenix-style connector
- EZCamera RS-232 Control Adapter
- Application Note: Using RoboSHOT Series Cameras with Polycom Codecs
- Quick-start guides

RoboSHOT 12 OneLINK HDMI System for Polycom Codecs, North America – 999-9545-500 (silver/black)

RoboSHOT 12 OneLINK HDMI System for Polycom Codecs, Europe/UK – 999-9545-501 (silver/black)

- RoboSHOT 12 HDBT camera
- Thin Profile Wall Mount with mounting hardware, black
- Vaddio IR Remote Commander
- OneLINK HDMI interface
- 48V power supply with AC cord set(s)
- 2 ft. (0.6 m) fan-out cable for Polycom, codec side
- 3-position Phoenix-style connector
- EZCamera RS-232 Control Adapter
- Application Note: Using RoboSHOT Series Cameras with Polycom Codecs
- Quick-start guides

RoboSHOT 12E HDBT OneLINK Bridge System for Polycom Codecs, North America – 999-96450-500 (black), 999-96450-500W (white)

RoboSHOT 12E HDBT OneLINK Bridge System for Polycom Codecs, Europe/UK – 999-96450-501 (black), 999-96450-501W (white)

- RoboSHOT 12E HDBT camera
- Thin Profile Wall Mount with mounting hardware, black or white, depending on camera color
- Vaddio IR Remote Commander
- OneLINK Bridge interface
- 48V power supply with AC cord set(s)
- 3-position Phoenix-style connectors, qty. 4
- 2 ft. (0.6 m) fan-out cable for Polycom, codec side
- 6 ft. (1.8 m) USB 3.0 cable, type A to type B
- EZCamera RS-232 Control Adapter
- Application Note: Using RoboSHOT Series Cameras with Polycom Codecs
- Quick-start guides

RoboSHOT 12 OneLINK Bridge System for Polycom Codecs, North America – 999-9645-500 (silver/black)

RoboSHOT 12 OneLINK Bridge System for Polycom Codecs, Europe/UK – 999-9645-501 (silver/black)

- RoboSHOT 12 HDBT camera
- Thin Profile Wall Mount with mounting hardware, black
- Vaddio IR Remote Commander
- OneLINK Bridge interface
- 48V power supply with AC cord set(s)
- 3-position Phoenix-style connectors, qty. 4
- 2 ft. (0.6 m) fan-out cable for Polycom, codec side
- 6 ft. (1.8 m) USB 3.0 cable, type A to type B
- EZCamera RS-232 Control Adapter
- Application Note: Using RoboSHOT Series Cameras with Polycom Codecs
- Quick-start guides

A Quick Look at the Camera

The cameras in the RoboSHOT line are similar in appearance.

- RoboSHOT 12 HDBT is silver, with a black base and stepped lens bezel
- RoboSHOT 30 HDBT is available in black or white, and has a fluted lens bezel
- RoboSHOT 12E HDBT and RoboSHOT 30E HDBT are available in black or white, and have smooth lens bezels

The image below shows a RoboSHOT 30 HDBT camera.

Front of the Camera



Camera and Zoom Lens

- **RoboSHOT 12 HDBT:** 12x optical zoom in Super-Wide mode, 10x optical zoom in normal mode. Recommended for small to medium sized conference rooms.
- **RoboSHOT 12E HDBT:** 12x optical zoom; recommended for small to medium sized conference rooms.
- **RoboSHOT 30 HDBT and RoboSHOT 30E HDBT:** 30x optical zoom; best suited to larger rooms.

IR Sensors: Sensors in the front of the camera base receive signals from the remote. Make sure there's nothing directly in front of the camera base, and point the remote at the camera.

Status indicator: The multicolored LED indicates the camera's current state.

Really Cool Logo Badge (RCLB): Attractive and shiny, with a sophisticated brushed-metal finish.

Back of the Camera – RoboSHOT 12E HDBT and RoboSHOT 30E HDBT

Rear panel connections are identical for the RoboSHOT 12E HDBT and RoboSHOT 30E HDBT cameras.



From left to right:

- **OneLINK HDBaseT:** RJ-45 connector. Connect to the network via PoE+ injector or OneLINK device for power, video, streaming, and control via the web interface or Telnet session.
- **HDMI:** HDMI video output connector.
- **HD Video Resolution Select:** Rotary switch to select the video output resolution. See [Video Resolution Setting](#).

Note

A label on the bottom of the camera lists the rotary switch settings.

Back of the Camera – RoboSHOT 12 HDBT and RoboSHOT 30 HDBT

Rear panel connections are identical for the older RoboSHOT 12 HDBT and RoboSHOT 30 HDBT cameras.



From left to right:

- **12 VDC, 3.0 A:** EIAJ-04 jack for local power. Connect only the power supply shipped with the camera or approved replacement 12 VDC, 3A power supply. This connection is not needed if you use a OneLINK device or a PoE+ power injector.
- **OneLINK HDBaseT:** RJ-45 connector. Connect to the network (optionally via PoE+ injector) or to a OneLINK device for streaming and for control via the web interface or Telnet session.
- **HDMI:** HDMI video output connector.
- **HD Video Resolution Select:** Rotary switch to select the video output resolution. See [Video Resolution Setting](#).
- **Camera Settings:** DIP switches to set camera behaviors such as IR remote frequency, baud rate and image flip. See [Camera Behavior Settings – RoboSHOT 12 HDBT and RoboSHOT 30 HDBT](#) for more information.

Note

A label on the bottom of the camera lists the rotary and DIP switch settings.

Installing the Camera

This section covers:

- Selecting the location for the camera
- Installing the camera mount
- Information on cables and RS-232 communication
- Settings for the physical switch(es) on the camera
- Connection diagrams
- Mounting the camera

And a required safety note here:

Note

PoE type networks connected to this equipment are for intra-building use only and should not be connected to lines that run outside of the building in which this product is located.

Don't Void Your Warranty!



Caution

Always support the camera's base when picking it up. Lifting the camera by its head or mounting arm will damage it.

Caution

This product is for indoor use. Use an appropriate protective enclosure if installing it outdoors or in a humid environment.

Do not install or operate this product if it has been dropped, damaged, or exposed to liquids. If any of these things happen, return it to Vaddio for safety and functional testing.

Caution

If using a DC power supply with this product, use the power supply included with it or recommended for use with it. Always check the output voltage listed on the power supply label, as power supplies for different products may look nearly identical. Using the wrong power supply will void the warranty, possibly causing unsafe operating conditions and damage to the product.

Before You Start

Things to keep in mind when deciding where to install the camera:

- Consider camera viewing angles, lighting conditions, line-of-sight obstructions, and in-wall obstructions.
- If the IR Remote Commander will be used, ensure that nothing blocks the IR lens in the camera's base.
- Ensure that the camera body can move freely and point away from the ceiling and lights.

Prepare for a successful installation:

- Be sure you can identify all cables correctly.
- Check Cat-5 cables for continuity.
- Ensure that the video resolution rotary switch and the DIP switches (if any) are set appropriately.
- *Talk to the network administrator.* If installing the camera in a non-DHCP network (one that does not automatically assign IP addresses), you may need to configure the camera with a static IP address as directed by the network administrator before connecting it to the network. Work with the network administrator to determine how to configure the equipment.

Installing the Wall Mount

The camera is shipped with a Thin Profile Wall Mount. Other mounting options are available as well. Contact us if you don't have the camera mount you need.

If you are installing a OneLINK camera extension system with the camera, attach the EZIM (the smaller unit) to the camera mount and route the camera cables through the opening before you install the mount.

You can install the camera wall mount to a 2-gang wall box or directly to the drywall.

- If you mount it to drywall, use the wall anchors provided with the wall mount.
- If you mount it to a wall box, use the cover plate screws supplied with the wall box.

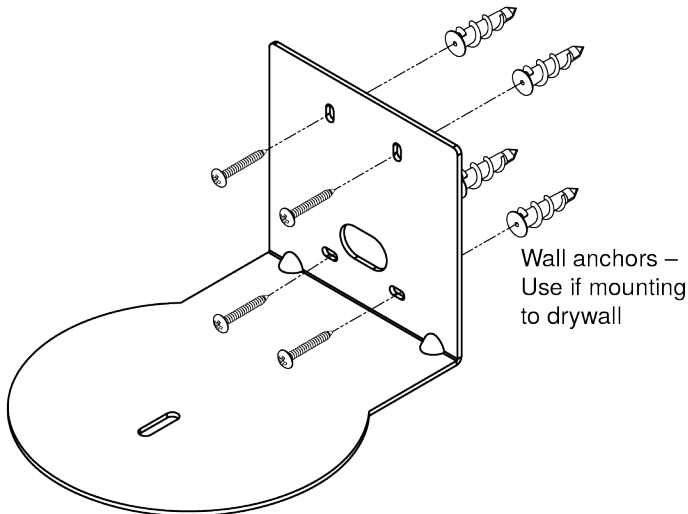

About Ceiling-Mounted Cameras

If you use an inverted mount, set the camera's Image Flip DIP switch ON for inverted operation. This orients the video image correctly and sets the tilt motors to respond appropriately to tilt up and down commands from the remote, web interface, and connected control devices. For RoboSHOT Elite series cameras, this switch is available to the administrator on the System page of the web interface.

Note

If mounting this camera using the Half-Recessed Ceiling Mount, you will need to power the mount's IR receiver separately to use the IR remote with the camera. Use Power Extension Module 999-1005-021. This camera does not supply power to the mount's IR receiver.

Video Resolution Setting

Non-architectural RoboSHOT cameras use a rotary switch to set output resolution. Streaming resolution is set separately in the web interface.

Set the desired video output resolution with the rotary switch before installing the camera. Note that the video resolutions are mapped differently on the rotary switch for the newer Elite-series cameras.

RoboSHOT 12E HDBT and RoboSHOT 30E HDBT only: If the camera has been updated to version 3.1.0 firmware or later, Position 0 selects software control. Set video output resolution in the web interface. The default resolution is 1080p/59.94. This capability is not available in earlier firmware versions or on the older RoboSHOT 12 HDBT and RoboSHOT 30 HDBT cameras.

See [Software-Controlled Video Output Resolution Setting](#).

RoboSHOT 12 HDBT and RoboSHOT 30 HDBT cameras



Position	Resolution	Position	Resolution
0	720p/59.94	8	1080p/50
1	1080i/59.94	9	
2	1080p/59.94	A	
3	720p/60	B	
4	1080i/60	C	
5	1080p/60	D	
6	720p/50	E	1080p/30
7	1080i/50	F	1080p/25

RoboSHOT 12E HDBT and RoboSHOT 30E HDBT cameras



Position	Resolution	Position	Resolution
0	Software Control	8	1080p/29.97
1	1080p/60	9	1080p/25
2	1080p/59.94	A	720p/60
3	1080p/50	B	720p/59.94
4	1080i/60	C	720p/50
5	1080i/59.94	D	
6	1080i/50	E	Factory Reset
7	1080p/30	F	

Camera Behavior Settings – RoboSHOT 12 HDBT and RoboSHOT 30 HDBT

Older RoboSHOT cameras use DIP switches to set camera behaviors; the RoboSHOT Elite series cameras set all camera behaviors in the web interface.

A label on the bottom of the camera provides a quick reference for setting the switches.

Set the switches appropriately before mounting the camera.

After the camera is installed, you can read the switches from the camera's web interface.

Note

When the camera is not inverted, DIP switches are in their default positions when they are up.

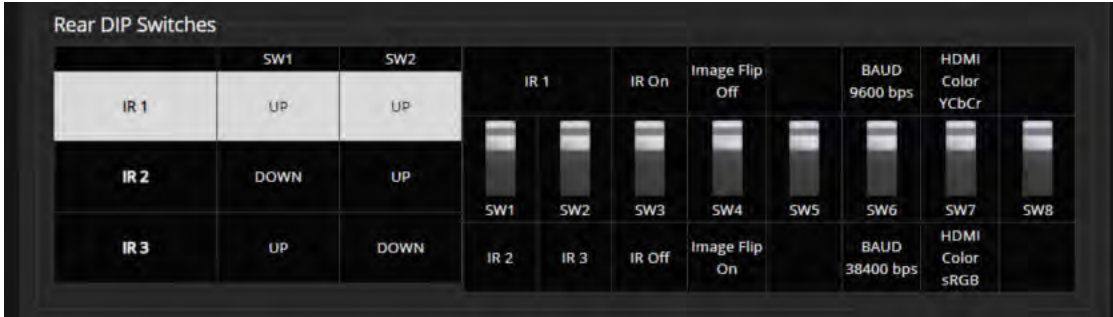

(RoboSHOT 30 HDBT shown; Switch 5 is Super Wide Mode if the camera is a RoboSHOT 12 HDBT.)

IR1, IR2, IR3 (Frequency Selection): If there are multiple cameras in the room, use **switches 1 and 2** to configure each with a different IR frequency to allow the IR Remote Commander to control them independently. Then use the Camera Select buttons at the top of the remote to select the camera you want to control.

- SW1 and SW2 up: IR frequency 1
- SW1 down, SW2 up: IR frequency 2
- SW1 up, SW2 down: IR frequency 3

IR: Leave **switch 3** UP if the IR remote will be used.

Image Flip: If mounting the camera upside-down, set **switch 4** DOWN: IMAGE FLIP ON. This orients the video image correctly and sets the tilt motors to respond appropriately to tilt up and down commands from the remote, web interface, and connected control devices.

Super Wide Mode (RoboSHOT 12 HDBT only): To use Super-wide mode, set **switch 5** DOWN. This gives 12X zoom with a 73° horizontal field of view. Normal mode provides 10X zoom with a 67.2° horizontal field of view (HFOV).

Baud Rate: Set **switch 6** to the baud rate of the RS-232-capable control device connected via OneLINK. The default is 9600 bps. The 38400 baud setting is optional if the connected control device supports it.

Leave **Switch 7** UP unless sRGB color output is needed.

For RoboSHOT 30 HDBT, **Switch 5** is not used. **Switch 8** is not currently used on either RoboSHOT 12 HDBT or RoboSHOT 30 HDBT.

RS-232 Serial Communication Settings

The RS-232 serial port (color-coded blue) provides a means of controlling the camera from a third-party device. Be sure the camera is set to the same baud rate as the external control device.

If the camera is powered by a OneLINK device, an RS-232 port is available on the OneLINK for an external control device. Be sure the camera is set to the same baud rate as the external control device.

Specification	Value
Communication Speed	9600 or 38400 baud, selectable
Number of start bits	1
Number of stop bits	1
Number of data bits	8
Parity	None
Flow control	None

The camera's default baud rate is 9600. The 38400 baud setting is optional if the connected device supports it.

Cabling Notes

Caution

When making cables, do not use pass-through RJ-45 connectors. If they are crimped incorrectly, they can damage the connectors on the product, cause intermittent connections, and degrade signal quality. Physical damage to the connectors may void your warranty.



Intact – will make reliable contact with cable connector



Damaged – Bent contact fingers will NOT make reliable contact with cable connector

Use Cat-5e or better cable. We recommend using high-quality connectors and a high-quality crimping tool. We recommend shielded cabling if the cables will be coiled, run tightly with other cables, or placed close sources of electromagnetic interference such as power lines.

Caution

Check your cables. Connecting a cable to the wrong port or using the wrong pin-out can result in equipment damage and will void the warranty.



Pro Tip

To prevent tragic mishaps, label both ends of every cable.

Connecting the Camera

Note

Talk to the network administrator before you connect the equipment.

If you install this equipment on a non-DHCP network (one that uses only static IP addresses), you may need to configure the camera with a static IP address before you connect it to the network. Work with the network administrator to determine how to configure the equipment.

See [Configuring the Camera with a Static IP Address](#) for step-by-step instructions to configure a static IP address.

Basic Connections – RoboSHOT 12E HDBT or RoboSHOT 30E HDBT

This diagram shows a basic installation for a RoboSHOT 12E HDBT or RoboSHOT 30E HDBT. The older RoboSHOT HDBT cameras can be connected in the same way, using a PoE+ mid-span power injector.



Basic Connections – RoboSHOT 12 HDBT or RoboSHOT 30 HDBT

This diagram shows a basic installation for a RoboSHOT 12 HDBT or RoboSHOT 30 HDBT camera.

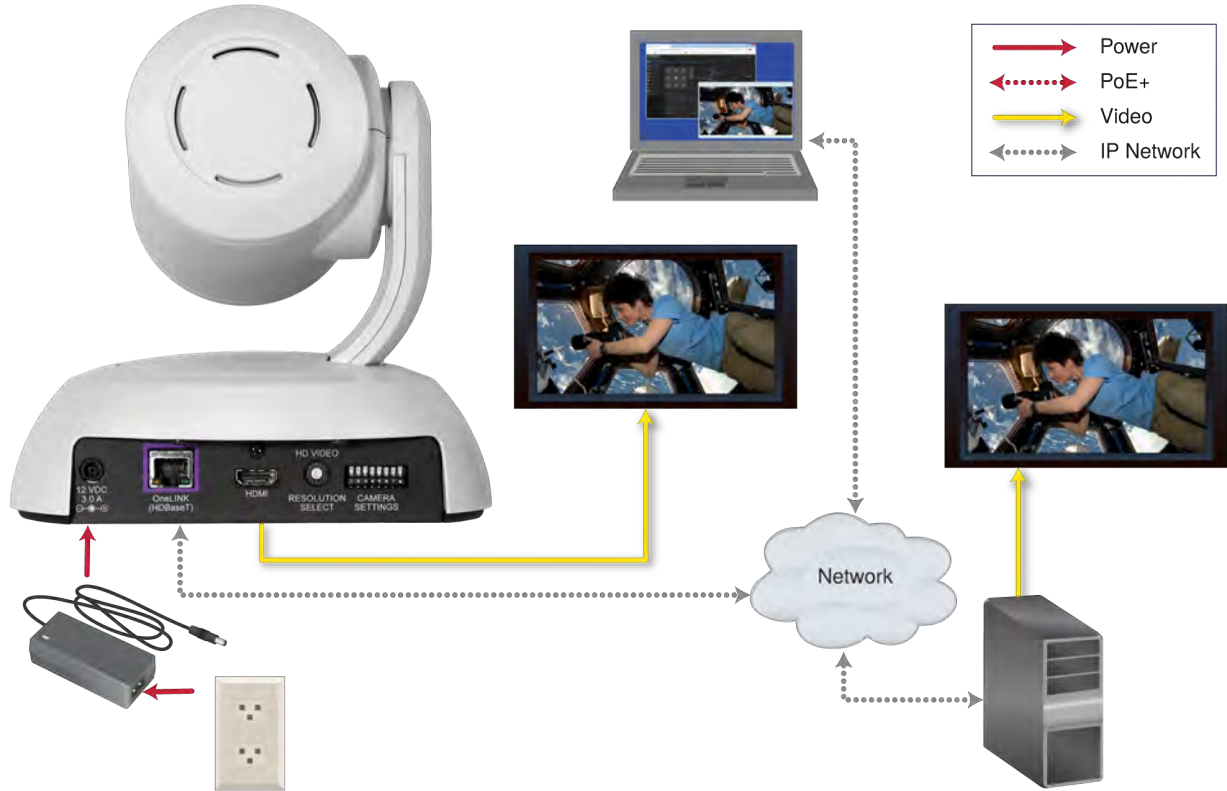

Basic Connections – RoboSHOT HDBT with Camera Extension

This diagram shows a RoboSHOT 12 HDBT camera connected to a OneLINK HDMI interface to extend power, video, and control over a single cable. The RoboSHOT 12E HDBT, RoboSHOT 30 HDBT, and RoboSHOT 30E HDBT can be connected in the same way.



Basic Connections – RoboSHOT HDBT Basic Conference Setup

This diagram shows a RoboSHOT 12 HDBT camera with a OneLINK Bridge interface in a basic conference room installation. The RoboSHOT 12E HDBT, RoboSHOT 30 HDBT, and RoboSHOT 30E HDBT can be connected in the same way. Note that the speakers must be connected to an amplifier.



Basic Connections – RoboSHOT HDBT Camera with Third-Party Control and Power

This example shows basic connections using a Crestron device. This diagram shows a RoboSHOT 12 HDBT camera. The RoboSHOT 12E HDBT, RoboSHOT 30 HDBT, and RoboSHOT 30E HDBT can be connected in the same way. Connection details vary depending on the equipment and functionality to be used in your installation.



Options for Power and Other Connections – RoboSHOT 12 HDBT and RoboSHOT 30 HDBT

Use the provided 12 VDC power supply – Network and video output require separate connections.

Connect the camera to a OneLINK® device – A single Cat-5e (or better) cable to the OneLINK/HDBaseT connector provides power, control, network, and video connectivity. Network, video output, and RS-232 control are connected at the OneLINK receiver. Do not use the camera's 12 VDC power supply in this configuration.

Use a PoE+ power injector – Connect to the network through a PoE+ power injector. Video output requires a separate connection. In most cases, you do not need to use the camera's 12 VDC power supply in this configuration.

Installing the Camera

Be sure you have already set the camera's switches.

Caution

Check your cables. Connecting a cable to the wrong port or using the wrong pin-out can result in equipment damage and will void the warranty.

1. Route the cables to the camera location.
2. Route the cables through the mount, and install the mount on the wall or attach it to the wall box. Leave the screws loose enough to adjust the position of the mount.
3. Level the mount and tighten the mounting screws.
4. Connect the cables to the camera.

Caution

If using local power rather than connecting to a OneLINK extension module or using PoE+, use the power supply shipped with the camera. Using a different power supply may create an unsafe operating condition or damage the camera, and will void the warranty.

Caution

5. Place the camera on the mount.

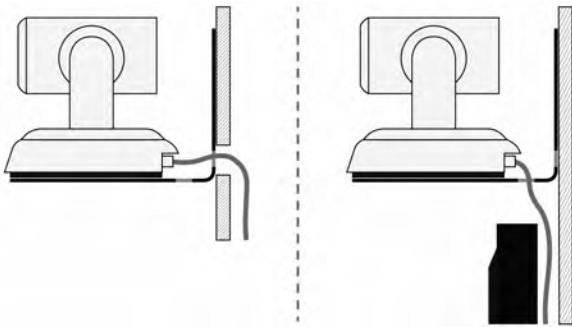

6. Attach the camera to the mount using the 1/4"-20 x .375 mounting screw supplied with the camera.

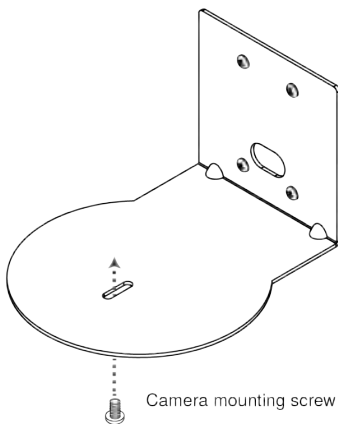

Images for illustration only; not to scale. Camera and mount details may differ.

Powering Up the Camera

Connect camera power.

The camera will run a self-test routine and move to its home position. This will take a few seconds.

When the camera is initialized and ready, video is available and the status light is blue. At this point, the camera is ready to accept control information.

Note

Wait until the camera finishes initializing before trying to operate or control it.

Status Light

The light in the camera's base indicates its current state.

- **Blue:** Normal operation (blinks once when the camera receives a command from the remote)
- **Red:** On-air tally (signal provided by external device via serial connection)
- **Blinking red:** Video is muted (UC color scheme only)
- **Purple:** In standby mode or booting
- **Yellow:** Firmware update in progress

Caution

Do not remove power or reset the camera while the indicator is yellow, showing a firmware update in progress. Interrupting a firmware update can make the camera unusable.

Note

By default, the camera's status light is active during normal operation; however, it can be configured to remain off when the camera is powered up. The camera may be sending video even if the indicator light is off.

Using the IR Remote

The IR remote provides basic camera control.

IR Remote Cheat Sheet

What do you need to do?	Button(s)	
Power on or standby	Power (green button at top right)	
Select the camera to control (if this remote controls more than one)	Camera Select buttons 1 through 3 (second row of buttons)	
Discover the camera's IP address	Data Screen button (top left) – press and hold for 3 seconds.	
Move the camera	Arrow buttons and Home button (dark red)	
Move the camera to a preset position	Position Preset buttons 1 through 6 (bottom two rows)	
Focus the camera	Auto Focus button (near arrow buttons) Manual Focus buttons Near and Far (below Zoom Speed buttons)	
Control zoom speed	Zoom Speed buttons (light gray) - Slow T and W , Fast T and W for telephoto (zoom in) and wide-angle (zoom out) modes	
Adjust for excess light behind the camera's subject	Back Light button (top center)	

IR Remote Details

The Vaddio remote provides the following functions:

Power – Switch the selected camera on or off.

Power indicator – Lights momentarily when you press a button.

Back Light – Use or turn off Back Light Compensation.

Data Screen – Display the camera's IP address and MAC address. Press this button again to dismiss the display.

Camera Select – In multi-camera installations, selects the camera to be controlled.

For older cameras with DIP switches on the back, see [DIP Switches: Camera Behavior Settings](#) for information on configuring the camera as camera 1, 2, or 3. For the newer Elite series cameras, see [Basic Camera Settings for RoboSHOT 12E CAT-5 and RoboSHOT 30E CAT-5](#).

Pan/Tilt (arrow button) controls and Home button – Control the camera's position.

Rev. Pan and Std. Pan– Control how the camera responds to the arrow buttons. Helpful for ceiling-mounted cameras and for presenters who are controlling the camera.

Pan/Tilt Reset – Not used.

Auto Focus – Switch the camera to Auto-Focus mode.

Zoom Speed – Select Slow or Fast movements for telephoto and wide-angle shots.

- T slow and T fast – Telephoto (zoom in)
- W slow and W fast – Wide-angle (zoom out)

Manual Focus – Switch the camera to Manual Focus mode.

Near (-) adjustment – Moves the focus nearer when in manual focus mode.

Far (+) adjustment – Moves the focus farther when in manual focus mode.

Preset – Save the camera's current position as one of the numbered presets.

Reset – Clear a saved preset.

Position Presets 1 through 6 – Move the camera to a predefined position, or specify the preset to save or clear.

The web interface offers greater control over camera movements to presets (such as setting the speed for Tri-Synchronous Motion), and provides additional presets.

Storing a Preset Using the Remote

Position the camera. Then hold down the Preset button and press one of the numbered preset buttons.

Clearing a Preset Using the Remote

Press and hold the Reset button while pressing the preset number you want to clear.



Web Interface

The camera's web interface allows control via a network connection, using a browser. Password-protected pages provide administrative access to tasks such as setting passwords, changing the IP address, viewing diagnostics, and installing firmware updates. The user login (or guest access, if it is enabled) provides access to camera controls similar to those available from the IR remote.

You will need to know the camera's IP address to use its web interface. If the network has a DHCP server, the camera will get its IP address, gateway and routing information automatically and you will be able to browse to it. If not, you will need to configure the camera to use a static IP address.

For cameras powered by a OneLINK HDMI or OneLINK Bridge: The OneLINK device has its own web interface. Refer to the appropriate OneLINK manual for information on its web interface.

Getting the Camera's IP Address

You will need to be able to view the camera's video output.

1. Press the Data Screen button on the remote. The display presents the camera's IP address and MAC address.
2. Press the Data Screen button again to dismiss the information.

If the address is 169.254.1.1, the camera is using its default IP address. This usually means one of these things:

- The network automatically assigns IP addresses, but the camera is not connected to the network.
- The network does not automatically assign IP addresses, and you need to configure the camera for the network. See [Configuring the Camera with a Static IP Address](#).

Accessing the Web Interface

Enter the IP address or hostname in your browser's address bar. You may need to enter `http://` or `https://` as a prefix to keep the browser from treating it as a search query.

(Example: `http://10.30.200.125`)

Note

The cameras in the RoboSHOT product line all have very similar web interfaces. Although some of the screen shots in this manual may be from different models of camera than the one you have, your camera's web interface should present the same controls, organized in the same way.

Browser Support

We have tested this product with these web browsers:

- Chrome®
- Microsoft® Internet Explorer®
- Safari®
- Firefox®

We test using the browser version available from the vendor at that time. Older versions of these browsers are likely to work, and other browsers may also work.

User Access

By default, the web interface opens to the Controls page, but the camera can be configured to require a user login. The default user password is **password**, but this can be changed. Check with the system administrator if the camera's web interface requires you to log in.

Only the Controls page is available with user-level access.

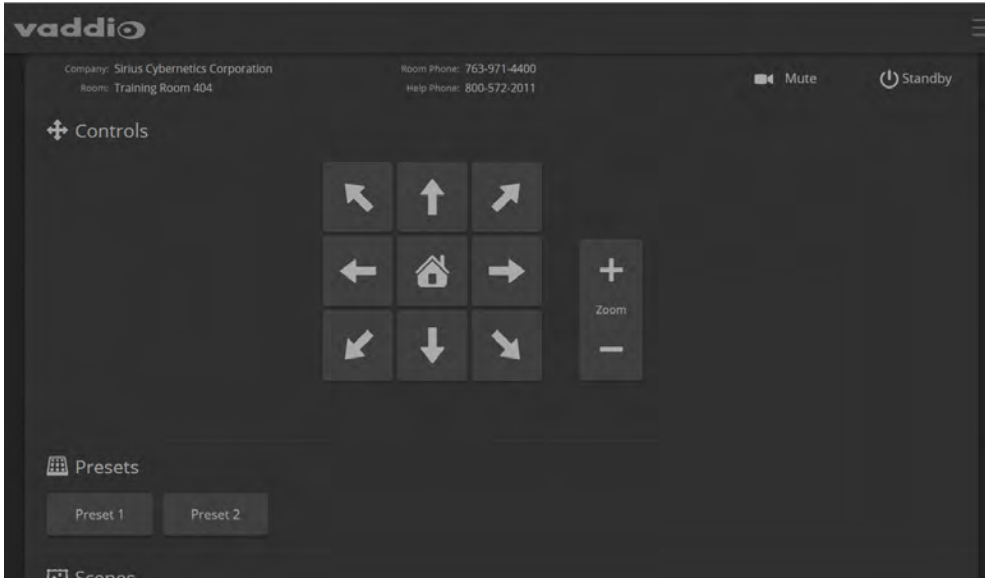

Your camera's Controls page will look somewhat different.

Administrative Access

If you are on the Controls screen, you're logged in at the user level, or guest access is enabled and you're not logged in at all.

Your camera's web interface will look somewhat different from this image.

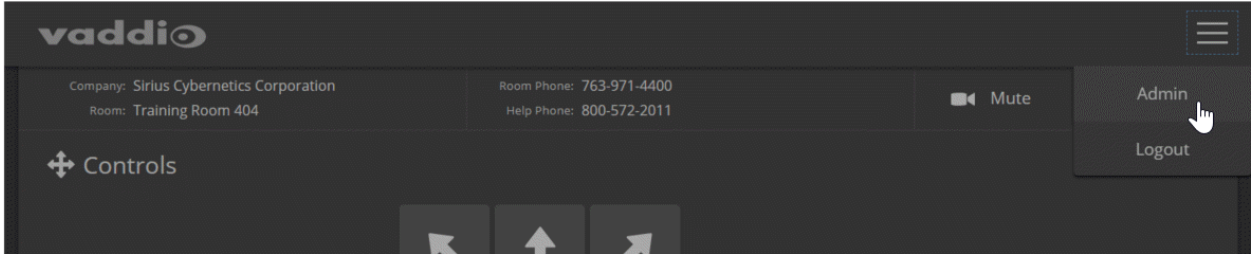

Open the menu to log on as Admin. The default admin password is **password**, but this can be changed.

Note

For best security, Vaddio strongly recommends changing the user and admin passwords from the default. Using the default passwords leaves the product vulnerable to tampering.

The admin account has access to system administration tasks and performance/behavior configuration tasks. System administration tasks are on the following pages, listed in the lower portion of the left navigation panel:

- Networking page – Configure date and time settings, hostname, and IP addressing.
- Security page – Set passwords, manage guest access, and enable/disable Telnet access.
- System page – View firmware version and switch settings, reboot, restore factory defaults, and update firmware.
- Room Labels page – Information to display on the web interface screens, including the conference room name and phone number and the in-house number for AV assistance.
- Help page – Tech support contact information and a link to the product information library on the Vaddio website.
- Diagnostics page – View or download the diagnostic log when troubleshooting issues.

Performance and behavior configuration tasks are on the following pages, listed in the upper portion of the left navigation panel:

- Camera page – Control the camera, make adjustments, create and manage presets and CCU scenes.
- Streaming page – Configure IP streaming.

Compact Menu View

By default, the navigation buttons in the camera's administrative interface display an icon and a text label. You can also select the compact view of the menu buttons along with the standard view. The button at the bottom of the menu toggles between the two views.

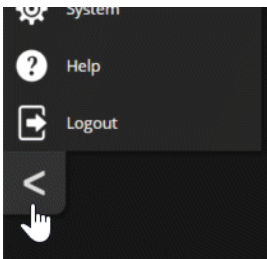

Web Interface Cheat Sheet

Where to find the camera controls you need right now.

What controls do you need?	Go to this screen
Camera operation <ul style="list-style-type: none"> ■ Stop sending video (video mute) ■ Enter or exit standby mode 	(any page)
Camera operation <ul style="list-style-type: none"> ■ Move or zoom the camera manually ■ Move to a camera preset (Presets section, if available) ■ Select the appropriate lighting adjustments (CCU Scenes section, if available) 	Controls (user or guest access) or Camera (admin access)
Camera behavior and adjustments <ul style="list-style-type: none"> ■ Set or clear presets ■ Set the speed for pan, tilt, or zoom motions ■ Focus the camera ■ Work with color and lighting adjustments (CCU scenes) ■ Set motors for inverted operation (Settings button reveals the control) 	Camera
Camera behavior settings – RoboSHOT 12E HDBT and RoboSHOT 30E HDBT On older RoboSHOT cameras, these settings are on the rear panel DIP switches. <ul style="list-style-type: none"> ■ IR1, IR2, IR3 (Frequency Selection) for controlling up to 3 cameras independently with the remote ■ IR on/off for enabling/disabling control via the remote ■ Image Flip for inverted camera installation ■ Baud rate for RS-232 serial communication ■ HDMI color space (YCbCr or sRGB; default is YCbCr) 	System (DIP Switches tab)
Advanced camera settings <ul style="list-style-type: none"> ■ Super-wide field of view (not available on 12E and 30E models) ■ Indicator light – select color scheme, enable/disable, set behavior in standby mode ■ Codec control mode 	System (DIP switches tab, General tab)
Read-outs of the camera's hardware switch settings	System (DIP switches tab)
Access management <ul style="list-style-type: none"> ■ Guest access ■ Account passwords ■ Idle session time-out ■ Telnet access enabled/disabled ■ Advanced security settings 	Security
IP streaming settings <ul style="list-style-type: none"> ■ Quality, resolution, and frame rate ■ RTSP streaming URL and path ■ RTMP service provider configuration 	Streaming
Network settings	Networking

What controls do you need?	Go to this screen
<ul style="list-style-type: none"> ■ Hostname ■ DHCP or static addressing ■ Static: IP address, subnet mask, gateway 	
Time zone and NTP server (source for system time/date)	Networking
Information about the camera location Help desk phone number for end users	Room Labels
Vaddio Technical Support contact information	Help
Diagnostic logs	Diagnostics

System Administration

This chapter covers settings for managing the camera as an element of your network.

Administrative tasks are on these pages of the web interface:

- Networking – Time settings, hostname, and other network configuration
- Security – Passwords, guest access, other IT security-related settings
- Room Labels – Helpful information to display in the web interface
- System – Controls to reboot, reset to factory defaults, and run firmware updates, read the rear panel switches, and access the soft DIP switches
- Help – Contact information for Vaddio Technical Support and a link to the documentation for this product
- Diagnostics – Logs to help Vaddio Technical Support troubleshoot issues

See [Configuring Camera Behavior](#) for information on image adjustments, streaming configuration, and other items related to camera behavior.

Note

Vaddio's RoboSHOT series cameras all have very similar web interfaces. Some of the screen shots in this manual may be from other models in the RoboSHOT series.

For Non-DHCP Environments: Configuring the Device with a Static IP Address for Initial Installation

NETWORKING PAGE

Caution

Consult your IT department before editing network settings. Errors in network configuration can make the camera inaccessible from the network. Do not change DHCP/Static addressing, IP address, subnet mask, or gateway unless you are very familiar with the characteristics and configuration of the network where you install the camera.

By default, the camera is set to DHCP and you do not need to configure it with a static IP address.

However, if no DHCP server is available to automatically assign an address, the camera will use the default IP address of 169.254.1.1. If this is the case, you may need to follow this procedure.

If you install more than one camera on a network that does not automatically assign IP addresses (a non-DHCP network), follow this procedure to prevent IP address conflicts.

Note

If the camera is currently at an IP address other than 169.254.1.1, skip this section unless you are instructed to configure the camera with a static IP address.

To access the camera's Networking page during installation (skip this procedure if the camera has already been in service on this network):

1. Connect the camera according to the connection diagram, but *do not connect the camera to the network*.
2. Connect the network port on the camera to the network port on a computer. Depending on the computer, you may need a crossover cable.
3. On the computer, open a browser and access the camera's web interface at **http://169.254.1.1**.
4. Log in as admin. The default password is **password**.

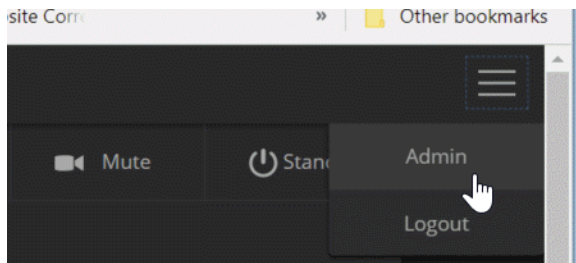

5. Navigate to the Networking page.

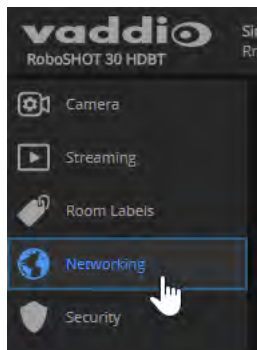

To configure the camera with a static IP address:

1. Work with your IT department to determine the correct IP address, subnet mask, and gateway to assign.
2. On the Networking page, set IP Address to Static.
3. Enter the IP address, subnet mask, and gateway as directed by the IT staffer; then save your work.

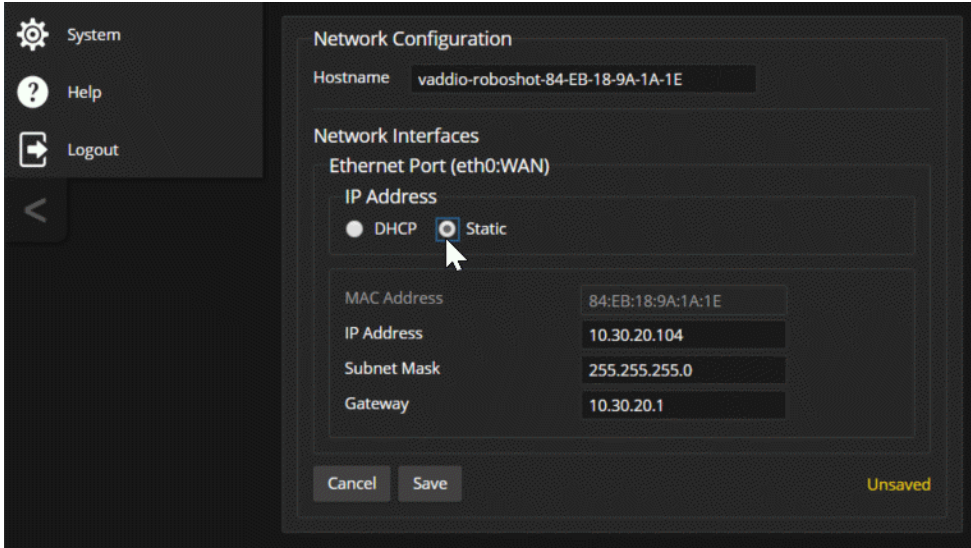

The camera is now ready to be connected to the network.

Changing the Camera's Hostname

NETWORKING PAGE

If your network supports hostname resolution, you may find it convenient to change the camera's hostname to something easy to remember, such as **camera-center-boardroom**.

Work with your IT department to ensure that the new hostname conforms to the organization's naming conventions.

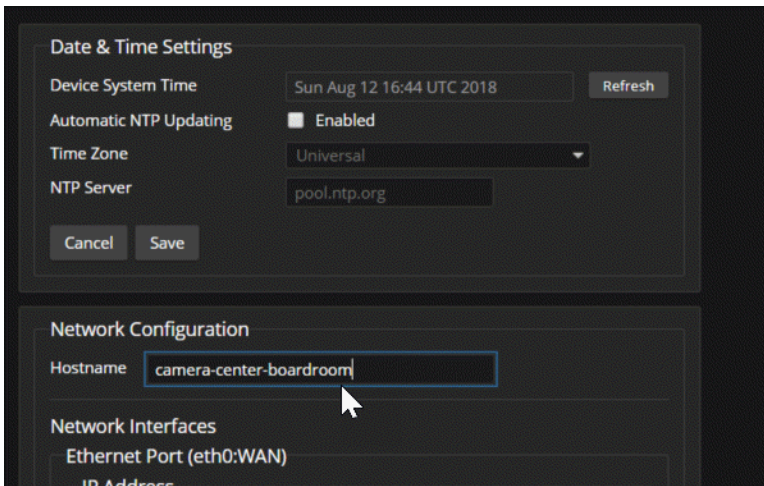

Optional For DHCP Environments: Changing from a DHCP Address to a Static IP Address

NETWORKING PAGE

In a network that assigns IP addresses automatically, the camera's IP address may change from time to time. To keep this from happening, set the IP address to Static. *Do not change the IP address, subnet mask, or gateway unless the network administrator instructs you to do so.*

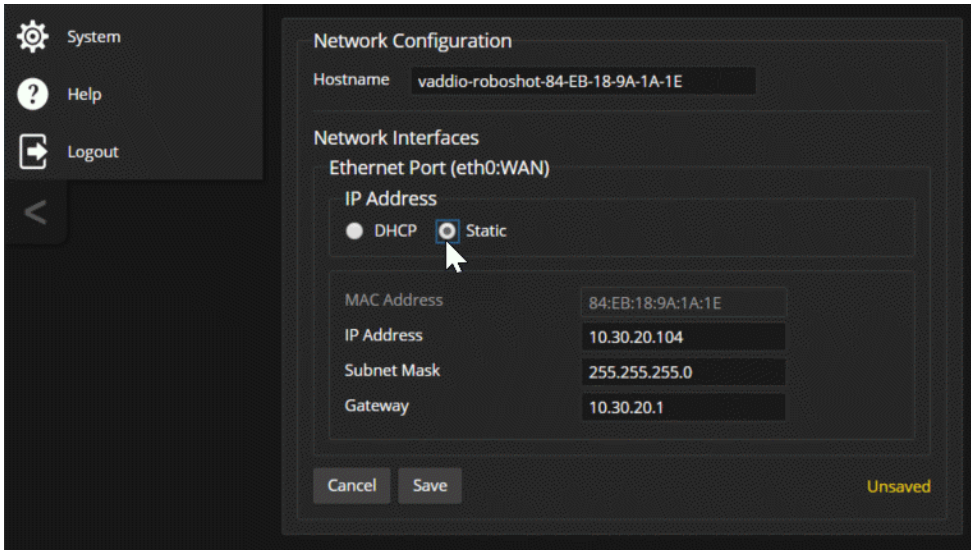

Specifying Time Zone and NTP Server

NETWORKING PAGE

Using automatic NTP updating ensures that the timestamps in the camera's diagnostic log are accurate. Specifying your time zone may make it easier to match logged events with other actions and external events.

1. To make the time zone and NTP server editable, enable Automatic NTP Updating.
2. Select the desired time zone from the list.
3. If desired, specify the NTP server to use. Otherwise, use the default.

You may need to refresh the system time display.

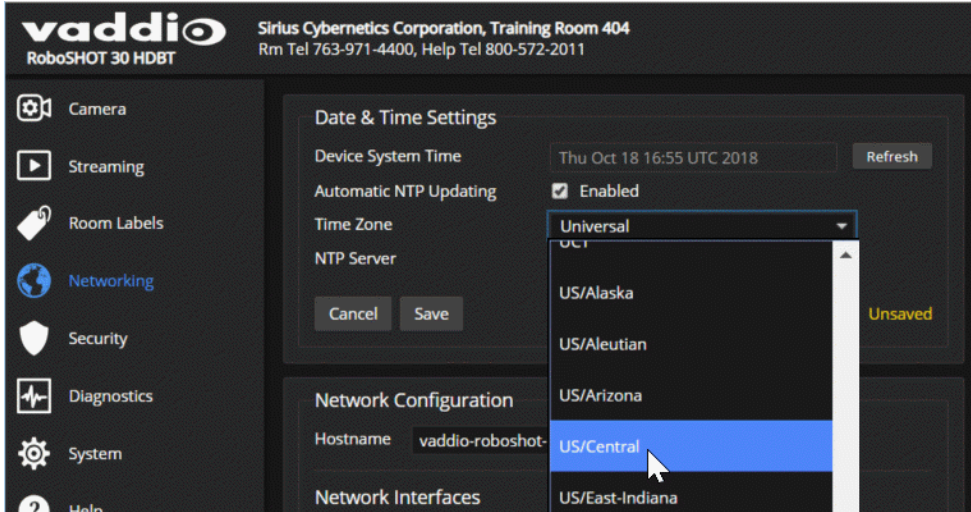

Managing Access and Passwords

SECURITY PAGE

Set the camera according to your organization's security policies:

- Allow or deny access to the Camera screen without logging on (Allow Guest Access) – this is enabled by default
- Set whether inactive sessions log off automatically or not (Automatically Expire Idle Sessions) – by default, inactive sessions expire after 30 minutes
- Change the password for the `admin` account
- Change the password for the `user` account
- Allow or disable access via Telnet (by default, access via Telnet is enabled)
- Require HTTPS for web access (by default, HTTP is also permitted)
- Allow or deny device discovery (allowed by default)

Note

Consult your network security specialist before changing any of these settings.

Note

For best security, Vaddio strongly recommends changing the user and admin passwords from the default. Using the default passwords leaves the product vulnerable to tampering.

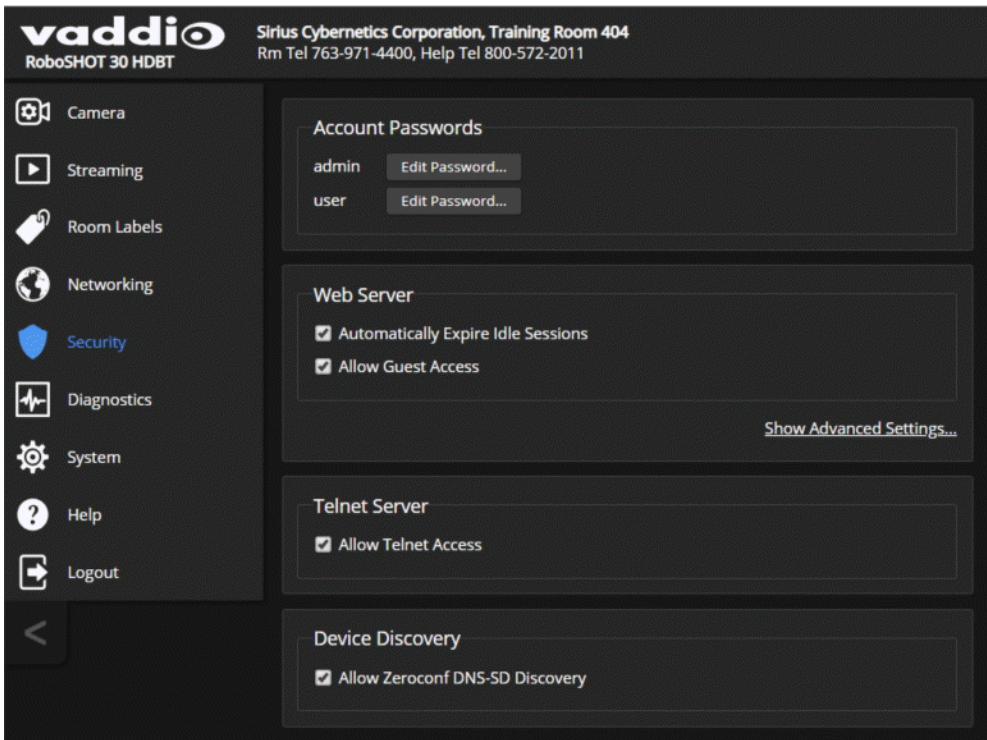

Disabling Telnet Access

SECURITY PAGE

If your installation does not require camera access via Telnet, you may choose to disable the camera's internal Telnet server.

Enabling or Requiring HTTPS

SECURITY PAGE

By default, the web interface uses the HTTP protocol. You can configure the camera's web interface to require a secure HTTPS connection instead.

Caution

Consult your network security professional to manage the camera's SSL certificate. Do not make any changes in the Certificate or Private Key text boxes without guidance from your organization's network security professional.

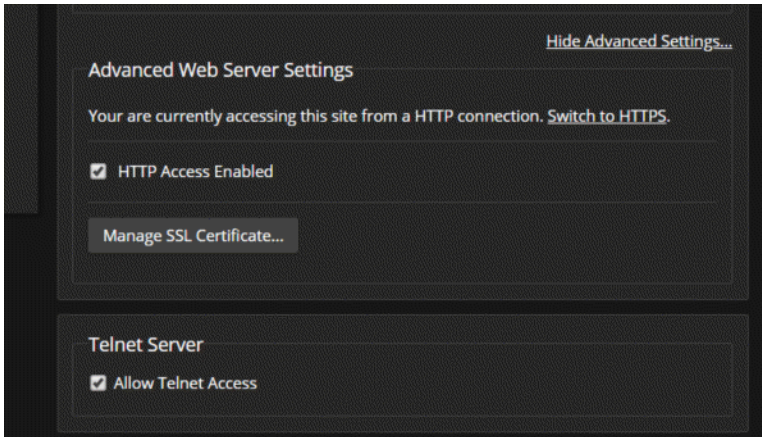

1. Select Show Advanced Settings. The advanced options open.
2. To switch to a secure HTTPS connection, select Switch to HTTPS.

Note

Your browser may present messages warning you that your connection is not secure, because the site's certificate is not valid. This happens when HTTPS is used but no SSL certificate is installed.

3. To require HTTPS connections, clear the box labeled HTTP Access Enabled. The camera's web interface will only be available via an HTTPS connection.

Adding Room Information to the Camera's Web Interface

ROOM LABELS PAGE

The information you enter on this page is displayed on every page of the web interface.

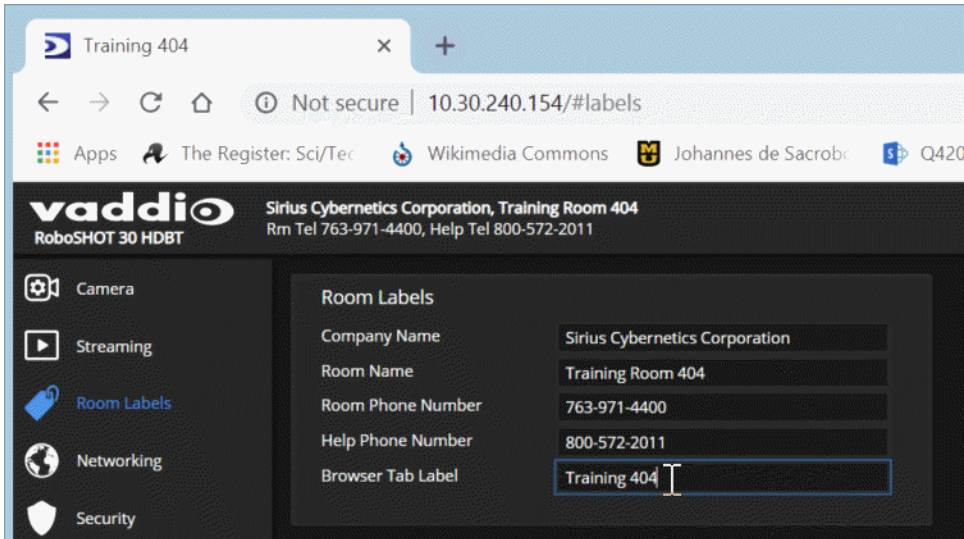

Saving (Exporting) or Restoring (Importing) a Camera Configuration

SYSTEM PAGE, FIRMWARE TAB

You can import a configuration to several cameras if you need to configure them the same way. Cameras must be of the same model, and must have a compatible firmware version installed. Configuration data does not include passwords or unique information such as hostname.

1. Configure the first camera.
2. Export its configuration (Export Data button). The export downloads to your computer as a .dat file. The filename is the camera's hostname.

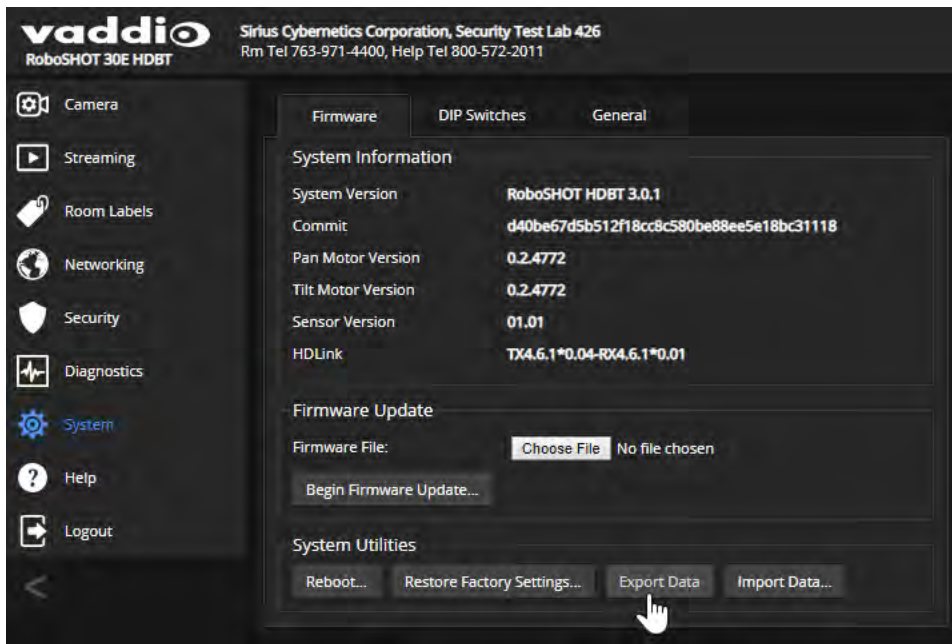

3. Import the configuration to the other cameras (Import Data button in each camera's web interface). The web interface prompts you to browse to the .dat file that will be imported.

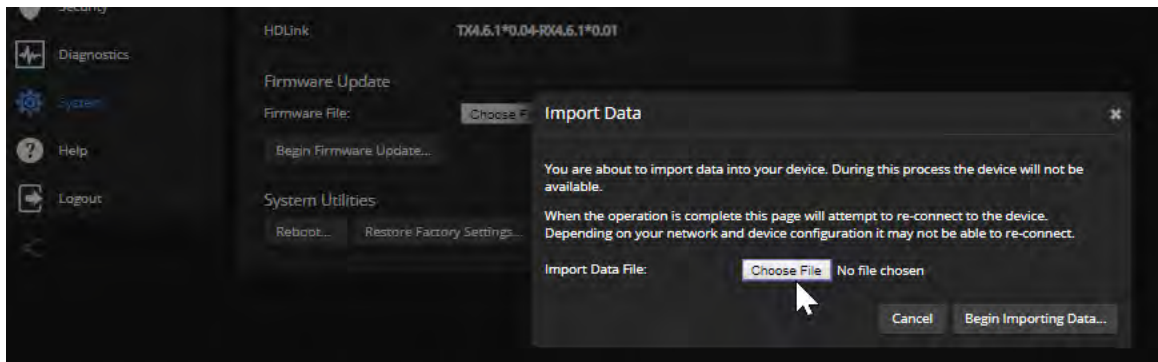

Note

If the camera is using an older firmware version, it may be unable import a configuration that was exported from a camera using a different version of firmware.

Installing a Camera Firmware Update

SYSTEM PAGE, FIRMWARE TAB

Caution

The camera must remain connected to power and to the network during the update. Interrupting the update could make the camera unusable.

1. Download the firmware and its release notes.
2. Select Choose File, then browse to the downloaded firmware and select it. The filename ends with .p7m.
3. Select Begin Firmware Update.
4. Read and understand the information in the Confirm dialog box. It's dull, but it could save you some time and aggravation.
5. Select Continue. A progress message box opens and the indicator light on the front of the camera turns yellow. If the update process presents warnings or error messages, read them carefully.

The camera reboots when the update is complete.

The screenshot displays the Vaddio web interface for a RoboSHOT 30 HDBT camera. The top header includes the Vaddio logo and contact information for Sirius Cybernetics Corporation. A left-hand navigation menu lists various system functions. The main content area is divided into two tabs: 'Firmware' (selected) and 'DIP Switches'. Under the 'Firmware' tab, there is a 'System Information' section listing various hardware and software versions. Below this is the 'Firmware Update' section, which includes a 'Firmware File' field with a 'Choose File' button and a filename 'RoboShotHD...-3.0.1.p7m'. A 'Begin Firmware Update...' button is highlighted with a mouse cursor. At the bottom, a 'System Utilities' section contains buttons for 'Reboot...', 'Restore Factory Settings...', 'Export Data', and 'Import Data...'.

vaddio Sirius Cybernetics Corporation, Training Room 404
RoboSHOT 30 HDBT Rm Tel 763-971-4400, Help Tel 800-572-2011

Camera Streaming Room Labels Networking Security Diagnostics System Help Logout

Firmware Firmware Update

System Information

System Version	RoboSHOT HDBT 1.3.0
Commit	1a7dd8836885267d73dd9197e2b47418aea4b3fc
Pan Motor Version	0.2.4772
Tilt Motor Version	0.2.4772
Sensor Version	07.00
HDLINK	TX4.6.1*0.04-RX4.6.1*0.01
PSoC Version	1.2

Firmware File: Choose File RoboShotHD...-3.0.1.p7m

Begin Firmware Update...

System Utilities

Reboot... Restore Factory Settings... Export Data Import Data...

Rebooting the Camera

SYSTEM PAGE, FIRMWARE TAB

This can help if the camera stops responding as you expect.

In the System Utilities section, select Reboot.



Contacting Vaddio Technical Support

HELP PAGE

If you can't resolve an issue using your troubleshooting skills (or the [Troubleshooting](#) table in this manual), we are here to help.

You'll find information for contacting Vaddio Technical Support on the Help page. The model identifier and the link for support information vary depending on the camera model.

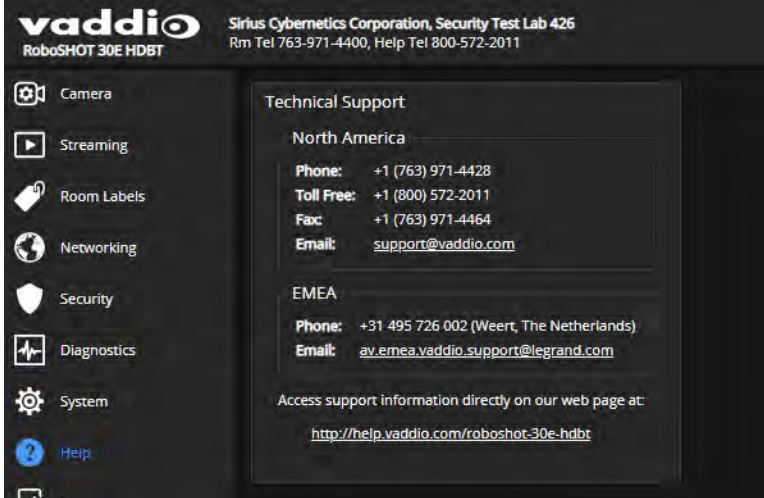

Accessing the Diagnostic Logs

DIAGNOSTICS PAGE

When you contact Vaddio technical support, your support representative may ask you to download and email the log file available from the Diagnostics page.

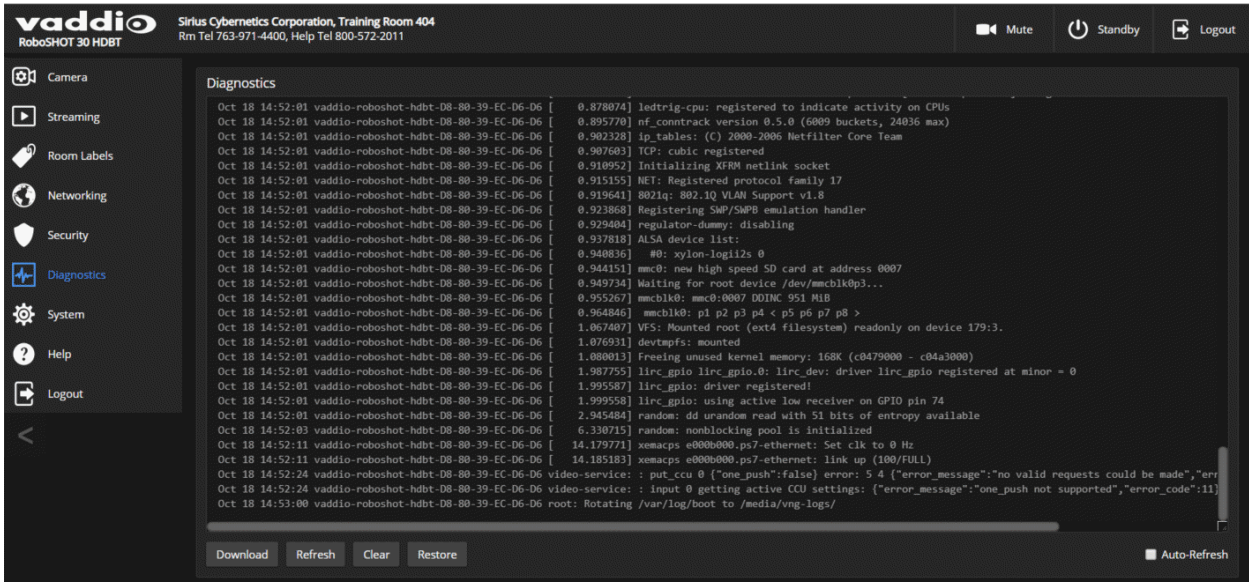

Configuring Camera Behavior

This chapter covers managing the camera as a part of the room's AV environment.

Camera configuration tasks are available on these pages:

- Camera – Color and lighting adjustments, presets (including custom Home), and real-time camera control
- Streaming – Resolution, quality, bandwidth, and more
- System (DIP Switches tab) – Camera identification (Camera 1, 2, or 3 on the remote), status light behavior, codec control mode, and more

Note

Vaddio's RoboSHOT series cameras all have very similar web interfaces. Some of the screen shots in this manual may be from other models in the RoboSHOT series.

Setting the Custom Home Position and Other Preset Shots

CAMERA PAGE

The camera's default home position is 0° pan and 0° tilt; you can set a different home position.

You can also define other presets, for shots that you will want to use repeatedly.

Note

Storing a preset overwrites any information that was previously associated with that preset. The Store Preset dialog does not show which presets have already been defined. Vaddio recommends renaming presets when you store them.

To store a preset or custom home position:

1. Set up the shot.
2. Select Store to open the Store Preset dialog.
3. Select the preset to define.
4. Select Store with Current Color Settings to save the current CCU settings along with the camera position.
5. Select Save with Tri-Sync to allow the pan, tilt, and zoom motors to move simultaneously from other presets to this position.
6. Store the preset.

Note

Tri-Synchronous Motion works best for on-air shots requiring significant movement. It is not useful when moving the camera less than 10° or when the camera is not on the air.

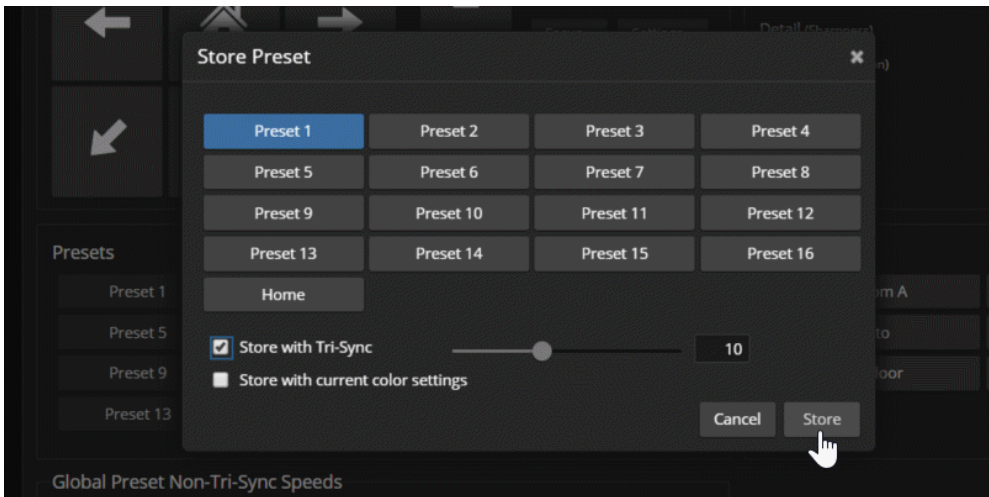

Renaming Presets and Custom CCU Scenes

You can rename presets and custom scenes. The process is the same for both. Right-click the button for the custom scene or preset, and edit the label.

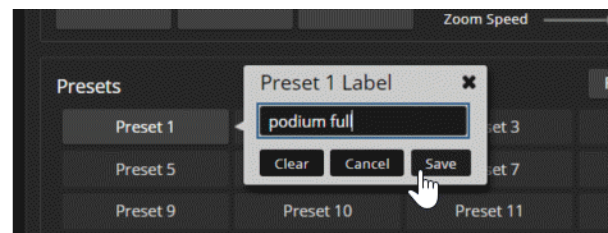

Initial Lighting and Color Settings

CAMERA PAGE

No two rooms are exactly alike – but a lot of rooms are a lot alike. The technical folks at Vaddio (Scott, to be specific) have already set up presets for common lighting scenarios (CCU scenes) – Incandescent Hi, Incandescent Lo, Fluorescent Hi, Fluorescent Lo, and Outdoor. The Auto setting allows the camera to determine the appropriate adjustments.

Adjust the camera for the lighting in use by selecting the CCU scene that best fits your environment.

Some adjustments to lighting and color may be necessary.

Note

Color adjustments are not available when the Auto CCU scene is selected.

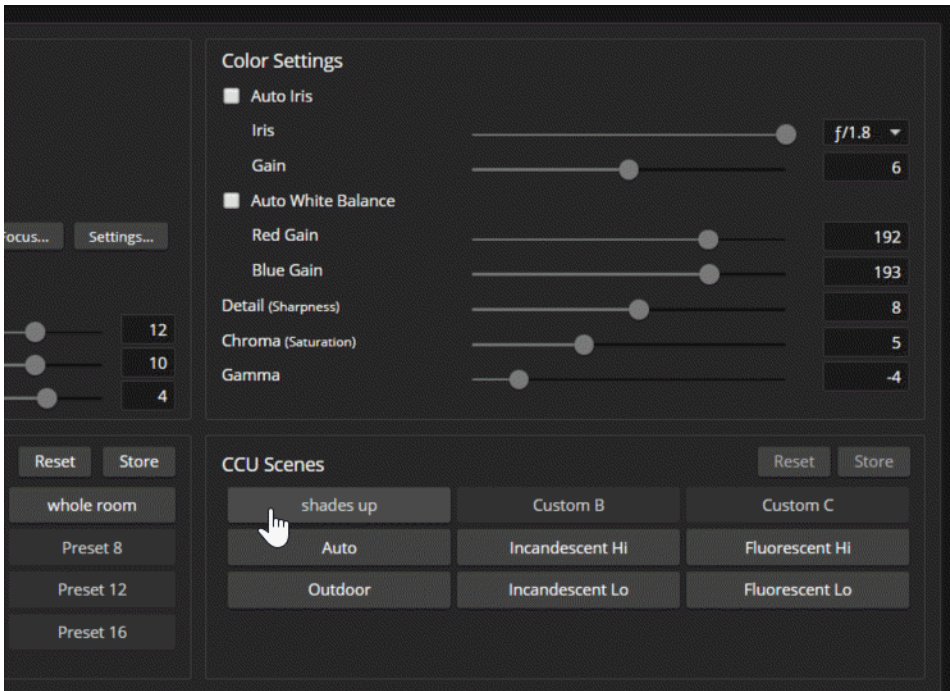

Lighting Adjustments

CAMERA PAGE AND SYSTEM PAGE (GENERAL TAB)

The camera provides settings to compensate for common lighting problems.

- **Auto Iris** allows the camera to compensate automatically for the light level.
- **Backlight Compensation** reduces contrast to adjust for bright light behind the main subject of the shot. Use this if the subject is in front of a window, projector screen, or other bright area and appears as a silhouette. This setting can't be used with Wide Dynamic Range.
- **Wide Dynamic Range** automatically darkens bright areas and brightens dark areas to provide a more properly exposed image in challenging lighting conditions. This setting can't be used with Backlight Compensation.
- **Point Light Compensation** reduces the intensity of small, extremely bright areas (point light sources) that would otherwise swamp the camera with light and make it difficult to see details in areas with less intense lighting. *Point Light Compensation is only available on the RoboSHOT 12E HDBT and RoboSHOT 30E HDBT cameras. It is on the General tab of the System page.*

Note

Wide Dynamic Range is not available on RoboSHOT 30 HDBT cameras, but it is available on the other RoboSHOT HDBT cameras.

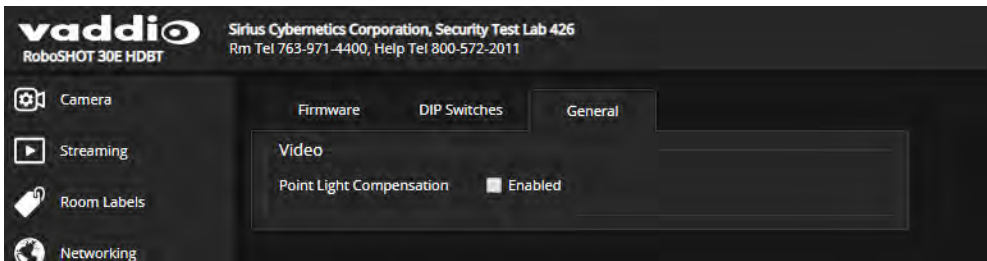

Depending on the camera's firmware version, additional settings may also be available on this tab.

The [Lighting and Image Quality Cheat Sheet](#) may be helpful.

Fine-Tuning Image Quality and Color

CAMERA PAGE

Fine-tune the color and lighting as needed using the Color Settings controls.

- **Auto White Balance** adjusts color automatically. Red gain and blue gain controls are not available when Auto White Balance is selected.
- **Red Gain** and **Blue Gain** provide manual color adjustment.
- **Detail** adjusts the image sharpness. If the video looks grainy or “noisy,” try a lower Detail setting. (As in conversation, too much detail is bad.)
- **Chroma** adjusts the color intensity.
- **Gamma** adjusts the range (grey density) between bright areas and shadows.

If you change Red Gain or Blue Gain and you don't like the results, start over by selecting and then deselecting Auto White Balance.

The [Color Adjustment Cheat Sheet](#) may be helpful.



Lighting and Image Quality Cheat Sheet

Here are some tips for using the CCU settings for lighting and image quality. For more detailed information on each setting, see [Lighting Adjustments](#) and [Fine-Tuning Image Quality and Color](#).

What do you need to correct?	Make this adjustment:
The image is too dark	Increase Iris (lower F-stop value)
	Increase Iris Gain
The image looks washed out or faded	Decrease Iris (higher F-stop value)
	Decrease Iris Gain
	Increase Chroma
	Decrease Gamma
The subject is silhouetted against a bright background	Enable Backlight Compensation
Small sources of bright light (point sources) make it hard to see details in areas with less intense lighting.	Enable Point Light Compensation (RoboSHOT 12E and 30E HDBT only)
Highlights and shadows look right, but mid-tones are too dark.	Increase Gamma
Shadows are too dark	Enable Wide Dynamic Range (WDR)
	Decrease Gamma
The image looks grainy	Decrease Detail
	Decrease Iris Gain
"Soft focus" effect; the image looks unrealistically smooth	Increase Detail

Color Adjustment Cheat Sheet

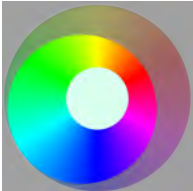
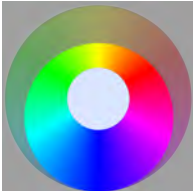
Here are some tips for using the color-related CCU settings. For more detailed information on each setting, see [Fine-Tuning Image Quality and Color](#).

What do you need to correct?	Make this adjustment:
Colors look less vivid than they should	Increase Chroma
Colors look too vivid	Decrease Chroma
Colors look wrong; white objects do not appear white	Enable Auto White Balance
	One Push White Balance
	Disable Auto White Balance and <ul style="list-style-type: none"> ■ adjust Red Gain (decrease for less red, increase for less green) ■ adjust Blue Gain (decrease for less blue, increase for less yellow)
<div style="display: flex; justify-content: space-around; text-align: center;"> <div> <p>Too much red</p>  </div> <div> <p>Not enough red</p>  </div> <div> <p>Too much blue</p>  </div> <div> <p>Not enough blue</p>  </div> <div> <p>Balanced</p>  </div> </div>	

Saving Color and Lighting Settings

CAMERA PAGE

If you are adjusting for lighting conditions that are likely to recur, you can save your adjustments as a custom scene.

1. Adjust lighting, image quality, and color.
2. When the scene looks the way you want it to, click Store CCU Scene.
3. In the Store CCU Scene dialog box, select which custom scene to store (Custom A, B, or C) and select Save.

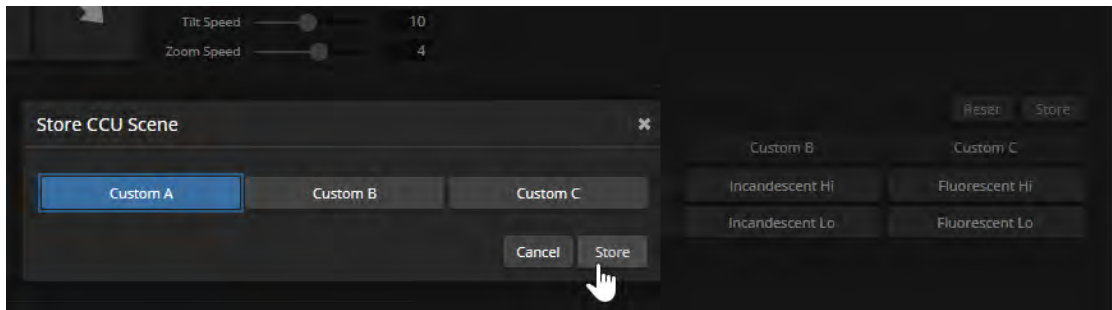

4. Optional: Name the new scene by right-clicking its button. A dialog box opens. Enter the name and save it.

Adjusting the Focus

CAMERA PAGE

Open the Focus control to select Auto-focus, or set manual focus with the + (near) and – (far) buttons. I know you already understand this, but I'm going to say it anyway: The + and – buttons don't work when Auto Focus is selected.



For users who are not logged in as admin, focus control is available via the IR Remote Commander.

Configuring IP Streaming

STREAMING PAGE

IP streaming is enabled by default. *Just as your camera outputs video unless you mute it, the camera also streams except when you disable the stream.*

About IP Streaming

Two IP streaming protocols are available: RTSP and RTMP.

- *RTSP streaming* delivers an IP stream that people can access from your network using a media player. This is the camera's default protocol for IP streaming.
- *RTMP streaming* sends a stream to a content service provider such as YouTube. No local preview is available. To use RTMP streaming, you must have an account with a streaming service.

To view the RTSP stream:

1. Open a stream viewer such as VLC Media Player.
2. Select "Network stream" or your viewer's equivalent option.
3. Copy the streaming URL from the camera's Streaming page and paste it into the viewer as the URL for the network stream.

vaddio Sirius Cybernetics Corporation, Training Room 404
RoboSHOT 30 HDBT Rm Tel 763-971-4400, Help Tel 800-572-2011

Camera
Streaming
Room Labels
Networking
Security
Diagnostics
System
Help
Logout

IP Streaming

General

Enable IP Streaming Enabled

Video Settings

Quality Mode Easy Custom

Resolution

Video Quality

Protocol

RTSP Port

RTMP

Streaming URL

Path

URL

[Show Advanced Settings...](#)

Cancel Save

Stopping the IP Stream

STREAMING PAGE

Just as the camera outputs video unless you mute it or put it in standby, the camera also streams except when you disable the stream.

Options:

- **To stop IP streaming entirely:** Clear the Enable IP Streaming check box.
- **To stop the video portion of the stream, but leave the stream running:** Mute the video. This also stops the video locally, so the connected display is blank.
- **To stop sending the stream to a content service provider but make it available as a network stream:** Change from RTMP to RTSP streaming.

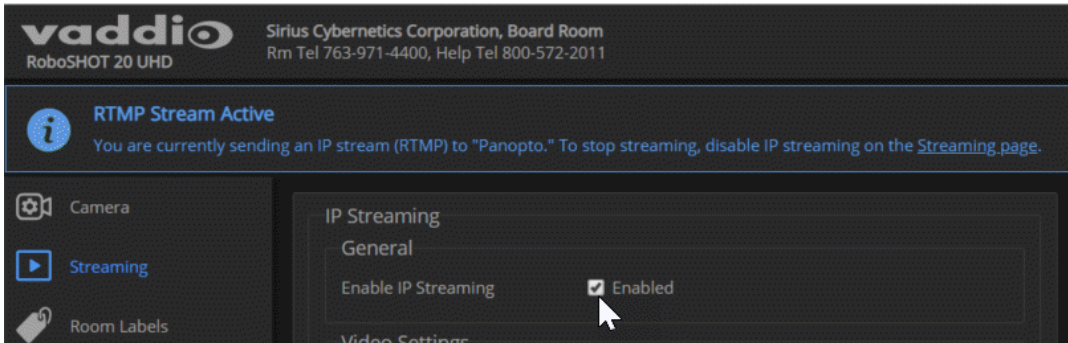

Setting up Streaming in Easy Mode

STREAMING PAGE

If you are not sure how to configure streaming settings, start with the Easy mode defaults. This configures most settings automatically.

1. Select Easy quality mode.
2. Select the desired IP streaming resolution. This determines the size of the window in which the stream is displayed.

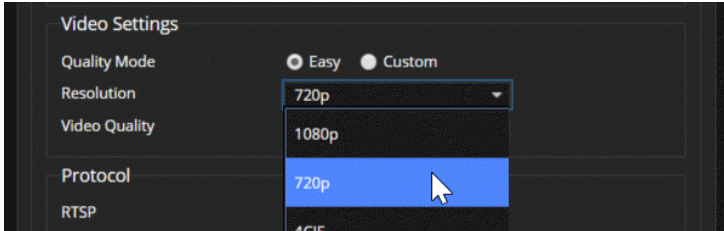

3. Select Video Quality.

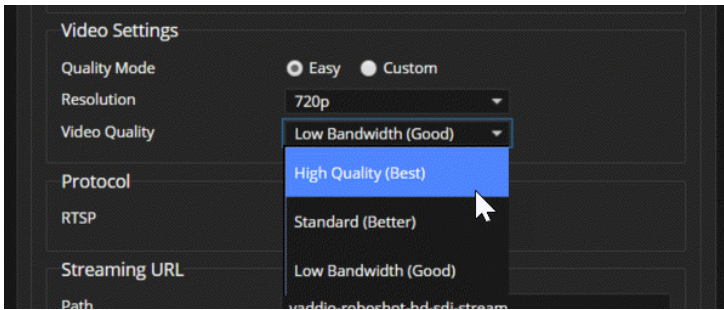

4. Save your changes.

Pro Tip

If streaming video quality is poor, try a lower resolution or bandwidth.

Setting up Streaming in Custom Mode

STREAMING PAGE

1. Select Custom quality mode.
2. Select the desired resolution.
3. Select the desired frame rate.

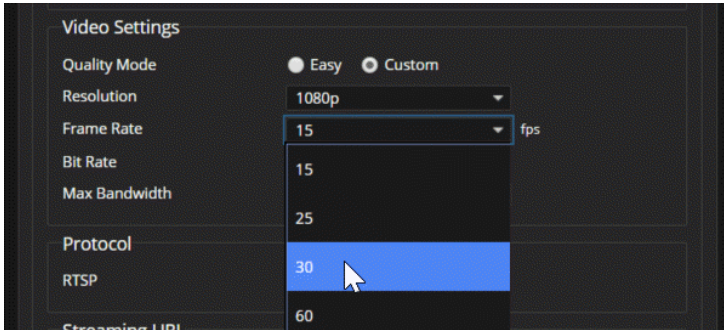

4. Select Constant or Variable bit rate.
5. Constant bit rate only: Set Max Bandwidth.

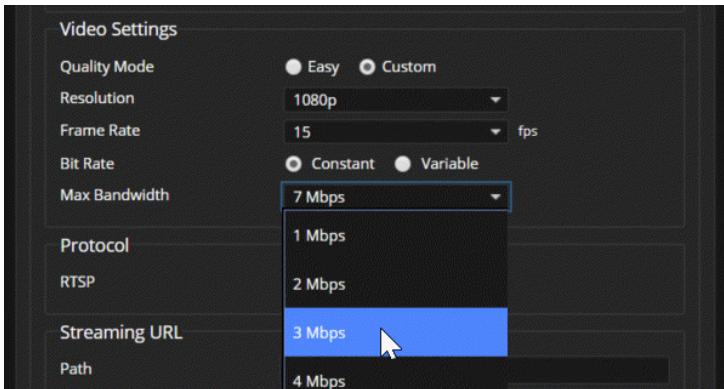

6. Variable bit rate only: Set the Quality (Quantization) slider.

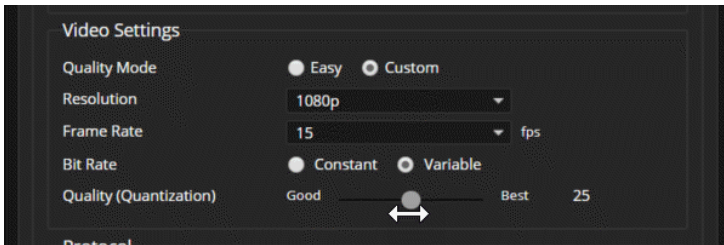

7. Save your changes.

RTSP Streaming Protocol and URL

STREAMING PAGE

RTSP is the default streaming protocol. When IP streaming is enabled, the RTSP stream is automatically available at the streaming URL shown.

RTSP port: Vaddio strongly recommends using the default RTSP port number.

Path: The portion of the streaming URL that appears after the IP address. You may wish to change this to help identify the stream source – for example, `demo-studio-3`.

URL: The location where the stream can be viewed. This will change if you edit the path.

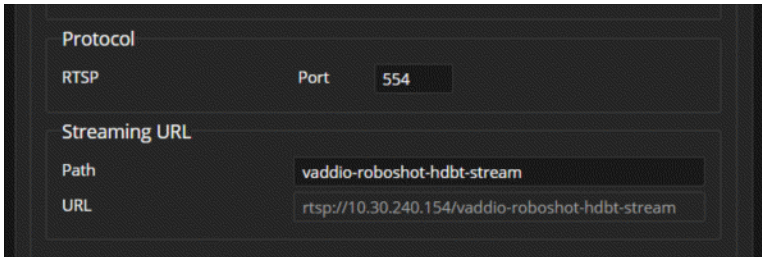

Your camera will present somewhat different information from this image, as the streaming URL incorporates the camera's model and IP address.

Configuring RTMP Streaming

STREAMING PAGE

To use RTMP streaming, you must have an account with a streaming service.

To configure an RTMP streaming service:

1. Select RTMP streaming, and select Settings.

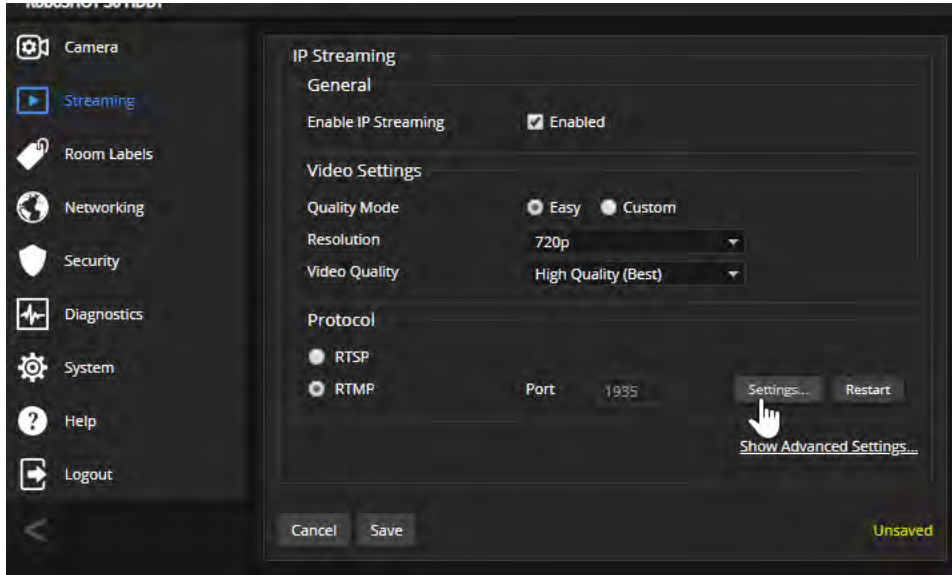

2. Expand the information box for the service.

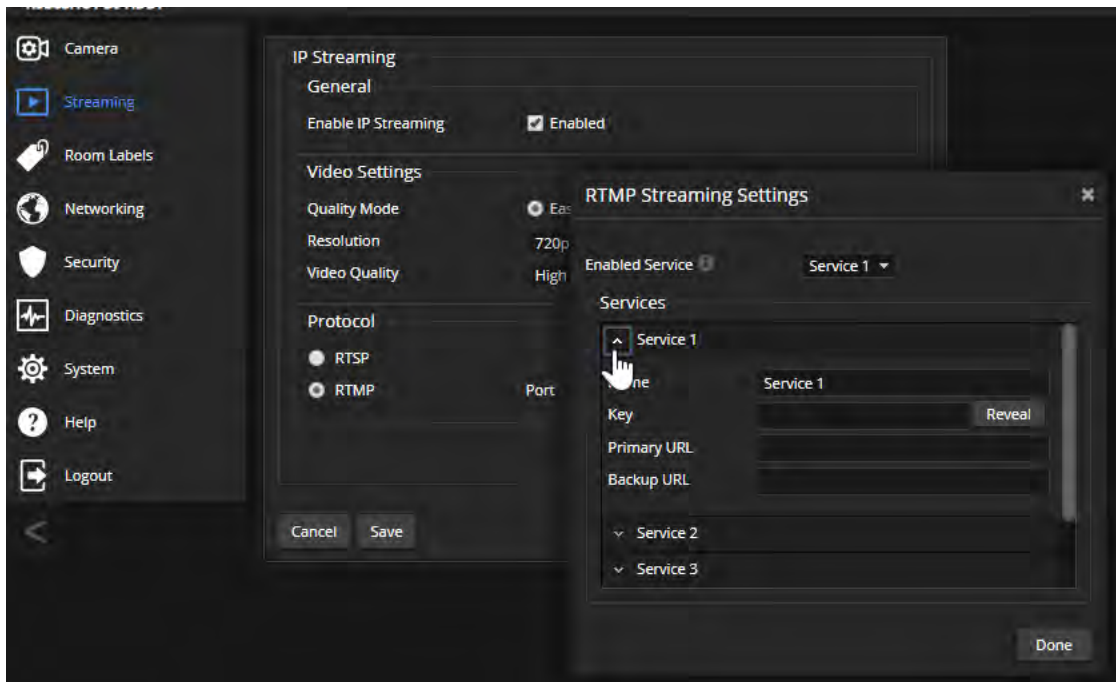

3. Enter the name of the service.
4. Paste in the key and URL(s) provided by the service.

To select the enabled RTMP streaming service:

Expand the list of available streaming services, and select the one to use.

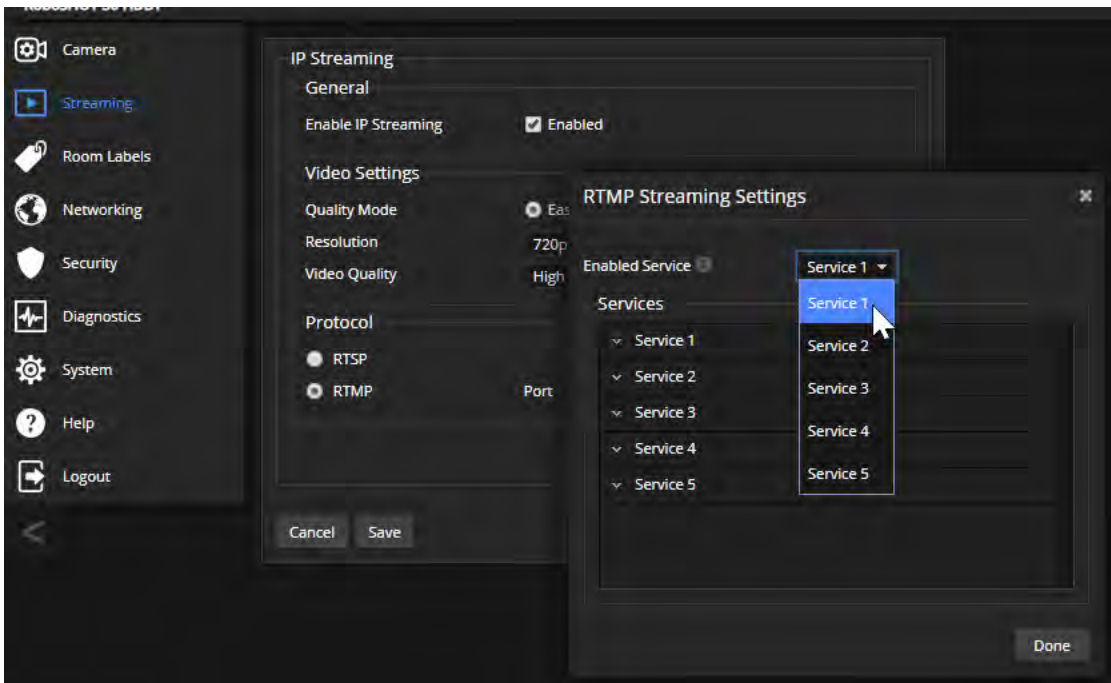

Note

When RTMP streaming is selected and a service is configured, the camera streams to that service until you stop the stream.

Advanced: Changing MTU

STREAMING PAGE

The default packet size for streaming is 1400. Do not change this except in consultation with your network administrator.

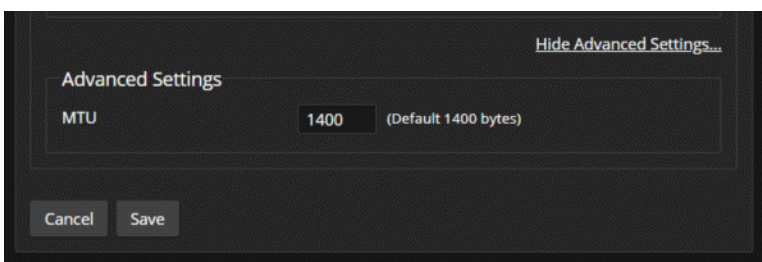
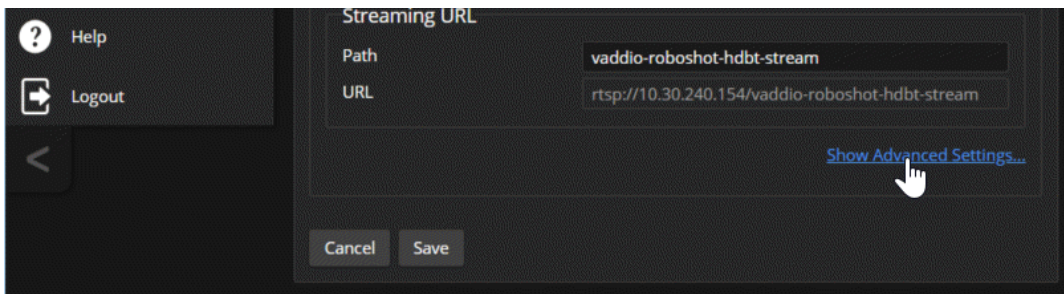

Speed Adjustments

CAMERA PAGE

The following speed adjustments are available:

- Manual pan, tilt, and zoom speeds – Used when you control camera movements with the IR Remote Commander or the arrow buttons in the web interface
- Global Preset Non-Tri-Sync Speeds – Separate pan, tilt, and zoom speeds used for movements between presets that do not use Tri-Synchronous Motion.
- Tri-Synchronous Motion speed – Only available when storing a preset with the Store with Tri-Sync option selected.

About Tri-Synchronous Motion

The Tri-Synchronous Motion algorithm calculates the pan, tilt and zoom speeds needed for the camera to move to a preset position, so that all three movements begin together and arrive at the same time. It ensures smooth on-air movements when making large changes in position, particularly when the zoom also changes. Tri-Synchronous Motion is only available as an option for moving to specific preset position.

Tri-Synchronous Motion is not helpful in movements of less than 10°, and is typically used only for on-air operation.

Setting the Speed for Manual Movements

CAMERA PAGE

The Pan Speed, Tilt Speed, and Zoom Speed sliders control how fast the camera moves in response to the direction and zoom controls on the IR remote and in the web interface.

To set speeds for movements using the arrow buttons:

Use the speed sliders to adjust the speed of movements that you control with the buttons for pan, tilt, and zoom. For tight shots, slower is usually better.

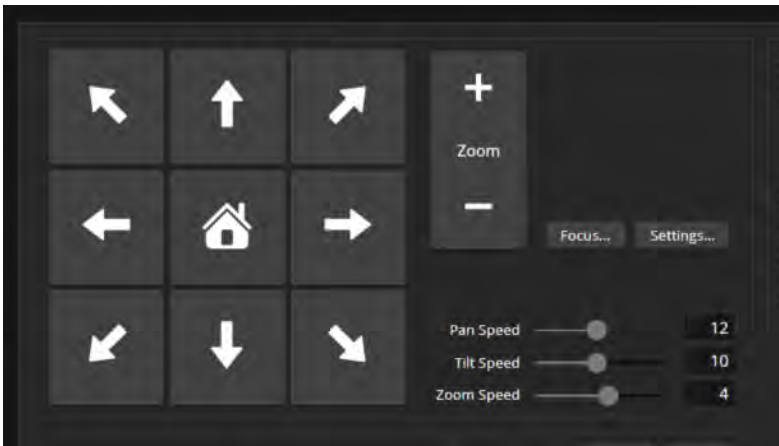

Setting the Speed of Movements to Presets

CAMERA PAGE

To set speeds for movements to presets:

1. Store presets at several points in the room, at different zoom levels, saving them without selecting the Tri-Sync option.
2. Move among the presets using the preset buttons.
3. Use the Global Preset Non-Tri-Sync Speed sliders to adjust as needed.

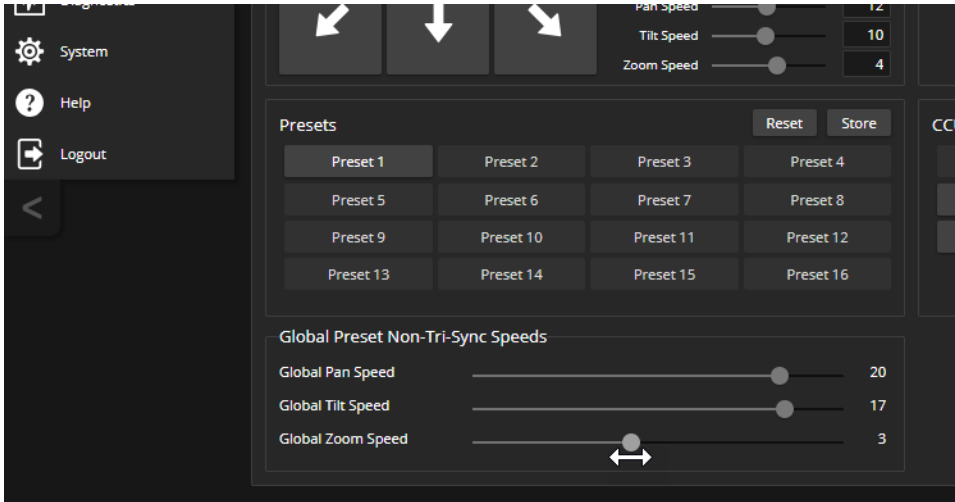

Adjusting Tri-Synchronous Motion Speed

CAMERA PAGE

The Tri-Synchronous Motion algorithm calculates the pan, tilt and zoom speeds needed for the camera to move from one preset to the next so that all three movements begin together and arrive at the same time.

You may need to experiment to find the best Tri-Sync speed setting. Here is a simple method:

1. Store a preset, checking Save with Tri-Sync and setting the speed slider about a third of the way along the scale.
2. Move the camera to a different pan, tilt, and zoom position, and save this position as another preset. Again, check Save with Tri-Sync; but set the speed slider to about the halfway point.
3. Move the camera from one preset to the other to evaluate which movement is closer to the speed you want. Use the Tri-Sync speed associated with that preset, or adjust it as needed.
4. Store all the presets you will need.
5. Switch among the presets to determine whether any of them should use different Tri-Sync speeds.
6. Adjust the speeds as needed.

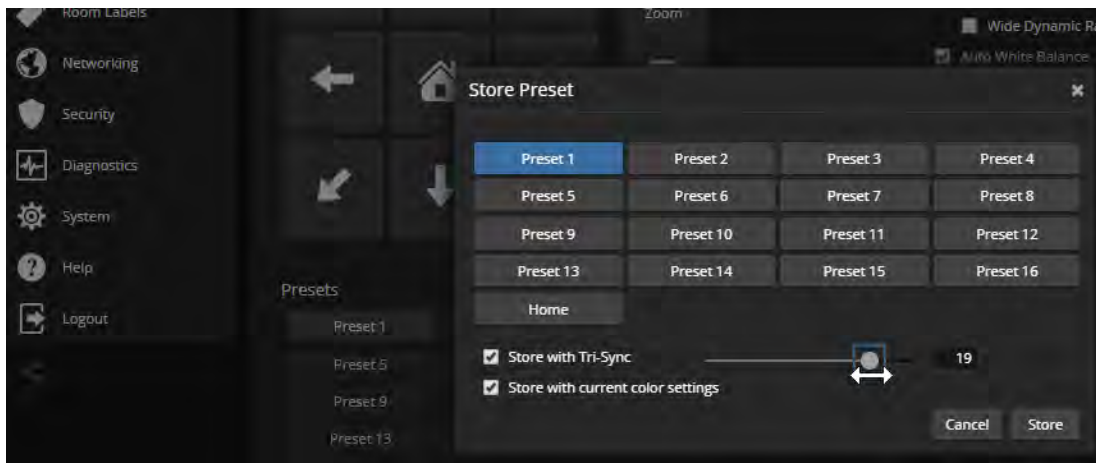

Setting the Direction for Camera Movements

CAMERA PAGE

By default, the arrow buttons on the remote and in the web interface show the direction you would see the camera move if you were looking the same direction as the camera. If a person facing the camera is controlling it with the remote, using the right arrow pans the camera to the person's left.

To make the arrow buttons indicate camera movement from the perspective of a person facing the camera, open the Settings control and invert the pan direction.

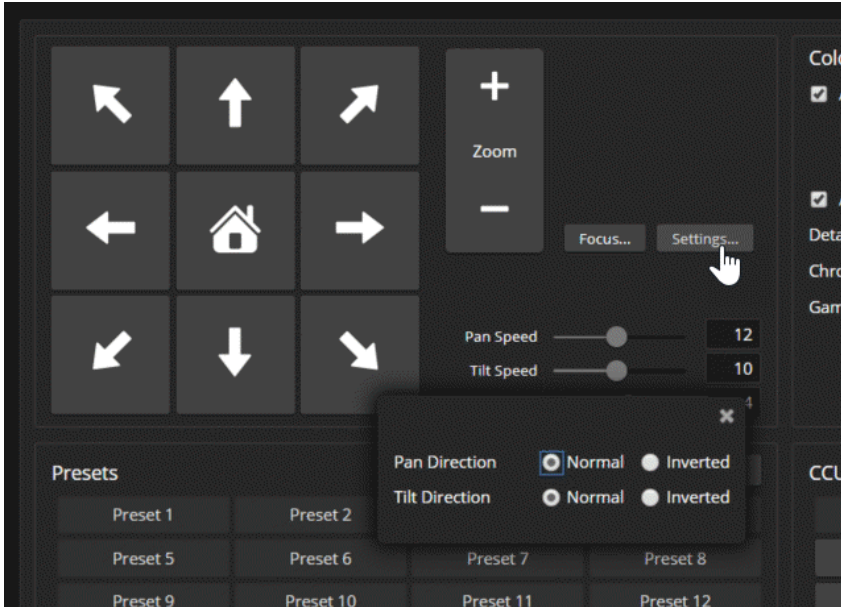

Reading the Camera's Switches

SYSTEM PAGE, DIP SWITCHES TAB

Open the DIP Switches tab to see the camera's current switch settings and configure certain camera behaviors.

Note

Sorry, this tab only controls the soft DIP switches. If your camera has physical switches, you have to physically move them to change the settings.

This screen shot shows the DIP Switches tab for the RoboSHOT 30E HDBT camera. On the older RoboSHOT 12 HDBT and RoboSHOT 30 HDBT cameras, the lower array of DIP switches is a read-out of the physical DIP switches on the back of the camera.

Note

If your camera has been updated to firmware version 3.1.0 or later, most of the soft DIP switch settings are now on the General tab.

vaddio Sirius Cybernetics Corporation, Security Test Lab 426
RoboSHOT 30E HDBT Rm Tel 763-971-4400, Help Tel 800-572-2011

Camera | Streaming | Room Labels | Networking | Security | Diagnostics | System | Help | Logout

Firmware | **DIP Switches** | General

Soft DIP Switches

Pro AV LED Color Scheme	HDMI Audio Enabled	LED On	Standard Control Mode	Enable LED in Standby
UC LED Color Scheme	HDMI Audio Disabled	LED Off	Codec Control Mode	Disable LED in Standby

Soft DIP Switches

	SOFT-SW1	SOFT-SW2	IR 1	IR On	Image Flip Off	BAUD 9600 bps	HDMI Color YCbCr
IR 1	UP	UP					
IR 2	DOWN	UP					
IR 3	UP	DOWN	IR 2	IR 3	IR Off	Image Flip On	BAUD 38400 bps HDMI Color sRGB

Rear Rotary Switch

	0	8	1080p/29.97
	1	9	1080p/25
	2	A	720p/60
	3	B	720p/59.94
	4	C	720p/50
	5	D	
	6	E	Factory Reset
	7	F	

Basic Camera Settings for RoboSHOT 12E HDBT and RoboSHOT 30E HDBT

SYSTEM PAGE, DIP SWITCHES TAB

Basic settings for the RoboSHOT E-series cameras are on the lower row of soft DIP switches. These correspond to the physical switches on the older RoboSHOT cameras.

IR1, IR2, IR3 (Frequency Selection): If there are multiple cameras in the room, use these two switches to configure each camera with a different IR frequency. Then use the Camera Select buttons at the top of the remote to select the camera you want to control. This allows the IR Remote Commander to control them independently.

- Left and right IR switches up: IR frequency 1
- Left IR switch down, right IR switch up: IR frequency 2
- Left IR switch up, right IR switch down: IR frequency 3

IR On/Off: Leave this switch UP if the IR remote will be used.

Image Flip: If mounting the camera upside-down, set the Image Flip switch ON. This orients the video image correctly and sets the tilt motors to respond appropriately to tilt up and down commands from the remote, web interface, and connected control devices.

Baud Rate: Set this switch to match the baud rate of the device connected to the RS-232 port.

HDMI color: YCbCr (default) or sRGB.

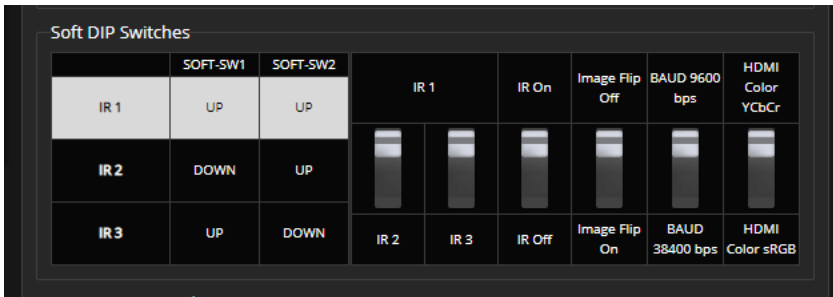

Software-Controlled Video Output Resolution Setting

RoboSHOT 12E HDBT and RoboSHOT 30E HDBT only: If the camera has been updated to version 3.1.0 firmware or later, Position 0 selects software control. The default resolution is 1080p/59.94. This capability is not available in earlier firmware versions or on the older RoboSHOT 12 HDBT and RoboSHOT 30 HDBT cameras.

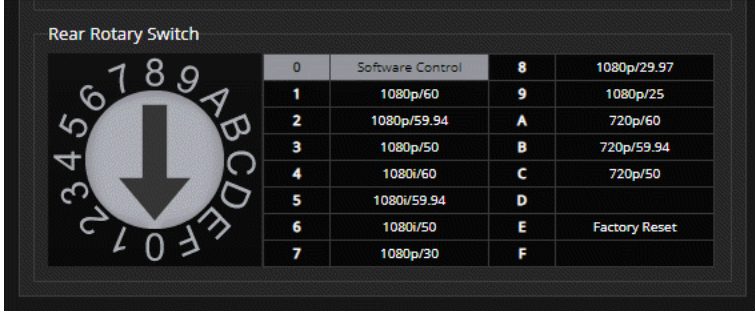

Set the video output resolution on the System page, General tab.

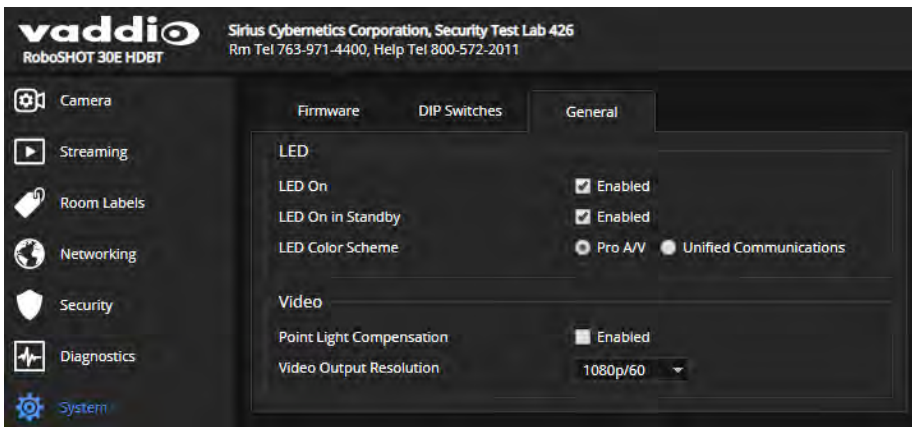

Additional Camera Behavior Settings

SYSTEM PAGE, DIP SWITCHES TAB AND GENERAL TAB

If your camera has not been updated to version 3.1.x, additional features are available on the upper row of soft DIP switches. In firmware version 3.1.0 and later, most of these settings are on the General tab.

These settings are the same for all cameras in the RoboSHOT HDBT family.

- **LED color scheme** – Status light color codes for Pro AV (broadcast, the default setting) or UC (unified conferencing).
- **HDMI Audio Enabled/Disabled** – When HDMI Audio is enabled, the camera's IP stream may include audio with the video.
- **LED on/off** – When the LED is set to OFF, it remains off even when the camera is sending video.
- **Standard Control Mode/Codec Control Mode** – Select Codec Control Mode if using the camera with a third-party codec.
- **Enable LED in Standby** – When the LED is enabled in standby mode, it illuminates purple to show that the camera is in standby but connected to power. When the LED is disabled in standby mode, it is only on when the camera is active (sending video or updating firmware).

Pre-3.1.0 firmware:

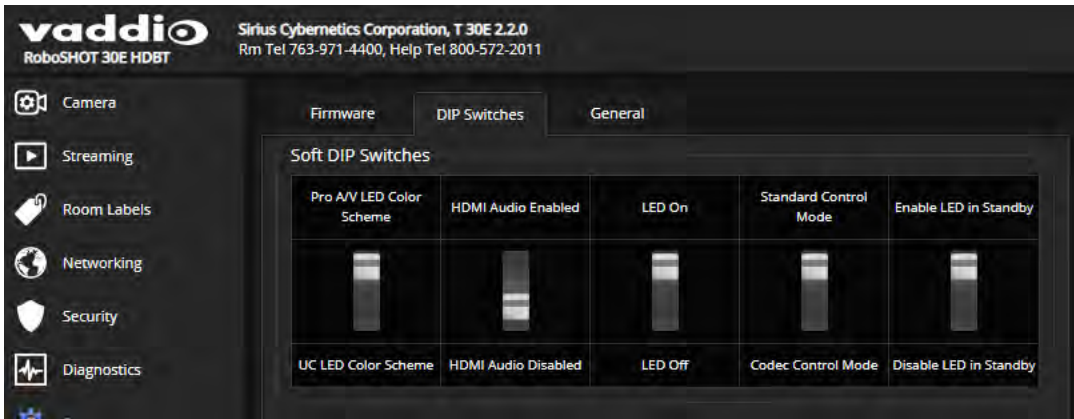

Version 3.1.0 and later firmware:

Note

When the camera's rotary switch is at position 0, you can set video output resolution from this page. This capability is not available when the switch is in any other position.

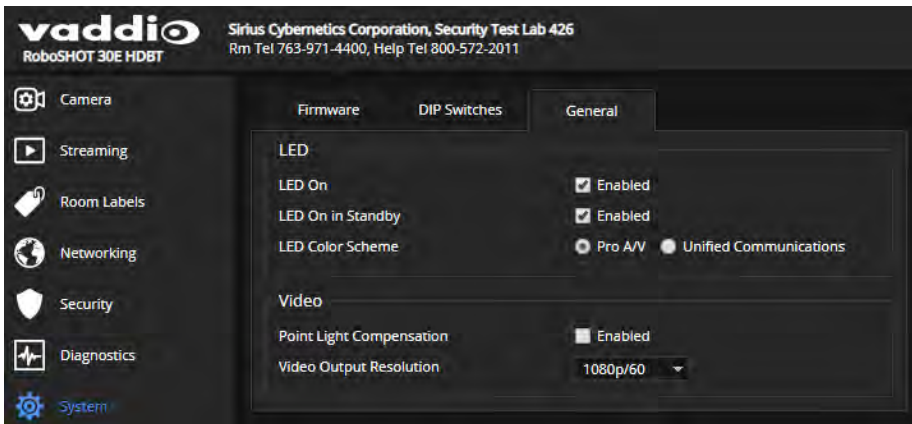

Operating the Camera from the Web Interface

CONTROLS PAGE

The Controls page does not require administrative access. If guest access is enabled, you do not need to log in to access this page. If guest access is disabled, you will need to log in as `user`.

The Controls page provides most of the same controls as the IR Remote Commander. See [Using the IR Remote](#).

- Move to camera presets, if any have been stored
- Pan, tilt, zoom, or return it to its home position
- Put the camera in standby or bring it back to the ready state
- Select a custom lighting adjustment, if any have been stored

Since the web interface is specific to the camera you are working with, it does not offer camera selection.

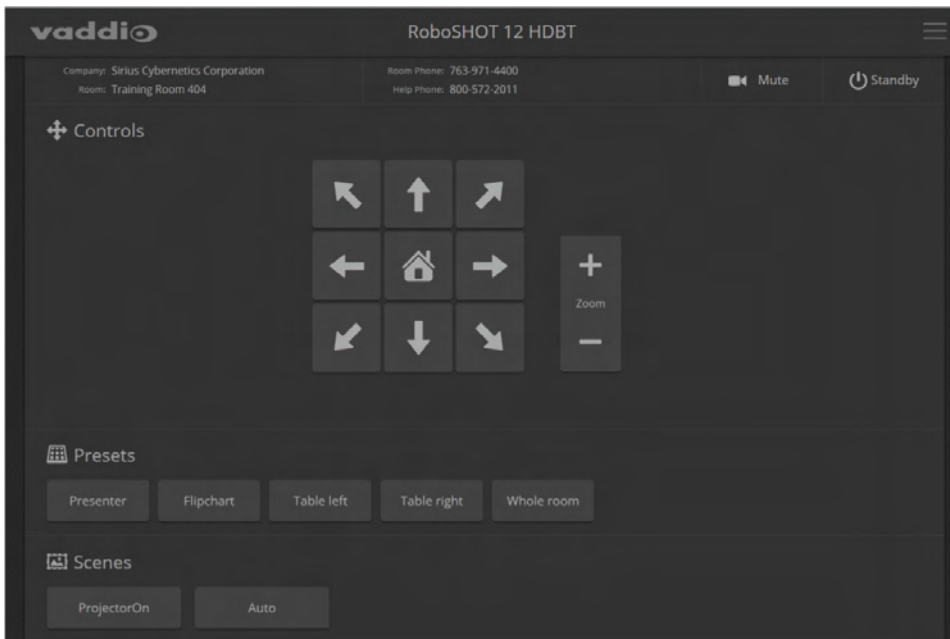

Switching the Camera Off or On (Standby)

Use the Standby button to switch between low-power (standby) and ready states. On entering standby mode, the camera moves to its standby position and stops sending video.

Stop or Resume Sending Video (Mute)

Use the Mute button to stop sending live video without putting the camera in standby mode. When the video is muted, the camera sends a blue or black screen. If the camera is part of a conferencing system, this does not mute the audio.

Moving the Camera

Use the arrow buttons for camera pan and tilt. The center button moves the camera to the home position.

Zooming In or Out

Use the Zoom + button to zoom in and the Zoom - button to zoom out.



Moving the Camera to a Preset Position

Presets are camera shots that have been stored. They include pan, tilt, and zoom information, and may include color and speed information as well. If no presets are defined, the Controls page does not present the Presets section.

Use the Preset buttons to move the camera to any of its preset positions.

Adjusting the Color and Lighting

If any color and lighting adjustments (CCU scenes) have been saved, they are available in the Scenes area, along with the Auto setting. In most cases, the Auto setting is appropriate. This setting allows the camera to adjust to current conditions automatically.

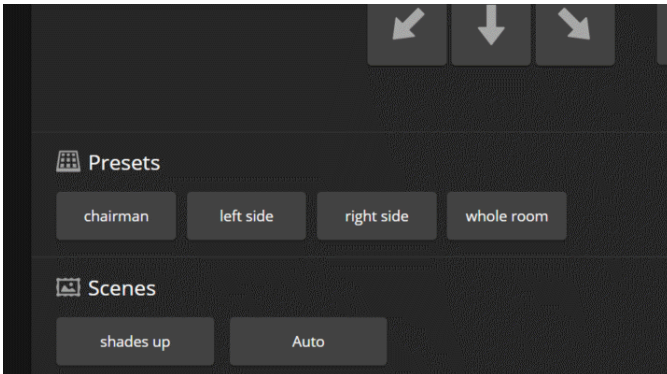

Telnet Command Reference

Vaddio's Telnet command protocol allows external devices to control the camera. Network connectivity and a Telnet client are required; Telnet port 23 is used. Telnet sessions require the administrator account login.

In addition to the camera control commands, Telnet session management commands are available – help, history, and exit.

Things to know about Telnet:

- The > character is the command prompt.
- Using a question mark as a command parameter will bring up a list of available subcommands or parameters. Example:

```
camera focus ?
camera focus
near Focus the camera near
far Focus the camera far
stop Stop the camera focus
mode Camera focus mode
```

- CTRL-5 clears the current serial buffer on the device.

Typographical conventions used in this manual:

- { **x** | **y** | **z** } – Choose x, y, or z. Example: camera led { on | off | toggle }
- <**variable**> – Substitute the desired value here. Example: camera ccu get <param>
- < **x - y** > – Valid range of values is from x through y. Example: camera ccu set detail <0 -15>
- [**parameter**] – Parameter is not required. Example: camera pan left [<speed>]

```
Telnet 192.168.1.66
BeardroomCamControl login: admin
Password:
Last login: Wed Mar 30 13:19:52 -0500 2016 on /dev/tty0
*****
Vaddio Interactive Shell
*****
WARNING: Authorized Access Only
*****

Welcome admin
> version
Serial 25120cea444ca884c4202702a214efba8e5e06c7
System Version PCC Premier 1.1.0-RC3
OK
> network settings get
Name eth0:WDM
MAC Address 60:1E:C0:8D:69:58
IP Address 192.168.1.66
Netmask 255.255.255.0
VLAN Disabled
Gateway 192.168.1.254
OK
```

camera home

Moves the camera to its home position.

Synopsis	camera home
Example	<pre>>camera home OK ></pre>

camera pan

Moves the camera horizontally.

Synopsis	camera pan { left [<speed>] right [<speed>] stop get set }	
Options	left	Moves the camera left.
	right	Moves the camera right.
	speed <1 – 24>	Optional: Specifies the pan speed as an integer (1 to 24). Default speed is 12.
	stop	Stops the camera's horizontal movement.
	get	Returns the camera's absolute pan position in degrees, as a floating point value between approximately -150.00 (left) and 150.00 (right).
	set <position>	Sets the camera's absolute pan position in degrees, as a floating point value between approximately -150.00 and 150.00. This is the minimum range. Individual cameras may have an additional degree or two of travel before they reach their physical limits. If the value is out of range, the camera returns an error message and no motion occurs.
Examples	<pre>>camera pan left OK ></pre> <p>Pans the camera left at the default speed.</p> <pre>>camera pan right 20 OK ></pre> <p>Pans the camera right using a speed of 20.</p> <pre>>camera pan stop OK ></pre> <p>Stops the camera's horizontal motion.</p>	

camera tilt

Moves the camera vertically.

Synopsis	camera tilt{ up [<speed>] down [<speed>] stop get set}	
Options	up	Moves the camera up.
	down	Moves the camera down.
	speed <1 – 20>	Optional: Specifies the tilt speed as an integer (1 to 20). Default speed is 10.
	stop	Stops the camera's vertical movement.
	get	Returns the camera's absolute tilt position in degrees, as a floating point value between approximately -30.00 (down) and 90.00 (up). Note that the range is roughly 30.00 to -90.00 if Image Flip is selected.
	set <position>	Sets the camera's absolute tilt position in degrees, as a floating point value between approximately -30.00 and 90.00 (-90 to 30 if the camera is configured for inverted operation). This is the minimum range; individual cameras may have an additional degree or two of travel before they reach their physical limits. If the value is out of range, the camera returns an error message and no motion occurs.
Examples	<pre>>camera tilt up OK > Tilts the camera up at the default speed. >camera tilt down 20 OK > Tilts the camera down using a speed of 20. >camera tilt stop OK > Stops the camera's vertical motion.</pre>	

camera zoom

Zooms the camera in toward the subject or out away from the subject.

Synopsis	camera zoom { in [<speed>] out [<speed>] stop get set}	
Options	in	Moves the camera in.
	out	Moves the camera out.
	speed [1 – 7]	Optional: Specifies the zoom speed as an integer (1 to 7). Default speed is 3.
	stop	Stops the camera's zoom movement.
	get	Returns the camera's current zoom level as a floating point value.
	set <1 – n>	Sets the zoom level as a floating point value. The value of n (maximum zoom) depends on the camera's capabilities. For example, the range is 1.00 to 12.00 for a 12x camera. If the value is out of range, the camera returns an error message and no zoom change occurs.
Examples	<pre>>camera zoom in OK > Zooms the camera in at the default speed. >camera zoom out 7 OK > Zooms the camera out using a speed of 7. >camera zoom stop OK > Stops the camera's zoom motion. >camera zoom set 14 OK > Sets the camera's zoom level to 14x. >camera zoom get 14 OK > Returns the camera's current zoom level.</pre>	

camera focus

Changes the camera focus.

Synopsis	<code>camera focus { near [<speed>] far [<speed> stop mode {get auto manual}}</code>	
Options	<code>near</code>	Brings the focus nearer to the camera. Can only be used when camera is in manual mode.
	<code>far</code>	Moves the focus farther from the camera. Can only be used when camera is in manual mode.
	<code>speed <1 – 8></code>	Optional: integer (1 to 8) specifies the focus speed.
	<code>stop</code>	Stops the camera's focus movement.
	<code>mode {get auto manual}</code>	Returns the current focus mode, or specifies automatic or manual focus.
Examples	<pre> camera focus near OK > </pre>  <p>Brings the focus near at the default speed.</p> <pre> camera focus far 7 OK > </pre> <p>Moves the focus farther from the camera at a speed of 7.</p> <pre> camera focus mode get auto_focus: on OK > </pre> <p>Returns the current focus mode.</p>	

camera preset

Moves the camera to the specified preset, or stores the current camera position and optionally CCU information, either with or without specifying that Tri-Synchronous Motion is to be used when moving to this position.

Note

This command corresponds to the CAM_Memory commands in the RS-232 command set.

Synopsis	camera preset { recall store} <1 – 16> [tri-sync <1 – 24>] [save-ccu]	
Options	recall <1 – 16>	Moves the camera to the specified preset, using Tri-Synchronous Motion if this was saved with the preset. If CCU information was saved with the preset, the camera switches to the CCU setting associated with the preset.
	store <1 – 16>	Stores the current camera position as the specified preset.
	tri-sync <1 – 24>	Optional: Specifies that the camera uses Tri-Synchronous Motion to move to this position, using the specified speed.
	save-ccu	Optional: Saves the current CCU settings as part of the preset. If not specified, the last color settings are used when recalled.
Examples	<pre>>camera preset recall 3 OK > Moves the camera to preset 3. >camera preset store 1 OK > Saves the camera's current position as preset 1. >camera preset store 4 tri-sync 15 OK > Stores the camera's current position as preset 4. The camera will use Tri-Synchronous Motion at speed 15 when it is recalled to this preset. >camera preset store 2 save-ccu OK > Stores the camera's current position as preset 2. The camera applies the current CCU settings when it is recalled to this preset.</pre>	

camera ccu get

Returns CCU (lighting and color) information.

Synopsis	<code>camera ccu get <param></code>	
Options 	<code>all</code>	Returns all current CCU settings.
	<code>auto_white_balance</code>	Returns the current state of the auto white balance setting (on or off).
	<code>red_gain</code>	Returns red gain as an integer (0 to 255).
	<code>blue_gain</code>	Returns blue gain as an integer (0 to 255).
	<code>backlight_compensation</code>	Returns the current state for backlight compensation (on or off).
	<code>auto_iris</code>	Returns the current auto-iris state (on or off).
	<code>iris</code>	Returns the iris value as an integer (0 to 11).
	<code>gain</code>	Returns gain as an integer (0 to 11).
	<code>detail</code>	Returns detail as an integer (0 to 15).
	<code>chroma</code>	Returns chroma as an integer (0 to 14).
	<code>gamma</code>	Returns gamma as an integer (-64 to 64)
	<code>wide_dynamic_range</code>	Returns the current state for Wide Dynamic Range (on or off).
Examples	<pre>>camera ccu get iris iris 6 OK ></pre> <p>Returns the current iris value.</p> <pre>>camera ccu get red_gain red_gain 201 OK ></pre> <p>Returns the current red gain value.</p> <pre>>camera ccu get all auto_iris on auto_white_balance on backlight_compensation off blue_gain 193 chroma 2 detail 8 gain 3 iris 11 red_gain 201 wide_dynamic_range off OK ></pre> <p>Returns all current CCU settings.</p>	

camera ccu set

Sets the specified CCU (lighting and color) information.

Synopsis	<code>camera ccu set <param> <value></code>	
Options 	<code>auto_white_balance {on off}</code>	Sets the current state of the auto white balance setting (on or off). Auto white balance overrides red gain and blue gain manual settings.
	<code>red_gain <0 – 255></code>	Sets the red gain value as an integer (0 to 255). Can only be used when auto white balance is off.
	<code>blue_gain <0 – 255></code>	Sets the blue gain value as an integer (0 to 255). Can only be used when auto white balance is off.
	<code>backlight_compensation {on off}</code>	Sets the current state of the backlight compensation setting (on or off). Can only be used when wide dynamic range mode is off.
	<code>iris <0 – 11></code>	Sets the iris value as an integer (0 to 11). Can only be used when auto-iris is off.
	<code>auto_iris {on off}</code>	Sets the auto-iris state (on or off). Auto-iris disables manual iris and gain when it is on.
	<code>gain <0 – 11></code>	Sets gain value as an integer (0 to 11). Can only be used when auto-iris is off.
	<code>detail <0 – 15></code>	Sets the detail value as an integer (0 to 15).
	<code>chroma <0 – 14></code>	Sets the chroma value as an integer (0 to 14).
	<code>gamma <-64 – 64></code>	Sets the gamma value as an integer (-64 to 64).
	<code>wide_dynamic_range {on off}</code>	Sets Wide Dynamic Range mode on or off. Can only be used when backlight compensation is off. This parameter is not valid for RoboSHOT 30 HDBT.
Examples	<pre>>camera ccu set auto_iris off OK > Turns off auto-iris mode, returning the camera to manual iris control. >camera ccu set red_gain 10 OK > Sets the red gain value to 10.</pre>	

camera ccu scene

Stores the current CCU scene or recalls the specified ccu scene.

Synopsis	camera ccu scene {recall {factory <1–6> custom <1–3>} store custom <1–3>}	
Options	recall factory <1–6> recall custom <1–3>	Recalls the camera to the specified scene (factory 1 to 6 or custom 1 to 3) .
	store custom <1–3>	Saves the current scene as the specified custom scene.
Examples	<pre>>camera ccu scene recall factory 2 OK > Sets the camera to use factory CCU scene 2. >camera ccu scene store custom 1 OK > Saves the current CCU scene as custom CCU scene 1.</pre>	

camera led

Set or change the behavior of the indicator light.

Synopsis	camera led { get off on }	
Options	get	Returns the indicator light's current state (on or off).
	off	Disables the indicator light.
	on	Enables the indicator light.
Examples	<pre>>camera led off OK > Disables the indicator light. You cannot tell by looking at the camera whether it is sending video. >camera led get led: on OK > Returns the current state of the indicator light.</pre>	

camera standby

Set or change camera standby status.

Synopsis	camera standby { get off on toggle }	
Options	get	Returns the camera's current standby state.
	off	Brings the camera out of standby (low power) mode.
	on	Stops video and puts the camera in standby mode.
	toggle	Changes the camera's standby state – if it was not in standby mode, it enters standby; if it was in standby mode, it "wakes up."
Examples	 <pre>>camera standby off OK ></pre> <p>Brings the camera out of standby mode.</p> <pre>>camera standby get standby: on OK ></pre> <p>Returns the current standby state.</p>	

streaming ip enable

Set or change the state of IP streaming.

Synopsis	streaming ip enable { get on off toggle }	
Parameters	get	Returns the current state of IP streaming
	on	Enables IP streaming.
	off	Disables IP streaming.
	toggle	Changes the state of IP streaming (on if it was off, or off if it was on). streaming ip enable toggle has the same effect as selecting the Enable IP Streaming checkbox in the web interface.
Example	<pre>>streaming ip enable on > OK</pre> <p>Enables IP streaming.</p> <pre>>streaming ip enable get enabled: true > OK</pre> <p>Returns the current state of IP streaming.</p>	

streaming settings get

Retrieves IP streaming settings. These are configured in the web interface.

Synopsis	streaming settings get	
Parameters	IP Custom_Frame_Rate	Frame rate (Custom mode).
	IP Custom_Resolution	Resolution (Custom mode).
	IP Enabled	True if IP streaming is enabled, False if it is not.
	IP MTU	Maximum packet size.
	IP Port	Port number used for IP streaming. Default for RTSP streaming is 554; default for RTMP streaming is 1935.
	IP Preset_Quality	Video quality (Easy mode).
	IP Preset_Resolution	Resolution (Easy mode).
	IP Protocol	IP streaming protocol in use (RTSP or RTMP).
	IP URL	URL where the RTSP stream is available.
	IP Video_Mode	Video quality mode selected (preset or custom)
Example	<pre>>streaming settings get IP Custom_Frame_Rate 30 IP Custom_Resolution 1080p IP Enabled true IP MTU 1400 IP Port 554 IP Preset_Quality Standard (Better) IP Preset_Resolution 720p IP Protocol RTSP IP URL vaddio-roboshot-hdbt-stream IP Video_Mode preset OK ></pre> <p>Returns the current streaming settings.</p>	

network settings get

Returns the current network settings for MAC address, IP address, subnet mask, and gateway.

Synopsis	network settings get	
Example	<pre>> network settings get Name eth0:WAN MAC Address 48:6F:77:64:79:21 IP Address 192.168.1.67 Netmask 255.255.255.0 VLAN Disabled Gateway 192.168.1.254 OK ></pre>	

network ping

Sends an ICMP ECHO_REQUEST to the specified IP address or hostname.

Synopsis	network ping [count <count>] [size <size>] <string>	
Options	<count>	The number of ECHO_REQUEST packets to send. Default is five packets.
	<size>	The size of each ECHO_REQUEST packet. Default is 56 bytes.
	<string>	The hostname or IP address where the ECHO_REQUEST packets will be sent.
Examples	<pre>>network ping 192.168.1.66 PING 192.168.1.66 (192.168.1.66): 56 data bytes 64 bytes from 192.168.1.66: seq=0 ttl=64 time=0.476 ms 64 bytes from 192.168.1.66: seq=1 ttl=64 time=0.416 ms 64 bytes from 192.168.1.66: seq=2 ttl=64 time=0.410 ms 64 bytes from 192.168.1.66: seq=3 ttl=64 time=0.410 ms 64 bytes from 192.168.1.66: seq=4 ttl=64 time=3.112 ms --- 192.168.1.66 ping statistics --- 5 packets transmitted, 5 packets received, 0% packet loss round-trip min/avg/max = 0.410/0.964/3.112 ms ></pre> <p>Sends five ECHO_REQUEST packets of 56 bytes each to the host at 192.168.1.66.</p>	
	<pre>>network ping count 10 size 100 192.168.1.1</pre> <p>Sends 10 ECHO_REQUEST packets of 100 bytes each to the host at 192.168.1.1. The command returns data in the same form as above.</p>	

system reboot

Reboots the system either immediately or after the specified delay. Note that a reboot is required when resetting the system to factory defaults (system factory-reset).

Synopsis	system reboot [<seconds>]	
Options	<seconds>	The number of seconds to delay the reboot.
Examples	<pre>>system reboot OK ></pre> <p>The system is going down for reboot NOW! roboshot-hdbt-48-6F-77-64-79-21</p> <p>Reboots the system immediately.</p>	
	<pre>>system reboot 30</pre> <p>Reboots the system in 30 seconds. The response is in the same form; the system message appears at the end of the delay.</p>	

system factory-reset

Gets or sets the factory reset status. When the factory reset status is on, the system resets to factory defaults on reboot.

Synopsis	system factory-reset { get on off }	
Options	get	Returns the camera's current factory reset status.
	on	Enables factory reset on reboot.
	off	Disables factory reset on reboot.
Examples	<pre>>system factory-reset get factory-reset (software): off factory-reset (hardware): off OK ></pre> <p>Returns the factory reset status.</p> <p>This evaluates the most recent <code>system factory-reset on</code> or <code>off</code> command, if one has been received, then reads the rear panel DIP switches and returns the status <code>on</code> if they are all in the down position.</p> <pre>>system factory-reset on factory-reset (software): on factory-reset (hardware): off OK ></pre> <p>Enables factory reset upon reboot.</p> <p>Note <i>This command does not initiate a factory reset. The factory reset takes place on the next reboot.</i></p>	

history

Returns the most recently issued commands from the current Telnet session. Since many of the programs read user input a line at a time, the command history is used to keep track of these lines and recall historic information.

Synopsis	history <limit>	
Options	<limit>	Integer value specifying the maximum number of commands to return.
Examples	<p>history Displays the current command buffer.</p> <p>history 5 Sets the history command buffer to remember the last 5 unique entries.</p>	
Additional information	<p>You can navigate the command history using the up and down arrow keys.</p> <p>This command supports the expansion functionality from which previous commands can be recalled from within a single session. History expansion is performed immediately after a complete line is read.</p> <p>Examples of history expansion:</p> <ul style="list-style-type: none"> * !! Substitute the last command line. * !4 Substitute the 4th command line (absolute as per 'history' command) * !-3 Substitute the command line entered 3 lines before (relative) 	



version

Returns the current firmware version.

Synopsis	version
Example	<pre>> version Commit d033ddb2378357a871011eb820706dcaa64ec0e2 HDLink TX4.6.1x0.03 Pan Motor Version 0.2.4772 Sensor Version 06.00 System Version RoboSHOT HDBT 3.0.1 Tilt Motor Version 0.2.4772 OK</pre> <p>Returns current firmware version information. Your camera may return slightly different information.</p>

help

Displays an overview of the CLI syntax.

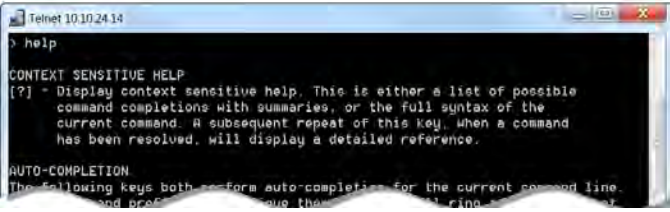
Synopsis	help
Example	<p>help</p>  <pre> > help CONTEXT SENSITIVE HELP [?] - Display context sensitive help. This is either a list of possible command completions with summaries, or the full syntax of the current command. A subsequent repeat of this key, when a command has been resolved, will display a detailed reference. AUTO-COMPLETION The following keys both perform auto-completion for the current command line. The spacebar and underscore key complete the current command line. </pre>

exit

Ends the command session and then closes the socket.

Synopsis	exit
Example	exit

RS-232 Serial Command Reference

The Vaddio RS-232 Serial Control Protocol is similar to the Sony® VISCA command set in order to be compatible with several popular control devices. Not all VISCA commands are supported, and there are Vaddio-specific commands in the following command and inquiry lists.

Although the RoboSHOT HDBT cameras do not have an RS-232 port, they can accept these commands via the HDBaseT connection when used with a OneLINK device or compatible third-party controller.

Be sure the camera is set to the same baud rate as the controller or other device originating the commands. For the older RoboSHOT HDBT cameras, see [DIP Switches: Camera Behavior Settings](#). For the newer RoboSHOT 12E HDBT and RoboSHOT 30E HDBT cameras, see [Basic Camera Settings for RoboSHOT 12E HDBT and RoboSHOT 30E HDBT](#).

Camera Movement, Zoom, and Focus Commands

Command Set	Command	Command Packet	Comments
CAM_Zoom	Stop	8x 01 04 07 00 FF	Variable speed: p = 0 (low) to 7 (high) Direct: pqrs = zoom position (0h-4000h for 12x, 0h-7AC0h for 30x)
	Tele (std)	8x 01 04 07 02 FF	
	Wide (std)	8x 01 04 07 03 FF	
	Tele (variable)	8x 01 04 07 2p FF	
	Wide (variable)	8x 01 04 07 3p FF	
	Direct	8x 01 04 47 0p 0q 0r 0s FF	
Corresponds to <code>camera zoom</code> in Telnet API			
CAM_Focus	Stop	8x 01 04 08 00 FF	Variable speed: p = 0 (low) to 7 (high) Direct and Near Limit: pqrs = focus position (1000h – F000h)
	Far (std)	8x 01 04 08 02 FF	
	Near (std)	8x 01 04 08 03 FF	
	Far (variable)	8x 01 04 08 2p FF	
	Near (variable)	8x 01 04 08 3p FF	
	Direct	8x 01 04 48 0p 0q 0r 0s FF	
	One Push Trigger	8x 01 04 18 01 FF	
	Near Limit	8x 01 04 28 0p 0q 0r 0s FF	
Corresponds to <code>camera focus</code> in Telnet API			
CAM_Focus Mode	Auto Focus	8x 01 04 38 02 FF	
	Manual Focus	8x 01 04 38 03 FF	
	Auto/Manual	8x 01 04 08 10 FF	

Command Set	Command	Command Packet	Comments
Pan-TiltDrive	Up	8x 01 06 01 vv ww 03 01 FF	vv= Pan speed (01h-18h)
	Down	8x 01 06 01 vv ww 03 02 FF	ww=Tilt speed (01h-14h)
	Left	8x 01 06 01 vv ww 01 03 FF	
	Right	8x 01 06 01 vv ww 02 03 FF	
	UpLeft	8x 01 06 01 vv ww 01 01 FF	
	UpRight	8x 01 06 01 vv ww 02 01 FF	
	DownLeft	8x 01 06 01 vv ww 01 02 FF	
	DownRight	8x 01 06 01 vv ww 02 02 FF	
	Stop	8x 01 06 01 vv ww 03 03 FF	
	Home	8x 01 06 04 FF	Returns the camera to its default position
Pan-TiltDrive	Absolute Position	8x 01 06 02 vv ww 0Y 0Y 0Y 0Y 0Z 0Z 0Z 0Z FF	0Y0Y0Y0Y = Pan position (90E2h-6BD8h) 0Z0Z0Z0Z = Tilt position (EB99h-3D59h)
Pan-Tilt-ZoomDrive	Up	8x 01 06 0A vv ww rr 03 01 03 FF	vv= Pan speed (01h-18h) ww=Tilt speed (01h-14h)
	Down	8x 01 06 0A vv ww rr 03 02 03 FF	rr=Zoom speed (00h - 07h)
	Left	8x 01 06 0A vv ww rr 01 03 03 FF	
	Right	8x 01 06 0A vv ww rr 02 03 03 FF	
	In	8x 01 06 0A vv ww rr 03 03 01 FF	
	Out	8x 01 06 0A vv ww rr 03 03 02 FF	
	Stop	8x 01 06 0A vv ww rr 03 03 03 FF	
	Home	8x 01 06 0C FF	Returns the camera to the default position and zoom
Pan-Tilt-ZoomDrive	Absolute Position	8x 01 06 0B vv ww 0Y 0Y 0Y 0Y 0Z 0Z 0Z 0Z 0R 0R 0R 0R FF	0Y0Y0Y0Y = Pan position (90E2h-6BD8h) 0Z0Z0Z0Z = Tilt position (EB99h-3D59h) 0R0R0R0R = Zoom position (0h-4000h for 12x, 0h-7AC0h for 30x)

Command Set	Command	Command Packet	Comments
CAM_Memory	Reset	8x 01 04 3F 00 0p FF	Corresponds to camera preset in Telnet API. p= preset number(0h-0Fh) qr= Speed(01h-18h)
	Set standard	8x 01 04 3F 01 0p FF	
	Set standard with 'scene'	8x 01 04 3F 21 0p FF	
	Set Tri-sync	8x 01 04 3F 11 0p 0q 0r FF	
	Set Tri-Sync with 'scene'	8x 01 04 3F 31 0p 0q 0r FF	
	Recall	8x 01 04 3F 02 0p FF	
			Corresponds to camera preset in Telnet API.
CAM_PTZ_PresetSpeed		8x 01 7e 01 0b pp qq rr FF	pp: pan speed (01h-18h) qq: tilt speed (01h-14h) rr: zoom speed (0h-07h)

Movement, Zoom, and Focus Inquiry Commands

Inquiry Command	Command	Response Packet	Comments
Pan-TiltPosInq	8x 09 06 12 FF	y0 50 0w 0w 0w 0z 0z 0z 0z FF	www= Pan position zzzz=Tilt Position
CAM_ZoomPosInq	8x 09 04 47 FF	y0 50 0p 0q 0r 0s FF	pqrs: Zoom position
CAM_FocusPosInq	8x 09 04 48 FF	y0 50 0p 0q 0r 0s FF	pqrs: Focus position
CAM_FocusModeInq	8x 09 04 38 FF	y0 50 02 FF	Auto focus
		y0 50 03 FF	Manual focus
			Corresponds to camera focus mode get in Telnet API.
CAM_MemoryInq	8x 09 04 3F FF	y0 50 pp FF	pp: Preset number recalled last (00h - 0Fh)
CAM_MemoryStatusInq	8x 09 04 3F 0p FF	y0 50 0p 0q 0r 0s FF	p: Preset number (00h - 0Fh) q: mode (00-std, 10-std /w ccu, 01-trisync, 11-trisync /w ccu) rs: speed (0x1-0x18) 1 - 24
CAM_MemSaveInq	8x 09 04 23 0X FF	y0 50 0p 0q 0r 0s FF	X: 00h to 0Fh (preset number) pqrs: 0000h to FFFFh (Data)
CAM_PTZ_PresetSpeedInq	8x 09 7E 01 0B FF	y0 50 p q r FF	p:pan speed (01h-18h) q:tilt speed (01h-14h) r:zoom speed (0h-07h)

Color and Light Management Commands

Command Set	Command	Command Packet	Comments
CAM_WB	Auto	8x 01 04 35 00 FF	Normal auto
	Manual	8x 01 04 35 05 FF	Manual control mode
Corresponds to <code>camera ccu set auto_white_balance</code> in Telnet API.			
CAM_RGain	Reset	8x 01 04 03 00 FF	Manual control of red gain pq = red gain (00h – FFh)
	Up	8x 01 04 03 02 FF	
	Down	8x 01 04 03 03 FF	
	Direct	8x 01 04 43 00 00 0p 0q FF	
Corresponds to <code>camera ccu set red_gain</code> in Telnet API.			
CAM_BGain	Reset	8x 01 04 04 00 FF	Manual control of blue gain pq = blue gain (00h – FFh)
	Up	8x 01 04 04 02 FF	
	Down	8x 01 04 04 03 FF	
	Direct	8x 01 04 44 00 00 0p 0q FF	
Corresponds to <code>camera ccu set blue_gain</code> in Telnet API.			
CAM_AE	Auto	8x 01 04 39 00 FF	Auto exposure mode
	Manual	8x 01 04 39 03 FF	Manual control mode
Corresponds to <code>camera ccu set auto_iris</code> in Telnet API.			
CAM_Shutter	Reset	8x 01 04 0A 00 FF	Shutter setting pq = shutter position (00h – 15h) See Shutter Speed Values – CAM_Shutter Command
	Up	8x 01 04 0A 02 FF	
	Down	8x 01 04 0A 03 FF	
	Direct	8x 01 04 4A 00 00 0p 0q FF	
CAM_Iris	Reset	8x 01 04 0B 00 FF	Iris setting pq = iris position (0h, 05h-11h) See Iris Values – CAM_Iris Command
	Up	8x 01 04 0B 02 FF	
	Down	8x 01 04 0B 03 FF	
	Direct	8x 01 04 4B 00 00 0p 0q FF	
Corresponds to <code>camera ccu set iris</code> in Telnet API.			
CAM_Gain	Reset	8x 01 04 0C 00 FF	Iris gain setting pq = gain position (01h – 0Fh) p = gain limit (04h-0Fh) See Iris Gain and Gain Limit Values – CAM_Gain Command
	Up	8x 01 04 0C 02 FF	
	Down	8x 01 04 0C 03 FF	
	Direct	8x 01 04 4C 00 00 0p 0q FF	
	+Gain Limit	8x 01 04 2C 0p FF	
Corresponds to <code>camera ccu set gain</code> in Telnet API.			
CAM_BackLight	On	8x 01 04 33 02 FF	Backlight compensation On/Off
	Off	8x 01 04 33 03 FF	
Corresponds to <code>camera ccu set backlight_compensation</code> in Telnet API.			

Command Set	Command	Command Packet	Comments
CAM_WD	On	8x 01 04 3D 02 FF	Wide Dynamic Range On
	Off	8x 01 04 3D 03 FF	Wide Dynamic Range Off
	Corresponds to <code>camera ccu set wide_dynamic_range</code> in Telnet API. May be unavailable on some cameras.		
CAM_Aperture	Reset	8x 01 04 02 00 FF	Aperture setting pq = aperture position (0h-0fh)
	Up	8x 01 04 02 01 FF	
	Down	8x 01 04 02 02 FF	
	Direct	8x 01 04 42 00 00 0p 0q FF	
	Corresponds to <code>camera ccu set detail</code> in Telnet API.		
CAM_Chroma	Direct	8x 01 7E 55 00 00 0p 0q FF	pq: 00h – 14h
	Corresponds to <code>camera ccu set chroma</code> in Telnet API.		
CAM_GammaOffset	Direct	8x 01 04 1E 00 00 00 0s 0t 0u FF	s: polarity offset (0 is plus, 1 is minus) tu: offset s=0 (00h to 40h) offset s=1 (00h to 10h)
	Corresponds to <code>camera ccu set gamma</code> in Telnet API.		

Shutter Speed Values (CAM_Shutter)

Value	60/59.94/30/29.97 fps	50/25 fps
0x15	1/10000	1/10000
0x14	1/6000	1/6000
0x13	1/4000	1/3500
0x12	1/3000	1/2500
0x11	1/2000	1/1750
0x10	1/1500	1/1250
0x0F	1/1000	1/1000
0x0E	1/725	1/600
0x0D	1/500	1/425
0x0C	1/350	1/300
0x0B	1/250	1/215
0x0A	1/180	1/150
0x09	1/125	1/120
0x08	1/100	1/100
0x07	1/90	1/75
0x06	1/60	1/50
0x05	1/30	1/25
0x04	1/15	1/12
0x03	1/8	1/6
0x02	1/4	1/3
0x01	1/2	1/2
0x00	1/1	1/1

Iris Values (CAM_Iris)

Value	Iris
0x11	F1.6
0x10	F2
0x0F	F2.4
0x0E	F2.8
0x0D	F3.4
0x0C	F4
0x0B	F4.8
0x0A	F5.6
0x09	F6.8
0x08	F8
0x07	F9.6
0x06	F11
0x05	F14
0x00	CLOSED

Iris Gain and Gain Limit Values (CAM_Gain)

Iris Gain			Iris Gain Limit		
Value	Steps	Gain in dB	Value	Steps	Gain in dB
0x0F	28	77.8	0x0F	28	77.8
0x0E	26	44.4	0x0E	26	44.4
0x0D	24	41.0	0x0D	24	41.0
0x0C	22	37.5	0x0C	22	37.5
0x0B	20	34.1	0x0B	20	34.1
0x0A	18	30.7	0x0A	18	30.7
0x09	16	27.3	0x09	16	27.3
0x08	14	23.9	0x08	14	23.9
0x07	12	20.5	0x07	12	20.5
0x06	10	17.1	0x06	10	17.1
0x05	8	13.7	0x05	8	13.7
0x04	6	10.2	0x04	6	10.2
0x03	4	6.8			
0x02	2	3.4			
0x01	0	0			

Color and Light Management Inquiry Commands

Inquiry Command	Command	Response Packet	Comments
CAM_WBModelInq	8x 09 04 35 FF	y0 50 00 FF	Auto
		y0 50 05 FF	Manual
CAM_RGainInq	8x 09 04 43 FF	y0 50 00 00 0p 0q FF	pq: Red gain
CAM_BGainInq	8x 09 04 44 FF	y0 50 00 00 0p 0q FF	pq: Blue gain
CAM_AEModelInq	8x 09 04 39 FF	y0 50 00 FF	Auto
		y0 50 03 FF	Manual
CAM_ShutterPosInq	8x 09 04 4A FF	y0 50 00 00 0p 0q FF	pq: Shutter position
CAM_IrisPosInq	8x 09 04 4B FF	y0 50 00 00 0p 0q FF	pq: Iris position
CAM_GainPosInq	8x 09 04 4C FF	y0 50 00 00 0p 0q FF	pq: Gain position
CAM_WDModelInq	8x 09 04 3D FF	y0 50 02 FF	On
		y0 50 03 FF	Off
CAM_BackLightModelInq	8x 09 04 33 FF	y0 50 02 FF	On
		y0 50 03 FF	Off
CAM_ApertureInq	8x 09 04 42 FF	y0 50 00 00 0p 0q FF	pq: Aperture gain
CAM_ChromaInq	8x 09 7E 55 FF	y0 50 05 00 00 00 0p FF	p: 0 – Eh
CAM_GammaOffsetInq	8x 09 04 1E FF	y0 50 00 00 00 0s 0t 0u FF	s: Polarity offset (0 is plus, 1 is minus) tu: Offset s=0 (00h to 40h) Offset s=1 (00h to 10h)

Other Commands

Command Set	Command	Command Packet	Comments
CommandCancel		8x 2p FF	p= socket (1 or 2)
CAM_Power	On	8x 01 04 00 02 FF	Power on
	Off	8x 01 04 00 03 FF	Power off
	Corresponds to <code>camera standby</code> in Telnet API.		
CAM_Tally	On	8x 01 7E 01 0A 00 02 FF	
	Off	8x 01 7E 01 0A 00 03 FF	
CAM_NR	--	8x 01 04 53 0p FF	p = noise reduction level (0: off, 1 – 5)
CAM_Mute	On	8x 01 04 75 02 FF	Video mute on/off
	Off	8x 01 04 75 03 FF	
	Toggle	8x 01 04 75 10 FF	
	Corresponds to <code>video mute</code> in Telnet API.		

Other Inquiry Commands

Inquiry Command	Command	Response Packet	Comments
CAM_PowerInq	8x 09 04 00 FF	y0 50 02 FF	On
		y0 50 03 FF	Off (standby)
	Corresponds to <code>camera standby get</code> in Telnet API		
CAM_IPAddress	8x 09 08 4E 00 00 FF	y0 50 49 50 00 00 00 0p 0p 0p 0q 0q 0q 0r 0r 0s 0s 0s FF	IP address = ppp.qqq.rrr.sss
CAM_TallyInq	8x 09 7E 01 0A FF	y0 50 02 FF	On
		y0 50 03 FF	Off
CAM_NRInq	8x 09 04 53 FF	y0 50 0p FF	Noise reduction p: 00h to 05h
CAM_MuteModelInq	8x 09 04 75 FF	y0 50 02 FF	On
		y0 50 03 FF	Off
	Corresponds to <code>video mute get</code> in Telnet API		
Vaddio_ModelInq	8x 09 08 0e FF	y0 50 05 0A 00 00 00 FF	RoboSHOT 12 HDBT
		y0 50 05 0B 00 00 00 FF	RoboSHOT 30 HDBT

Specifications

Camera and image

Image device	RoboSHOT 12 HDBT: 1/2.8-Type Exmor [®] CMOS sensor RoboSHOT 30 HDBT: 1/2.8-Type Exmor R [™] backlit CMOS sensor RoboSHOT 12E HDBT and RoboSHOT 30E HDBT: 1/2.5-Type Exmor R back-lit CMOS sensor
Video Resolutions	1080p/60, 59.94, 50, 30, 25 1080i/60, 59.94, 50 720p/60, 59.94, 50 RoboSHOT 12E HDBT and RoboSHOT 30E HDBT also offer 1080p/29.97
IP Streaming Resolutions	1080p, 720p, 4CIF, 480p, 640 x 480, 360p, CIF
Video Aspect Ratio	16:9 for all resolutions
Pan and tilt	Pan $\pm 150^\circ$, tilt $+90^\circ -30^\circ$; speed 0.35 [°] /sec to 120 [°] /sec
Lens and horizontal FOV	12 model: <ul style="list-style-type: none"> ○ Normal mode: 10x zoom, 67.3[°] (wide) to 7.6[°] (tele), f=3.8mm to 38.0mm, F1.8 to F3.4 ○ Super Wide mode: 12x zoom, 73.0[°] (wide) to 6.6[°] (tele), f=3.91mm to 47.0mm, F1.8 to F3.4 12E model: 12x zoom, 70.2 [°] (wide) to 6.8 [°] (tele), f=4.4mm wide end to 88.4mm tele end, F2 to F3.8 30 model: 30x zoom, 65 [°] (wide) to 2.3 [°] (tele), F1.6 to F4.7 30E model: 30x zoom, 70.2 [°] (wide) to 3.1 [°] (tele), f=4.4mm wide end to 88.4mm tele end, F2 to F3.8
Min. working distance	RoboSHOT 12 HDBT: 8 in. (0.2 m) wide, 30 in. (0.8 m) tele RoboSHOT 30 HDBT: 10 in. (0.25 m) wide, 48 in. (1.2 m) tele RoboSHOT 12E and 30E HDBT: 3 in. (0.08 m) wide, 31 in. (0.8 m) tele
Min. illumination	Recommended: 100+ lux
Gain	Auto/Manual (28 steps)
Backlight compensation	On/off
Aperture/detail	16 steps
Focusing system	Auto Focus, Manual Focus, One Push Trigger Mode, Infinity Mode, Near Limit Mode
White balance	Auto, ATW, Indoor, Outdoor, One-push, Manual
Noise reduction	On/Off, 6 Steps
Sync system	Internal
S/N ratio	More than 50 dB
Remote management	IR Remote Commander, web interface, Telnet and VISCA/RS-232 command APIs
Power	RoboSHOT 12 and 30 HDBT: 12 VDC, 3.0 A or PoE+ RoboSHOT 12E and 30E HDBT: PoE+

Physical and Environmental

Height	6.9 in. (17.6 cm)	Weight	4.85 lbs (2.2 kg)
Width	7.1 in. (17.9 cm)	Operating/storage temperature	0 [°] C to +40 [°] C (32 [°] F to 104 [°] F)
Depth	6.8 in. (17.2 cm)	Operating/storage humidity	20% to 80% RH, non-condensing

Specifications are subject to change without notice.

Troubleshooting and Care

Use this information to determine whether it's time to call Vaddio Technical Support.

Check the Status Light First

When the camera doesn't behave as you expect, check the indicator light before you do anything else.

- **Blue:** Normal operation (blinks once when the camera receives a command from the remote)
- **Red:** On-air tally (signal provided by external device via serial connection)
- **Blinking red:** Video is muted (UC color scheme only)
- **Purple:** In standby mode or booting
- **Yellow:** Firmware update in progress

If the status light is off, check whether you can access the camera via its web interface or Telnet. If so, the status light is disabled.

Check the Cables Next

If the equipment behaves in a way that suggests even a remote possibility of a bad cable, please try a known good cable with the same pin-out.

Cables can be defective, whether they are purchased from a vendor or made at the installation site. Crimping tools can crimp unevenly, contacts can break internally, and individual conductors in the cable can break inside the jacketing material. Any of these can result in a cable that passes a continuity check but does not work reliably, or does not pass enough power to the connected device.

(The author would like to confess having made a certain number of almost-good cables. It happens.)

Power/Responsiveness Issues

What is it doing?	Possible causes	Check and correct
<p>Nothing. The status light is off, there is no video, and the camera does not respond to the remote.</p> 	If a OneLINK extension module is used: The camera is not connected to the OneLINK module.	Plug the OneLINK module into the camera.
	If a OneLINK extension module is used: The OneLINK power supply is not connected.	Plug the OneLINK module's power supply into a wall outlet.
	If a OneLINK extension module is used: The OneLINK module is not working properly.	Test by connecting the camera directly to the PoE+ power injector or 12VDC power pack that was shipped with it. If the camera works when it is connected to a power source, but not when connected to the the OneLINK module, the OneLINK is bad. Contact your reseller or Vaddio Technical Support.
	Caution: Do not connect the camera to the 48 VDC OneLINK power pack. This will damage the camera and void its warranty.	
	Insufficient power using a PoE injector.	Use a PoE+ power injector – PoE does not deliver enough power.
	At least one of the cables is bad.	Check using known good cables.
	The wall outlet is not active. (Check by finding out if it powers something else, such as a laptop or phone charger.)	Use a different outlet.
The camera or its power source is bad.	Contact your reseller or Vaddio Technical Support.	
The camera never finishes initializing and the light is purple. The web interface is not available.	The camera is not receiving enough power. Is a PoE power injector connected?	Use PoE+ instead. PoE does not deliver enough power for a PTZ camera.
	The PoE+ power injector is bad.	Contact your reseller or Vaddio Technical Support.
The camera does not respond to the remote and the light is yellow.	A firmware update is in progress.	Wait a few minutes, and try again when the light turns blue.

Video and Streaming Issues

What is it doing?	Possible causes	Check and correct
Blue or black video. The camera's web interface is available and the camera responds to the directional controls on the remote.	Video is muted.	Select the Mute button in the web interface. This button is available on every page of the web interface.
No IP stream.	Streaming is not enabled.	Enable streaming: Streaming page in the web interface.

Camera Control and Other Issues

What is it doing?	Possible causes	Check and correct
The camera does not respond to the remote, but the web interface is available.	The remote and the camera are not using the same IR channel.	Press the Camera Select 1 button on the remote. Try the other Camera Select buttons if necessary.
	IR is switched off	Turn IR on using the appropriate DIP switch or soft DIP switch. More information: DIP Switches: Camera Behavior Settings (older RoboSHOT cameras) or Basic Camera Settings for RoboSHOT 12E HDBT and RoboSHOT 30E HDBT .
	The remote's batteries are dead.	Put new batteries in the remote.
The camera responds to the remote but not to the web interface.	The web interface is controlling a different camera. (Check by removing power from the camera; the web interface should become unavailable.)	Check the camera's IP address. See Getting the camera's IP address .
	More than one device is using this IP address.	
The camera responds to the remote but the web interface is not available.	The camera is not using the IP address you browsed to.	Press the Data Screen button on the remote to see camera information.
	The camera is not connected to the network.	Connect the network cable.
The camera loses all its settings when power is cycled.	All the DIP switches are in the ON (down) position.	Set the DIP switches to their proper positions. Default is all OFF (up). See DIP Switches: Camera Behavior Settings for more information.



Restoring Factory Settings from the Web Interface

SYSTEM PAGE, FIRMWARE TAB

Sometimes it's easiest to just start over. To restore the original factory settings...click Restore Factory Settings. This will overwrite everything you have customized – custom CCU scenes and presets, soft DIP switch settings, passwords, room labels, and more. For this reason, you may want to back up (export) the camera's configuration after you set up the customizations you want. See [Saving \(Exporting\) or Restoring \(Importing\) a Configuration](#).

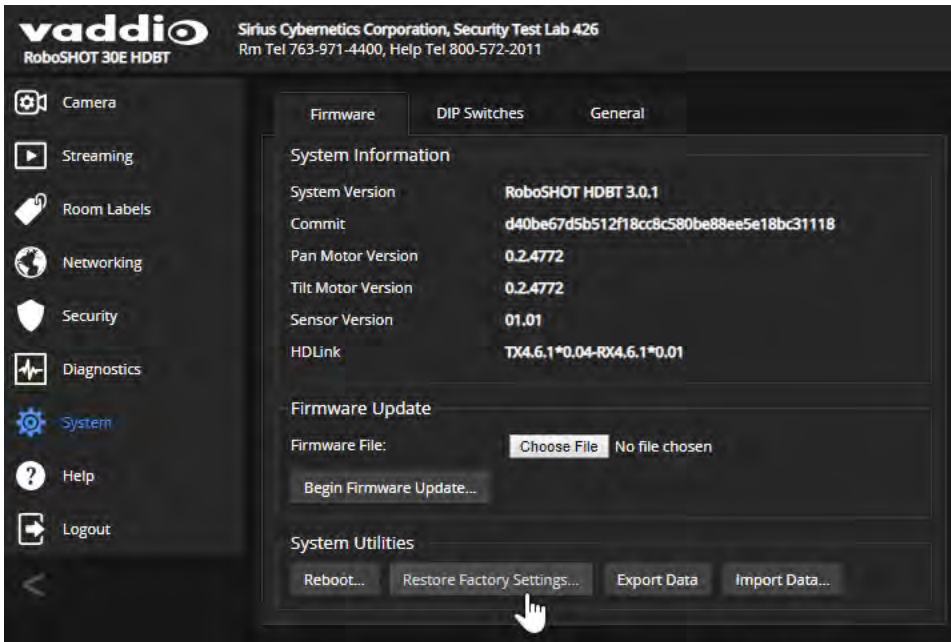

Restoring Factory Default Settings Via Hardware

If the camera's administrative controls are not accessible, you can restore factory defaults using the switches on the back of the camera.

To restore factory default settings on an older RoboSHOT camera:

Set all DIP switches DOWN and cycle the power. Then return all DIP switches to the desired settings.

To restore factory default settings on a RoboSHOT 12E HDBT or RoboSHOT 30E HDBT camera:

Set the rotary switch to the Factory Reset position (E) and cycle the power. Then return the rotary switch to its previous position.

Operation, Storage, and Care

For smears or smudges on the product, wipe with a clean, soft cloth. Use a lens cleaner on the lens. Do not use any abrasive chemicals.

Keep this device away from food and liquids.

Do not operate or store the device under any of the following conditions:

- Temperatures above 40°C (104°F) or below 0°C (32°F)
- High humidity, condensing or wet environments
- Inclement weather
- Severe vibration
- Inside a cement mixer
- Dry environments with an excess of static discharge

Do not attempt to take this product apart. There are no user-serviceable components inside.

And a friendly reminder from our Training department...

As much as you might love our gear, do not attempt to romance your camera. As a robot it cannot return your love.



Compliance and Conformity Statements

Compliance testing was performed to the following regulations:

FCC Part 15 (15.107, 15.109), Subpart B	Class A
ICES-003, Issue 54: 2012	Class A
EMC Directive 2014/30/EU	Class A
EN 55032: 2015	Class A
EN 55024: November 2010	Class A
KN24 2008 (CISPR 24: 1997 + A1: 2000 + A2: 2002)	Class A
IEC 60950-1:2005 (2nd Edition); Am 1: 2009 + Am 2: 2013	Safety
EN 60950-1: 2006 + A11: 2009 + A1: 2010 + A12: 2011 + A2: 2013	Safety

FCC Part 15 Compliance

This equipment has been tested and found to comply with the limits for a Class A digital device, pursuant to Part 15, Subpart B, of the FCC Rules. These limits are designed to provide reasonable protection against harmful interference when the equipment is operated in a commercial environment. This equipment generates, uses, and can radiate radio frequency energy and, if not installed and used in accordance with the instruction manual, may cause harmful interference to radio communications. Operation of this equipment in a residential area is likely to cause harmful interference in which case the user will be required to correct the interference at his/her own expense.

Operation is subject to the following two conditions: (1) This device may not cause interference, and (2) This device must accept any interference including interference that may cause undesired operation of the device.

Changes or modifications not expressly approved by Vaddio can affect emission compliance and could void the user's authority to operate this equipment.



ICES-003 Compliance

This digital apparatus does not exceed the Class A limits for radio noise emissions from digital apparatus set out in the Radio Interference Regulations of the Canadian Department of Communications.

Le présent appareil numérique n'émet pas de bruits radioélectriques dépassant les limites applicables aux appareils numériques de la classe A prescrites dans le Règlement sur le brouillage radioélectrique édicté par le ministère des Communications du Canada.



European Compliance

This product has been evaluated for Electromagnetic Compatibility under the EMC Directive for Emissions and Immunity and meets the requirements for a Class A digital device. In a domestic environment this product may cause radio interference in which case the user may be required to take adequate measures.

Standard(s) To Which Conformity Is Declared:



EMC Directive 2014/30/EU

EN 55032: 2015

Conducted and Radiated Emissions

EN 55024: November 2010

Immunity

EN 61000-4-2: 1995 + Amendments A1: 1998 + A2: 2001

Electrostatic Discharge

EN 61000-4-3: 2006 + A1: 2008

Radiated Immunity

EN 61000-4-4: 2004 + Corrigendum 2006

Electrical Fast Transients

EN 61000-4-5: 2006

Surge Immunity

EN 61000-4-6: 2009

Conducted Immunity

EN 61000-4-8: 2010

Power Frequency Magnetic Field

EN 61000-4-11: 2004

Voltage Dips, Interrupts and Fluctuations

KN24 2008 (CISPR 24: 1997 + A1: 2000 + A2: 2002)

IT Immunity Characteristics

EN 61000-4-2

Electrostatic Discharge

EN 61000-4-3

Radiated Immunity

EN 61000-4-4

Electrical Fast Transients

EN 61000-4-5

Surge Immunity

EN 61000-4-6

Conducted Immunity

EN 61000-4-8

Power Frequency Magnetic Field

EN 61000-4-11

Voltage Dips, Interrupts and Fluctuations

IEC 60950-1: 2005 (2nd Edition); Am 1: 2009 + Am 2: 2013

Safety

EN 60950-1: 2006 + A11: 2009 + A1: 2010 + A12: 2011 + A2: 2013

Safety

Warranty and Return Policy

Hardware warranty: Two (2) year limited warranty on all parts and labor for Vaddio manufactured products. Vaddio warrants its manufactured products against defects in materials and workmanship for a period of two years from the day of purchase, to the original purchaser, if Vaddio receives notice of such defects during the warranty. Vaddio, at its option, will repair or replace products that prove to be defective. Vaddio manufactures its hardware products from parts and components that are new or equivalent to new in accordance with industry standard practices.

Exclusions: The above warranty shall not apply to defects resulting from improper or inadequate maintenance by the customer, customers applied software or interfacing, unauthorized modifications or misuse, mishandling, operation outside the normal environmental specifications for the product, use of the incorrect power supply, modified power supply or improper site operation and maintenance. OEM and special order products manufactured by other companies are excluded and are covered by the manufacturer's warranty.

Vaddio Customer Service: Vaddio will test, repair, or replace the product or products without charge if the unit is under warranty. If the product is out of warranty, Vaddio will test then repair the product or products. The cost of parts and labor charge will be estimated by a technician and confirmed by the customer prior to repair. All components must be returned for testing as a complete unit. Vaddio will not accept responsibility for shipment after it has left the premises.

Vaddio Technical Support: Vaddio technicians will determine and discuss with the customer the criteria for repair costs and/or replacement. Vaddio Technical Support can be contacted by email at support@vaddio.com or by phone at one of the phone numbers listed on support.vaddio.com.

Return Material Authorization (RMA) number: Before returning a product for repair or replacement request an RMA from Vaddio's technical support. Provide the technician with a return phone number, e-mail address, shipping address, product serial numbers and original purchase order number. Describe the reason for repairs or returns as well as the date of purchase. See the General RMA Terms and Procedures section for more information. RMAs are valid for 30 days and will be issued to Vaddio dealers only. End users must return products through Vaddio dealers. Include the assigned RMA number in all correspondence with Vaddio. Write the assigned RMA number clearly on the shipping label of the box when returning the product. All products returned for credit are subject to a restocking charge without exception. Special order products are not returnable.

Voided warranty: The warranty does not apply if the original serial number has been removed or if the product has been disassembled or damaged through misuse, accident, modifications, use of incorrect power supply, use of a modified power supply or unauthorized repair.

Shipping and handling: Vaddio will not pay for inbound shipping transportation or insurance charges or accept any responsibility for laws and ordinances from inbound transit. Vaddio will pay for outbound shipping, transportation, and insurance charges for all items under warranty but will not assume responsibility for loss and/or damage by the outbound freight carrier. If the return shipment appears damaged, retain the original boxes and packing material for inspection by the carrier. Contact your carrier immediately.

Products not under warranty: Payment arrangements are required before outbound shipment for all out of warranty products.

General RMA Terms and Procedures: RMA's are valid for 30 days and will be issued to Vaddio dealers only.

- End users must return products through Vaddio dealers.
- Before a defective product can be authorized to send in for repair, it must first go through the troubleshooting process with a member of the Vaddio Technical Support team.
- Products authorized for repair must have a valid RMA (Return Material Authorization) number.
 - Vaddio RMA Team will issue the RMA number.
 - An RMA number is to be included in all correspondence with Vaddio.
 - The RMA number must appear clearly on the shipping label (not the box) when the product is returned.
 - A packing slip must be included on the inside of the box with the RMA number listed and reason for RMA return.
- Products received at Vaddio that do not have a valid RMA number clearly marked on the outside of the shipping container may be refused and returned to sender.
- Boxes showing external damage will be refused and sent back to the sender regardless of the clearly marked RMA number and will remain the responsibility of the sender.

RMA Charges (Restocking): All qualified returns must be made in unopened, original packaging with all original materials.

- Initial shipments of equipment that are refused upon attempted delivery, for any reason, are subject to restocking charges.
- The Dealer has up to 60 days from the date of purchase to return Vaddio product for credit for future purchases of Vaddio product only.
- The Dealer has 61 to 90 days from the date of purchase to return Vaddio product with a 15% restocking fee or \$50.00 fee, whichever amount is greater
- The Dealer has up to 30 days from the date of purchase to return OEM and other manufacturer's products with a 15% restocking fee or \$50.00 fee, whichever amount is greater.
- NOTE: Special Order products from other manufacturers (identified in the Vaddio Price Guide as noncancelable, nonreturnable and not refundable) are not eligible for advance replacement from Vaddio.

Advance Replacement Policies: For Vaddio manufactured products, advance replacement will be provided for up to one (1) year after the initial shipment of products.

- NOTE: OEM and other manufacturer's products are excluded from the Vaddio advance replacement policy. Advance replacement will be provided for up to 30 days after initial shipment of OEM products. Thereafter, a return to Vaddio and factory repair is offered during the other manufacturer's warranty period. Vaddio will determine if the returned product is qualified for the OEM warranty.
- NOTE: Special Order products from other manufacturers (identified in the Vaddio Price Guide as noncancelable, nonreturnable and not refundable) are not eligible for advance replacement from Vaddio.

Advance Replacement Procedures: The Vaddio Dealer must submit a non-revocable purchase order for advance replacement equipment at normal dealer pricing. Credit shall be issued upon complete product return (including all accessories) for dealers with Net 30 terms. For credit card accounts, charges will be assessed to the credit card for the replacement and credited back upon complete product return.

- Returns must be made in the original Vaddio packaging with all original materials if at all possible. Vaddio products with missing original materials will be billed to the dealer at dealer price.
- NOTE: OEM products must be returned in the original packaging with all materials and the RMA number written on the shipping label only and not on the OEM box. If the return is incomplete and/or the OEM box is defaced, the product shall be returned to the dealer and the RMA will not be credited.
- Equipment returned with “No Trouble Found” after advanced replacement will be assessed a full 15% or \$50.00 restocking fee (whichever is greater) for each item and may also be assessed for additional charges to compensate for wear, damages and reconditioning.
- All returns must be accompanied by RMA # as stated above.
- All Advanced Replacement products are sent via 2-day service in the continental USA. If the product is requested to be sent via priority or overnight shipping, the Dealer shall pay shipping costs. The dealer can elect to supply their preferred shipping account number.
- International customers are responsible for all freight charges for equipment returned to Vaddio, including international shipping, taxes, and duties, insurance and all other associated logistic charges.

Warranty Repair Terms and Procedures: Vaddio will repair any product free of charge, including parts and labor, within the terms outlined in the warranty agreement for that product.

- Customers must provide proof of the product’s purchase date.
- Product that is within the warranty period will be repaired under the non-warranty terms if:
 - The equipment has been damaged by negligence, accident, act of God, mishandling, used with the incorrect, modified or extended power supply or has not been operated in accordance with the procedures described in the operating and technical instructions.
 - The equipment has been altered or repaired by other than the Manufacturer or an authorized service representative.
 - Adaptations or accessories other than those manufactured or provided by the Manufacturer have been made or attached to the equipment, which in the determination of the Manufacturer, shall have affected the performance, safety or reliability of the equipment; or the equipment’s original serial number has been modified or removed.
- Customer is responsible for shipping charges to send defective product under warranty to Vaddio. Vaddio will pay ground service return shipping charges during the 2nd year of the warranty period.
- Standard return shipping method for products under warranty, but out of the advance replacement warranty period, is ground shipment. Extra charges associated with priority shipping, when requested, will be the responsibility of the customer.

Non-Warranty Repair Terms: Vaddio will repair any non-obsolete product that does not meet the terms of the warranty. Non-warranty repair terms are as follows:

- The customer is responsible for, and agrees to pay, all parts and labor costs associated with the repair. Standard non-warranty repair charges are outlined below.
- Customers must provide payment method and one of the following, prior to receiving an RMA:
 - Hard copy of a PO, for dealers with Net 30 terms and in good standing with Vaddio.
 - Valid credit card number - Credit card will be charged upon shipping repaired product back to customer.
- Request for COD: Customers will be notified of COD charges prior to shipping repaired unit.
- Customer is responsible for all shipping charges both to and from Vaddio, and may use their own carrier.
- Customers will receive a courtesy call notifying them of total repair charges prior to return shipping.

Non-Warranty Repair Charges: Total repair charges (per unit) for a non-warranty repair consist of the following:

- Cost of any replacement parts needed to repair the defect.
- Labor costs billed per hour after minimum charges/time.
- Labor charges include troubleshooting and repair time only.
- Burn-in time and final test time is not included in the labor charges.
- Labor time is rounded to the nearest quarter hour.
- Labor charges are billed at the prevailing rate for the category of equipment repaired, after minimum charges/time. For prevailing labor rates, please contact the Vaddio technical support.
- All shipping and handling costs are the responsibility of the customer for non-warranty repairs.

Minimum Labor Charges: All non-warranty repairs are subject to a minimum evaluation/repair labor charge even if there is no problem found. Please contact Vaddio technical support for the current applicable rate.

Repair Charge Estimates: Estimates on repair charges for a specific problem will not be given before an RMA is issued and the actual product has been evaluated by a Vaddio technician. Repair estimates will be given after the repair department receives and evaluates the unit.

- Customers requesting an estimate on repair charges must do so up front when they call in for an RMA. The RMA team will call or email with the estimate after evaluating the unit and before proceeding with the repair.
- Any product evaluated for a repair estimate is still subject to the minimum labor charges even if the customer decides not to proceed with the repair.
- Vaddio does not guarantee estimates given on repair charges. Actual repair costs may exceed the estimate.
- Customer is responsible for actual repair charges, regardless of estimate.

Repair Policy Notes:

- **Duration of Repair:** Products are repaired on a first come first serve basis. The turn-a-round time of a particular repair is dependent upon circumstances such as product type, the nature of the problem and current repair volumes. Requests for expedited repair service will be considered on a case-by-case basis.
- **Repair Warranty:** Vaddio guarantees all of its repair work, performed on non-warranty items, for 90 days from the day the repaired product is shipped back to the customer. If the original problem described was not resolved or reoccurs within the 90-day period, Vaddio will repair the unit free of labor charges. However additional material charges may apply unless the parts used to affect the repair are again deemed defective.

Photo Credits

This manual may include some or all of these photos.

European Space Agency (ESA) astronaut Samantha Cristoforetti, a Flight Engineer with Expedition 42, photographs the Earth through a window in the Cupola on the International Space Station

By NASA - https://blogs.nasa.gov/ISS_Science_Blog/2015/03/06/women-in-space-part-two-whats-gender-got-to-do-with-it/, Public Domain, <https://commons.wikimedia.org/w/index.php?curid=38834990>

Carl Sagan, Bruce Murray, Louis Friedman (founders) and Harry Ashmore (advisor), on the occasion of signing the papers formally incorporating The Planetary Society

By credit NASA JPL - JPL, Public Domain, <https://commons.wikimedia.org/w/index.php?curid=1180927>

Main Control Room / Mission Control Room of ESA at the European Space Operations Centre (ESOC) in Darmstadt, Germany

By European Space Agency - ESOC flickr, Credit: ESA - Jürgen Mai, CC BY-SA 3.0-igo,

<https://commons.wikimedia.org/w/index.php?curid=36743173>

Expedition 42 on orbit crew portrait, International Space Station, Mar. 7, 2015 – Barry Wilmore (Commander) Top, Upside down, to the right cosmonaut Elena Serova, & ESA European Space Agency Samantha Cristoforetti. Bottom center US astronaut Terry Virts, top left cosmonauts Alexander Samokutyaev and Anton Shkaplerov.

By NASA - <https://www.flickr.com/photos/nasa2explore/16166230844/>, Public Domain,

<https://commons.wikimedia.org/w/index.php?curid=38931301>

European Space Agency astronaut Luca Parmitano, Expedition 36 flight engineer, outside the International Space Station

By NASA - <http://spaceflight.nasa.gov/gallery/images/station/crew-36/html/iss036e016704.html>, Public Domain, <https://commons.wikimedia.org/w/index.php?curid=27263573>

Chris Cassidy, Luca Parmitano, and Karen Nyberg, ISS, 2013. Photo Credit: NASA

Nicolas Altobelli, Rosetta Scientist at ESA's European Space Astronomy Centre, Villanueva de la Cañada, Madrid, Spain

By European Space Agency - Nicolas Altobelli talks to the media, CC BY-SA 3.0-igo,

<https://commons.wikimedia.org/w/index.php?curid=36743144>

Andrea Accomazzo, ESA Rosetta Spacecraft Operations Manager, providing a live update from the Main Control Room at ESA's European Space Operations Centre, Darmstadt, Germany during the Rosetta wake-up day.

By European Space Agency - Live update from the Main Control Room, CC BY-SA 3.0-igo,

<https://commons.wikimedia.org/w/index.php?curid=36743150>

Sleeping goose

By ladypine - Own work, CC BY-SA 3.0, <https://commons.wikimedia.org/w/index.php?curid=1695227>

STS-123 and Expedition 16 crews on the STS-123 crew's last full day onboard the International Space Station.

By NASA - <http://www.spaceflight.nasa.gov/gallery/images/shuttle/sts-123/html/iss016e033684.html>, Public Domain, <https://commons.wikimedia.org/w/index.php?curid=3773505>

Index

A

- admin login 27, 35
 - changing 35
 - default 27
- anatomy of the camera 8-10
- API 66-81, 83-84, 86-89
 - RS-232 (VISCA) 81, 83-84, 86-89
 - Telnet 67-80
- auto focus 48, 70
- auto iris 45, 72-73
- auto white balance 45, 47, 72-73
- automatic NTP updating 34

B

- backing up a configuration 38
- backlight compensation 45-46, 72-73
- behavior on power-up 22, 42
- bit rate, constant or variable (IP streaming setting) 52
- blue gain 45, 47, 72-73
- browser compatibility 25

C

- cable 9-10, 15, 91
 - connectors 9-10, 15
 - please check them (PLEASE) 15, 91
 - recommendations 15
- camera control issues, troubleshooting 93
- camera mount, installing 12
- Camera page (web) 44-45
- camera select 23-24
- camera specifications 90
- camera standby position 64
- capabilities 2, 90
- CCU scenes 42-44, 47, 65, 74
 - custom 43, 47, 74
 - recalling 74
- CCU settings 46-47, 71-73
- ceiling-mounted cameras 12
- cheat sheet 23, 28, 46-47
 - color adjustment 47
 - lighting and image quality 46
 - Vaddio IR Remote Commander 23
 - web interface 28
- chroma setting 45-47, 72-73

- cleaning 95
- Codec Control Mode setting 62
- color codes for status light 22, 91
- color settings 44-45, 47, 72-73
- command history 79
- command set, RS-232 (VISCA) 81, 83-84, 86-89
- compatibility, browsers 25
- conferencing 49
- configuration, saving or restoring 38
- connection example 16-17
- connector identification 9-10
- connector pin-out, RS-232 15
- constant bit rate (IP streaming setting) 52
- Controls page (web) 64
- custom CCU scenes 47
- custom home position, setting 42

D

- damage, preventing 11, 15
- default 25-27, 78, 94
 - admin password 27
 - IP address 25
 - settings, restoring 78, 94
 - user password 26
- detail setting 45-46, 72-73
- diagnostic logs 41
- Diagnostics page (web) 41
- DIP switch settings 60, 62
 - reading from web interface 60
- directional controls 23-24, 65

E

- Enable LED in Standby setting 62

F

- factory defaults, restoring 78, 94
- fault isolation 91-93
- firmware update 39
- firmware version 39, 79
- focus 23-24, 48, 70

G

- gain 45-47, 72
 - blue 45, 47
 - iris 46
 - red 45, 47
- gamma setting 45-46
- getting help 41

guest access 35

H

HDMI Audio Enabled/Disabled setting 62

HDMI resolution, setting 13

Help page (web) 41

home position 42, 65, 67

 custom 42

hostname 32

 camera 32

HTTPS, enabling or requiring 36

I

importing a configuration 38

inactive sessions (web interface) 35

indicator light 8, 22, 62, 74, 91

 color scheme 62

 enabling/disabling 74

 location 8

 meaning of colors 22, 91

information, conference room 37

installation, typical 16-17

inverted installation 12

IP address 16, 23-25, 30, 32-33

 camera, discovering 25

 default 25, 30, 33

 preventing conflicts 16

 static 32

 static, configuring before installation 16, 30

IP streaming 49, 51-55, 75-76

 enabling or disabling 49

 quality 52

 resolutions and frame rates 51-52

 settings 51-55, 75-76

IR remote 23-24

iris settings 45-46, 72-73

L

labels, room 37

LED 8, 22, 62, 74, 91

 enabling/disabling 74

 location 8

 meaning of colors 22, 91

LED Color Scheme setting 62

LED On/Off setting 62

light, status indicator 8, 22, 62, 74, 91

 color scheme 62

 enabling/disabling 74

 location 8

 meaning of colors 22, 91

lighting settings 44-45, 65, 72-74

locations of connectors 9-10

log files 41

login 26-27

 admin 27

 user 26

low-power (standby) state 64, 75

M

manual focus 23-24, 48, 70

media player 49

mounting cameras 11-12, 21

muting video 64

N

navigation buttons, hiding/showing 27

network configuration 25, 30, 32-33, 76

 current 76

Networking page (web) 30, 32-34

NTP server 34

O

One Push White Balance 47

OneLINK 9-10, 16-17

operating environment 95

output resolution 13

P

packing lists 3

page 30, 32-37, 39-41, 44-45, 49, 53-55, 62, 64

 Camera 44-45

 Control 64

 Diagnostics 41

 Help 41

 Networking 30, 32-34

 Room Labels 37

 Security 35-36

 Streaming 49, 53-55

 System 39-40, 62

pan 56-57, 59, 67

 direction 59

 speed 56-57

pan/tilt/zoom controls 23-24, 65

passwords 26-27, 35

 admin, default 27

 user, default 26

performance specifications 90
 physical and environmental specifications 90
 pin-out, RS-232 connector 15
 ping command 77
 point light compensation 45-46
 power 9-10, 16-17, 22-24, 92
 issues, troubleshooting 92
 on and off 22-24
 options 10, 16-17
 PoE+ 9-10
 power-up settings 42
 presets 23-24, 43, 65, 71
 clearing 24
 moving to 65
 recalling 71
 renaming 43
 setting 24, 71
 privacy 64
 Pro AV LED Color Scheme setting 62
 product capabilities 2
 product returns and repairs 98

Q

quantization (IP streaming setting) 52
 quick reference 23, 28, 46-47
 Vaddio IR Remote Commander 23
 web interface 28

R

ready state 64, 75
 rebooting the camera 40, 77
 red gain 45, 47, 72-73
 remote control 23-24
 reset See also rebooting the camera; restoring default settings
 resolution 13, 51-52, 62
 IP streaming 51-52
 setting in web interface 62
 restoring a configuration 38
 restoring default settings 78, 94
 RJ-45 connectors 15
 room information 37
 Room Labels page (web) 37
 rotary switch 13
 RS-232 commands 81, 83-84, 86-89
 setting values 86-87
 RS-232 connector 15
 RTMP streaming 49, 54
 RTSP streaming 49, 51-53

S

safety requirements 11
 saving a configuration 38
 scenes, CCU 43-44, 65
 naming 43
 storing 47
 Scott 44
 Security page (web) 35-36
 session time-out 35
 settings, default, restoring 78, 94
 shelf-mounted cameras 21
 shelf, camera mount 12
 soft DIP switches 62
 software control of video output resolution 62
 solving problems 91-93
 specifications 90
 speed 56-57, 67-70
 focus 70
 pan/tilt/zoom 56-57, 67-69
 SSL certificate 36
 Standard Control/Codec Control setting 62
 standby (low-power) state 64, 75
 start-up behavior, setting 42
 static IP address 30, 32-33
 status light 8, 22, 62, 74, 91
 color scheme 62
 enabling/disabling 74
 location 8
 meanings of colors 22, 91
 storage environment 95
 storing a configuration 38
 stream viewer 49
 streaming 49-55, 75-76, 93
 enabling or disabling 49-50
 IP 49
 issues, troubleshooting 93
 MTU, setting 55
 quality 52
 settings 51-55, 76
 state 75
 USB 49
 Streaming page (web) 49, 53-55
 streaming URL 53
 supported web browsers 25
 switch settings 12-13, 39, 60, 62
 3G Level A/Level B 62
 Enable LED in Standby 62

- HDMI Audio Enabled/Disabled 62
- Image Flip 12
- LED Color Scheme 62
- LED On/Off 62
- reading from web interface 39
- Standard Control/Codec Control 62
- video resolution 13
- System page (web) 39-40, 62
- system time 34

T

- technical specifications 90
- technical support 41
- Telnet 35, 66
 - disabling access via 35
 - session 66
 - session history 79
 - session, ending 80
- Telnet API 66-80
 - command help 66
 - syntax help 80
- temperature, operating and storage 95
- tilt 56-57, 59, 68
 - direction 59
 - speed 56-57
- time zone 34
- Tri-Synchronous Motion (Tri-Sync) 58, 71
- troubleshooting 91-93
- typical installation 21

U

- UC LED Color Scheme setting 62
- update 39
- URL, RTSP streaming 53
- USB streaming 49
- user login 26, 35
 - changing 35
 - default 26

V

- Vaddio IR Remote Commander 23
- variable bit rate (IP streaming setting) 52
- version, firmware 79
- video mute 64
- Video Output Resolution (setting) 62
- video resolution 13
- VISCA commands 81, 83-84, 86-89
- voilà, a small cat 93

W

- wall-mounted cameras 21
- wall mount 12
- warranty 11, 98
- web browsers supported 25
- web interface 25, 27, 30-37, 39-41, 44-45, 49, 53-55, 62, 64
 - accessing 25
 - accessing via direct connection 31
 - Camera page 44-45
 - Controls page 64
 - Diagnostics page 41
 - Help page 41
 - navigation button labels 27
 - Networking page 30, 32-34
 - Room Labels page 37
 - Security page 35-36
 - Streaming page 49, 53-55
 - System page 39-40, 62
- wide dynamic range setting 45-46, 72-73

Z

- zoom 65, 69
- zoom speed 23-24, 56-57, 69

Vaddio is a brand of Legrand AV Inc. · www.legrandav.com · Phone 800.572.2011 / +1.763.971.4400 · Fax +1.763.971.4464 · Email av.vaddio.support@legrand.com

Visit us at support.vaddio.com for firmware updates, specifications, drawings, manuals, technical support information, and more.

©2019 Legrand AV Inc.

Vaddio is a registered trademark of Legrand AV Inc. All other brand names or marks are used for identification purposes and are trademarks of their respective owners. All patents are protected under existing designations. Other patents pending.

A brand of  legrand®

Commercial AV Brands Chief | Da-Lite | Middle Atlantic | Projecta | Vaddio

vaddio®