



Integrator's Complete Guide to the

DocCAM 20 HDBT

Ceiling-Mounted Document Camera

Document 411-0017-30 Rev C
May 2018

Contents

Overview	1
What's in this Guide	1
Features	2
Unpacking the Camera	3
A Quick Look at the Camera	4
Features of Interest During Installation	5
Connector Panel	5
Features of Interest During Operation	6
Installing the Camera	7
Don't Void Your Warranty!	7
Cabling Notes	7
Pre-Installation Functional Check	8
Basic Connection Diagram	9
Options for Power and Other Connections	9
About Installation Height and Viewing Area	10
Selecting the Installation Area	10
Things You Will Need for the Installation	11
Installing the Power Source	11
Installing the Camera in a Suspended Tile Ceiling	12
Preparing the Tile Ceiling	12
Completing the Installation in a Tile Ceiling	13
Installing the Camera in a Hard Ceiling	14
Preparing the Hard Ceiling	14
Completing the Installation in a Hard Ceiling	15
Powering Up the Camera	16
Status Light	17
Using the IR Remote	18
IR Remote Cheat Sheet	18
IR Remote Details	19
Storing a Preset Using the Remote	19
Clearing a Preset Using the Remote	19
Web Interface	20
Getting the Camera's IP Address	20
Accessing the Web Interface	20
Browser Support	20
Administrative Access	21
Compact Menu View	21
Web Interface Cheat Sheet	22
System Administration	23
Configuring Network Settings	24

Specifying Time Zone and NTP Server	25
Managing Access and Passwords	26
Adding Room Information to the Web Interface	27
Rebooting the Camera	27
Saving (Exporting) or Restoring (Importing) a Configuration	28
Installing a Firmware Update	29
Contacting Vaddio Technical Support	30
Accessing the Diagnostic Logs	30
Configuring Camera Behavior	31
Configuring IP Streaming	31
Editing IP Streaming Settings	31
Protocol and Streaming URL	33
Adjusting for the Lighting in the Room	34
Setting the Home Zoom Level and Other Zoom Presets	36
Setting Video Output Resolution	38
Enabling or Disabling the Laser Pointer	39
Software Switch Settings	40
Operating the Camera from the Web Interface	41
Telnet Serial Command API	43
camera zoom	44
camera focus	45
camera preset	46
camera ccu get	47
camera ccu set	48
camera resolution	49
camera laser	50
camera home	51
camera standby	51
video mute	51
streaming settings get	52
network ping	53
network settings get	53
system reboot	54
system factory-reset	54
version	55
history	55
help	56
exit	56
RS-232 Control	57
Camera Zoom and Focus Commands	57
Zoom and Focus Inquiry Commands	58

Color and Light Management Commands	59
Exposure Compensation Values (CAM_ExpComp)	61
Shutter Speed Values (CAM_Shutter)	62
Iris Values (CAM_Iris)	63
Iris Gain Values (CAM_Gain)	63
Iris Gain Limit Values (CAM_Gain)	64
Color and Light Management Inquiry Commands	64
Other Commands	65
Other Inquiry Commands	66
Specifications	67
Troubleshooting and Care	68
Check the Status Light First	68
Identify the Issue	68
Restoring Factory Settings	69
Operation, Storage, and Care	69
Compliance Statements and Declarations of Conformity	70
FCC Part 15 Compliance	70
ICES-003 Compliance	71
European Compliance	71
Warranty Information	72
Photo Credits	73
Index	74

Overview

This guide describes installation and related information for the DocCAM 20 HDBT ceiling-mounted document camera:

- Camera only, worldwide – 999-9968-000
- Camera with OneLINK HDMI camera extension, North America – 999-9968-200
- Camera with OneLINK HDMI camera extension, Europe/UK – 999-9968-201
- Camera with OneLINK Bridge A/V interface, North America – 999-9968-300
- Camera with OneLINK Bridge A/V interface, Europe/UK – 999-9968-301



What's in this Guide

This guide covers:

- Unpacking and installation
- The camera's physical features
- Controlling the camera using the IR remote or web interface
- Working with the Universal CCU
- Controlling the camera using Telnet or RS-232 commands
- Specifications
- Troubleshooting and maintenance
- Warranty and compliance/conformity information

For your convenience, this information is also available in smaller, limited-purpose manuals:

- **Installation Guide for RoboSHOT Cameras with the Universal CCU Interface** (unpacking, physical features, switch settings, installation, initial power-up)
- **Configuration and Administration Guide for RoboSHOT Cameras with the Universal CCU Interface** (physical features, controlling the camera, troubleshooting, and specifications)
- **Installation Guide for RoboSHOT Cameras with Quick-Connect Interfaces** (unpacking, physical features, switch settings, installation, initial power-up)
- **Configuration and Administration Guide for RoboSHOT Cameras with Quick-Connect Interfaces** (physical features, controlling the camera, troubleshooting, and specifications)

Download manuals, dimensional drawings, and other information from www.vaddio.com/support.

Features

- Exmor® 1/2.8 type, high-speed, low-noise image sensor for 2.38 megapixels total, full HD (native 1080p/60)
- 20x optical zoom with horizontal field of view from 60° (wide end) to 3.3° (tele end)
- Low-power laser pointer for centering
- Superior low-light performance (0.4 Lux)
- Web interface for remote administration and operation, integration-ready Telnet and serial RS-232 control, presenter-friendly IR remote control
- Use with a OneLINK device for power, video, and control:
 - OneLINK HDMI – uncompressed HDMI video, bidirectional RS-232 connectivity for camera control via third-party equipment, passes IP stream from the camera
 - OneLINK Bridge – OneLINK HDMI capabilities plus uncompressed USB 3.0 streaming, HD-SDI output, and audio routed up to the camera and injected into the IP stream

Camera assembly numbers 998-9968-001 and 998-9968-100:

Class 1 Laser Product (IEC 60825-1:2014)

Produit Laser de la Classe 1 (IEC 60825-1:2014)

Klass 1 Laserprodukt (IEC 60825-1:2014)

Camera assembly number 998-9968-000 only:

This product contains a Class 3 laser.

Unpacking the Camera

Note

This camera is shipped with a mounting kit for use in suspended acoustic tile ceilings. If you plan to mount the camera in a hard ceiling (such as gypsum board), you will need mounting kit 998-2225-152.

Make sure you receive all the items you expected.

DocCAM 20 HDBT, camera only

999-9968-000 – worldwide

Note

No power option is provided with this kit. The PoE+ mid-span power injector part numbers 451-0800-055 (North America) and 451-0800-155 (Europe and UK) are compatible with this camera. OneLINK devices are also compatible, and provide more flexibility in installation.

- DocCAM 20 HDBT camera
- Trim ring with mounting screws
- Tile support brace
- IR remote

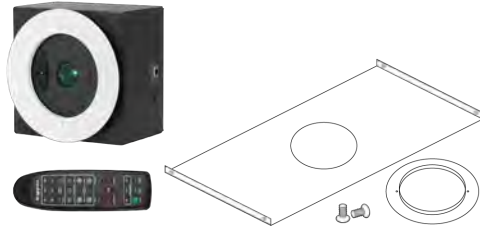

DocCAM 20 HDBT with OneLINK HDMI

999-9968-200 – North America

999-9968-201 – Europe/UK

- DocCAM 20 HDBT camera
- OneLINK HDMI Receiver kit – includes receiver, 48 VDC power supply and AC cord set(s)
- Trim ring with mounting screws
- Tile support brace
- IR remote



DocCAM 20 HDBT with OneLINK Bridge

999-9968-300 – North America

999-9968-301 – Europe/UK

- DocCAM 20 HDBT camera
- OneLINK Bridge AV Interface kit – includes AV interface, 48 VDC power supply and AC cord set for North America
- 3-position Phoenix-type connectors (qty. 4)
- USB 3.0 cable, type A to type B, 6 ft (1.8 m)
- Trim ring with mounting screws
- Tile support brace
- IR remote



A Quick Look at the Camera

The DocCAM 20 HDBT ceiling-mounted document camera is designed for recessed mounting. The features of interest during installation are not visible after the installation is complete.

Camera assembly numbers 998-9968-001 and 998-9968-100:

Class 1 Laser Product (IEC 60825-1:2014)

Produit Laser de la Classe 1 (IEC 60825-1:2014)

Klass 1 Laserprodukt (IEC 60825-1:2014)

Camera assembly numbers 998-9968-001 and 998-9968-100:

Note

This product contains a Class 1, 650 nm red laser pointer.

Cet appareil contient un pointeur laser de la Classe 1, à lumière rouge de 650 nm.

Camera assembly number 998-9968-000 only:

Caution

This product contains a Class 3 (5 mw) 650 nm red laser which produces visible laser radiation. Avoid direct eye exposure. Do not look at the laser aperture during camera operation.

All DocCAM 20 HDBT part numbers:

Caution | Avertissement

Laser light – Avoid direct eye exposure. Do not look at the laser aperture during camera operation.

Lumière de laser – Ne regardez pas directement dans le faisceau laser. Ne regardez pas directement dans l'ouverture laser lorsque la caméra est en marche.

Caution | Avertissement

Use of controls or adjustments or performance of procedures other than those specified herein may result in hazardous laser radiation exposure.

L'utilisation de commandes, réglages ou instructions autres que ceux spécifiés présente un risque d'exposition dangereuse aux radiations laser.

Features of Interest During Installation

- **Camera enclosure** – 8 x 8 x 5.1 inches (20.3 x 20.3 x 12.9 cm).
- **Bezel ring** – Extends 0.5 inch from the front face of the camera enclosure; includes threaded holes to attach the trim ring.
- **OneLINK/HDBaseT connector** – For power and all connectivity. When installed, the connector side points in the direction that the top of the document or other camera subject will face.
- **Fasteners for conduit box** – For installations that require all cabling to be routed through conduit. The conduit box is not supplied with this product.

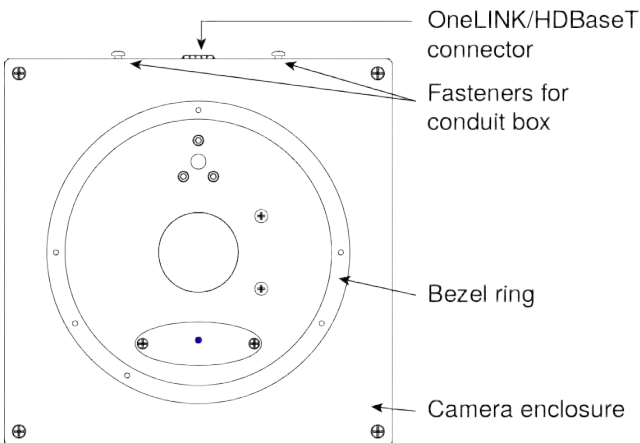

Connector Panel

The DocCAM 20 HDBT has one connector, the OneLINK/HDBaseT connector. When installed, the connector points in the direction of the top of the document or other camera subject – usually toward the audience.

The camera has no physical switches. Hardware configuration is via the web interface.

This is it: The Art of Easy.

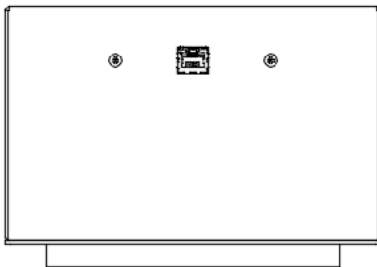

Features of Interest During Operation

In a typical installation, only the items inside the bezel ring are visible.

- **Camera lens** – 20x optical zoom lens for crisp detail.
- **Laser pointer** – Shows where the camera image is centered. Use the remote to turn on the laser pointer.

Caution | Avertissement

Laser light – Avoid direct eye exposure. Do not look at the laser aperture during camera operation.

Lumière de laser – Ne regardez pas directement dans le faisceau laser. Ne regardez pas directement dans l'ouverture laser lorsque la caméra est en marche.

- **IR window** – Sensors in the camera face receive signals from the remote. Point the remote toward the camera; precision is not necessary.
- **Status light** – The multicolored LED indicates the camera's current state.

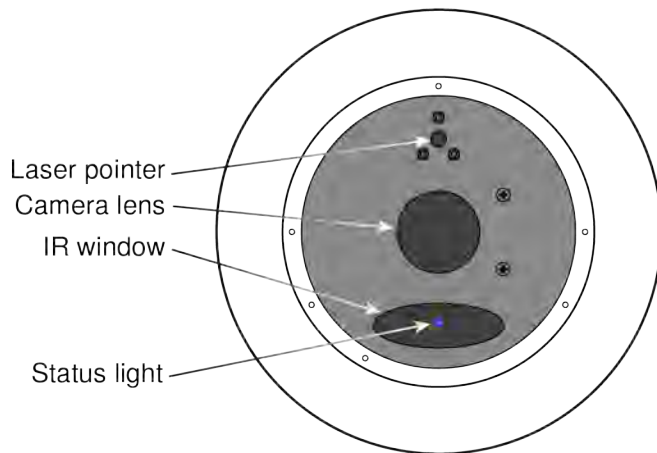

Caution | Avertissement

Laser controls are available to remote operators using the web interface. Keep your eyes out of the beam path.

Les commandes laser sont disponibles aux opérateurs à distance utilisant l'interface Web. Gardez les yeux hors du trajet du faisceau.

Installing the Camera

This section covers:

- Connections and pre-installation functional check
- Selecting the location for the camera
- Preparing the ceiling
- Installing the camera

Don't Void Your Warranty!

Caution

This product is for indoor use. Do not install it outdoors or in a humid environment without the appropriate protective enclosure. Do not allow it to come into contact with any liquid.

Do not install or operate this product if it has been dropped, damaged, or exposed to liquids. If any of these things happen, return it to Vaddio for safety and functional testing.

Use the power supply, power injector, or camera extension device included with or recommended for use with this product. For products with power supplies, using the wrong power supply will void the warranty, and could create unsafe operating conditions or damage the product. Note that power supplies for different products may look nearly identical – always check the label for the output voltage.

Cabling Notes

Use Cat-5e or better cable and standard RJ-45 connectors (568B termination). We recommend using high-quality connectors and a high-quality crimping tool.

Caution

Check Cat-5 cables for continuity before using them. Using the wrong pin-out may damage the camera system and void the warranty.

Note

Use standard RJ-45 connectors and a good crimping tool. Do not use pass-through RJ-45 connectors. Poorly terminated cables can damage the connectors on the product, cause intermittent connections, and degrade signal quality. Test cable pin-outs and continuity before connecting them.



Intact – will make reliable contact with cable connector



Damaged – Bent contact fingers will NOT make reliable contact with cable connector



Pro Tip

To prevent tragic mishaps, label both ends of every cable.

Pre-Installation Functional Check

Before you install the camera, verify that it powers up and sends video. Referring to the basic connection diagrams, connect the camera and verify that video is available on the connected display.

When you have verified that the camera operates properly, disconnect it and continue with the installation.

Camera assembly numbers 998-9968-001 and 998-9968-100:

Note

This product contains a Class 1, 650 nm red laser pointer.

Cet appareil contient un pointeur laser de la Classe 1, à lumière rouge de 650 nm.

Camera assembly number 998-9968-000 only:

This product contains a Class 3 laser.

All DocCAM 20 HDBT part numbers:

Caution | Avertissement

Laser light – Avoid direct eye exposure. Do not look at the laser aperture during camera operation.

Lumière de laser – Ne regardez pas directement dans le faisceau laser. Ne regardez pas directement dans l'ouverture laser lorsque la caméra est en marche.

Caution | Avertissement

Use of controls or adjustments or performance of procedures other than those specified herein may result in hazardous laser radiation exposure.

L'utilisation de commandes, réglages ou instructions autres que ceux spécifiés présente un risque d'exposition dangereuse aux radiations laser.

Basic Connection Diagram

The diagram below shows basic connections with a OneLINK Bridge AV Interface providing camera power, control, and video from the camera to other devices.

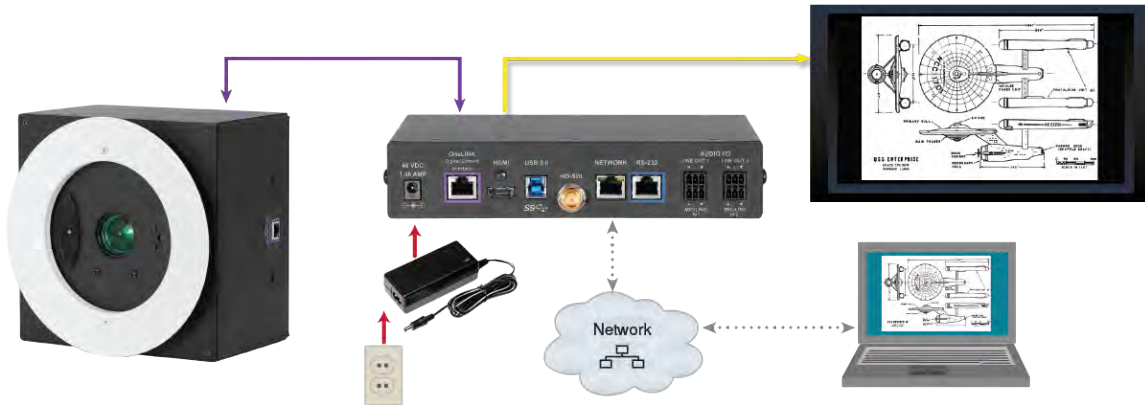

Note

The OneLINK device is recommended but not required; the camera can be connected directly to a third-party device with a PoE+ power injector (not provided). PoE+ mid-span power injector part numbers 451-0800-055 (North America) and 451-0800-155 (Europe and UK) are compatible with this camera.

Options for Power and Other Connections

Connect the camera to a OneLINK HDMI or a OneLINK Bridge AV Interface – a single Cat-5e (or better) cable provides power to the camera, along with HDBaseT network and video connectivity. Network, video output, and RS-232 control are connected at the OneLINK device. The OneLINK Bridge also provides audio connections.

Use a PoE+ power injector – Connect to a third-party control device through a PoE+ power injector (not provided). Power injector part numbers 451-0800-055 (North America) and 451-0800-155 (Europe and UK) are compatible with this camera.

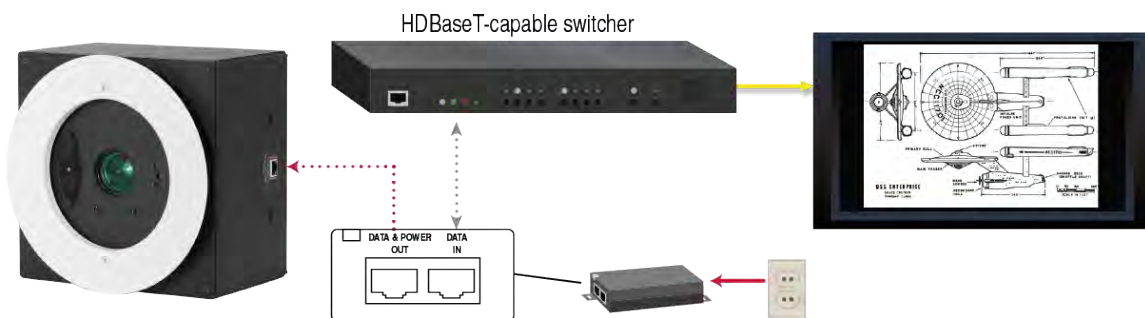

About Installation Height and Viewing Area

The camera may be installed in a ceiling up to 30 ft (9.1 m) high, depending on the desired viewing area.

When installed in a 9 ft (2.75 m) ceiling, such as a small classroom:

- Minimum viewing area is smaller than a business card
- Maximum viewing area is nearly 7 ft x 4 ft (over 2 m x 1 m)

When installed in a 30 ft (9.1 m) ceiling, such as a large lecture hall:

- Minimum viewing area is smaller than a sheet of letter-size or A4 paper
- Maximum viewing area is over 30 ft x 17 ft (over 9 x 5 m)

The Image Size Calculator on our website can help you to determine the minimum and maximum viewing areas with more precision.

Selecting the Installation Area

The DocCAM 20 HDBT can be installed in a suspended acoustic tile ceiling or in a wood or drywall ceiling. Total installed weight is roughly 5.1 lbs (2.3 kg).

Note

All above-ceiling work must conform to local building codes and should be performed by qualified personnel.

1. Use the plumb line to determine the ideal camera location, centered above the surface where documents or other objects will be placed, and mark the desired center.
2. Determine the exact alignment of the camera with respect to the intended subject.

Note

The image cannot be rotated. If installing in a hard ceiling, the camera cannot be rotated after installation.

3. Verify that the area above the ceiling where the camera is to be installed is clear of obstructions and provides enough room for the camera enclosure:
 - 8 inch by 8 inch (20.3 cm x 20.3 cm) footprint, aligned to the work surface where the camera's subject is placed
 - Minimum 5.6 inches of clear space above the opening to maneuver the camera into place

Things You Will Need for the Installation

Before you start, be sure you have what you need:

- Access to the area above the ceiling
- Plumb line
- Pencil
- Appropriate tools for cutting a hole in the ceiling
- #2 Phillips screwdriver
- Conduit box, if required
- Mounting kit 998-2225-152, if installing in a gypsum board (drywall) or other non-suspended ceiling

Installing the Power Source

You can connect the camera to the IP network using a mid-span power injector, or you can connect it to a OneLINK device. If you use a OneLINK device, it may be installed up to 328 ft (100 m) from the camera.

Note

If you purchase only the camera, no power source is included with the camera.

1. Install the power injector or OneLINK device before installing the camera enclosure.
2. Route the camera cable from the power injector or OneLINK device to the camera enclosure location.

Installing the Camera in a Suspended Tile Ceiling

The camera is shipped with the ceiling mount for this type of installation.

The camera is mounted from above the ceiling, through a round hole, with only the bezel and the features inside it accessible from below. The camera rests on a support plate that distributes its weight across the ceiling tile; the support plate may also be suspended. A trim ring conceals the camera bezel and the adjacent portion of the ceiling tile.

Preparing the Tile Ceiling

Note

All above-ceiling work must conform to local building codes and should be performed by qualified personnel.

1. Remove the ceiling tile where the camera will be mounted.
2. Trace a 6.25 in. (15.9 cm) circle for the camera opening on the front side of the tile. You can use the tile support brace as a template.
3. Cut the camera opening.
4. Ensure that the camera's bezel ring fits into the opening. The bezel ring stands out 0.5 in (12.7 mm) from the camera face.
5. Place the tile back in the ceiling grid.
6. Place the tile support brace above the tile, aligning it to the hole in the tile.
7. Secure the tile support brace to the building structure using appropriate hardware such as Chief's "Speed Connect Hardware Kit," part number CMSHDW. The ends have holes to accommodate support wires.

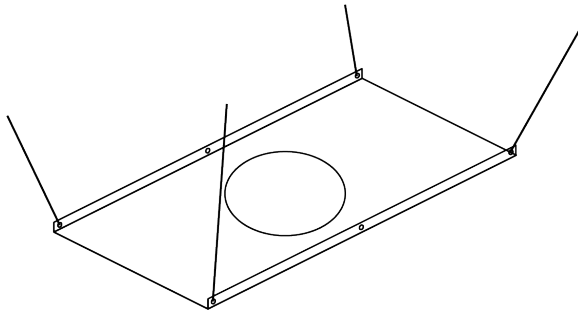

Completing the Installation in a Tile Ceiling

1. Connect the camera cable to the camera, routing it through a conduit box if required.
2. If using conduit, attach the conduit box to the camera enclosure using the threaded inserts on either side of the cable connector.
3. Seat the camera in place, with the bezel ring in the opening.
4. Rotate the camera so that the cable connector is facing the same direction as the top of the document or other photographic subject.
5. Secure the trim ring to the camera bezel ring using the screws provided with it.

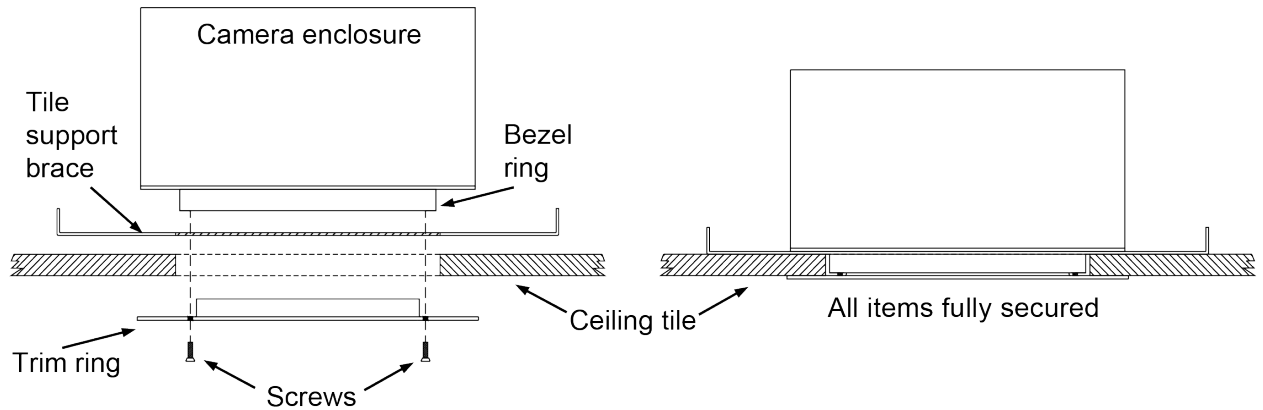

6. Connect the camera cable to the OneLINK device or customer-provided PoE+ power injector.

Note

After the camera is powered on, check the image and rotate the camera as needed to align it.

Installing the Camera in a Hard Ceiling

You will need mounting kit 998-2225-152 to install the camera in a gypsum board (drywall) or wood ceiling. *This mounting kit is not included with the camera.*

The camera is raised into place through a square hole in the ceiling, and attached from below using two mounting plates. A large trim ring conceals the portion of the camera enclosure outside the bezel and the camera mounting plates.

Preparing the Hard Ceiling

Follow these steps to mount the camera in a gypsum board or other non-suspended ceiling using Hard Ceiling Mounting Kit 998-2225-152.

Note

All above-ceiling work must conform to local building codes and should be performed by qualified personnel.

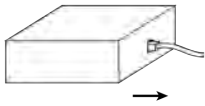

1. Determine the exact alignment of the camera with respect to the subject. The camera face with the connector must point in the same direction as the top of the document or other camera subject.

Note

The image cannot be rotated. Ensure that the camera opening is aligned precisely.



2. Trace a square, 8.125 x 8.125 inch (20.7 x 20.7 cm), for the camera opening.
3. Cut the camera opening.

Completing the Installation in a Hard Ceiling

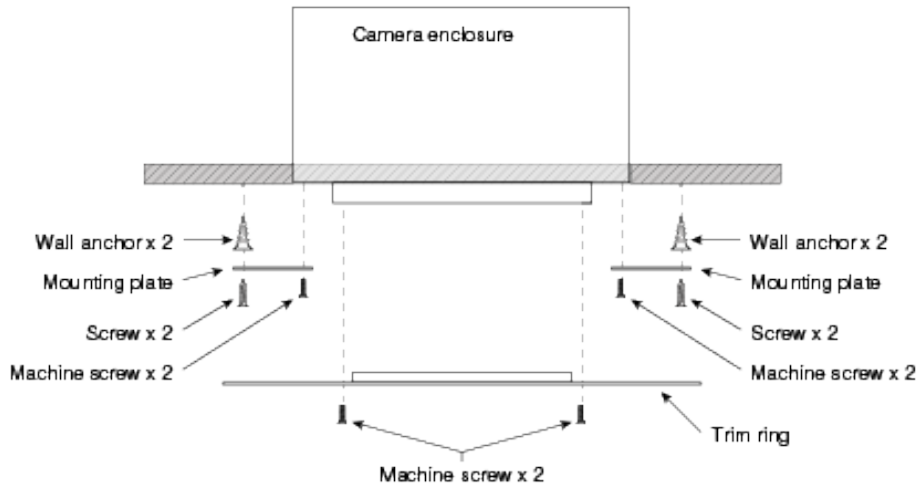

1. Attach the mounting plates to the camera with the black machine screws.
2. Lift the camera into place and mark the locations to drill into the ceiling.
3. Drill the holes and install the screw anchors.
4. Connect the camera cable to the camera, routing it through a conduit box if required.
5. Lift the camera into place and secure it with the 1 1/4 in. screws.
6. Attach the trim ring to the camera's bezel ring with the white machine screws.
7. Connect the camera cable to the OneLINK device or customer-provided PoE+ power injector.



Powering Up the Camera

Connect power to the OneLINK device or PoE+ power injector that supplies power and connectivity to the camera.

Note

Wait until the camera finishes initializing before trying to operate or control it.

The camera will take a few seconds to initialize. When the camera is ready, its status light is blue. At this point, video is available and the camera is ready to accept control information.

Camera assembly numbers 998-9968-001 and 998-9968-100:

Note

This product contains a Class 1, 650 nm red laser pointer.

Cet appareil contient un pointeur laser de la Classe 1, à lumière rouge de 650 nm.

Camera assembly number 998-9968-000 only:

Caution

This product contains a Class 3 (5 mw) 650 nm red laser which produces visible laser radiation. Avoid direct eye exposure. Do not look at the laser aperture during camera operation.

All DocCAM 20 HDBT part numbers:

Caution | Avertissement

Laser light – Avoid direct eye exposure. Do not look at the laser aperture during camera operation.

Lumière de laser – Ne regardez pas directement dans le faisceau laser. Ne regardez pas directement dans l'ouverture laser lorsque la caméra est en marche.

Caution | Avertissement

Use of controls or adjustments or performance of procedures other than those specified herein may result in hazardous laser radiation exposure.

L'utilisation de commandes, réglages ou instructions autres que ceux spécifiés présente un risque d'exposition dangereuse aux radiations laser.

Caution | Avertissement

Laser controls are available to remote operators using the web interface. Keep your eyes out of the beam path.

Les commandes laser sont disponibles aux opérateurs à distance utilisant l'interface Web. Gardez les yeux hors du trajet du faisceau.

Status Light

The light in the camera's face indicates its current state.

Note

By default, the camera's status light is active during normal operation; however, it can be configured to remain off when the camera is powered up. The camera may be sending video even if the indicator light is off.

- **Blue:** Normal operation (blinks off momentarily when the camera receives a command from the remote)
- **Purple:** In standby mode or booting
- **Yellow:** Firmware update in progress – overrides status light configuration

Camera assembly numbers 998-9968-001 and 998-9968-100:

Note

This product contains a Class 1, 650 nm red laser pointer.

Cet appareil contient un pointeur laser de la Classe 1, à lumière rouge de 650 nm.

Camera assembly number 998-9968-000 only:

Caution

This product contains a Class 3 (5 mw) 650 nm red laser which produces visible laser radiation. Avoid direct eye exposure. Do not look at the laser aperture during camera operation.

All DocCAM 20 HDBT part numbers:

Caution | Avertissement

Laser light – Avoid direct eye exposure. Do not look at the laser aperture during camera operation.

Lumière de laser – Ne regardez pas directement dans le faisceau laser. Ne regardez pas directement dans l'ouverture laser lorsque la caméra est en marche.

Using the IR Remote

The IR remote provides basic camera control for end users.

IR Remote Cheat Sheet

What do you need to do?	Button(s)
Power on or standby	Power (green button at top right)
Select the camera to control (if this remote controls more than one)	Camera Select buttons 1 through 3 (second row of buttons)
Discover the camera's IP address	Data Screen button (top left) – press and hold for 3 seconds.
Center the camera's subject	Laser buttons – The laser pointer is aligned at the factory to point slightly above the center of the camera's subject.
Move the camera to a zoom preset	Position Preset buttons 1 through 6 (bottom two rows)
Focus the camera	Auto Focus button (near arrow buttons) Manual Focus buttons Near and Far (below Zoom Speed buttons)
Control zoom speed	Zoom Speed buttons - Slow T and W , Fast T and W for telephoto and wide-angle modes (light gray)
Adjust for excess light behind the camera's subject	Back Light button (top center)

IR Remote Details

The Vaddio remote provides the following functions:

Power – Switch the selected camera on or off.

Power indicator – Lights momentarily when you press a button.

Back Light – Use or turn off Back Light Compensation.

Data Screen – Display the camera's IP address and MAC address. Press this button again to dismiss the display.

Camera Select – In multi-camera installations, selects the camera to be controlled. See [Camera Settings](#) for information on configuring the camera as camera 1, 2, or 3.

Home button – Returns the camera to its home zoom level.

Laser On – Toggles the laser pointer on and off.

Laser MOM – Turns on the laser pointer momentarily, and forbids it to go out with its friends if it doesn't turn off again after 5 seconds.

Camera assembly numbers 998-9968-001 and 998-9968-100:

Note

This product contains a Class 1, 650 nm red laser pointer.

Cet appareil contient un pointeur laser de la Classe 1, à lumière rouge de 650 nm.

Caution | Avertissement

Laser light – Avoid direct eye exposure. Do not look at the laser aperture during camera operation.

Lumière de laser – Ne regardez pas directement dans le faisceau laser. Ne regardez pas directement dans l'ouverture laser lorsque la caméra est en marche.

Auto Focus – Switch the camera to Auto-Focus mode.

Zoom Speed – Select Slow or Fast movements for telephoto and wide-angle shots.

- **T** (slow and fast) – Telephoto
- **W** (slow and fast) – Wide-angle

Manual Focus – Switch the camera to Manual Focus mode.

Near (-) adjustment – Moves the focus nearer when in manual focus mode.

Far (+) adjustment – Moves the focus farther when in manual focus mode.

Preset – Save the camera's current zoom level as one of the numbered presets.

Reset – Clear a saved preset.

Position Presets 1 through 6 – Move the camera to a predefined zoom level, or specify the preset to save or clear.

Storing a Preset Using the Remote

Zoom to the desired level. Then hold down the Preset button and press one of the numbered preset buttons.

Clearing a Preset Using the Remote

Press and hold the Reset button while pressing the preset number you want to clear.



Web Interface

The camera's web interface allows control via a network connection, using a browser. Password-protected pages provide administrative access to tasks such as setting passwords, changing the IP address, viewing diagnostics, and installing firmware updates. The user login (or guest access, if it is enabled) provides access to camera controls similar to those available from the IR remote.

You will need to know the camera's IP address to use the web interface. If the LAN has a DHCP server, the camera will get its IP address, gateway and routing information automatically and you will be able to browse to it. If not, you will need to configure the camera to use a static IP address.

Getting the Camera's IP Address

You will need to be able to view the camera's video output on an HDMI display.

1. Press the Data Screen button on the remote. The room display presents the camera's IP address and MAC address.
2. Press the Data Screen button again to dismiss the information.

If the address is 169.254.1.1, the camera is using its default IP address and you will need to configure it for your network. You can configure the camera's static IP address either through the network or from a computer connected directly to its Ethernet port. You may need a crossover cable.

Note

For static addressing, work with your IT department to determine the correct IP address, subnet mask, and gateway information.

Accessing the Web Interface

Enter the IP address or hostname in your browser's address bar. If you use the hostname, you may need to enter `http://` or `https://` as a prefix to keep the browser from treating it as a search query.

Browser Support

We have tested this product with these web browsers:

- Chrome®
- Microsoft® Internet Explorer®
- Safari®
- Firefox®

We test using the browser version available from the vendor at that time. Older versions of these browsers are likely to work, and other browsers may also work.

Administrative Access

If you are on the Controls screen and no other screens are available, you're logged in at the user level, or guest access is enabled and you're not logged on at all. Use the Admin button to open the login screen.

When you log in as Admin, all the admin menu buttons appear on the left side of the screen. In addition to Camera Controls, you also have access to:

- Camera Settings – Additional control over camera behavior related to camera movement and color management.
- Streaming – Set up IP (H.264) streaming.
- Room Labels – Add helpful information the web interface screens, such as conference room name and the in-house number for AV assistance.
- Networking – Ethernet configuration.
- Security – Set passwords and manage guest access.
- Diagnostics – Access to logs for troubleshooting.
- System – Reboot, restore defaults, view switch settings, and run updates.
- Help – Tech support contact information.

Compact Menu View

By default, the navigation buttons in the administrative interface display an icon and a text label. You can also select the compact view of the menu buttons along with the standard view. The button at the bottom of the menu toggles between the two views.

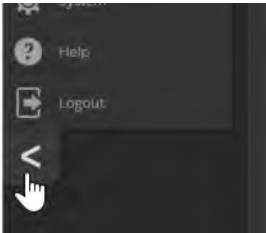

Web Interface Cheat Sheet

Where to find the camera controls you need right now.

What do you need?	Go to this screen
Camera operation <ul style="list-style-type: none"> ■ Stop sending video (video mute) ■ Enter or exit standby mode 	(any page)
Camera operation <ul style="list-style-type: none"> ■ Zoom the camera ■ Set the speed for zoom motions ■ Focus the camera (Focus button reveals the focus control) ■ Zoom to a camera preset 	Camera
Camera behavior <ul style="list-style-type: none"> ■ Set or clear presets ■ Select the appropriate lighting adjustments (CCU Scenes section) 	Camera
Camera behavior <ul style="list-style-type: none"> ■ Define custom lighting adjustments (CCU scenes) ■ Specify whether to use automated adjustments (auto-iris, auto white balance, backlight compensation) 	Camera
Camera adjustments <ul style="list-style-type: none"> ■ Color settings (Iris, iris gain, red gain, blue gain, detail, chroma, gamma) ■ Store and label custom color settings as CCU scenes 	Camera
Access management <ul style="list-style-type: none"> ■ Guest access ■ Account passwords ■ Idle session time-out 	Security
IP streaming settings <ul style="list-style-type: none"> ■ Quality ■ Resolution ■ Frame rate ■ Streaming URL and path 	Streaming
IP settings <ul style="list-style-type: none"> ■ Hostname ■ DHCP or static addressing ■ Static: IP address, subnet mask, gateway 	Networking
Access to the camera's soft DIP switch settings	System
Time zone and NTP server (source for system time/date)	Networking
Diagnostic logs	Diagnostics
Information about the camera location	Room Labels
Helpdesk phone number for end users	Room Labels
Vaddio Technical Support contact information	Help

System Administration

Administrative tasks are on these pages of the web interface:

- Networking – Ethernet configuration.
- Security – Passwords, guest access, other IT security-related settings
- Room Labels – Helpful information to display in the web interface.
- System – Controls to reboot, reset to factory defaults, and run firmware updates, access to soft DIP switches.
- Help – Contact information for Vaddio Technical Support and a link to the documentation for this product.
- Diagnostics – Logs to help Vaddio Technical Support troubleshoot issues.

Configuring Network Settings

NETWORKING PAGE

Editable network settings include:

- The camera's hostname
- Choice of static IP addressing or DHCP addressing
- IP address, subnet mask, and gateway, if static IP addressing is used

If your network supports hostname resolution, you may find it convenient to change the camera's hostname.

DHCP is the default setting, but the camera will use the default address of 169.254.1.1 if no DHCP server is available.

You will only be able to enter the IP address, subnet mask, and gateway if you set IP Address to Static.

Caution

Consult your IT department before changing any network settings. Errors in network configuration can make the camera and its IP stream inaccessible from the network. Do not change DHCP/Static addressing, IP address, subnet mask, or gateway unless you are very familiar with the characteristics and configuration of the network where you install the camera.

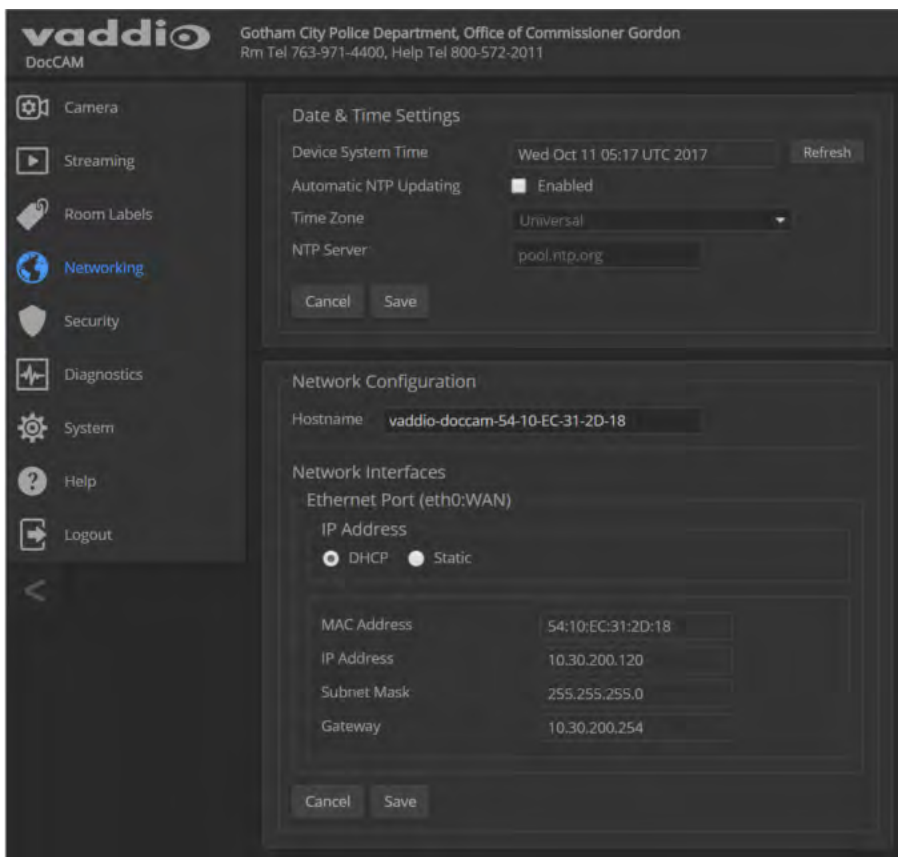

Specifying Time Zone and NTP Server

NETWORKING PAGE

Using automatic NTP updating ensures that the timestamps in the camera's diagnostic log are accurate. Specifying your time zone may make it easier to match logged events with other actions and external events.

1. To make the time zone and NTP server editable, enable Automatic NTP Updating.
2. Select the desired time zone from the list.
3. If desired, specify the NTP server to use. Otherwise, use the default.

You may need to refresh the system time display.

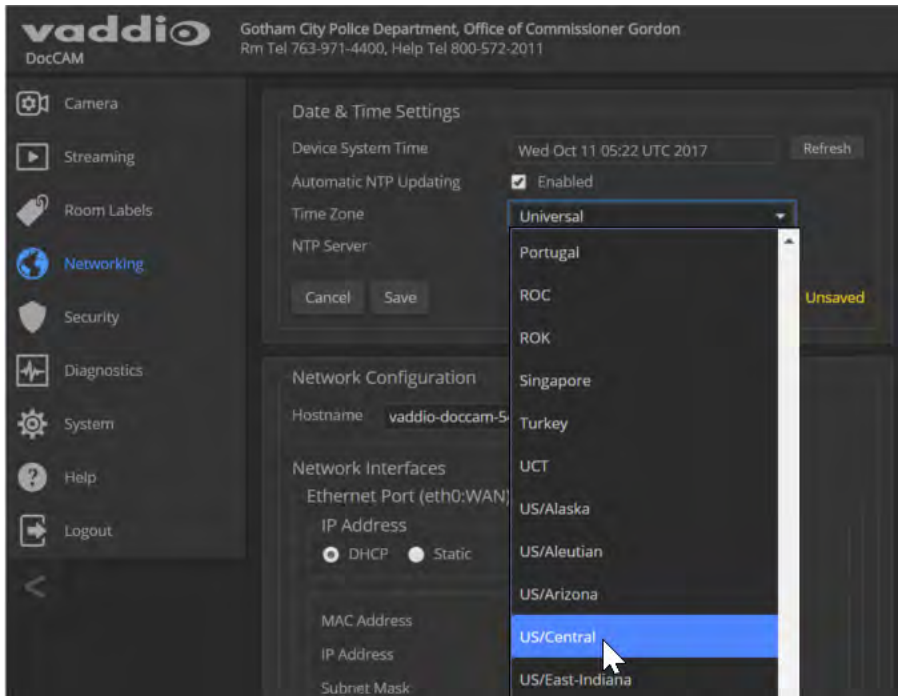

Managing Access and Passwords

SECURITY PAGE

Things you can do on this page:

- Allow people to access the Camera screen without logging on (Allow Guest Access)
- Set whether inactive sessions log off automatically or not (Automatically Expire Idle Sessions)
- Change the password for the admin account
- Change the password for the user account
- Disable access via Telnet (by default, access via Telnet is enabled)

Some of these capabilities may be absent if the camera has not been updated with recent firmware.

Note

For best security, Vaddio strongly recommends changing the user and admin passwords from the default. Using the default passwords leaves the product vulnerable to tampering.

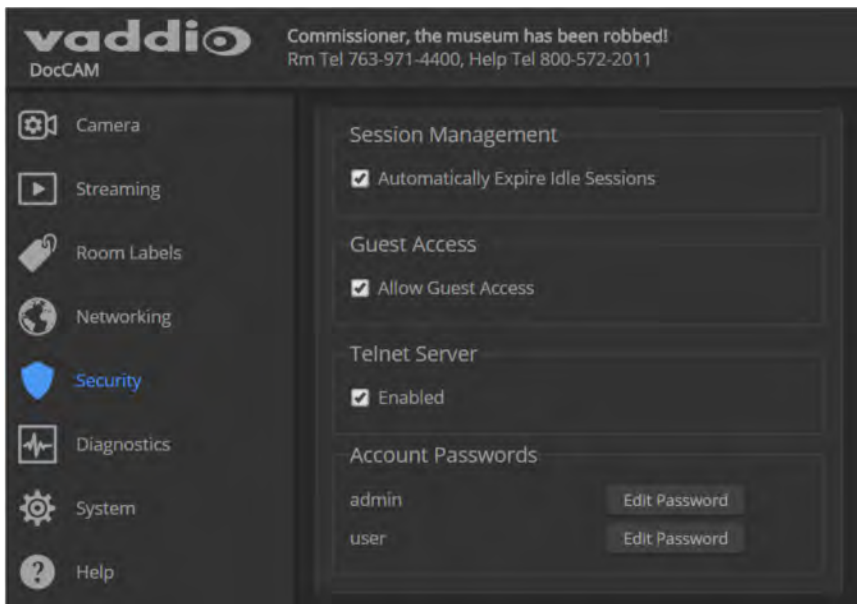

Adding Room Information to the Web Interface

ROOM LABELS PAGE

The information you enter on this page is displayed on every page of the web interface.

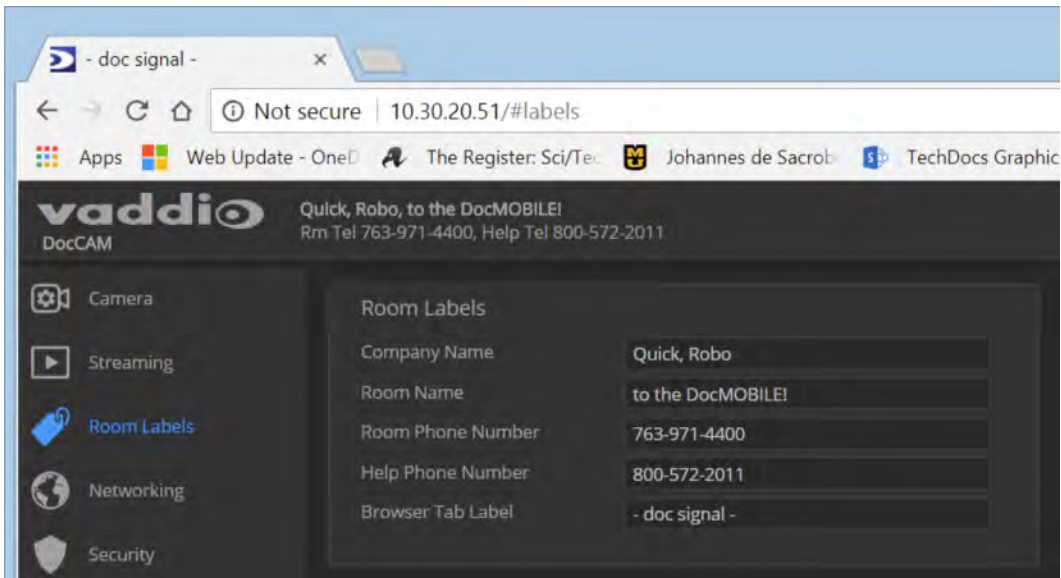

Rebooting the Camera

SYSTEM PAGE, FIRMWARE TAB

This can help if the camera stops responding as you expect.

In the System Utilities section, select Reboot.

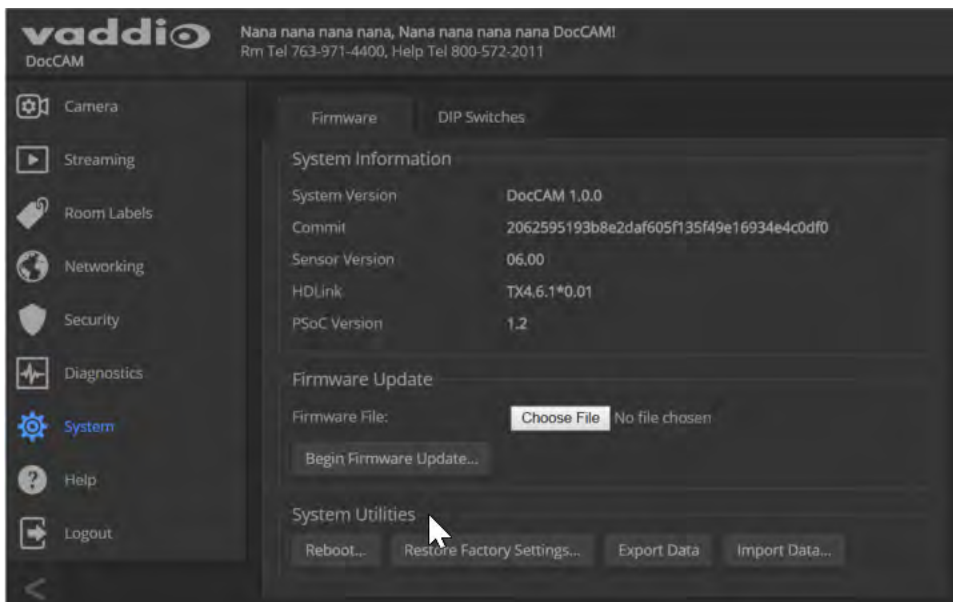

Saving (Exporting) or Restoring (Importing) a Configuration

SYSTEM PAGE, FIRMWARE TAB

You can import a configuration to several cameras if you need to configure them the same way. Cameras must be of the same model, and must have a compatible firmware version installed.

Sensitive information such as hostname and passwords is not included in the configuration.

1. Configure the first camera.
2. Export its configuration (Export Data button). The export downloads to your computer as a `.dat` file. The filename is the camera's hostname.
3. Import the configuration to the other cameras (Import Data button in each camera's web interface).

Note

If the camera is using an older software version, it may be unable import a configuration that was exported from a camera using a different version of software.

Installing a Firmware Update

SYSTEM PAGE, FIRMWARE TAB

1. Locate and download the firmware and its release notes.
2. Select Choose File, then browse to the firmware that you downloaded and select it. The filename ends with .p7m.
3. Click Begin Firmware Update.
4. READ the information in the Confirm dialog box and be sure you understand it. It may seem boring, but it could save you some time and aggravation.
5. When you are ready to start the update, click Continue. A progress message box opens and the indicator light on the front of the camera turns yellow to show the firmware update is in progress. If the update process presents warnings or error messages, read them carefully.

The process may take a few minutes.

Caution

Ensure that the camera stays powered on and connected to the network during the update. Interrupting the update could make the camera unusable.

The camera reboots when the update is complete.

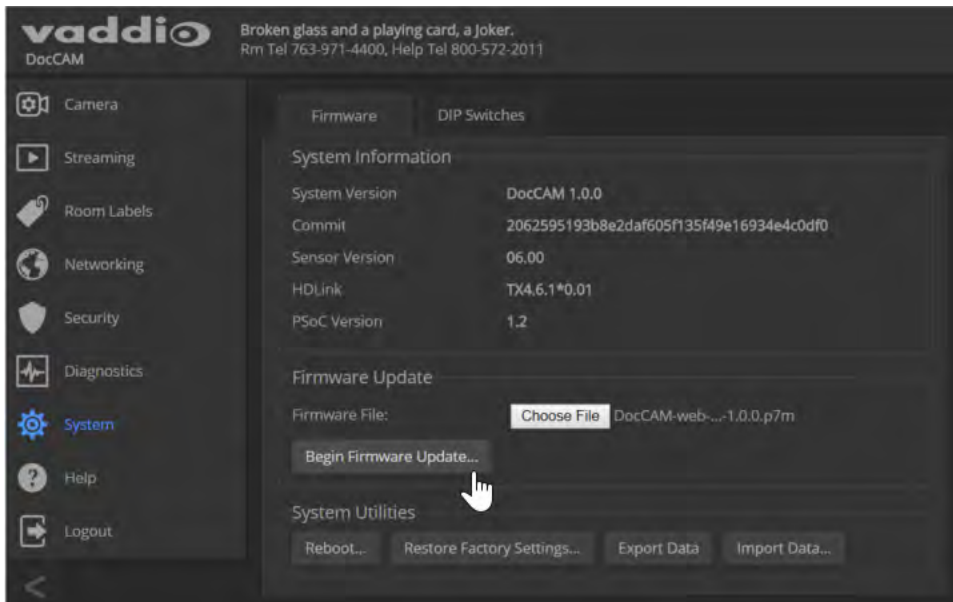

Contacting Vaddio Technical Support

HELP PAGE

If you can't resolve an issue using your troubleshooting skills (or the [Troubleshooting](#) table in this manual), we are here to help.

You'll find information for contacting Vaddio Technical Support on the Help page.

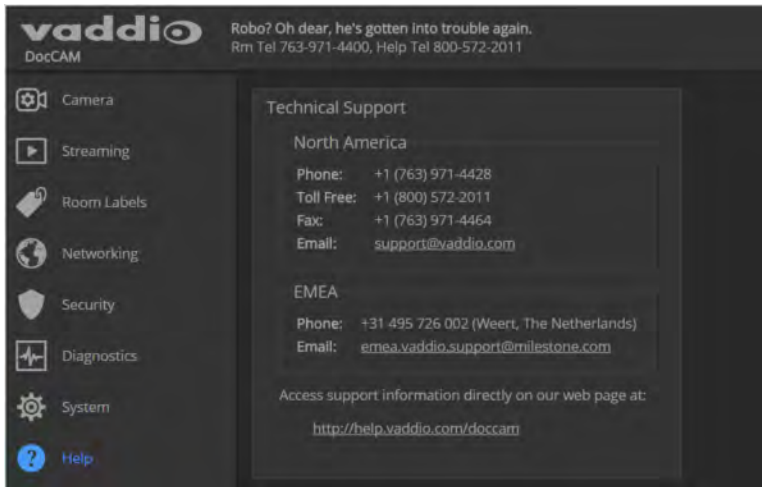

Accessing the Diagnostic Logs

DIAGNOSTICS PAGE

When you contact Vaddio technical support, your support representative may ask you to download and email the log file available from the Diagnostics page.

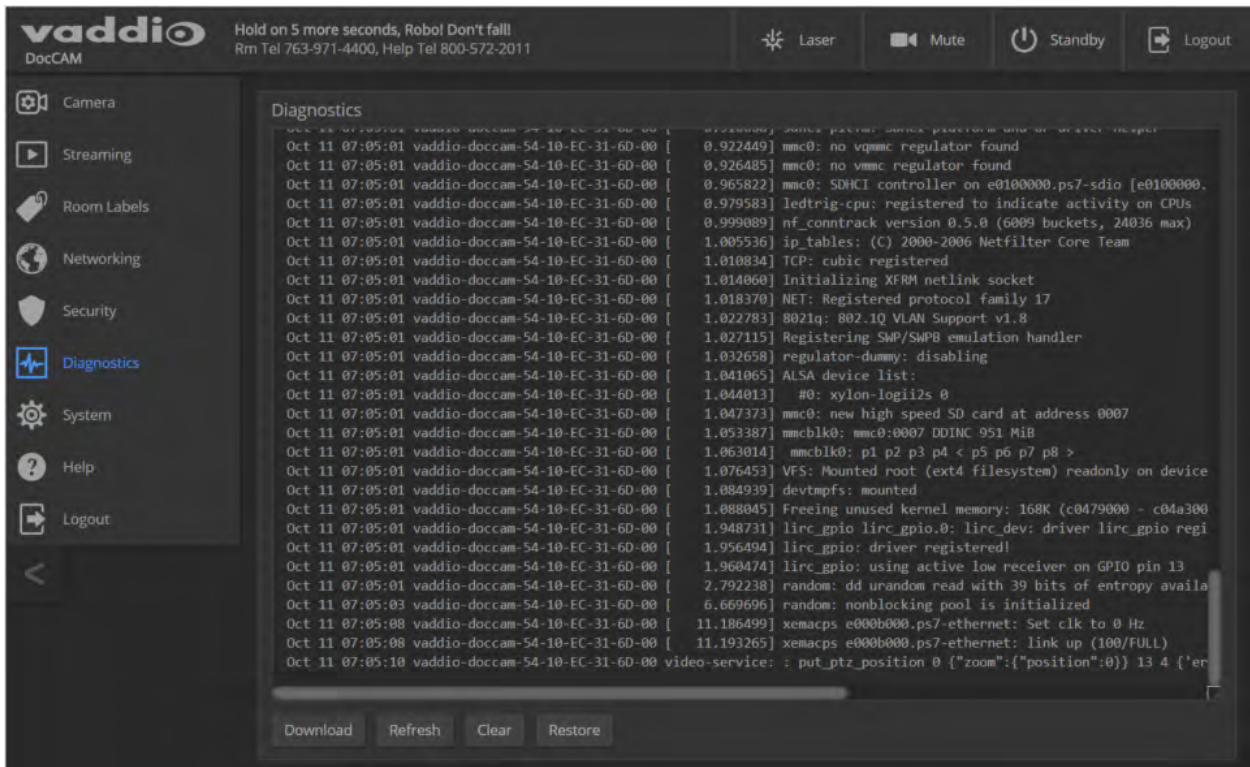

Configuring Camera Behavior

Basic camera configuration tasks are available on the Camera page:

- Storing the Home zoom level and other zoom presets
- Adjusting for the lighting in the room

Streaming settings are on the Streaming page. Other camera configuration tasks are on the DIP Switches tab of the System page. Settings include:

- Video resolution
- How the camera responds to the remote
- Enabling or disabling the laser pointer
- Status light behavior and color scheme
- Codec control mode (off/on)

Configuring IP Streaming

STREAMING PAGE

IP streaming is enabled by default. Use the Enable IP Streaming checkbox to change this.

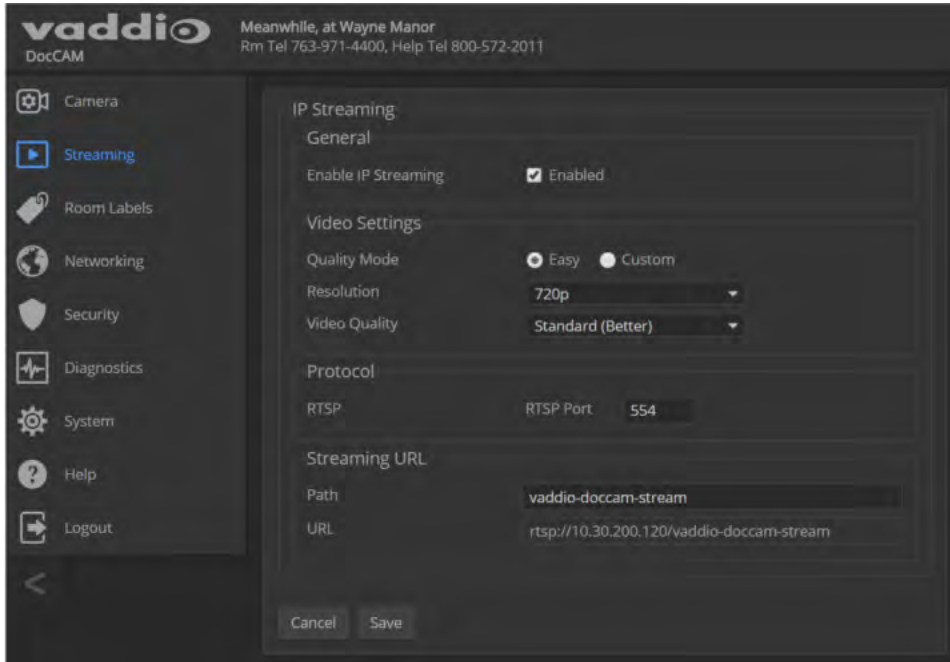

Editing IP Streaming Settings

STREAMING PAGE

Note

The IP streaming resolution cannot be higher than the value set with the video resolution switch on the back of the camera. (See [Video Resolution](#) for information on setting the switch.) If the selected value is out of range, the camera will automatically adjust the streaming resolution.

If you are not sure about these settings, start with the defaults.

1. Select the Quality Mode: Easy or Custom. Easy mode configures most settings automatically.
2. Select the desired IP streaming resolution.

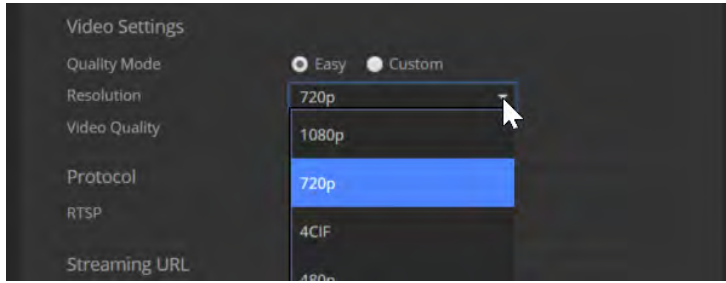

3. Easy quality mode only: Select Video Quality.

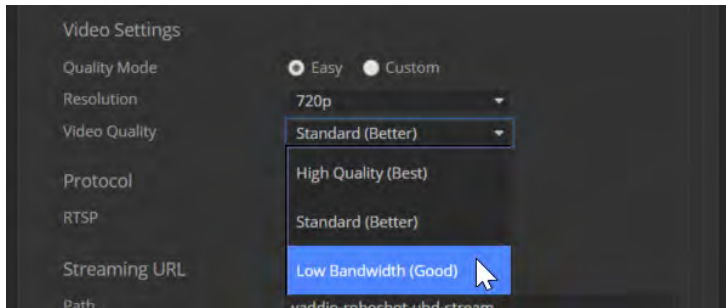

4. Custom quality mode only: Select the desired IP streaming frame rate.

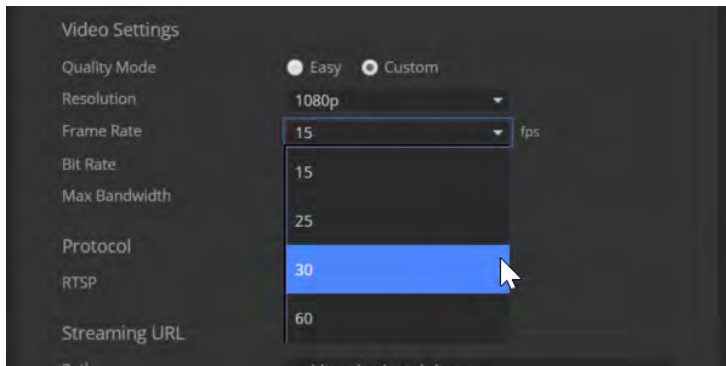

5. Custom quality mode only: Select Constant or Variable bit rate.

6. Custom quality mode, Constant bit rate only: Set Max Bandwidth.

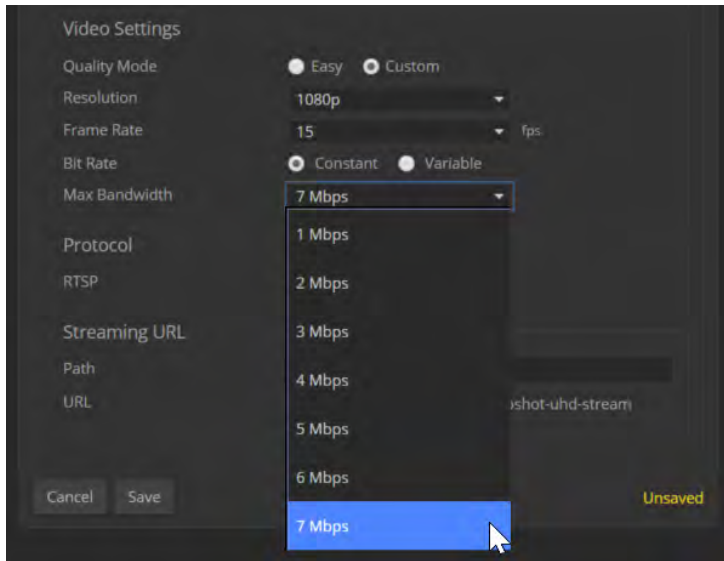

7. Custom quality mode, Variable bit rate only: Set the Quality (Quantization) slider.

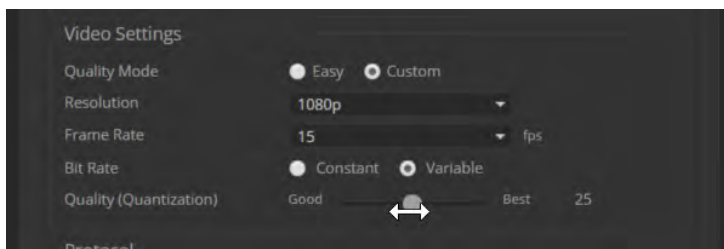

8. Save your changes.

Protocol and Streaming URL

STREAMING PAGE

The camera uses the RTSP protocol for H.264 streaming. Resolutions range from 1080p down to CIF; frame rates are 60/30/25/15.

RTSP port: Vaddio strongly recommends using the default RTSP port number.

Streaming URL: If necessary, edit the path name to change the portion of the streaming URL that appears after the IP address.

Adjusting for the Lighting in the Room

CAMERA PAGE

The camera's default settings include the Auto CCU scene, Auto Iris, and Auto White balance, to allow the camera to do most of the lighting adjustments on its own. Our technical experts (specifically Scott) have pre-loaded some additional adjustments for common lighting scenarios as factory-defined CCU scenes – Incandescent Hi, Incandescent Lo, Fluorescent Hi, Fluorescent Lo, and Outdoor.

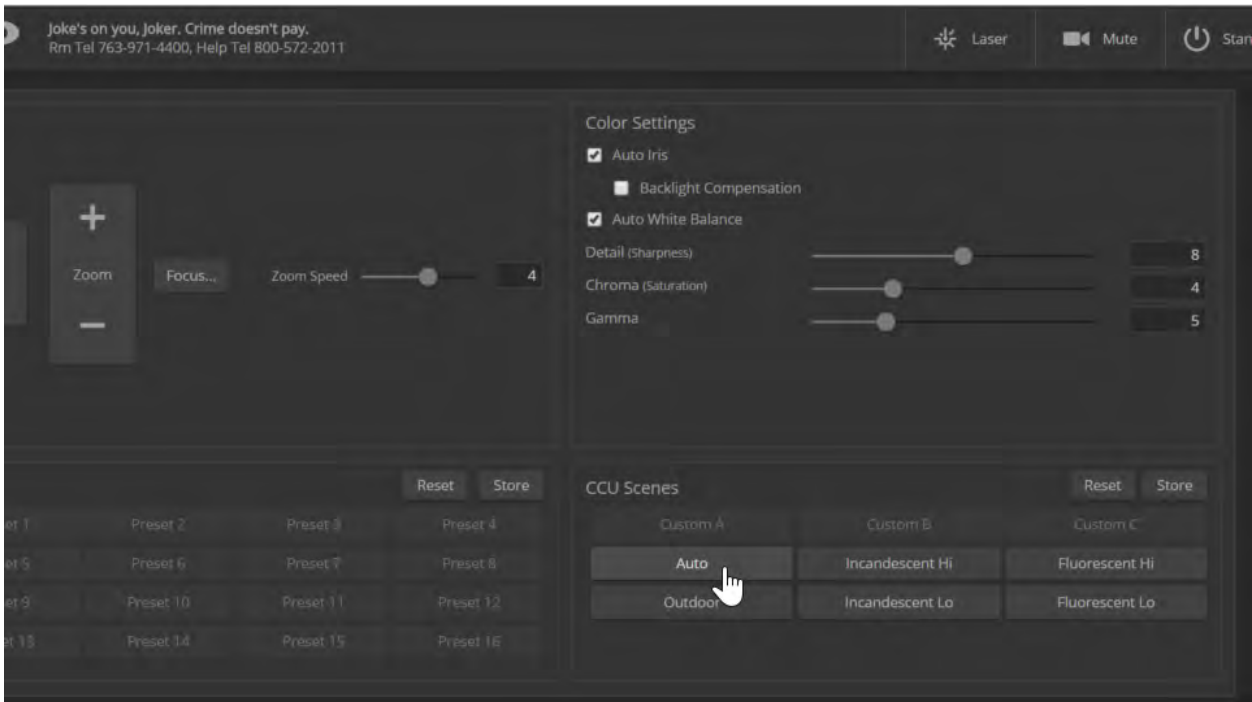

If the Auto settings don't yield the results you want, pick the CCU scene button with the label that best describes the lighting in the room. Then fine-tune the lighting and color adjustments as needed using the Color Settings:

- Auto Iris manages light level adjustments automatically. Clear this checkbox to adjust iris and gain manually.
- Auto White Balance manages color automatically. Clear this checkbox to adjust red gain and blue gain manually.
- If there is bright light behind the main subject of the shot, check the box for Back Light Compensation. This setting is only available if you are using Auto Iris.
- To adjust the intensity of the color, use the Chroma slider.
- To adjust the contrast between light and dark areas, use the Gamma slider.
- To adjust the image sharpness, use the Detail slider.

Note

If the video looks grainy or “noisy,” try a lower Detail setting. As in conversation, too much detail is bad.

If you make a change that you don't like, you can clear all your changes by selecting a CCU scene. If you will want to use your color and lighting adjustments again (for example, after changing to a different zoom preset), save them as a custom CCU scene.

If you do not save your adjustments as a custom CCU scene, they will no longer be available after any action that accesses or affects color and lighting adjustments. These actions include:

- Rebooting the camera
- Putting the camera in standby mode
- Selecting a zoom preset that has color and lighting adjustments associated with it

To save a custom CCU scene:

1. Adjust color and lighting. When the scene looks the way you want it to, click Store CCU Scene.
2. In the Store CCU Scene dialog box, select which custom scene to store (Custom A, B, or C).
3. Save your custom scene.

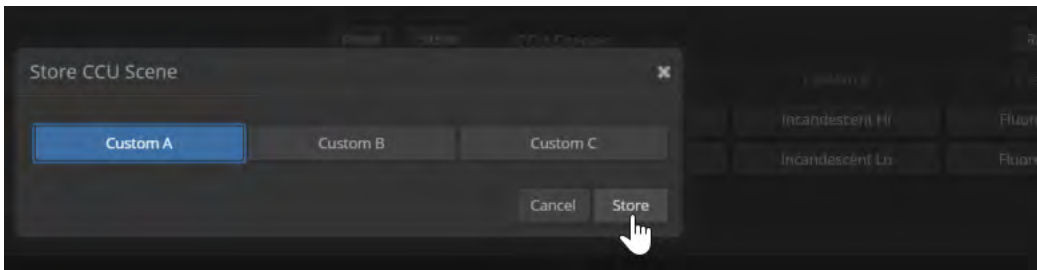

To rename a custom CCU scene:

Right-click a CCU scene label and make the change in the dialog box that opens.



Setting the Home Zoom Level and Other Zoom Presets

CAMERA PAGE

You can define a default zoom level – the Home preset. The camera returns to this level on powering up from standby or following a reboot. You can also define other zoom presets, for views that you will want to use repeatedly.

All zoom presets may include color and lighting information as well as zoom level.

Note

The Store Preset dialog does not show which presets have already been defined. Storing a preset overwrites any information that was previously associated with that preset.

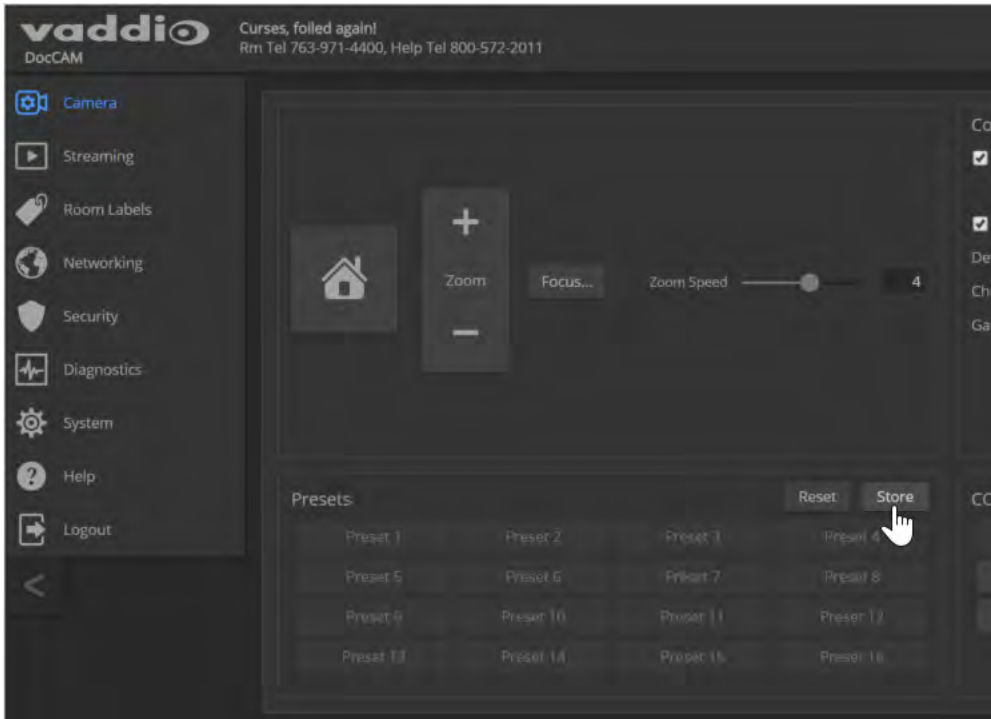

To set a zoom preset:

1. Set up the shot.
2. Optional: Adjust the color settings as needed.
3. Note which presets have not been defined.
4. In the Presets area, select Store.
5. Select the preset number that you want to store.
6. Optional: Check the "Store with current color settings" box. This is super-helpful if you adjusted the color settings in step 2.

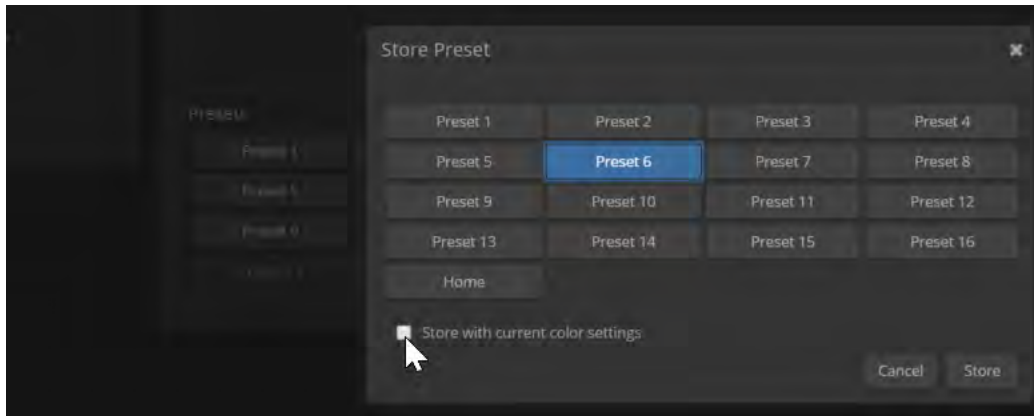

To rename a zoom preset:

Right-click the preset and enter a name in the dialog box that opens.

To clear a zoom preset:

Storing a zoom preset automatically overwrites any information previously associated with that preset. To clear a preset without storing new information, select Reset in the Presets area. Then select the preset to be cleared, and select Reset in the Reset Presets dialog box.

Setting Video Output Resolution

SYSTEM PAGE, DIP SWITCHES TAB

The video output resolution set on the System page determines the resolution available on the video output (s) of the connected OneLINK device or HDBaseT-capable third-party equipment. It also determines the maximum resolution available for the IP stream.

To change the video output resolution:

Select the resolution and frame rate from the table. The arrow on the soft rotary switch points at the character corresponding to your selection.

Hal You fell for it, and now you're both doomed!
Rm Tel 763-971-4400, Help Tel 800-572-2011

Camera | Firmware | **DIP Switches**

Soft DIP Switches

IR Settings	IR On	Laser Enabled	BAUD 9600 bps	LED On	UC LED Color Scheme	HDMI Color YCbCr
IR Settings	IR Off	Laser Disabled	BAUD 38400 bps	LED Off	Pro AV LED Color Scheme	HDMI Color sRGB

Soft Rotary Switch

0	720p/59.94	8	1080p/50
1	1080i/59.94	9	
2	1080p/59.94	A	
3	720p/60	B	
4	1080i/60	C	
5	1080p/60	D	
6	720p/50	E	1080p/30
7	1080i/50	F	1080p/25

Enabling or Disabling the Laser Pointer

SYSTEM PAGE, DIP SWITCHES TAB

By default, the laser pointer is enabled. To disable it, use the soft DIP switch for Laser Enabled/Laser Disabled.

Camera assembly numbers 998-9968-001 and 998-9968-100:

Note

This product contains a Class 1, 650 nm red laser pointer.

Cet appareil contient un pointeur laser de la Classe 1, à lumière rouge de 650 nm.

Camera assembly number 998-9968-000 only:

Caution

This product contains a Class 3 (5 mw) 650 nm red laser which produces visible laser radiation. Avoid direct eye exposure. Do not look at the laser aperture during camera operation.

All DocCAM 20 HDBT part numbers:

Caution | Avertissement

Laser light – Avoid direct eye exposure. Do not look at the laser aperture during camera operation.

Lumière de laser – Ne regardez pas directement dans le faisceau laser. Ne regardez pas directement dans l'ouverture laser lorsque la caméra est en marche.

Caution | Avertissement

Laser controls are available to remote operators using the web interface. Keep your eyes out of the beam path.

Les commandes laser sont disponibles aux opérateurs à distance utilisant l'interface Web. Gardez les yeux hors du trajet du faisceau.

Software Switch Settings

SYSTEM PAGE, DIP SWITCHES TAB

The DIP Switches tab of the System page provides access to these features:

Camera ID (IR Settings) – The IR Remote Commander can control up to three cameras in the same room with different IR frequencies. Use **IR Settings** switches 1 and 2 to select the frequency to identify the camera as camera 1, 2, or 3; then use the Camera Select buttons at the top of the remote to select the camera you want to control.

Switch 1 and switch 2 up: Camera 1

Switch 1 down, switch 2 up: Camera 2

Switch 1 and switch 2 down: Camera 3

IR On/IR Off – Enable/disable the camera's IR sensors. The camera does not respond to the IR remote if IR is off.

IR Out Off/On – Forwards IR when on.

Image Flip – If mounting the camera upside-down, set IMAGE FLIP ON.

Super Wide mode – Provides a wider horizontal field of view and greater zoom. Some distortion may be present.

Baud Rate – RS-232 serial communication rate (9600 bps or 38400 bps).

HDMI color – YCbCr (default) or sRGB.

LED color scheme – Color codes for UC (unified conferencing, the default setting) or Pro AV (broadcast). At this time, the two color schemes are functionally identical on this camera.

LED on/off – In most cases, Vaddio recommends leaving the status light on, to let people in the room know whether the camera is currently sending video.

Note

Vaddio recommends leaving the soft switches in their default positions unless you have verified that you need to change them.



Operating the Camera from the Web Interface

Operator controls include:

- Home and other zoom presets – If defined, Home returns the camera to its default zoom level. Other zoom levels may also be available as presets. All presets, including Home, may include lighting and color adjustments.
- Manual zoom – Zoom in (+) or zoom out (-) using the Zoom buttons.
- Scenes – If defined, color and lighting adjustments are available as scenes.
- Laser – Turn on or turn off the laser pointer, if this is enabled.
- Video Mute – Stop or resume sending video.
- Standby – Put the camera in a low-power state.

The system administrator may choose to disable the laser pointer. See [Enabling or Disabling the Laser Pointer](#).

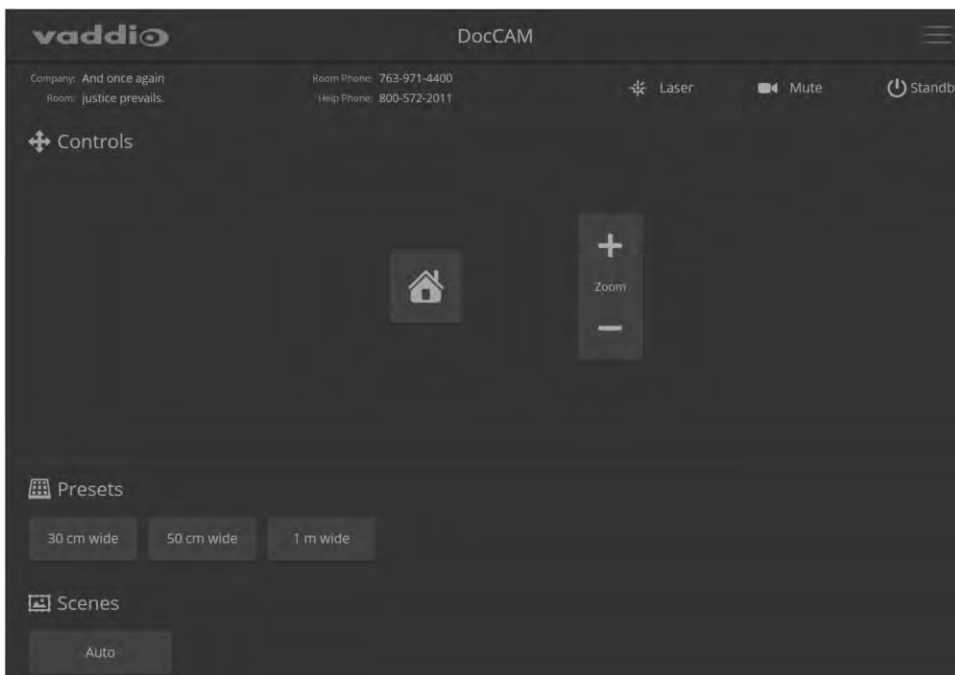

Caution | Avertissement

Laser controls are available to remote operators using the web interface. Keep your eyes out of the beam path.

Les commandes laser sont disponibles aux opérateurs à distance utilisant l'interface Web. Gardez les yeux hors du trajet du faisceau.

Camera assembly numbers 998-9968-001 and 998-9968-100:

Class 1 Laser Product (IEC 60825-1:2014)

Produit Laser de la Classe 1 (IEC 60825-1:2014)

Klass 1 Laserprodukt (IEC 60825-1:2014)

Camera assembly numbers 998-9968-001 and 998-9968-100:

Note

This product contains a Class 1, 650 nm red laser pointer.

Cet appareil contient un pointeur laser de la Classe 1, à lumière rouge de 650 nm.

Camera assembly number 998-9968-000 only:

Caution

This product contains a Class 3 (5 mw) 650 nm red laser which produces visible laser radiation. Avoid direct eye exposure. Do not look at the laser aperture during camera operation.

All DocCAM 20 HDBT part numbers:

Caution | Avertissement

Laser light – Avoid direct eye exposure. Do not look at the laser aperture during camera operation.

Lumière de laser – Ne regardez pas directement dans le faisceau laser. Ne regardez pas directement dans l'ouverture laser lorsque la caméra est en marche.

Telnet Serial Command API

The Vaddio serial command protocol is a high-level, text-based command line interface supported via Telnet session on the camera. The API is accessed by a telnet client on the Ethernet port; the default Telnet port is 23. Telnet sessions require the administrator account login.

The command application protocol interface is intended to allow external device such as AMX or Crestron to control the camera. The protocol is based upon ASCII format following the VT100 terminal emulation standard and uses an intuitive text command nomenclature for ease of use.

General format usage follows a get/set structure. Usage examples for each type are:

Set Example

COMMAND: > **camera zoom in**

RESPONSE: > OK

Get Example

COMMAND: > **camera ccu get iris**

RESPONSE: > iris 11

Syntax Error Example

COMMAND: > **camera preset 1**

RESPONSE: > Syntax error: Unknown or incomplete command

Using a question mark as a command parameter will bring up a list of available commands for the menu you are in.

Things to know about control via Telnet session:

- Command lines are terminated with a carriage return.
- All ASCII characters (including carriage returns) are echoed to the terminal program and appended with the VT100 string ESC[J (hex 1B 5B 4A), which most terminal programs automatically strip.
- CTRL-5 Clears the current serial buffer on the device.

Typographical conventions:

- {x | y | z} – Choose x, y, or z.
- <variable> – Substitute the desired value here.
- < x - y > – Valid range of values is from x through y.
- [optional] – Parameter is not required.

```

telnet 192.168.1.66
BoardroomCamControl login: admin
Password:
Last login: Wed Mar 30 13:19:52 -0500 2016 on /dev/pts/0
*****
*      Vaddio Interactive Shell      *
*          WARNING: Authorized Access Only          *
*****

Welcome admin
? : version
Commit      25120c9af446a884cf282702a214efba8e96bc7
System Version PCC Premier 1.1.0-RC3
OK
? : network settings get
Name        eth0:WAN
MAC Address 98:1E:C0:8D:89:5B
IP Address  192.168.1.66
Netmask     255.255.255.0
DLCN       Disabled
Gateway    192.168.1.254
OK

```

camera zoom

Zooms the camera in toward the subject or out away from the subject.

Synopsis	camera zoom { in [<speed>] out [<speed>] stop }	
Options	in	Moves the camera in.
	out	Moves the camera out.
	speed [1 - 7]	Optional: Specifies the zoom speed as an integer (1 to 7). Default speed is 3.
	stop	Stops the camera's zoom movement.
	get	
	set <1..20>	Sets the zoom level as an integer from 1 to 20.
Examples	<pre>>camera zoom in OK > Zooms the camera in at the default speed. >camera zoom out 7 OK > Zooms the camera out using a speed of 7. >camera zoom stop OK > Stops the camera's zoom motion. >camera zoom set 14 OK > Sets the camera's zoom level to 14x. >camera zoom get 14 OK > Returns the camera's current zoom level.</pre>	

camera focus

Changes the camera focus.

Synopsis	<code>camera focus { near [<speed>] far [<speed> stop mode {get auto manual}}</code>	
Options	<code>near</code>	Brings the focus nearer to the camera. Can only be used when camera is in manual mode.
	<code>far</code>	Moves the focus farther from the camera. Can only be used when camera is in manual mode.
	<code>speed <1 - 8></code>	Optional: integer (1 to 8) specifies the focus speed.
	<code>mode {get auto manual}</code>	Returns the current focus mode, or specifies automatic or manual focus.
	<code>stop</code>	Stops the camera's focus movement.
Examples	<pre> camera focus near OK > </pre> <p>Brings the focus near at the default speed.</p> <pre> camera focus far 7 OK > </pre> <p>Moves the focus farther from the camera at a speed of 7.</p> <pre> camera focus mode get auto_focus: on OK > </pre> <p>Returns the current focus mode.</p>	



camera preset

Moves the camera to the specified zoom preset, or stores the current camera zoom level and optionally CCU information.

Note

This command corresponds to the CAM_Memory commands in the RS-232 command set.

Synopsis	camera preset { recall store} <1 - 16> [save-ccu]	
Options	recall	Zooms the camera to the specified zoom preset. If CCU information was saved with the preset, the camera switches to the CCU setting associated with the preset.
	store	Stores the current zoom level as the specified preset.
	save-ccu	Optional: Saves the current CCU settings as part of the preset. If not specified, the color settings do not change.
Examples	<pre>>camera preset recall 3 OK ></pre> <p>Moves the camera to preset 3.</p> <pre>>camera preset store 1 OK ></pre> <p>Saves the camera's current zoom position as preset 1.</p> <pre>>camera preset store 2 save-ccu OK ></pre> <p>Stores the camera's current position as preset 2. The camera applies the current CCU settings when it is recalled to this preset.</p>	

camera ccu get

Returns CCU (lighting and color) information.

Synopsis	<code>camera ccu get <param></code>	
Options 	<code>all</code>	Returns all current CCU settings.
	<code>auto_white_balance</code>	Returns the current state of the auto white balance setting (on or off).
	<code>red_gain</code>	Returns the red gain value as an integer (0 to 255).
	<code>blue_gain</code>	Returns the blue gain value as an integer (0 to 255).
	<code>backlight_compensation</code>	Returns the current state of the backlight compensation setting (on or off).
	<code>auto_iris</code>	Returns the current auto-iris state (on or off).
	<code>iris</code>	Returns the iris value as an integer (0 to 11).
	<code>gain</code>	Returns the gain value as an integer (1 to 11).
	<code>detail</code>	Returns the detail value as an integer (0 to 15).
	<code>chroma</code>	Returns the chroma value as an integer (0 to 14).
	<code>freeze</code>	Returns the current freeze-frame mode (on or off).
Examples	<pre>>camera ccu get iris iris 6 OK ></pre> <p>Returns the current iris value.</p> <pre>>camera ccu get red_gain red_gain 201 OK ></pre> <p>Returns the current red gain value.</p> <pre>>camera ccu get all auto_iris on auto_white_balance on backlight_compensation off blue_gain 193 chroma 2 detail 8 gain 3 iris 11 red_gain 201 freeze off OK ></pre> <p>Returns all current CCU settings.</p>	

camera ccu set

Sets the specified CCU (lighting and color) information.

Synopsis	camera ccu set <param> <value>	
Options 	auto_white_balance {on off}	Sets the current state of the auto white balance setting (on or off). Auto white balance overrides red gain and blue gain manual settings.
	red_gain <0 - 255>	Sets the red gain value as an integer (0 to 255). Can only be used when auto white balance is off.
	blue_gain <0 - 255>	Sets the blue gain value as an integer (0 to 255). Can only be used when auto white balance is off.
	backlight_compensation {on off}	Sets the current state of the backlight compensation setting (on or off).
	iris <0 - 13>	Sets the iris value as an integer (0 to 13). Can only be used when auto-iris is off.
	auto_iris {on off}	Sets the auto-iris state (on or off). Auto-iris disables manual iris and gain when it is on.
	gain <1 - 11>	Sets gain value as an integer (1 to 11). Can only be used when auto-iris is off.
	detail <0 - 15>	Sets the detail value as an integer (0 to 15).
	chroma <0 - 14>	Sets the chroma value as an integer (0 to 14).
	freeze {on off}	Sets freeze-frame mode on or off.
Examples	<pre>>camera ccu set auto_iris off OK ></pre> <p>Turns off auto-iris mode, returning the camera to manual iris control.</p> <pre>>camera ccu set red_gain 10 OK ></pre> <p>Sets the red gain value to 10.</p>	

camera resolution

Gets or sets the camera's video output resolution.

Notes

Video streams may be at lower resolutions than the configured resolution, but cannot be at higher resolutions.

Changing the resolution interrupts the IP stream. If you are viewing the IP stream, you will need to reopen the stream on the media player.

Synopsis	camera resolution { get set <resolution> }	
Options	get	Returns the resolution and frame rate currently in use.
	set	Sets the resolution and frame rate.
	resolutions	1080p/60 1080p/59.94 1080p/50 1080p/30 1080p/25 1080i/60 1080i/59.94 1080i/50 720p/60 720p/59.94 720p/50
Examples	<pre>>camera resolution get "720p/59.94" > Returns the camera's current resolution and frame rate. >camera resolution set 1080p/30 OK > Sets the camera's resolution and frame rate to 1080p/30.</pre>	

camera laser

Control the camera's laser pointer.

Camera assembly numbers 998-9968-001 and 998-9968-100:

Class 1 Laser Product (IEC 60825-1:2014)

Produit Laser de la Classe 1 (IEC 60825-1:2014)

Klass 1 Laserprodukt (IEC 60825-1:2014)

Camera assembly numbers 998-9968-001 and 998-9968-100:

Note

This product contains a Class 1, 650 nm red laser pointer.

Cet appareil contient un pointeur laser de la Classe 1, à lumière rouge de 650 nm.

Camera assembly number 998-9968-000 only:

Caution

This product contains a Class 3 (5 mw) 650 nm red laser which produces visible laser radiation. Avoid direct eye exposure. Do not look at the laser aperture during camera operation.

All DocCAM 20 HDBT part numbers:

Caution | Avertissement



Laser light – Avoid direct eye exposure. Do not look at the laser aperture during camera operation.

Lumière de laser – Ne regardez pas directement dans le faisceau laser. Ne regardez pas directement dans l'ouverture laser lorsque la caméra est en marche.

Caution | Avertissement

Laser controls are available to remote operators using the web interface. Keep your eyes out of the beam path.

Les commandes laser sont disponibles aux opérateurs à distance utilisant l'interface Web. Gardez les yeux hors du trajet du faisceau.

Synopsis	camera laser { get on off toggle momentary }	
Options	get	Get the current status of the laser pointer (on or off).
	on	Turn on the laser pointer.
	off	Turn off the laser pointer.
	toggle	Change the state of the laser (on if it was off, or off if it was on).
	momentary	Turn on the laser pointer for 5 seconds.
Examples	 <pre>>camera laser on OK > Turns on the laser pointer. >camera laser momentary OK > Turns on the laser pointer for 5 seconds.</pre> 	

camera home

Moves the camera to its home zoom position.

Synopsis	camera home
Example	<pre>>camera home OK ></pre>

camera standby

Set or change camera standby status.

Synopsis	camera standby { get off on toggle }	
Options	get	Returns the camera's current standby state.
	off	Brings the camera out of standby (low power) mode.
	on	Stops video and puts the camera in standby mode.
	toggle	Changes the camera's standby state - if it was not in standby mode, it enters standby; if it was in standby mode, it "wakes up."
Examples	<pre>>camera standby off OK ></pre> <p>Brings the camera out of standby mode.</p> <pre>>camera standby get standby: on OK ></pre> <p>Returns the current standby state.</p>	

video mute

Gets or sets the camera's video mute status. When video is muted, the camera sends black video with an on-screen message stating that video mute is on. This can be desirable when preparing the room or when privacy is needed.

Synopsis	video mute {get off on toggle}	
Parameters	get	Returns the current video mute status.
	off	Unmutes the video. Normal video resumes.
	on	Mutes the video. Black screen with message.
	toggle	Changes the camera's video mute status.
Examples	<pre>video mute get mute: off</pre> <p>Returns video mute status.</p>	
	<pre>video mute on</pre> <p>Transmits black video.</p>	

streaming settings get

Retrieves IP streaming settings. These are configured in the web interface.

Synopsis	<code>streaming settings get</code>	
Parameters	IP Custom_Frame_Rate	Frame rate selected in Custom quality mode.
	IP Custom_Resolution	Resolution selected in Custom quality mode.
	IP Enabled	True if IP streaming is enabled, False if it is not.
	IP Port	The RTSP port number used for IP streaming. Default is 554.
	IP Preset_Quality	Video quality selected in Easy video quality mode.
	IP Preset_Resolution	Resolution selected in Easy video quality mode.
	IP Protocol	The IP streaming protocol in use.
	IP URL	The URL where the stream is available.
	IP Video_Mode	Video quality mode selected (preset or custom)
Example	<pre>>streaming settings get IP Custom_Frame_Rate 30 IP Custom_Resolution 1080p IP Enabled true IP Port 554 IP Preset_Quality Standard (Better) IP Preset_Resolution 720p IP Protocol RTSP IP URL vaddio-doccam-stream IP Video_Mode preset</pre> <p>Returns the current streaming settings.</p>	

network ping

Sends an ICMP ECHO_REQUEST to the specified IP address or hostname.

Synopsis	<code>network ping [count <count>] [size <size>] <destination-ip></code>	
Options	<code><count></code>	The number of ECHO_REQUEST packets to send. Default is five packets.
	<code><size></code>	The size of each ECHO_REQUEST packet. Default is 56 bytes.
	<code><destination-ip></code>	The IP address where the ECHO_REQUEST packets will be sent.
Examples	<pre>>network ping 192.168.1.66 PING 192.168.1.66 (192.168.1.66): 56 data bytes 64 bytes from 192.168.1.66: seq=0 ttl=64 time=0.476 ms 64 bytes from 192.168.1.66: seq=1 ttl=64 time=0.416 ms 64 bytes from 192.168.1.66: seq=2 ttl=64 time=0.410 ms 64 bytes from 192.168.1.66: seq=3 ttl=64 time=0.410 ms 64 bytes from 192.168.1.66: seq=4 ttl=64 time=3.112 ms --- 192.168.1.66 ping statistics --- 5 packets transmitted, 5 packets received, 0% packet loss round-trip min/avg/max = 0.410/0.964/3.112 ms ></pre> <p>Sends five ECHO_REQUEST packets of 56 bytes each to the host at 192.168.1.66.</p>	
	<pre>>network ping count 10 size 100 192.168.1.1</pre> <p>Sends 10 ECHO_REQUEST packets of 100 bytes each to the host at 192.168.1.1. The command returns data in the same form as above.</p>	

network settings get

Returns the current network settings for MAC address, IP address, subnet mask, and gateway.

Synopsis	<code>network settings get</code>
Example	<pre>> network settings get Name eth0:WAN MAC Address 00:1E:C0:F6:CA:7B IP Address 192.168.1.67 Netmask 255.255.255.0 VLAN Disabled Gateway 192.168.1.254 OK ></pre>

system reboot

Reboots the system either immediately or after the specified delay. Note that a reboot is required when resetting the system to factory defaults (system factory-reset).

Synopsis	system reboot [<seconds>]	
Options	<seconds>	The number of seconds to delay the reboot.
Examples	<pre>>system reboot OK > The system is going down for reboot NOW! doccam-D8-80-39-62-A7-C5 Reboots the system immediately. >system reboot 30 Reboots the system in 30 seconds. The response is in the same form; the system message appears at the end of the delay.</pre>	

system factory-reset

Gets or sets the factory reset status. When the factory reset status is on, the system resets to factory defaults on reboot.

Synopsis	system factory-reset { get on off }	
Options	get	Returns the camera's current factory reset status.
	on	Enables factory reset on reboot.
	off	Disables factory reset on reboot.
Examples	 <pre>>system factory-reset get factory-reset (software): off factory-reset (hardware): off OK > Returns the factory reset status. This evaluates the most recent system factory-reset on or off command, if one has been received, then reads the rear panel DIP switches and returns the status on if they are all in the down position. >system factory-reset on factory-reset (software): on factory-reset (hardware): off OK > Enables factory reset upon reboot. Note This command does not initiate a factory reset. The factory reset takes place on the next reboot.</pre>	

version

Returns the current firmware version.

Synopsis	<code>version</code>
Example	<pre>> version Commit: 2062595193b8e2daf605f135f49e16934e4c0df0 HDLink: TX4.6.1*0.01 PSoC Version: 1.2 Sensor Version: 06.00 System Version: DocCAM 1.0.0 OK Returns current firmware version information.</pre>

history

Returns the most recently issued commands from the current Telnet session. Since many of the programs read user input a line at a time, the command history is used to keep track of these lines and recall historic information.

Synopsis	<code>history <limit></code>	
Options	<code><limit></code>	Integer value specifying the maximum number of commands to return.
Examples	<p>history Displays the current command buffer.</p> <p>history 5 Sets the history command buffer to remember the last 5 unique entries.</p>	
Additional information	<p>You can navigate the command history using the up and down arrow keys.</p> <p>This command supports the expansion functionality from which previous commands can be recalled from within a single session. History expansion is performed immediately after a complete line is read.</p> <p>Examples of history expansion:</p> <ul style="list-style-type: none"> * !! Substitute the last command line. * !4 Substitute the 4th command line (absolute as per 'history' command) * !-3 Substitute the command line entered 3 lines before (relative) 	



help

Displays an overview of the CLI syntax.

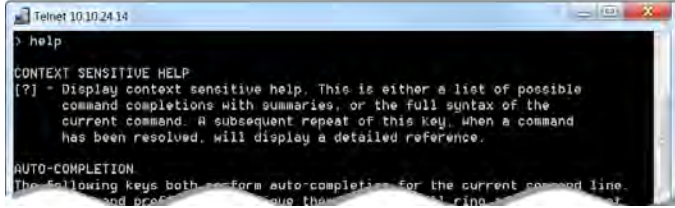
Synopsis	help
Example 	help 

exit

Ends the command session and then closes the socket.

Synopsis	exit
Example	exit

RS-232 Control

The Vaddio Control Protocol is similar to the Sony® VISCA command set in order to be compatible with several popular control devices. Not all VISCA commands are supported and there are Vaddio-specific commands in the following command and inquiry lists.

Camera Zoom and Focus Commands

Command Set	Command	Command Packet	Comments
CAM_Zoom	Stop	8x 01 04 07 00 FF	Corresponds to camera zoom in Telnet API
	Tele (std)	8x 01 04 07 02 FF	
	Wide (std)	8x 01 04 07 03 FF	
	Tele (variable)	8x 01 04 07 2p FF	p = speed 0 (low) to 7 (high)
	Wide (variable)	8x 01 04 07 3p FF	p = speed 0 (low) to 7 (high)
	Direct	8x 01 04 47 0p 0q 0r 0s FF	pqrs = zoom position (0h-4000h)
CAM_Focus	Stop	8x 01 04 08 00 FF	Corresponds to camera focus in Telnet API
	Far (std)	8x 01 04 08 02 FF	
	Near (std)	8x 01 04 08 03 FF	
	Far (variable)	8x 01 04 08 2p FF	p = speed 0 (low) to 7 (high)
	Near (variable)	8x 01 04 08 3p FF	p = speed 0 (low) to 7 (high)
	Direct	8x 01 04 48 0p 0q 0r 0s FF	pqrs = focus position (1000h – F000h)
	Auto Focus	8x 01 04 38 02 FF	
	Manual Focus	8x 01 04 38 03 FF	
	Auto/Manual	8x 01 04 08 10 FF	
	One Push Trigger	8x 01 04 18 01 FF	One push AF trigger
	Near Limit	8x 01 04 28 0p 0q 0r 0s FF	pqrs = near focus limit***
CAM_AFMode	Normal AF	8x 01 04 57 00 FF	AF movement mode
	Internal AF	8x 01 04 57 01 FF	
	Zoom Trigger AF	8x 01 04 57 02 FF	pqrs = movement time, rs = interval

Command Set	Command	Command Packet	Comments
	Activate/Internal Time	8x 01 04 27 0p 0q 0r 0s FF	
CAM_Memory	Reset	8x 01 04 3F 00 0p FF	Corresponds to camera preset in Telnet API. p= preset number(0h-0fh)
	Set standard	8x 01 04 3F 01 0p FF	
	Set standard with 'scene'	8x 01 04 3F 21 0p FF	
	Recall	8x 01 04 3F 02 0p FF	

Zoom and Focus Inquiry Commands

Inquiry Command	Command	Response Packet	Comments
CAM_ZoomPosInq	8x 09 04 47 FF	y0 50 0p 0q 0r 0s FF	pqrs: Zoom position
CAM_FocusPosInq	8x 09 04 48 FF	y0 50 0p 0q 0r 0s FF	pqrs: Focus position
CAM_FocusModelInq	8x 09 04 38 FF	y0 50 02 FF	Auto focus
		y0 50 03 FF	Manual focus
CAM_AFModelInq	8x 09 04 57 FF	y0 50 00 FF	Normal AF
		y0 50 01 FF	Interval AF
		y0 50 02 FF	Zoom trigger AF
CAM_MemoryInq	8x 09 04 3F FF	y0 50 pp FF	pp: Memory number recalled last
CAM_MemoryStatusInq	8x 09 04 3F 0p FF	y0 50 0p 0q 0r 0s FF	p: Memory number q: mode (00-std, 10-std /w ccu, 01-trisync, 11-trisync /w ccu) rs: speed (0x1-0x18) 1 - 24
CAM_MemSaveInq	8x 09 04 23 0X FF	y0 50 0p 0q 0r 0s FF	X: 00h to 07h (Address) pqrs: 0000h to FFFFh (Data)

Color and Light Management Commands

Command Set	Command	Command Packet	Comments
CAM_WB	Auto	8x 01 04 35 00 FF	Normal auto
	Indoor	8x 01 04 35 01 FF	Indoor mode
	Outdoor	8x 01 04 35 02 FF	Outdoor mode
	One Push WB	8x 01 04 35 03 FF	One-push WB mode
	ATW	8x 01 04 35 04 FF	Auto-tracing white balance
	Manual	8x 01 04 35 05 FF	Manual control mode
	One Push Trigger	8x 01 04 10 05 FF	One-push WB trigger
	Outdoor Auto	8x 01 04 35 06 FF	Outdoor auto
	Sodium Lamp Auto	8x 01 04 35 07 FF	Auto including sodium lamp source
	Sodium Lamp	8x 01 04 35 08 FF	Sodium lamp source fixed mode
	Sodium Lamp Outdoor Auto	8x 01 04 35 09 FF	Outdoor auto including sodium lamp source
CAM_RGain	Reset	8x 01 04 03 00 FF	Manual control of red gain
	Up	8x 01 04 03 02 FF	
	Down	8x 01 04 03 03 FF	
	Direct	8x 01 04 43 00 00 0p 0q FF	pq = red gain (00h – FFh)
CAM_BGain	Reset	8x 01 04 04 00 FF	Manual control of blue gain
	Up	8x 01 04 04 02 FF	
	Down	8x 01 04 04 03 FF	
	Direct	8x 01 04 44 00 00 0p 0q FF	pq = blue gain (00h – FFh)
CAM_AE	Full Auto	8x 01 04 39 00 FF	Auto exposure mode
	Manual	8x 01 04 39 03 FF	Manual control mode
	Shutter Priority	8x 01 04 39 0A FF	Shutter priority auto exposure mode
	Iris Priority	8x 01 04 39 0B FF	Iris priority auto exposure mode
	Bright	8x 01 04 39 0D FF	Bright mode (modified AE mode)

Command Set	Command	Command Packet	Comments
CAM_ExpComp	On	8x 01 04 3E 02 FF	Exposure compensation on/off/reset
	Off	8x 01 04 3E 03 FF	
	Reset	8x 01 04 0E 00 FF	Direct: pq = position (0h-0Eh) See "Exposure Compensation Values (CAM_ExpComp)" on the facing page
	Up	8x 01 04 0E 02 FF	
	Down	8x 01 04 0E 03 FF	
	Direct	8x 01 04 4E 00 00 0p 0q FF	
CAM_Shutter	Reset	8x 01 04 0A 00 FF	Shutter setting pq = shutter position (00h – 15h) See "Shutter Speed Values (CAM_Shutter)" on page 62
	Up	8x 01 04 0A 02 FF	
	Down	8x 01 04 0A 03 FF	
	Direct	8x 01 04 4A 00 00 0p 0q FF	
CAM_Iris	Reset	8x 01 04 0B 00 FF	Iris setting pq = iris position (0h, 05h-11h) See "Iris Values (CAM_Iris)" on page 63
	Up	8x 01 04 0B 02 FF	
	Down	8x 01 04 0B 03 FF	
	Direct	8x 01 04 4B 00 00 0p 0q FF	
CAM_Gain	Reset	8x 01 04 0C 00 FF	Iris gain setting pq = gain position (01h – 0Fh) p = gain limit (04h-0Fh) See "Iris Gain Values (CAM_Gain)" on page 63 and "Iris Gain Limit Values (CAM_Gain)" on page 64
	Up	8x 01 04 0C 02 FF	
	Down	8x 01 04 0C 03 FF	
	Direct	8x 01 04 4C 00 00 0p 0q FF	
	+Gain Limit	8x 01 04 2C 0p FF	
CAM_BackLight	On	8x 01 04 33 02 FF	Backlight compensation On/Off
	Off	8x 01 04 33 03 FF	
CAM_Aperture	Reset	8x 01 04 02 00 FF	Aperture setting
	Up	8x 01 04 02 01 FF	
	Down	8x 01 04 02 02 FF	

Command Set	Command	Command Packet	Comments
	Direct	8x 01 04 42 00 00 0p 0q FF	pq = aperture position (0h-0fh)
CAM_Gamma	--	8x 01 04 5B 0p FF	p = gamma setting (0: std, 1: straight)
CAM_Chroma	Direct	8x 01 7E 55 00 00 0p 0q FF	pq: 00h – 14h
CAM_ICR	On	8x 01 04 01 02 FF	ICR mode on/off - adds an IR cut filter to the image for low light images
	Off	8x 01 04 01 03 FF	

Exposure Compensation Values (CAM_ExpComp)

Value	Iris	Gain
0x0E	+7	+10.5 dB
0x0D	+6	+9 dB
0x0C	+5	+7.5 dB
0x0B	+4	+6 dB
0x0A	+3	+4.5 dB
0x09	+2	+3 dB
0x08	+1	+1.5 dB
0x07	0	0 dB
0x06	-1	-1.5 dB
0x05	-2	-3 dB
0x04	-3	-4.5 dB
0x03	-4	-6 dB
0x02	-5	-7.5 dB
0x01	-6	-9 dB
0x00	-7	-10.5 dB

Shutter Speed Values (CAM_Shutter)

Value	60/59.94/30/29.97 fps	50/25 fps
0x15	1/10000	1/10000
0x14	1/6000	1/6000
0x13	1/4000	1/3500
0x12	1/3000	1/2500
0x11	1/2000	1/1750
0x10	1/1500	1/1250
0x0F	1/1000	1/1000
0x0E	1/725	1/600
0x0D	1/500	1/425
0x0C	1/350	1/300
0x0B	1/250	1/215
0x0A	1/180	1/150
0x09	1/125	1/120
0x08	1/100	1/100
0x07	1/90	1/75
0x06	1/60	1/50
0x05	1/30	1/25
0x04	1/15	1/12
0x03	1/8	1/6
0x02	1/4	1/3
0x01	1/2	1/2
0x00	1/1	1/1

Iris Values (CAM_Iris)

Value	Iris
0x11	F1.6
0x10	F2
0x0F	F2.4
0x0E	F2.8
0x0D	F3.4
0x0C	F4
0x0B	F4.8
0x0A	F5.6
0x09	F6.8
0x08	F8
0x07	F9.6
0x06	F11
0x05	F14
0x00	CLOSED

Iris Gain Values (CAM_Gain)

Value	Steps	Gain in dB
0x0F	28	77.8
0x0E	26	44.4
0x0D	24	41.0
0x0C	22	37.5
0x0B	20	34.1
0x0A	18	30.7
0x09	16	27.3
0x08	14	23.9
0x07	12	20.5
0x06	10	17.1
0x05	8	13.7
0x04	6	10.2
0x03	4	6.8
0x02	2	3.4
0x01	0	0

Iris Gain Limit Values (CAM_Gain)

Value	Steps	Gain in dB
0x0F	28	77.8
0x0E	26	44.4
0x0D	24	41.0
0x0C	22	37.5
0x0B	20	34.1
0x0A	18	30.7
0x09	16	27.3
0x08	14	23.9
0x07	12	20.5
0x06	10	17.1
0x05	8	13.7
0x04	6	10.2

Color and Light Management Inquiry Commands

Inquiry Command	Command	Response Packet	Comments
CAM_WBModelInq	8x 09 04 35 FF	y0 50 00 FF	Auto
		y0 50 01 FF	Indoor
		y0 50 02 FF	Outdoor
		y0 50 03 FF	One-push WB
		y0 50 04 FF	ATW
		y0 50 05 FF	Manual
		y0 50 06 FF	Outdoor auto
		y0 50 07 FF	Sodium lamp auto
		y0 50 08 FF	Sodium lamp
		y0 50 09 FF	Sodium lamp outdoor auto
CAM_RGainInq	8x 09 04 43 FF	y0 50 00 00 0p 0q FF	pq: Red gain
CAM_BGainInq	8x 09 04 44 FF	y0 50 00 00 0p 0q FF	pq: Blue gain
CAM_AEModeInq	8x 09 04 39 FF	y0 50 00 FF	Full auto
		y0 50 03 FF	Manual
		y0 50 0A FF	Shutter priority
		y0 50 0B FF	Iris priority
		y0 50 0D FF	Bright
CAM_ExpCompModelInq	8x 09 04 3E FF	y0 50 02 FF	On
		y0 50 03 FF	Off

Inquiry Command	Command	Response Packet	Comments
CAM_ShutterPosInq	8x 09 04 4A FF	y0 50 00 00 0p 0q FF	pq: Shutter position
CAM_IrisPosInq	8x 09 04 4B FF	y0 50 00 00 0p 0q FF	pq: Iris position
CAM_GainPosInq	8x 09 04 4C FF	y0 50 00 00 0p 0q FF	pq: Gain position
CAM_BackLightModelInq	8x 09 04 33 FF	y0 50 02 FF	On
		y0 50 03 FF	Off
CAM_ApertureInq	8x 09 04 42 FF	y0 50 00 00 0p 0q FF	pq: Aperture gain
CAM_ChromaInq	8x 09 7E 55 FF	y0 50 05 00 00 00 0p FF	p: 0 – 0eh
CAM_GammaInq	8x 09 04 5B FF	y0 50 0p FF	Gamma p: 00h , 01h
CAM_ICRModelInq	8x 09 04 01 FF	y0 50 02 FF	On
		y0 50 03 FF	Off

Other Commands

Command Set	Command	Command Packet	Comments
AddressSet	Broadcast	88 30 01 FF	Sets address
IF_Clear	Broadcast	88 01 00 01 FF	I/F clear
CommandCancel		8x 2p FF	p= socket (1 or 2)
CAM_Power	On	8x 01 04 00 02 FF	Power on
	Off	8x 01 04 00 03 FF	Power off
CAM_Tally	On	8x 01 7E 01 0A 00 02 FF	
	Off	8x 01 7E 01 0A 00 03 FF	
CAM_Freeze	On	8x 01 04 62 02 FF	Freeze frame on/off
	Off	8x 01 04 62 03 FF	
CAM_Mute	On	8x 01 04 75 02 FF	Video mute on/off
	Off	8x 01 04 75 03 FF	
	On/Off	8x 01 04 75 10 FF	
CAM_Laser	On	81 01 04 2F 02 FF	Laser pointer on/off/toggle-momentary
	Off	81 01 04 2F 03 FF	
	Toggle	81 01 04 2F 01 FF	

Other Inquiry Commands

Inquiry Command	Command	Response Packet	Comments
CAM_PowerInq	8x 09 04 00 FF	y0 50 02 FF	On
		y0 50 03 FF	Off (standby)
CAM_TallyInq	8x 09 7E 01 0A FF	y0 50 02 FF	On
		y0 50 03 FF	Off
CAM_ResolutionInq	8x 09 06 23 FF	y0 50 0p 0q FF	pq: Video resolution
CAM_FreezeModelInq	8x 09 04 62 FF	y0 50 02 FF	On
		y0 50 03 FF	Off
CAM_ICRModelInq	8x 09 04 01 FF	y0 50 02 FF	On
		y0 50 03 FF	Off
CAM_MuteModelInq	8x 09 04 75 FF	y0 50 02 FF	On
		y0 50 03 FF	Off
CAM_VersionInq	8x 09 00 02 FF	y0 50 00 10 mn pq 0E 0E 02 FF	mnpq: Model code DocCAM 20 HDBT: 050E
CAM_LaserInq	8x 09 04 2F FF	y0 50 02 FF	Laser pointer on
		y0 50 03 FF	Laser pointer off

Specifications

Camera and image

Image device	1/2.8-type Exmor® CMOS sensor, full HD		
Pixels	2.14 million (effective), 2.38 million (total)		
Lens	20x optical zoom, f=4.7mm wide end to 94mm tele end, F1.6 to F3.5		
Horizontal FOV	60° wide end to 3.3° tele end		
Min. working distance	10mm (wide), 1m (tele)	Max. installation height	30 ft (9.1 m)
Min. illumination	0.4 lux – F1.6, 1/30s (100+ lux recommended)		
Backlight compensation	On/off	Aperture/detail	16 steps
Focusing system	Auto/Manual	Gain	Auto / Manual (28 steps)
White balance	Auto, ATW, Indoor, Outdoor, One-push, Manual		
S/N ratio	More than 50 dB	Noise reduction	On/Off, 6 Steps
Sync system	Internal	Power	PoE+
Remote management	IR Remote, web interface, Telnet and RS-232 command APIs		

Physical and Environmental

Weight with tile support and trim ring	5.05 lb (2.3 kg)		
Height	4.25 in (10.8 cm)	Operating/storage temperature	0°C to +40°C (32°F to 104°F)
Width	8 in. (20.3 cm)	Operating/storage humidity	20% to 80% RH, non-condensing
Depth	8 in. (20.3 cm)	Bezel ring outer diameter	6.25 in

Specifications are subject to change without notice.

Troubleshooting and Care

Stuff happens – we get it. Use this information to determine whether it's time to call Vaddio Technical Support.

Check the Status Light First

When the camera doesn't behave as you expect, check the indicator light before you do anything else.

- **Blue:** Normal operation (blinks once when the camera receives a command from the remote)
- **Purple:** In standby mode or booting
- **Yellow:** Firmware update in progress
- **Red:** On-air tally

Identify the Issue

What is it doing?	Possible causes	Check and correct
Nothing. The status light is off, there is no video, and the camera does not respond to the remote. 	The camera is not receiving power.	Is the camera's power source (OneLINK device or PoE+ injector) receiving power? Is the camera's cable connected to the power source? If both are true, either the camera cable or the camera is bad.
	The camera's status light is turned off and the camera is in standby mode.	Point the remote toward the camera and press the Power button.
	The camera's status light is turned off and the remote is not using the same IR channel as the camera.	Push the Camera Select 1 button on the remote. Try the other Camera Select buttons if necessary.
	The camera's status light is off and the camera is confused.	Reboot or power-cycle the camera.
The camera never finishes initializing and the light is purple.	The camera is not receiving enough power. Is a PoE power injector connected?	Use PoE+ instead. PoE does not deliver enough power.
The camera does not respond to the remote and the light is yellow.	A firmware update is in progress.	Wait a few minutes, and try again when the light turns blue.
The camera does not respond to the remote, but the web interface is available	The remote and the camera are not using the same IR channel.	Press the Camera Select 1 button on the remote. Try the other Camera Select buttons if necessary.
	IR is switched off (Soft DIP switch 3 down)	Turn IR on (System page, DIP Switches tab). See Other Switch Settings for more information.
	The remote's batteries are dead.	Put new batteries in the remote.

What is it doing?	Possible causes	Check and correct
The camera responds to the remote but the web interface is not available.	The camera is not using the IP address you browsed to.	Press the Data Screen button on the remote to see camera information.
The camera's web UI is available but the camera does not respond to commands sent via RS-232 connection to the OneLINK device.	The RS-232 cable to the OneLINK device is not connected, or is bad.	Connect a known good cable.
	The camera's baud rate setting doesn't match the settings on the controlling device.	Check the baud rate setting at both ends to be sure they match. The camera's baud rate setting is available on the System page in the web UI.
No H.264 video stream.	Streaming is not enabled.	Enable streaming: Streaming page in the web interface.
The laser pointer is off-center in the image area.	The laser pointer is out of alignment.	Contact Vaddio Technical Support.

Restoring Factory Settings

SYSTEM PAGE, FIRMWARE TAB

Sometimes it's easiest to just start over. To restore the original factory settings...click Restore Factory Settings. This will overwrite anything you have customized, such as custom CCU scenes and presets.

Operation, Storage, and Care

For smears or smudges on the product, wipe with a clean, soft cloth. Use a lens cleaner on the lens. Do not use any abrasive chemicals.

Keep this device away from food and liquids.

Do not operate or store the device under any of the following conditions:

- Temperatures above 40°C (104°F) or below 0°C (32°F)
- High humidity, condensing or wet environments
- Inclement weather
- Severe vibration
- Lunar environments not pressurized and climate-controlled to Earth-normal
- Dry environments with an excess of static discharge

Do not attempt to take this product apart. There are no user-serviceable components inside.

Compliance Statements and Declarations of Conformity

Camera assembly numbers 998-9968-001 and 998-9968-100:

Camera assembly numbers 998-9968-001 and 998-9968-100:

Class 1 Laser Product (IEC 60825-1:2014)

Produit Laser de la Classe 1 (IEC 60825-1:2014)

Klass 1 Laserprodukt (IEC 60825-1:2014)

Camera assembly number 998-9968-000 only:

This product contains a Class 3 laser.

All camera assemblies

Compliance testing was performed to the following regulations:

FCC Part 15 (15.107, 15.109), Subpart B	Class A
ICES-003, Issue 54: 2012	Class A
EMC Directive 2014/30/EU	Class A
EN 55032: 2015	Class A
EN 55024: November 2010	Class A
KN24 2008 (CISPR 24: 1997 + A1: 2000 + A2: 2002)	Class A

Camera assembly numbers 998-9968-001 and 998-9968-100:

IEC 60950-1:2005 (2nd Edition); Am 1: 2009 + Am 2: 2013	Safety
EN 60950-1: 2006 + A11: 2009 + A1: 2010 + A12: 2011 + A2: 2013	Safety
IEC 60825-1: 2014 (3rd Edition)	Safety

FCC Part 15 Compliance

This equipment has been tested and found to comply with the limits for a Class A digital device, pursuant to Part 15, Subpart B, of the FCC Rules. These limits are designed to provide reasonable protection against harmful interference when the equipment is operated in a commercial environment. This equipment generates, uses, and can radiate radio frequency energy and, if not installed and used in accordance with the instruction manual, may cause harmful interference to radio communications. Operation of this equipment in a residential area is likely to cause harmful interference in which case the user will be required to correct the interference at his/her own expense.

Operation is subject to the following two conditions: (1) This device may not cause interference, and (2) This device must accept any interference including interference that may cause undesired operation of the device.

Changes or modifications not expressly approved by Vaddio can affect emission compliance and could void the user's authority to operate this equipment.



ICES-003 Compliance

This digital apparatus does not exceed the Class A limits for radio noise emissions from digital apparatus set out in the Radio Interference Regulations of the Canadian Department of Communications.

Le présent appareil numérique n'émet pas de bruits radioélectriques dépassant les limites applicables aux appareils numériques de la classe A prescrites dans le Règlement sur le brouillage radioélectrique édicté par le ministère des Communications du Canada.



European Compliance

This product has been evaluated for Electromagnetic Compatibility under the EMC Directive for Emissions and Immunity and meets the requirements for a Class A digital device. In a domestic environment this product may cause radio interference in which case the user may be required to take adequate measures.

Standard(s) To Which Conformity Is Declared:



EMC Directive 2014/30/EU

EN 55032: 2015

Conducted and Radiated Emissions

EN 55024: November 2010

Immunity

EN 61000-4-2: 1995 + Amendments A1: 1998 + A2: 2001

Electrostatic Discharge

EN 61000-4-3: 2006 + A1: 2008

Radiated Immunity

EN 61000-4-4: 2004 + Corrigendum 2006

Electrical Fast Transients

EN 61000-4-5: 2006

Surge Immunity

EN 61000-4-6: 2009

Conducted Immunity

EN 61000-4-8: 2010

Power Frequency Magnetic Field

EN 61000-4-11: 2004

Voltage Dips, Interrupts and Fluctuations

KN24 2008 (CISPR 24: 1997 + A1: 2000 + A2: 2002)

IT Immunity Characteristics

EN 61000-4-2

Electrostatic Discharge

EN 61000-4-3

Radiated Immunity

EN 61000-4-4

Electrical Fast Transients

EN 61000-4-5

Surge Immunity

EN 61000-4-6

Conducted Immunity

EN 61000-4-8

Power Frequency Magnetic Field

EN 61000-4-11

Voltage Dips, Interrupts and Fluctuations

Camera assembly numbers 998-9968-001 and 998-9968-100:
IEC 60950-1: 2005 (2nd Edition); Am 1: 2009 + Am 2: 2013

Safety

Camera assembly numbers 998-9968-001 and 998-9968-100:
EN 60950-1: 2006 + A11: 2009 + A1: 2010 + A12: 2011 + A2:
2013

Safety

Camera assembly numbers 998-9968-001 and 998-9968-100:
IEC 60825-1: 2014 (3rd Edition)

Safety

Camera assembly number 998-9968-000 only: This product has not been evaluated for compliance with CE safety requirements.

Warranty Information

See Vaddio Warranty, Service and Return Policies posted on support.vaddio.com for complete details.

Hardware* warranty: Two (2) year limited warranty on all parts and labor for Vaddio manufactured products. Vaddio warrants its manufactured products against defects in materials and workmanship for a period of two years from the day of purchase, to the original purchaser, if Vaddio receives notice of such defects during the warranty. Vaddio, at its option, will repair or replace products that prove to be defective. Vaddio manufactures its hardware products from parts and components that are new or equivalent to new in accordance with industry standard practices.

Exclusions: The above warranty shall not apply to defects resulting from improper or inadequate maintenance by the customer, customers applied software or interfacing, unauthorized modifications or misuse, mishandling, operation outside the normal environmental specifications for the product, use of the incorrect power supply, modified power supply or improper site operation and maintenance. OEM and special order products manufactured by other companies are excluded and are covered by the manufacturer's warranty.

Vaddio Customer Service: Vaddio will test, repair, or replace the product or products without charge if the unit is under warranty. If the product is out of warranty, Vaddio will test then repair the product or products. The cost of parts and labor charge will be estimated by a technician and confirmed by the customer prior to repair. All components must be returned for testing as a complete unit. Vaddio will not accept responsibility for shipment after it has left the premises.

Vaddio Technical Support: Vaddio technicians will determine and discuss with the customer the criteria for repair costs and/or replacement. Vaddio Technical Support can be contacted by email at support@vaddio.com or by phone at one of the phone numbers listed on support.vaddio.com.

Return Material Authorization (RMA) number: Before returning a product for repair or replacement request an RMA from Vaddio's technical support. Provide the technician with a return phone number, e-mail address, shipping address, product serial numbers and original purchase order number. Describe the reason for repairs or returns as well as the date of purchase. See the General RMA Terms and Procedures section for more information. RMAs are valid for 30 days and will be issued to Vaddio dealers only. End users must return products through Vaddio dealers. Include the assigned RMA number in all correspondence with Vaddio. Write the assigned RMA number clearly on the shipping label of the box when returning the product. All products returned for credit are subject to a restocking charge without exception. Special order product are not returnable.

Voided warranty: The warranty does not apply if the original serial number has been removed or if the product has been disassembled or damaged through misuse, accident, modifications, use of incorrect power supply, use of a modified power supply or unauthorized repair.

Shipping and handling: Vaddio will not pay for inbound shipping transportation or insurance charges or accept any responsibility for laws and ordinances from inbound transit. Vaddio will pay for outbound shipping, transportation, and insurance charges for all items under warranty but will not assume responsibility for loss and/or damage by the outbound freight carrier. If the return shipment appears damaged, retain the original boxes and packing material for inspection by the carrier. Contact your carrier immediately.

Products not under warranty: Payment arrangements are required before outbound shipment for all out of warranty products.

Photo Credits

This guide may include some or all of these photos.

European Space Agency (ESA) astronaut Samantha Cristoforetti, a Flight Engineer with Expedition 42, photographs the Earth through a window in the Cupola on the International Space Station

By NASA - https://blogs.nasa.gov/ISS_Science_Blog/2015/03/06/women-in-space-part-two-whats-gender-got-to-do-with-it/, Public Domain, <https://commons.wikimedia.org/w/index.php?curid=38834990>

Carl Sagan, Bruce Murray, Louis Friedman (founders) and Harry Ashmore (advisor), on the occasion of signing the papers formally incorporating The Planetary Society

By credit NASA JPL - JPL, Public Domain, <https://commons.wikimedia.org/w/index.php?curid=1180927>

Main Control Room / Mission Control Room of ESA at the European Space Operations Centre (ESOC) in Darmstadt, Germany

By European Space Agency - ESOC flickr, Credit: ESA - Jürgen Mai, CC BY-SA 3.0-igo,

<https://commons.wikimedia.org/w/index.php?curid=36743173>

Expedition 42 on orbit crew portrait, International Space Station, Mar. 7, 2015 – Barry Wilmore (Commander) Top, Upside down, to the right cosmonaut Elena Serova, & ESA European Space Agency Samantha Cristoforetti. Bottom center US astronaut Terry Virts, top left cosmonauts Alexander Samokutyaev and Anton Shkaplerov.

By NASA - <https://www.flickr.com/photos/nasa2explore/16166230844/>, Public Domain,

<https://commons.wikimedia.org/w/index.php?curid=38931301>

European Space Agency astronaut Luca Parmitano, Expedition 36 flight engineer, outside the International Space Station

By NASA - <http://spaceflight.nasa.gov/gallery/images/station/crew-36/html/iss036e016704.html>, Public Domain, <https://commons.wikimedia.org/w/index.php?curid=27263573>

Chris Cassidy, Luca Parmitano, and Karen Nyberg, ISS, 2013. Photo Credit: NASA

Nicolas Altobelli, Rosetta Scientist at ESA's European Space Astronomy Centre, Villanueva de la Cañada, Madrid, Spain

By European Space Agency - Nicolas Altobelli talks to the media, CC BY-SA 3.0-igo,

<https://commons.wikimedia.org/w/index.php?curid=36743144>

Andrea Accomazzo, ESA Rosetta Spacecraft Operations Manager, providing a live update from the Main Control Room at ESA's European Space Operations Centre, Darmstadt, Germany during the Rosetta wake-up day.

By European Space Agency - Live update from the Main Control Room, CC BY-SA 3.0-igo,

<https://commons.wikimedia.org/w/index.php?curid=36743150>

Sleeping goose

By ladypine - Own work, CC BY-SA 3.0, <https://commons.wikimedia.org/w/index.php?curid=1695227>

Index

A

- admin login 26
 - changing 26
- anatomy of the camera 4-6
- API 43, 56
 - syntax help 56
- auto focus 45
- auto iris 34, 47-48
- auto white balance 34, 47-48
- automatic NTP updating 25

B

- backing up a configuration 28
- backlight compensation 34, 47-48
- behavior on power-up 16, 36
- bit rate, constant or variable (IP streaming setting) 31
- blue gain 34, 47-48
- browser compatibility 20

C

- cable connector 5, 7
- camera ID setting (DIP switch) 40
- camera power 9, 11
- camera select 18-19, See also camera ID setting (DIP switch)
- camera specifications 67
- capabilities 2
- CCU scenes 36
- CCU settings 46-48
- cheat sheet 18, 22
 - Vaddio IR Remote Commander 18
 - web interface 22
- chroma setting 34, 47-48
- cleaning 69
- color settings 34, 47-48
- colors of the status light 17, 68
- command history 55
- commands, RS-232 (VISCA) 57-59, 61-66
- compatibility, browsers 20
- configuration, saving or restoring 28
- connection example 9
- connector identification 4
- constant bit rate (IP streaming setting) 31
- custom CCU scenes 34
- custom home position, setting 36

D

- damage, preventing 7
- default IP address 20
- default settings, restoring 54, 69
- detail setting 34, 47-48
- DHCP 24
- diagnostic logs 30
- Diagnostics page (web) 30
- DIP switch settings 40
- directional controls 18-19

F

- factory defaults, restoring 54, 69
- fault isolation 68
- firmware update 29
- firmware version 29, 55
- focus 18-19, 45

G

- gain 34, 47
 - blue 34
 - red 34
- getting help 30
- guest access 26
 - allowing 26

H

- Help page (web) 30
- home position 36, 51
 - custom 36
- hostname 24

I

- importing a configuration 28
- inactive sessions (web interface) 26
- indicator light 6, 17, 40, 68
 - color scheme 40
 - enable/disable (soft DIP switch) 40
 - location 6
- information, conference room 27
- installation requirements 10-12, 14
- installation, typical 9, 13, 15
 - in gypsum board ceiling 15
 - in tile ceiling 13
- IP address 18-20, 24
 - default 20, 24
- IP streaming 31, 33, 38, 52
 - enabling or disabling 31

- maximum resolution available 38
- quality 31
- resolutions and frame rates 31
- settings 31, 33, 52
- IR on/off (soft DIP switch) 40
- IR remote 18-19
- iris settings 34, 47-48

L

- labels, room 27
- laser pointer 6, 40, 50
 - controlling via API 50
 - enable/disable (soft DIP switch) 40
 - location 6
- lighting settings 34, 47-48
- location of connector 5
- log files 30
- low-power state 51

M

- manual focus 18-19, 45
- maximum IP streaming resolution 38
- mounting kit for hard ceilings 11, 14

N

- navigation buttons, hiding/showing 21
- network configuration 20, 24, 53
 - default 24
- Networking page (web) 24
- NTP server 25

O

- OneLINK 9, 11, 68
- operating environment 69

P

- packing lists 3
- page 24, 26-27, 29-31, 38
 - Diagnostics 30
 - Help 30
 - Networking 24
 - Room Labels 27
 - Security 26
 - Streaming 31
 - System 27, 29, 38
- pan/tilt/zoom 18-19
- passwords 26
- performance specifications 67
- physical and environmental specifications 67

- ping command 53
- PoE+ power 9
- power 9, 11, 16, 18-19
 - on and off 16, 18-19
 - options 9, 11
- power-up settings 36
- presets 18-19, 46
 - clearing 19
 - recalling 46
 - setting 19, 46
- product capabilities 2
- product returns and repairs 72

Q

- quantization (IP streaming setting) 31
- quick reference 18, 22
 - Vaddio IR Remote Commander 18
 - web interface 22

R

- ready state 51
- rebooting the camera 27, 54
- red gain 34, 47-48
- remote control 18-19
- requirements, installation 10-12, 14
- resolution 31, 38, 49
 - IP streaming 31
 - setting via API 49
 - switch setting 38
- restoring a configuration 28
- restoring default settings 54, 69
- RJ-45 connector 7
- room information 27
- Room Labels page (web) 27
- rotary switch, soft (resolution/frame rate) 38
- RS-232 commands 57-59, 61-66
 - setting values 61-64

S

- safety requirements 4, 7, 16-17
- saving a configuration 28
- scenes, CCU 34
 - storing 34
- Scott 34
- Security page (web) 26
- session time-out 26
- settings, default, restoring 54, 69
- site requirements 10
- soft DIP switches 40

- soft rotary switch (resolution/frame rate) 38
- solving problems 68
- specifications 67
- speed 44-45
 - focus 45
 - pan/tilt/zoom 44
- standby state 51
- start-up behavior, setting 36
- static IP address 24
- status light, meanings of colors 17, 68
- storage environment 69
- storing a configuration 28
- streaming 31
 - enabling or disabling 31
 - quality 31
 - settings 31
- Streaming page (web) 31
- streaming settings 52
- structural requirements 10, 12, 14
- supported web browsers 20
- switch settings 29, 40
 - reading from web interface 29
- System page (web) 27, 29, 38
- system time 25

T

- technical specifications 67
- technical support 30
- Telnet command help 56
- Telnet session 43, 55-56
 - ending 56
 - history 55
- temperature, operating and storage 69
- time zone 25
- troubleshooting 68
- typical installation 9, 13, 15
 - in gypsum board ceiling 15
 - in tile ceiling 13

U

- update 29
- user login 26
 - changing 26

V

- Vaddio IR Remote Commander 18
- variable bit rate (IP streaming setting) 31
- version, firmware 55
- video resolution setting 38

- VISCA commands 57-59, 61-66

W

- warranty 7, 72
- web browsers supported 20
- web interface 21, 24, 26-27, 29-31, 38
 - Diagnostics page 30
 - Help page 30
 - navigation button labels 21
 - Networking page 24
 - Room Labels page 27
 - Security page 26
 - Streaming page 31
 - System page 27, 29, 38
- wide dynamic range setting 47-48

Z

- zoom 44
- zoom speed 18-19, 44

Vaddio is a brand of Milestone AV Technologies · www.vaddio.com · Phone 800.572.2011 / +1.763.971.4400 · Fax +1.763.971.4464 · Email info@vaddio.com

Visit us at support.vaddio.com for firmware updates, specifications, drawings, manuals, technical support information, and more. Vaddio, RoboSHOT, and OneLINK are trademarks or registered trademarks of Milestone AV Technologies. HDBaseT™ and the HDBaseT Alliance logo are trademarks of the HDBaseT Alliance. Exmor® is a trademark of Sony Corporation. All other brand names or marks are used for identification purposes and are trademarks of their respective owners. In British Columbia, Milestone AV Technologies ULC carries on business as MAVT Milestone AV Technologies ULC.

©2018 Milestone AV Technologies

vaddio®