



VADDIO™ CLEARVIEW™ HD-20SE QSR SYSTEM

ClearVIEW HD-20SE High Definition, Robotic PTZ Camera featuring the Quick-Connect SR System Interface

Model Number: 999-6985-000 (North America)

Model Number: 999-6985-001 (International)

Model Number: 999-6985-000AW (North America) Arctic White Camera

Model Number: 999-6985-001AW (International) Arctic White Camera



Quick-Connect SR Interface

Part Number: 998-1105-016



TABLE OF CONTENTS

Overview	3
Unpacking:	4
Anatomy of the ClearVIEW HD-20se HD PTZ Camera	5
Image: Front View ClearVIEW HD-20SE	5
Image: Rear View ClearVIEW HD-20SE Connectors	6
First Time Set-up with the ClearVIEW HD-20se:	7
Image: Rear Panel Connections	7
Drawing: Dip Switch and Resolution Label on the Bottom of the ClearVIEW HD-20SE	7
Quick-Connect SR Interface	8
Image: Rear Panel with Feature Call-outs	8
Before Installing:	8
Image: Basic Connectivity Example of the ClearVIEW HD-20SE	9
Installation Basics:	10
General Installation Instructions for the CONCEAL Wall Mounting System:	10
Compliance and CE Declaration of Conformity - ClearVIEW HD-20SE	12
Warranty Information	13
General Specifications:	14
Appendix 1: YPbPr Video Pin-Out for the HD-20SE Camera	14
EZ-Power Video RJ-45 Connector Pin-outs	15
Drawing: ClearVIEW HD-20SE Dimensions	15
Communication Specification	16
HD-20SE Command List (1/2)	16
HD-20SE Command List (2/2)	17
HD-20SE Inquiry List (1/1)	18
Table: HD-20SE OSD Menu Structure	19

OVERVIEW:

The amazing ClearVIEW HD-20SE HD PTZ Camera quite literally combines all of the best features of the ClearVIEW HD-18, HD-19 and HD-20 HD PTZ cameras into ONE! The innovation of the HD-18 EZCamera™ Cat-5 interfaces, the low light capability of the HD-19 and the FULL HD performance of the HD-20 are all represented, and improved upon with the ClearVIEW HD-20SE. The ClearVIEW HD-20SE is clearly the best ClearVIEW ever, and here's why.

The HD-20SE is a native 1080p/60 camera using the latest 1/2.8-Type Exmor® high-speed, low noise CMOS image sensor technology with 2.38 Megapixels (total) and 2.14 Megapixels (effective). The ISP (image signal processor) is off-the-hook, not only providing fast, razor-sharp auto-focus routines with incredible detail, realistic textures and vivid colors, it also has an impressive low-light performance of 0.3 Lux (color) and 0.03 Lux (B/W). The lens is a 20X optical zoom multi-element glass lens with an impressive horizontal field of view of 63° on the wide end to 3.47° on the tele end. The outputs are simultaneous HDMI, YPbPr and HSDS™ (differential video for use with Quick-Connect™ Interfaces) and supports both drop frame and non-drop frame HD video resolutions of 1080p/60/59.94/50/30/25, 1080i/60/59.94/50 and 720p/60/59.94/50.

So to recap, latest technology, awesome ISP, superb low-light performance, powerful yet wide angle lens, lots and lots of video outs, drop and non-drop frame video, Full HD and there's more!

The ClearVIEW HD-20SE is paired with the Quick-Connect SR Interface in the QSR system, which provides power to the camera and returns HSDS video from the camera up to 100' (30.5m) over a single Cat-5e cable. RS-232 control and IR signals (modulated or non-modulated) can be passed from the camera to third-party equipment, such as videoconferencing codecs on a second Cat-5e cable.

The ClearVIEW HD-20SE is an exceptional value and a remarkable camera for even the most demanding HD video applications including House of Worship productions, pro A/V system integration, distance learning classrooms, live events, IMAG systems, UCC applications, videoconferencing, distance learning, lecture capture and more!. To top it all off, the ClearVIEW HD-20SE cameras are available in black or arctic white and are made in the USA.

Intended Use:

Before operating the device, please read the entire manual thoroughly. The system was designed, built and tested for use indoors with the power supply provided. The use of a power supply other than the one provided or outdoor operation has not been tested and could damage the device and/or create a potentially unsafe operating condition.

Important Safeguards:

Read and understand all instructions before using. Do not operate any device if it has been dropped or damaged. In this case, a Vaddio technician must examine the product before operating. To reduce the risk of electric shock, do not immerse in water or other liquids and avoid extremely humid conditions.



Use only the power supply provided with the system. Use of any unauthorized power supply will void any and all warranties.



Please do not use "pass-thru" type RJ-45 connectors. These pass-thru type connectors do not work well for professional installations and can be the cause of intermittent connections which can result in the RS-232 control line failing and locking up, and/or compromising the HSDS (high speed differential) signals. For best results please use standard RJ-45 connectors and test all cables for proper pin-outs prior to use and connection to Vaddio product.



ClearVIEW
HD-20SE in
Black

ClearVIEW
HD-20SE in
Arctic White
(AW)

Quick-Connect SR
Interface

Save These Instructions:

The information contained in this manual will help you install and operate your product. If these instructions are misplaced, Vaddio keeps copies of Specifications, Installation and User Guides and most pertinent product drawings for the Vaddio product line on the Vaddio website. These documents can be downloaded from www.vaddio.com free of charge.

UNPACKING:

Carefully remove the product and all of the included parts from the packaging. Identify the following parts for each camera:

ClearVIEW HD-20SE QSR SYSTEM (North America):

Part Number: 999-6985-000

- One (1) ClearVIEW HD-20SE Camera (998-6980-000)
- One (1) Quick-Connect SR Interface
- One (1) 24 VDC, 2.08 Power Supply with Power Cord for North America
- One (1) 3-Pos Molex 5mm Euro Connector
- One (1) Vaddio IR Remote Commander
- One (1) EZCamera™ Control Adapter (RJ-45 to DB-9)
- One (1) CONCEAL Wall Mount System
- Quick-Start Guide (1-pager)

Note: Full Manuals are downloaded from support.vaddio.com

ClearVIEW HD-20SE, HD PTZ Camera (International):

Part Number: 999-6985-001

- One (1) ClearVIEW HD-20SE Camera (998-6980-000)
- One (1) Quick-Connect SR Interface
- One (1) 3-Pos Molex 5mm Euro Connector
- One (1) 24 VDC, 2.08 Power Supply
- One (1) Euro Power Cable
- One (1) UK Power Cable
- One (1) Vaddio IR Remote Commander
- One (1) EZCamera™ Control Adapter (RJ-45 to DB-9)
- One (1) CONCEAL Wall Mount System
- Quick-Start Guide (1-pager)

Note: Full Manuals are downloaded from support.vaddio.com

ClearVIEW HD-20SE, HD PTZ Camera (North America):

Part Number: 999-6985-000AW (Artic White Version)

- One (1) ClearVIEW HD-20SE Camera (998-6980-000AW)
- One (1) Quick-Connect SR Interface
- One (1) 3-Pos Molex 5mm Euro Connector
- One (1) 24 VDC, 2.08 Power Supply with Power Cord for North America
- One (1) Vaddio IR Remote Commander
- One (1) EZCamera™ Control Adapter (RJ-45 to DB-9)
- One (1) CONCEAL Wall Mount System in AW
- Quick-Start Guide (1-pager)

Note: Full Manuals are downloaded from support.vaddio.com

ClearVIEW HD-20SE, HD PTZ Camera (International):

Part Number: 999-6985-001AW (Artic White Version)

- One (1) ClearVIEW HD-20SE Camera (998-6980-000AW)
- One (1) Quick-Connect SR Interface
- One (1) 3-Pos Molex 5mm Euro Connector
- One (1) 24 VDC, 2.08 Power Supply
- One (1) Euro Power Cable
- One (1) UK Power Cable
- One (1) Vaddio IR Remote Commander
- One (1) EZCamera™ Control Adapter (RJ-45 to DB-9)
- One (1) CONCEAL Wall Mount System in AW
- Quick-Start Guide (1-pager)

Note: Full Manuals are downloaded from support.vaddio.com



ANATOMY OF THE CLEARVIEW HD-20SE HD PTZ CAMERA

Image: Front View ClearVIEW HD-20SE



1) Camera and Zoom Lens:

The 20X optical zoom lens is built around a (1/2.8 Type) high-speed, low-noise Exmor CMOS image sensor with a total of 2.38 total megapixels for precise HD video image acquisition.

2) Red Tally Light:

A red tally light is illuminated when the camera receives a command from an external control system.

3) IR Sensors:

IR sensors are built into the front of the ClearVIEW HD-20SE to receive IR signals from the IR remote control supplied with the camera.

4) Blue Power Light:

A Vaddio blue LED power light is illuminated when the camera is turned on. This LED will blink when IR signals are received.

Image: Rear View ClearVIEW HD-20SE Connectors



5) RS-232 IN & IR Out (Color Coded Blue):

The RS-232 accepts modified VISCA protocol for camera control, as well as transmits IR signaling received by the IR receivers to the Quick-Connect SR and the Quick-Connect DVI/HDMI-SR only, which can be sent to third party devices.

6) Dip Switch Settings:

Settings for IR remote, baud rate and image flip can be configured on these switches. See the Switch Settings page for additional information.

7) HD Video Select:

A rotary switch allows the user to choose the component HD output video resolution and format. See the Switch Settings page for additional information.

HD Resolution Note: When changing the resolution of the camera, the camera may have to be power-cycled after the change. The switcher typically will require a reboot or rescan.

8) 12 VDC Input:

Power input for the standard, ClearVIEW HD-20SE camera power supply.

9) HDMI Output:

The HDMI output feeds out HD digital video only (no copy protect or device communication is included). The HDMI output is optimized for HD video signals (seems logical).

10) YPbPr Output:

Component HD video (YPbPr) is output through the DE-15 connector. YPbPr and HDMI signals are simultaneous. Limited SD resolutions are supported.

11) EZ-POWER VIDEO Port (Color Coded Orange):

This RJ-45 connector is only used with the Quick-Connect SR Interface, Quick-Connect DVI-D/HDMI SR Interface and the Quick-Connect USB Interface to supply power and return HSDS (differential) video from the camera.

12) Slot for Optional Cards:

An EZIM CCU Slot Card is available for use with the Quick-Connect Universal CCU and is plugged into this slot.

FIRST TIME SET-UP WITH THE CLEARVIEW HD-20SE:

The ClearVIEW HD-20SE was designed to be a high quality camera that is very easy to use and operate. There is documentation at the back of this manual for pin-outs of the connectors on the ClearVIEW HD-20SE camera.

Step 1: Using the HD VIDEO SELECT rotary switch and CAMERA SETTINGS dip switches on the back of the camera, set up the camera's output resolution and functional preferences. There is a label on the bottom of the camera that identifies the choices.

Important Dip Switch Note: Setting all dip switches down and power cycling the camera will load the factory default camera settings. For the first time set-up, loading the defaults may be a good idea.

Image: Rear Panel Connections



Drawing: Dip Switch and Resolution Label on the Bottom of the ClearVIEW HD-20SE

DIP SWITCH SETTINGS										HD VIDEO SELECT			
IR 1 & 2 UP	IR OUT OFF	9600 bps	5 OFF	6 OFF	HDMI COLOR YCbCr	IMAGE FLIP OFF	9 OFF	10 OFF	0	720p/59.94	8	1080p/50	
<input checked="" type="checkbox"/>	<input checked="" type="checkbox"/>	<input checked="" type="checkbox"/>	<input checked="" type="checkbox"/>	<input checked="" type="checkbox"/>	<input checked="" type="checkbox"/>	<input checked="" type="checkbox"/>	<input checked="" type="checkbox"/>	<input checked="" type="checkbox"/>	1	1080i/59.94	9	---	
<input checked="" type="checkbox"/>	<input checked="" type="checkbox"/>	<input checked="" type="checkbox"/>	<input checked="" type="checkbox"/>	<input checked="" type="checkbox"/>	<input checked="" type="checkbox"/>	<input checked="" type="checkbox"/>	<input checked="" type="checkbox"/>	<input checked="" type="checkbox"/>	2	1080p/59.94	A	---	
<input checked="" type="checkbox"/>	<input checked="" type="checkbox"/>	<input checked="" type="checkbox"/>	<input checked="" type="checkbox"/>	<input checked="" type="checkbox"/>	<input checked="" type="checkbox"/>	<input checked="" type="checkbox"/>	<input checked="" type="checkbox"/>	<input checked="" type="checkbox"/>	3	720p/60	B	---	
<input checked="" type="checkbox"/>	<input checked="" type="checkbox"/>	<input checked="" type="checkbox"/>	<input checked="" type="checkbox"/>	<input checked="" type="checkbox"/>	<input checked="" type="checkbox"/>	<input checked="" type="checkbox"/>	<input checked="" type="checkbox"/>	<input checked="" type="checkbox"/>	4	1080i/60	C	---	
<input checked="" type="checkbox"/>	<input checked="" type="checkbox"/>	<input checked="" type="checkbox"/>	<input checked="" type="checkbox"/>	<input checked="" type="checkbox"/>	<input checked="" type="checkbox"/>	<input checked="" type="checkbox"/>	<input checked="" type="checkbox"/>	<input checked="" type="checkbox"/>	5	1080p/60	D	---	
IR 2 ON	IR 3 ON	ON	38400 bps	---	---	sRGB COLOR	ON	---	6	720p/50	E	1080p/30	
<input checked="" type="checkbox"/>	<input checked="" type="checkbox"/>	<input checked="" type="checkbox"/>	<input checked="" type="checkbox"/>	<input checked="" type="checkbox"/>	<input checked="" type="checkbox"/>	<input checked="" type="checkbox"/>	<input checked="" type="checkbox"/>	<input checked="" type="checkbox"/>	7	1080i/50	F	1080p/25	
1	2	3	4	5	6	7	8	9	10				

- Set the desired and available HD output resolution for the camera with the Rotary Switch.
- Set the IR frequency of the camera if it is to respond to the IR remote control.
- If using the IR forwarding feature, set the IR OUT switch to ON (SW3).
- Set the Baud Rate dip switch (SW4) to 9600bps for most applications. Default for Vaddio EZCamera Cabling Systems is 9600bps.
- To set the HDMI or DVI color space, use dip switch 7 (SW7).
- If inverting the camera, turn the IMAGE FLIP ON (SW8).

Dip Switch Settings Explained:

- IR 1 & 2:** The IR remote has the capability of operating up to three different PTZ cameras from one remote. Use the selector buttons at the top of the IR remote to select the frequency.
- IR Out 3:** The IR output is sent out on the RS-232 RJ-45 jack on the back of the camera. Turning on the IR output will allow IR signals to be transmitted over the Cat-5 cable to the head end. When using RS-232 control or Vaddio CCU controllers (also via RS-232), turn the IR OUT to OFF (up).
- Baud Rate 4:** The options for baud rate are either 9600 bps or 38,400 bps.
- HDMI Color or sRGB Color space 7:** Default is YCbCr. Use sRGB color space with older DVI-D monitors only. The YCbCr color space works for HDMI digital video. With the Quick-Connect SR, only use YCbCr.
- Image Flip 8:** To invert the HD-20, turn the IMAGE FLIP ON (switch down).
- Switches 5, 6, 9 and 10:** Leave up - or in the OFF position.

QUICK-CONNECT SR INTERFACE

Image: Rear Panel with Feature Call-outs

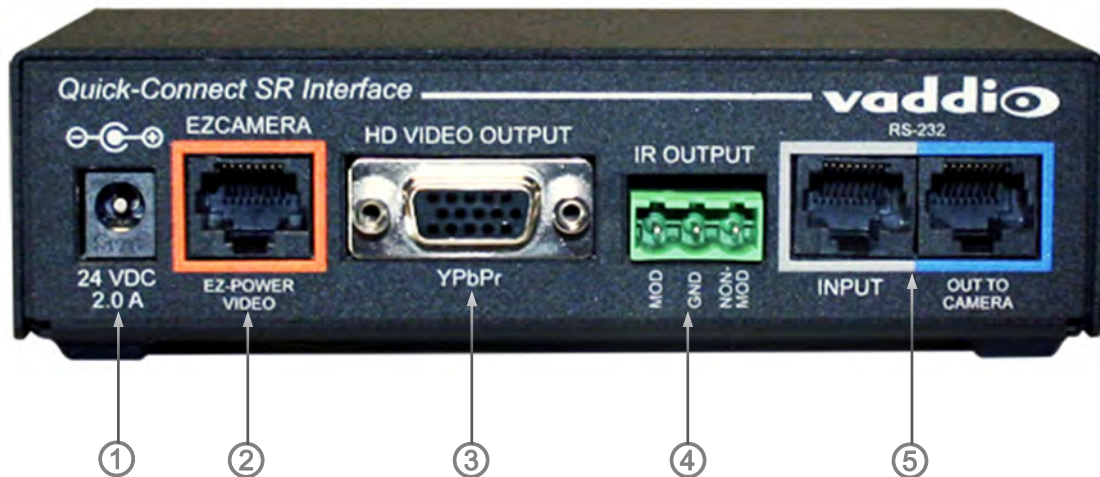

1) Power Input:

5.5mm OD x 2.5mm ID coaxial connector for the provided 24 VDC, 2.0 Amp switching power supply.

2) EZ-POWER VIDEO Port (Color Coded Orange):

A single Cat-5/5e/6 connection between the EZ-POWER VIDEO RJ-45 connector and the camera's the EZ-POWER VIDEO Port extends power and video. Power is fed to the camera and HSDS video is returned from the camera on the same Cat-5.

3) HD Video Output:

DE-15 connector outputs the YPbPr analog component HD video, which was extended from the camera over Cat-5 cable. SD video resolutions (Y/C and CVBS formats) are not supported by the Quick-Connect SR Interface, however analog component YPbPr SD (high fps format - 480p/59.94 and 576p/50) video is supported.

4) IR Output:

With the IR pass-thru turned ON (see camera dip switch settings), IR from third-party IR remote controls can be sent through the camera to third-party equipment, such as hardware videoconferencing codecs. IR can be used as either modulated (through the air) or non-modulated (wired) signals.

5) RS-232 INPUT (Color Coded Grey) and OUT TO CAMERA (Color Coded Blue) Jacks: These RJ-45 connectors allow an external controller (look-out for upcoming shameless plug) like the ProductionVIEW™ Precision Camera Controller to route through the Quick-Connect SR for ease of cable routing.

Before Installing:

- Choose camera mounting location, paying close attention to camera viewing angles, lighting conditions, possible line of site obstructions, and checking for in-wall obstructions where the camera is to be mounted. Always pick a mounting location that will optimize the performance of the camera.
- The CONCEAL wall mount for the ClearVIEW system can be mounted directly to a 2-gang wall box or can be mounted using only dry wall anchors.
- For Power/Video and RS-232 signals, use standard Cat-5 cable (568B termination with real RJ-45 connectors) from the EZ-POWER VIDEO and RS-232 ports on the back of the camera to the Quick-Connect SR Interface (see install instructions).

Image: Basic Connectivity Example of the ClearVIEW HD-20se

HD-20se Camera connected to the Quick-Connect SR Interface and ProductionVIEW Precision Camera Controller



RS-232 Cabling:

For RS-232, use a standard Cat-5 cable (568B termination for RJ-45 connectors) from the RS-232 port on the back of a Vaddio ProductionVIEW camera controller or switcher. If the camera will be connected to a third-party control system (such as AMX or Crestron), a DE-9 to RJ-45 adapter is supplied with the camera for RS-232.

INSTALLATION BASICS:

The ClearVIEW QSR system was designed for installation on a vertical surface with Cat-5 cable connectivity for Video, Power and Control signaling (two Cat-5 cables are required). Installation is simplified in that no custom 8-Pin mini-din cables or expensive plenum coax cables or multi-pin cables are needed and no power outlets are required near the camera bracket. All cabling is routed to the head-end using Cat-5 cables with standard straight through RJ-45 connectors (568B termination). *“Pass-thru” type RJ-45 connectors should be avoided, like black bears on an installation site.*



General Installation Instructions for the CONCEAL Wall Mounting System:

Step 1: Determine Camera Mount Location

When locating the camera, consider viewing angles, lighting conditions, possible line of site obstructions and check for in-wall obstructions where the camera is to be mounted. Again, choose a mounting location to optimize the performance of the camera. After determining the optimum location of the camera system, route both of the required Cat-5 cables from the camera to the head-end. Mark the cables EZ-POWER VIDEO and RS-232 accordingly.

Both Cat-5 cables should feed-through a 1” (25.4mm) opening (circular or square shape) centered in the rectangular slot located on the rear flange of the CONCEAL Wall Mount Bracket.



Note: Do not cut out the entire rectangular slot opening in the wall! This will not allow the two lower wall anchors to correctly fasten the CONCEAL bracket to the wall.

If the bracket is to be mounted on a 2-gang wall box, use the screws supplied with the wall box cover plate to attach the CONCEAL Wall Mount Bracket. If mounting to drywall with wall anchors, use the four (4) quality wall anchors/screws provided.

Note: The mounting holes are slotted and are 90° opposing to provide easy leveling. Level the mount and tighten the mounting screws. The example of the CONCEAL mount shows an HD-USB, but the steps are identical for the HD-22 or HD-30.



Note: Check all Cat-5 cables for continuity in advance of final connection. Plugging the POWER/VIDEO Cat-5 cable into the wrong RJ-45 may cause damage to the camera system and void the warranty!

Step 2: System Wiring

Follow the sample wiring diagrams for connecting the Cat-5 cables to the camera and Quick-Connect SR Interface. Additional diagrams are available on the Vaddio website.

Connect the camera side as follows:

- Connect the Power/Video Cat-5 to the EZ POWER HD VIDEO RJ-45 jack on the back of the camera.
- Connect the RS-232 Control Cat-5 to the “RS-232 IN” RJ-45 on the camera.

Connect the Quick-Connect SR side as follows:

- Connect the Power/Video Cat-5 to the EZCAMERA POWER & HD VIDEO RJ-45 jack
- Connect the RS-232 Cat-5 cable to the RS-232 OUTPUT and route the controller to the RS-232 input.
- The controller can be routed directly to the camera if preferred. For IR Forwarding, the RS-232 cable must be routed through the Quick-Connect SR in order to operate correctly (see pin-out section)
- Wait to connect the power supply until later.

Step 3: Secure the Camera To the CONCEAL Wall Mount Bracket

After all cables are attached to the camera, place the camera onto the camera mount and insert the two 1/4"-20 screws into the camera through the two-screw slots in the bottom of the mount. **Note:** Be sure to align each side of the camera evenly for the best fit prior to tightening the mounting screws.

Step 4: Install the CONCEAL Lower Cover Plate

Attach the CONCEAL lower cover plate. Slide the lower cover plate from front of the mounting bracket toward the rear of the bracket. The two (2) rear locking tabs will need to be guided into position first and will lock in place as the lower cover plate is pushed toward the rear of the mounting bracket. The two (2) front tabs will engage as the cover is pushed back into place.

CONCEAL Lower Cover Plate with Locking Tabs



CONCEAL Lower Cover Plate locked in place



Step 5: Install the CONCEAL Rear Camera Cover

Install the CONCEAL rear camera cover on the mounting bracket with the supplied screw.

CONCEAL Rear Camera Cover



Completed CONCEAL Wall Mount Camera Bracket Installation



NOTE (One more time!): Verify that the Cat-5 cables are plugged in correctly. Plugging the Power/Video cable into the wrong RJ-45 jack may cause damage to the camera system and void the warranty.

Step 6: Connect System Power

Connect the 24 VDC power supply to the Quick-Connect SR Interface and to an AC outlet. The SR will power the camera via the Power/Video Cat-5 cable. The camera will "Home" to a centered position and will output video when it has completely booted up. The ClearVIEW camera is now ready for control information from the controller or IR Remote Commander.



A Note on Boot Order: When using a joystick controller or external control system, in order to ensure proper continuity of control and operation of the cameras, the RS-232 controller should be powered-on after the camera. In most, if not all cases, the camera needs to be on and running in order for communication to take place between the camera and controller. When plugging a new camera into a RS-232 controller/joystick that has already been powered up, a system reboot or camera rescan may be necessary to find the camera.

COMPLIANCE AND CE DECLARATION OF CONFORMITY - CLEARVIEW HD-20SE

Compliance testing was performed to the following regulations:

- **FCC Part 15 (15.107, 15.109), Subpart B**
- **ICES-003, Issue 4: 2004**
- **EN 55022 A: 2006 + A1: 2007**
- **KN24 2008 (CISPR 24: 1997 + A1: 2000 + A2: 2002)**
- **KN22 2008 (CISPR 22: 2006)**
- **EMC Directive 2004/108/EC**
- **EN 55024: A2: 2003**

- Class A
- Class A
- Class A
- Class A
- Class A
- Class A
- Class A



FCC Part 15 Compliance

This equipment has been tested and found to comply with the limits for a Class A digital device, pursuant to Part 15, Subpart B, of the FCC Rules. These limits are designed to provide reasonable protection against harmful interference when the equipment is operated in a commercial environment. This equipment generates, uses, and can radiate radio frequency energy and, if not installed and used in accordance with the instruction manual, may cause harmful interference to radio communications. Operation of this equipment in a residential area is likely to cause harmful interference in which case the user will be required to correct the interference at his/her own expense.

Operation is subject to the following two conditions: (1) This device may not cause interference, and (2) This device must accept any interference including interference that may cause undesired operation of the device. Changes or modifications not expressly approved by Vaddio can affect emission compliance and could void the user's authority to operate this equipment.



ICES-003 Compliance

This digital apparatus does not exceed the Class A limits for radio noise emissions from digital apparatus set out in the Radio Interference Regulations of the Canadian Department of Communications.

Le présent appareil numérique n'émet pas de bruits radioélectriques dépassant les limites applicables aux appareils numériques de la classe A prescrites dans le Règlement sur le brouillage radioélectrique édicté par le ministère des Communications du Canada.



European Compliance

This product has been evaluated for Electromagnetic Compatibility under the EMC Directive for Emissions and Immunity and meets the requirements for a Class A digital device. In a domestic environment this product may cause radio interference in which case the user may be required to take adequate measures.

Standard(s) To Which Conformity Is Declared:

EMC Directive 2004/108/EC

EN 55022 A: 2006 + A1: 2007(CISPR 22:2005/A1:2005)

EN 55024: 1998 + Amendments A1: 2001 + A2: 2003

- EN 61000-4-2: 1995 + Amendments A1: 1998 + A2: 2001
- EN 61000-4-3: 2006 + A1: 2008
- EN 61000-4-4: 2004 + Corrigendum 2006
- EN 61000-4-5: 2006
- EN 61000-4-6: 2009
- EN 61000-4-8: 2010
- EN 61000-4-11: 2004

KN24 2008 (CISPR 24: 1997 + A1: 2000 + A2: 2002)

- EN 61000-4-2
- EN 61000-4-3
- EN 61000-4-4
- EN 61000-4-5
- EN 61000-4-6
- EN 61000-4-8
- EN 61000-4-11

IEC 60950-1:2005 (2nd Edition); Am 1:2009

EN 60950-1:2006+A11:2009+A1:2010+A12:2011

- Radiated and Conducted Emissions
- Immunity
- Electrostatic Discharge
- Radiated Immunity
- Electrical Fast Transients
- Surge Immunity
- Conducted Immunity
- Power Frequency Magnetic Field
- Voltage Dips, Interrupts and Fluctuations
- IT Immunity Characteristics
- Electrostatic Discharge
- Radiated Immunity
- Electrical Fast Transients
- Surge Immunity
- Conducted Immunity
- Power Frequency Magnetic Field
- Voltage Dips, Interrupts and Fluctuations
- Safety
- Safety

WARRANTY INFORMATION

(See Vaddio Warranty, Service and Return Policies posted on vaddio.com for complete details):

Hardware* Warranty: Two (2) year limited warranty on all parts and labor for Vaddio manufactured products. Vaddio warrants its manufactured products against defects in materials and workmanship for a period of two years from the day of purchase, to the original purchaser, if Vaddio receives notice of such defects during the warranty. Vaddio, at its option, will repair or replace products that prove to be defective. Vaddio manufactures its hardware products from parts and components that are new or equivalent to new in accordance with industry standard practices.

Exclusions: The above warranty shall not apply to defects resulting from improper or inadequate maintenance by the customer, customers applied software or interfacing, unauthorized modifications or misuse, mishandling, operation outside the normal environmental specifications for the product, use of the incorrect power supply, modified power supply or improper site operation and maintenance. OEM products and products manufactured by other companies are excluded and are covered by the manufacturer's warranty.

Vaddio Customer Service: Vaddio will test, repair, or replace the product or products without charge if the unit is under warranty. If the product is out of warranty, Vaddio will test then repair the product or products. The cost of parts and labor charge will be estimated by a technician and confirmed by the customer prior to repair. All components must be returned for testing as a complete unit. Vaddio will not accept responsibility for shipment after it has left the premises.

Vaddio Technical Support: Vaddio technicians will determine and discuss with the customer the criteria for repair costs and/or replacement. Vaddio Technical Support can be contacted through one of the following resources: e-mail support at support@vaddio.com or online at vaddio.com.

Return Material Authorization (RMA) Number: Before returning a product for repair or replacement request an RMA from Vaddio's technical support. Provide the technician with a return phone number, e-mail address, shipping address, product serial numbers and original purchase order number. Describe the reason for repairs or returns as well as the date of purchase. See the General RMA Terms and Procedures section for more information. RMA's are valid for 30 days and will be issued to Vaddio dealers only. End users must return products through Vaddio dealers. Include the assigned RMA number in all correspondence with Vaddio. Write the assigned RMA number clearly on the shipping label of the box when returning the product. All products returned for credit are subject to a restocking charge without exception.

Voided Warranty: The warranty does not apply if the original serial number has been removed or if the product has been disassembled or damaged through misuse, accident, modifications, use of incorrect power supply, use of a modified power supply or unauthorized repair.

Shipping and Handling: Vaddio will not pay for inbound shipping transportation or insurance charges or accept any responsibility for laws and ordinances from inbound transit. Vaddio will pay for outbound shipping, transportation, and insurance charges for all items under warranty but will not assume responsibility for loss and/or damage by the outbound freight carrier. If the return shipment appears damaged, retain the original boxes and packing material for inspection by the carrier. *Contact your carrier immediately.*

Products not under Warranty: Payment arrangements are required before outbound shipment for all out of warranty products.

Other General Information:

Care and Cleaning

Do not attempt to take this product apart at any time. There are no user-serviceable components inside.

- Do not spill liquids in the product
- Keep this device away from food and liquid
- For smears or smudges on the product, wipe with a clean, soft cloth
- Use a quality lens cleaner on the lens
- Do not use any abrasive chemicals.

Operating and Storage Conditions:

Do not store or operate the device under the following conditions:

- Temperatures above 40°C (104°F) or temperatures below 0°C (32°F)
- High humidity, condensing or wet environments
- In inclement weather
- In swimming pools or beaver dams
- Dry environments with an excess of static discharge
- In orbit (vacuum, temperature and re-entry problem)
- Under severe vibration

GENERAL SPECIFICATIONS:

ClearVIEW HD-20se, HD PTZ Camera	
Part Numbers	999-6985-000 (North America), 999-6985-001 (Int'l) - Black Camera Version 999-6985-000AW (North America), 999-6985-001AW (Int'l) - Artic White Camera Version
Image Sensor	1/2.8-Type Exmor, high-speed, low-noise CMOS Image Sensor 2.38 Megapixels (2.14M effective pixels).
Zoom	20X Optical Zoom with Multi-element Glass Lens
Field of View	Horizontal: 63° Wide End to 3.47° Tele End, (16:9 Aspect Ratio) Vertical: 36.8° Wide End to 1.85° Tele End
Lens Focal Length	f=4.44mm to 89mm / F1.6 - F3.4
Minimum Illumination	Color: 0.3 Lux (F1.6, 1/30 sec, 50 IRE), B/W: 0.03 Lux (F1.6, 1/30 sec, 50 IRE)
Video Resolutions	HD: 1080p/60/59.94/50./30/25, 1080i60/59.94/50 and 720p/60/59.94/50 HD Video Resolutions Only at 16:9
White Balance	Auto, Manual (Red and Blue Gain), OPWB, Indoor, Outdoor and Fluorescent
Video Output Formats	HDMI, Analog Component, HSDS (Differential Video, Power and Control for Quick-Connects)
Signal to Noise Ratio	Greater than 50 dB (AGC: Off)
Compatible Quick-Connects	Quick-Connect SR, Quick-Connect DVI/HDMI SR, Quick-Connect USB and Quick-Connect Universal CCU
Pan Range	Pan: +170 degrees to -170 degrees, Tilt: +90 degrees to -30 degrees
Preset Positions	16 (internal), 6 recalled via IR Remote
Control Methods	RS-232, IR Remote Commander and OSD (on screen display)
Tally Light	Available through RS-232 Control
HD Video Select	16-Position Rotary Switch: Used to set HD Video Resolution Output
Camera Settings	10-Position Dip Switch: Settings for IR Select, Baud Rate 9600, Image Flip and Color Space
Accessory Slot Cards	EZIM CCU Slot Card, Part Number 998-6900-006
Dimensions/Weight	7.81" (198.37mm) H x 6.67" (169.42mm) W x 7.057" (179.25. mm) D / 5.6 lbs. (2.630835643 kg.)
Quick-Connect SR Interface	
Connectors	<ul style="list-style-type: none"> • Power Connector: 5.5mm OD, 2.5mm ID coaxial connector • Power/Video RJ-45: Supplies power to, and differential HD video from the camera • Video Output: DE-15 connector for HD Analog Component (YPbPr) video only (No SD Support) • IR Output: Transmits modulated or non-modulated IR signals - from the camera's IR receiver • RS-232 IN RJ-45: Accepts RS-232 from ProductionVIEW or other external control systems • RS-232 OUT RJ-45: Sends RS-232 from Quick-Connect SR to the camera
Power Supply	24 VDC, 2.08 Amp Switching Power Supply
Dimensions (H x W x D)	1/3 Rack Size 1.6" (40.64mm) H x 5.5" (139.7mm) W x 3.25" (82.55mm) D
Accessory	Rack Mount Adapter: 998-6000-002 - Holds three (3) Quick-Connect SR Interfaces

APPENDIX 1: YPbPr VIDEO PIN-OUT FOR THE HD-20SE CAMERA

Pin	YPbPr
1	Pr
2	Y
3	Pb
4	-
5	-
6	Pr GND
7	Y GND
8	Pb GND
9	-
10	GND
11	-
12	-
13	-
14	-
15	-

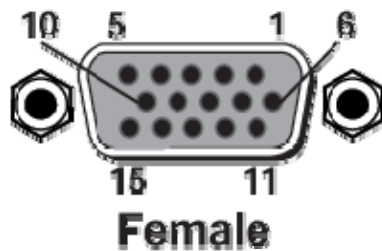

EZ-Power Video RJ-45 Connector Pin-outs



Important Note: The EZ-Power Video RJ-45 Connector is for use with the **Quick-Connect SR, Quick-Connect DVI/HDMI SR** and **Quick-Connect USB Interfaces ONLY** (568B Wiring Standard). The video signals are differential (HSDS™) and can only be received by the interfaces above.

Pin	YPbPr
1	Power+
2	Power-
3	Y+
4	PB+
5	PB -
6	Y -
7	PR+
8	PR-

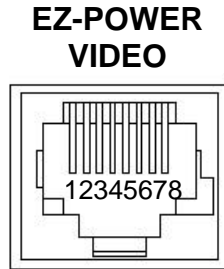

Drawing: ClearVIEW HD-20se Dimensions

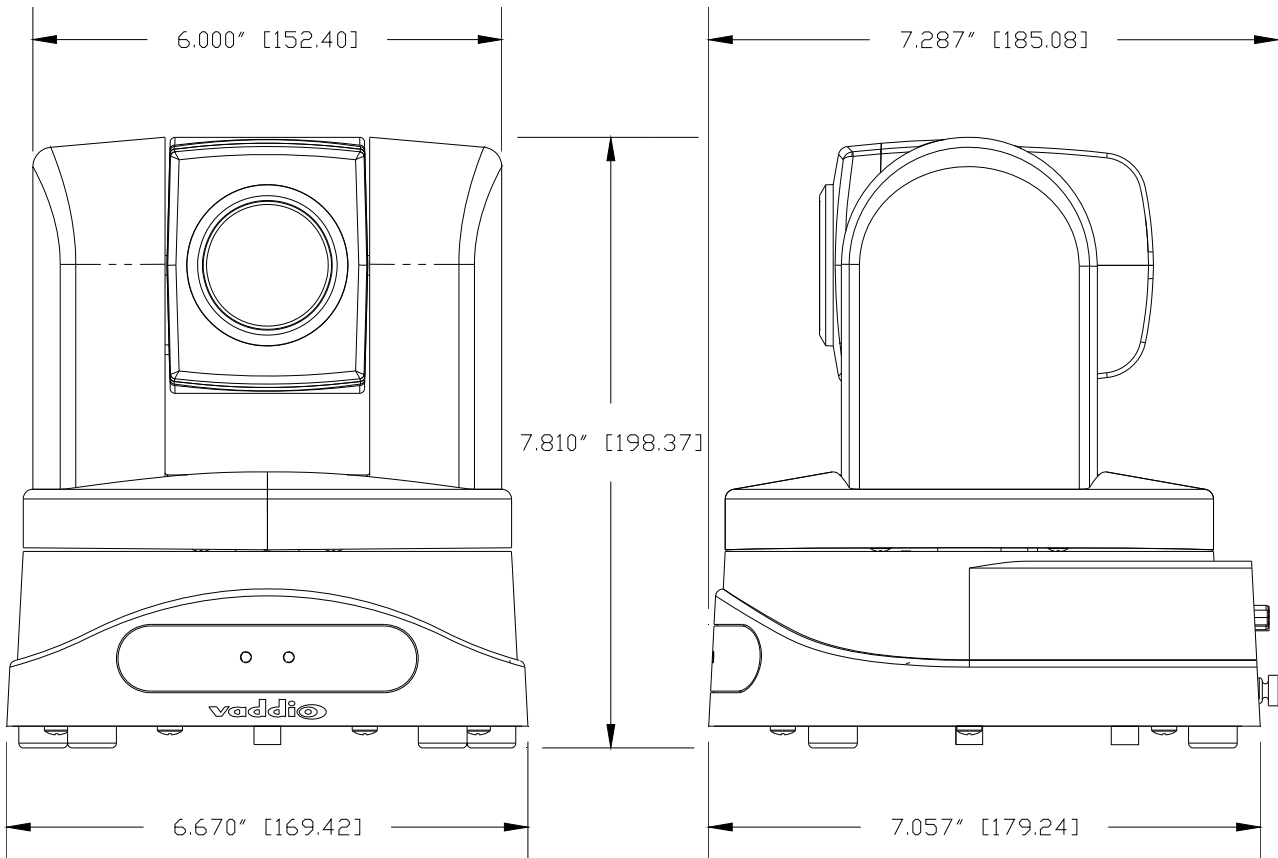

COMMUNICATION SPECIFICATION

Communication Speed: 9600 bps (default)
 Start bit: 1
 Stop bit: 1
 Data bits: 8
 Parity: None
 No Flow control

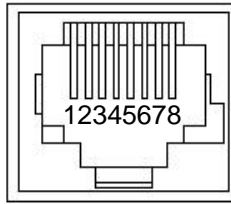

Pin #	RJ-45 RS-232 and IR Out Pins
1)	Unused
2)	Unused
3)	Unused
4)	IR Output (Diff Signal to Quick-Connect SR)
5)	IR Ground (Diff Signal to Quick-Connect SR)
6)	GND (GND of IR Short Range - Pin 3)
7)	RXD (from TXD of control source)
8)	TXD (to RXD of control source)

NOTE: The Vaddio ClearVIEW HD-20SE Control Protocol is similar, but not identical to, the Sony® VISCA™ command set in order to be compatible with several popular control devices. Not all VISCA commands are supported and there are many HD-Series specific commands in the following Command and Inquiry Lists.

HD-20SE Command List (1/2)

Command Set	Command	Command Packet	Comments
Address Set	Broadcast	88 30 01 FF	Address Set (Daisy chain)
IF_Clear	Broadcast	88 01 00 01 FF	IF Clear
Command Cancel		8x 2p FF	p:socket number(1,2)
CAM_Power	On	8x 01 04 00 02 FF	Power On/Off
	Off(Standby)	8x 01 04 00 03 FF	
CAM_Zoom	Stop	8x 01 04 07 00 FF	pqrs: Zoom Position* v:(Speed) 0-7
	Tele(Standard)	8x 01 04 07 02 FF	
	Wide(Standard)	8x 01 04 07 03 FF	
	Tele(Variable)	8x 01 04 07 2p FF	
	Wide(Variable)	8x 01 04 07 3p FF	
	Direct	8x 01 04 47 0p 0q 0r 0s FF	
CAM_Focus	Direct(Variable)	8x 01 7E 01 4A 0v 0p 0q 0r 0s FF	pqrs: Focus position*
	Stop	8x 01 04 08 00 FF	
	Far(Standard)	8x 01 04 08 02 FF	
	Near(Standard)	8x 01 04 08 03 FF	
	Far(Variable)	8x 01 04 08 2p FF	
	Near(Variable)	8x 01 04 08 3p FF	
	AutoFocus	8x 01 04 38 02 FF	
	ManualFocus	8x 01 04 38 03 FF	
CAM_WB	Auto/Manual	8x 01 04 38 10 FF	pqrs: Focus position*
	Direct	8x 01 04 48 0p 0q 0r 0s FF	
	Auto	8x 01 04 35 00 FF	
	Manual	8x 01 04 35 05 FF	
	Indoor	8x 01 04 35 01 FF	
CAM_RGain	Outdoor	8x 01 04 35 02 FF	pqrs:00-0xffff
	One Push WB	8x 01 04 35 03 FF	
	Reset	8x 01 04 03 00 FF	
	Up	8x 01 04 03 02 FF	
CAM_BGain	Down	8x 01 04 03 03 FF	pqrs:00-0xffff
	Direct	8x 01 04 43 0p 0q 0r 0s FF	
	Reset	8x 01 04 04 00 FF	
	Up	8x 01 04 04 02 FF	
CAM_AE	Down	8x 01 04 04 03 FF	Auto Exposure Mode Manual Control Mode Shutter Priority Mode Exposure Priority Mode (default)
	Direct	8x 01 04 44 43 0p 0q 0r 0s FF	
	Full Auto	8x 01 04 39 00 FF	
	Manual	8x 01 04 39 03 FF	
CAM_Iris	Shutter Priority	8x 01 04 39 0A FF	pq(0x00-0x08)
	Iris Priority	8x 01 04 39 0B FF	
	Reset	8x 01 04 0B 00 FF	
	Up	8x 01 04 0B 02 FF	
CAM_Gain	Down	8x 01 04 0B 03 FF	pq(0x00-0x2A)
	Direct	8x 01 04 4B 00 00 0p 0q FF	
	Reset	8x 01 04 0C 00 FF	
	Up	8x 01 04 0C 02 FF	
CAM_Bright	Down	8x 01 04 0C 03 FF	pq(0x01-0x64)
	Direct	8x 01 04 4C 00 00 0p 0q FF	
	Reset	8x 01 04 0D 00 FF	
	Up	8x 01 04 0D 02 FF	
CAM_Bright	Down	8x 01 04 0D 03 FF	pq(0x01-0x64)
	Direct	8x 01 04 4D 00 00 0p 0q FF	
	Reset	8x 01 04 0D 00 FF	
	Up	8x 01 04 0D 02 FF	
CAM_Bright	Down	8x 01 04 0D 03 FF	pq(0x01-0x64)
	Direct	8x 01 04 4D 00 00 0p 0q FF	
	Reset	8x 01 04 0D 00 FF	
	Up	8x 01 04 0D 02 FF	

HD-20SE Command List (2/2)

Command Set	Command	Command Packet	Comments
CAM_Backlight	On	8x 01 04 33 02 FF	
	Off	8x 01 04 33 03 FF	
CAM_Aperture	Reset	8x 01 04 02 00 FF	
	Up	8x 01 04 02 02 FF	
	Down	8x 01 04 02 03 FF	
	Direct	8x 01 04 42 00 00 0p 0q FF	pq(0x00-0x1F)
CAM_Memory	Reset	8x 01 04 3F 00 0p FF	
	Set	8x 01 04 3F 01 0p FF	
	Recall	8x01 04 3F 02 0p FF	p:Memory No(=0-0xF)
CAM_IDWrite		8x 01 04 22 0p 0q 0r 0s FF	pqrs:0x0000 – 0xFFFF
CAM_LR_Reverse On	On	8x 01 04 61 02 FF	Mirror (Horizontal) on
	Off	8x 01 04 61 03 FF	Mirror (Horizontal) off
IR_Receive##	On	8x 01 06 08 02 FF	
	Off	8x 01 06 08 03 FF	
	On/Off	8x 01 06 08 10 FF	IR forwarding/Local IR
Pan-tiltDrive	Up	8x 01 06 01 VV WW 03 01 FF	VV: Pan Speed (0x01-0x18)
	Down	8x 01 06 01 VV WW 03 02 FF	WW: Tilt Speed(0x01-0x14)
	Left	8x 01 06 01 VV WW 01 03 FF	
	Right	8x 01 06 01 VV WW 02 03 FF	
	UpLeft	8x 01 06 01 VV WW 01 01 FF	
	UpRight	8x 01 06 01 VV WW 02 01 FF	
	DownLeft	8x 01 06 01 VV WW 01 02 FF	
	DownRight	8x 01 06 01 VV WW 02 02 FF	
	Stop	8x 01 06 01 VV WW 03 03 FF	
	Absolute Position	8x 01 06 02 VV WW 0Y 0Y 0Y 0Y 0Z 0Z 0Z 0Z FF	YYYY: Pan Position** ZZZZ: Tilt Position**
	Home	8x 01 06 04 FF	
Reset	8x 01 06 05 FF		
Pan-tilt-zoom Drive	Up	8x 01 06 0A VV WW XX 03 01 03 FF	VV: Pan Speed (0x01-0x18)
	Down	8x 01 06 0A VV WW XX 03 02 03 FF	WW: Tilt Speed(0x01-0x14)
	Left	8x 01 06 0A VV WW XX 01 03 03 FF	XX: ZoomSpeed(0x00-0x07)
	Right	8x 01 06 0A VV WW XX 02 03 03 FF	
	Tele	8x 01 06 0A VV WW XX 03 03 01 FF	
	Wide	8x 01 06 0A VV WW XX 03 03 02 FF	
	UpLeft	8x 01 06 0A VV WW XX 01 01 03 FF	
	UpRight	8x 01 06 0A VV WW XX 02 01 03 FF	
	DownLeft	8x 01 06 0A VV WW XX 01 02 03 FF	
	DownRight	8x 01 06 0A VV WW XX 02 02 03 FF	
	Stop	8x 01 06 0A VV WW XX 03 03 03 FF	YYYY: Pan Position** ZZZZ: Tilt Position** RRRR: ZoomPosition**
	Absolute Position	8x 01 06 0B VV WW XX 0Y 0Y 0Y 0Y 0Z 0Z 0Z 0Z 0R 0R 0R 0R FF	
	Tally	On	8x 01 7E 01 0A 00 02 FF
Off		8x 01 7E 01 0A 00 03 FF	
Preset Pan Speed	Pan/Tilt/Zoom Speed	8x 01 7E 01 0B WW SS ZZ FF	WW: Pan Speed (0x01-0x18) SS:Tilt Speed(0x01-0x14) ZZ:Zoom Speed(0-7);
Motor Config	Hard Motor Stops	8x 01 7E 01 70 00 00 FF	
	Soft Motor Stops	8x 01 7E 01 70 00 01 FF	
BLK.Enhance	Pedestal	No Support	No Support
GMA.Enhance	Gamma	8x 01 7E 54 00 00 0p 0q FF	pq: Gamma (0x00-0x10)
CRM.Enhance	Chroma	8x 01 7E 55 00 00 0p 0q FF	pq: Chroma (0x00-0x64)
KNE.Enhance	Knee	No Support	No Support
DIS.Enhance	Digital Image	8x 01 7E 57 02 FF	On
	Stabilizer	8x 01 7E 57 03 FF	Off
SNR.Enhance	Super Noise	8x 01 7E 58 02 FF	On
	Reduction	8x 01 7E 58 03 FF	Off
AGC.Enhance	AGC Mode	8x 01 7E 59 00 FF	Off
		8x 01 7E 59 01 FF	Low
		8x 01 7E 59 02 FF	Medium
		8x 01 7E 59 03 FF	High
CAM_Shutter	Reset	8x 01 04 0A 00 FF	
	Up	8x 01 04 0A 02 FF	
	Down	8x 01 04 0A 03 FF	
	Direct	8x 01 04 4A 00 00 0p 0q FF	pq(0x00-0x1C)
CAM_ExpComp	On	8x 01 04 3E 02 FF	AutoExposure Off
	Off	8x 01 04 3E 03 FF	AutoExposure On
	Reset	8x 01 04 0E 00 FF	
	Up	8x 01 04 0E 02 FF	
	Down	8x 01 04 0E 03 FF	
Direct	8x 01 04 4E 00 00 0p 0q FF	Pq: 0x00-0x2A	
CAM_ICR Cut Filter	ICR On	8x 01 04 01 02 FF	ICR On - Cut Filter Out
	ICR Off	8x 01 04 01 03 FF	ICR Off - Cut Filter In

HD-20SE Command List (2/2) Notes

***Zoom and Focus Data:**

CAM_Zoom: Range(0x000-0x071A)
 CAM_Focus: Range (0x0ed-0x0944) dependent on Zoom Position

****Additional Information:**

Pan Range: 8044 – 7FBC (-32,700 to +32,700)
 Tilt Range: E891 – 4C2B (-5,999 to +19,499)
 Actual Pan/Tilt ranges defined in Inquiry list

HD-20se Inquiry List (1/1)



Inquiry Command	Command	Response Packet	Comments
CAM_PowerInq	8x 09 04 00 FF	y0 50 02 FF y0 50 03 FF	On Off(Standby)
CAM_ZoomPosInq	8x 09 04 47 FF	y0 50 0p 0q 0r 0s FF	pqr: 0-0x071A
CAM_FocusPosInq	8x 09 04 48 FF	y0 50 0p 0q 0r 0s FF	pqrs: Focus Position
CAM_WBModelInq	8x 09 04 35 FF	y0 50 00 FF y0 50 05 FF y0 50 01 FF y0 50 02 FF y0 50 03 FF	Auto Manual Indoor Outdoor One Push WB
CAM_RGain	8x 09 04 43 FF	y0 50 0p 0q 0r 0s FF	pqrs: 000-0xffff
CAM_BGain	8x 09 04 44 FF	y0 50 0p 0q 0r 0s FF	pqrs: 000-0xffff
CAM_Iris	8x 09 04 4B FF	y0 50 00 00 0p 0q FF	pq(0x00-0x08)
CAM_Gain	8x 09 04 4C FF	y0 50 00 00 0p 0q FF	pq(0x00-0x2A)
CAM_Bright	8x 01 04 4D FF	y0 50 00 00 0p 0q FF	pq(0x01-0x64)
CAM_BacklightModelInq	8x 09 04 33 FF	y0 50 02 FF y0 50 03 FF	On Off
CAM_ApertureInq	8x 09 04 42 FF	y0 50 00 00 0p 0q FF	Pq:x00-0x1F
CAM_MemoryInq	8x 09 04 3F FF	y0 50 0p FF	p:Preset 0-0xf
CAM_IDInq	8x 09 04 3F FF	y0 50 0p 0q 0r 0s FF	pqrs:0x0000 – 0xFFFF
CAM_ReceiveInq	8x 09 06 08 FF	y0 50 02 FF y0 50 03 FF	On Off
CAM_LR_Reverse	8x 09 04 61 FF	y0 50 02 FF y0 50 03 FF	On Off
Pan-TiltMaxSpeedInq	8x 09 06 11 FF	y0 50 pp qq FF	pp:Pan 0x01-0x18 qq:Tilt 0x01-0x14
Pan-tiltPositionInq	8x 09 06 12 FF	FF y0 50 0p 0p 0p 0q 0q 0q 0q FF	pppp: Pan 0x8044-0x7FB2 qqqq: Tilt 0xE890-0x4C2C
TallyInq	8x 09 7E 01 0A FF	y0 50 02 FF y0 50 03 FF	On Off
PresetSpeedInq	8x 09 7E 01 0B FF	y0 50 pp qq rr FF	pp:Pan 0x01-0x18 qq:Tilt 0x01-0x14 rr:Zoom 0x00-0x07
Motor Config	8x 09 7E 01 70 FF	y0 50 00 FF y0 50 01 FF	Hard Motor Stops Soft Motor Stops
BLK.Enhance	No support	No Support	Pedestal
GMA.Enhance	8x 09 7E 54 FF	y0 50 00 00 0p 0q FF	pq: Gamma (0x00-0x10)
CRM.Enhance	8x 09 7E 55 FF	y0 50 00 00 0p 0q FF	pq: Chroma (0x00-0x64)
KNE.Enhance	No support	No Support	Knee
DIS.Enhance	8x 09 7E 57 FF	y0 50 02 FF y0 50 03 FF	On Off
SNR.Enhance	8x 09 7E 58 FF	y0 50 02 FF y0 50 03 FF	On Off
AGC.Enhance	8x 09 7e 59 FF	y0 50 00 FF y0 50 01 FF y0 50 02 FF y0 50 03 FF y0 50 04 FF	Off Low Medium High Manual AGC
CAM_AEModelInq	8x 09 04 39 FF	y0 50 00 FF y0 50 03 FF y0 50 0A FF y0 50 0B FF	Auto Exposure Mode Manual Control Mode Shutter Priority Mode Exposure Priority Mode
CAM_ShutterPosInq	8x 09 04 4A FF	y0 50 00 00 0p 0q FF	pq: 0x0-0x1C
CAM_ExpCompModelInq	8x 09 04 3E FF	y0 50 02 FF y0 50 03 FF	On - AE Mode Off Off – AE Mode On
CAM_ExpCompPosInq	8x 09 04 4E FF	y0 50 00 00 0p 0q FF	pq: ExpComp Pos
CAM_ICRModelInq	8x 09 04 01 FF	y0 50 02 FF y0 50 03 FF	On - ICR filter Out Off – ICR filter In

TABLE: HD-20SE OSD MENU STRUCTURE

Use this OSD menu with the IR Commander to make video adjustments (AWB, COLOR, EXP, etc...) on the HD-20SE Camera.

Menu	Controls	Modes/Range	Default	Notes
SSDR	OFF		OFF	Dynamic Range Adjustment
	ON	SSDR 0-15	8*	*When Dynamic Range is ON
	Return			Return to Main Menu
WHITE BAL	ATW		ON	Auto White Balance - ON
	MANUAL>	RED 0 - 1000	560	Adjust Red Level
		BLUE 0 - 1000	480	Adjust Blue Level
		RETURN<		Return to WHITE BAL Menu
	AWC-SET			
	OUTDOOR	Set to Outdoor when room has direct sun light and blue walls		
INDOOR	Set to Indoor when fluorescent lights start to cause color variation in ATW mode			
	MERCURY			
	SODIUM			
	RETURN<			Return to Main Menu
BACKLIGHT	OFF		OFF	Default BLC is off
	WDR>	LEVEL (LOW / MED / HIGH)	OFF	Wide Dynamic Range
		RETURN<		
	BLC>	LEVEL (LOW / MED / HIGH)	OFF	
		BOTTOM 1-100		
		LEFT 1-100		
		RIGHT 1-100		
		RETURN<		Return to BACKLIGHT Menu
	HLC>	LEVEL (LOW / MED / HIGH)	OFF	
		MASK TONE 1-15		
	RETURN<		Return to BACKLIGHT Menu	
	RETURN<		Return to Main Menu	
INTELLIGENCE	OFF	Intelligence, motion detection analytics and masking are not processed or used by the HD-20SE camera, however the OSD menu still works.		
FOCUS	MODE	AUTO / MANUAL / ONE PUSH	AUTO	
	ZOOM TRACK>	OFF / TRACK / AUTO TRACK	AUTOTRACK	
	ZOOM SPEED>	SLOW / MEDIUM / FAST		
	DIGITAL ZOOM>	OFF/ON	OFF	Default is OFF
		ON>LIMIT X2 - X16		Avoid Digital Zoom if possible
		RETURN<		Return to FOCUS Menu
	Zoom POS INIT>	OFF/AUTO		Zoom position initialization
		MANUAL>		
		POS INIT 1X - 20X	1X	Sets INIT Zoom Position
		RETURN<		Return to FOCUS Menu
	USER PRESET>	OFF/ON	OFF	
		ON > PRESET NO 1-128	1	Zoom Presets
		PRESET SAVE		
	PRESET CLEAR			
	RETURN<		Return to FOCUS Menu	
LENS INIT	MANUAL / AUTO			
RETURN<			Return to Main Menu	
EXPOSURE	BRIGHTNESS	0-100	50	Brightness Sets Luminance Target
	IRIS>	AUTO	AUTO	Automatic Gain Control
		MANUAL>	Closed to F28	Manual Iris
		RETURN<		Return to EXPOSURE Menu
	SHUTTER	A FLK	Use Anti-Flicker when lighting causes color hunting	
		ESC		
		MANUAL> 1/30 - 1/30,000 sec.		Shutter Speed
		RETURN<		Return to EXPOSURE Menu
	AGC	OFF / LOW / MED / HIGH	LOW	
		MANUAL (OFF)>		
	AGC VALUE 0 - 36dB	0 dB	Automatic Gain Control	
	RETURN<			
SSNR	OFF / LOW / MED / HIGH	LOW	Noise Reduction - Don't use above Low	
SENS-UP	OFF	OFF	OFF - Do not Use	
RETURN<			Return to Main Menu	

HD-20SE OSD Menu Structure (continued)

Menu	Controls	Range/Modes	Default	Notes
SPECIAL	DAY/NIGHT>	COLOR / B/W / AUTO	COLOR	Do not use
	DIS>	OFF / ON	OFF	Digital Image Stabilization - leave off
	DEFOG	OFF / ON / MANUAL/AUTO	OFF	Do not use
	COMM ADJUST>	BAUD RATE	NEVER CHANGE THE BAUD RATE OR THE UART SETTINGS - Control is lost if these are changed. Factory default reboot will be required. 	
		UART		
		RETURN<		Return to SPECIAL Menu
	IMAGE ADJUST>	H-REV ON / OFF	OFF	Use Dip Switch on Camera to Flip Image
		V-REV ON / OFF	OFF	Use Dip Switch on Camera to Flip Image
		SHARPNESS ON/OFF	ON	Picture Detail
		ON> 0-30	15	
		RETURN<		Return to IMAGE ADJUST Menu
		MONITOR LCD>		
		GAMMA .0 -1.0	0.50	
		COLOR LEVEL 0-100	50	
		RETURN<		Return to IMAGE ADJUST Menu
		USER>		
		GAMMA .0 - 1.0	0.50	
		COLOR LEVEL 0-100	50	
		RETURN<		Return to IMAGE ADJUST Menu
		RETURN<		Return to Main Menu
	DISPLAY	CAM TITLE ON / OFF	OFF	
		ON> A-Z, 1-9		
		RETURN<		Return to DISPLAY Menu
		CAM ID ON / OFF	OFF	
		CAM INFO ON / OFF	OFF	
		ZOOM MAG ON/OFF	OFF	
		OSD COLOR	WHITE	WHITE/YELLOW/GREEN/RED/BLUE
		LANGUAGE	ENGLISH	(ENG, FR, KOR, SP, CHIN, JAP, PORT, RUS, DUT, ITAL)
		SET LANGUAGE		
		RETURN<		Return to Main Menu
	VIDEO OUT FORM	COMPONENT ON / OFF	ON	Do not change this parameter
		RETURN<		Do not change resolutions here - Use the Rotary Switch on the back of the camera
RESET				
EXIT				



Inside Back Cover - Mostly Blank



Toll Free: 800-572-2011 ▪ Phone: 763-971-4400 ▪ FAX: 763-971-4464
www.vaddio.com