



Camera and Electronic Products for Integrators

Installation and User Guide

Vaddio™ ClearVIEW™ HD-18 High-Definition PTZ Camera



Model Number 999-6900-000 (North America)
Model Number 999-6900-001 (International)

Model Number 999-6900-000W (North America)
Model Number 999-6900-001W (International)
Arctic White Version



Vaddio ClearVIEW HD-18 Overview

With the ClearVIEW HD-18 integrated robotic PTZ camera, Vaddio continues to redefine image control. The camera is built around a 1.3 megapixel, 1/3" CCD with an 18x optical zoom lens, making it the ideal choice for a wide range of high definition video applications. In addition to the component HD output (720p, 1080i or 1080p), the camera comes with a simultaneous composite SD output (NTSC or PAL).

Because the camera module is built around a CCD image sensor, the HD-18 is excellent in low-light situations, with a 1.8 lux rating. In addition, the video signal to noise ratio output of the camera is greater than 50dB, delivering clean, clear video.



The multi-element Wide Dynamic Zoom lens allows ClearVIEW HD-18 to capture a wide angle of view (55.2°) enough to view everyone at a conference room table, as well as capture an individual from a long distance (3.2°). The zoom range provides greater flexibility for a wide variety of applications.

Pan range is +170 to -170 degrees, and Tilt range is -30 to +90 degrees. The camera is also invertible for ceiling-mount applications. A variety of accessories are available, allowing the camera to be installed in a variety of projects.

The ClearVIEW HD-18 is an exceptional camera for a wide range of high definition shooting applications, such as houses of worship, corporate boardrooms, live event production and distance-learning.

Intended Use:

Before operating the Vaddio ClearVIEW HD-18, please read the entire manual thoroughly. The system was designed, built and tested for use indoors, and with the provided power supply and cabling. The use of a power supply other than the one provided or outdoor operation has not been tested and could damage the camera and/or create a potentially unsafe operating condition.

Save These Instructions:

The information contained in this manual will help you install and operate your Vaddio ClearVIEW HD-18. If these instructions are misplaced, Vaddio keeps copies of Specifications, Installation and User Guides and most pertinent product drawings for the Vaddio product line on the Vaddio website. These documents can be downloaded from www.vaddio.com free of charge.

Important Safeguards:

Read and understand all instructions before using. Do not operate any device if it has been dropped or damaged. In this case, a Vaddio technician must examine the product before operating. To reduce the risk of electric shock, do not immerse in water or other liquids and avoid extremely humid conditions.



Use only the power supply provided with the ClearVIEW HD-18 system. Use of any unauthorized power supply will void any and all warranties.

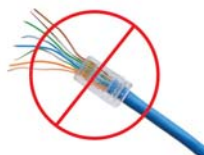

Do not use "pass-thru" RJ-45 connectors. Use standard RJ-45 connectors for best results.

UNPACKING:

Carefully remove the device and all of the parts from the packaging.
Unpack and identify the following parts:

- One (1) ClearVIEW HD-18 Camera
- One (1) Vaddio IR Remote Commander
- One (1) EZCamera™ Control Adapter (RJ-45 to DB-9)
- One (1) Vaddio PowerRite™ 12 VDC, 3 Amp Power Supply
- One (1) AC Cord Set (US or UK and Europe)
- Documentation and Manuals

Figure 2: ClearVIEW HD-18 camera (front)



1. Camera – A 1/3", 1.3 megapixel HD image sensor is combined with an 18x optical zoom lens, for capturing high-quality video.
2. Tally Light – A tally light is illuminated when the camera receives a VISCA command from an external control system and tally is triggered.
3. IR Sensors – Dual IR sensors are built into the front of the ClearVIEW HD-18 to receive IR signals from the IR remote control supplied with the camera.
4. Power Light – A power light is illuminated when the camera is turned on.

Compatible Switchers and Joystick Controllers:



ProductionVIEW™ HD
(999-5600-000)



ControlVIEW™ XHD
(999-5672-000)



Precision Camera Controller
(999-5700-000)

Figure 3: ClearVIEW HD-18 camera (back)



5. RS-232 In & IR Out – The RS-232 accepts VISCA protocol for camera control, as well as transmits IR signaling received by the IR receivers, which can be transmitted to third party devices.
6. DIP Switch Settings – Settings for IR remote, baud rate, SD output format, and image flip can be configured on these switches. See page 5 for additional information on switch settings.
7. HD Video Select – A rotary switch allows the user to choose the component HD output video resolution and format. See page 5 for additional information on switch settings.
8. 12 VDC Input – Power input for the standard, ClearVIEW HD-18 camera power supply.
9. YPbPr Video Output – Component HD video is fed through the DB-15 connector.
10. SD Video Output – Standard definition video is fed through the BNC connector.
11. EZ Power/Video Port – This RJ-45 connector is only used with the Quick-Connect Short Range break-out box.
12. Slot for Optional Cards – Optional slot cards can be plugged into the ClearVIEW HD-18 camera.

First Time Set-up with the ClearVIEW HD-18:

ClearVIEW HD-18 was designed to be exceptionally easy to use and operate. There is documentation at the back of the manual for pin-outs for all of the connectors on the ClearVIEW HD-18 camera.

Getting Started:

1. First, set up the HD and SD output resolutions for the camera, along with IR output, baud rate and image flip. See position settings on the following page for the switches that are found on the back of the camera (see 6 & 7 on Figure 3).

2. After configuring the output resolution and other settings, follow the sample diagram on the following page for connecting the camera to other peripheral equipment.
3. IR Remote Operation: Follow the instructions provided with the IR Remote for moving the camera, as well as setting preset camera positions.

Figure 5: Dip Switch and HD Video Output Resolution Setting Options for the ClearVIEW HD-18 Camera

DIP SWITCH SETTINGS										HD VIDEO SELECT				
IR 1 1 & 2 UP		IR OUT OFF		9600 bps	SD NTSC	SD 4:3 6 & 7 UP		IMAGE FLIP OFF	TEST BARS OFF	10 OFF	0	720p/59.94	8	576i/25
<input checked="" type="checkbox"/>	<input checked="" type="checkbox"/>	<input checked="" type="checkbox"/>	<input checked="" type="checkbox"/>	<input checked="" type="checkbox"/>	<input checked="" type="checkbox"/>	<input checked="" type="checkbox"/>	<input checked="" type="checkbox"/>	<input checked="" type="checkbox"/>	<input checked="" type="checkbox"/>	<input checked="" type="checkbox"/>	1	1080i/59.94	9	---
<input checked="" type="checkbox"/>	<input checked="" type="checkbox"/>	<input checked="" type="checkbox"/>	<input checked="" type="checkbox"/>	<input checked="" type="checkbox"/>	<input checked="" type="checkbox"/>	<input checked="" type="checkbox"/>	<input checked="" type="checkbox"/>	<input checked="" type="checkbox"/>	<input checked="" type="checkbox"/>	<input checked="" type="checkbox"/>	2	1080p/59.94	A	---
<input type="checkbox"/>	<input type="checkbox"/>	<input type="checkbox"/>	<input type="checkbox"/>	<input type="checkbox"/>	<input type="checkbox"/>	<input type="checkbox"/>	<input type="checkbox"/>	<input type="checkbox"/>	<input type="checkbox"/>	<input type="checkbox"/>	3	1080p/60	B	---
<input type="checkbox"/>	<input type="checkbox"/>	<input type="checkbox"/>	<input type="checkbox"/>	<input type="checkbox"/>	<input type="checkbox"/>	<input type="checkbox"/>	<input type="checkbox"/>	<input type="checkbox"/>	<input type="checkbox"/>	<input type="checkbox"/>	4	720p/50	C	---
<input type="checkbox"/>	<input type="checkbox"/>	<input type="checkbox"/>	<input type="checkbox"/>	<input type="checkbox"/>	<input type="checkbox"/>	<input type="checkbox"/>	<input type="checkbox"/>	<input type="checkbox"/>	<input type="checkbox"/>	<input type="checkbox"/>	5	1080i/50	D	---
<input type="checkbox"/>	<input type="checkbox"/>	<input type="checkbox"/>	38400 bps	SD PAL	SD SQ	SD LB	ON	ON	ON	ON	6	1080p/50	E	1080p/30
<input type="checkbox"/>	<input type="checkbox"/>	<input type="checkbox"/>	<input type="checkbox"/>	<input type="checkbox"/>	<input type="checkbox"/>	<input type="checkbox"/>	<input type="checkbox"/>	<input type="checkbox"/>	<input type="checkbox"/>	<input type="checkbox"/>	7	480i/29.97	F	1080p/25
1	2	3	4	5	6	7	8	9	10					

Note: The Test Bars are non standard, but are 75% YCbCr Color Bars and are intended as a convenience for testing the signal path only.

- IR 1, 2 & 3: These settings, using switches 1 & 2, determine the IR frequency of the IR remote control that was supplied with your camera. The IR remote has the capability of operating up to three different PTZ cameras from one remote, using the selector buttons at the top of the remote.
- IR Out: The IR output is sent on the RJ-45, RS-232 jack on the back of the camera. Turning on the IR output will allow IR signals to be transmitted over the CAT-5 cable.
- Baud Rate: The options for baud rate are either 9600 or 38,400 for RS-232.
- SD Output Frequency: Select either NTSC or PAL as the output for the camera's SD signal that is transmitted on the BNC connector.
- SD Output Size: Three options are available for the SD output, select from crop, squeeze or letterbox.
- Image Flip: Turning Image Flip on (switch down), will allow the camera to be inverted.
- Test Bars: Turning this switch on will override the camera video output and send test video bars from the camera.
- Switch 10: This switch is unused, and should be left in the OFF position.

RS-232 Cabling

For RS-232, use a standard CAT-5 cable (568B termination for RJ-45 connectors) from the RS-232 port on the back of a Vaddio ProductionVIEW camera controller or switcher. If the camera will be connected to a third-party control system (such as AMX or Crestron), a DB-9 to RJ-45 adapter is supplied with the camera for RS-232.

Videoconference Codecs and RS-232

Depending on the codec that is used, and which RS-232 port is used with a codec, special DB-9 to RJ-45 adapters may sometimes be required. Refer to Vaddio's website for Tech Notes on the ClearVIEW HD-18 page on specific diagrams for wiring the camera to videoconference codecs. Any special adapters and configuration information will be noted on the Tech Note.

Figure 6: Standard wiring configuration of the camera to a Vaddio Joystick controller.

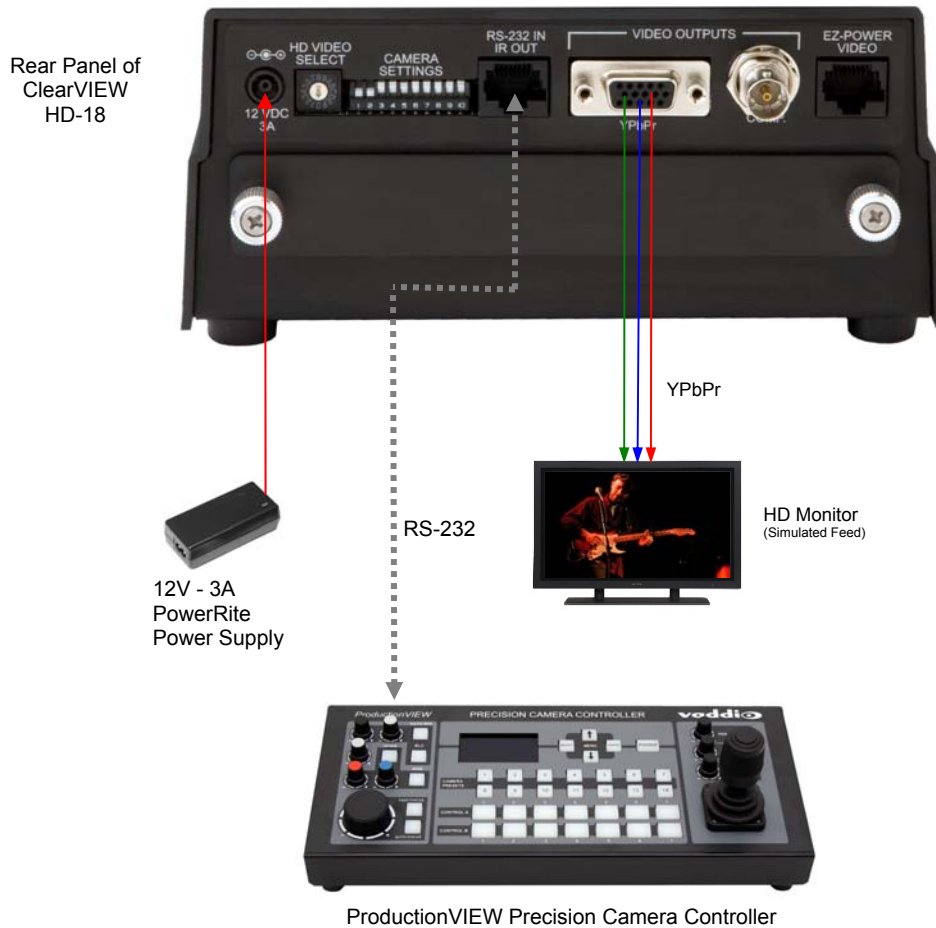

NOTE: Strain relief for the 15-pin connector on the back of the camera is highly recommended.

Optional Accessories



TANDBERG RS-232 Adapter
998-1002-232
Polycom RS-232 Adapter
998-1003-232
Polycom HDX 8000 Series Adapter
998-1006-232



15-pin to Male BNC output cable
440-5600-001 (3 ft.)
440-5600-002 (6 ft.)
440-5600-003 (7 inch.)



Wall Mount Bracket
535-2000-230

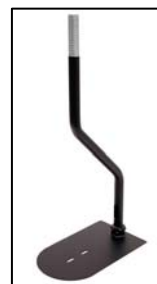

Drop Down Ceiling Mount
535-2000-296

Compliance and CE Declaration of Conformity



FCC Part 15 Compliance

This equipment has been tested and found to comply with the limits for a Class A digital device, pursuant to Part 15 of the FCC Rules. These limits are designed to provide reasonable protection against harmful interference when the equipment is operated in a commercial environment. This equipment generates, uses, and can radiate radio frequency energy and, if not installed and used in accordance with the instruction manual, may cause harmful interference to radio communications. Operation of this equipment in a residential area is likely to cause harmful interference in which case the user will be required to correct the interference at his/her own expense.

Operation is subject to the following two conditions: (1) This device may not cause interference, and (2) This device must accept any interference including interference that may cause undesired operation of the device.

Changes or modifications not expressly approved by Vaddio can affect emission compliance and could void the user's authority to operate this equipment.



ICES-003 Compliance

This digital apparatus does not exceed the Class A limits for radio noise emissions from digital apparatus set out in the Radio Interference Regulations of the Canadian Department of Communications.

Le présent appareil numérique n'émet pas de bruits radioélectriques dépassant les limites applicables aux appareils numériques de la classe A prescrites dans le Règlement sur le brouillage radioélectrique édicté par le ministère des Communications du Canada.



European Compliance

This product has been evaluated for Electromagnetic Compatibility under the EMC Directive for Emissions and Immunity and meets the requirements for a Class A digital device. In a domestic environment this product may cause radio interference in which case the user may be required to take adequate measures.

Standard(s) To Which Conformity Is Declared:

EMC Directive 2004/108/EC

EN 55022 A: 2006 + A1 2007 (CISPR 22:2005/A1:2005) Conducted and Radiated Emissions

- AS/NZS CISPR 22: 2006, Australia and New Zealand - Conducted and Radiated Emissions
- VCCI V-3/2009.04, Japan - Conducted and Radiated Emissions

EN 55024: 1998 + Amendments A1: 2001 + A2: 2003 - Electromagnetic Compatibility - Immunity

EN 61000-4-2 Electrostatic Discharge

EN 61000-4-3 Radiated Immunity

EN 61000-4-4 Electrical Fast Transients

EN 61000-4-5 Surge Immunity

EN 61000-4-6 Conducted Immunity

EN 61000-4-8 Power Frequency Magnetic Field

EN 61000-4-11 Voltage Dips, Interruptions and Fluctuations

Warranty Information:

Hardware* Warranty - One year limited warranty on all parts. Vaddio warrants this product against defects in materials and workmanship for a period of one year from the day of purchase from Vaddio. If Vaddio receives notice of such defects during the warranty period, they will, at their option, repair or replace products that prove to be defective.

Exclusions - The above warranty shall not apply to defects resulting from: improper or inadequate maintenance by the customer, customer applied software or interfacing, unauthorized modifications or misuse, operation outside the normal environmental specifications for the product, use of the incorrect power supply, improper extension of the power supply cable or improper site operation and maintenance.

Vaddio Customer service – Vaddio will test, repair, or replace the product or products without charge if the unit is under warranty and is found to be defective. If the product is out of warranty, Vaddio will test then repair the product or products. The cost of parts and labor charge will be estimated by a technician and confirmed by the customer prior to repair. All components must be returned for testing as a complete unit. Vaddio will not accept responsibility for shipment after it has left the premises.

Vaddio Technical support - Vaddio technicians will determine and discuss with the customer the criteria for repair costs and/or replacement. Vaddio Technical Support can be contacted through one of the following resources: e-mail support at support@vaddio.com or online at www.vaddio.com.

Return Material Authorization (RMA) number - Before returning a product for repair or replacement, request an RMA from Vaddio's technical support. Provide a technician with a return phone number, e-mail address, shipping address, and product serial numbers and describe the reason for repairs or returns as well as the date of purchase and proof of purchase. Include your assigned RMA number in all correspondence with Vaddio. Write your assigned RMA number on the outside of the box when returning the product.

Voided warranty – The warranty does not apply if the original serial number has been removed or if the product has been disassembled or damaged through misuse, accident, modifications, or unauthorized repair. Cutting the power supply cable on the secondary side (low voltage side) to extend the power to the device (camera or controller) voids the warranty for that device.

Shipping and handling - Vaddio will not pay for inbound shipping transportation or insurance charges or accept any responsibility for laws and ordinances from inbound transit. Vaddio will pay for outbound shipping, transportation, and insurance charges for all items under warranty but will not assume responsibility for loss and/or damage by the outbound freight carrier.

• If the return shipment appears damaged, retain the original boxes and packing material for inspection by the carrier. Contact your carrier immediately.

Products not under warranty - Payment arrangements are required before outbound shipment for all out of warranty products.

*Vaddio manufactures its hardware products from parts and components that are new or equivalent to new in accordance with industry standard practices.

Other General Information:

Care and Cleaning

Do not attempt to take this product apart at any time. There are no user-serviceable components inside.

- Do not spill liquids in the ClearVIEW HD-18
- Keep this device away from food and liquid
- For smears or smudges on the console, wipe with a clean, soft cloth with a light duty household cleaner that leaves no residue. Repeated use of a "Windex®" type product with vigorous pressure may remove some of the silk screening and this will void the warranty.
- Do not use any abrasive chemicals.

Operating and Storage Conditions:

Do not store or operate the ClearVIEW HD-18 under the following conditions:

- Temperatures above 40°C (104°F) or temperatures below 0°C (32°F)
- High humidity, condensing or wet environments or In inclement weather
- Dusty environments
- Under severe vibration

General Specifications:

ClearVIEW HD-18	
Part Numbers	ClearVIEW HD-18 999-6900-000 (North America), ClearVIEW HD-18W (Arctic white version - North America) 999-6900-000W ClearVIEW HD-18 999-6900-001 (INT'L) ClearVIEW HD-18W (Arctic white version - INT'L) 999-6900-001W
Image Device	1/3" CCD
Picture Elements	1.3 Megapixels
Signal System	HD: 1080p, 1080i or 720p @ 59.94; 1080p @ 60; 1080p, 1080i or 720p @ 50 SD: Composite NTSC or PAL (simultaneous in Crop, Squeeze or Letterbox mode)
Lens	18x Optical Zoom
Focal Length	f=4.7 to 84.6mm
Horizontal Viewing Angle	3.2 to 55.2 degrees (16:9)
Frame Delay	1 frame
Video S/N Ratio	>50 dB
Invertible	Yes
Minimum Illumination	1.8 lux
Control Protocol	VISCA & Vaddio
Serial Communication	RS-232 (9600 or 38,400)
Pan Range	+170 degrees to -170 degrees
Tilt Range	+90 degrees to -30 degrees
Pan/Tilt Speed	0.25° to 60° degrees/second
Preset Positions	16 (internal), 6 recalled via IR Remote
Weight	5.8 lbs. (2.63 kg.)

Appendix 1:

Video Pin-out Table for WallVIEW HD-18

Pin	YPbPr
1	Pr
2	Y
3	Pb
4	-
5	-
6	Pr GND
7	Y GND
8	Pb GND
9	-
10	-
11	-
12	-
13	-
14	-
15	-

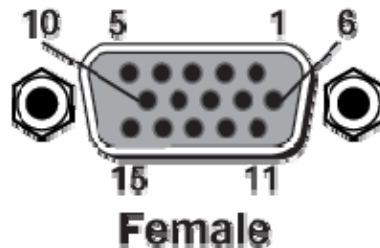

EZCamera Power & HD Video RJ-45 Connector Pin-outs

For HD-18 Camera and Quick-Connect HD-18 SR **ONLY** (568B Wiring Standard)

Pin	YPbPr
1	Power+
2	Power-
3	Y+
4	PB+
5	PB GND
6	Y GND
7	PR+
8	PR-

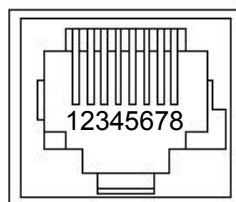

Appendix 2: ClearVIEW HD-18 Dimensions

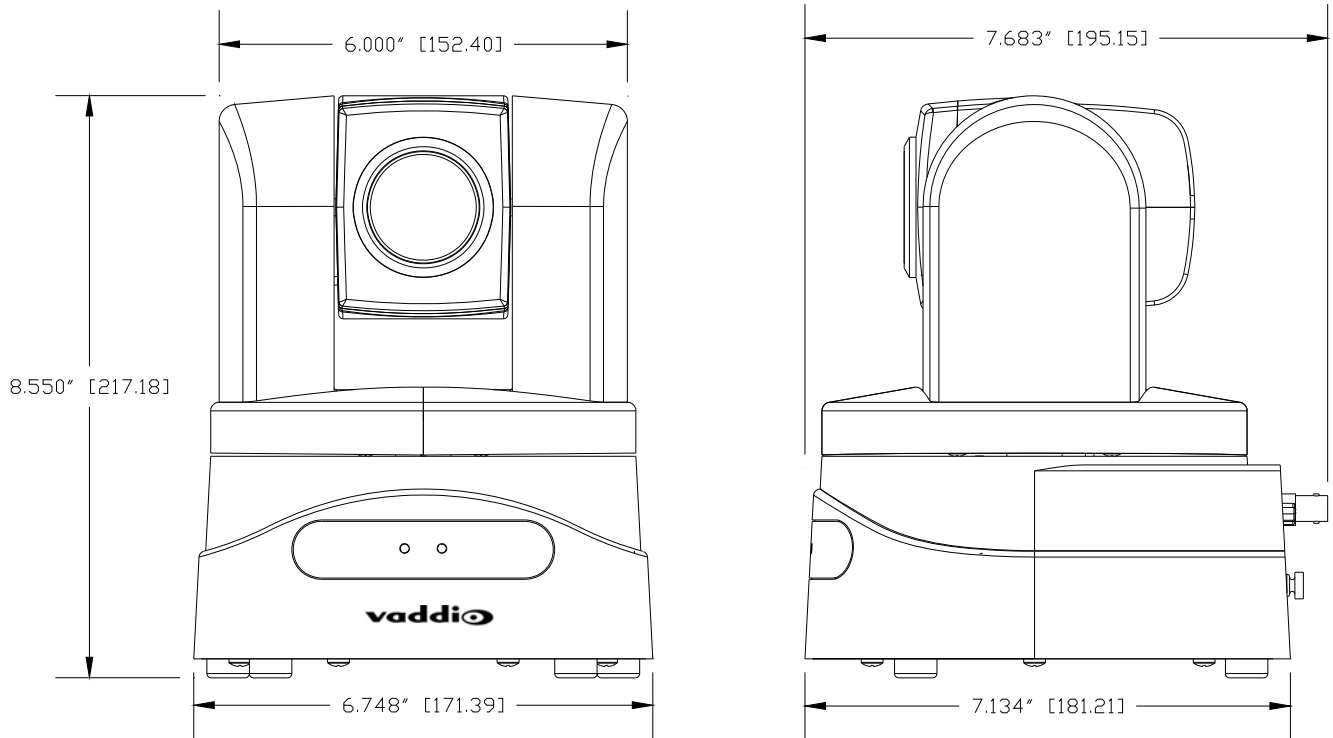

Appendix 3: Communication Specification

Communication Speed: 9600 bps (default)
 Start bit: 1
 Stop bit: 1
 Data bits: 8
 Parity: None
 No Flow control

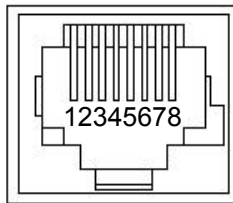

Pin #	RJ-45 RS-232 and IR Out Pins
1)	Unused
2)	Unused
3)	IR Out (TTL level)
4)	IR Output (Diff Signal to HD-18 Quick-Connect)
5)	IR Ground (Diff Signal to HD-18 Quick-Connect)
6)	GND (GND of IR Short Range - Pin 3)
7)	RXD (from TXD of control source)
8)	TXD (to RXD of control source)

NOTE: The Vaddio ClearVIEW HD-18 Control Protocol is similar, but not identical to the Sony™ VISCA™ command set in order to be compatible with several popular control devices. Not all VISCA commands are supported and there are many HD-18 specific commands in the following Command and Inquiry Lists.

HD-18 Command List (1/2)

Command Set	V	Command	Command Packet	Comments
AddressSet	Y	Broadcast	88 30 01 FF	Address Set
IF_Clear	Y	Broadcast	88 01 00 01 FF	I/F Clear
CommandCancel	Y		81 2p FF	p: Socket No(=1 to2)
CAM_Power	Y	On	81 01 04 00 02 FF	Power On/Off
	Y	Off	81 01 04 00 03 FF	
CAM_Zoom	Y	Stop	81 01 04 07 00 FF	p:0(Slow) to 7(Fast) p:0(Slow) to 7(Fast) pqrs: Zoom Position* V:(Speed) 0-7
	Y	Tele(Standard)	81 01 04 07 02 FF	
	Y	Wide(Standard)	81 01 04 07 03 FF	
	Y	Tele(Variable)	81 01 04 07 2p FF	
	Y	Wide(Variable)	81 01 04 07 3p FF	
	Y	Direct	81 01 04 47 0p 0q 0r 0s FF	
	Y	Direct(Variable)	81 01 7E 01 4A 0V 0p 0q 0r 0s FF	
CAM_Focus	Y	Stop	81 01 04 08 00 FF	Supported as 'Standard' Supported as 'Standard'
	Y	Far(Standard)	81 01 04 08 02 FF	
	Y	Near(Standard)	81 01 04 08 03 FF	
	Y	Far(Variable)	81 01 04 08 2p FF	
	Y	Near(Variable)	81 01 04 08 3p FF	
	Y	AutoFocus	81 01 04 38 02 FF	
	Y	ManualFocus	81 01 04 38 03 FF	
	Y	Auto/Manual	81 01 04 38 10 FF	
CAM_WB	Y	Auto	81 01 04 35 00 FF	
	Y	Manual	81 01 04 35 05 FF	
CAM_RGain	Y	Reset	81 01 04 03 00 FF	pqr:000-1ff
	Y	Up	81 01 04 03 02 FF	
	Y	Down	81 01 04 03 03 FF	
	Y	Direct	81 01 04 43 00 0p 0q 0r FF	
CAM_BGain	Y	Reset	8x 01 04 04 00 FF	pqr:000-1ff
	Y	Up	8x 01 04 04 02 FF	
	Y	Down	81 01 04 04 03 FF	
	Y	Direct	81 01 04 44 00 0p 0q 0r FF	
CAM_AE	Y	Full Auto	81 01 04 39 00 FF	Auto Exposure Mode Manual Control Mode Shutter Priority Mode Exposure Priority Mode (default) AGC Priority Mode
	Y	Manual	81 01 04 39 03 FF	
	Y	Shutter Priority	81 01 04 39 0A FF	
	Y	Iris Priority	81 01 04 39 0B FF	
	Y	Bright	81 01 04 39 0D FF	
CAM_Iris	Y	Reset	81 01 04 0B 00 FF	pq(0x00-0x11)
	Y	Up	81 01 04 0B 02 FF	
	Y	Down	81 01 04 0B 03 FF	
	Y	Direct	81 01 04 4B 00 00 0p 0q FF	
CAM_Gain	Y	Reset	81 01 04 0C 00 FF	pq(0x00-0x1E)
	Y	Up	81 01 04 0C 02 FF	
	Y	Down	81 01 04 0C 03 FF	
	Y	Direct	81 01 04 4C 00 00 0p 0q FF	

HD-18 Command List (2/2)

Command Set	V	Command	Command Packet	Comments	
CAM_Backlight	Y	On	81 01 04 33 02 FF		
	Y	Off	81 01 04 33 03 FF		
CAM_Aperture	Y	Reset	81 01 04 02 00 FF		
	Y	Up	81 01 04 02 02 FF		
	Y	Down	81 01 04 02 03 FF		
	Y	Direct	81 01 04 42 00 00 0p 0q FF	pq(0x00-0x3F)	
CAM_Memory	Y	Reset	81 01 04 3F 00 0p FF	p:Memory No(=0-0xf)	
	Y	Set	81 01 04 3F 01 0p FF		
	Y	Recall	81 01 04 3F 02 0p FF		
CAM_IDWrite	Y		81 01 04 22 0p 0q 0r 0s FF	pqrs:Camera ID(=0000 – FFFF)	
IR_Receive	Y	On	81 01 06 08 02 FF		
	Y	Off	81 01 06 08 03 FF		
	Y	On/Off	81 01 06 08 10 FF		
IR_ReceiveReturn	N+	On	81 01 7D 01 03 00 00 FF		
	N+	Off	81 01 7D 01 13 00 00 FF		
Pan-tiltDrive	Y	Up	81 01 06 01 VV WW 03 01 FF	WW: Pan Speed (0x01-0x18) VV:Tilt Speed(0x01-0x14)	
	Y	Down	81 01 06 01 VV WW 03 02 FF		
	Y	Left	81 01 06 01 VV WW 01 03 FF		
	Y	Right	81 01 06 01 VV WW 02 03 FF		
	Y	UpLeft	81 01 06 01 VV WW 01 01 FF		
	Y	UpRight	81 01 06 01 VV WW 02 01 FF		
	Y	DownLeft	81 01 06 01 VV WW 01 02 FF		
	Y	DownRight	81 01 06 01 VV WW 02 02 FF		
	Y	Stop	81 01 06 01 VV WW 03 03 FF		
	Y	Absolute Position	81 01 06 02 VV WW 0Y 0Y 0Y 0Y 0Z 0Z 0Z 0Z FF 0Y 0Y 0Y 0Y 0Z 0Z 0Z 0Z FF		YYYY: Pan Position* ZZZZ: Tilt Position*
	Y				
	Y	Home Reset	81 01 06 04 FF 81 01 06 05 FF		
	Tally	Y	On		81 01 7E 01 0A 00 02 FF
Y		Off	81 01 7E 01 0A 00 03 FF		
Preset Pan Speed	Y	Pan/Tilt Speed	81 01 7E 01 0B WW VV ZZ FF	WW: Pan Speed (0x01-0x18) VV:Tilt Speed(0x01-0x14) ZZ:Zoom Speed(0-7);	
Motor Config	Y	Hard Motor Stops	81 01 7E 01 70 00 00 FF		
	Y	Soft Motor Stops	81 01 7E 01 70 00 01 FF		
BLK.Enhance	Y	Pedestal	81 01 7E 53 00 00 0p 0q FF	pq: Black Level (0x01-0xFD)	
GMA.Enhance	Y	Gamma	81 01 7E 54 00 00 0p 0q FF	pq: Gamma (0x00-0x8F)	
CRM.Enhance	Y	Chroma	81 01 7E 55 00 00 0p 0q FF	pq: Chroma (0x08-0x1F)	
KNE.Enhance	Y	Knee	81 01 7E 55 00 00 0p 0q FF	pq: Knee (0x0-07F)	
CAM_Shutter	Y	Reset	81 01 04 0A 00 FF	(Only supported in Shutter Priority Mode)	
	Y	Up	81 01 04 0A 02 FF		
	Y	Down	81 01 04 0A 03 FF		
	Y	Direct	81 01 04 4A 00 00 0p 0q FF		
CAM_ExpComp	Y	On	81 01 04 3E 02 FF	AutoExposure Off	
	Y	Off	81 01 04 3E 03 FF	AutoExposure On	
	Y	Reset	81 01 04 0E 00 FF		
	Y	Up	81 01 04 0E02 FF		
	Y	Down	81 01 04 0E 03 FF		
	Y	Direct	81 01 04 4E 00 00 0p 0q FF	Pq: 0x00-0x1E	
CAM_ICR Cut Filter	Y	ICR On	81 01 04 01 02 FF	ICR On	
	Y	ICR Off	81 01 04 01 03 FF	ICR Off	

Additional Information:

Pan Range: 8044 – 7FBC (-32,700 to +32,700)

Tilt Range: E891 – 4C2B (-5,999 to +19,499)

* Actual Pan/Tilt ranges defined in Inquiry list

HD-18 Inquiry List (1/1)

Inquiry Command	V	Command	Command Packet	Comments
CAM_PowerInq	Y	81 09 04 00 FF	y0 50 02 FF y0 50 03 FF	On Off(Standby)
CAM_ZoomPosInq	Y	81 09 04 47 FF	y0 50 0p 0q 0r 0s FF	pqr: Zoom Position
CAM_WBModelInq	Y	81 09 04 35 FF	y0 50 00 FF y0 50 05 FF	Auto Manual
CAM_RGain	Y	81 09 04 43 FF	y0 50 00 0p 0q 0r FF	pqr:000-1ff
CAM_BGain	Y	81 09 04 44 FF	y0 50 00 0p 0q 0r FF	pqr:000-1ff
CAM_AEModelInq	Y	81 09 04 39 FF	y0 50 00 FF y0 50 03 FF	Auto Exposure Mode Manual Control Mode
CAM_Iris	Y	81 09 04 4B FF	y0 50 00 00 0p 0q FF	pq(0x00-0x11)
CAM_Gain	Y	81 09 04 4C FF	y0 50 00 00 0p 0q FF	pq(0x00-0x1E)
CAM_BacklightModelInq	Y	81 09 04 33 FF	y0 50 02 FF y0 50 03 FF	On Off
CAM_ApertureInq	Y	81 09 04 42 FF	y0 50 00 00 0p 0q FF	pq(0x00-0x3F)
CAM_MemoryInq	Y	81 09 04 3F FF	y0 50 0p FF	p:Memory No(=0-0xf)
CAM_IDInq	Y	81 09 04 3F FF	y0 50 0p 0q 0r 0s FF	pqrs:(0000 – FFFF)
CAM_ReceiveInq	Y	81 09 06 08 FF	y0 50 02 FF y0 50 03 FF	On Off
Pan-TiltMaxSpeedInq	Y	81 09 06 11 FF	y0 50 WW VV FF	WW: Pan Speed (0x01-0x18) VV:Tilt Speed(0x01-0x14)
Pan-tiltPositionInq	Y	81 09 06 12 FF	y0 50 0Y 0Y 0Y 0Y 0Z 0Z 0Z 0Z FF	YYYY: Pan (0x0100-0x1800) ZZZZ:Tilt (0x0100-0x1400)
TallyInq	Y Y	81 09 7E 01 0A FF	y0 50 02 FF y0 50 03 FF	On Off
PresetSpeedInq	Y	81 09 7E 01 0B FF	y0 50 WW VV ZZ FF	WW: Pan Speed (0x01-0x18) VV:Tilt Speed(0x01-0x14) ZZ:Zoom Speed(0-7);
Motor Config	Y	81 09 7E 01 70 FF	y0 50 00 FF y0 50 01 FF	Hard Motor Stops Soft Motor Stops
BLK.Enhance	Y	81 01 7E 53 FF	y0 50 00 00 0p 0q FF	pq: Black Level (0x01-0xFD)
GMA.Enhance	Y	81 01 7E 54 FF	y0 50 00 00 0p 0q FF	pq: Gamma (0x00-0x8F)
CRM.Enhance	Y	81 01 7E 55 FF	y0 50 00 00 0p 0q FF	pq: Chroma (0x08-0x1F)
KNE.Enhance	Y	81 01 7E 56 FF	y0 50 00 00 0p 0q FF	pq: Knee (0x0-07F)
CAM_AEModelInq	Y	81 09 04 39 FF	y0 50 00 FF y0 50 03 FF y0 50 0A FF y0 50 0B FF y0 50 0D FF	Auto Exposure Mode Manual Control Mode Shutter Priority Mode Exposure Priority Mode AGC Priority Mode
CAM_ShutterPosInq	Y	81 09 04 4A FF	y0 50 00 00 0p 0q FF	pq: ShutterPosition (Only supported in Shutter Priority Mode)
CAM_ExpCompModelInq	Y	81 09 04 3E FF	y0 50 02 FF y0 50 03 FF	On - AE Mode Off Off – AE Mode On
CAM_ExpCompPosInq	Y	81 09 04 4E FF	y0 50 00 00 0p 0q FF	pq: ExpComp Pos -Iris Position
CAM_ICRModelInq	Y	81 09 04 01 FF	y0 50 02 FF y0 50 03 FF	ICR On ICR Off



9433 Science Center Drive, Minneapolis, MN 55428
Toll Free: 800-572-2011 ▪ Phone: 763-971-4400 ▪ FAX: 763-971-4464
www.vaddio.com

©2010 Vaddio - All Rights Reserved. Reproduction in whole or in part without written permission is prohibited. Specifications and pricing are subject to change without notice. Vaddio, ProductionVIEW, ClearVIEW, EZCamera, ControlVIEW and PowerRite are registered trademarks of Vaddio. All other trademarks are property of their respective owners. Document Number 341-885 Rev C.