



Installation Guide for the

OneLINK Bridge

AV Interface

Document 411-0009-31 Rev E
November 2019

Contents

Overview	1
What's in this Guide	2
Features	2
Unpacking the OneLINK Bridge AV Interface	3
OneLINK Bridge for HDBaseT Cameras	3
OneLINK Bridge For HDBaseT Cameras Used with Codecs	3
OneLINK Bridge For HDMI Cameras	4
OneLINK Bridge For HDMI Cameras Used with Codecs	5
A Quick Look at the OneLINK Device	8
Front Panel of the Receiver	8
Connector Panel of the Receiver	8
Connector Panel of the EZCamera Interface Module (EZIM)	9
Installing the OneLINK Device	10
Don't Void Your Warranty!	10
Cabling Notes	10
RS-232 Connector Pin-Outs	11
Mounting the OneLINK Device	11
About Installations Using the Half-Recessed Ceiling Mount	11
Visual Conventions for Connection Diagrams	12
Connections for HDBaseT Cameras	12
Kits and Systems for HDBaseT Cameras	12
Connecting a Vaddio HDBaseT Camera	13
Connections for HDBaseT Cameras Used with Codecs	14
Kits for HDBaseT Cameras Used with Codecs	14
Connecting a Vaddio HDBaseT Camera and Polycom Codec	15
Connecting a Vaddio HDBaseT Camera and Cisco Codec	17
Connections for HDMI Cameras	21
Kits for HDMI Cameras	21
Connecting a RoboSHOT HDMI Camera	22
Connecting a Polycom EagleEye IV Camera	23
Connecting a Cisco Camera	24
Connecting a Sony or Panasonic HDMI Camera	26
Connections for HDMI Cameras Used with Codecs	28
Kits for HDMI Cameras Used with Codecs	28
Connecting a RoboSHOT HDMI Camera and Polycom Codec	29
Connecting a Polycom EagleEye IV Camera and Polycom Codec	31
Connecting a RoboSHOT HDMI Camera and Cisco Codec	33
Connecting a Cisco Camera and Codec	37
Powering Up the Equipment	43
Next Steps	43

Operation, Storage, and Care	43
Compliance Statements and Declarations of Conformity	44
FCC Part 15 Compliance	44
ICES-003 Compliance	44
European Compliance	45
Warranty Information	46
Index	47

Overview

This guide covers the OneLINK™ Bridge AV Interface, which is available in the following kit configurations for use with Vaddio or third-party cameras, with or without third-party codecs.

- 999-9595-000/001/009, OneLINK Bridge AV interface
- 999-9620-000/001/009, OneLINK Bridge AV interface for Polycom EagleEye IV cameras with Polycom codecs
- 999-9630-000/001/009, OneLINK Bridge AV interface for Sony and Panasonic cameras
- 999-9560-000/001/009, OneLINK Bridge AV interface for RoboSHOT HDMI cameras with Polycom codecs (*discontinued*)
- 999-9645-000/001/009, OneLINK Bridge AV interface for Vaddio HDBaseT cameras with Polycom codecs
- 999-9660-000/001/009, OneLINK Bridge AV interface for Cisco cameras with Cisco codecs
- 999-9670-000/001/009, OneLINK Bridge AV interface for RoboSHOT HDMI cameras with Cisco codecs (*camera has been discontinued*)
- 999-9675-000/001/009, OneLINK Bridge AV interface for Vaddio HDBaseT cameras with Cisco codecs
- 999-9690-000/001, OneLINK Bridge AV interface for RoboSHOT HDMI cameras (*camera has been discontinued*)

Part number suffixes indicate power cord set types. Those ending in -000 include cord sets for use in North America; -001 kits include cord sets for use in Europe and the UK; -009 kits include cord sets for use in Australia and New Zealand.

The OneLINK Bridge AV interface is also available as a component of several Vaddio camera systems.

Note

*The kits for RoboSHOT HDMI cameras are still available, although the RoboSHOT 12 HDMI and RoboSHOT 30 HDMI cameras have been discontinued. **OneLINK devices are not compatible with RoboSHOT 12E HDMI and RoboSHOT 30E HDMI cameras.***



If the camera extension is sold for use with an HDMI camera, it is shipped with a OneLINK EZCamera Interface Module (EZIM).



What's in this Guide

This guide provides information about:

- Unpacking the OneLINK device
- The OneLINK device's physical features
- Installing the OneLINK device
- Initial power-on
- Warranty and compliance/conformity information

Complete product information is available in the **Complete Manual for the OneLINK Bridge AV Interface**.

Features

- Vaddio's market-leading AV Bridge functionality converts any conference room to a BYOD environment, connecting professional AV equipment and delivering a USB 3.0 audio and video stream for soft-conferencing clients
- Two balanced audio inputs, line level or mic level; two balanced audio outputs, line level
- Simultaneous uncompressed USB 3.0, HDMI 1.4b, and 3Gb/s HD-SDI; passes IP stream if available from source
- Administrative control via web interface; passes web, Telnet, and RS-232 serial control to connected devices
- Simple, clutter-free camera installation – power, control, video, and streaming over one cable
- Extends installation distance for HDMI and HDBaseT™ cameras up to 100 m (328 ft.) using Cat-6 cable; 230 ft (70 m) using Cat-5e
- Compatible with Vaddio HDBaseT cameras – no EZCamera Interface Module (EZIM) needed
- Compatible with legacy RoboSHOT HDMI and other HDMI cameras
- Available in system configurations with Vaddio cameras; kits available for use with Polycom and Cisco codecs

Note

OneLINK products are not compatible with RoboSHOT 12E HDMI or RoboSHOT 30E HDMI cameras.

Unpacking the OneLINK Bridge AV Interface

Make sure you received all the items you expected. Here are the packing lists for the OneLINK Bridge kits. Every OneLINK device ships with a power supply and at least one AC cord set. The last three digits of the kit part number contain the regional code that specifies which cord set(s). For most OneLINK kits, the part numbers follow this convention:

- Kits with part numbers ending in -000 include one AC cord set for North America.
- Kits with part numbers ending in -001 include two AC cord sets, one for Europe and one for the UK.
- Kits with part numbers ending in -009 include one AC cord set for Australia and New Zealand.

OneLINK Bridge for HDBaseT Cameras

OneLINK Bridge AV Interface for Vaddio HDBaseT Cameras, 999-9595-000/001/009

Camera not included.

- OneLINK Bridge AV interface
- Power supply, 48 VDC/1.36 A, with AC cord set(s)
- USB 3.0 A to B cable, 6 ft. (1.8 m)
- 3-position Phoenix connector plug, 3.5 mm, qty. 4
- EZCamera RS-232 control adapter (998-1001-232)
- Quick-Start Guide 411-0009-01



OneLINK Bridge For HDBaseT Cameras Used with Codecs

OneLINK Bridge for Vaddio HDBaseT Cameras with Polycom Codecs, 999-9645-000/001/009

Camera and codec not included.

- OneLINK Bridge AV interface
- Power supply, 48 VDC/1.36 A, with AC cord set(s)
- USB 3.0 A to B cable, 6 ft. (1.8 m)
- 3-position Phoenix connector plug, 3.5 mm (qty. 4)
- Fan-out cable, codec side, 2 ft. (0.6 m)
- EZCamera RS-232 control adapter 998-1001-232
- Quick-Start Guide 411-0009-01



OneLINK Bridge for Vaddio HDBaseT Cameras with Cisco Codecs, 999-9675-000/001/009

Camera and codec not included.

Note

If connecting to a Cisco SX20 codec, you will need to provide a Cisco split cable, Cisco part number CAB-PHD4XS2-SPLIT.

- OneLINK Bridge AV interface
- Power supply, 48 VDC/1.36 A, with AC cord set(s)
- USB 3.0 A to B cable, 6 ft. (1.8 m)
- 3-position Phoenix connector plug, 3.5 mm (qty. 4)
- HDMI cable, 3 ft. (0.9 m)
- Custom-pinout Cat-5e cable for Cisco, 3 ft. (0.9 m)
- Cat-5e patch cable, 3 ft. (0.9 m)
- EZCamera RS-232 control adapter 998-1002-232
- Quick-Start Guide 411-0009-01



OneLINK Bridge For HDMI Cameras

OneLINK Bridge for RoboSHOT HDMI Cameras, 999-9690-000/001/009

Camera not included.

- OneLINK Bridge AV interface
- OneLINK EZCamera Interface Module (EZIM) with mounting screws
- Power supply, 48 VDC/1.36 A, with AC cord set(s)
- USB 3.0 A to B cable, 6 ft. (1.8 m)
- 3-position Phoenix connector plug, 3.5 mm, qty. 4
- Power cable EIAJ-04 to EIAJ-04, 1 ft. (0.3 m)
- HDMI cable, 1 ft. (0.3 m)
- Cat-5e patch cable, 1 ft. (0.3 m), qty. 2
- EZCamera RS-232 control adapter
- Quick-Start Guide 411-0009-02



Note

The RoboSHOT 12 HDMI and RoboSHOT 30 HDMI cameras have been discontinued. This kit is not compatible with RoboSHOT 12E HDMI and RoboSHOT 30E HDMI cameras.

OneLINK Bridge for Sony and Panasonic Cameras, 999-9630-000/001/009

Camera not included.

- OneLINK Bridge AV interface
- OneLINK EZCamera Interface Module (EZIM)
- Power supply, 48 VDC/1.36 A, with AC cord set(s)
- USB 3.0 A to B cable, 6 ft. (1.8 m)
- 3-position Phoenix connector plug, 3.5 mm, qty. 4
- Wall mount with mounting hardware for Sony and Panasonic cameras
- Power cable EIAJ-04 to EIAJ-04, 1 ft. (0.3 m)
- Power cable EIAJ-04 to 3x6.3mm, 1 ft. (0.3 m)
- HDMI cable, 1 ft. (0.3 m)
- RJ-45 to 8-pin mini-DIN cable, 1 ft. (0.3 m)
- Cat-5e patch cable, 1 ft. (0.3 m)
- Quick-Start Guide 411-0009-02



OneLINK Bridge For HDMI Cameras Used with Codecs

OneLINK Bridge for Polycom Cameras with Polycom Codecs, 999-9620-000/001/009

Camera and codec not included.

- OneLINK Bridge AV Interface
- OneLINK EZCamera Interface Module (EZIM)
- Power supply, 48 VDC/1.36 A, with AC cord set(s)
- Wall mount with mounting hardware for Polycom codec and camera
- USB 3.0 A to B cable, 6 ft. (1.8 m)
- 3-position Phoenix connector plug, 3.5 mm, qty. 4
- Fan-out cable, EZIM side, 1 ft. (0.3 m)
- Fan-out cable, codec side, 2 ft. (0.6 m)
- EZCamera RS-232 control adapter 998-1001-232
- Quick-Start Guide 411-0009-02



OneLINK Bridge for RoboSHOT HDMI with Polycom Codecs, 999-9640-000/001/009

Camera and codec not included.

- OneLINK Bridge AV interface
- OneLINK EZCamera Interface Module (EZIM)
- Power supply, 48 VDC/1.36 A, with AC cord set(s)
- USB 3.0 A to B cable, 6 ft. (1.8 m)
- 3-position Phoenix connector plug, 3.5 mm, qty. 4
- Fan-out cable, codec side, 2 ft. (0.6 m)
- Cat-5e patch cable, 1 ft. (0.3 m), qty. 2
- HDMI cable, 1 ft. (0.3 m)
- Power cable EIAJ-04 to EIAJ-04, 1 ft. (0.3 m)
- Quick-Start Guide 411-0009-02



Note

The RoboSHOT 12 HDMI and RoboSHOT 30 HDMI cameras have been discontinued. This kit is not compatible with RoboSHOT 12E HDMI and RoboSHOT 30E HDMI cameras.

OneLINK Bridge for Cisco Cameras with Cisco Codecs, 999-9660-000/001/009

Camera and codec not included.

Note

If connecting to a Cisco SX20 codec, you will need to provide a Cisco split cable, Cisco part number CAB-PHD4XS2-SPLIT. This cable is also required when connecting to a Cisco Precision 40 or Precision HD 1080p2.5x camera; you will need two of them if connecting one of these cameras and an SX20 codec.

- OneLINK Bridge AV Interface
- OneLINK EZCamera Interface Module (EZIM) with mounting screws
- Power supply, 48 VDC/1.36 A, with AC cord set(s)
- Wall mount with mounting hardware for Cisco codec and camera
- USB 3.0 A to B cable, 6 ft. (1.8 m)
- 3-position Phoenix connector plug, 3.5 mm, qty. 4
- Power cable EIAJ-04 to 5.5x2.1 mm, 1 ft. (0.3 m)
- HDMI cable, 1 ft. (0.3 m)
- HDMI cable, 3 ft. (0.9 m)
- Custom-pinout Cat-5e cable for Cisco cameras, 1 ft. (0.3 m)
- Custom-pinout Cat-5e cable for Cisco SX20, 3 ft. (0.9 m)
- Cat-5e patch cable, 1 ft. (0.3 m)
- Cat-5e patch cable, 3 ft. (0.9 m)
- EZCamera RS-232 control adapter 998-1002-232
- Quick-Start Guide 411-0009-02



OneLINK Bridge for RoboSHOT HDMI with Cisco Codecs, 999-9670-000

Camera and codec not included.

Note

If connecting to a Cisco SX20 codec, you will need to provide a Cisco split cable, Cisco part number CAB-PHD4XS2-SPLIT.

- OneLINK Bridge AV Interface
- OneLINK EZCamera Interface Module (EZIM) with mounting screws
- Power supply, 48 VDC/1.36 A, with AC cord set(s)
- USB 3.0 A to B cable, 6 ft. (1.8 m)
- 3-position Phoenix connector plug, 3.5 mm, qty. 4
- Power cable EIAJ-04 to EIAJ-04, 1 ft. (0.3 m)
- HDMI cable, 1 ft. (0.3 m)
- HDMI cable, 3 ft (0.9 m)
- Custom-pinout Cat-5e cable for Cisco, 3 ft. (0.9 m)
- Cat-5e patch cable, 1 ft. (0.3 m), qty. 2
- Cat-5e patch cable, 3 ft. (0.9 m)
- EZCamera RS-232 control adapter 998-1002-232
- Quick-Start Guide



Note

The RoboSHOT 12 HDMI and RoboSHOT 30 HDMI cameras have been discontinued. This kit is not compatible with RoboSHOT 12E HDMI and RoboSHOT 30E HDMI cameras.

A Quick Look at the OneLINK Device

This section covers the physical features of the OneLINK Bridge AV interface.

All OneLINK kits include a receiver, which is typically co-located with other equipment, up to 328 ft (100 m) away from the camera. OneLINK kits for use with HDMI cameras also include an EZCamera Interface Module (EZIM) HDBaseT converter, which is mounted adjacent to the camera.

Front Panel of the Receiver



- **USB** indicator – Illuminates when a USB stream is present.
- **Network** indicator – Illuminates when connected to the IP network.
- **Source** indicator – Illuminates when a video input is detected.
- **OneLINK** indicator – Illuminates when the OneLINK Bridge detects a connection to an HDBaseT device or to the OneLINK EZIM.
- **Display IP and MAC Address** button (illuminated blue) – Outputs the OneLINK Bridge IP and MAC addresses as an overlay on the HDMI, HD-SDI, and USB video outputs.
- **Power System Reset** button (illuminated red) – reboots the OneLINK Bridge without affecting the connected camera.

Connector Panel of the Receiver



From the left:

- **Power input jack** – Use the supplied 48VDC, 1.36A power supply.
- **OneLINK interface port** – Connect a Cat-5e (or better) cable to the EZIM, or to the camera if your OneLINK kit or system did not include an EZIM. This bidirectional connection carries video, audio (if available), network connectivity including H.264 IP streaming from the camera (if available), RS-232 control, and 12 VDC power.
- **HDMI output** – HDMI output to a connected display.
- **USB 3.0** – Uncompressed video output with PCM audio for conferencing applications
- **HD-SDI** – Video output from the camera
- **Network port** – H.264 IP streaming (if available from the camera), web interface access, and third-party IP control via Telnet API.
- **RS-232 port** – Connect to a camera controller.
- **Audio I/O Line Out 1 and Line Out 2** – Far-end audio from conferencing application or as configured in the audio matrix
- **Audio I/O Mic/Line In 1 and Mic/Line In 2** – Microphone or other audio inputs

Connector Panel of the EZCamera Interface Module (EZIM)

If the OneLINK device is used with an HDMI camera, the EZIM is required.



From the left:

- **Power output jack** – Supplies power to the camera. The kit you purchased includes the appropriate cable to connect your camera's power input to this jack.
- **Network port** – Provides network connectivity to the camera for H.264 IP streaming (if available from the camera), web interface access, and third-party control via Telnet API. Connect to the camera's network port.
- **RS-232 port** – Provides RS-232 connectivity to the camera, for third-party control. The kit you purchased may include a cable and/or an RS-232 adapter to connect to the camera's RS-232 port.
- **HDMI input** – Receives HDMI video from the camera. Connect to the camera's HDMI output.
- **OneLINK port** – Single-cable connection to the OneLINK receiver. This bidirectional connection carries all video, power, and control.

Installing the OneLINK Device

This section covers:

- Things to know before you start the installation
- Basic connection examples

Download dimensional drawings, quick-start guides, and other information from the appropriate OneLINK kit page on legrandav.com.

Don't Void Your Warranty!

Caution

Use only the power supply included with this product. Using a different one will void the warranty, and could create unsafe operating conditions or damage the product.

Do not connect the OneLINK power supply to a Vaddio camera. It does not provide the correct voltage for Vaddio cameras, and will damage the camera and void the camera's warranty.

This product is for indoor use only. Do not install it outdoors or in a humid environment. Do not allow it to come into contact with any liquid. Do not install or operate this product if it has been dropped, damaged, or exposed to liquids. If any of these things happen, return it to Vaddio for safety and functional testing.

Note

Disassembling this product will void the warranty.

Cabling Notes

Cable distance between the EZIM (or the camera, if no EZIM is used) and the OneLINK device is a maximum of 328 feet (100 m) using Cat-6 or Cat-7 cable, or 230 feet (70 m) using Cat-5e cable.

Cat-6 or Cat-7 cabling allows longer maximum cabling distance, and may provide better performance in noisier RF or EMF environments. We recommend shielded cabling if the cables will be coiled, run tightly with other cables, or routed near sources of electromagnetic interference such as power lines or fluorescent light fixtures. When in doubt, use shielded Cat-6 cable.

Caution

When making cables for Vaddio products, do not use pass-through RJ-45 connectors. If they are crimped incorrectly, they can damage the connectors on the product, cause intermittent connections, and degrade signal quality. Physical damage to the connectors will void your warranty.



Intact

Contact fingers will make reliable contact with the cable connector



Damaged

Some contact fingers are bent and will NOT make reliable contact with the cable connector

We recommend using high-quality connectors and a high-quality crimping tool.



Pro Tip

To prevent tragic mishaps, label both ends of every cable.

RS-232 Connector Pin-Outs

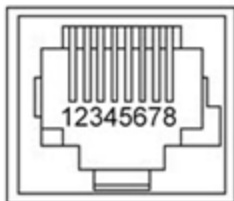

OneLINK Receiver - RS-232 Control Port

1. Unused
2. Unused
3. Unused
4. Unused
5. Unused
6. GND – green
7. RX (from TX of controller) – brown/white
8. TX (to RX of controller) – brown

OneLINK EZIM - RS-232 Control Port

1. Unused
2. Unused
3. Unused
4. IR GND
5. IR (non-mod)
6. GND – green
7. TX (to RX of camera) – brown/white
8. RX (from TX of camera) – brown

Note

Vaddio recommends adhering to the 568B cabling standard for Cat-5 cabling.

Mounting the OneLINK Device

If you are installing the OneLINK device with a OneLINK EZIM, mount the EZIM with or near the camera. The Thin Profile Wall Mount for the camera may include mounting holes to attach the EZIM to the underside of the mount using two 6-32 screws. Connect all required cables during camera installation. Rack and under-table mounting kits are available for the receiver. Follow the mounting instructions supplied with the kit.

About Installations Using the Half-Recessed Ceiling Mount

If the connected camera is mounted in Vaddio's Half-Recessed Ceiling Mount, the camera's IR receiver is unable to receive signals from the remote. The mount has an IR receiver that can forward commands to the camera; this must be powered separately using Power Extension Module 999-1005-021. Cameras powered by OneLINK devices cannot supply power to the mount's IR receiver.

Visual Conventions for Connection Diagrams

The following sections provide representative connection diagrams for the various OneLINK kit and system configurations available. All diagrams in this guide use these visual conventions for connection type.



Connections for HDBaseT Cameras

In this configuration, the OneLINK Bridge extends network connectivity, power, and control to an HDBaseT camera, and brings HDMI video from the camera to a display. The camera can optionally be controlled by a camera controller on an RS-232 serial connection to the OneLINK Bridge or over the network, depending on the controller. The OneLINK Bridge also provides connections for microphones and speakers, and can originate a USB stream to bridge the non-USB camera and audio equipment into a USB-based conferencing application.

If an IP stream is available from the camera, the OneLINK device passes it to the network. IP streaming resolutions up to 2160p/30 are supported. HDMI output resolution and streaming parameters (including resolution) are configured on the camera, not the OneLINK device.

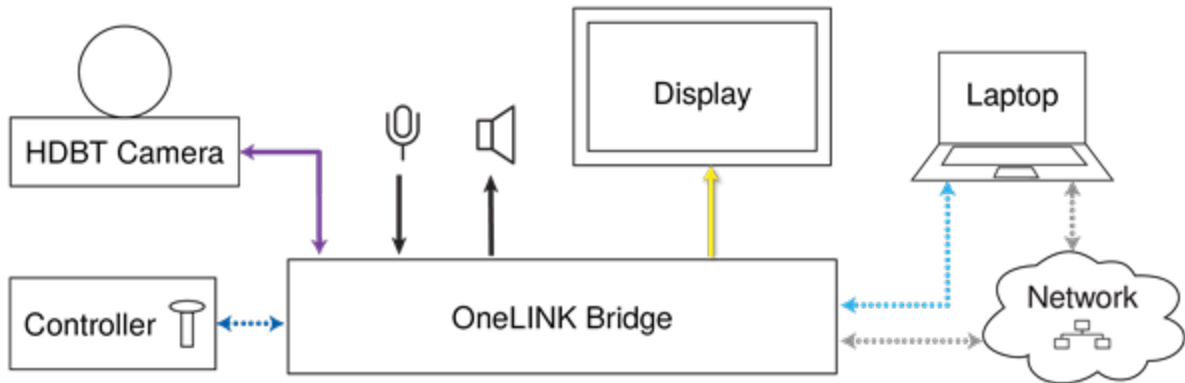

The controller is optional.

Kits and Systems for HDBaseT Cameras

This block diagram applies to:

- OneLINK Bridge for Vaddio HDBaseT Cameras, 999-9595-000/001/009 – compatible with all Vaddio HDBaseT cameras.
- RoboSHOT 12 HDBaseT OneLINK Bridge System, 999-9960-200/201/209
- RoboSHOT 30 HDBaseT OneLINK Bridge System, 999-9963-200/200W/201/201W/209/209W
- RoboSHOT 20 UHD OneLINK Bridge System, 999-9950-200/200W/201/201W/209/209W
- DocCAM 20 HDBaseT OneLINK Bridge System, 999-9968-300/301/309
- Future systems consisting of a Vaddio HDBaseT camera and a OneLINK Bridge AV interface

Connecting a Vaddio HDBaseT Camera

999-9595-000/001/009

In this diagram, the OneLINK Bridge extends network connectivity, power, and control to a RoboSHOT 12 HDBT camera, and brings HDMI video from the camera to a display. The OneLINK Bridge also provides audio connections, and can originate a USB stream to bridge non-USB equipment into a USB-based conferencing application.

Items in this diagram:

- OneLINK BridgeAV interface
- RoboSHOT 12 HDBT camera (not included in kit 999-9595-000/001/009)
- HDMI display and HDMI cable (not included)
- Laptop using soft conferencing client (not included)
- USB 3.0 cable to laptop
- Audio cables (not included) terminated with supplied connectors
- Connections to microphones and speakers (not included)
- Cat-5e cables for OneLINK and network connections (not included)

RoboSHOT HDBT Camera

Other Vaddio HDBaseT cameras connect in the same way.



Connections for HDBaseT Cameras Used with Codecs

In this configuration, the OneLINK HDMI extends network connectivity, power, and control to an HDBaseT camera, and brings HDMI video from the camera to a connected codec. The codec may be connected to the OneLINK device directly via RS-232, or they may communicate over the IP network, depending on the codec. The OneLINK Bridge can originate a USB stream to bridge the camera, codec, and codec-connected audio equipment into a USB-based conferencing application.

If an IP stream is available from the camera, the OneLINK device passes it to the network. IP streaming resolutions up to 2160p/30 are supported. HDMI output resolution and streaming parameters (including resolution) are configured on the camera, not the OneLINK device.

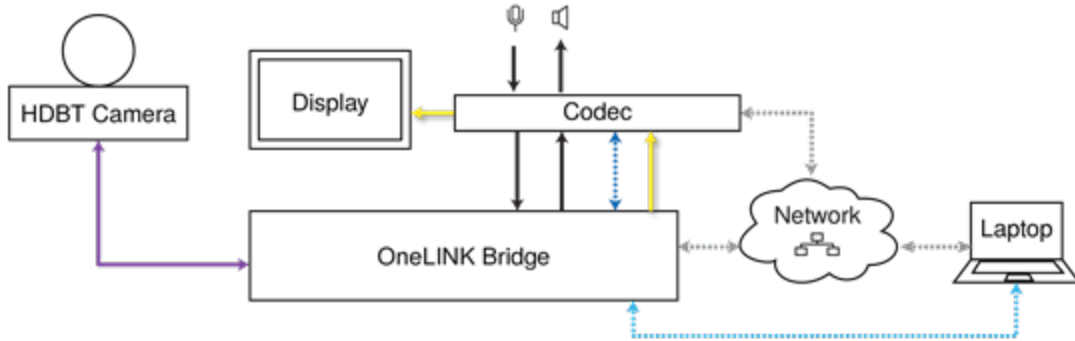

Kits for HDBaseT Cameras Used with Codecs

This block diagram applies to:

- OneLINK Bridge for Vaddio HDBaseT Cameras with Polycom Codecs, 999-9645-000/001/009 – compatible with all Vaddio HDBaseT cameras and with Polycom RealPresence Group Series codecs.
- OneLINK Bridge for Vaddio HDBaseT Cameras with Cisco Codecs, 999-9675-000/001/009 – compatible with all Vaddio HDBaseT cameras and with Cisco C20, C40, C60, SX20, and SX80 codecs.

Connecting a Vaddio HDBaseT Camera and Polycom Codec

999-9645-000/001/009

In these diagrams, the OneLINK Bridge extends network connectivity, power, and control to a RoboSHOT 12 HDBT camera, and connects the camera to a Polycom codec. The OneLINK Bridge also provides audio connections, and can originate a USB stream to bridge non-USB equipment into a USB-based conferencing application.

Other Vaddio HDBaseT cameras would be connected in exactly the same way.

Items in these diagrams:

- OneLINK Bridge AV interface
- Power supply with AC cord set
- Codec-side fan-out cable
- RoboSHOT 12 HDBT camera (not included)
- Polycom RealPresence Group Series codec (not included)
- HDMI display and HDMI cable (not included)
- Laptop with soft conferencing client (not included)
- Cat-5e cables for OneLINK and network connections (not included)

RoboSHOT HDBT Camera and Polycom RealPresence Group 310 Codec

The Group 500 codec looks very similar and connects in the same way.

Other Vaddio HDBaseT cameras connect in the same way.

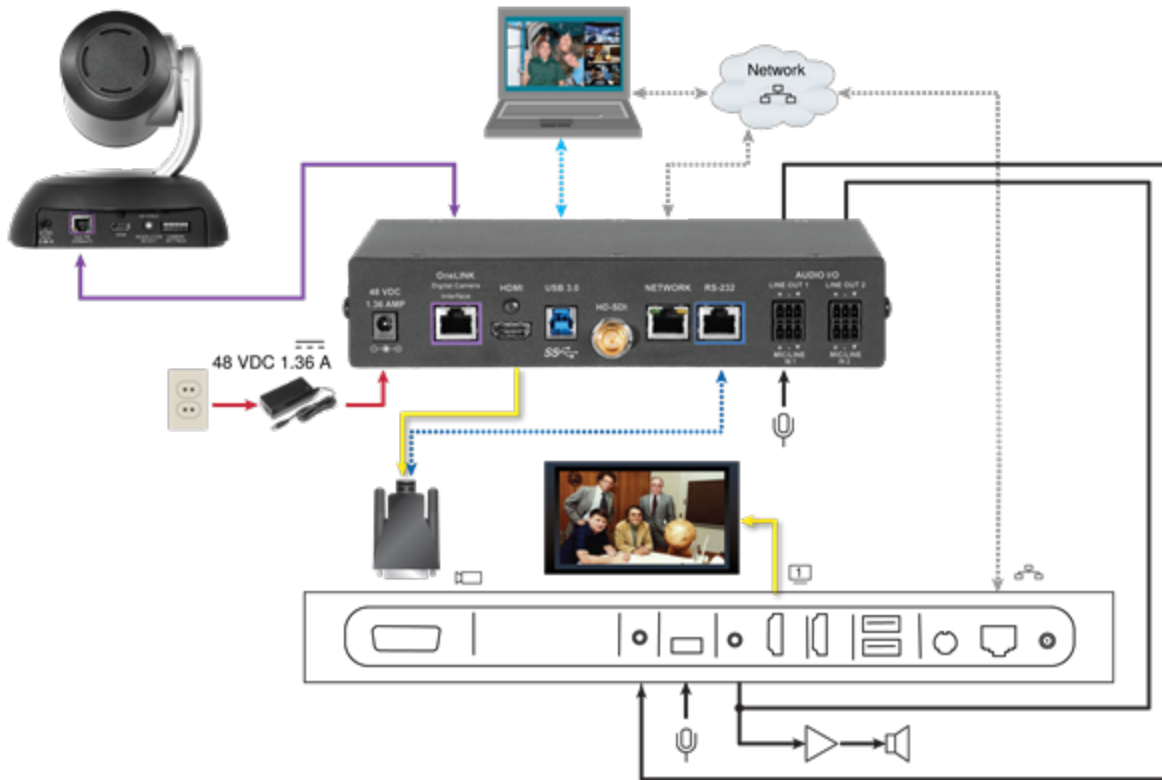

RoboSHOT HDBT Camera and Polycom RealPresence Group 700 Codec

Other Vaddio HDBaseT cameras connect in the same way.

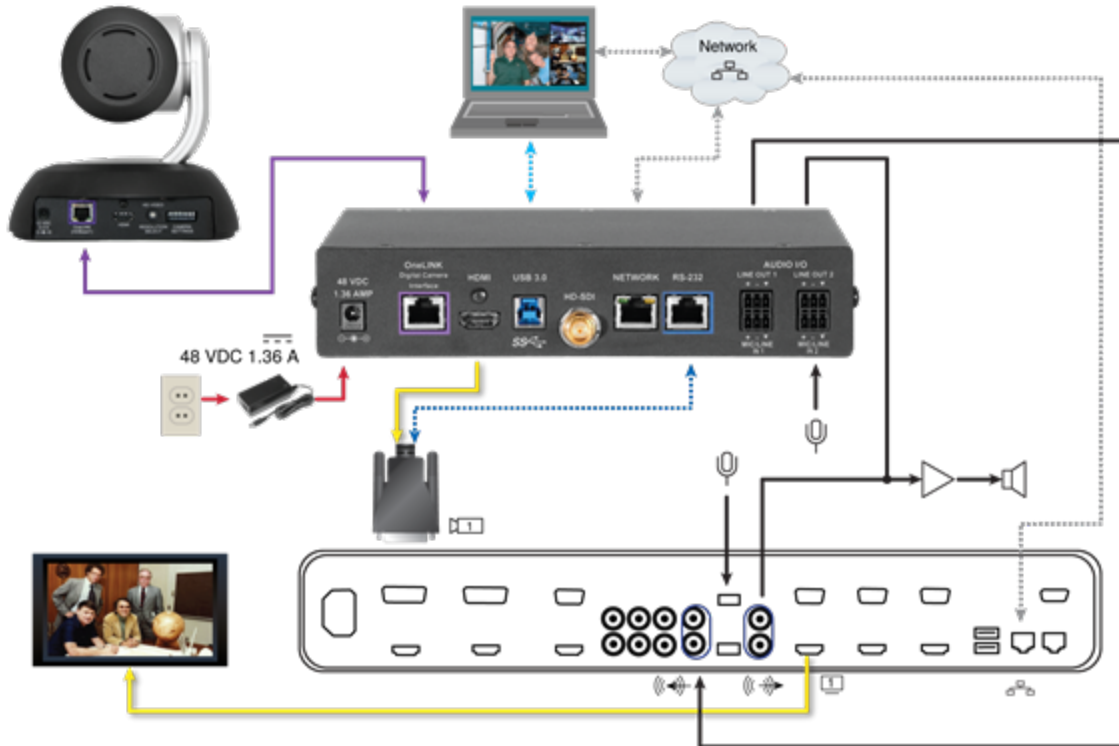

Hardware Note: IR Forwarding

Although the OneLINK Bridge does not support IR forwarding, the two unterminated wires of the fan-out cable can be terminated and connected to an IR emitter (repeater).

Hardware Note: Connection and Configuration Changes

After connecting or configuring the equipment, reboot the OneLINK device, camera, and codec. Note that rebooting the OneLINK device does not affect the camera and codec; they must be rebooted separately.

Connecting a Vaddio HDBaseT Camera and Cisco Codec

999-9675-000/001/009

In these diagrams, the OneLINK Bridge extends network connectivity, power, and control to a RoboSHOT 12 HDBT camera, and connects the camera to a Cisco codec. The OneLINK Bridge also provides audio connections, and can originate a USB stream to bridge non-USB equipment into a USB-based conferencing application.

Other Vaddio HDBaseT cameras would be connected in exactly the same way.

Items in these diagrams:

- OneLINK Bridge AV interface
- Power supply and AC cord set
- RS-232 adapter 998-1002-232 (used with standard Cat-5 cable on C20, C60, and SX80 codecs)
- Cisco split cable CAB-PHD4XS2-SPLIT(not included; required for SX20 codec)
- Codec-side null modem cable (used with split cable on SX20 codec)
- RoboSHOT 12 HDBT camera (not included)
- Cisco codec (not included)
- HDMI display and HDMI cable (not included)
- Laptop with soft conferencing client (not included)
- Cat-5e cables for OneLINK and network connections (not included)

RoboSHOT HDBT Camera and Cisco C20 Codec

Other Vaddio HDBaseT cameras connect in the same way.

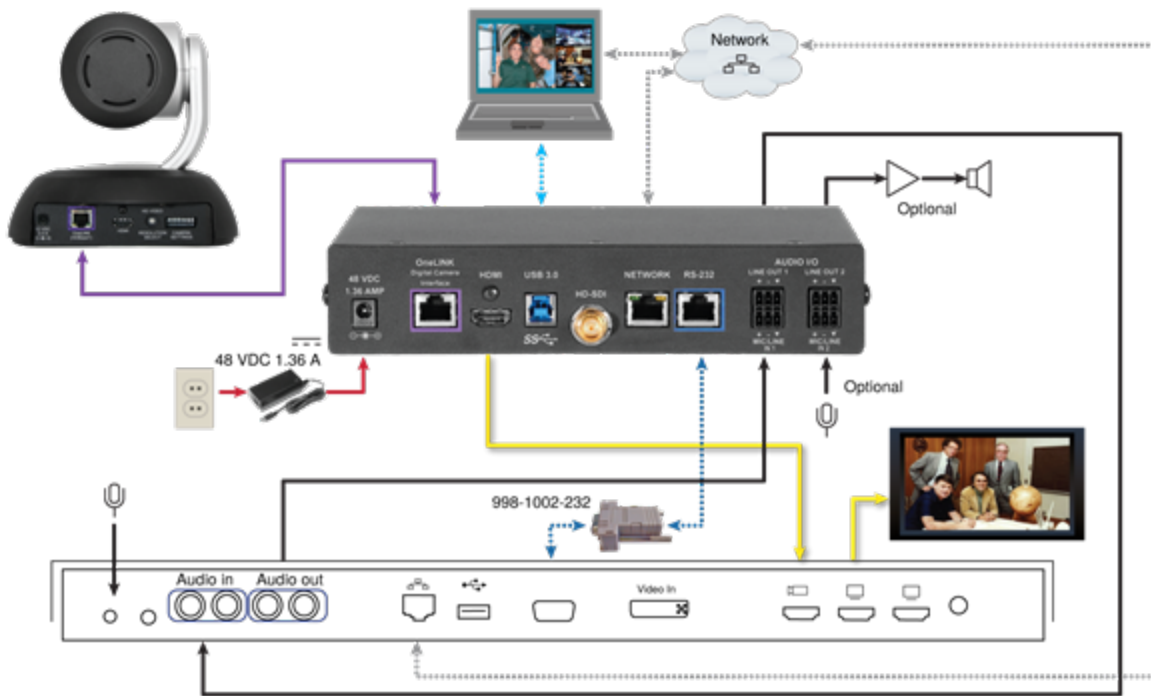

RoboSHOT HDBT Camera and Cisco C60 Codec

The C40 codec looks very similar and connects in the same way.

Other Vaddio HDBaseT cameras connect in the same way.

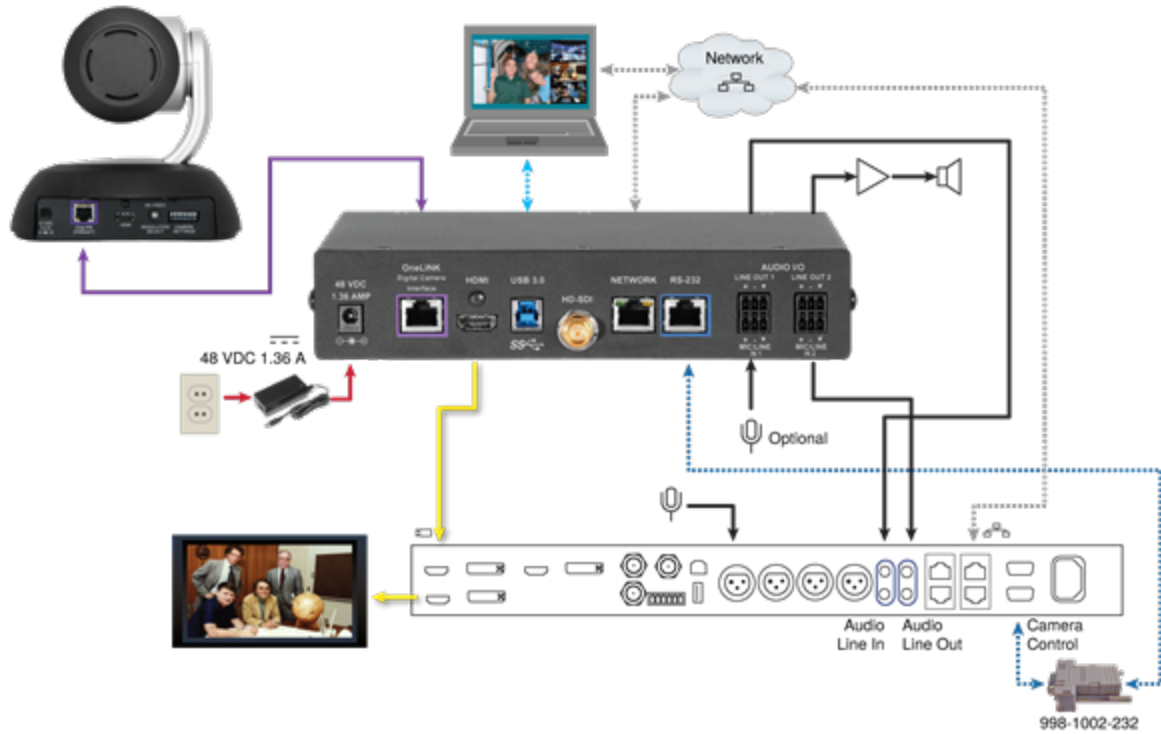

RoboSHOT HDBT Camera and Cisco SX20 Codec

Other Vaddio HDBaseT cameras connect in the same way.

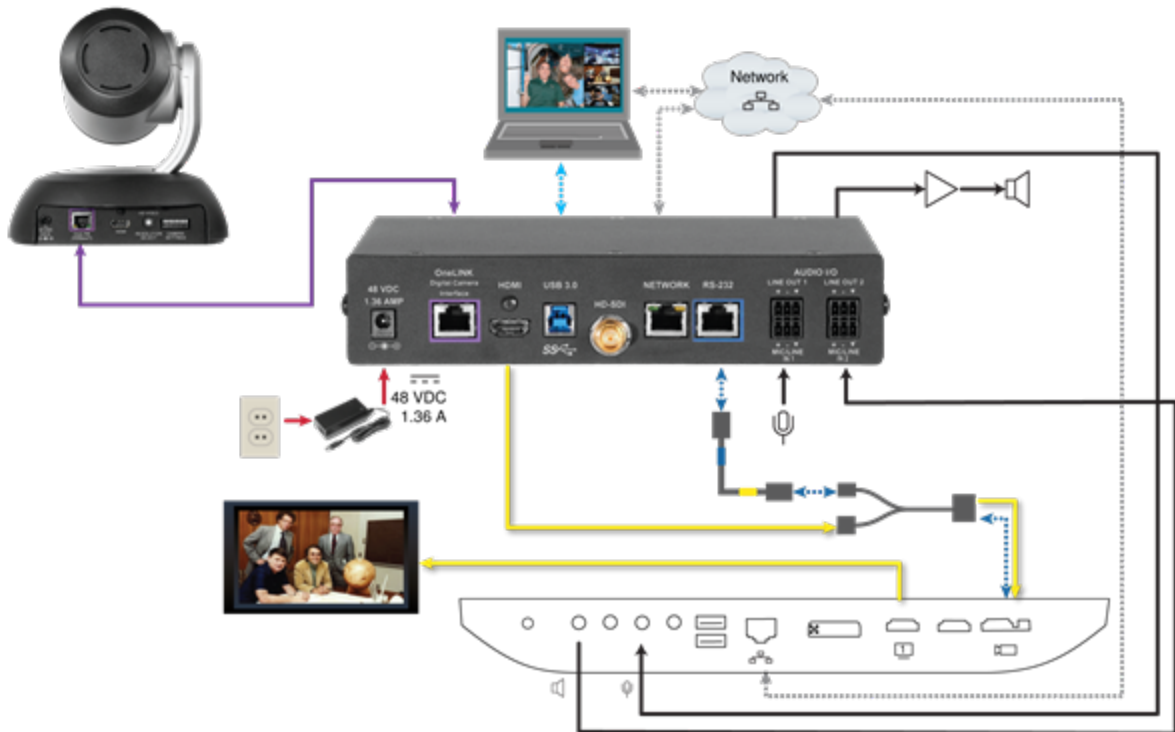

Note

If connecting to a Cisco SX20 codec, you will need to provide a Cisco split cable, Cisco part number CAB-PHD4XS2-SPLIT.

RoboSHOT HDBT Camera and Cisco SX80 Codec

Other Vaddio HDBaseT cameras connect in the same way.

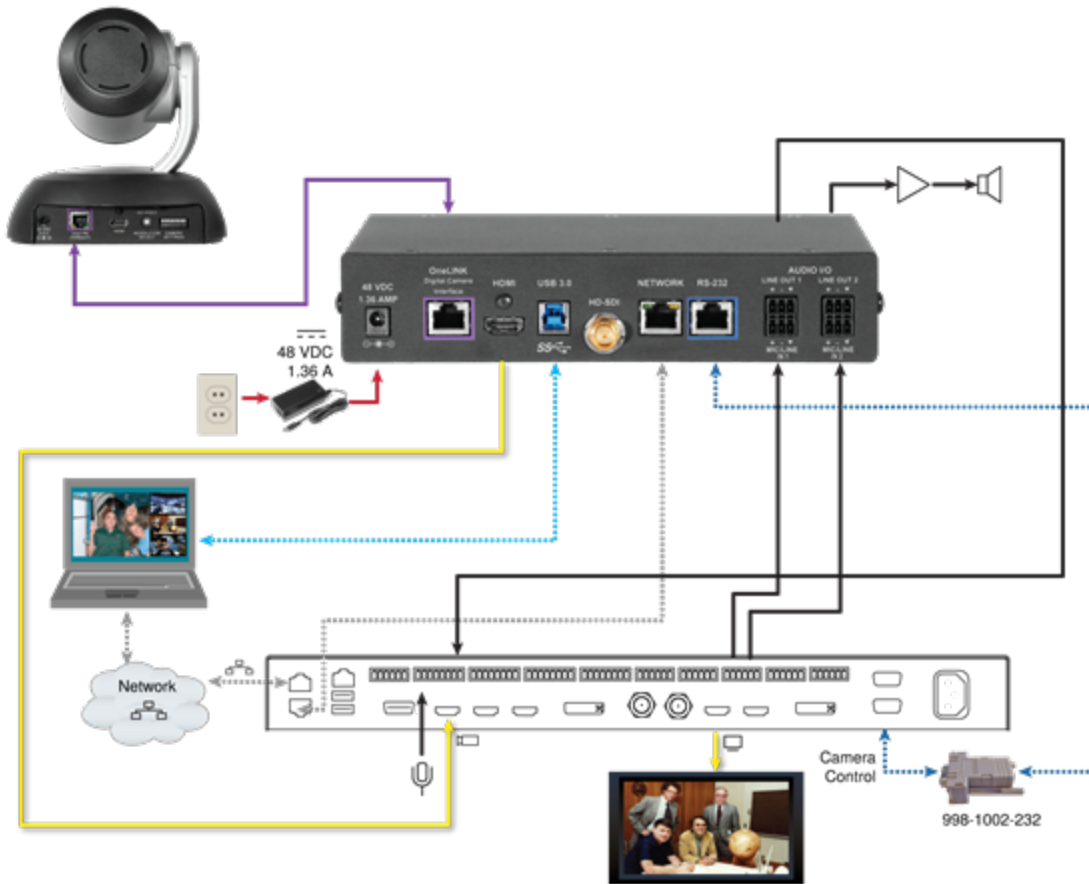

Hardware Note: RS-232 Connections

For RS-232 connections to Cisco gear using DE-9 connectors, use the 998-1002-232 RJ-45 to DE-9 adapter. Its wiring differs from the 998-1001-232 adapter shipped with many Vaddio products.

For RS-232 connections to Cisco gear using the Cisco split cable, use the appropriate null-modem cable to the RJ-45 side of the split cable. Connect the null-modem cable as indicated on the cable labels.

Hardware Note: Connection and Configuration Changes

After connecting or configuring the equipment, reboot the OneLINK device, camera, and codec. Note that rebooting the OneLINK device does not affect the camera and codec; they must be rebooted separately.

OneLINK Device Configuration

After installation is complete and the OneLINK device and camera are operational, you will need to change the AEC reference if you made the audio connections as shown in these diagrams. Set Master Output/AEC Reference to Output 2 if using Line Out 2 for the speaker connection.

Connections for HDMI Cameras

In this configuration, the OneLINK Bridge extends network connectivity, power, and control to an HDMI camera, and brings HDMI video from the camera to a display. The camera can optionally be controlled by a camera controller on an RS-232 serial connection to the OneLINK Bridge or over the network, depending on the controller. The OneLINK Bridge also provides connections for microphones and speakers, and can originate a USB stream to bridge the non-USB camera and audio equipment into a USB-based conferencing application.

If an IP stream is available from the camera, the OneLINK device passes it to the network. IP streaming resolutions up to 2160p/30 are supported. HDMI output resolution and streaming parameters (including resolution) are configured on the camera, not the OneLINK device.

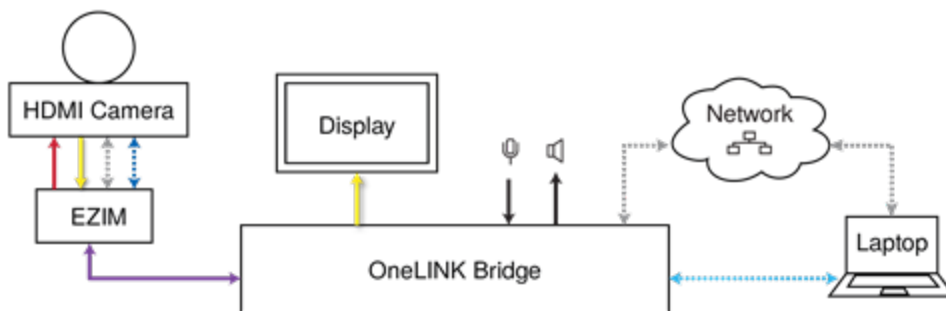

Kits for HDMI Cameras

This block diagram applies to:

- OneLINK Bridge AV interface for Polycom cameras with Polycom Codecs, 999-9620-000/001/009, when used without a codec – compatible with Polycom EagleEye IV camera.
- OneLINK Bridge AV Interface for Sony and Panasonic Cameras, 999-9630-000/001/009 – compatible with Panasonic HE-series, Sony EVI-D series, and Sony BRC-H series cameras.
- OneLINK Bridge AV interface for Cisco Cameras with Cisco Codecs, 999-9660-000/001/009, when used without a codec – compatible with Cisco Precision series cameras.
- OneLINK Bridge AV Interface for RoboSHOT HDMICameras, 999-9690-000/001/009 (*camera has been discontinued*)

Connecting a RoboSHOT HDMI Camera

999-9690-000/001/009

In this diagram, the OneLINK Bridge extends network connectivity, power, and control to a RoboSHOT HDMI camera, and brings camera video to the connected HDMI display. The OneLINK Bridge also provides audio connections, and can originate a USB stream to bridge non-USB equipment into a USB-based conferencing application.

Items in this diagram:

- OneLINK Bridge AV interface and OneLINK EZIM
- OneLINK power supply and AC cord set
- RoboSHOT 12 HDMI camera (not included)
- Power cable, HDMI cable, and Cat-5e cables from the OneLINK EZIM to the camera
- HDMI display and HDMI cable (not included)
- Laptop with soft conferencing client (not included)
- Cat-5e cables for OneLINK and network connections (not included)

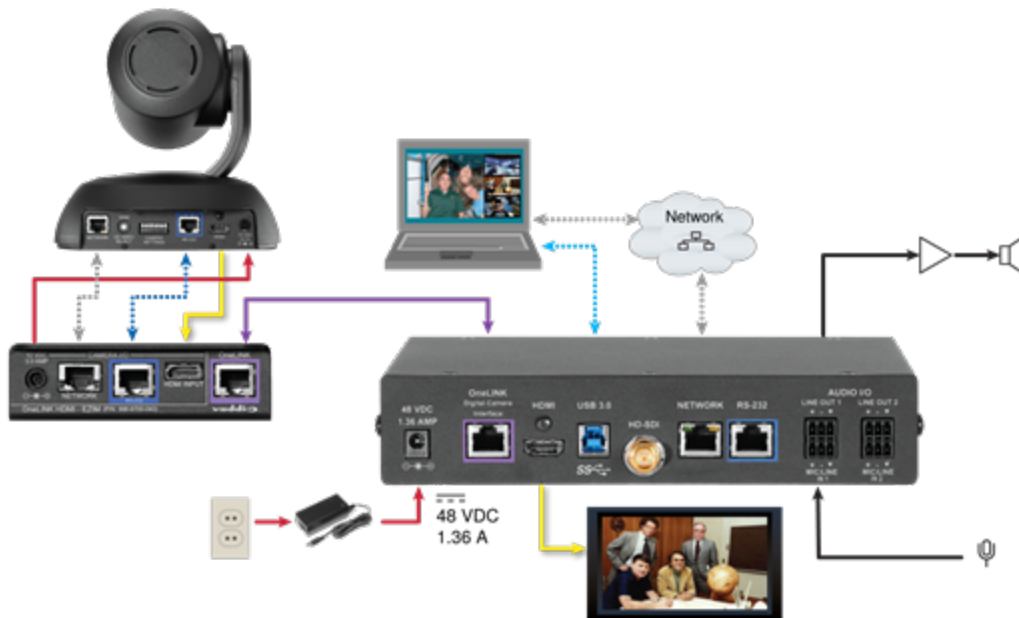

Connecting a Polycom EagleEye IV Camera

999-9620-000/001/009

In this diagram, the OneLINK Bridge extends network connectivity, power, and control to a Polycom EagleEye IV camera, and brings HDMI video from the camera to a display. The OneLINK Bridge also provides audio connections, and can originate a USB stream to bridge non-USB equipment into a USB-based conferencing application.

Items in this diagram:

- OneLINK Bridge AV interface and OneLINK EZIM
- Power supply and AC cord set
- Camera-side fan-out cable
- Polycom EagleEye IV camera (not included)
- HDMI display and cable (not included)
- Laptop with soft conferencing client (not included)
- Cat-5e cables for OneLINK and network connections (not included)

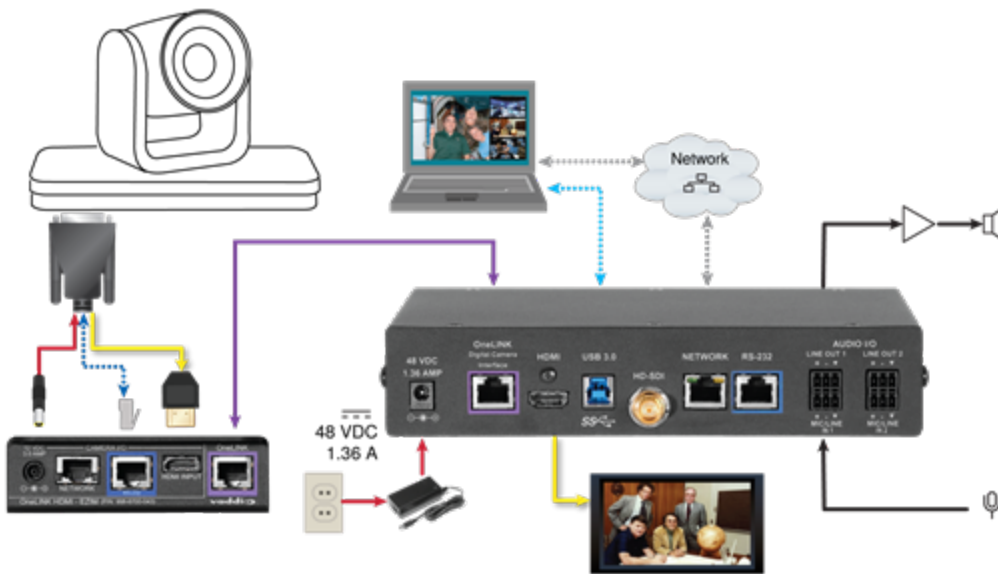

Connecting a Cisco Camera

999-9660-000/001/009

In these diagrams, the OneLINK Bridge extends power and control to a Cisco camera, and brings HDMI video from the camera to a display. The OneLINK Bridge also provides audio connections, and can originate a USB stream to bridge non-USB equipment into a USB-based conferencing application.

- OneLINK BridgeAV interface and OneLINK EZIM
- Camera-side fan-out cable (not included; used with Precision 40 and Precision HD 1080p2.5x)
- Cisco camera (not included)
- HDMI display and HDMI cable (not included)
- Laptop with soft conferencing client (not included)
- Cat-5e cables for OneLINK and network connections (not included)

Cisco Precision 40 or Precision HD Series Camera

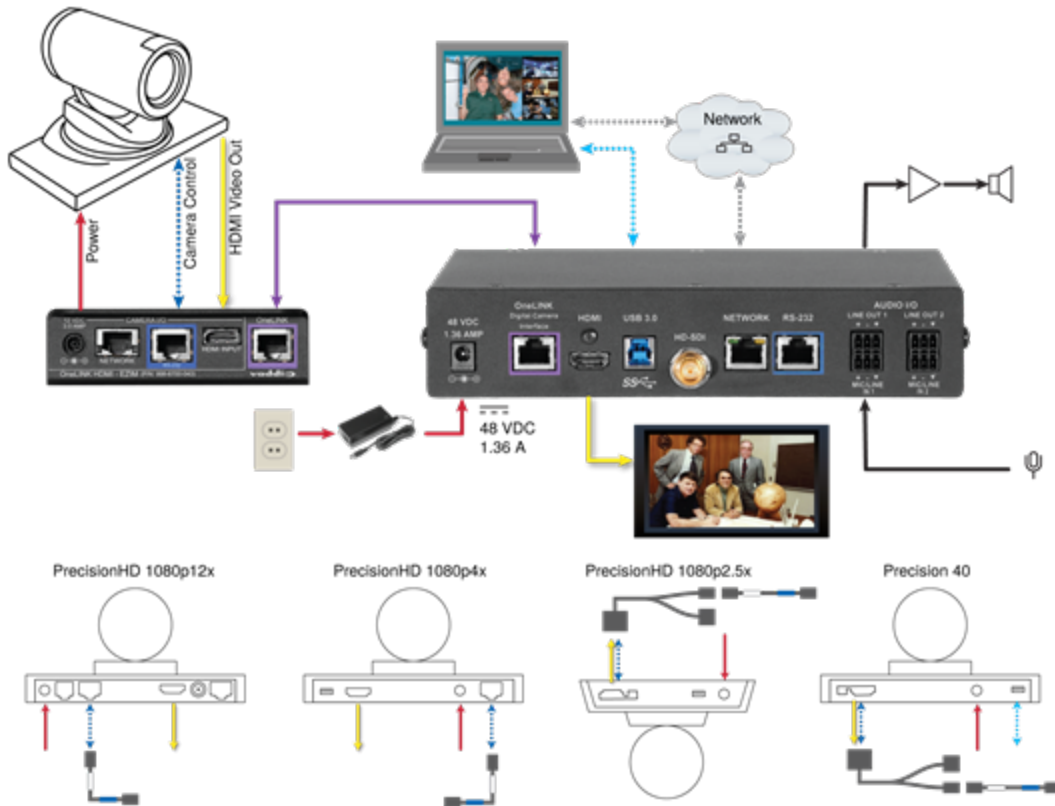

Note

If connecting to a Cisco Precision 40 or Precision HD 1080p2.5x camera, you will need to provide a Cisco split cable, Cisco part number CAB-PHD4XS2-SPLIT.

Cisco Precision 60 Camera

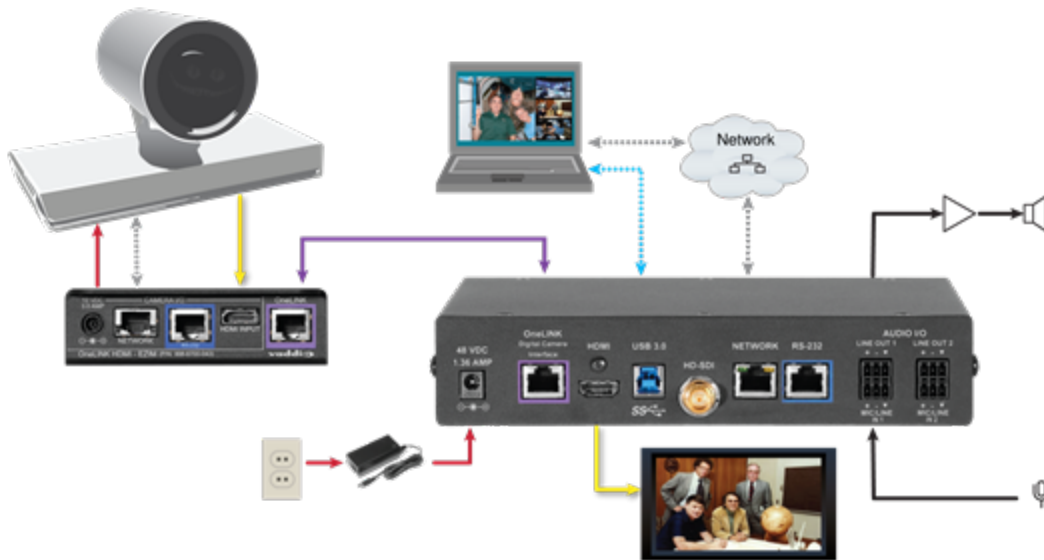

Hardware Note: RS-232 Connections

For RS-232 connections to Cisco cameras, use the appropriate null-modem cable. Connect it as indicated on the cable labels. This cable is used with the Cisco split cable CAB-PHD4XS2-SPLIT for some cameras.

Connecting a Sony or Panasonic HDMI Camera

999-9630-000/001/009

In these diagrams, the OneLINK Bridge extends power and control to a Sony or Panasonic HDMI camera, and brings video from the camera to a display. The OneLINK Bridge also provides audio connections, and can originate a USB stream to bridge non-USB equipment into a USB-based conferencing application.

Items in this diagram:

- OneLINK Bridge AV interface and OneLINK EZIM
- Power supply and AC cord set
- Camera with cables (not included)
- HDMI display and cable (not included)
- Laptop with soft conferencing client (not included)

Panasonic AW-HE130 Camera

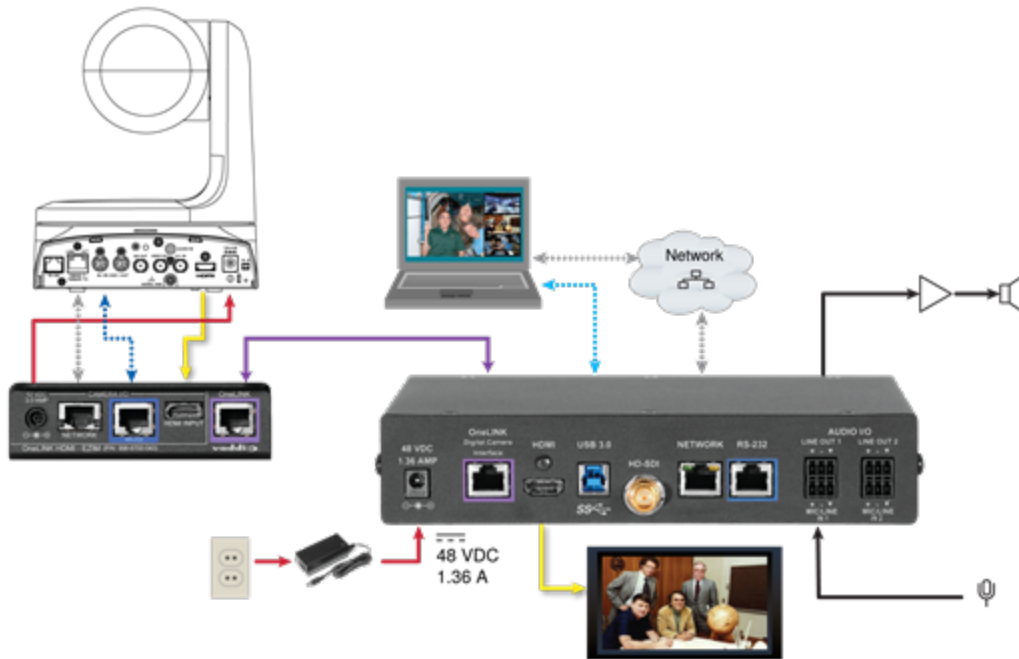

Sony SRG300 Camera

The SRG120 camera's connector panel looks very similar, and connects in the same way.

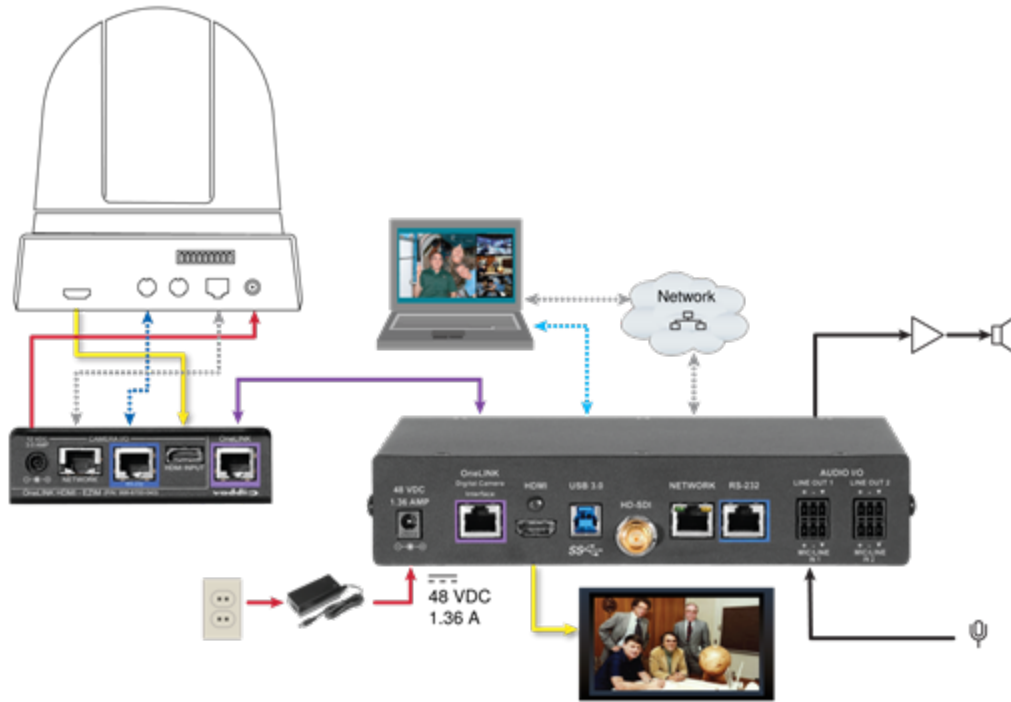

Connections for HDMI Cameras Used with Codecs

In this configuration, the OneLINK HDMI extends network connectivity, power, and control to an HDMI camera, and brings HDMI video from the camera to a connected codec. The codec may be connected to the OneLINK device directly via RS-232, or they may communicate over the IP network, depending on the codec. The OneLINK Bridge can originate a USB stream to bridge the camera, codec, and codec-connected audio equipment into a USB-based conferencing application.

If an IP stream is available from the camera, the OneLINK device passes it to the network. IP streaming resolutions up to 2160p/30 are supported. HDMI output resolution and streaming parameters (including resolution) are configured on the camera, not the OneLINK device.

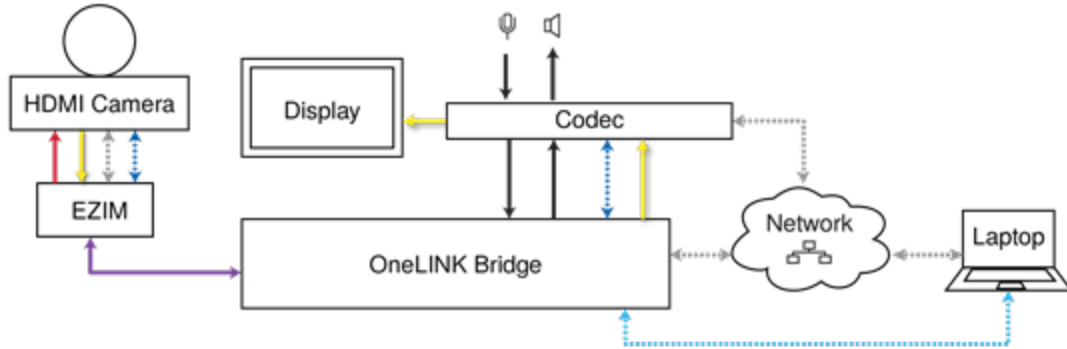

Kits for HDMI Cameras Used with Codecs

This block diagram applies to:

- OneLINK Bridge for Polycom Cameras with Polycom Codecs, 999-9620-000/001/009 – compatible with Polycom EagleEye IV camera and Polycom RealPresence Group Series codecs.
- OneLINK Bridge for RoboSHOT HDMI Cameras with Polycom Codecs, 999-9640-000/001/009 – compatible with RoboSHOT HDMI cameras and Polycom RealPresence Group Series codecs.
- OneLINK Bridge for Cisco Cameras with Cisco Codecs, 999-9660-000/001/009 – compatible with Cisco Precision series cameras and Cisco C20, C40, C60, SX20, and SX80 codecs.
- OneLINK Bridge for RoboSHOT HDMI Cameras with Cisco Codecs, 999-9670-000/001/009 – compatible with RoboSHOT HDMI cameras and with Cisco C20, C40, C60, SX20, and SX80 codecs.

Connecting a RoboSHOT HDMI Camera and Polycom Codec

999-9640-000/001/009

In these diagrams, the OneLINK Bridge extends network connectivity, power, and control to a RoboSHOT 12 or 30 HDMI camera, and connects the camera to a Polycom codec. The OneLINK Bridge also provides audio connections, and can originate a USB stream to bridge non-USB equipment into a USB-based conferencing application.

Items in these diagrams:

- OneLINK Bridge AV interface and OneLINK EZIM
- Power supply with AC cord set
- RoboSHOT 12 HDMI camera (not included)
- Polycom RealPresence Group Series codec (not included)
- Codec-side fan-out cable
- HDMI display and HDMI cable (not included)
- Laptop with soft conferencing client (not included)
- Cat-5e cables for OneLINK and network connections (not included)

RoboSHOT HDMI Camera and Polycom RealPresence Group 310 Codec

The Group 500 codec looks very similar and connects in the same way.

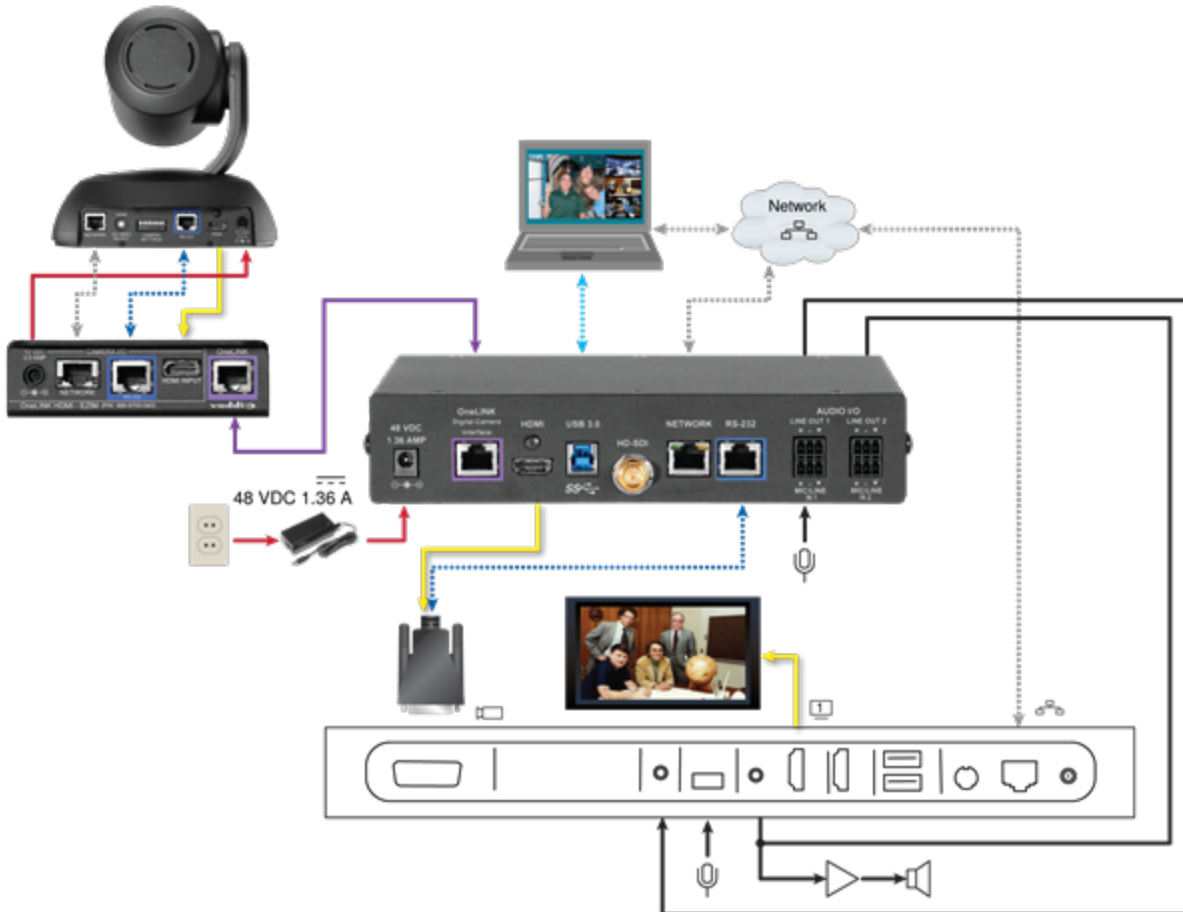

RoboSHOT HDMI Camera and Polycom RealPresence Group 700 Codec

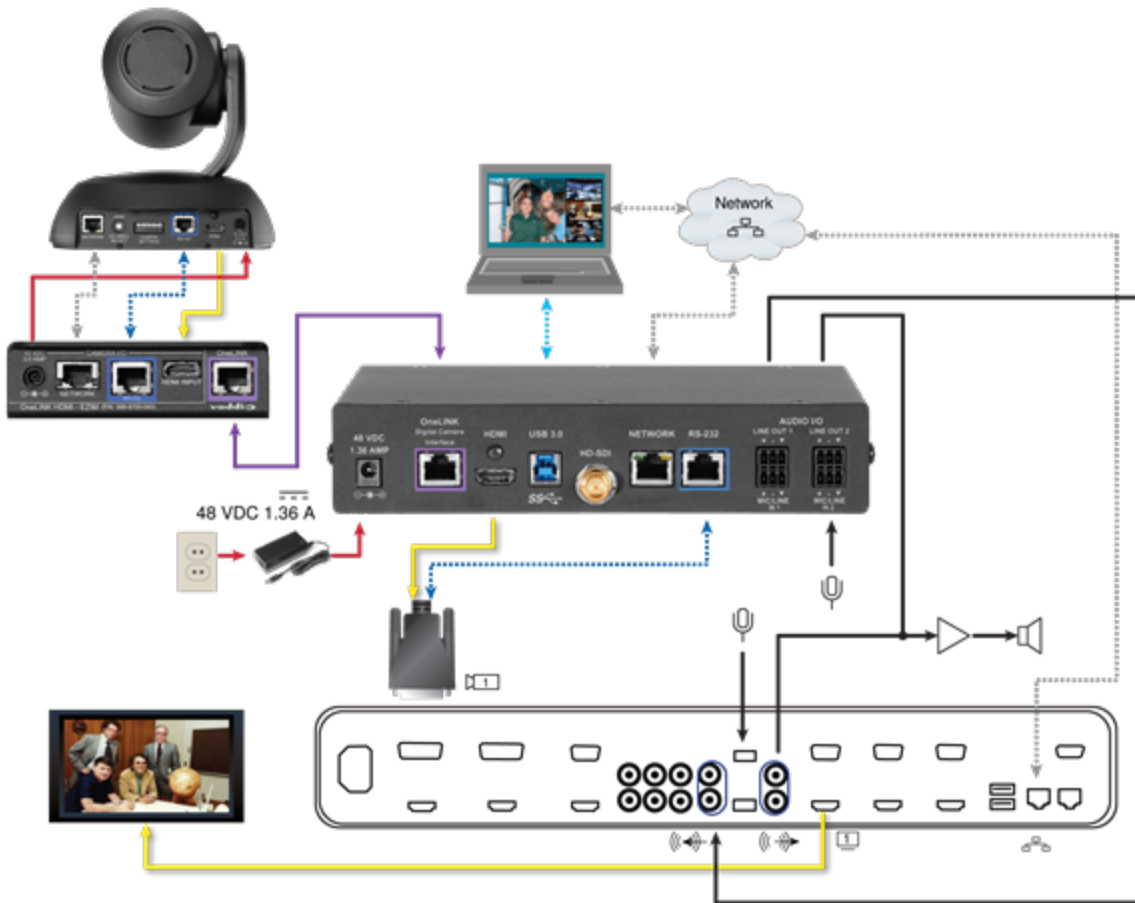

Hardware Note: IR Forwarding

Although the OneLINK Bridge does not support IR forwarding, the two unterminated wires of the fan-out cable can be terminated and connected to an IR emitter (repeater).

Hardware Note: Connection and Configuration Changes

After connecting or configuring the equipment, reboot the OneLINK device, camera, and codec. Note that rebooting the OneLINK device does not affect the camera and codec; they must be rebooted separately.

Connecting a Polycom EagleEye IV Camera and Polycom Codec

999-9620-000/001/009

In these diagrams, the OneLINK Bridge extends network connectivity, power, and control to a Polycom EagleEye IV camera, and connects the camera to a Polycom codec. The OneLINK Bridge also provides audio connections, and can originate a USB stream to bridge non-USB equipment into a USB-based conferencing application.

Items in these diagrams:

- OneLINK Bridge AV interface and OneLINK EZIM
- Power supply with AC cord set
- Polycom EagleEye IV camera (not included)
- Polycom RealPresence Group Series codec (not included)
- Codec-side fan-out cable
- HDMI display and HDMI cable (not included)
- Laptop with soft conferencing client (not included)
- Cat-5e cables for OneLINK and network connections (not included)

Polycom EagleEye IV Camera and Polycom RealPresence Group 310 Codec

The Group 500 codec looks very similar and connects in the same way.

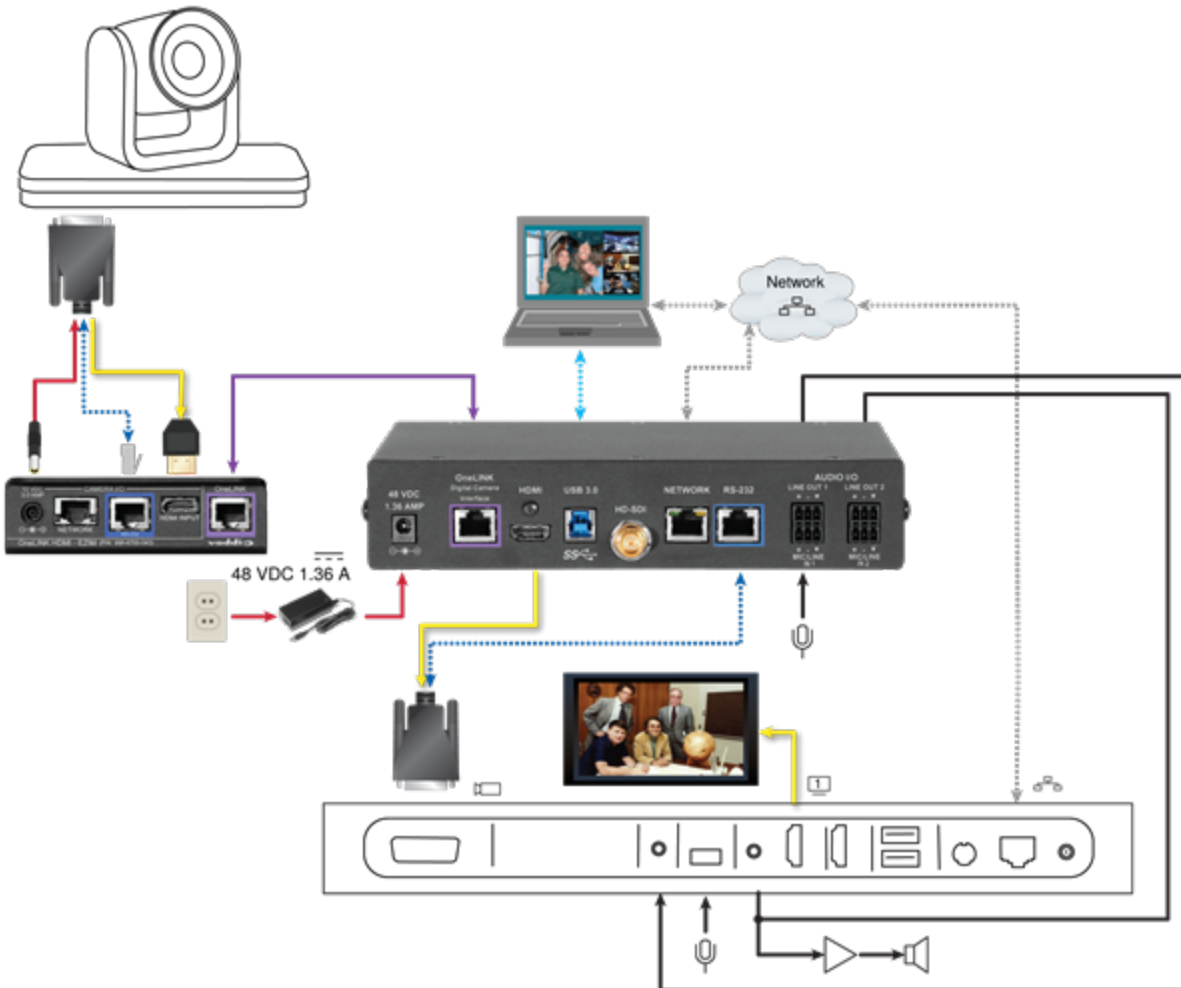

Polycom EagleEye IV Camera and Polycom RealPresence Group 700 Codec

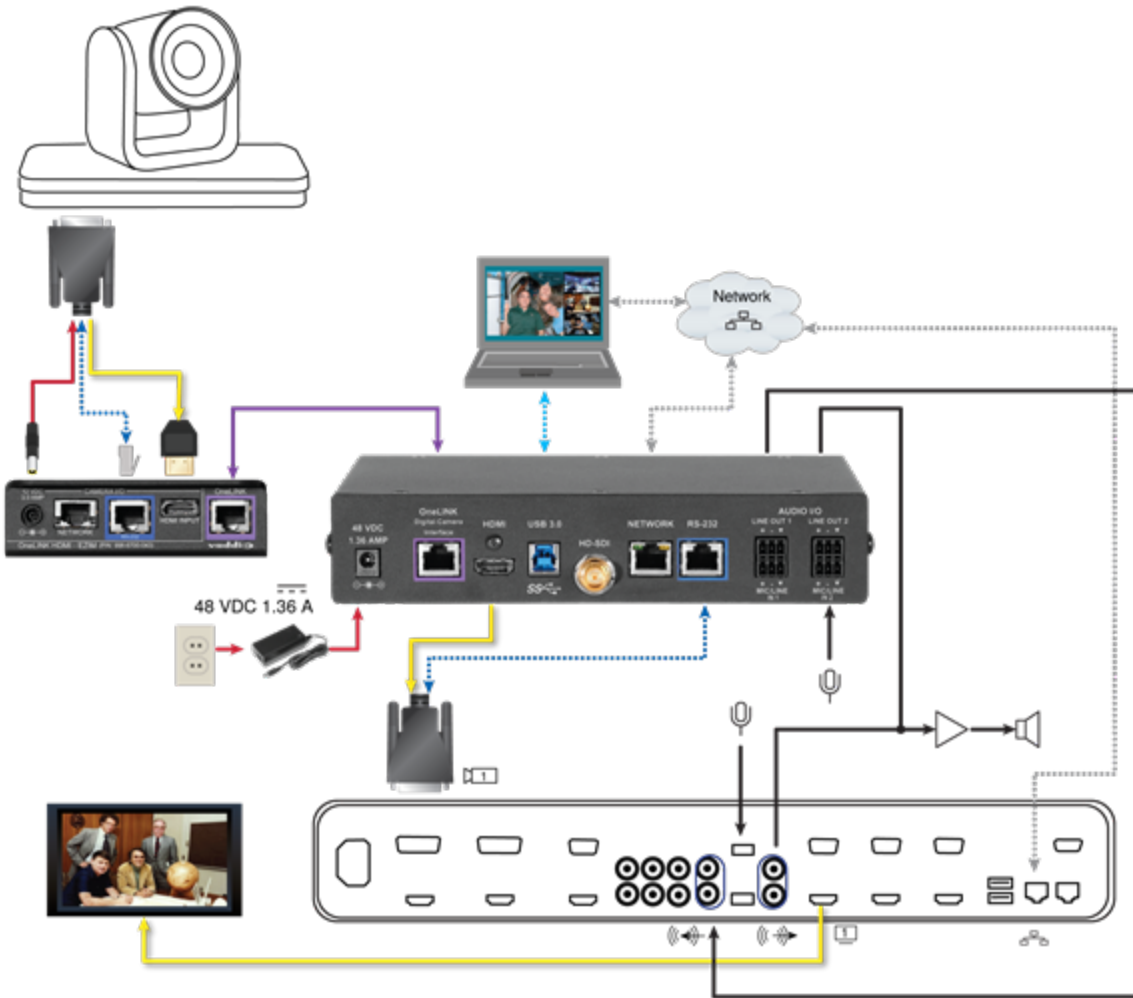

Hardware Note: IR Forwarding

Although the OneLINK Bridge does not support IR forwarding, the two unterminated wires of the fan-out cable can be terminated and connected to an IR emitter (repeater).

Hardware Note: Connection and Configuration Changes

After connecting or configuring the equipment, reboot the OneLINK device, camera, and codec. Note that rebooting the OneLINK device does not affect the camera and codec; they must be rebooted separately.

Connecting a RoboSHOT HDMI Camera and Cisco Codec

999-9670-000/001/009

In these diagrams, the OneLINK Bridge extends network connectivity, power, and control to a RoboSHOT 12 or 30 HDMI camera, and connects the camera to a Cisco codec. The OneLINK Bridge also provides audio connections, and can originate a USB stream to bridge non-USB equipment into a USB-based conferencing application.

Items in these diagrams:

- OneLINK Bridge AV interface and OneLINK EZIM
- Power supply and AC cord set
- RS-232 adapter 998-1002-232 (used with standard Cat-5 cable on C20, C60. and SX80 codecs)
- Cisco split cable CAB-PHD4XS2-SPLIT (not included; required for SX20 codec)
- Codec-side null modem cable (used with split cable on SX20 codec)
- RoboSHOT 12 HDMI camera (not included)
- Cisco codec (not included)
- HDMI display and HDMI cable (not included)
- Laptop with soft conferencing client (not included)
- Cat-5e cables for OneLINK and network connections (not included)

RoboSHOT HDMI Camera and Cisco C20 Codec

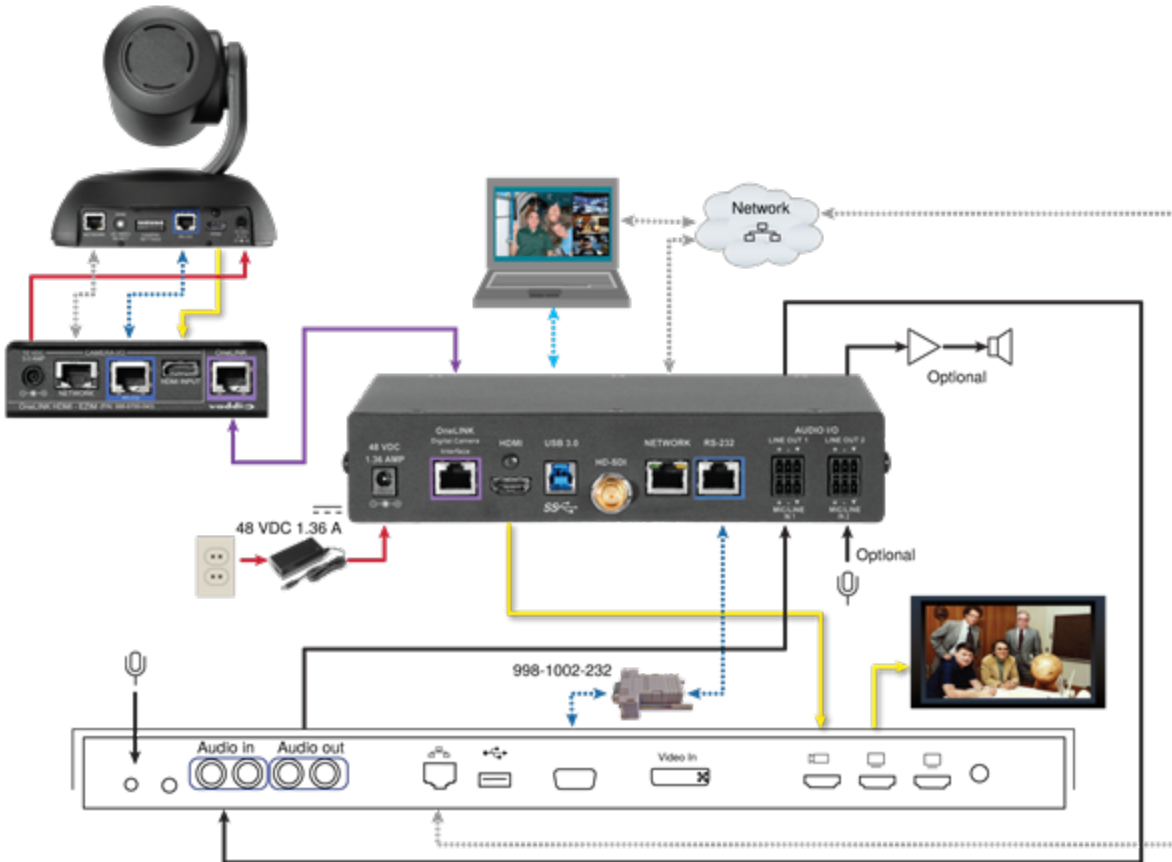

RoboSHOT HDMI Camera and Cisco C60 Codec

The C40 codec looks very similar and connects in the same way.

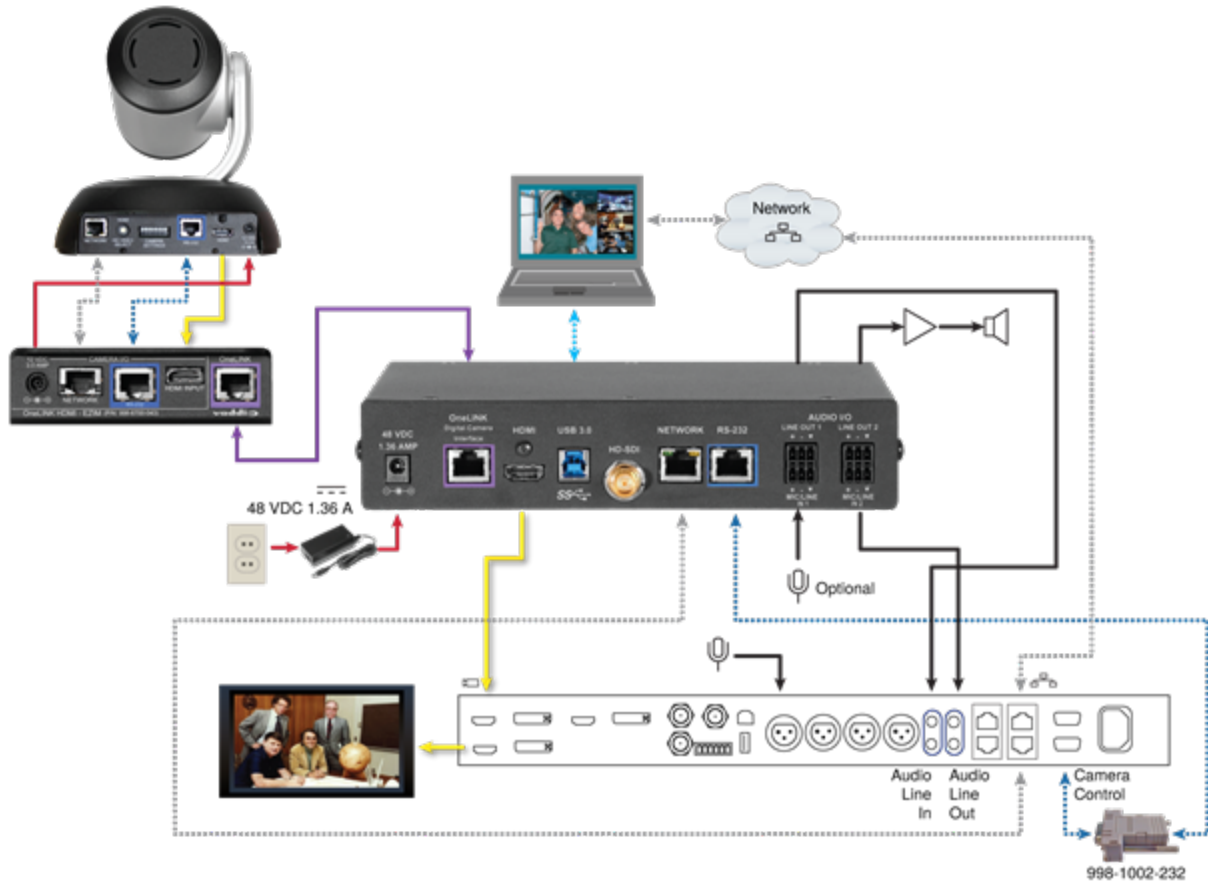

RoboSHOT HDMI Camera and Cisco SX20 Codec

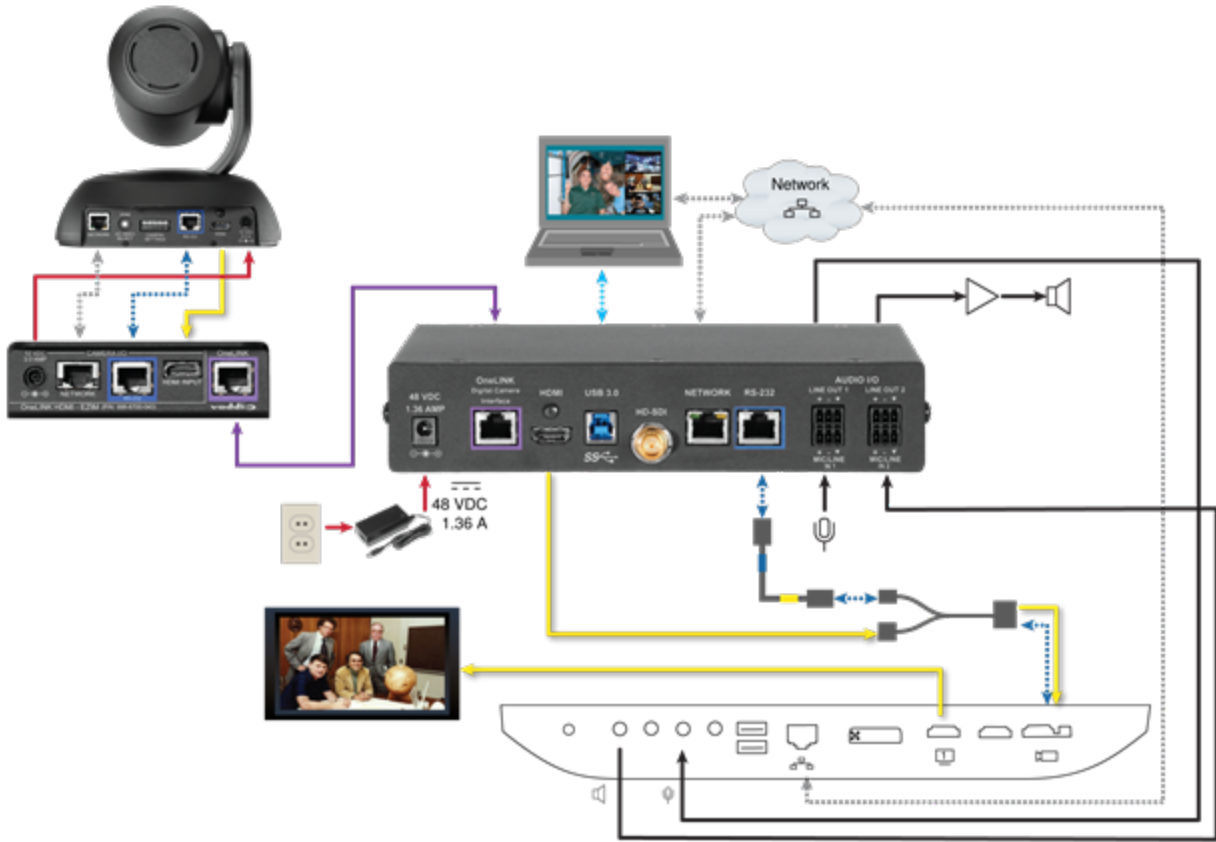

Note

If connecting to a Cisco SX20 codec, you will need to provide a Cisco split cable, Cisco part number CAB-PHD4XS2-SPLIT.

RoboSHOT HDMI Camera and Cisco SX80 Codec

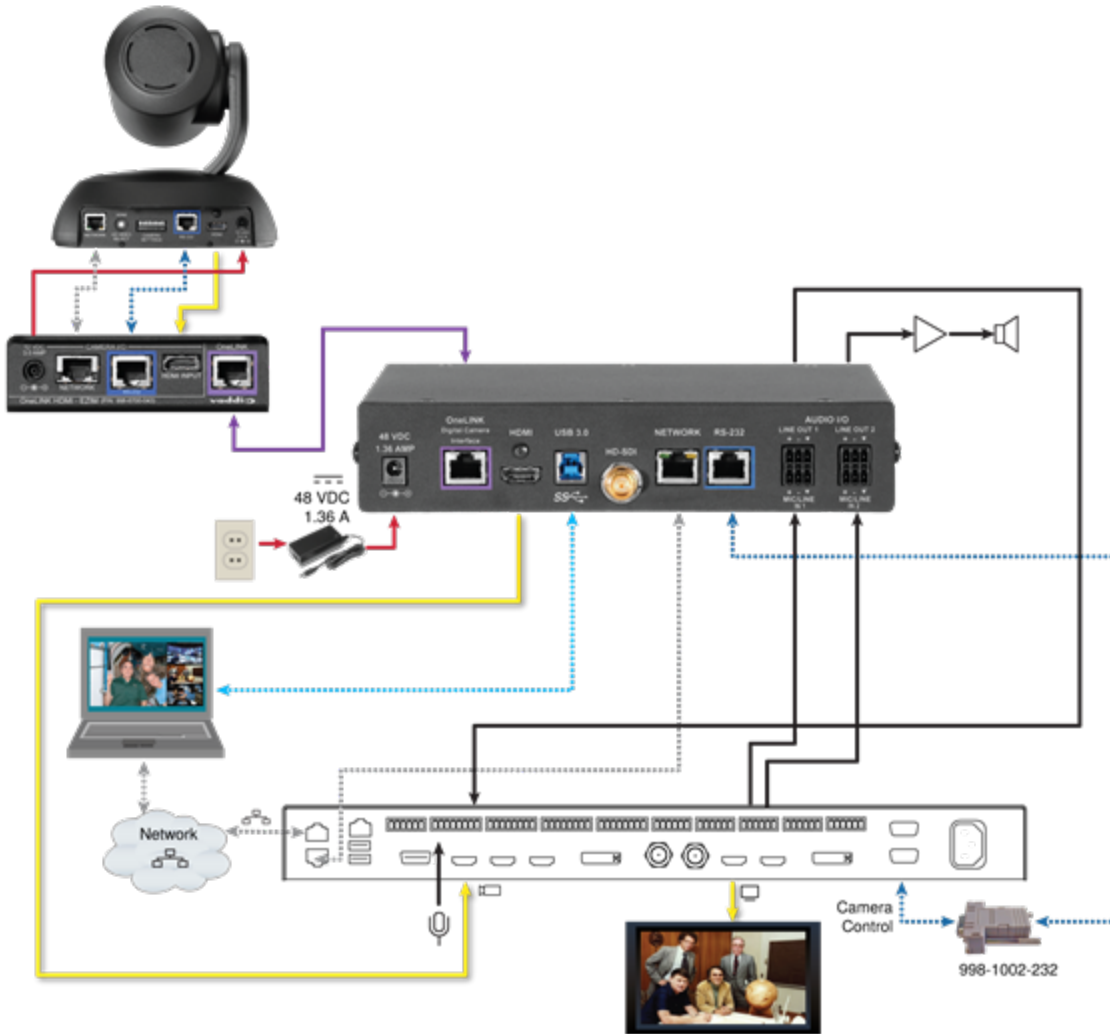

Hardware Note: RS-232 Connections

For RS-232 connections to Cisco gear using DE-9 connectors, use the 998-1002-232 RJ-45 to DE-9 adapter. Its wiring differs from the 998-1001-232 adapter shipped with many Vaddio products.

For RS-232 connections to Cisco gear using the Cisco split cable, use the appropriate null-modem cable to the RJ-45 side of the split cable. Connect the null-modem cable as indicated on the cable labels.

Hardware Note: Connection and Configuration Changes

After connecting or configuring the equipment, reboot the OneLINK device, camera, and codec. Note that rebooting the OneLINK device does not affect the camera and codec; they must be rebooted separately.

OneLINK Device Configuration

After installation is complete and the OneLINK device and camera are operational, you will need to change the AEC reference if you made the audio connections as shown in these diagrams. Set Master Output/AEC Reference to Output 2 if using Line Out 2 for the speaker connection.

Connecting a Cisco Camera and Codec

999-9660-000/001/009

In these diagrams, the OneLINK Bridge extends network connectivity, power, and control to a Cisco camera, and connects the camera to a Cisco codec. The OneLINK Bridge also provides audio connections, and can originate a USB stream to bridge non-USB equipment into a USB-based conferencing application.

Items in these diagrams:

- OneLINK BridgeAV interface and OneLINK EZIM
- Cisco split cable CAB-PHD4XS2-SPLIT (not included; required for SX20 codec and for Precision 40 and Precision HD 1080p2.5x cameras)
- Camera-side null modem cable (used on all supported Cisco cameras)
- Codec-side null modem cable (used with Cisco split cable on SX20 codec)
- RS-232 adapter 998-1002-232 (used with standard Cat-5 cable on C20, C60. and SX80 codecs)
- Cisco camera (not included)
- Cisco codec (not included)
- HDMI display and HDMI cable (not included)
- Laptop with soft conferencing client (not included)
- Cat-5e cables for OneLINK and network connections (not included)

Note

If connecting to a Cisco SX20 codec, you will need to provide a Cisco split cable, Cisco part number CAB-PHD4XS2-SPLIT. This cable is also required when connecting to a Cisco Precision 40 or Precision HD 1080p2.5x camera; you will need two of them if connecting one of these cameras and an SX20 codec.

Cisco Precision 40 or Precision HD Series Camera and Cisco C20 Codec

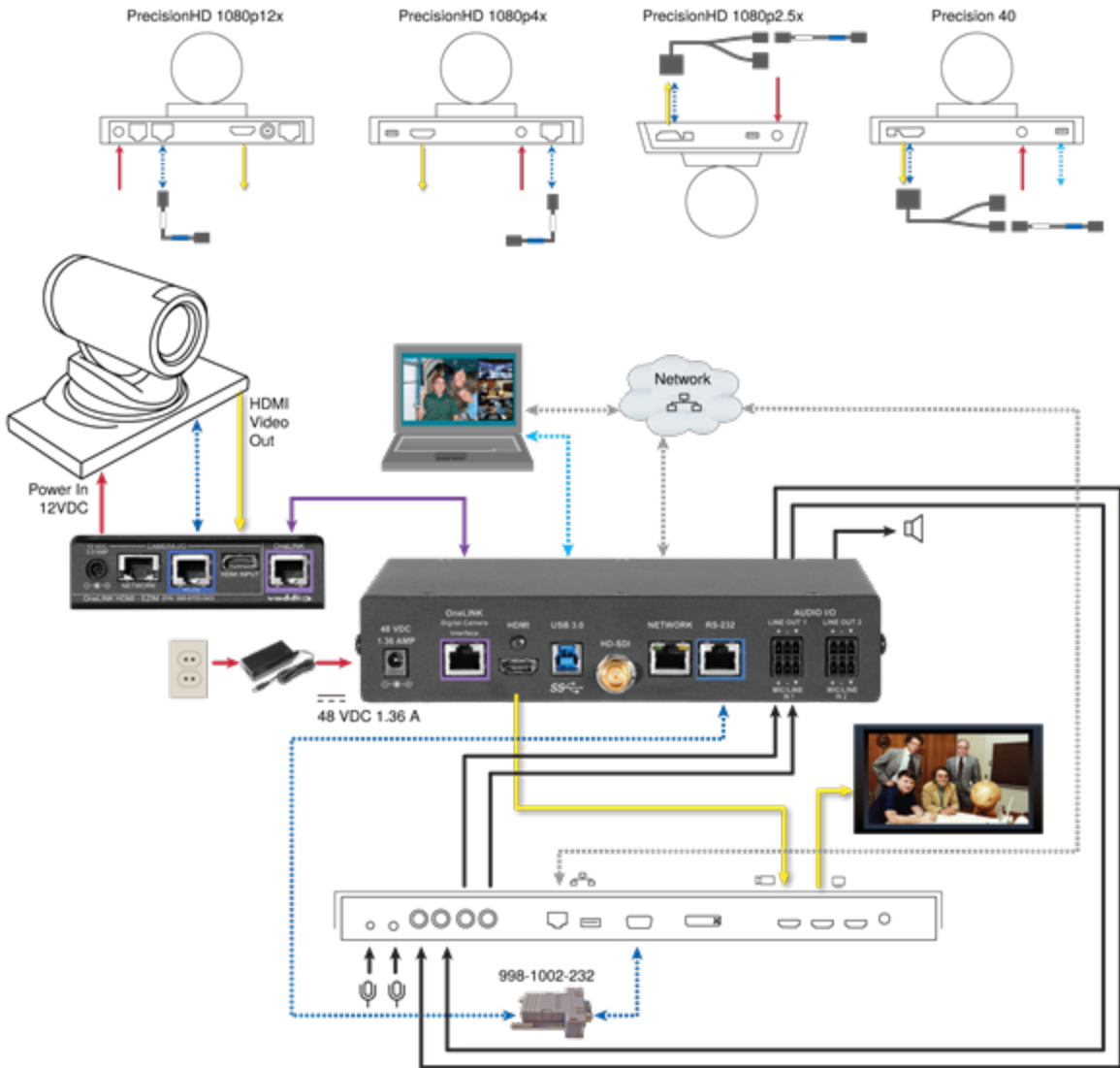

Cisco Precision 40 or Precision HD Series Camera and Cisco C60 Codec

The C40 codec looks very similar and connects in the same way.

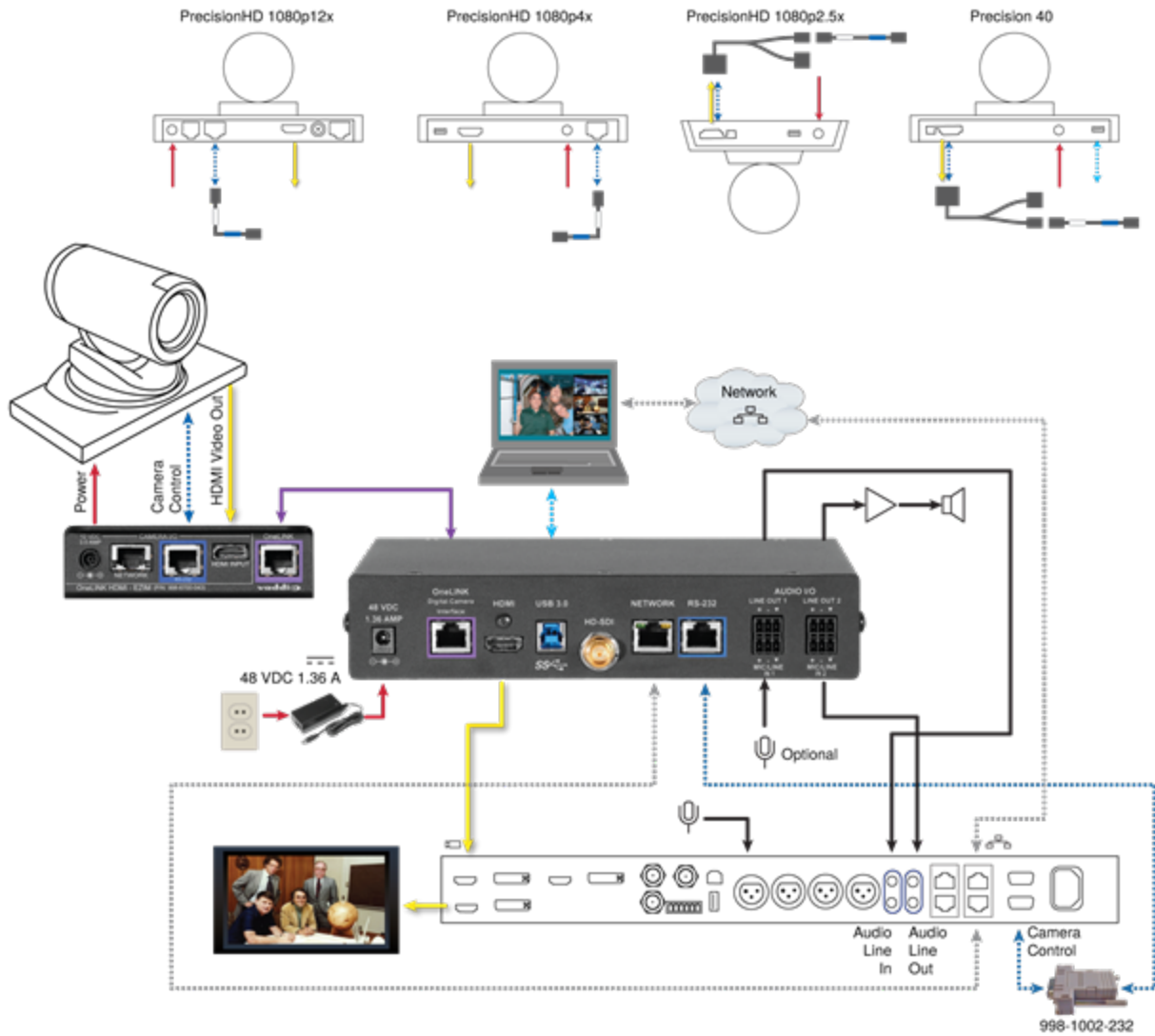

Cisco Precision 40 or Precision HD Series Camera and Cisco SX20 Codec

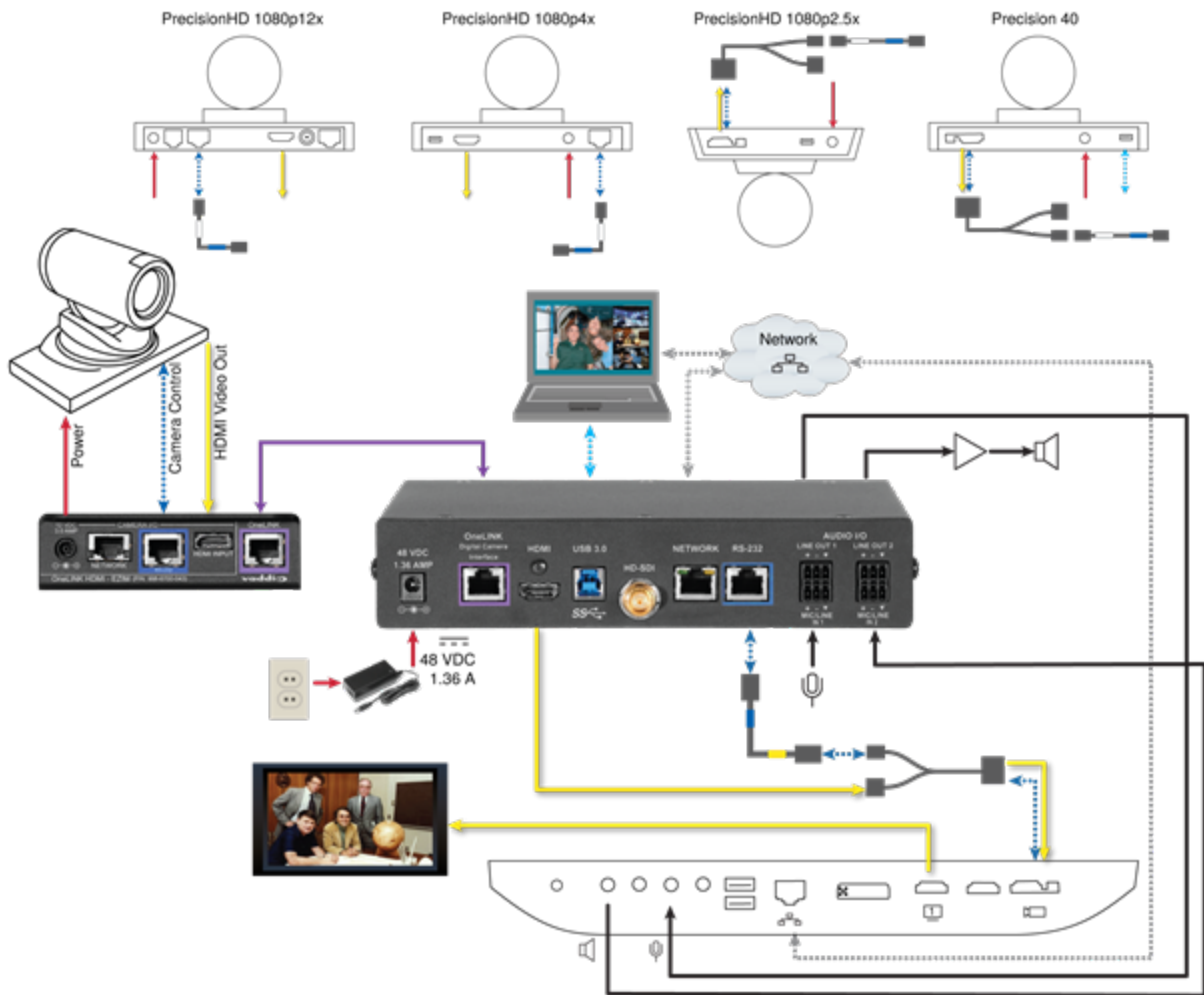

Cisco Precision 40 or Precision HD Series Camera and Cisco SX80 Codec

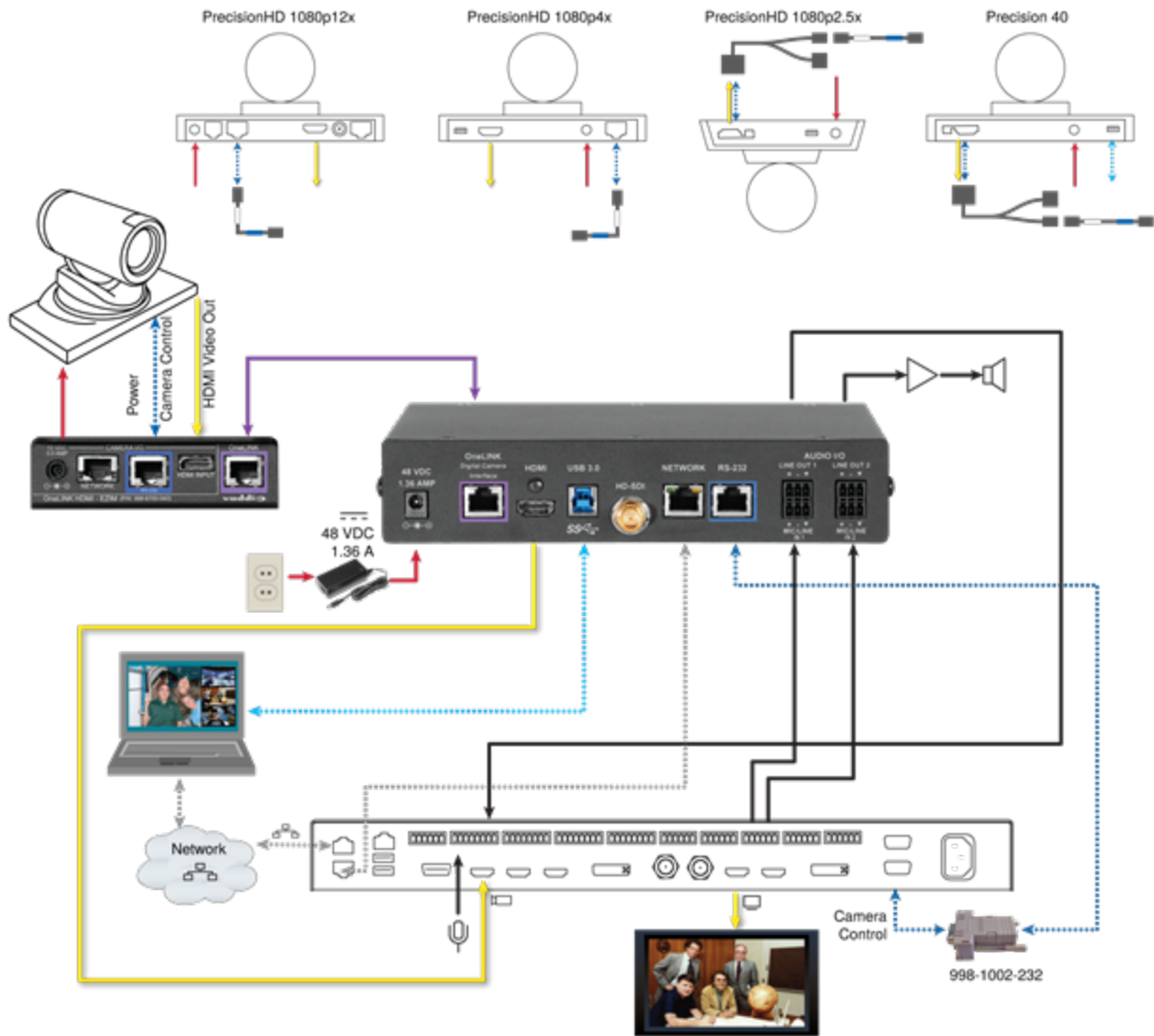

Cisco Precision 60 Camera and Cisco SX80 Codec

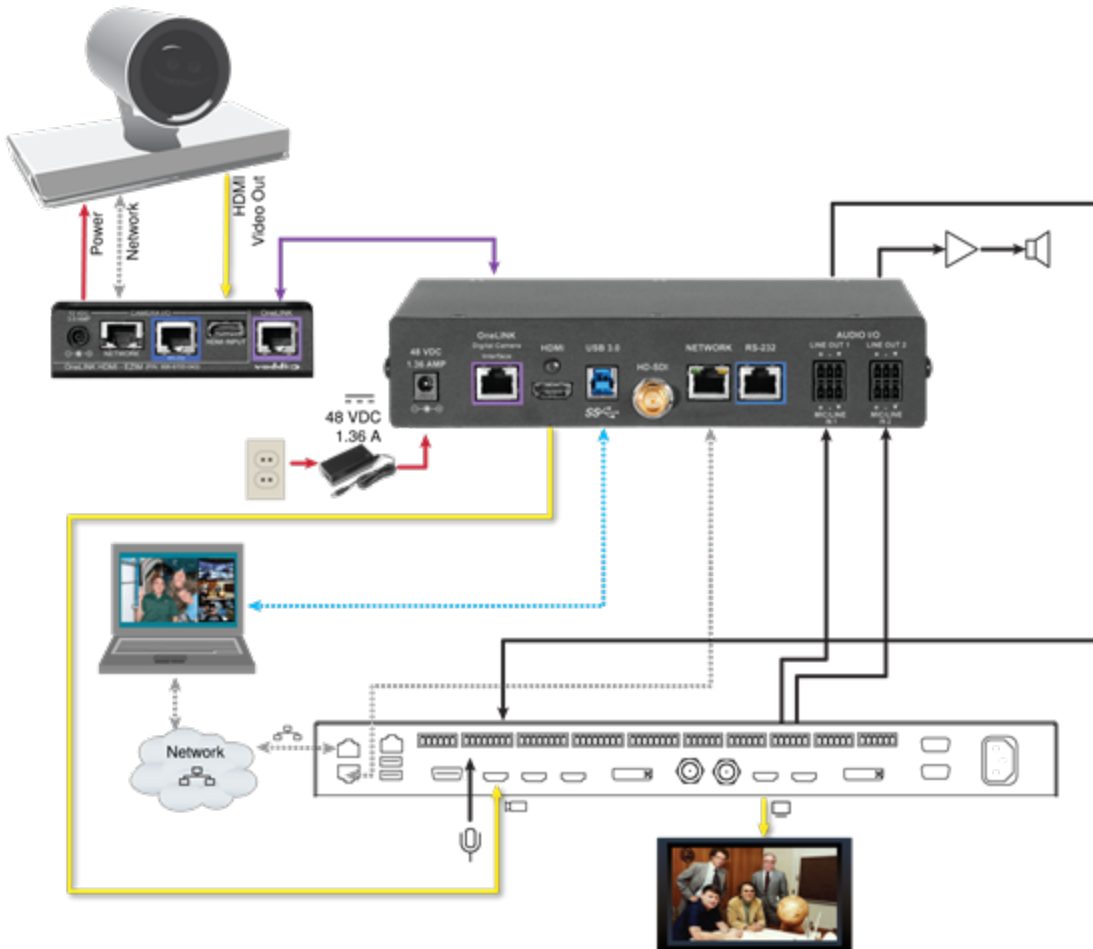

Hardware Note: RS-232 Connections

For RS-232 connections to Cisco gear using DE-9 connectors, use the 998-1002-232 RJ-45 to DE-9 adapter. Its wiring differs from the 998-1001-232 adapter shipped with many Vaddio products.

For RS-232 connections to Cisco gear using the Cisco split cable, use the appropriate null-modem cable to the RJ-45 side of the split cable. Connect the null-modem cable as indicated on the cable labels.

Hardware Note: Connection and Configuration Changes

After connecting or configuring the equipment, reboot the OneLINK device, camera, and codec. Note that rebooting the OneLINK device does not affect the camera and codec; they must be rebooted separately.

OneLINK Device Configuration

After installation is complete and the OneLINK device and camera are operational, you will need to change the AEC reference if you made the audio connections as shown in these diagrams. Set Master Output/AEC Reference to Output 2 if using Line Out 2 for the speaker connection.

Powering Up the Equipment

Power up the connected equipment that is not powered by the OneLINK device (such as displays and third-party control devices), then connect power to the OneLINK device. The connected camera and the OneLINK device power up together.

Next Steps

The OneLINK device is now ready to configure and use. This information is available in the **Complete Manual for the OneLINK Bridge AV Interface**.

You may need to configure the following settings on the camera:

- Network settings
- Streaming
- Video resolution and other camera settings

Refer to the camera's manual for details.

Operation, Storage, and Care

For smears or smudges on the product, wipe with a clean, soft cloth. Use a lens cleaner on the lens. Do not use any abrasive chemicals.

Keep this device away from food and liquids.

Do not operate or store the device under any of the following conditions:

- Temperatures above 40°C (104°F) or below 0°C (32°F)
- High humidity, condensing or wet environments
- Inclement weather
- Severe vibration
- Lateral acceleration of more than 27G
- Dry environments with an excess of static discharge

Do not attempt to take this product apart. There are no user-serviceable components inside.

Compliance Statements and Declarations of Conformity

Compliance testing was performed to the following regulations:

FCC Part 15 (15.107, 15.109), Subpart B	Class A
ICES-003, Issue 6, January 2016	Class A
EN 55024, 2010	Class A
EN 55032, 2012	Class A
EN 60950-1: 2006 + A11: 2009 + A1: 2010 + A12: 2011 + A2: 2013	Safety
KN24 2008 (CISPR 24: 1997 + A1: 2000 + A2: 2002)	Class A
EMC Directive 2014/30/EU	Class A

FCC Part 15 Compliance

This equipment has been tested and found to comply with the limits for a Class A digital device, pursuant to Part 15, Subpart B, of the FCC Rules. These limits are designed to provide reasonable protection against harmful interference when the equipment is operated in a commercial environment. This equipment generates, uses, and can radiate radio frequency energy and, if not installed and used in accordance with the instruction manual, may cause harmful interference to radio communications. Operation of this equipment in a residential area is likely to cause harmful interference in which case the user will be required to correct the interference at his/her own expense.

Operation is subject to the following two conditions: (1) This device may not cause interference, and (2) This device must accept any interference including interference that may cause undesired operation of the device.

Changes or modifications not expressly approved by Milestone AV Technologies can affect emission compliance and could void the user's authority to operate this equipment.



ICES-003 Compliance

This digital apparatus does not exceed the Class A limits for radio noise emissions from digital apparatus set out in the Radio Interference Regulations of the Canadian Department of Communications.

Le présent appareil numérique n'émet pas de bruits radioélectriques dépassant les limites applicables aux appareils numériques de la classe A prescrites dans le Règlement sur le brouillage radioélectrique édicté par le ministère des Communications du Canada.



European Compliance

This product has been evaluated for Electromagnetic Compatibility under the EMC Directive for Emissions and Immunity and meets the requirements for a Class A digital device. In a domestic environment this product may cause radio interference in which case the user may be required to take adequate measures.

Standard(s) To Which Conformity Is Declared:



EMC Directive 2014/30/EU	
EN 55032: 2012	Multimedia Equipment Emissions Requirements
EN 55024: 2010	IT Immunity Characteristics
EN 61000-4-2 + Amendments A1, A2	Electrostatic Discharge
EN 61000-4-3 + A1	Radiated Immunity
EN 61000-4-4 + Corrigendum	Electrical Fast Transients
EN 61000-4-5	Surge Immunity
EN 61000-4-6	Conducted Immunity
EN 61000-4-8	Power Frequency Magnetic Field
EN 61000-4-11	Voltage Dips, Interrupts and Fluctuations
KN24 2008 (CISPR 24: 1997 + A1: 2000 + A2: 2002)	IT Immunity Characteristics
EN 61000-4-2	Electrostatic Discharge
EN 61000-4-3	Radiated Immunity
EN 61000-4-4	Electrical Fast Transients
EN 61000-4-5	Surge Immunity
EN 61000-4-6	Conducted Immunity
EN 61000-4-8	Power Frequency Magnetic Field
EN 61000-4-11	Voltage Dips, Interrupts and Fluctuations
Low Voltage Directive 2014/35/EU	
IEC 60950-1: 2005 (2nd Edition); Am 1: 2009 + Am 2: 2013	Safety
EN 60950-1: 2006 + A11: 2009 + A1: 2010 + A12: 2011 + A2: 2013	Safety
RoHS Directive 2011/65/EU	

Warranty Information

See Vaddio Warranty, Service and Return Policies posted on support.vaddio.com for complete details.

Hardware* warranty: Two (2) year limited warranty on all parts and labor for Vaddio manufactured products. Vaddio warrants its manufactured products against defects in materials and workmanship for a period of two years from the day of purchase, to the original purchaser, if Vaddio receives notice of such defects during the warranty. Vaddio, at its option, will repair or replace products that prove to be defective. Vaddio manufactures its hardware products from parts and components that are new or equivalent to new in accordance with industry standard practices.

Exclusions: The above warranty shall not apply to defects resulting from improper or inadequate maintenance by the customer, customers applied software or interfacing, unauthorized modifications or misuse, mishandling, operation outside the normal environmental specifications for the product, use of the incorrect power supply, modified power supply or improper site operation and maintenance. OEM and special order products manufactured by other companies are excluded and are covered by the manufacturer's warranty.

Vaddio Customer Service: Vaddio will test, repair, or replace the product or products without charge if the unit is under warranty. If the product is out of warranty, Vaddio will test then repair the product or products. The cost of parts and labor charge will be estimated by a technician and confirmed by the customer prior to repair. All components must be returned for testing as a complete unit. Vaddio will not accept responsibility for shipment after it has left the premises.

Vaddio Technical Support: Vaddio technicians will determine and discuss with the customer the criteria for repair costs and/or replacement. Vaddio Technical Support can be contacted by email at support@vaddio.com or by phone at one of the phone numbers listed on support.vaddio.com.

Return Material Authorization (RMA) number: Before returning a product for repair or replacement request an RMA from Vaddio's technical support. Provide the technician with a return phone number, e-mail address, shipping address, product serial numbers and original purchase order number. Describe the reason for repairs or returns as well as the date of purchase. See the General RMA Terms and Procedures section for more information. RMAs are valid for 30 days and will be issued to Vaddio dealers only. End users must return products through Vaddio dealers. Include the assigned RMA number in all correspondence with Vaddio. Write the assigned RMA number clearly on the shipping label of the box when returning the product. All products returned for credit are subject to a restocking charge without exception. Special order product are not returnable.

Voided warranty: The warranty does not apply if the original serial number has been removed or if the product has been disassembled or damaged through misuse, accident, modifications, use of incorrect power supply, use of a modified power supply or unauthorized repair.

Shipping and handling: Vaddio will not pay for inbound shipping transportation or insurance charges or accept any responsibility for laws and ordinances from inbound transit. Vaddio will pay for outbound shipping, transportation, and insurance charges for all items under warranty but will not assume responsibility for loss and/or damage by the outbound freight carrier. If the return shipment appears damaged, retain the original boxes and packing material for inspection by the carrier. Contact your carrier immediately.

Products not under warranty: Payment arrangements are required before outbound shipment for all out of warranty products.

Index

A

- anatomy of the EZCamera Interface Module 9
- anatomy of the OneLINK device 8

C

- cable connectors 8-10
- cables 2, 10, 17, 20, 25, 30, 32, 36, 42
 - Cisco split 17, 25, 36, 42
 - maximum length 2, 10
 - null-modem 20, 25, 36, 42
 - Polycom fan-out, codec, terminating 32
 - Polycom fan-out, codec, terminating |
 - Models.All OneLINK HDMI |
 - Models.All OneLINK HDMI [54] 30
- capabilities 2
- cleaning 43
- configuring 20, 36, 42
 - AEC reference 20, 36, 42
- connection diagram 12-36, 38-42
 - block, HDBaseT camera 12
 - block, HDBaseT camera with codec 14
 - block, HDMI camera 21
 - block, HDMI camera with codec 28
 - Cisco Precision 40 24
 - Cisco Precision 40 with Cisco C20 38
 - Cisco Precision 40 with Cisco C40 39
 - Cisco Precision 40 with Cisco C60 39
 - Cisco Precision 40 with Cisco SX20 40
 - Cisco Precision 40 with Cisco SX80 41
 - Cisco Precision 60 25
 - Cisco Precision 60 with Cisco SX80 42
 - Cisco Precision HD 24
 - Cisco Precision HD with Cisco C20 38
 - Cisco Precision HD with Cisco C40 39
 - Cisco Precision HD with Cisco C60 39
 - Cisco Precision HD with Cisco SX20 40
 - Cisco Precision HD with Cisco SX80 41
 - Panasonic AW-HE130 26
 - Polycom EagleEye IV 23
 - Polycom EagleEye IV with Polycom RPG 310 31
 - Polycom EagleEye IV with Polycom RPG 500 31
 - Polycom EagleEye IV with Polycom RPG 700 32
 - RoboSHOT HDMI 22

- RoboSHOT HDMI with Cisco C20 33
- RoboSHOT HDMI with Cisco C40 34
- RoboSHOT HDMI with Cisco C60 34
- RoboSHOT HDMI with Cisco SX20 35
- RoboSHOT HDMI with Cisco SX80 36
- RoboSHOT HDMI with Polycom RPG 310 29
- RoboSHOT HDMI with Polycom RPG 500 29
- RoboSHOT HDMI with Polycom RPG 700 30
- Sony SRG120 27
- Sony SRG300 27
- Vaddio HDBaseT 13
- Vaddio HDBaseT with Cisco C20 17
- Vaddio HDBaseT with Cisco C40 18
- Vaddio HDBaseT with Cisco C60 18
- Vaddio HDBaseT with Cisco SX20 19
- Vaddio HDBaseT with Cisco SX80 20
- Vaddio HDBaseT with Polycom RPG 310 15
- Vaddio HDBaseT with Polycom RPG 500 15
- Vaddio HDBaseT with Polycom RPG 700 16
- visual conventions 12
- connectors 8-11
 - identification 8-9
 - pin-outs, RS-232 11
- customer-provided items 4, 6-7, 13, 15, 17, 22-24, 26, 29, 31, 33, 37

D

- damage, preventing 10

H

- hardware reset 8

I

- indicator lights 8
- installation 11
 - mounting 11
- IP address display 8
- IR forwarding 16, 30, 32
- items you will need 4, 6-7, 13, 15, 17, 22-24, 26, 29, 31, 33, 37

K

- key for connection diagrams 12

- kits 1, 3-7, 12-15, 17, 21-24, 26, 28-29, 31, 33, 37
 - for Cisco cameras 24
 - for Cisco cameras with Cisco codecs 6, 21, 28, 37
 - for Panasonic cameras 5, 21, 26
 - for Polycom cameras 23
 - for Polycom cameras with Polycom codecs 5, 21, 28, 31
 - for RoboSHOT HDMI cameras 4, 21-22
 - for RoboSHOT HDMI cameras with Cisco codecs 7, 28, 33
 - for RoboSHOT HDMI cameras with Polycom codecs 5, 28-29
 - for Sony cameras 5, 21, 26
 - for Vaddio HDBaseT cameras 3, 12-13
 - for Vaddio HDBaseT cameras with Cisco codecs 4, 14, 17
 - for Vaddio HDBaseT cameras with Polycom codecs 3, 14-15

L

- line types in diagrams 12
- locations of connectors 8-9

M

- MAC address display 8

O

- operating environment 43

P

- packing lists 3-7
 - 999-9595-000/001/009 3
 - 999-9620-000/001/009 5
 - 999-9630-000/001/009 5
 - 999-9640-000/001/009 5
 - 999-9645-000/001/009 3
 - 999-9660-000/001/009 6
 - 999-9670-000/001/009 7
 - 999-9675-000/001/009 4
 - 999-9690-000/001/009 4
- pin-outs 11
 - for RS-232 connectors 11
- power on/power off 43
- product capabilities 2
- product returns and repairs 46
- product SKUs 1, 3-7

R

- reset button location 8
- RJ-45 connectors, recommendation 10
- RS-232 adapter for Cisco products 20, 36, 42
- RS-232 connector pin-out 11

S

- storage environment 43

T

- temperature, operating and storage 43

W

- warranty 10, 46

Vaddio is a brand of Legrand AV Inc. · www.legrandav.com · Phone 800.572.2011 / +1.763.971.4400 · Fax +1.763.971.4464 · Email av.vaddio.support@legrand.com

Visit us at www.legrandav.com for firmware updates, specifications, drawings, manuals, technical support information, and more.

©2019 Legrand AV Inc.

Vaddio is a registered trademark of Legrand AV Inc. All other brand names or marks are used for identification purposes and are trademarks of their respective owners. All patents are protected under existing designations. Other patents pending.

A brand of  legrand®

Commercial AV Brands Chief | Da-Lite | Middle Atlantic | Projecta | Vaddio

vaddio®