



Integrator's Complete Guide to the

ConferenceSHOT FX

USB 3.0 Fixed Camera

Document 411-0015-30 Rev A
October 2017

Contents

Overview	1
What's in this Guide	1
Features	1
Unpacking the Camera	2
A Quick Look at the Camera	3
Back of the Camera	3
Switch Settings	4
Installation	5
Before You Install the Camera	5
Don't Void Your Warranty!	5
Cabling Notes	5
Installing the Wall Mount	6
About Ceiling-Mounted Cameras	6
Installing the Camera	7
Basic Connections	8
Powering Up the Camera	8
Status Light	8
Using the Remote Control	9
Quick Reference	9
Details	9
Storing a Preset Using the Remote	9
Web Interface	10
Browser Support	10
User Access	10
Administrative Access	11
Web Interface Quick Reference	12
Compact Menu View	12
System Administration	13
Configuring Network Settings	14
Setting Time Zone and NTP Server	15
Configuring Streaming Settings	16
Editing the USB Device Name	16
Allowing Soft Client Control of the Camera	16
Enabling or Disabling Streaming	16
Setting IP Streaming Settings	17
Advanced IP Streaming Settings	18
Managing Access and Passwords	18
Adding Room Information to the Screen	19
Rebooting the Camera	19
Saving or Restoring a Configuration	19

Starting a Firmware Update	20
Contacting Vaddio Technical Support	21
Viewing Diagnostic Logs	22
Configuring Camera Behavior	23
Color and Lighting Adjustments	23
Adjusting the Color Settings	24
Storing Color Settings with the Home Zoom Level or Other Zoom Preset	25
Setting Other Camera Behaviors	26
Operating the Camera	27
Stopping or Resuming Video	27
Managing the Camera Ready State	27
Zooming to a Preset Level	28
Storing a Zoom Preset	28
Telnet Serial Command API	29
camera home	30
camera zoom	30
camera focus	31
camera preset	31
camera ccu get	32
camera ccu set	33
camera led	34
camera standby	34
video mute	35
streaming settings get	36
network settings get	37
network ping	37
system reboot	38
system factory-reset	38
sleep	39
history	39
version	39
help	40
exit	40
RS-232 Serial Communication	41
Camera Zoom and Focus Commands	42
Color and Light Management Commands	43
Other Commands	44
Command Setting Values – Exposure Control	44
Iris Values	44
Iris Gain Values	45
Zoom and Focus Inquiry Commands	45

Color and Light Management Inquiry Commands	45
Other Inquiry Commands	45
Specifications	46
Troubleshooting and Care	47
Status Light	48
Restoring Default Camera Settings	48
Operation, Storage, and Care	49
Compliance Statements and Declarations of Conformity	50
FCC Part 15 Compliance	50
ICES-003 Compliance	50
European Compliance	51
Warranty Information	52
Index	53

Overview

This guide covers the ConferenceSHOT FX USB 3.0 fixed camera, worldwide part numbers 999-20000-000 (black) and 999-20000-000W (white).



What's in this Guide

This guide covers

- Unpacking and installation
- The camera's physical features and switch settings
- Controlling the camera using the IR remote or web interface
- Controlling the camera using Telnet or RS-232 commands
- Specifications
- Troubleshooting and maintenance
- Warranty and compliance/conformity information

For your convenience, this information is also available in smaller, limited-purpose manuals:

- **Installation Guide for the ConferenceSHOT FX USB 3.0 Fixed Camera** (unpacking, physical features, switch settings, installation, initial power-up)
- **Configuration and Administration Guide for the ConferenceSHOT FX USB 3.0 Fixed Camera** (physical features, controlling the camera, and troubleshooting)

Download manuals, dimensional drawings, and other information from www.vaddio.com/support.

Features

- Fixed USB 3.0 camera for small to medium conference rooms
- 2 Megapixel, native 1080p/60 (full HD) image sensor
- 3x optical zoom, horizontal field of view of 88°
- Simultaneous uncompressed USB 3.0 and IP (H.264) streaming outputs at resolutions up to 1080p/60
- Selectable IP stream resolution; USB stream resolution auto-negotiated with conferencing client
- Universal Video Class (UVC) drivers supported in Windows®, Mac® OS, and Linux operating systems, compatible with most UC conferencing applications
- Presenter-friendly IR remote control
- Integration-ready Telnet or serial RS-232 control
- Full administrative control via web interface; manage remotely while monitoring the stream separately.

Unpacking the Camera

Make sure you received all the items you expected.

Caution:

Use the power supply shipped with the camera. Using a different power supply may create an unsafe operating condition or damage the camera, and will void the warranty.

Caution

Always support the camera's body when picking it up. Lifting the camera by its head or mounting arm will damage it.



ConferenceSHOT FX camera, black, part number 999-20000-000

The box should contain one of each item listed here:

- Camera, part number 998-20000-000
- Thin Profile Wall Mount with mounting hardware, black
- 12 VDC, 1.5 Amp switching power supply with AC plug adapters
- USB 3.0 Type A to Type B cable, 6 ft. (1.8 m)
- Remote control
- Quick Start Guide



ConferenceSHOT FX camera, white, part number 999-20000-000W

The box should contain one of each item listed here:

- Camera, part number 998-20000-000W
- Thin Profile Wall Mount with mounting hardware, white
- 12 VDC, 1.5 Amp switching power supply with AC plug adapters
- USB 3.0 Type A to Type B cable, 6 ft. (1.8 m)
- Remote control
- Quick Start Guide



A Quick Look at the Camera



- **Camera and Zoom Lens:** The ConferenceSHOT FX camera features a 3X optical zoom lens.
- **IR sensor:** Receives signals from the remote. Make sure there's nothing directly in front of the camera base, and point the remote at the camera.
- **Status light:** The multi-colored LED indicates the camera's current state, unless it has been turned off.

Note

The camera may be powered up and sending video even if the status light is off.

Back of the Camera



- **12 VDC, 1.5 amp power connector** – Connect only the power supply shipped with the camera
- **USB 3.0 type B video device connector** – Streams uncompressed UVC standard video
- **Ethernet RJ-45** – Connect to the network for IP streaming and camera control via web interface or Telnet
- **DIP switches** – Set IR frequency and image flip (camera is invertible)
- **RS-232 port** – Connect to a controller to manage the camera using a modified VISCA protocol

Switch Settings

The camera uses DIP switches to determine certain camera functions.

A label on the bottom of the camera provides a quick reference for setting the switches.

When the camera is right side up, switches are in their default positions when they are up.

IR Frequency Selection: The IR Remote Commander can control up to three cameras in the same room with different IR frequencies. Use **switches 1 and 2** to select the frequency to identify the camera as camera 1, 2, or 3; then use the Camera Select buttons at the top of the remote to select the camera you want to control.

Inverted operation: If mounting the camera upside-down, set **switch 3** to the DOWN position: IMAGE FLIP ON.

Switch 4 is not currently used.

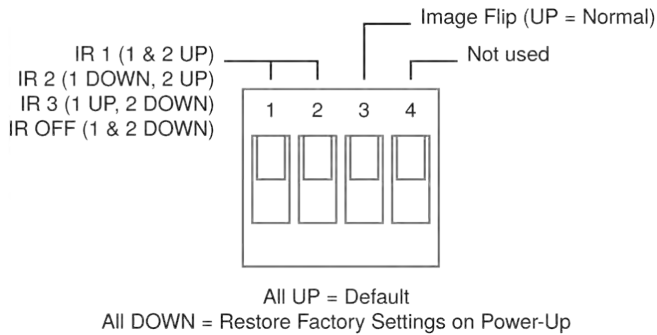

Note

The web interface provides additional switch settings for baud rate, status indicator behavior, and soft client compatibility.

Installation

This section covers siting the camera, installing the mount, and installing the camera.

Before You Install the Camera

All ConferenceSHOT cameras include a wall mount. Other mounting options are available as well. Contact us if you don't have the camera mount you need.

- Choose a camera mounting location that will optimize camera performance. Consider camera viewing angles, lighting conditions, line-of-sight obstructions, and in-wall obstructions where the camera is to be mounted.
- Ensure that the camera can be pointed appropriately from the desired location. The camera will not perform well if it is pointed toward a light source such as a light fixture or window.
- Follow the installation instructions included with the camera mount.

Don't Void Your Warranty!

Caution

This product is for indoor use. Do not install it outdoors or in a humid environment without the appropriate protective enclosure. Do not allow it to come into contact with any liquid.

Use only the power supply included with this product. Using a different one will void the warranty, and could create unsafe operating conditions or damage the product.

Do not install or operate this product if it has been dropped, damaged, or exposed to liquids. If any of these things happen, return it to Vaddio for safety and functional testing.

Learn more at www.vaddio.com/products.

Cabling Notes

Note

Use standard RJ-45 connectors and a good crimping tool. Do not use pass-through RJ-45 connectors. Poorly crimped connectors can damage the connectors on the product, cause intermittent connections, and degrade signal quality. Test cable pin-outs and continuity before connecting them.



Intact – Contact fingers will make reliable contact with the cable connector



Damaged – Some contact fingers are bent and will NOT make reliable contact with the cable connector

Pro Tip

Label all cables at both ends.

Installing the Wall Mount

You can install the camera wall mount to a 2-gang wall box or directly to the drywall.

- If you mount it to drywall, use the wall anchors provided with the wall mount.
- If you mount it to a wall box, use the cover plate screws supplied with the wall box.

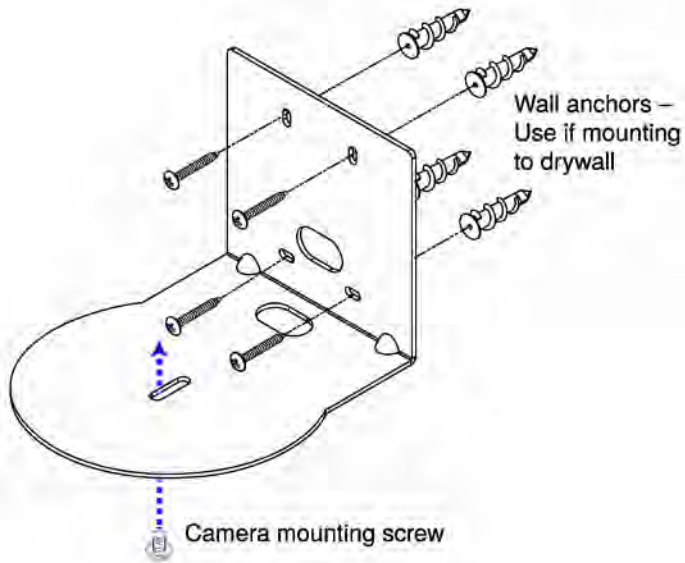

About Ceiling-Mounted Cameras

If you use an inverted mount, the camera will need to be configured for inverted operation. See [Setting Switches in the Web Interface](#).

Installing the Camera

Caution

Before you start, be sure you can identify all cables correctly. Connecting a cable to the wrong port can result in equipment damage.

Caution:

Check Cat-5 cables for continuity before using them. Using the wrong pin-out may damage the camera system and void the warranty. Pro tip: Label your cables.

1. Route the cables through the opening in the mounting shelf.
2. Connect the cables to the camera.

Caution:

Use the power supply shipped with the camera. Using a different power supply will damage the camera and void the warranty, and may create an unsafe operating condition.

3. Place the camera on the mount.
4. Attach the camera to the mount using the 1/4"-20 x .375 mounting screw supplied with the camera.

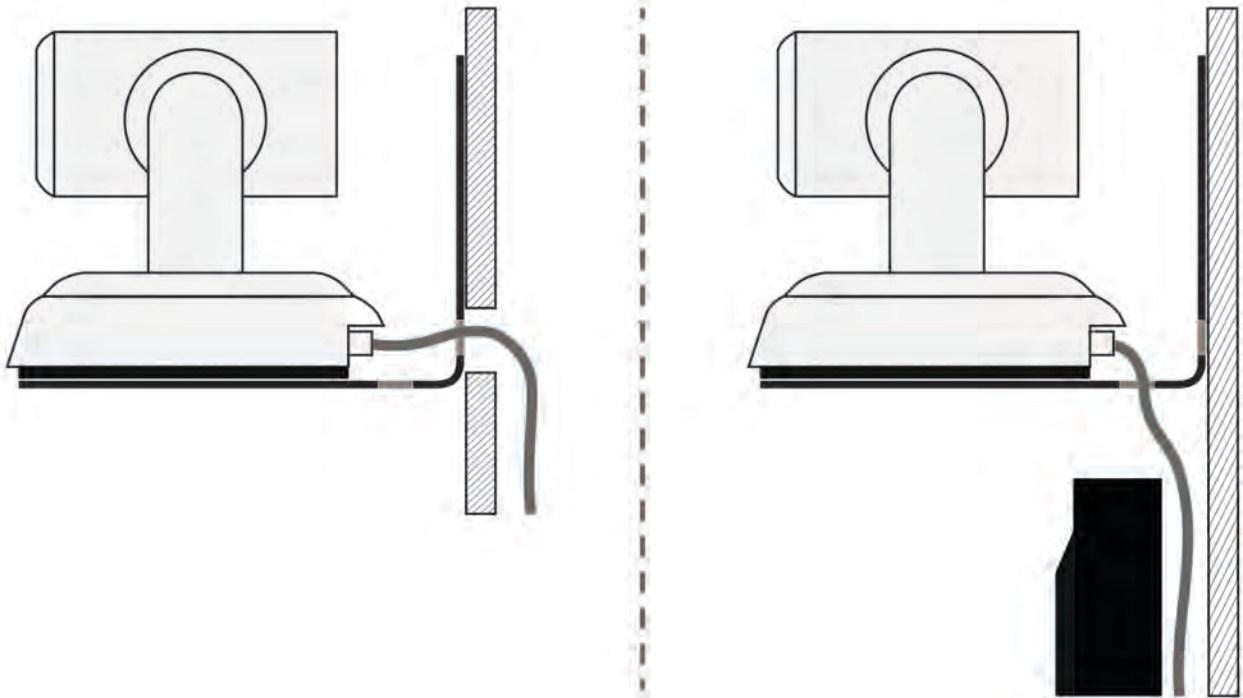

Image for illustration only; not to scale. Camera and mount details may differ.

Note

This is a fixed camera. After it is powered up and sending video, it will need to be positioned by hand.

Basic Connections

Here is an example of how the camera might be set up in a conference room. In this setup, a computer uses a unified communications conferencing application with the camera and a conference phone.

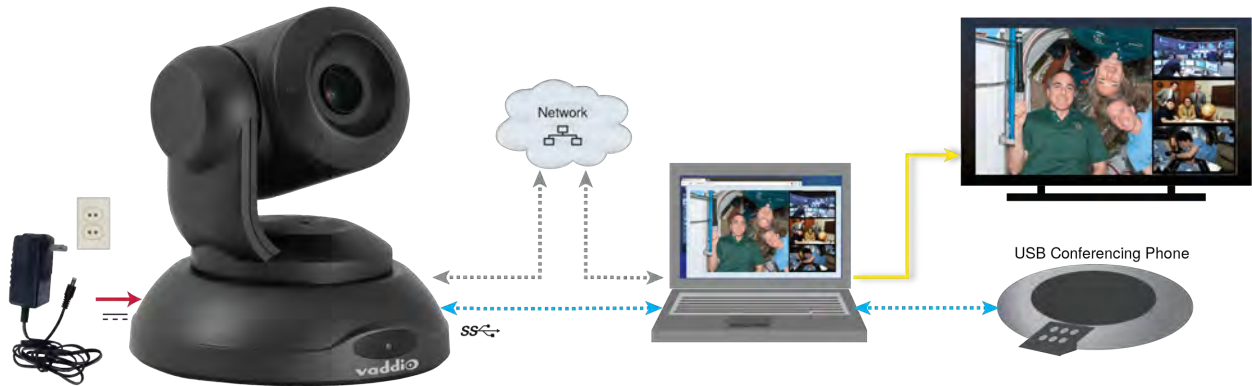

Powering Up the Camera

Connect camera power.

The status light illuminates purple as the camera initializes. When the camera is ready and a video stream is available, the light changes to blue.

Turn and tilt the camera as needed to position it for the desired view.

Status Light

The light in the camera's base indicates its current state.

- Blue – Camera is active
- Purple – Standby mode or booting
- Yellow – Firmware update is in progress
- Blinking blue – USB cable is disconnected
- Blinking purple – Error

Caution

Do not remove power or reset the camera while the indicator is yellow, showing a firmware update in progress. Interrupting a firmware update can make the camera unusable.

Note

The camera may be powered up and sending video even if the status light is off.

Using the Remote Control

The remote provides basic camera control.

Quick Reference

What do you need to do?	Button(s)
Power on or standby	Power (button at top right)
Select the camera to control (if this remote controls more than one)	IR 1 , IR 2 , and IR 3 buttons
Discover the camera's IP address	OSD button (top left) – press and hold for 3 seconds
Return the camera to its home zoom position	OK button
Move the camera to a preset zoom	Preset 1 and Preset 2 buttons (lower left)
Change zoom	Zoom Out and Zoom In buttons

Details

The remote provides the following functions:

OSD (On-Screen Display) – Press and hold for 3 seconds to display the camera's IP address and MAC address on the near-end display. Press momentarily to dismiss the information.

Power indicator – Shows power on, IR transmission, and battery level.

Power – Switch the selected camera on or off.

Arrow buttons – Non-functional, so they're perfect for fidgeting.

OK – Return to the camera's home zoom level.

Zoom Out and **Zoom In** – Change the zoom.

P-Store – Preset store. Hold while pressing Preset 1 or Preset 2 to store a preset.

Preset 1 and **Preset 2** – Zoom the camera to a preset zoom level. Presets may include color settings if defined through the web interface, which provides access to 16 presets.

IR 1, **IR 2**, and **IR 3** – In multi-camera installations, selects the camera to be controlled.



Storing a Preset Using the Remote

Zoom to the desired level. Then hold down the **P-Store** button while pressing **Preset 1** or **Preset 2**.

Web Interface

The camera provides a web interface to allow control via an Ethernet network connection, using a browser. In addition to the user-level camera control that the IR remote offers, the web interface allows password-protected administrative access to tasks such as setting passwords, changing the IP address, viewing diagnostics, and installing firmware updates.

You will need to know the camera's IP address to use the web interface. If the LAN has a DHCP server, the camera will get its IP address, gateway and routing information automatically and you will be able to browse to it. If not, you will need to configure the camera to use a static IP address.

To display the camera's IP address during set-up:

1. Connect the camera to the network, and connect the camera's USB cable to your computer. Then power up the camera. If necessary, your computer loads the appropriate USB driver.
2. Open a media player. The camera is available as a capture device.
3. Play the video capture from the camera.
4. Point the remote at the camera and press the OSD button. The camera overlays its IP address and MAC address on the video output.
5. Press the button again to dismiss the information display.

If the camera has already been configured and video is available, all you need to do is use the remote.

If the address is 169.254.1.1, the camera is using its default IP address and you will need to configure it for your network. You can configure the camera's static IP address either through the network or from a computer connected directly to its Ethernet port. You may need a crossover cable.

Note

Work with your IT department to determine the correct IP address, subnet mask, and gateway information.

To access the web interface:

Enter the IP address or hostname in your browser's address bar. If you use the hostname, you may need to enter `http://` as a prefix to keep the browser from treating it as a search query.

Browser Support

Vaddio tests with these web browsers:

- Chrome® (latest version),
- Microsoft® Internet Explorer® (versions 8 through 11)
- Safari® (versions 6 and 7)
- Firefox® (latest version),

Other browsers may also work.

User Access

By default, the web interface opens to the Controls page without requiring a login; but if the administrator has changed the guest access setting, you will need to log in. The default user password is **password**. Only the camera control page is available with user-level access.

Administrative Access

If you are on the Controls screen, you're logged in at the user level, or guest access is enabled and you're not logged in at all. Open the menu to log in as admin.

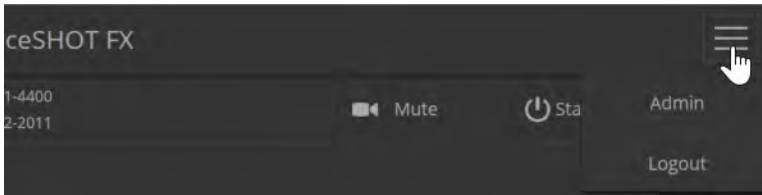

The default admin password is **password**.

Logging in as Admin gives you access to configuration and system administration tasks:

- Camera – Additional control over camera behavior related to camera zoom and color management.
- Streaming – USB device settings and IP (H.264) streaming.
- Room Labels – Information to display on the web interface screens, including the conference room name and phone number and the in-house number for AV assistance.
- Networking – Ethernet configuration.
- Security – Set passwords and manage guest access.
- Diagnostics – View or download logs when troubleshooting issues.
- System – View firmware version and hardware switch settings, access soft DIP switches, reboot, restore factory defaults, and run firmware updates.
- Help – Tech support contact information and a link to the product information library on the Vaddio website.
- Logout – Leave the web interface in a password-protected state. If guest access is on, this returns the web interface to the Controls page at guest access level.

Web Interface Quick Reference

Where to find the controls you need right now.

What do you need?	Go to this page
Camera operation <ul style="list-style-type: none"> ■ Stop sending video (video mute) ■ Enter or exit standby mode 	(any page)
Camera operation <ul style="list-style-type: none"> ■ Zoom the camera manually ■ Go to a zoom preset ■ Return to the "home" zoom level 	Controls (User or guest access page) Camera (when logged in as admin)
Camera behavior <ul style="list-style-type: none"> ■ Set up zoom presets, including the Home zoom level ■ Focus the camera (Focus button reveals the focus control) ■ Adjust color settings ■ Specify whether to use automated adjustments (auto-iris, auto white balance, backlight compensation) 	Camera
Access management <ul style="list-style-type: none"> ■ Guest access ■ Account passwords ■ Automatic logout for idle sessions 	Security
USB and IP streaming settings	Streaming
Other IP settings <ul style="list-style-type: none"> ■ Hostname ■ DHCP or static addressing ■ Static: IP address, subnet mask, gateway 	Networking
Date and time, time zone, and NTP server	Networking
Information about the camera <ul style="list-style-type: none"> ■ Room location and phone number ■ Help desk phone number 	Room Labels
Vaddio Technical Support contact information	Help
Diagnostic logs	Diagnostics

Compact Menu View

By default, the navigation buttons in the administrative interface display an icon and a text label.

The web interface provides a compact view of the menu buttons along with the standard view. The button at the bottom of the menu toggles between the two views.

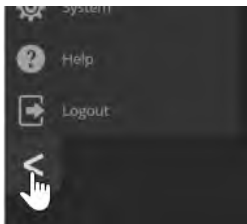

System Administration

Administrative tasks are on these pages:

- Networking – Ethernet configuration.
- Streaming – USB device settings and IP (H.264) streaming.
- Security – Set passwords and manage guest access.
- Room Labels – Information to display in the web interface, such as the room location and phone number and the in-house number for AV assistance.
- System – Firmware version and hardware switch settings, soft DIP switches, controls to reboot, restore factory defaults, and run firmware updates.
- Help – Tech support contact information and a link to the product information library.
- Diagnostics – View or download logs when troubleshooting issues.

Configuring Network Settings

NETWORKING PAGE

Editable network settings include:

- The camera's hostname
- Choice of static IP addressing or DHCP addressing
- IP address, subnet mask, and gateway, if static IP addressing is used

If your network supports hostname resolution, you may find it convenient to change the camera's hostname.

DHCP is the default setting, but the camera will use the default address of 169.254.1.1 if no DHCP server is available. You will only be able to enter the IP address, subnet mask, and gateway if you set IP Address to Static.

Caution

Consult your IT department before editing network settings. Errors in network configuration can make the camera and its IP stream inaccessible from the network. Do not change DHCP/Static addressing, IP address, subnet mask, or gateway unless you are very familiar with the characteristics and configuration of the network where you install the camera.

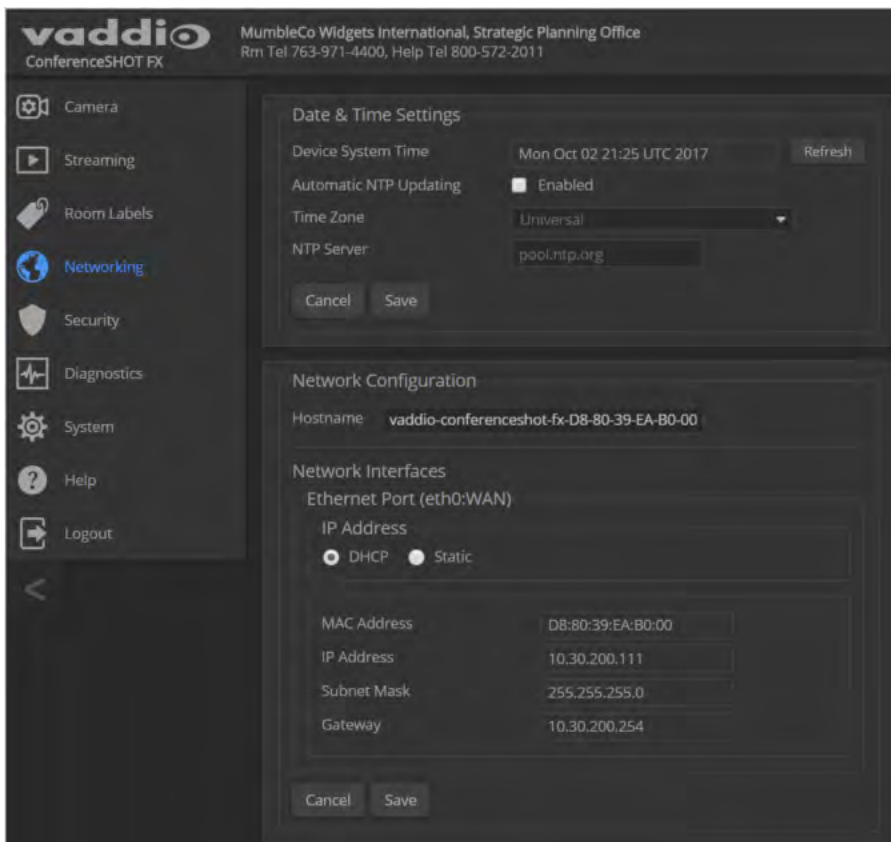

Setting Time Zone and NTP Server

NETWORKING PAGE

Currently, time and date information is only used for the timestamps in the diagnostic log.

Unless you use a time server on your own network, you must have internet connectivity to access an NTP server. If you have internet connectivity, you do not need to change the default NTP server information.

1. To make the time zone and NTP server editable, enable Automatic NTP Updating.
2. Select the desired time zone from the list.
3. If desired, specify the NTP server to use. If you are not sure about this, use the default.

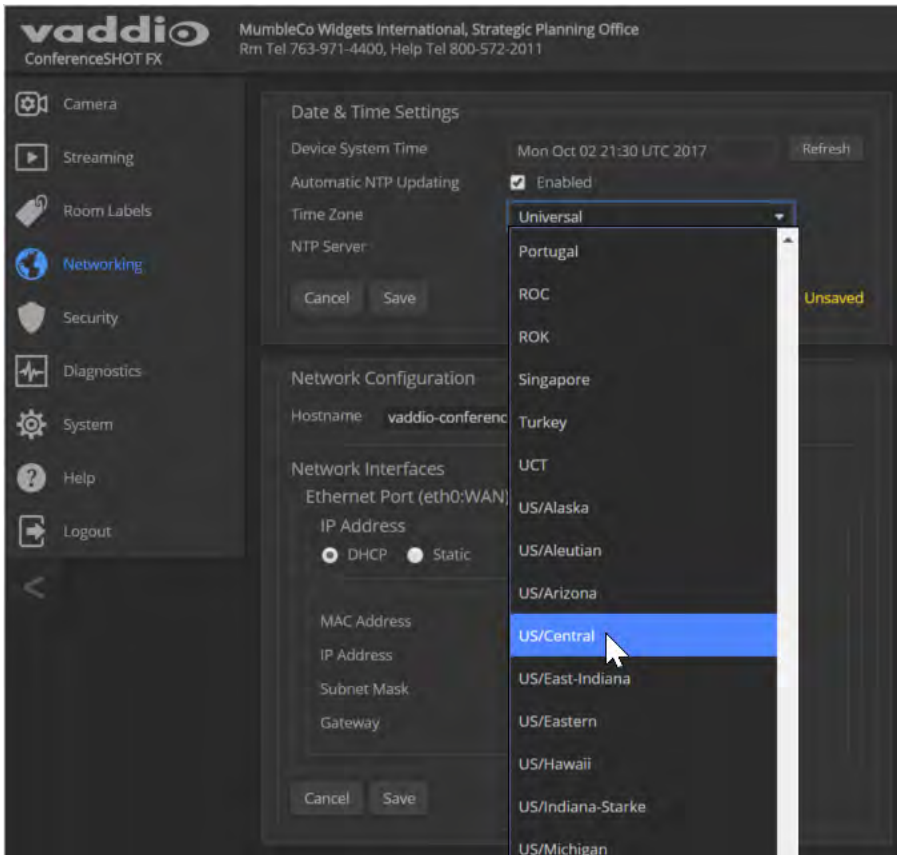

Configuring Streaming Settings

STREAMING PAGE

Streaming settings include:

- The USB device name
- Soft client control of the camera
- IP streaming and USB streaming enable/disable controls
- Resolution, video quality, and frame rate for IP streaming
- IP streaming port and path/URL

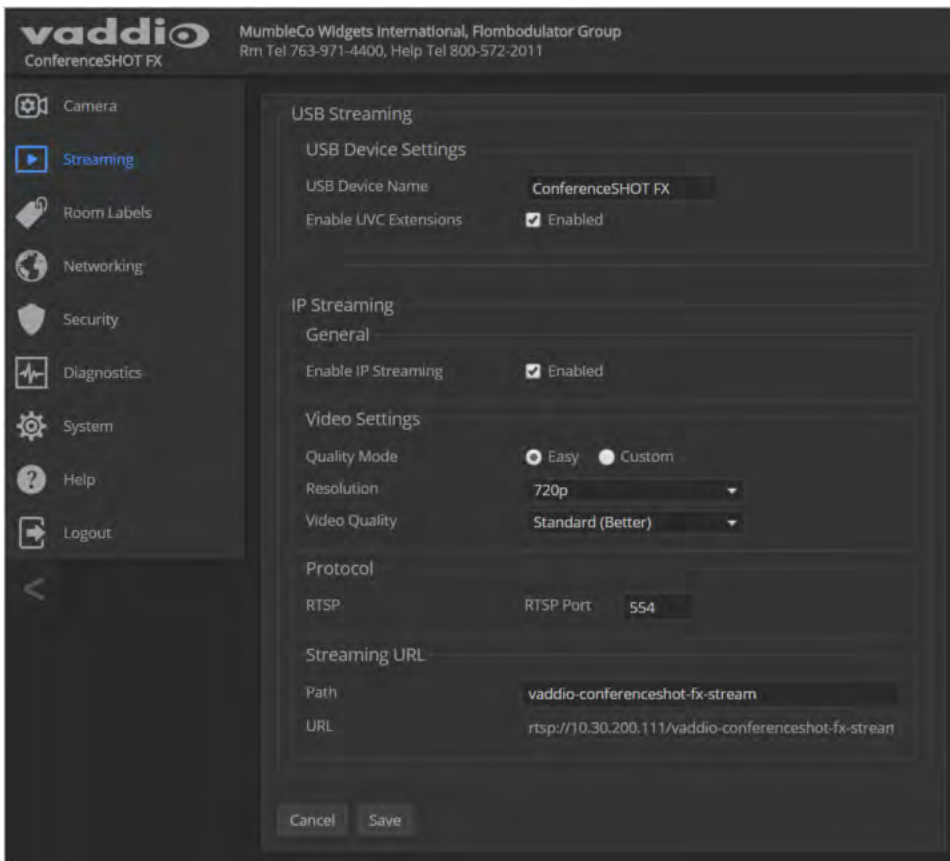

After making changes on this page, save them.

Editing the USB Device Name

To change the way the camera shows up in your soft client's camera selection list, edit the USB Device Name.

Allowing Soft Client Control of the Camera

To allow conferencing applications to control the camera, check the box marked Enable UVC Extensions.

Enabling or Disabling Streaming

IP and USB streaming are enabled by default. Use the Enable USB Streaming and Enable IP Streaming checkboxes to change this.

Setting IP Streaming Settings

If you are not sure about these settings, start with the defaults.

1. Select the video Quality Mode: Easy or Custom. Easy automatically sets the recommended frame rate; Custom provides additional control.
2. Select the desired IP streaming resolution.
3. Easy quality mode only: Select Video Quality.

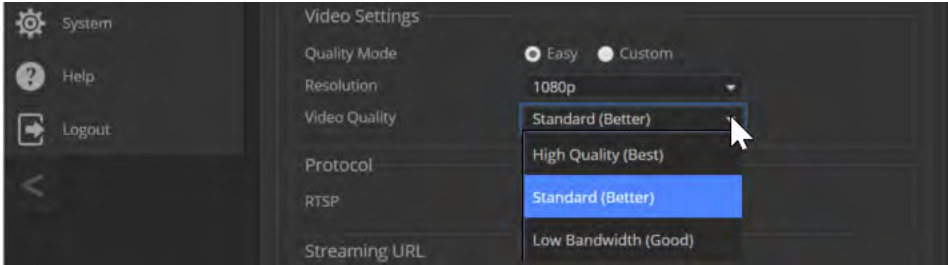

4. Custom quality mode only: Select the desired IP streaming frame rate.

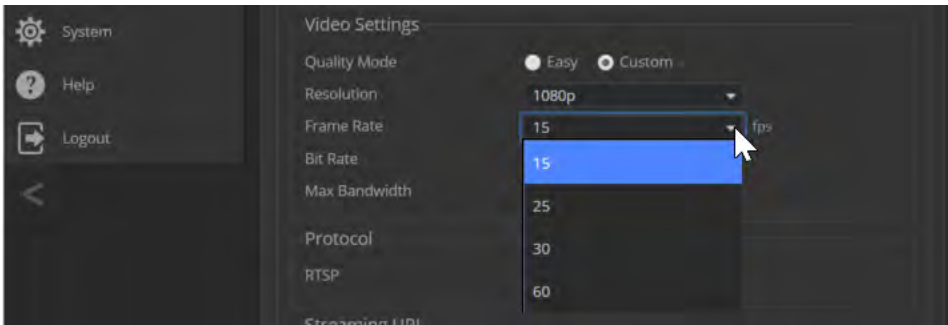

5. Custom quality mode only: Select Constant or Variable bit rate.
6. Custom quality mode only: Select Bandwidth for Constant Bit Rate or Quality (Quantization) for Variable bit rate.

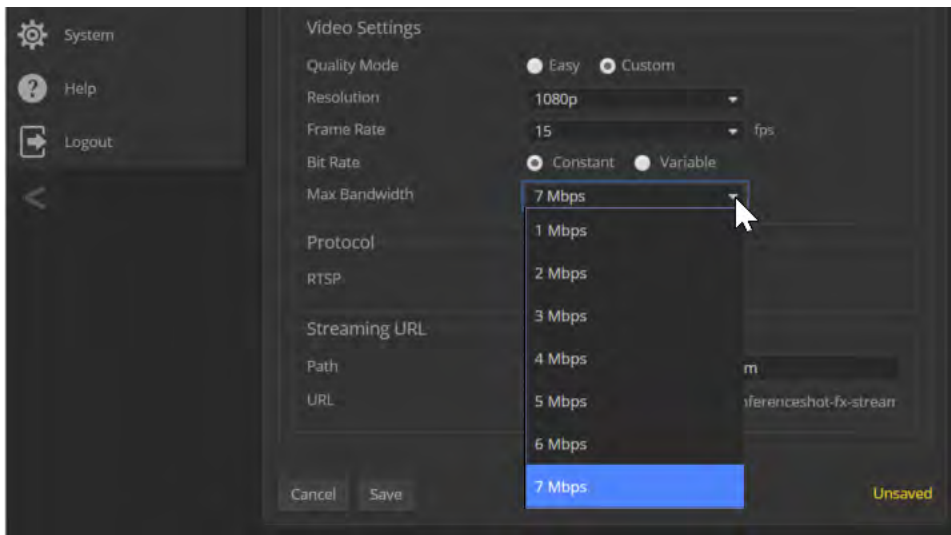

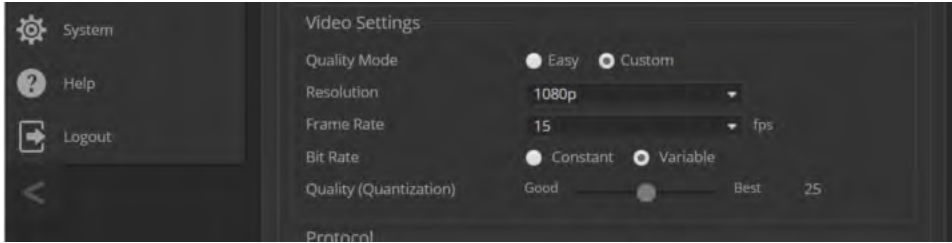
**Note**

USB streaming resolution and frame rate are automatically negotiated between the camera and the conferencing application.

Advanced IP Streaming Settings

Consult your IT department before changing these.

RTSP port: Vaddio strongly recommends using the default RTSP port number unless you need to change it. Consult your IT department.

Streaming URL: Edit the path to change the portion of the streaming URL that appears after the IP address, if necessary.

Managing Access and Passwords

SECURITY PAGE

Things you can do on this page:

- Change the password for the admin account (default is **password**)
- Change the password for the user account (default is **password**)
- Allow people to access the Controls screen without logging on (Allow Guest Access) – by default, guest access is permitted
- Set whether inactive sessions log off automatically or not – by default, inactive sessions expire after 30 minutes

Note

For best security, Vaddio strongly recommends changing the user and admin passwords. Using the default passwords leaves the product vulnerable to tampering. Be sure you have a way to remember the passwords after changing them.

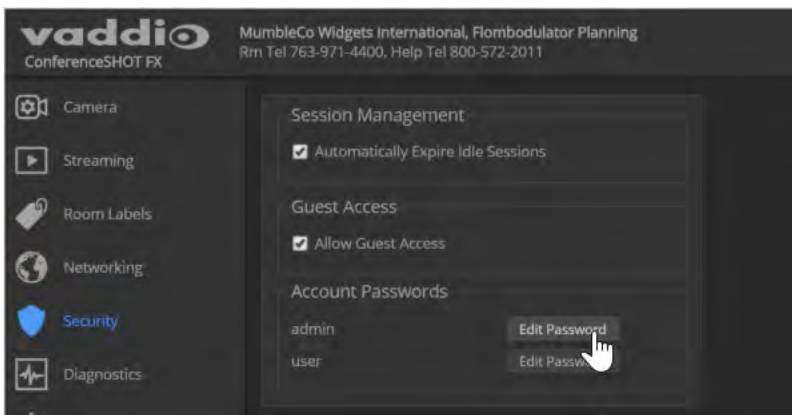

Adding Room Information to the Screen

ROOM LABELS PAGE

Enter your organization's name, the conference room name and phone number, and the number for people to call for in-house A/V support. This information is displayed on every page of the web interface.



Rebooting the Camera

SYSTEM PAGE, FIRMWARE TAB

This can help if the camera stops responding as you expect. In the System Utilities section, click Reboot.

Saving or Restoring a Configuration

SYSTEM PAGE, FIRMWARE TAB

If you need to configure several cameras the same way, you can configure the first one, export its configuration, and then import the configuration to the other cameras. The export downloads to your computer as a .dat file. The filename is the camera's hostname.

Note

The camera cannot import a .dat file that was exported from a camera using a different version of software.

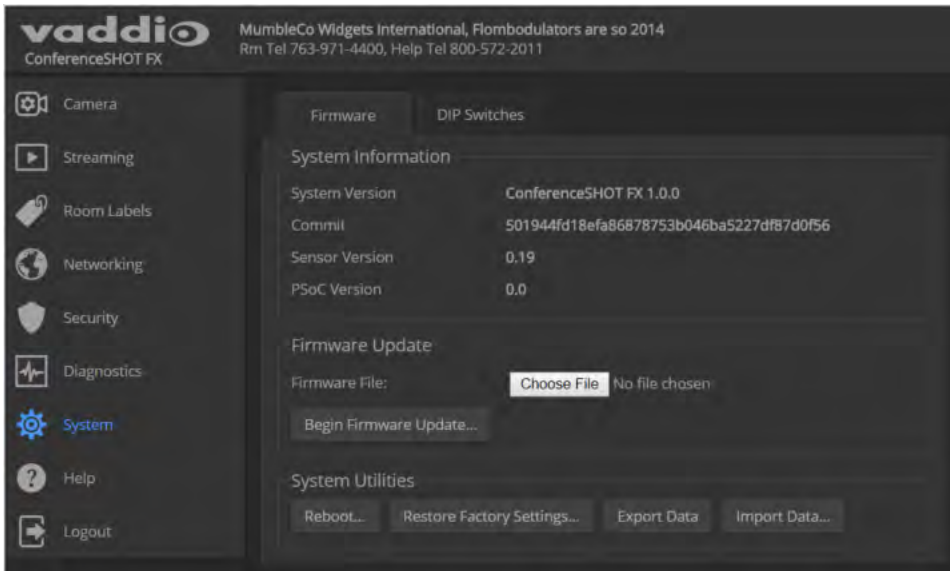

Starting a Firmware Update

SYSTEM PAGE, FIRMWARE TAB

1. Be sure you have downloaded the appropriate update file to your computer.
2. Click Choose File and select the update file.
3. Click Begin Firmware Update.
4. READ the information in the Confirm dialog box and be sure you understand it. It may seem boring, but it could save you some time and aggravation.
5. When you are ready to start the update, click Continue. A progress message box opens and the indicator light on the front of the camera turns yellow to show the firmware update is in progress. If the update process presents warnings or error messages, read them carefully.
The camera reboots when the update is complete.
6. Contact Vaddio technical support if you encounter any problems with the update.

Caution

Do not remove power or reset the camera while the indicator is yellow, showing a firmware update in progress. Interrupting a firmware update can make the camera unusable.

Contacting Vaddio Technical Support

HELP PAGE

If you can't resolve an issue using your troubleshooting skills (or the [Troubleshooting](#) table in this manual), we are here to help.

You'll find information for contacting Vaddio Technical Support on the Help screen.



Viewing Diagnostic Logs

DIAGNOSTICS PAGE

If you encounter a problem that you can't solve, your Vaddio technical support representative may ask you to download and email the log file available from the Diagnostics screen.

The screenshot shows the Vaddio web interface for the ConferenceSHOT FX camera. The top header includes the Vaddio logo, contact information for MumbleCo Widgets International, and controls for Mute, Standby, and Logout. The left sidebar contains navigation icons for Camera, Streaming, Room Labels, Networking, Security, Diagnostics (highlighted in blue), System, Help, and Logout. The main area is titled 'Diagnostics' and displays a terminal window with the following log output:

```

Oct 2 18:52:01 vaddio-conferenceshot-fx-D8-80-39-EA-B0-00 [ 0.883075] TCP: cubic registered
Oct 2 18:52:01 vaddio-conferenceshot-fx-D8-80-39-EA-B0-00 [ 0.886387] Initializing XFRM netlink socket
Oct 2 18:52:01 vaddio-conferenceshot-fx-D8-80-39-EA-B0-00 [ 0.890587] NET: Registered protocol family 17
Oct 2 18:52:01 vaddio-conferenceshot-fx-D8-80-39-EA-B0-00 [ 0.895056] 8021q: 802.1Q VLAN Support v1.8
Oct 2 18:52:01 vaddio-conferenceshot-fx-D8-80-39-EA-B0-00 [ 0.899291] Registering SWP/SWPB emulation handler
Oct 2 18:52:01 vaddio-conferenceshot-fx-D8-80-39-EA-B0-00 [ 0.904811] regulator-dummy: disabling
Oct 2 18:52:01 vaddio-conferenceshot-fx-D8-80-39-EA-B0-00 [ 0.913800] Waiting for root device /dev/mmcblk0p3...
Oct 2 18:52:01 vaddio-conferenceshot-fx-D8-80-39-EA-B0-00 [ 0.920842] mmc0: new high speed SD card at address b368
Oct 2 18:52:01 vaddio-conferenceshot-fx-D8-80-39-EA-B0-00 [ 0.926737] mmcblk0: mmc0:b368 AF UD 471 MiB
Oct 2 18:52:01 vaddio-conferenceshot-fx-D8-80-39-EA-B0-00 [ 0.935559] mmcblk0: p1 p2 p3 p4 < p5 p6 p7 p8 >
Oct 2 18:52:01 vaddio-conferenceshot-fx-D8-80-39-EA-B0-00 [ 1.031137] VFS: Mounted root (ext4 filesystem) readonly
Oct 2 18:52:01 vaddio-conferenceshot-fx-D8-80-39-EA-B0-00 [ 1.040868] devtmpfs: mounted
Oct 2 18:52:01 vaddio-conferenceshot-fx-D8-80-39-EA-B0-00 [ 1.044064] Freeing unused kernel memory: 168K (c043a000
Oct 2 18:52:01 vaddio-conferenceshot-fx-D8-80-39-EA-B0-00 [ 1.935768] lirc_gpio lirc_gpio.0: lirc_dev: driver lirc
Oct 2 18:52:01 vaddio-conferenceshot-fx-D8-80-39-EA-B0-00 [ 1.943514] lirc_gpio: driver registered!
Oct 2 18:52:01 vaddio-conferenceshot-fx-D8-80-39-EA-B0-00 [ 1.947580] lirc_gpio: using active low receiver on GPIC
Oct 2 18:52:01 vaddio-conferenceshot-fx-D8-80-39-EA-B0-00 [ 3.111630] random: dd urandom read with 58 bits of entr
Oct 2 18:52:03 vaddio-conferenceshot-fx-D8-80-39-EA-B0-00 [ 7.208615] ramoops: nonblocking pool is initialized
Oct 2 18:52:11 vaddio-conferenceshot-fx-D8-80-39-EA-B0-00 [ 15.035611] xemacps e000b000.ps7-ethernet: Set clk to 0
Oct 2 18:52:11 vaddio-conferenceshot-fx-D8-80-39-EA-B0-00 [ 15.041135] xemacps e000b000.ps7-ethernet: link up (100
Oct 2 18:52:22 vaddio-conferenceshot-fx-D8-80-39-EA-B0-00 usbctl-service: _deal_with_usb_inquiry: no cached privacy v
Oct 2 18:52:22 vaddio-conferenceshot-fx-D8-80-39-EA-B0-00 usbctl-service: _execute_uvc_packet: VideoService failed tc
Oct 2 18:52:23 vaddio-conferenceshot-fx-D8-80-39-EA-B0-00 usbctl-service: _handle_usb_controller_packet exceptions.Ke
Oct 2 18:52:23 vaddio-conferenceshot-fx-D8-80-39-EA-B0-00 usbctl-service: Traceback (most recent call last):
Oct 2 18:52:23 vaddio-conferenceshot-fx-D8-80-39-EA-B0-00 File "/usr/lib/python2.7/site-packages/vng_mv_usbctl/usbctl
Oct 2 18:52:23 vaddio-conferenceshot-fx-D8-80-39-EA-B0-00 File "/usr/lib/python2.7/site-packages/vng_mv_usbctl/usbctl
Oct 2 18:52:23 vaddio-conferenceshot-fx-D8-80-39-EA-B0-00 File "/usr/lib/python2.7/site-packages/vng_mv_usbctl/usbctl
Oct 2 18:52:23 vaddio-conferenceshot-fx-D8-80-39-EA-B0-00 KeyError: 'user_value'

```

At the bottom of the terminal window, there are four buttons: Download, Refresh, Clear, and Restore.

Configuring Camera Behavior

Camera configuration tasks include:

- Setting the home zoom level and other zoom presets
- Adjusting color and lighting settings
- Setting the status light behavior

Color and Lighting Adjustments

CAMERA PAGE

The Camera page lets you do these things:

- Set up the color settings the camera uses.
- Set zoom presets that will be available to the operator.

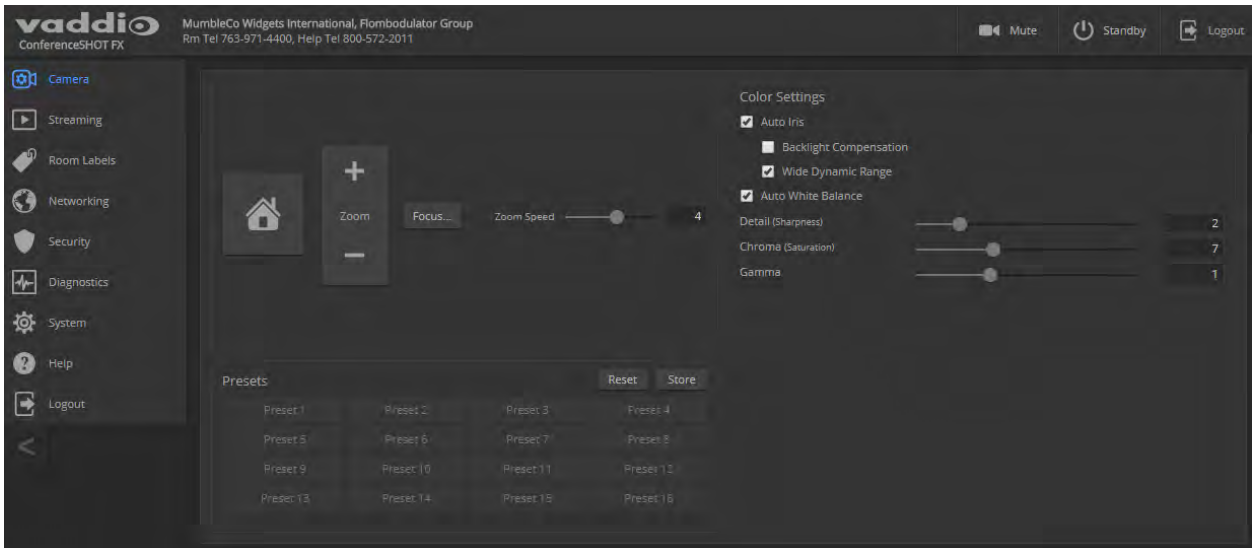

Adjusting the Color Settings

1. To allow the camera to compensate automatically for the light level, check the Auto Iris box. Leave it unchecked to adjust iris and gain manually.
2. Auto Iris adjustments – these adjust contrast between the brightest and darkest areas of the image.
 - If there is bright light behind the main subject of the shot, check the box for Back Light Compensation.
 - To increase contrast between the brightest and darkest areas, check the box for Wide Dynamic Range.

Because Backlight Compensation reduces the contrast between extremes and Wide Dynamic Range increases it, they cannot be used together.

3. To allow the camera to adjust the white balance automatically, check the Auto White Balance box. Leave it unchecked to adjust red gain and blue gain manually.
4. Detail – adjust the slider as required for the right image sharpness.

Note

If the video looks grainy or “noisy,” try a lower Detail setting.

5. Chroma – adjust the slider as needed for the right level of color intensity.
6. Gamma – adjust the slider as needed for the desired range between bright areas and shadows.

If you make a change that you don't like, start over by selecting and then deselecting Auto White Balance.



Storing Color Settings with the Home Zoom Level or Other Zoom Preset

If there is a view that will be used repeatedly, you can save the zoom level and color settings together as a preset. Home, Preset 1, and Preset 2 are available from the remote; all stored presets are available from the web interface.

1. Adjust the zoom to the desired level.
2. Adjust the color settings as needed.
3. Select Store to open the Store Preset box. Presets that have already been defined are highlighted.

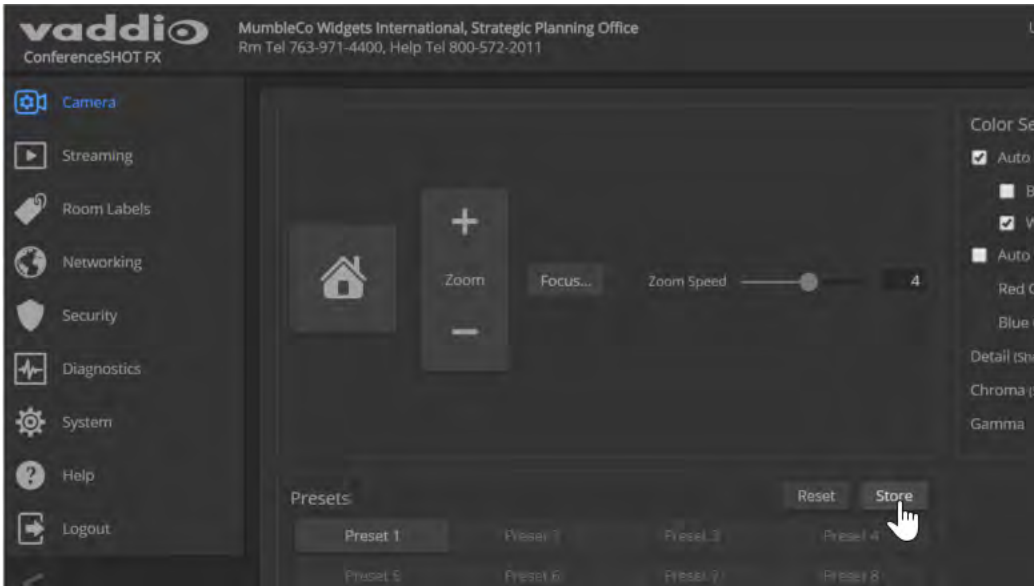

4. Select the preset to store. The checkbox for storing color settings appears, as if by magic. Select it if you want to associate the current color settings with this preset.

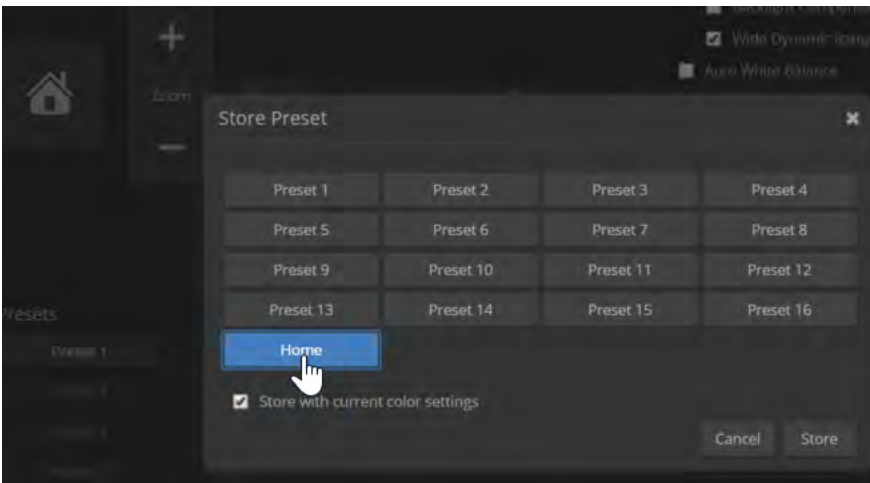

5. Save your work.

Setting Other Camera Behaviors

SYSTEM PAGE

The DIP Switches tab of the System page provides access to these features:

Baud Rate (9600 bps or 38400 bps) – RS-232 serial communication rate.

Status light color scheme (Pro AV or UCC) – Select the status light color scheme that meets your needs. The Pro AV color scheme matches the color scheme used in Vaddio's non-USB cameras.

Status light on/off – In most cases, we recommend leaving the status light on, to let people in the room know whether the camera is currently sending video.

USB stream format (UVC Compliant or Client Custom) – Client Custom enables far-end camera control when used with the Zoom soft client.

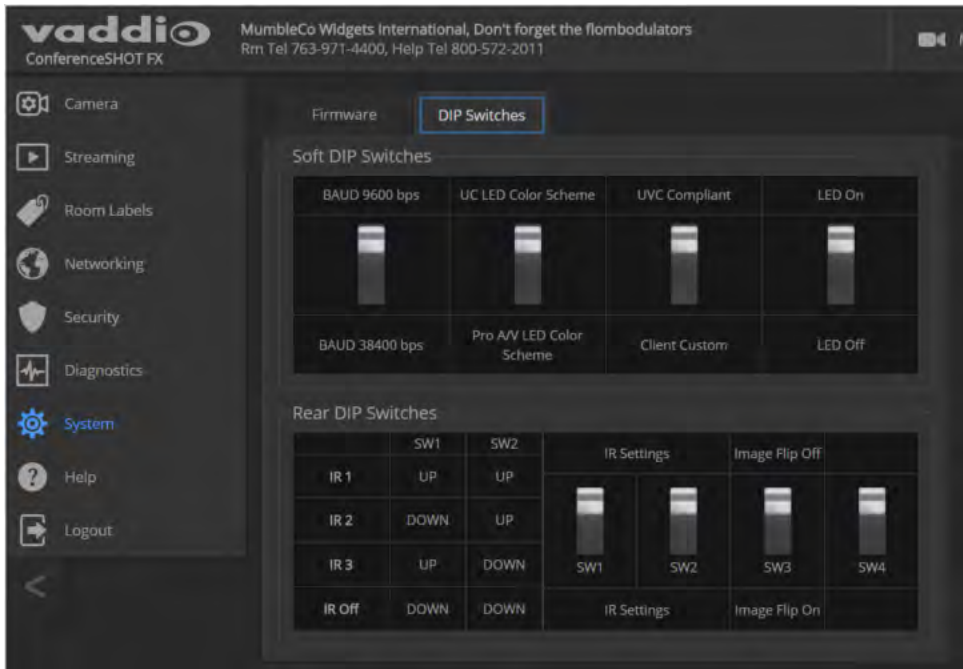

Note

The camera may be powered up and sending video even if the status light is off.

Operating the Camera

CONTROLS PAGE (USER OR GUEST ACCESS)

The Controls page provides most of the same controls as the IR Remote Commander, along with some that are not available from the remote:

- [Stop or resume transmitting live camera video](#) (video mute)
- [Put the camera in standby](#) or bring it back to the ready state
- [Zoom to](#) camera presets

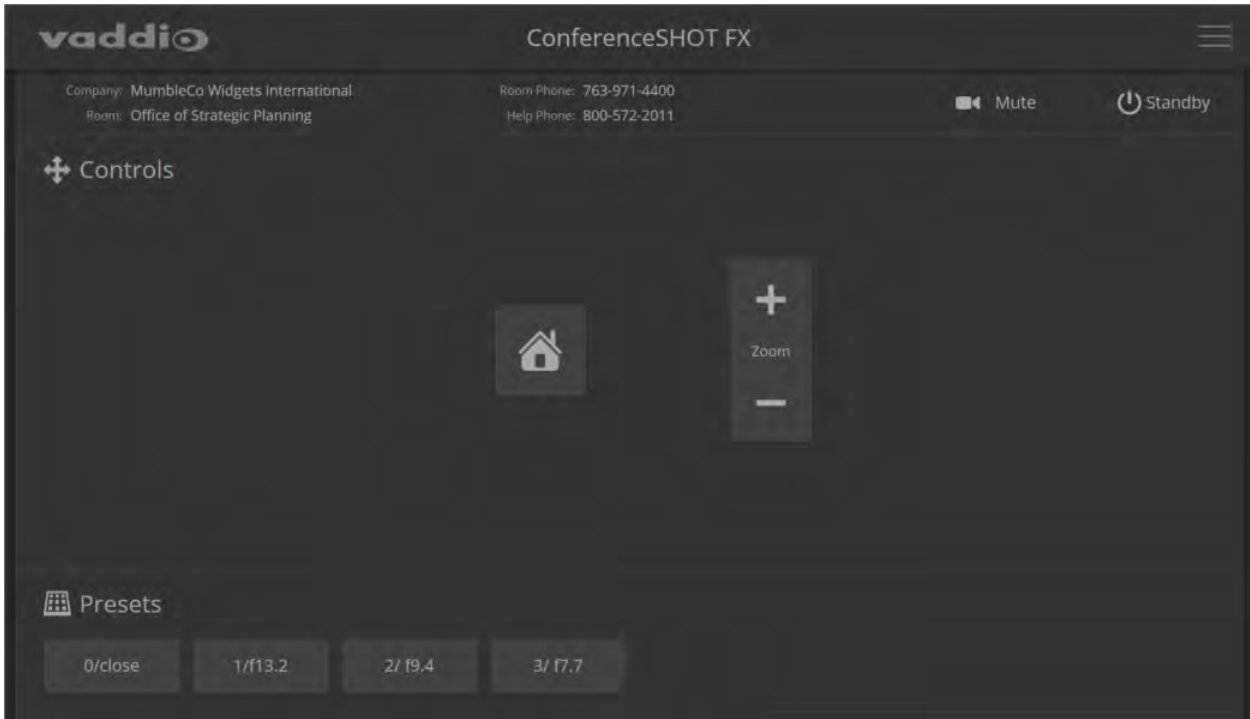

Stopping or Resuming Video

Use the Video Mute button to temporarily stop video from the camera without placing it in standby. Remember that the mute button does not mute the room's microphones, conference phone, or your computer's microphone. In video mute mode, the camera transmits blue or black video, with a message that the video is muted.

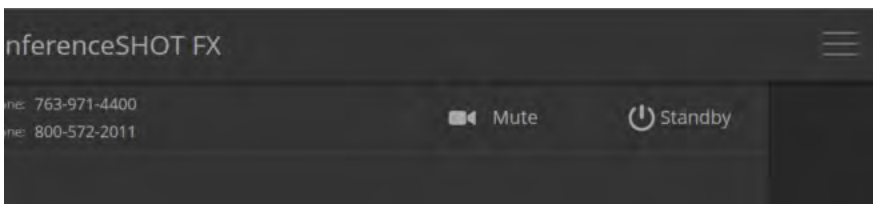

Managing the Camera Ready State

Use the Standby button to switch between low-power (standby) and ready states. In standby mode, the button is red and the screen presents the message "Device is in standby."

Zooming to a Preset Level

All defined zoom presets are available from the Controls page. The administrator may assign them descriptive names.

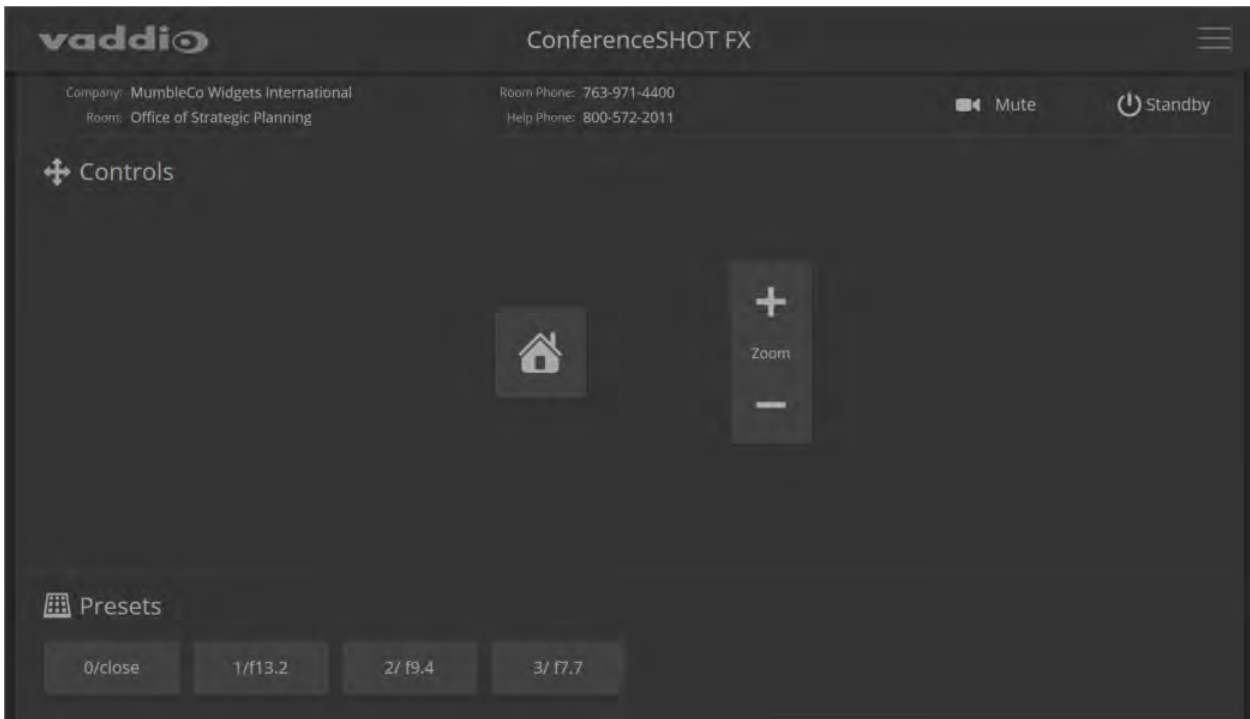

Preset 1 and Preset 2 are also available using the buttons on the remote. If you select a preset that has not yet been programmed, nothing happens.

Storing a Zoom Preset

You must log in as admin to set the home zoom level or presets 3 through 16; however, anyone can use the remote to set presets 1 and 2.

Zoom to the desired level, then hold down the P-Store button while pressing either Preset 1 or Preset 2.



Telnet Serial Command API

The Vaddio Telnet command API allows an external device such as an AMX or Crestron presentation system to control the camera.

Note

When you connect via Telnet, you must log in using the admin account.

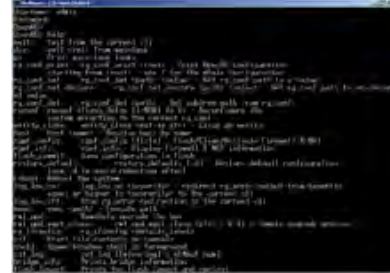

The command format follows a get/set structure. Here are some examples:

Command	<code>camera pan right</code>
Response	OK >
Command	<code>camera focus mode auto</code>
Response	OK >
Command	<code>camera ccu get iris</code>
Response	iris 6 OK >

Use a question mark as a command parameter to bring up a list of commands, subcommands, or command parameters. For example:

```
> camera focus ?
near    Focus the camera near
far     Focus the camera far
stop    Stop the camera focus
mode    Camera focus mode
```

Things you might need to know about control via Telnet session:

- Command lines are terminated with a carriage return.
- All ASCII characters (including carriage returns) are echoed to the terminal program and appended with the VT100 string ESC[J (hex 1B 5B 4A), which most terminal programs automatically strip.
- CTRL-5 Clears the current serial buffer on the device.

Typographical conventions:

- n { x | y | z } – Choose x, y, or z.
- n <variable> – Substitute the desired value here.
- n < x - y > – Valid range of values is from x through y.
- n [optional] – Parameter is not required.

camera home

Returns the camera to the zoom level set as "home." The home preset can be configured in the web interface.

Synopsis	camera home
Example	<pre>>camera home OK ></pre>

camera zoom

Moves the camera in toward the subject or out away from the subject.

Synopsis	camera zoom { in out stop }	
Options	in	Moves the camera in.
	out	Moves the camera out.
	stop	Stops the camera's zoom movement.
Examples	<pre>>camera zoom in OK > Zooms the camera in >camera zoom stop OK > Stops the camera's zoom motion.</pre>	

camera focus

Changes the camera focus.

Synopsis	<code>camera focus { near [<speed>] far [<speed> stop mode {get auto manual}] }</code>	
Options	<code>near</code>	Brings the focus nearer to the camera. Can only be used when camera is in manual mode.
	<code>far</code>	Moves the focus farther from the camera. Can only be used when camera is in manual mode.
	<code>speed <1 - 8></code>	Optional: integer (1 to 8) specifies the focus speed.
	<code>mode [get auto manual]</code>	Returns the current focus mode, or specifies automatic or manual focus.
	<code>stop</code>	Stops the camera's focus movement.
Examples	 <pre> camera focus near OK > Brings the focus near at the default speed. camera focus far 7 OK > Moves the focus farther from the camera at a speed of 7. camera focus mode get auto_focus: on OK > Returns the current focus mode. </pre>	

camera preset

Moves the camera to the specified preset zoom level, or stores the current zoom level.

Synopsis	<code>camera preset { recall store} [1 - 16]</code>	
Options	<code>recall [1 - 16]</code>	Zooms the camera to the specified preset.
	<code>store [1 - 16]</code>	Stores the current zoom level as the specified preset.
Examples	<pre> >camera preset recall 3 OK > Zooms the camera to preset 3. >camera preset store 1 OK > Saves the camera's current zoom level as preset 1. </pre>	

camera ccu get

Returns or sets CCU (lighting) information.

Synopsis	camera ccu get <param>	
	auto_white_balance	Returns the current state of the auto white balance setting (on or off).
	red_gain	Returns the red gain value as an integer (0 to 20).
	blue_gain	Returns the blue gain value as an integer (0 to 20).
	backlight_compensation	Returns the current state of the backlight compensation setting (on or off).
	iris	Returns the iris value as an integer (0 to 9).
	auto_iris	Returns the current auto-iris state (on or off).
	gain	Returns the gain value as an integer (1 to 10).
	detail	Returns the detail value as an integer (0 to 10).
	chroma	Returns the chroma value as an integer (0 to 20).
	wide_dynamic_range	Returns the current setting for Wide Dynamic Range (on or off).
	all	Returns all current CCU settings.
Examples	<pre>>camera ccu get iris iris 6 OK > Returns the current iris value. >camera ccu get red_gain red_gain 201 OK > Returns the current red gain value. >camera ccu get all auto_iris on auto_white_balance on backlight_compensation off blue_gain 193 chroma 2 detail 8 gain 3 iris 11 red_gain 201 wide_dynamic_range off OK > Returns all current CCU settings.</pre>	

camera ccu set

Sets the specified CCU (lighting) information.

Synopsis	camera ccu set <param> <value>	
<p>Options</p> 	auto_white_balance {on off}	Sets the current state of the auto white balance setting (on or off). Auto white balance overrides red gain and blue gain manual settings.
	red_gain <0 - 20>	Sets the red gain value as an integer (0 to 20). Can only be used when auto white balance is off.
	blue_gain <0 - 20>	Sets the blue gain value as an integer (0 to 20). Can only be used when auto white balance is off.
	backlight_compensation {on off}	Sets the current state of the backlight compensation setting (on or off). Can only be used when wide dynamic range mode is off.
	iris <0 - 9>	Sets the iris value as an integer (0 to 9). Can only be used when auto-iris is off.
	auto_iris {on off}	Sets the auto-iris state (on or off). Auto-iris disables manual iris and gain when it is on.
	gain <1 - 10>	Sets gain value as an integer (1 to 10). Can only be used when auto-iris is off.
	detail <0 - 10>	Sets the detail value as an integer (0 to 10).
	chroma <0 - 20>	Sets the chroma value as an integer (0 to 20).
	wide_dynamic_range {on off}	Sets Wide Dynamic Range mode on or off. Can only be used when backlight compensation is off.
Examples	<pre>>camera ccu set auto_iris off OK > Turns off auto-iris mode, returning the camera to manual iris control. >camera ccu set red_gain 10 OK > Sets the red gain value to 10.</pre>	

camera led

Get or change the state of the camera's indicator light.

Note

The camera may be powered up and sending video even if the status light is off.

Synopsis	camera led { get off on }	
Options	get	Returns the current state of the indicator light.
	off	Switches off the indicator light.
	on	Switches on the indicator light.
Examples	<pre>>camera led off OK > Switches off the camera's indicator light. >camera led get led: on OK > Returns the current state of the indicator light.</pre>	

camera standby

Set or change camera standby status.

Synopsis	camera standby { get off on toggle }	
Options	get	Returns the camera's current standby state.
	off	Brings the camera out of standby (sleep) mode.
	on	Stops video and puts the camera in standby mode.
	toggle	Changes the camera's standby state - if it was not in standby mode, it enters standby; if it was in standby mode, it "wakes up."
Examples	<pre>>camera standby off OK > Brings the camera out of standby mode. >camera standby get standby: on OK > Returns the current standby state.</pre>	

video mute

Gets or sets the camera's video mute status. When video is muted, the camera sends blue or black video with an on-screen message stating that video mute is on. This can be desirable when preparing the room, or when privacy is needed.

Synopsis	video mute { get off on toggle }	
Options	get	Returns the current video mute status.
	off	Unmutes the video. (Normal video resumes.)
	on	Mutes the video. (Blue or black screen with message)
	toggle	Changes the camera's video mute status.
Examples	<pre>>video mute get mute: off OK ></pre> <p>Returns video mute status.</p> <pre>>video mute on OK ></pre> <p>Transmits blue or black video.</p>	

streaming settings get

Returns current IP and USB streaming settings.

Synopsis	streaming settings get	
Parameters	IP Custom_Frame_Rate	Frame rate selected in Custom quality mode.
	IP Custom_Resolution	Resolution selected in Custom quality mode.
	IP Enabled	Specifies whether IP streaming is enabled.
	IP Port	The RTSP port number used for IP streaming. Default is 554.
	IP Preset_Quality	Video quality selected in Easy video quality mode.
	IP Preset_Resolution	Resolution selected in Easy video quality mode.
	IP Protocol	The IP streaming protocol in use.
	IP URL	The URL where the stream is available. To view the stream, enter the URL as <code>rtsp://</code> followed by the IP address, the <code>/</code> character, and the string returned as the IP URL.
	IP Video_Mode	Video quality mode selected (preset or custom).
	USB Active	True when a USB stream is present; false otherwise.
	USB Device	The USB Device Name currently assigned.
	USB Frame_Rate	Frame rate in use for USB streaming (negotiated with conferencing client). 0 when no USB stream is present.
	USB Resolution	Resolution of the USB stream (negotiated with conferencing client). 0x0 when no USB stream is present.
	USB Version	2 or 3, as negotiated with the conferencing client. 0 if no USB stream is present.
UVC Extensions_Enabled	Allow or disable soft client USB control of the camera.	
Example	<pre>>streaming settings get IP Custom_Frame_Rate 15 IP Custom_Resolution 1080p IP Enabled true IP Port 554 IP Preset_Quality Standard (Better) IP Preset_Resolution 720p IP Protocol RTSP IP URL vaddio-conferenceshot-fx-stream IP Video_Mode preset USB Active true USB Device ConferenceSHOT FX USB Frame_Rate 30 USB Resolution 360p USB Version 3 UVC Extensions_Enabled true OK ></pre>	

network settings get

Returns the camera's current network settings and MAC address.

Synopsis	<code>network settings get</code>
Example	<pre>network settings get Name eth0:WAN MAC Address 00:1E:C0:F6:CA:7B IP Address 192.168.1.67 Netmask 255.255.255.0 VLAN Disabled Gateway 192.168.1.254 OK ></pre>

network ping

Sends an ICMP ECHO_REQUEST to the specified IP address.

Synopsis	<code>network ping [count <count>] [size <size>] <destination-ip></code>	
Options	<count>	The number of ECHO_REQUEST packets to send. Default is five packets.
	<size>	The size of each ECHO_REQUEST packet. Default is 56 bytes.
	<destination-ip>	The IP address where the ECHO_REQUEST packets will be sent.
Examples	<pre>>network ping 192.168.1.66 PING 192.168.1.66 (192.168.1.66): 56 data bytes 64 bytes from 192.168.1.66: seq=0 ttl=64 time=0.476 ms 64 bytes from 192.168.1.66: seq=1 ttl=64 time=0.416 ms 64 bytes from 192.168.1.66: seq=2 ttl=64 time=0.410 ms 64 bytes from 192.168.1.66: seq=3 ttl=64 time=0.410 ms 64 bytes from 192.168.1.66: seq=4 ttl=64 time=3.112 ms --- 192.168.1.66 ping statistics --- 5 packets transmitted, 5 packets received, 0% packet loss round-trip min/avg/max = 0.410/0.964/3.112 ms ></pre> <p>Sends five ECHO_REQUEST packets of 56 bytes each to the host at 192.168.1.66.</p>	
	<pre>>network ping count 10 size 100 192.168.1.1</pre> <p>Sends 10 ECHO_REQUEST packets of 100 bytes each to the host at 192.168.1.1. The command returns data in the same form as above.</p>	

system reboot

Reboots the system either immediately or after the specified delay. Note that a reboot is required when resetting the system to factory defaults (system factory-reset).

Synopsis	system reboot [<seconds>]	
Options	<seconds>	The number of seconds to delay the reboot.
Examples	<pre>>system reboot OK > The system is going down for reboot NOW!conferenceshot-fx-D8-80-39-62-A7-C5 Reboots the camera immediately. >system reboot 30 Reboots the camera in 30 seconds. The response is in the same form; the system message appears at the end of the delay.</pre>	

system factory-reset

Gets or sets the factory reset status. When the factory reset status is on, the system resets to factory defaults on reboot.

Synopsis	system factory-reset { get on off }	
Options	get	Returns the camera's current factory reset status.
	on	Enables factory reset on reboot.
	off	Disables factory reset on reboot.
Examples	 <pre>>system factory-reset get factory-reset (software): off factory-reset (hardware): off OK > Returns the factory reset status. This evaluates the most recent system factory-reset on or off command, if one has been received. >system factory-reset on factory-reset (software): on factory-reset (hardware): off OK > Enables factory reset upon reboot. Note This command does not initiate a factory reset. The factory reset takes place on the next reboot.</pre>	

sleep

Pauses command execution for the specified number of milliseconds.

Synopsis	<code>sleep <milliseconds></code>	
Options	<code><milliseconds></code>	The number of milliseconds (1 to 10000) to pause.
Example	<pre>>sleep 7000 OK ></pre> <p>Pause for 7 seconds (7000 milliseconds) before returning.</p>	

history

Returns the most recently issued commands from the current Telnet session. Since many of the programs read user input a line at a time, the command history is used to keep track of these lines and recall historic information.

Synopsis	<code>history <limit></code>	
Options	<code><limit></code>	Integer value specifying the maximum number of commands to return.
Examples	<pre>history Displays the current command buffer. history 5 Sets the history command buffer to remember the last 5 unique entries.</pre>	
Additional information	<p>You can navigate the command history using the up and down arrow keys. This command supports the expansion functionality from which previous commands can be recalled from within a single session. History expansion is performed immediately after a complete line is read.</p> <p>Examples of history expansion:</p> <ul style="list-style-type: none"> * !! Substitute the last command line. * !4 Substitute the 4th command line (absolute as per 'history' command) * !-3 Substitute the command line entered 3 lines before (relative) 	



version

Returns the current firmware version.

Synopsis	<code>version</code>	
Example	<pre>>version Commit 5a031cc87f4f27a28c486cf7f0e0c26bccf4e4ad PSoC Version 0.0 Sensor Version 0.19 System Version ConferenceSHOT FX 1.0.0 OK ></pre>	

help

Displays an overview of the CLI syntax.

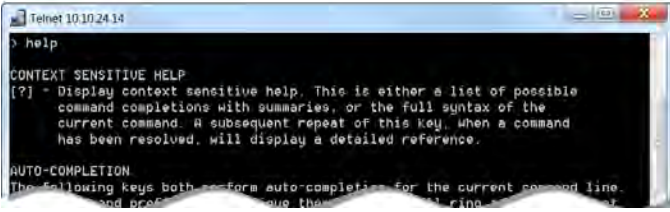
Synopsis	help
Example	<p>help</p> 

exit

Ends the command session and closes the socket.

Synopsis	exit
Example	exit

RS-232 Serial Communication

The RS-232 serial port (RJ-45, color-coded blue) on the camera's back panel enables third-party control.

Parameter	Value
Communication Speed	9600 bps (default)
Number of start bits	1
Number of stop bits	1
Number of data bits	8
Parity	None
Flow control	None

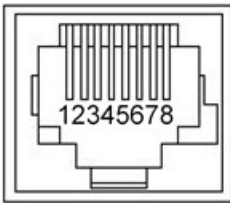

Connector pin-out:

- Pin 1: Not used
- Pin 2: Not used
- Pin 3: Not used
- Pin 4: Not used
- Pin 5: Not used
- Pin 6: GND
- Pin 7: RXD (from TXD of control source)
- Pin 8: TXD (to RXD of control source)

Caution:

Check Cat-5 cables for continuity before using them. Using the wrong pin-out may damage the camera system and void the warranty. Pro tip: Label your cables.

The Vaddio ConferenceSHOT Control Protocol is similar to the Sony® VISCA command set in order to be compatible with several popular control devices. Not all VISCA commands are supported and there are Vaddio-specific commands in the following command and inquiry lists.

Camera Zoom and Focus Commands

Command Set	Command	Command Packet	Comments
CAM_Zoom	Stop	8x 01 04 07 00 FF	
	Tele (std)	8x 01 04 07 02 FF	
	Wide (std)	8x 01 04 07 03 FF	
	Tele (variable)	8x 01 04 07 2p FF	p = speed 0 (low) to 7 (high)
	Wide (variable)	8x 01 04 07 3p FF	p = speed 0 (low) to 7 (high)
	Direct	8x 01 04 47 0p 0q 0r 0s FF	pqrs = zoom position (0h-4000h)
CAM_Focus	Stop	8x 01 04 08 00 FF	
	Far (std)	8x 01 04 08 02 FF	
	Near (std)	8x 01 04 08 03 FF	
	Far (variable)	8x 01 04 08 2p FF	p = speed 0 (low) to 7 (high)
	Near (variable)	8x 01 04 08 3p FF	p = speed 0 (low) to 7 (high)
	Direct	8x 01 04 48 0p 0q 0r 0s FF	pqrs = focus position (1000h – 11FFh)
	Auto Focus	8x 01 04 38 02 FF	
	Manual Focus	8x 01 04 38 03 FF	
	Auto/Manual	8x 01 04 08 10 FF	
CAM_ZoomFocus	Direct	8x 01 04 47 0p 0q 0r 0s 0t 0u 0v 0w FF	pqrs = zoom position (0h-4000h) tuvw = focus position (1000h – 11FFh)

Color and Light Management Commands

Command Set	Command	Command Packet	Comments
CAM_RGain	Reset	8x 01 04 03 00 FF	Manual control of red gain
	Up	8x 01 04 03 02 FF	
	Down	8x 01 04 03 03 FF	
	Direct	8x 01 04 43 00 00 0p 0q FF	pq = red gain (00h – 14h)
CAM_BGain	Reset	8x 01 04 04 00 FF	Manual control of blue gain
	Up	8x 01 04 04 02 FF	
	Down	8x 01 04 04 03 FF	
	Direct	8x 01 04 44 00 00 0p 0q FF	pq = blue gain (00h – 14h)
CAM_Iris	Reset	8x 01 04 0B 00 FF	Iris setting
	Up	8x 01 04 0B 02 FF	
	Down	8x 01 04 0B 03 FF	
	Direct	8x 01 04 4B 00 00 0p 0q FF	pq = iris position (0h, 05h-11h) See Iris Values
CAM_Gain	Direct	8x 01 04 4C 00 00 0p 0q FF	Iris gain setting pq = gain position (01h – 0Ah) See Iris Gain Values
CAM_BackLight	On	8x 01 04 33 02 FF	Backlight compensation On/Off
	Off	8x 01 04 33 03 FF	
CAM_Aperture	Reset	8x 01 04 02 00 FF	Aperture setting
	Up	8x 01 04 02 01 FF	
	Down	8x 01 04 02 02 FF	
	Direct	8x 01 04 42 00 00 0p 0q FF	pq = aperture position (0h – 0Ah)
CAM_Gamma	Direct	8x 01 04 1E 00 00 00 00 0t 0u FF	tu: 00h to 03h
CAM_Chroma	Direct	8x 01 7E 55 00 00 0p 0q FF	pq: 00h – 14h

Other Commands

Command Set	Command	Command Packet	Comments
AddressSet	Broadcast	88 30 01 FF	Sets address for all daisy-chained cameras
IF_Clear	Broadcast	88 01 00 01 FF	I/F clear
CommandCancel		8x 2p FF	p= socket (1 or 2)
CAM_Power	On	8x 01 04 00 02 FF	Power on
	Off	8x 01 04 00 03 FF	Power off

Command Setting Values – Exposure Control

Iris Values

Value	Iris
0x11	F1.8
0x10	F2
0x0F	F2.4
0x0E	F2.8
0x0D	F3.3
0x0C	F4
0x0B	F4.8
0x0A	F5.6
0x09	F6.8
0x08	F8
0x07	F9.6
0x06	N/A
0x05	N/A
0x00	CLOSE

Iris Gain Values

Value	Steps
0x0A	18
0x09	16
0x08	14
0x07	12
0x06	10
0x05	8
0x04	6
0x03	4
0x02	2
0x01	0

Zoom and Focus Inquiry Commands

Inquiry Command	Command	Response Packet	Comments
CAM_ZoomPosInq	8x 09 04 47 FF	y0 50 0p 0q 0r 0s FF	pqrs: Zoom position
CAM_FocusModelInq	8x 09 04 38 FF	y0 50 02 FF	Auto focus
		y0 50 03 FF	Manual focus
CAM_FocusPosInq	8x 09 04 48 FF	y0 50 0p 0q 0r 0s FF	pqrs: Focus position

Color and Light Management Inquiry Commands

Inquiry Command	Command	Response Packet	Comments
CAM_RGainInq	8x 09 04 43 FF	y0 50 00 00 0p 0q FF	pq: Red gain
CAM_BGainInq	8x 09 04 44 FF	y0 50 00 00 0p 0q FF	pq: Blue gain
CAM_IrisPosInq	8x 09 04 4B FF	y0 50 00 00 0p 0q FF	pq: Iris position
CAM_GainPosInq	8x 09 04 4C FF	y0 50 00 00 0p 0q FF	pq: Gain position
CAM_BackLightModelInq	8x 09 04 33 FF	y0 50 02 FF	On
		y0 50 03 FF	Off
CAM_ApertureInq	8x 09 04 42 FF	y0 50 00 00 0p 0q FF	pq: Aperture gain

Other Inquiry Commands

Inquiry Command	Command	Response Packet	Comments
CAM_PowerInq	8x 09 04 00 FF	y0 50 02 FF	On
		y0 50 03 FF	Off (standby)

Specifications

Camera and Image

Image device		Pixels	
IP (H.264) RTSP Video Resolutions	1080p/30/15 720p/60-15 360p/60-15	USB 3.0 (UVC) Video Resolutions	1080p/60 down to 180p/15; autonegotiated
Lens and horizontal FOV	3x optical zoom, 88° wide to 46° tele		
Min. working distance	10mm (wide), 1.0m (tele)	Min. illumination	100+ lux recommended
Aperture/detail	16 steps	Gain	Auto or manual
Backlight compensation	On or off	White balance	Auto or manual
Focusing system	Auto or manual	Wide Dynamic Range	On or off
Sync system	Internal	S/N ratio	Over 50 dB
Remote management	Web interface, Telnet, RS-232	Power	12 VDC, 1.5 A

Physical and Environmental

Height	6.3" (163 mm)	Operating temperature	0°C to +40°C (32°F to 104°F)
Width	6.1" (155 mm)	Operating humidity (relative)	20% to 80% non-condensing
Depth	5.5" (145 mm)	Storage temperature	-5°C to +60°C (-23°F to 140°F)
Weight	3.0 lbs.(1.36 kg)	Storage humidity (relative)	20% to 80% non-condensing

Specifications are subject to change without notice.

Troubleshooting and Care

When the camera doesn't behave as you expect, check the indicator light on the front before you do anything else.

Use this table to determine whether it's time to call Vaddio Technical Support.

What is it doing?	Possible causes	Check and correct
Nothing. The light on the front is off and no video is available.	At least one of the cables is bad.	Check using known good cables.
	The wall outlet is not active. (Check by finding out if it powers something else, such as a laptop or phone charger.)	Use a different outlet.
	The camera or its power supply is bad.	Contact your reseller or Vaddio Technical Support.
The light on the front of the camera is off but the web interface and video are available.	The status light is turned off.	You can turn it on again using the LED soft DIP switch on the System page, or using the Telnet command camera led on .
The camera is not responding to the remote and the light is yellow.	A firmware update is in progress.	Wait a few minutes, and try again when the light turns blue.
The camera does not respond to the remote, but the web interface is available.	The remote is not using the same IR channel as the camera.	Push the Camera Select 1 button on the remote.
	The batteries in the remote are dead.	Put new batteries in the remote.
The camera responds to the remote but the web interface is not available.	The camera is not using the IP address you browsed to.	Press the Data Screen button on the remote to see camera information.
Video is available but the camera does not move.	ConferenceSHOT FX cameras must be manually positioned.	Check the System screen to verify the camera model. This is normal behavior for fixed cameras.
No H.264 video stream.	IP streaming is not enabled.	Enable IP streaming: Streaming page in the web interface.
No USB video stream.	USB streaming is not enabled.	Enable USB streaming: Streaming page in the web interface.

Status Light

The light in the camera's base indicates its current state.

- Blue – Camera is active
- Purple – Standby mode or booting
- Yellow – Firmware update is in progress
- Blinking blue – USB cable is disconnected
- Blinking purple – Error

Caution

Do not remove power or reset the camera while the indicator is yellow, showing a firmware update in progress. Interrupting a firmware update can make the camera unusable.

Note

The camera may be powered up and sending video even if the status light is off.

Restoring Default Camera Settings

Factory reset clears most settings and returns soft DIP switches (on the DIP Switches tab of the System page) to their default positions.

Using the switches on the back of the camera: Set all DIP switches DOWN and cycle the power to reload the default camera settings. Then return all DIP switches to the desired settings.

From the web interface: Log on using the admin account, go to the System page's Firmware tab, and click Restore Factory Settings.

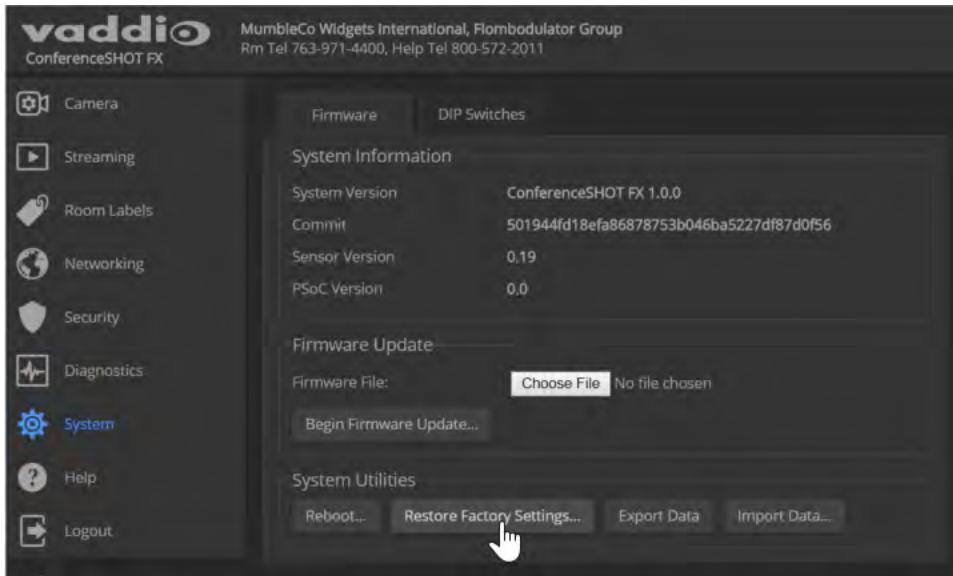

Operation, Storage, and Care

For smears or smudges on the product, wipe with a clean, soft cloth. Use a lens cleaner on the lens. Do not use any abrasive chemicals.

Keep this device away from food and liquids.

Do not operate or store the device under any of the following conditions:

- Temperatures above 40°C (104°F) or below 0°C (32°F)
- High humidity, condensing or wet environments
- Inclement weather
- Severe vibration
- Between converging tectonic plates
- Dry environments with an excess of static discharge

Do not attempt to take this product apart. There are no user-serviceable components inside.

Compliance Statements and Declarations of Conformity

Compliance testing was performed to the following regulations:

FCC Part 15 (15.107, 15.109), Subpart B	Class A
ICES-003, Issue 54: 2012	Class A
EMC Directive 2004/108/EC	Class A
EN 55022: December 2010	Class A
EN 55024: November 2010	Class A
KN22 2008 (CISPR 22: 2006)	Class A
KN24 2008 (CISPR 24: 1997 + A1: 2000 + A2: 2002)	Class A
IEC 60950-1:2005 (2nd Edition); Am 1: 2009 + Am 2: 2013	Safety
EN 60950-1: 2006 + A11: 2009 + A1: 2010 + A12: 2011 + A2: 2013	Safety

FCC Part 15 Compliance

Operation is subject to the following two conditions: (1) This device may not cause interference, and (2) This device must accept any interference including interference that may cause undesired operation of the device.



Changes or modifications not expressly approved by Vaddio can affect emission compliance and could void the user's authority to operate this equipment.

ICES-003 Compliance

This digital apparatus does not exceed the Class A limits for radio noise emissions from digital apparatus set out in the Radio Interference Regulations of the Canadian Department of Communications.

Le présent appareil numérique n'émet pas de bruits radioélectriques dépassant les limites applicables aux appareils numériques de la classe A prescrites dans le Règlement sur le brouillage radioélectrique édicté par le ministère des Communications du Canada.

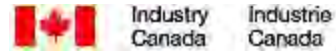

European Compliance

This product has been evaluated for electromagnetic compatibility under the EMC Directive for Emissions and Immunity and meets the requirements for a Class A digital device. In a domestic environment this product may cause radio interference in which case the user may be required to take adequate measures.

Standard(s) To Which Conformity Is Declared:



EMC Directive 2004/108/EC

EN 55022: December 2010

EN 55024: November 2010

EN 61000-4-2: 1995 + Amendments A1: 1998 + A2: 2001

EN 61000-4-3: 2006 + A1: 2008

EN 61000-4-4: 2004 + Corrigendum 2006

EN 61000-4-5: 2006

EN 61000-4-6: 2009

EN 61000-4-8: 2010

EN 61000-4-11: 2004

KN22 2008 (CISPR 22: 2006)

KN24 2008 (CISPR 24: 1997 + A1: 2000 + A2: 2002)

EN 61000-4-2

EN 61000-4-3

EN 61000-4-4

EN 61000-4-5

EN 61000-4-6

EN 61000-4-8

EN 61000-4-11

IEC 60950-1: 2005 (2nd Edition); Am 1: 2009 + Am 2: 2013

EN 60950-1: 2006 + A11: 2009 + A1: 2010 + A12: 2011 + A2: 2013

Conducted and Radiated Emissions

Immunity

Electrostatic Discharge

Radiated Immunity

Electrical Fast Transients

Surge Immunity

Conducted Immunity

Power Frequency Magnetic Field

Voltage Dips, Interrupts and Fluctuations

Conducted and Radiated Emissions

IT Immunity Characteristics

Electrostatic Discharge

Radiated Immunity

Electrical Fast Transients

Surge Immunity

Conducted Immunity

Power Frequency Magnetic Field

Voltage Dips, Interrupts and Fluctuations

Safety

Safety

Warranty Information

See Vaddio Warranty, Service and Return Policies posted on support.vaddio.com for complete details.

Hardware* warranty: Two (2) year limited warranty on all parts and labor for Vaddio manufactured products. Vaddio warrants its manufactured products against defects in materials and workmanship for a period of two years from the day of purchase, to the original purchaser, if Vaddio receives notice of such defects during the warranty. Vaddio, at its option, will repair or replace products that prove to be defective. Vaddio manufactures its hardware products from parts and components that are new or equivalent to new in accordance with industry standard practices.

Exclusions: The above warranty shall not apply to defects resulting from improper or inadequate maintenance by the customer, customers applied software or interfacing, unauthorized modifications or misuse, mishandling, operation outside the normal environmental specifications for the product, use of the incorrect power supply, modified power supply or improper site operation and maintenance. OEM and special order products manufactured by other companies are excluded and are covered by the manufacturer's warranty.

Vaddio Customer Service: Vaddio will test, repair, or replace the product or products without charge if the unit is under warranty. If the product is out of warranty, Vaddio will test then repair the product or products. The cost of parts and labor charge will be estimated by a technician and confirmed by the customer prior to repair. All components must be returned for testing as a complete unit. Vaddio will not accept responsibility for shipment after it has left the premises.

Vaddio Technical Support: Vaddio technicians will determine and discuss with the customer the criteria for repair costs and/or replacement. Vaddio Technical Support can be contacted by email at support@vaddio.com or by phone at one of the phone numbers listed on support.vaddio.com.

Return Material Authorization (RMA) number: Before returning a product for repair or replacement request an RMA from Vaddio's technical support. Provide the technician with a return phone number, e-mail address, shipping address, product serial numbers and original purchase order number. Describe the reason for repairs or returns as well as the date of purchase. See the General RMA Terms and Procedures section for more information. RMAs are valid for 30 days and will be issued to Vaddio dealers only. End users must return products through Vaddio dealers. Include the assigned RMA number in all correspondence with Vaddio. Write the assigned RMA number clearly on the shipping label of the box when returning the product. All products returned for credit are subject to a restocking charge without exception. Special order product are not returnable.

Voided warranty: The warranty does not apply if the original serial number has been removed or if the product has been disassembled or damaged through misuse, accident, modifications, use of incorrect power supply, use of a modified power supply or unauthorized repair.

Shipping and handling: Vaddio will not pay for inbound shipping transportation or insurance charges or accept any responsibility for laws and ordinances from inbound transit. Vaddio will pay for outbound shipping, transportation, and insurance charges for all items under warranty but will not assume responsibility for loss and/or damage by the outbound freight carrier. If the return shipment appears damaged, retain the original boxes and packing material for inspection by the carrier. Contact your carrier immediately.

Products not under warranty: Payment arrangements are required before outbound shipment for all out of warranty products.

Index

A

- admin login 11, 18
 - default 11
 - editing 18
- anatomy of the camera 3
- API 29, 40
 - syntax help 40
- auto focus 31
- auto iris 33
- auto white balance 33

B

- backing up a configuration 19
- backlight compensation 32-33
- bandwidth 17
- baud rate setting (DIP switch) 26
- bit rate (IP streaming setting) 17
- blue gain 33
- browser compatibility 10

C

- cable connectors 3, 5
- camera ID setting (DIP switch) 4
- camera mount 2, 5-7
 - installing 6
- Camera page (web) 23
- camera placement 5
- camera select 9, See also camera ID setting (DIP switch)
- camera specifications 46
- camera standby position 27
- capabilities 1, 46
- CCU settings 31-33
- ceiling-mounted cameras 6
- cheat sheet 9, 12
 - web interface 12
- chroma setting 33
- cleaning 49
- color codes for status light 8, 48
- color settings 32-33
- command history 39
- commands, RS-232 (VISCA) 42-45
- compatibility, browsers 10
- configuration, saving or restoring 19
- connection diagram 8

- connectors 3
- Constant Bit Rate 17
- Controls page (web) 27

D

- damage, preventing 2, 5, 41
- default IP address 10
- default settings, restoring 48
- detail setting 33
- device name, USB 16
- DHCP 14
- diagnosing issues 47
- diagnostic logs 22
- Diagnostics page (web) 22
- diagram, connection 8
- DIP switches 3-4, 26
 - location 3
 - settings 4
 - soft 26
- directional controls 9

E

- Ethernet port 3

F

- factory defaults, restoring 38, 48
- fault isolation 47
- firmware update 20
- firmware version 39
- focus 9, 31
- Frame Rate (IP streaming setting) 17

G

- getting help 21
- guest access 18

H

- Help page (web) 21
- home position 30
- hostname 14

I

- image flip setting (DIP switch) 4
- importing a configuration 19
- inactive sessions (web interface) 18
- indicator light 8, 26, 34, 48
 - enabling/disabling 26, 34
 - meaning of colors 8, 48
- information, conference room 19

- installation 6-8
 - basic connections 8
 - camera 7
 - camera mount 6
 - inverted installation 6
 - IP address 9-10, 14
 - default 10, 14
 - IP streaming 16-17, 36
 - resolutions and frame rates 16
 - settings 17, 36
 - IR remote 9
 - iris settings 32-33
- L**
- labels, room 19
 - light, status indicator 8, 26, 34, 48
 - color scheme 26
 - enabling/disabling 26, 34
 - meaning of colors 8, 48
 - lighting settings 32-33
 - location of the camera 5
 - locations of connectors 3
 - log files 22
 - low-power (standby) state 27, 34
- M**
- manual focus 9, 31
 - Max Bandwidth (IP streaming setting) 17
 - mount 5-7
 - mounting the camera 5, 7
 - muting 27, 35
 - video 27, 35
- N**
- navigation buttons, hiding/showing 12
 - network configuration 10, 14, 37
 - current 37
 - default 14
 - network port 3
 - Networking page (web) 14
 - NTP server 15
- O**
- operating environment 5, 49
- P**
- packing list 2
 - page 14, 16, 18-19, 21-23, 27
 - Camera 23
 - Controls 27
 - Diagnostics 22
 - Help 21
 - Networking 14
 - Room Labels 19
 - Security 18
 - Streaming 16
 - pan/tilt/zoom 9
 - part numbers 2
 - passwords 18
 - pause command execution 39
 - performance specifications 46
 - physical and environmental specifications 46
 - pin-out, RS-232 connector 41
 - ping command 37
 - power on/power off 9
 - power supply 2
 - precautions 2, 5
 - for operating the system 5
 - presets 9, 31
 - moving to 31
 - setting 9, 31
 - pro A/V status light color scheme 26
 - product capabilities 1, 46
 - product returns and repairs 52
- Q**
- quick reference 9, 12
 - remote control 9
 - Vaddio IR Remote Commander 9
 - web interface 12
- R**
- ready state 27, 34
 - rebooting 19, 38
 - red gain 33
 - remote control 9, 28
 - requirements 5
 - installation 5
 - mounting 5
 - resolution 16-17
 - IP streaming 16-17
 - USB streaming 16
 - restoring a configuration 19
 - restoring default settings 38, 48
 - RJ-45 connectors 5
 - room information 19
 - Room Labels page (web) 19

RS-232 commands 42-45
 setting values 44
 RS-232 serial connection 41

S

saving a configuration 19
 Security page (web) 18
 settings, default, restoring 38, 48
 shelf-mounted cameras 7
 shelf, camera mount 6
 site requirements 5
 soft client control, enabling/disabling 16
 soft DIP switches 26
 software update 20
 solving problems 47
 specifications 46
 speed 23, 30-31
 focus 31
 pan/tilt/zoom 30
 standby (low-power) state 27, 34
 static IP address 14
 status light 8, 26, 34, 48
 color scheme (DIP switch) 26
 enabling/disabling 34
 meanings of colors 8, 48
 off/on (soft DIP switch) 26
 storage environment 49
 storing a configuration 19
 Streaming page (web) 16
 streaming settings 16, 36
 supported web browsers 10
 switch location 3
 switch settings 4, 6, 26
 baud rate (soft DIP switch) 26
 camera ID (DIP switch) 4
 image flip (DIP switch) 4
 image flip (soft DIP switch) 6
 in web interface 26
 status light color scheme (soft DIP switch) 26
 status light off/on (soft DIP switch) 26
 USB stream format 26
 syntax help, Telnet 40

T

technical specifications 46
 technical support 21
 Telnet command help 40

Telnet session 29, 39-40
 ending 40
 history 39
 temperature, operating and storage 49
 third-party control 29, 41
 time zone 15
 troubleshooting 47

U

UC conferencing status light color scheme 26
 update 20
 USB cable 2
 USB device name 16
 USB port 3
 USB stream format (DIP switch) 26
 USB streaming 16
 user login 10, 18
 default 10
 editing 18

V

Vaddio IR Remote Commander 9
 Variable Bit Rate 17
 version, firmware 39
 video mute 27, 35
 Video Quality (IP streaming setting) 17
 virtual DIP switches 26
 VISCA commands 42-45
 visual parts identification 3

W

wall mount 6
 installing 6
 warranty 5, 52
 web browsers supported 10
 web interface 12, 14, 16, 18-19, 21-23, 27-28
 Camera page 23
 Controls page 27
 Diagnostics page 22
 Help page 21
 navigation button labels 12
 Networking page 14
 Room Labels page 19
 Security page 18
 Streaming page 16

Z

zoom 30

zoom presets 28, 31
 storing 28, 31
 using 28, 31
zoom speed 9, 30

Vaddio is a brand of Milestone AV Technologies · www.milestone.com

Phone 800.572.2011 / +1.763.971.4400 · Fax +1.763.971.4464 · Email info@vaddio.com

Visit us at support.vaddio.com for firmware updates, specifications, drawings, manuals, technical support information, and more.

Vaddio and ConferenceSHOT are trademarks or registered trademarks of Milestone AV Technologies. All other brand names or marks are used for identification purposes and are trademarks of their respective owners.

In British Columbia, Milestone AV Technologies ULC carries on business as MAVT Milestone AV Technologies ULC.

©2017 Milestone AV Technologies

vaddio®