



VADDIO™ CLEARVIEW™ HD-20SE QCCU SYSTEM

ClearVIEW HD-20se High Definition, Robotic PTZ Camera featuring the Quick-Connect™ Universal CCU System Interface, EZIM™ CCU Slot Card and CONCEAL™ Mount

Model Number 999-6987-000 (North America)

Model Number 999-6987-001 (International)

Model Number 999-6987-000AW (North America) Arctic White Camera

Model Number 999-6987-001AW (International) Arctic White Camera



Quick-Connect Universal CCU Interface



EZIM™ CCU Slot Card Interface

Part Number: 998-6700-006



TABLE OF CONTENTS

Overview..... 3

Unpacking:..... 4

Anatomy of the ClearVIEW HD-20se HD PTZ Camera 5

 Image: Front View ClearVIEW HD-20SE 5

 Image: Rear View ClearVIEW HD-20SE Connectors 6

First Time Set-up with the ClearVIEW HD-20SE: 7

 Image: Rear Panel Connections 7

 Drawing: Dip Switch and Resolution Label on the Bottom of the ClearVIEW HD-20SE 7

Anatomy of the Universal CCU..... 8

 Image: Front Panel CCU Controls..... 8

 Image: Close up View of the Universal CCU Control Panel 8

 Image: Rear Panel CCU Connections and Controls (left to right)..... 9

The EZIM (EZ Interface Module) HD-Series Slot Card..... 9

 Image: EZIM Slot Card 9

HD-20SE with Quick-Connect Universal CCU Control Menus..... 10

 Menu Organization 10

 Image: Main Menu Page 10

 Image: Shutter, Noise Reduction and Image Stabilization Menu..... 10

 Image: Cat-5 Adjustment Menu Page 10

 Image: Version Info Menu 11

 Image: LCD Screen Adjustment Screen 11

 Image: Basic Connectivity Example..... 12

Installation Basics:..... 13

 General Installation Instructions for the CONCEAL Wall Mounting System:..... 13

Optimizing CCU System Performance: 15

Compliance and CE Declaration of Conformity - ClearVIEW HD-20SE 16

Compliance and CE Declaration of Conformity..... 17

Warranty Information 18

General Specifications:..... 19

Appendix 1: Cable Pin-outs for the Quick-Connect Universal CCU..... 20

 EZIM Slot Card Pin-outs 21

 Drawing: ClearVIEW HD-20SE Dimensions 21

Communication Specification 22

 HD-20SE Command List (1/2)..... 22

 HD-20SE Command List (2/2)..... 23

 HD-20SE Inquiry List (1/1) 24

Table: HD-20SE OSD Menu Structure..... 25

CCU Scene Selection Commands 26

OVERVIEW:

The amazing ClearVIEW HD-20SE HD PTZ Camera quite literally combines all of the best features of the ClearVIEW HD-18, HD-19 and HD-20 HD PTZ cameras into ONE! The innovation of the HD-18 EZCamera™ Cat-5 interfaces, the low light capability of the HD-19 and the FULL HD performance of the HD-20 are all represented, and improved upon with the ClearVIEW HD-20SE. The ClearVIEW HD-20SE is clearly the best ClearVIEW ever, and here's why.

The HD-20SE is a native 1080p/60 camera using the latest 1/2.8-Type Exmor® high-speed, low noise CMOS image sensor technology with 2.38 Megapixels (total) and 2.14 Megapixels (effective). The ISP (image signal processor) is off-the-hook, not only providing fast, razor-sharp auto-focus routines with incredible detail, realistic textures and vivid colors, it also has an impressive low-light performance of 0.3 Lux (color) and 0.03 Lux (B/W). The lens is a 20X optical zoom multi-element glass lens with an impressive horizontal field of view of 63° on the wide end to 3.47° on the tele end. The outputs are simultaneous HDMI, YPbPr and HSDS™ (differential video for use with Quick-Connect™ Interfaces) and supports both drop frame and non-drop frame HD video resolutions of 1080p/60/59.94/50/30/25, 1080i/60/59.94/50 and 720p/60/59.94/50.

So to recap, latest technology, awesome ISP, superb low-light performance, powerful yet wide angle lens, lots and lots of video outs, drop and non-drop frame video, Full HD and there's more!

The QCCU System pairs up the HD-20SE with Quick-Connect Universal CCU and uses HSDS™ (high speed differential signaling), an active video transmission system, to deliver high quality HD video over standard Cat-5 cabling up to 500' (152.4m) with virtually no loss in video quality and no latency. One of the most flexible attributes the Universal CCU is at the outputs. It has HD-SDI (yep, 3 Gb/s single link HD-SDI for up to 1080p/60 resolution), HDMI and HD Analog component (YPbPr) outputs, all of which can be used concurrently (at the same resolution). The back-lit blue LED screen displays up to eight (8) parameters at a time, as well as the camera's model number so the interrelationship of the controls is easily and quickly read and understood. The Universal CCU allows the user to adjust Red and Blue Gain, OPWB, Iris functions, Chroma, Brightness, Detail, Gamma and Gain on allowing the camera to deliver a more accurate representation of the captured image's color. Other added advantages include the ability to color match and shade cameras in a multi-camera installation.

The ClearVIEW HD-20SE QCCU system is an exceptional value and a remarkable package for even the most demanding HD video applications including House of Worship productions, pro A/V system integration, distance learning classrooms, live events, IMAG systems, UCC applications, videoconferencing, distance learning and lecture capture. To top it all off, the cameras are available in black or arctic white and are made in the USA.

Intended Use:

Before operating the device, please read the entire manual thoroughly. *The system was designed, built and tested for use indoors with the power supply provided.* The use of a power supply other than the one provided or outdoor operation has not been tested and could damage the device and/or create a potentially unsafe operating condition.

Important Safeguards:

Read and understand all instructions before using. Do not operate any device if it has been dropped or damaged. In this case, a Vaddio technician must examine the product before operating. To reduce the risk of electric shock, do not immerse in water or other liquids and avoid extremely humid conditions.



Please do not use "pass-thru" type RJ-45 connectors. These pass-thru type connectors do not work well for professional installations and can be the cause of intermittent connections which can result in the RS-232 control line failing and locking up, and/or compromising the HSDS (high speed differential) signals. For best results please use standard RJ-45 connectors and test all cables for proper pin-outs prior to use and connection to Vaddio product.



ClearVIEW
HD-20SE in
Black

ClearVIEW
HD-20SE in
Arctic White
(AW)

Quick-Connect Universal CCU



Save These Instructions:

The information contained in this manual will help you install and operate your product. If these instructions are misplaced, Vaddio keeps copies of Specifications, Installation and User Guides and most pertinent product drawings for the Vaddio product line on the Vaddio website. These documents can be downloaded from www.vaddio.com free of charge.

UNPACKING:

Carefully remove the product and all of the included parts from the packaging. Identify the following parts:

ClearVIEW HD-20SE QCCU SYSTEM (North America):

Part Number: 999-6987-000

- One (1) ClearVIEW HD-20SE Camera (998-6980-000)
- One (1) Quick-Connect Universal CCU Interface (998-1105-034)
- One (1) EZIM CCU Slot Card
- One (1) 36 VDC, 2.78 Power Supply with Power Cord for North America
- One (1) 2-Pos Molex 5mm Euro Connector
- One (1) Vaddio IR Remote Commander
- One (1) EZCamera™ Control Adapter (RJ-45 to DE-9)
- One (1) CONCEAL Wall Mount System in black
- Quick-Start Guide (1-pager)

Note: Full Manuals are downloaded from support.vaddio.com



ClearVIEW HD-20se, HD PTZ Camera (International):

Part Number: 999-6987-001

- One (1) ClearVIEW HD-20SE Camera (998-6980-000)
- One (1) Quick-Connect Universal CCU Interface (998-1105-034)
- One (1) EZIM CCU Slot Card
- One (1) 2-Pos Molex 5mm Euro Connector
- One (1) 36 VDC, 2.78 Power Supply
- One (1) Euro Power Cable
- One (1) UK Power Cable
- One (1) Vaddio IR Remote Commander
- One (1) EZCamera™ Control Adapter (RJ-45 to DE-9)
- One (1) CONCEAL Wall Mount System in black
- Quick-Start Guide (1-pager)

Note: Full Manuals are downloaded from support.vaddio.com

ClearVIEW HD-20se, HD PTZ Camera (North America):

Part Number: 999-6987-000AW (Artic White Version)

- One (1) ClearVIEW HD-20SE Camera (998-6980-000AW)
- One (1) Quick-Connect Universal CCU Interface (998-1105-034)
- One (1) EZIM CCU Slot Card
- One (1) 36 VDC, 2.78 Power Supply with Power Cord for North America
- One (1) 2-Pos Molex 5mm Euro Connector
- One (1) Vaddio IR Remote Commander
- One (1) EZCamera™ Control Adapter (RJ-45 to DB-9)
- One (1) CONCEAL Wall Mount System in AW
- Quick-Start Guide (1-pager)

Note: Full Manuals are downloaded from support.vaddio.com



ClearVIEW HD-20se, HD PTZ Camera (International):

Part Number: 999-6987-001AW (Artic White Version)

- One (1) ClearVIEW HD-20SE Camera (998-6980-000AW)
- One (1) Quick-Connect Universal CCU Interface (998-1105-034)
- One (1) EZIM CCU Slot Card
- One (1) 36 VDC, 2.78 Power Supply with Power Cord for North America
- One (1) 2-Pos Molex 5mm Euro Connector
- One (1) Euro Power Cable
- One (1) UK Power Cable
- One (1) Vaddio IR Remote Commander
- One (1) EZCamera™ Control Adapter (RJ-45 to DB-9)
- One (1) CONCEAL Wall Mount System in AW
- Quick-Start Guide (1-pager)

Note: Full Manuals are downloaded from support.vaddio.com

ANATOMY OF THE CLEARVIEW HD-20SE HD PTZ CAMERA

Image: Front View ClearVIEW HD-20SE



1) Camera and Zoom Lens:

The 20X optical zoom lens is built around a (1/2.8 Type) high-speed, low-noise Exmor CMOS image sensor with a total of 2.38 total megapixels for precise HD video image acquisition.

2) Red Tally Light:

A red tally light is illuminated when the camera receives a command from an external control system.

3) IR Sensors:

IR sensors are built into the front of the ClearVIEW HD-20SE to receive IR signals from the IR remote control supplied with the camera.

4) Blue Power Light:

A Vaddio blue LED power light is illuminated when the camera is turned on. This LED will blink when IR signals are received.

Image: Rear View ClearVIEW HD-20SE Connectors

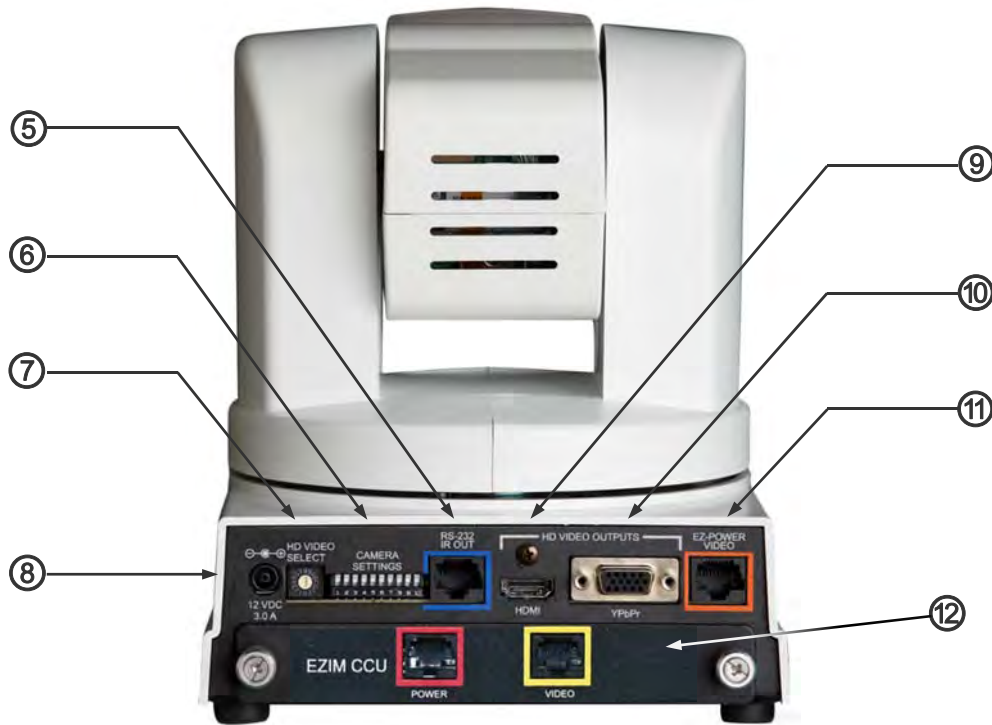

5) RS-232 IN & IR Out (Color Coded Blue):

The RS-232 accepts modified VISCA protocol for camera control. The IR Forwarding feature is not functional with the Quick-Connect USB Interface.

6) Dip Switch Settings:

Settings for IR remote, baud rate and image flip can be configured on these switches. See the Switch Settings page for additional information.

7) HD Video Select:

A rotary switch allows the user to choose the component HD output video resolution and format. See the Switch Settings page for additional information.



HD Resolution Note: When changing the resolution of the camera, the camera may have to be power-cycled after the change. The switcher typically will require a reboot or rescan.

8) 12 VDC Input:

Power input for the standard, ClearVIEW HD-20SE camera power supply.

9) HDMI Output:

The HDMI output feeds out HD digital video only (no copy protect or device communication is included). The HDMI output is optimized for HD video signals (seems logical).

10) YPbPr Output:

Component HD video (YPbPr) is output through the DE-15 connector. YPbPr and HDMI signals are simultaneous. Limited SD resolutions are supported.

11) EZ-POWER VIDEO Port (Color Coded Orange):

This RJ-45 connector is only used with the Quick-Connect SR Interface, Quick-Connect DVI-D/HDMI SR Interface and the Quick-Connect USB Interface to supply power and return HSDS (differential) video from the camera.

12) EZIM CCU Slot Card (Color coded Red for Power and Yellow for HSDS Video):

Optional slot cards can be plugged into the PowerVIEW HD-22 HD camera (the EZIM CCU Slot Card is part of the QCCU System). Power is color coded **Red** and HSDS video is color coded **Yellow**. Universal CCU is color coded similarly.

FIRST TIME SET-UP WITH THE CLEARVIEW HD-20SE:

The ClearVIEW HD-20SE was designed to be a high quality camera that is very easy to use and operate. There is documentation at the back of this manual for pin-outs of the connectors on the ClearVIEW HD-20SE camera.

Step 1: Using the HD VIDEO SELECT rotary switch and CAMERA SETTINGS dip switches on the back of the camera, set up the camera's output resolution and functional preferences. There is a label on the bottom of the camera that identifies the choices.

Important Dip Switch Note: Setting all dip switches down and power cycling the camera will load the factory default camera settings. For the first time set-up, loading the defaults may be a good idea.

Image: Rear Panel Connections

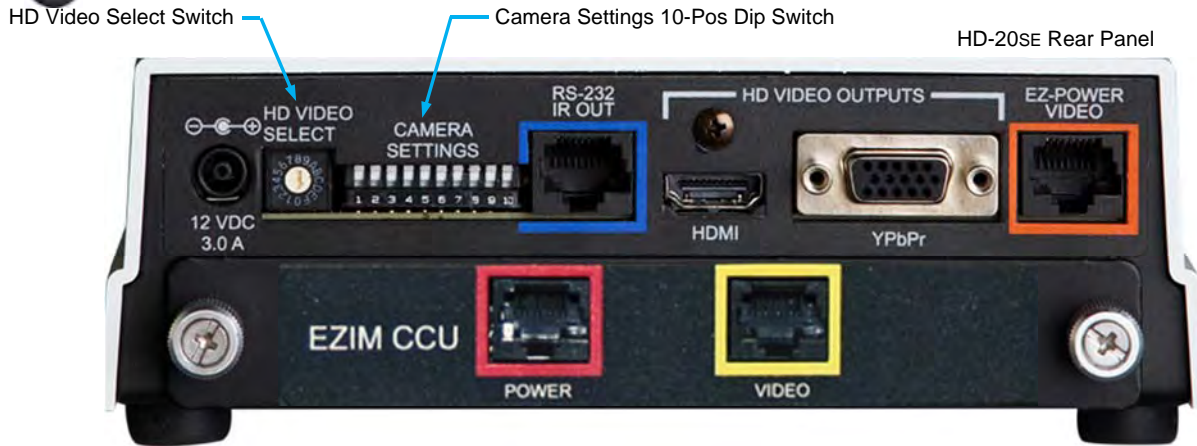

Drawing: Dip Switch and Resolution Label on the Bottom of the ClearVIEW HD-20SE

DIP SWITCH SETTINGS										HD VIDEO SELECT			
IR 1 1 & 2 UP	IR OUT OFF	9600 bps	5 OFF	6 OFF	HDMI COLOR YCbCr	IMAGE FLIP OFF	9 OFF	10 OFF	0	720p/59.94	8	1080p/50	
<input checked="" type="checkbox"/>	<input checked="" type="checkbox"/>	<input checked="" type="checkbox"/>	<input checked="" type="checkbox"/>	<input checked="" type="checkbox"/>	<input checked="" type="checkbox"/>	<input checked="" type="checkbox"/>	<input checked="" type="checkbox"/>	<input checked="" type="checkbox"/>	1	1080i/59.94	9	---	
<input checked="" type="checkbox"/>	<input checked="" type="checkbox"/>	<input checked="" type="checkbox"/>	<input checked="" type="checkbox"/>	<input checked="" type="checkbox"/>	<input checked="" type="checkbox"/>	<input checked="" type="checkbox"/>	<input checked="" type="checkbox"/>	<input checked="" type="checkbox"/>	2	1080p/59.94	A	---	
<input checked="" type="checkbox"/>	<input checked="" type="checkbox"/>	<input checked="" type="checkbox"/>	<input checked="" type="checkbox"/>	<input checked="" type="checkbox"/>	<input checked="" type="checkbox"/>	<input checked="" type="checkbox"/>	<input checked="" type="checkbox"/>	<input checked="" type="checkbox"/>	3	720p/60	B	---	
<input checked="" type="checkbox"/>	<input checked="" type="checkbox"/>	<input checked="" type="checkbox"/>	<input checked="" type="checkbox"/>	<input checked="" type="checkbox"/>	<input checked="" type="checkbox"/>	<input checked="" type="checkbox"/>	<input checked="" type="checkbox"/>	<input checked="" type="checkbox"/>	4	1080i/60	C	---	
<input checked="" type="checkbox"/>	<input checked="" type="checkbox"/>	<input checked="" type="checkbox"/>	<input checked="" type="checkbox"/>	<input checked="" type="checkbox"/>	<input checked="" type="checkbox"/>	<input checked="" type="checkbox"/>	<input checked="" type="checkbox"/>	<input checked="" type="checkbox"/>	5	1080p/60	D	---	
IR 2 ON	IR 3 ON	ON	38400 bps	---	sRGB COLOR	ON	---	---	6	720p/50	E	1080p/30	
<input checked="" type="checkbox"/>	<input checked="" type="checkbox"/>	<input checked="" type="checkbox"/>	<input checked="" type="checkbox"/>	<input checked="" type="checkbox"/>	<input checked="" type="checkbox"/>	<input checked="" type="checkbox"/>	<input checked="" type="checkbox"/>	<input checked="" type="checkbox"/>	7	1080i/50	F	1080p/25	
1	2	3	4	5	6	7	8	9	10				

- Set the desired and available HD output resolution for the camera with the Rotary Switch.
- Set the IR frequency of the camera if it is to respond to the IR remote control.
- If using the IR forwarding feature, set the IR OUT switch to ON (SW3).
- Set the Baud Rate dip switch (SW4) to 9600bps for most applications. Default for Vaddio EZCamera Cabling Systems is 9600bps.
- To set the HDMI or DVI color space, use dip switch 7 (SW7).
- If inverting the camera, turn the IMAGE FLIP ON (SW8).

Dip Switch Settings Explained:

- IR 1 & 2:** The IR remote has the capability of operating up to three different PTZ cameras from one remote. Use the selector buttons at the top of the IR remote to select the frequency.
- IR Out 3:** The IR output is sent out on the RS-232 RJ-45 jack on the back of the camera. Turning on the IR output will allow IR signals to be transmitted over the Cat-5 cable to the head end. When using RS-232 control or Vaddio CCU controllers (also via RS-232), turn the IR OUT to OFF (up).
- Baud Rate 4:** The options for baud rate are either 9600 bps or 38,400 bps.
- HDMI Color or sRGB Color space 7:** Default is YCbCr. Use sRGB color space with older DVI-D 1.0 monitors only. The YCbCr color space works for HDMI digital video.
- Image Flip 8:** To invert the HD-20, turn the IMAGE FLIP ON (switch down).
- Switches 5, 6, 9 and 10:** Leave up - or in the OFF position.

ANATOMY OF THE UNIVERSAL CCU

The Universal CCU will automatically sense the connected camera and initialize the firmware for that camera. The next section will look at the controls and how they are laid out for easy access.

Image: Front Panel CCU Controls



Front Panel Controls (left to right):

- **5-Line Blue Back-lit LED:** Displays up to 8 parameters at a time so the interrelationship of the controls can easily and quickly be read and understood.
- **Tally Light:** A contact closure on the back panel lights the blue LED on front panel indicating which Universal CCU and camera combination is the live Program in a multi-camera CCU installation. A tally command will also be sent to the camera via RS-232 to light the LED on cameras with on-board tally lights

Image: Close up View of the Universal CCU Control Panel



Keypad Controls from (left to right): Touch the button for the parameter to be controlled and adjust the value with the rotary encoder, then touch the cancel button to exit. When the rotary encoder button is touched, the SELECT and CANCEL menu buttons will illuminate to remind the user to either...select or cancel.

- **Scenes A, B & C:** Three user definable camera scenes (A, B & C) can be stored into microprocessor memory. When lit (backlit blue button), the scene is activated. To store a scene, the user adjusts the controls and touches and holds the scene button down until the button blinks. To erase a scene press and hold the scene button and the cancel button.
- **Auto White Balance:** The Automatic White Balance controls/adjusts the color levels automatically when engaged. Take it out of Auto to manually adjust the Red and Blue levels.
- **OPWB (One Push White Balance):** When using OPWB, zoom in on a white subject, at least 60% of the image must be white, touch the OPWB button and the coloration of the image will adjust to the white used in this shot.
- **Red & Blue Gain Controls:** The Red and Blue Gain buttons in combination with the encoder adjust the red and blue gain of the signal when Auto White Balance is disengaged.
- **Chroma:** Chroma controls the overall color of the image being captured.
- **Bright:** This is the overall luminance control for the image.
- **Gamma:** Gamma adjusts the overall brightness of an image to compensate for the perception of luminance and chroma.
- **Detail:** The Detail control sharpens or softens objects in the frame. Works well when looking at text.
- **IRIS - Auto or Manual:** The Auto Iris mode automatically adjusts the iris and gain of the camera. To manually adjust the iris or gain, turn off this control. The Manual Iris control allows the user to set the iris manually to one of the several settings available
- **Gain:** The Gain control boosts the signal level when the iris is open all the way, and there is not enough lighting available. To manually adjust the Gain, Auto Iris must be off. Use the Gain last to enhance the image.
- **Rotary Encoder:** Use the encoder to adjust values after the button is selected. This makes for very quick changes.
- **The Menu Buttons:** There are other screens to be accessed other than the camera control screen. Use the SELECT and CANCEL to enter other controls and exit other menus.

Image: Rear Panel CCU Connections and Controls (left to right)



- **Power Supply Input:** The Universal CCU uses a 36VDC, 2.78 Amp power supply on a 5.5mm OD x 2.5mm ID coaxial connector with a positive center.
- **36 VDC to Camera - RED RJ-45:** Power is provided on a Cat-5 cable to the RoboSHOT 36 VDC RJ-45 marked for CCU use only (see page 9). The power is regulated in the camera to 12 VDC.
- **RS-232 IN - GREY RJ-45:** RS-232 Input from ProductionVIEW™ console, Precision Camera Controller or other custom camera control system. Daisy Chain topology is not supported.
- **RS-232 to Camera - BLUE RJ-45:** RS-232 control is sent through this Cat-5 connection.
- **Tally on 2-pin Molex 5.0mm Euro-Style connector:** A contact closure lights the blue LED on front panel showing which Universal CCU and camera combination is the live Program in a multi-camera CCU installation. A tally command will also be sent to the camera via RS-232 to illuminate the LED on the cameras that have on-board tally lights.
- **Camera Feature Switches:** The CCU interface has an 8-position dip switch on the rear panel to allow for certain functionality. All switches should be in the down position for default.
 - **Dip Switch 1:** Put up to allow Scene A to load upon start-up or boot up.
 - **Dip Switch 5:** Put up to access LCD Display Menu settings including Display Mode, Bias and Contrast.
- **Video from Camera - YELLOW RJ-45:** The yellow RJ-45 receives the camera's differential video signals from the RoboSHOT's EZ-POWER VIDEO jack (but there's no power on the cable).
- **HD Video Outputs:** The Universal CCU has 3 (three) simultaneous video output formats that are the same resolution as the video inputs providing the ultimate in connectivity flexibility. The output formats include:
 - HD YPbPr on DE-15-F (HD15) - (supports up to/and including 1080p/60 - not limited)
 - HDMI on HDMI-F (supports up to and including 1080p/60)
 - HD-SDI on Edge Mount Carrier Class, Gold BNC-F (supports 3Gb/s Single Link 1080p/60 HD-SDI)



Big Important Note: The Quick-Connect Universal CCU supports the resolutions with frame rates of above 50 Hz (60, 59.94 and 50). Consequently, the 30, 29.97 and 25 fps from the Vaddio cameras are not supported

The EZIM (EZ Interface Module) HD-Series Slot Card

The EZIM Slot Card fits into the slot in the base of the HD-20SE and terminates the Power (red) Cat-5 cable and the Video (yellow) Cat-5 cable to the camera (see colors above).



Please remove power from the camera prior to inserting, seating and screwing down the card with the attached thumb screws. Hot swapping is generally advised, so please...turn the camera off before inserting the slot card.

Image: EZIM Slot Card



EZIM CCU Slot Card (Front View)

HD-20SE WITH QUICK-CONNECT UNIVERSAL CCU CONTROL MENUS

The HD-20SE camera has an individual firmware that auto loads when the camera is plugged in to the Universal CCU and the CCU is turned on (Note: Always turn the camera on first so when the CCU wakes up, it will recognize the camera). The menus are organized as follows:

Menu Organization

Main Control Menu 8-Most used Controls displayed	Shutter, Noise Reduction and Image Stabilization Menu	CAT-5 Adjust Menu With Skew, Color Space Y-Gain and Six preset Scene	Version Info Menu	LED Display Menu For set up of front panel LED display	LCD Display Adjustment Menu
--	--	--	--------------------------	--	------------------------------------

For this Menu, put Dip Switch 5 UP

Image: Main Menu Page

The Main Menu screen shows eight (8) prominent parameters at a time. These controls are directly related to the front panel buttons allowing for quick change access. Simply touch the button of the control to be adjusted, and spin the rotary encoder and watch the value of the control on the display change in real-time. This screen does not need a cursor since the control relates directly to a front panel button.

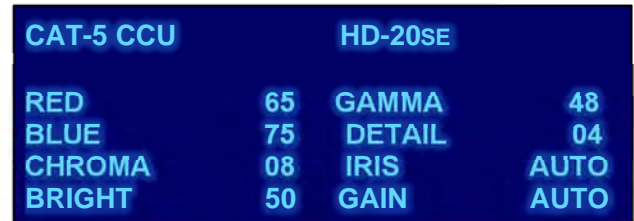
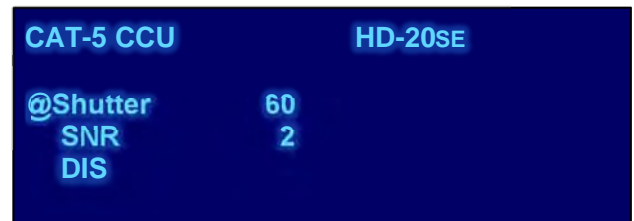

Image: Shutter, Noise Reduction and Image Stabilization Menu

Access to the shutter speed is allowed in this menu. For the most part, it can be left at the default unless challenging or funky lighting demands the use of the shutter. On this screen and the rest, the cursor is the “@” sign and the “>” appears as the parameter is select and adjusted. Touch cancel to return to the cursor mode. A few notes about Super Noise Reduction and Image Stabilization:



Super Noise Reduction: Please use the noise reduction, if needed, on the lower settings. Too much noise reduction will tend to blur images with a lot of movement. So consider the subject matter, if you are shooting a Roller Derby, use as little as possible, conversely a well framed shot of paint drying can use more noise reduction...as needed, of course.

Image Stabilization: It is great for a hand held camcorder, an operator with a tripod and on a mount on the front of a church balcony. But in the absence of shaking and vibration, try not to use image stabilization in general. Using a camera with image stabilization with a joystick can be frustrating as the image will not start or stop with the movements of the joystick because it is buffering frames to apply stabilization and there will be a difficult lag to anticipate. Anticipating for buffered frames isn't anything we like people to have to think about.

Image: Cat-5 Adjustment Menu Page

The Cat-5 Adjustment Menu allows the operator to adjust the skew of the Cat-5 Cable, the color space of the HDMI output, Y-Gain and the Scene Configuration.

- Adjust the skew of the Cat-5 cable (range of 1 to 16) to compensate for differing lengths of the Cat-5 cable pairs between the camera and CCU. This setting will usually be best in the middle of the range of skew numbers which pass acceptable video.
- Set the HDMI Color Space to YCbCr for HDMI and to sRGB for DVI-D output (on an HDMI connector).
- The Y-Gain is for adjusting the video ± 10 IRE at all outputs as needed for associated video equipment.
- Preset Lighting Scene Configurations offer sample settings for fluorescent, incandescent and outdoor lighting environments. Choose the scene (shown in the Screen Config description below) which looks best for the situation and fine tune from there.

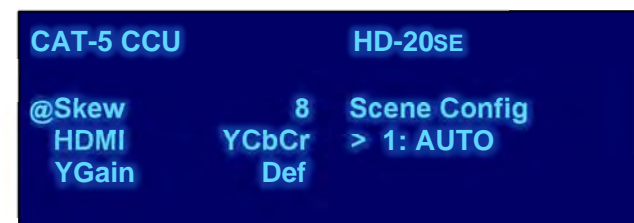

Scene Configurations:

Six (6) Generalized Scene Configurations have been added to allow the user to quickly run through preset lighting environment scenes. The admin can set three (3) custom scenes as well. The following presets are included:

- 1) AUTO (full Auto)
- 2) Incand Lo (incandescent low)
- 3) Incand Hi (incandescent high)
- 4) Fluor Lo (fluorescent low)
- 5) Fluor Hi (fluorescent high)
- 6) Outdoor

Image: Version Info Menu

The Version Menu screen displays the software/firmware versions of the Vaddio cameras attached as a convenience to the operator. The versions shown include the motor firmware and the FPGA code version date.

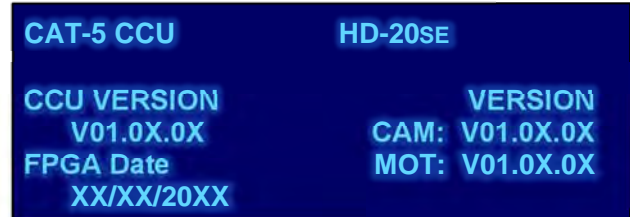

Image: LCD Screen Adjustment Screen

Put DIP switch 5 in the up position to adjust the front panel LCD. The controls provided on this menu include:

- **Display Mode:** Normal (negative mode) and Inverted (positive mode)
- **Bias:** Serves as a brightness control.
- **Contrast:** For overall adjustment of the LCD contrast. Set these controls to taste with the idea of making the display more readable.
- When finished, put DIP switch 5 back in the down position.

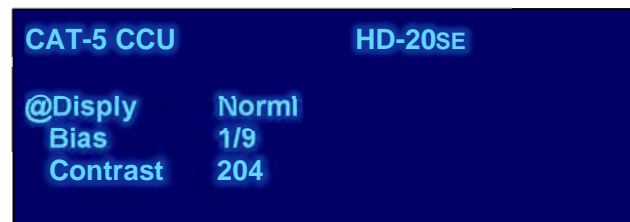

Image: Basic Connectivity Example

HD-20SE camera connected to Quick-Connect Universal CCU Interface, ProductionVIEW™ Precision Camera Controller, Truck and Monitor.

Rear View of ClearVIEW HD-20SE
CONCEAL Mount Not Shown

Rear Panel of HD-20SE with EZIM CCU Slot Card installed in the bottom row slot. All Universal CCU camera packages are shipped with the EZIM CCU Slot Card.



EZ-POWER VIDEO Port (color coded orange) is not used with the QCCU System

EZIM CCU Slot Card

Video, Power and Control on three Cat-5/5e/6 cables up to 500' (152.4m)

36 VDC Power Cat-5e to EZIM CCU Slot Card (red to red)

RS-232 Cat-5e (blue to blue)

HSDS (differential) HD Video Cat-5e from Camera (yellow to yellow)

36 VDC, 2.78 Amp Power Supply



Quick-Connect Universal CCU Interface - Rear Panel

RS-232 Cat-5e

HDMI Output to Local Monitor

HD-SDI Output to Switcher in Truck

ProductionVIEW Precision Camera Controller



Local HD Monitor (23rd Century Simulated Video)



INSTALLATION BASICS:

The ClearVIEW HD-20SE QCCU System with the CONCEAL was designed for installation on a vertical wall surface with Cat-5 cable connectivity for Video, Power and Control signaling (three Cat-5 cables are required). Installation is simplified in that no custom 8-Pin mini-din cables or expensive plenum coax cables are needed and no power outlets are required near the camera bracket. All cabling is routed to the head-end using Cat-5e cables with standard straight through RJ-45 connectors (568B termination). *“Pass-thru” type RJ-45 connectors should be avoided, like black cats and broken mirrors, if at all possible.*



General Installation Instructions for the CONCEAL Wall Mounting System:

Step 1: Determine Camera Mount Location

When locating the camera, consider viewing angles, lighting conditions, possible line of site obstructions and check for in-wall obstructions where the camera is to be mounted. Pick a mounting location to optimize the performance of the camera. After determining the optimum location of the camera system, route the required three (3) Cat-5e cables from the camera to the head-end. Mark the Cables: POWER, VIDEO and CONTROL.

The three (3) Cat-5 cables should feed-through a 1” (25.4mm) opening (circular or square shape) centered in the rectangular slot located on the rear flange of the CONCEAL Wall Mount Bracket.



Note: Do not cut out the entire rectangular slot opening in the wall! This will not allow the two lower wall anchors to correctly fasten the Conceal Wall Mount to the wall.

If the bracket is to be mounted on a 2-gang wall box, use the screws supplied with the wall box cover plate to attach the CONCEAL Wall Mount Bracket. If mounting to drywall with wall anchors, use the four (4) quality wall anchors/screws provided



CONCEAL Wall Mount Bracket:
Cabled and Attached to Wall



Fig. 2: Camera aligned and attached to the CONCEAL Wall Mount Bracket (by two-(1/4”-20) screws in the bottom of the mount).



Note: Check all Cat-5e cables for continuity in advance of final connection. Plugging the POWER Cat-5e cable into the wrong RJ-45 may cause damage to the camera system and void the warranty!

Step 2: System Wiring

Follow the sample wiring diagrams for connecting the Cat-5e cables to the camera and Quick-Connect Universal CCU Interface. Additional diagrams are available on the Vaddio website.

Connect the camera side as follows:

- Connect the POWER Cat-5 to the Power RJ-45 on the EZIM CCU Slot Card.
- Connect the VIDEO Cat-5 to the Video RJ-45 on the EZIM CCU Slot Card.
- Connect the RS-232 control Cat-5 to the “RS-232 IN” RJ-45 on the top row of connectors on the camera.

Connect the Universal CCU side as follows:

- Connect the VIDEO Cat-5 cable to the VIDEO FROM CAMERA RJ-45 jack (yellow) on the CCU.
- Connect the RS-232 Cat-5 cable to the RS-232 TO CAMERA RJ-45 (Blue) on the CCU.
- Wait to connect the POWER Cat-5 cable until later.

Step 3: Secure the Camera To the CONCEAL Wall Mount Bracket

After all cables are attached to the camera, place the camera onto the camera mount and insert the two 1/4"-20 screws into the camera through the two-screw holes in the bottom of the mount. **Note:** Be sure to align each side of the camera evenly to all sides of the CONCEAL Wall Mount Bracket before final tightening of the mounting screws.

Step 4: Install the CONCEAL Lower Cover Plate

Attach the CONCEAL lower cover plate. Slide lower cover plate from front of the mounting bracket toward the rear of the bracket. The two (2) rear locking tabs will need to be guided into position first and will lock in place as the lower cover plate is pushed toward the rear of the mounting bracket and the front two (2) tabs are inserted.

CONCEAL Lower Cover Plate with Locking Tabs



CONCEAL Lower Cover Plate locked in place



Step 5: Install the CONCEAL Rear Camera Cover

After successful testing of the camera, install the CONCEAL rear camera cover on the mounting bracket with the supplied screw (see Fig. 5 and 6).

CONCEAL Rear Camera Cover



Completed CONCEAL Wall Mount Camera Bracket Installation



Step 6: Connect System Power (it's alive)

Connect the Vaddio 36 VDC power supply to the Quick-Connect Universal CCU Interface and an AC outlet. The CCU will power the camera via the Cat-5e cable. The camera will "Home" to a centered position ready for control information from the Universal CCU. To ensure proper continuity of control and operation of the cameras, the RS-232 controller (control system or joystick) should be powered on after the camera(s). The video outputs will be live at this point. Whatever resolution that was picked with the Rotary HD Video Select switch will be at the outputs of the CCU (HDMI, HD-SDI and YPbPr) simultaneously (see page 7).



A Note on Boot Order: When using a joystick controller or external control system, in order to ensure proper continuity of control and operation of the cameras, the RS-232 controller should be powered-on after the camera. In most, if not all cases, the camera needs to be on and running in order for communication to take place between the camera and controller. When plugging a new camera into a RS-232 controller/joystick that has already been powered up, a system reboot or camera rescan may be necessary to find the camera.

OPTIMIZING CCU SYSTEM PERFORMANCE:

Optimizing the CCU settings will help achieve maximum performance from the system. Difficult lighting is one of the most challenging problems video system integrators face. The Vaddio CCU will provide the flexibility to fine tune for variables such as cable length, day/night lighting transitions and lighting color temperature.



- **Set skew control:**

Adjust to afford the best picture brightness, quality and clarity. The range is 0-16. There will typically be a range of values where the video will output a valid image. The best setting is usually achieved with a number roughly in the middle of this valid video range.

- **Adjust Y Gain:**

Allows for the adjustment of luminance gain up to +/- 10% as needed to compensate for a too light or too dark image in downstream equipment.

- **Adjust Iris and Digital Gain Settings:**

Disable Auto Iris. Set the Iris to its largest aperture (lowest 'f' number). Adjust the Gain until the image is too dark and then bring it back until it is properly exposed. Exposures that require high gain settings will have a grainy video image. Adjust the detail setting lower for a smoother image.

- **Adjust Color to Taste:**

Required adjustments will vary based on the environment. The CCU allows the set-up of three (3) scenes so settings are available for a variety of conditions. Adjust the Chroma level to taste. Adjust Red/Blue levels next. Adjusting for skin tones or using a color chart is an easy way to find a good baseline setup.

COMPLIANCE AND CE DECLARATION OF CONFORMITY - CLEARVIEW HD-20SE

Compliance testing was performed to the following regulations:

- **FCC Part 15 (15.107, 15.109), Subpart B**
- **ICES-003, Issue 4: 2004**
- **EN 55022 A: 2006 + A1: 2007**
- **KN24 2008 (CISPR 24: 1997 + A1: 2000 + A2: 2002)**
- **KN22 2008 (CISPR 22: 2006)**
- **EMC Directive 2004/108/EC**
- **EN 55024: A2: 2003**

- Class A
- Class A
- Class A
- Class A
- Class A
- Class A
- Class A



FCC Part 15 Compliance

This equipment has been tested and found to comply with the limits for a Class A digital device, pursuant to Part 15, Subpart B, of the FCC Rules. These limits are designed to provide reasonable protection against harmful interference when the equipment is operated in a commercial environment. This equipment generates, uses, and can radiate radio frequency energy and, if not installed and used in accordance with the instruction manual, may cause harmful interference to radio communications. Operation of this equipment in a residential area is likely to cause harmful interference in which case the user will be required to correct the interference at his/her own expense.

Operation is subject to the following two conditions: (1) This device may not cause interference, and (2) This device must accept any interference including interference that may cause undesired operation of the device. Changes or modifications not expressly approved by Vaddio can affect emission compliance and could void the user's authority to operate this equipment.



ICES-003 Compliance

This digital apparatus does not exceed the Class A limits for radio noise emissions from digital apparatus set out in the Radio Interference Regulations of the Canadian Department of Communications.

Le présent appareil numérique n'émet pas de bruits radioélectriques dépassant les limites applicables aux appareils numériques de la classe A prescrites dans le Règlement sur le brouillage radioélectrique édicté par le ministère des Communications du Canada.



European Compliance

This product has been evaluated for Electromagnetic Compatibility under the EMC Directive for Emissions and Immunity and meets the requirements for a Class A digital device. In a domestic environment this product may cause radio interference in which case the user may be required to take adequate measures.

Standard(s) To Which Conformity Is Declared:

EMC Directive 2004/108/EC

EN 55022 A: 2006 + A1: 2007(CISPR 22:2005/A1:2005)

EN 55024: 1998 + Amendments A1: 2001 + A2: 2003

- EN 61000-4-2: 1995 + Amendments A1: 1998 + A2: 2001
- EN 61000-4-3: 2006 + A1: 2008
- EN 61000-4-4: 2004 + Corrigendum 2006
- EN 61000-4-5: 2006
- EN 61000-4-6: 2009
- EN 61000-4-8: 2010
- EN 61000-4-11: 2004

KN24 2008 (CISPR 24: 1997 + A1: 2000 + A2: 2002)

- EN 61000-4-2
- EN 61000-4-3
- EN 61000-4-4
- EN 61000-4-5
- EN 61000-4-6
- EN 61000-4-8
- EN 61000-4-11

IEC 60950-1:2005 (2nd Edition); Am 1:2009

EN 60950-1:2006+A11:2009+A1:2010+A12:2011

- Radiated and Conducted Emissions
- Immunity
- Electrostatic Discharge
- Radiated Immunity
- Electrical Fast Transients
- Surge Immunity
- Conducted Immunity
- Power Frequency Magnetic Field
- Voltage Dips, Interrupts and Fluctuations
- IT Immunity Characteristics
- Electrostatic Discharge
- Radiated Immunity
- Electrical Fast Transients
- Surge Immunity
- Conducted Immunity
- Power Frequency Magnetic Field
- Voltage Dips, Interrupts and Fluctuations
- Safety
- Safety

**COMPLIANCE AND CE DECLARATION OF CONFORMITY
Quick Connect Universal CCU**



Compliance testing was performed to the following regulations:

- **FCC Part 15, Subpart B**
- **ICES-003, Issue 4: 2004**
- **European Standard EN 55022 A: October 2007**
- **European Standard EN 55024/A2 January 2003**
- **IEC 60950-1:2005 (Second Edition); Am 1:2009**
- **EN 60950-1:2006+A11:2009+A1:2010+A12:2011**
- **EMC Directive 89/336/EC**

- Class A
- Class A
- Class A
- Class A
- Safety
- Safety
- Class A



FCC Part 15 Compliance

This equipment has been tested and found to comply with the limits for a Class A digital device, pursuant to Part 15, Subpart B, of the FCC Rules. These limits are designed to provide reasonable protection against harmful interference when the equipment is operated in a commercial environment. This equipment generates, uses, and can radiate radio frequency energy and, if not installed and used in accordance with the instruction manual, may cause harmful interference to radio communications. Operation of this equipment in a residential area is likely to cause harmful interference in which case the user will be required to correct the interference at his/her own expense.

Operation is subject to the following two conditions: (1) This device may not cause interference, and (2) This device must accept any interference including interference that may cause undesired operation of the device.

Changes or modifications not expressly approved by Vaddio can affect emission compliance and could void the user's authority to operate this equipment.



ICES-003 Compliance

This digital apparatus does not exceed the Class A limits for radio noise emissions from digital apparatus set out in the Radio Interference Regulations of the Canadian Department of Communications.

Le présent appareil numérique n'émet pas de bruits radioélectriques dépassant les limites applicables aux appareils numériques de la classe A prescrites dans le Règlement sur le brouillage radioélectrique édicté par le ministère des Communications du Canada.



European Compliance

This product has been evaluated for Electromagnetic Compatibility under the EMC Directive for Emissions and Immunity and meets the requirements for a Class A digital device. In a domestic environment this product may cause radio interference in which case the user may be required to take adequate measures.

Standard(s) To Which Conformity Is Declared:

EMC Directive 89/336/EC

EN 55022 A: 1998 + A1: 2000

Conducted and Radiated Emissions

EN 55024: 1998 + Amendments A1: 2001 + A2: 2002

Immunity

• EN 61000-4-2:

Electrostatic Discharge

• EN 61000-4-3:

Radiated Immunity

• EN 61000-4-4:

Electrical Fast Transients

• EN 61000-4-5:

Surge Immunity

• EN 61000-4-6:

Conducted Immunity

• EN 61000-4-8:

Power Frequency Magnetic Field

• EN 61000-4-11

Voltage Dips, Interrupts and Fluctuations

• **IEC 60950-1:2005 (Second Edition); Am 1:2009**

Safety

• **EN 60950-1:2006+A11:2009+A1:2010+A12:2011**

Safety

WARRANTY INFORMATION

(See Vaddio Warranty, Service and Return Policies posted on vaddio.com for complete details):

Hardware* Warranty: Two (2) year limited warranty on all parts and labor for Vaddio manufactured products. Vaddio warrants its manufactured products against defects in materials and workmanship for a period of two years from the day of purchase, to the original purchaser, if Vaddio receives notice of such defects during the warranty. Vaddio, at its option, will repair or replace products that prove to be defective. Vaddio manufactures its hardware products from parts and components that are new or equivalent to new in accordance with industry standard practices.

Exclusions: The above warranty shall not apply to defects resulting from improper or inadequate maintenance by the customer, customers applied software or interfacing, unauthorized modifications or misuse, mishandling, operation outside the normal environmental specifications for the product, use of the incorrect power supply, modified power supply or improper site operation and maintenance. OEM products and products manufactured by other companies are excluded and are covered by the manufacturer's warranty.

Vaddio Customer Service: Vaddio will test, repair, or replace the product or products without charge if the unit is under warranty. If the product is out of warranty, Vaddio will test then repair the product or products. The cost of parts and labor charge will be estimated by a technician and confirmed by the customer prior to repair. All components must be returned for testing as a complete unit. Vaddio will not accept responsibility for shipment after it has left the premises.

Vaddio Technical Support: Vaddio technicians will determine and discuss with the customer the criteria for repair costs and/or replacement. Vaddio Technical Support can be contacted through one of the following resources: e-mail support at support@vaddio.com or online at vaddio.com.

Return Material Authorization (RMA) Number: Before returning a product for repair or replacement request an RMA from Vaddio's technical support. Provide the technician with a return phone number, e-mail address, shipping address, product serial numbers and original purchase order number. Describe the reason for repairs or returns as well as the date of purchase. See the General RMA Terms and Procedures section for more information. RMA's are valid for 30 days and will be issued to Vaddio dealers only. End users must return products through Vaddio dealers. Include the assigned RMA number in all correspondence with Vaddio. Write the assigned RMA number clearly on the shipping label of the box when returning the product. All products returned for credit are subject to a restocking charge without exception.

Voided Warranty: The warranty does not apply if the original serial number has been removed or if the product has been disassembled or damaged through misuse, accident, modifications, use of incorrect power supply, use of a modified power supply or unauthorized repair.

Shipping and Handling: Vaddio will not pay for inbound shipping transportation or insurance charges or accept any responsibility for laws and ordinances from inbound transit. Vaddio will pay for outbound shipping, transportation, and insurance charges for all items under warranty but will not assume responsibility for loss and/or damage by the outbound freight carrier. If the return shipment appears damaged, retain the original boxes and packing material for inspection by the carrier. *Contact your carrier immediately.*

Products not under Warranty: Payment arrangements are required before outbound shipment for all out of warranty products.

Other General Information:

Care and Cleaning

Do not attempt to take this product apart at any time. There are no user-serviceable components inside.

- Do not spill liquids in the product
- Keep this device away from food and liquid
- For smears or smudges on the product, wipe with a clean, soft cloth
- Use a quality lens cleaner on the lens
- Do not use any abrasive chemicals.

Operating and Storage Conditions:

Do not store or operate the device under the following conditions:

- Temperatures above 40°C (104°F) or temperatures below 0°C (32°F)
- High humidity, condensing or wet environments
- In inclement weather
- In swimming pools
- Dry environments with an excess of static discharge
- In the asteroid belt (collision issues)
- Under severe vibration

GENERAL SPECIFICATIONS:

ClearVIEW HD-20se, HD PTZ Camera	
Part Numbers	999-6986-000 (North America), 999-6986-001 (Int'l) - Black Camera Version 999-6986-000AW (North America), 999-6986-001AW (Int'l) - Artic White Camera Version
Image Sensor	1/2.8-Type Exmor, high-speed, low-noise CMOS Image Sensor 2.38 Megapixels (2.14M effective pixels).
Zoom	20X Optical Zoom with Multi-element Glass Lens
Field of View	Horizontal: 63° Wide End to 3.47° Tele End, (16:9 Aspect Ratio) Vertical: 36.8° Wide End to 1.85° Tele End
Lens Focal Length	f=4.44mm to 89mm / F1.6 - F3.4
Minimum Illumination	Color: 0.3 Lux (F1.6, 1/30 sec, 50 IRE), B/W: 0.03 Lux (F1.6, 1/30 sec, 50 IRE)
Video Resolutions	HD: 1080p/60/59.94/50./30/25, 1080i60/59.94/50 and 720p/60/59.94/50 HD Video Resolutions Only at 16:9
White Balance	Auto, Manual (Red and Blue Gain), OPWB, Indoor, Outdoor and Fluorescent
Video Output Formats	HDMI, Analog Component, HSDS (Differential Video, Power and Control for Quick-Connects)
Signal to Noise Ratio	Greater than 50 dB (AGC: Off)
Compatible Quick-Connects	Quick-Connect SR, Quick-Connect DVI/HDMI SR, Quick-Connect USB and Quick-Connect Universal CCU
Pan Range	Pan: +170 degrees to -170 degrees, Tilt: +90 degrees to -30 degrees
Preset Positions	16 (internal), 6 recalled via IR Remote
Control Methods	RS-232, IR Remote Commander and OSD (on screen display)
Tally Light	Available through RS-232 Control
HD Video Select	16-Position Rotary Switch: Used to set HD Video Resolution Output
Camera Settings	10-Position Dip Switch: Settings for IR Select, Baud Rate 9600, Image Flip and Color Space
Accessory Slot Cards	EZIM CCU Slot Card, Part Number 998-6900-006
Dimensions/Weight	7.81" (198.37mm) H x 6.67" (169.42mm) W x 7.057" (179.25. mm) D / 5.6 lbs. (2.630835643 kg.)
Quick-Connect Universal CCU Interface	
Connectors	<ul style="list-style-type: none"> Power Connector: 5.5mm OD x 2.5mm ID Power RJ-45: Supplies 36V to EZIM Slot Card RS-232 IN RJ-45: Accepts RS-232 from ProductionVIEW or other non-daisy-chain control systems RS-232 OUT RJ-45: Passes RS-232 and Sync video feed to camera EZIM Tally: 2-Pin Phoenix type spring cage connector Video From Camera RJ-45: Accept differential video from EZIM Slot Card Video Outputs: <ul style="list-style-type: none"> HD-YPbPr on DE-15-F connector HDMI on HDMI-F connector HD-SDI on Edge Mount Carrier Class, Gold BNC-F (supports 3Gb/s Single Link 1080p/60 HD-SDI)
Video Support	The Quick-Connect Universal CCU supports resolutions with frame rates of above 50 Hz (60, 59.94 and 50). Consequently, the 30, 29.97 and 25 frame rates from the Vaddio cameras are not supported.
Camera Settings Switch	All switches should be in the down position for default. <ul style="list-style-type: none"> Dip Switch 1: Put up to allow Scene A to load upon start-up or boot up. Dip Switch 5: Put up to access LCD Display Menu settings including Display Mode (Negative Mode-Default or Positive Mode), Bias (Brightness) and Contrast. Dip Switches 2, 3, 4, 6, 7 & 8: NA for HD-20, HD-19 and HD-18
Video Adjustments	Y-Gain (luminance gain) for fine tuning over longer cable distances Skew for distance compensation:
CAT-5/5e/6 Cable Maximum Distance	Up to 500' (152.4m)
Power Supply	36 VDC, 2.78 Amp
Dimensions	1-RU Rack Mount - 1.72" H x 18.93" W x 7" D (43.7mm x 480.1mm x 177.8mm) Rack Ears Included

APPENDIX 1: CABLE PIN-OUTS FOR THE QUICK-CONNECT UNIVERSAL CCU



Power Connector RJ-45 (Red)

Pin #	Function	Pairs
Pin - 1	Power +	1
Pin - 2	Power -	1
Pin - 3	Power +	2
Pin - 4	Power -	3
Pin - 5	Power +	3
Pin - 6	Power -	2
Pin - 7	Power +	4
Pin - 8	Power -	4

36 VDC TO CAMERA

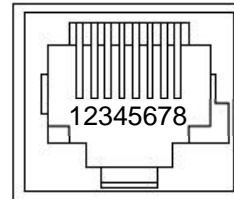

RS-232 IN RJ-45 (Green)

Pin #	Function	Pairs
Pin - 1	N/A	Not Used
Pin - 2	N/A	Not Used
Pin - 3	N/A	Not Used
Pin - 4	N/A	Not Used
Pin - 5	N/A	Not Used
Pin - 6	Digital GND	
Pin - 7	RXD (from TXD of control source)	4
Pin - 8	TXD (to RXD of control source)	4

RS-232 IN

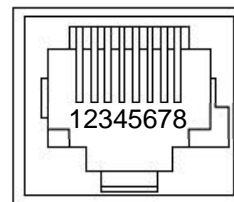

RS-232 OUT RJ-45 (Blue)

Pin #	Function	Pairs
Pin - 1	N/A	Not Used
Pin - 2	N/A	Not Used
Pin - 3	N/A	Not Used
Pin - 4	N/A	Not Used
Pin - 5	N/A	Not Used
Pin - 6	Digital GND	
Pin - 7	TXD (to RXD of control source)	4
Pin - 8	RXD (from TXD of control source)	4

RS-232 TO CAMERA

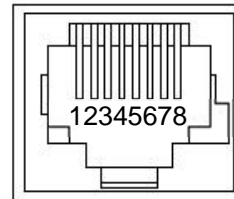

Video (HSDS-differential) RJ-45 (Yellow)

Pin #	Function	Pairs
Pin - 1	N/A	Not Used
Pin - 2	N/A	Not Used
Pin - 3	Y+	2
Pin - 4	PB+	33
Pin - 5	PB GND	3
Pin - 6	Y GND	2
Pin - 7	PR+	4
Pin - 8	PR-	4

VIDEO FROM CAMERA

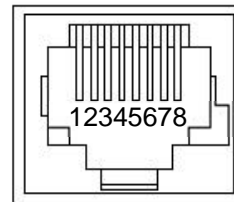

Appendix 1 (continued)
EZIM Slot Card Pin-outs



EZIM CCU Slot Card (Front View)

Power Connector RJ-45 (Red)

Pin #	Function	Pairs
Pin - 1	Power +	1
Pin - 2	Power -	1
Pin - 3	Power +	2
Pin - 4	Power -	3
Pin - 5	Power +	3
Pin - 6	Power -	2
Pin - 7	Power +	4
Pin - 8	Power -	4

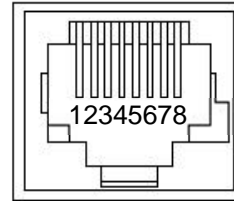

POWER

Video (HSDS-differential) RJ-45

Pin #	Function	Pairs
Pin - 1	N/A	Not Used
Pin - 2	N/A	Not Used
Pin - 3	Y+	2
Pin - 4	PB+	3
Pin - 5	PB GND	3
Pin - 6	Y GND	2
Pin - 7	PR+	4
Pin - 8	PR-	4

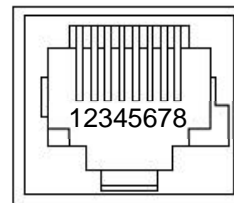

VIDEO

Drawing: ClearVIEW HD-20se Dimensions

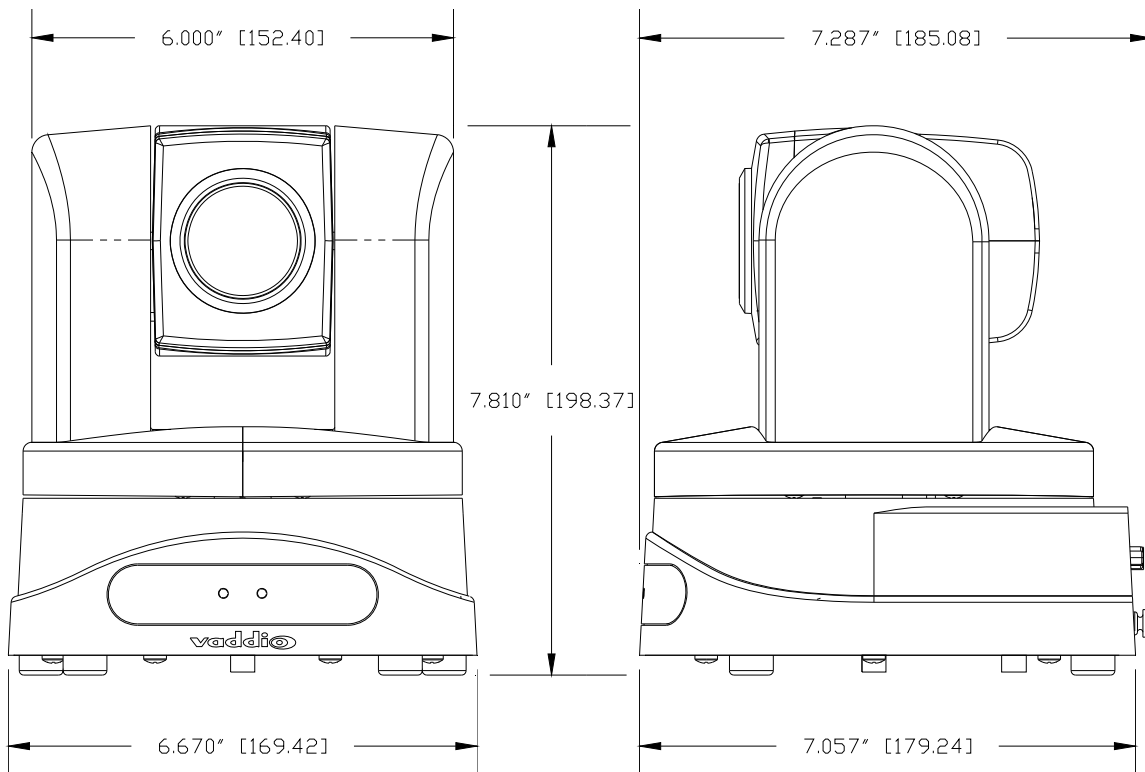

COMMUNICATION SPECIFICATION

Communication Speed: 9600 bps (default)
 Start bit: 1
 Stop bit: 1
 Data bits: 8
 Parity: None
 No Flow control

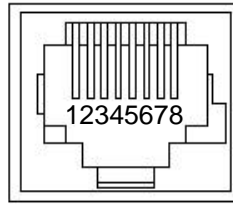

Pin #	RJ-45 RS-232 and IR Out Pins
1)	Unused
2)	Unused
3)	Unused
4)	IR Output (Diff Signal to Quick-Connect SR)
5)	IR Ground (Diff Signal to Quick-Connect SR)
6)	GND (GND of IR Short Range - Pin 3)
7)	RXD (from TXD of control source)
8)	TXD (to RXD of control source)

NOTE: The Vaddio ClearVIEW HD-20SE Control Protocol is similar, but not identical to, the Sony® VISCA™ command set in order to be compatible with several popular control devices. Not all VISCA commands are supported and there are many HD-Series specific commands in the following Command and Inquiry Lists.

HD-20SE Command List (1/2)

Command Set	Command	Command Packet	Comments
Address Set	Broadcast	88 30 01 FF	Address Set (Daisy chain)
IF_Clear	Broadcast	88 01 00 01 FF	IF Clear
Command Cancel		8x 2p FF	p:socket number(1,2)
CAM_Power	On	8x 01 04 00 02 FF	Power On/Off
	Off(Standby)	8x 01 04 00 03 FF	
CAM_Zoom	Stop	8x 01 04 07 00 FF	pqrs: Zoom Position* v:(Speed) 0-7
	Tele(Standard)	8x 01 04 07 02 FF	
	Wide(Standard)	8x 01 04 07 03 FF	
	Tele(Variable)	8x 01 04 07 2p FF	
	Wide(Variable)	8x 01 04 07 3p FF	
	Direct	8x 01 04 47 0p 0q 0r 0s FF	
CAM_Focus	Direct(Variable)	8x 01 7E 01 4A 0v 0p 0q 0r 0s FF	pqrs: Focus position*
	Stop	8x 01 04 08 00 FF	
	Far(Standard)	8x 01 04 08 02 FF	
	Near(Standard)	8x 01 04 08 03 FF	
	Far(Variable)	8x 01 04 08 2p FF	
	Near(Variable)	8x 01 04 08 3p FF	
	AutoFocus	8x 01 04 38 02 FF	
	ManualFocus	8x 01 04 38 03 FF	
CAM_WB	Auto/Manual	8x 01 04 38 10 FF	pqrs: Focus position*
	Direct	8x 01 04 48 0p 0q 0r 0s FF	
	Auto	8x 01 04 35 00 FF	
	Manual	8x 01 04 35 05 FF	
	Indoor	8x 01 04 35 01 FF	
CAM_RGain	Outdoor	8x 01 04 35 02 FF	pqrs:00-0xffff
	One Push WB	8x 01 04 35 03 FF	
	Reset	8x 01 04 03 00 FF	
	Up	8x 01 04 03 02 FF	
CAM_BGain	Down	8x 01 04 03 03 FF	pqrs:00-0xffff
	Direct	8x 01 04 43 0p 0q 0r 0s FF	
	Reset	8x 01 04 04 00 FF	
	Up	8x 01 04 04 02 FF	
CAM_AE	Down	8x 01 04 04 03 FF	Auto Exposure Mode Manual Control Mode Shutter Priority Mode Exposure Priority Mode (default)
	Direct	8x 01 04 44 43 0p 0q 0r 0s FF	
	Full Auto	8x 01 04 39 00 FF	
	Manual	8x 01 04 39 03 FF	
CAM_Iris	Shutter Priority	8x 01 04 39 0A FF	pq(0x00-0x08)
	Iris Priority	8x 01 04 39 0B FF	
	Reset	8x 01 04 0B 00 FF	
	Up	8x 01 04 0B 02 FF	
CAM_Gain	Down	8x 01 04 0B 03 FF	pq(0x00-0x2A)
	Direct	8x 01 04 4B 00 00 0p 0q FF	
	Reset	8x 01 04 0C 00 FF	
	Up	8x 01 04 0C 02 FF	
CAM_Bright	Down	8x 01 04 0C 03 FF	pq(0x01-0x64)
	Direct	8x 01 04 4C 00 00 0p 0q FF	
	Reset	8x 01 04 0D 00 FF	
	Up	8x 01 04 0D 02 FF	
CAM_Bright	Down	8x 01 04 0D 03 FF	pq(0x01-0x64)
	Direct	8x 01 04 4D 00 00 0p 0q FF	
	Reset	8x 01 04 0D 00 FF	
	Up	8x 01 04 0D 02 FF	

HD-20SE Command List (2/2)

Command Set	Command	Command Packet	Comments
CAM_Backlight	On	8x 01 04 33 02 FF	
	Off	8x 01 04 33 03 FF	
CAM_Aperture	Reset	8x 01 04 02 00 FF	
	Up	8x 01 04 02 02 FF	
	Down	8x 01 04 02 03 FF	
	Direct	8x 01 04 42 00 00 0p 0q FF	pq(0x00-0x1F)
CAM_Memory	Reset	8x 01 04 3F 00 0p FF	
	Set	8x 01 04 3F 01 0p FF	
	Recall	8x01 04 3F 02 0p FF	p:Memory No(=0-0xF)
CAM_IDWrite		8x 01 04 22 0p 0q 0r 0s FF	pqrs:0x0000 – 0xFFFF
CAM_LR_Reverse On	On	8x 01 04 61 02 FF	Mirror (Horizontal) on
	Off	8x 01 04 61 03 FF	Mirror (Horizontal) off
IR_Receive##	On	8x 01 06 08 02 FF	
	Off	8x 01 06 08 03 FF	
	On/Off	8x 01 06 08 10 FF	IR forwarding/Local IR
Pan-tiltDrive	Up	8x 01 06 01 VV WW 03 01 FF	VV: Pan Speed (0x01-0x18)
	Down	8x 01 06 01 VV WW 03 02 FF	WW: Tilt Speed(0x01-0x14)
	Left	8x 01 06 01 VV WW 01 03 FF	
	Right	8x 01 06 01 VV WW 02 03 FF	
	UpLeft	8x 01 06 01 VV WW 01 01 FF	
	UpRight	8x 01 06 01 VV WW 02 01 FF	
	DownLeft	8x 01 06 01 VV WW 01 02 FF	
	DownRight	8x 01 06 01 VV WW 02 02 FF	
	Stop	8x 01 06 01 VV WW 03 03 FF	
	Absolute Position	8x 01 06 02 VV WW 0Y 0Y 0Y 0Y 0Z 0Z 0Z 0Z FF	YYYY: Pan Position** ZZZZ: Tilt Position**
	Home	8x 01 06 04 FF	
Reset	8x 01 06 05 FF		
Pan-tilt-zoom Drive	Up	8x 01 06 0A VV WW XX 03 01 03 FF	VV: Pan Speed (0x01-0x18)
	Down	8x 01 06 0A VV WW XX 03 02 03 FF	WW: Tilt Speed(0x01-0x14)
	Left	8x 01 06 0A VV WW XX 01 03 03 FF	XX: ZoomSpeed(0x00-0x07)
	Right	8x 01 06 0A VV WW XX 02 03 03 FF	
	Tele	8x 01 06 0A VV WW XX 03 03 01 FF	
	Wide	8x 01 06 0A VV WW XX 03 03 02 FF	
	UpLeft	8x 01 06 0A VV WW XX 01 01 03 FF	
	UpRight	8x 01 06 0A VV WW XX 02 01 03 FF	
	DownLeft	8x 01 06 0A VV WW XX 01 02 03 FF	
	DownRight	8x 01 06 0A VV WW XX 02 02 03 FF	
	Stop	8x 01 06 0A VV WW XX 03 03 03 FF	YYYY: Pan Position** ZZZZ: Tilt Position** RRRR: ZoomPosition**
	Absolute Position	8x 01 06 0B VV WW XX 0Y 0Y 0Y 0Y 0Z 0Z 0Z 0Z 0R 0R 0R 0R FF	
	Tally	On	8x 01 7E 01 0A 00 02 FF
Off		8x 01 7E 01 0A 00 03 FF	
Preset Pan Speed	Pan/Tilt/Zoom Speed	8x 01 7E 01 0B WW SS ZZ FF	WW: Pan Speed (0x01-0x18) SS:Tilt Speed(0x01-0x14) ZZ:Zoom Speed(0-7);
Motor Config	Hard Motor Stops	8x 01 7E 01 70 00 00 FF	
	Soft Motor Stops	8x 01 7E 01 70 00 01 FF	
BLK.Enhance	Pedestal	No Support	No Support
GMA.Enhance	Gamma	8x 01 7E 54 00 00 0p 0q FF	pq: Gamma (0x00-0x10)
CRM.Enhance	Chroma	8x 01 7E 55 00 00 0p 0q FF	pq: Chroma (0x00-0x64)
KNE.Enhance	Knee	No Support	No Support
DIS.Enhance	Digital Image	8x 01 7E 57 02 FF	On
	Stabilizer	8x 01 7E 57 03 FF	Off
SNR.Enhance	Super Noise	8x 01 7E 58 02 FF	On
	Reduction	8x 01 7E 58 03 FF	Off
AGC.Enhance	AGC Mode	8x 01 7E 59 00 FF	Off
		8x 01 7E 59 01 FF	Low
		8x 01 7E 59 02 FF	Medium
		8x 01 7E 59 03 FF	High
CAM_Shutter	Reset	8x 01 04 0A 00 FF	
	Up	8x 01 04 0A 02 FF	
	Down	8x 01 04 0A 03 FF	
	Direct	8x 01 04 4A 00 00 0p 0q FF	pq(0x00-0x1C)
CAM_ExpComp	On	8x 01 04 3E 02 FF	AutoExposure Off
	Off	8x 01 04 3E 03 FF	AutoExposure On
	Reset	8x 01 04 0E 00 FF	
	Up	8x 01 04 0E 02 FF	
	Down	8x 01 04 0E 03 FF	
CAM_ICR Cut Filter	ICR On	8x 01 04 01 02 FF	ICR On - Cut Filter Out
	ICR Off	8x 01 04 01 03 FF	ICR Off - Cut Filter In

HD-20SE Command List (2/2) Notes

***Zoom and Focus Data:**

CAM_Zoom: Range(0x000-0x071A)
 CAM_Focus: Range (0x0ed-0x0944) dependent on Zoom Position

****Additional Information:**

Pan Range: 8044 – 7FBC (-32,700 to +32,700)
 Tilt Range: E891 – 4C2B (-5,999 to +19,499)
 Actual Pan/Tilt ranges defined in Inquiry list

HD-20se Inquiry List (1/1)

Inquiry Command	Command	Response Packet	Comments
CAM_PowerInq	8x 09 04 00 FF	y0 50 02 FF y0 50 03 FF	On Off(Standby)
CAM_ZoomPosInq	8x 09 04 47 FF	y0 50 0p 0q 0r 0s FF	pqr: 0-0x071A
CAM_FocusPosInq	8x 09 04 48 FF	y0 50 0p 0q 0r 0s FF	pqrs: Focus Position
CAM_WBModelInq	8x 09 04 35 FF	y0 50 00 FF y0 50 05 FF y0 50 01 FF y0 50 02 FF y0 50 03 FF	Auto Manual Indoor Outdoor One Push WB
CAM_RGain	8x 09 04 43 FF	y0 50 0p 0q 0r 0s FF	pqrs: 000-0xffff
CAM_BGain	8x 09 04 44 FF	y0 50 0p 0q 0r 0s FF	pqrs: 000-0xffff
CAM_Iris	8x 09 04 4B FF	y0 50 00 00 0p 0q FF	pq(0x00-0x08)
CAM_Gain	8x 09 04 4C FF	y0 50 00 00 0p 0q FF	pq(0x00-0x2A)
CAM_Bright	8x 01 04 4D FF	y0 50 00 00 0p 0q FF	pq(0x01-0x64)
CAM_BacklightModelInq	8x 09 04 33 FF	y0 50 02 FF y0 50 03 FF	On Off
CAM_ApertureInq	8x 09 04 42 FF	y0 50 00 00 0p 0q FF	Pq:x00-0x1F
CAM_MemoryInq	8x 09 04 3F FF	y0 50 0p FF	p:Preset 0-0xf
CAM_IDInq	8x 09 04 3F FF	y0 50 0p 0q 0r 0s FF	pqrs:0x0000 – 0xFFFF
CAM_ReceiveInq	8x 09 06 08 FF	y0 50 02 FF y0 50 03 FF	On Off
CAM_LR_Reverse	8x 09 04 61 FF	y0 50 02 FF y0 50 03 FF	On Off
Pan-TiltMaxSpeedInq	8x 09 06 11 FF	y0 50 pp qq FF	pp:Pan 0x01-0x18 qq:Tilt 0x01-0x14
Pan-tiltPositionInq	8x 09 06 12 FF	FF y0 50 0p 0p 0p 0q 0q 0q 0q FF	pppp: Pan 0x8044-0x7FB2 qqqq: Tilt 0xE890-0x4C2C
TallyInq	8x 09 7E 01 0A FF	y0 50 02 FF y0 50 03 FF	On Off
PresetSpeedInq	8x 09 7E 01 0B FF	y0 50 pp qq rr FF	pp:Pan 0x01-0x18 qq:Tilt 0x01-0x14 rr:Zoom 0x00-0x07
Motor Config	8x 09 7E 01 70 FF	y0 50 00 FF y0 50 01 FF	Hard Motor Stops Soft Motor Stops
BLK.Enhance	No support	No Support	Pedestal
GMA.Enhance	8x 09 7E 54 FF	y0 50 00 00 0p 0q FF	pq: Gamma (0x00-0x10)
CRM.Enhance	8x 09 7E 55 FF	y0 50 00 00 0p 0q FF	pq: Chroma (0x00-0x64)
KNE.Enhance	No support	No Support	Knee
DIS.Enhance	8x 09 7E 57 FF	y0 50 02 FF y0 50 03 FF	On Off
SNR.Enhance	8x 09 7E 58 FF	y0 50 02 FF y0 50 03 FF	On Off
AGC.Enhance	8x 09 7e 59 FF	y0 50 00 FF y0 50 01 FF y0 50 02 FF y0 50 03 FF y0 50 04 FF	Off Low Medium High Manual AGC
CAM_AEModelInq	8x 09 04 39 FF	y0 50 00 FF y0 50 03 FF y0 50 0A FF y0 50 0B FF	Auto Exposure Mode Manual Control Mode Shutter Priority Mode Exposure Priority Mode
CAM_ShutterPosInq	8x 09 04 4A FF	y0 50 00 00 0p 0q FF	pq: 0x0-0x1C
CAM_ExpCompModelInq	8x 09 04 3E FF	y0 50 02 FF y0 50 03 FF	On - AE Mode Off Off - AE Mode On
CAM_ExpCompPosInq	8x 09 04 4E FF	y0 50 00 00 0p 0q FF	pq: ExpComp Pos
CAM_ICRModelInq	8x 09 04 01 FF	y0 50 02 FF y0 50 03 FF	On - ICR filter Out Off - ICR filter In

TABLE: HD-20SE OSD MENU STRUCTURE

Use this OSD menu with the IR Commander to make video adjustments (AWB, COLOR, EXP, etc...) on the HD-20SE Camera.

Menu	Controls	Modes/Range	Default	Notes
SSDR	OFF		OFF	Dynamic Range Adjustment
	ON	SSDR 0-15	8*	*When Dynamic Range is ON
	Return			Return to Main Menu
WHITE BAL	ATW		ON	Auto White Balance - ON
	MANUAL>	RED 0 - 1000	560	Adjust Red Level
		BLUE 0 - 1000	480	Adjust Blue Level
		RETURN<		Return to WHITE BAL Menu
	AWC-SET			
	OUTDOOR	Set to Outdoor when room has direct sun light and blue walls		
	INDOOR	Set to Indoor when fluorescent lights start to cause color variation in ATW mode		
	MERCURY			
	SODIUM			
	RETURN<			Return to Main Menu
BACKLIGHT	OFF		OFF	Default BLC is off
	WDR>	LEVEL (LOW / MED / HIGH)	OFF	Wide Dynamic Range
		RETURN<		
	BLC>	LEVEL (LOW / MED / HIGH)	OFF	
		BOTTOM 1-100		
		LEFT 1-100		
		RIGHT 1-100		
		RETURN<		Return to BACKLIGHT Menu
	HLC>	LEVEL (LOW / MED / HIGH)	OFF	
		MASK TONE 1-15		
	RETURN<		Return to BACKLIGHT Menu	
	RETURN<			Return to Main Menu
INTELLIGENCE	OFF	Intelligence, motion detection analytics and masking are not processed or used by the HD-20SE camera, however the OSD menu still works.		
FOCUS	MODE	AUTO / MANUAL / ONE PUSH	AUTO	
	ZOOM TRACK>	OFF / TRACK / AUTO TRACK	AUTOTRACK	
	ZOOM SPEED>	SLOW / MEDIUM / FAST		
	DIGITAL ZOOM>	OFF/ON	OFF	Default is OFF
		ON>LIMIT X2 - X16		Avoid Digital Zoom if possible
		RETURN<		Return to FOCUS Menu
	Zoom POS INIT>	OFF/AUTO		Zoom position initialization
		MANUAL>		
		POS INIT 1X - 20X	1X	Sets INIT Zoom Position
		RETURN<		Return to FOCUS Menu
	USER PRESET>	OFF/ON	OFF	
		ON > PRESET NO 1-128	1	Zoom Presets
		PRESET SAVE		
	PRESET CLEAR			
	RETURN<		Return to FOCUS Menu	
LENS INIT	MANUAL / AUTO			
RETURN<			Return to Main Menu	
EXPOSURE	BRIGHTNESS	0-100	50	Brightness Sets Luminance Target
	IRIS>	AUTO	AUTO	Automatic Gain Control
		MANUAL>	Closed to F28	Manual Iris
		RETURN<		Return to EXPOSURE Menu
	SHUTTER	A FLK	Use Anti-Flicker when lighting causes color hunting	
		ESC		
		MANUAL> 1/30 - 1/30,000 sec.		Shutter Speed
		RETURN<		Return to EXPOSURE Menu
	AGC	OFF / LOW / MED / HIGH	LOW	
		MANUAL (OFF)>		
	AGC VALUE 0 - 36dB	0 dB	Automatic Gain Control	
	RETURN<			
SSNR	OFF / LOW / MED / HIGH	LOW	Noise Reduction - Don't use above Low	
SENS-UP	OFF	OFF	OFF - Do not Use	
RETURN<			Return to Main Menu	

ZoomSHOT OSD Menu Structure (continued)

Menu	Controls	Range/Modes	Default	Notes
SPECIAL	DAY/NIGHT>	COLOR / B/W / AUTO	COLOR	Do not use
	DIS>	OFF / ON	OFF	Digital Image Stabilization - leave off
	DEFOG	OFF / ON / MANUAL/AUTO	OFF	Do not use
	COMM ADJUST>	BAUD RATE	NEVER CHANGE THE BAUD RATE OR THE UART SETTINGS - Control is lost if these are changed. Factory default reboot will be required.	
		UART		
		RETURN<		Return to SPECIAL Menu
	IMAGE ADJUST>	H-REV ON / OFF	OFF	Use Dip Switch on Camera to Flip Image
		V-REV ON / OFF	OFF	Use Dip Switch on Camera to Flip Image
		SHARPNESS ON/OFF	ON	Picture Detail
		ON> 0-30	15	
		RETURN<		Return to IMAGE ADJUST Menu
		MONITOR LCD>		
		GAMMA .0 -1.0	0.50	
		COLOR LEVEL 0-100	50	
		RETURN<		Return to IMAGE ADJUST Menu
		USER>		
		GAMMA .0 - 1.0	0.50	
		COLOR LEVEL 0-100	50	
		RETURN<		Return to IMAGE ADJUST Menu
		RETURN<		Return to Main Menu
	DISPLAY	CAM TITLE ON / OFF	OFF	
		ON> A-Z, 1-9		
		RETURN<		Return to DISPLAY Menu
		CAM ID ON / OFF	OFF	
		CAM INFO ON / OFF	OFF	
		ZOOM MAG ON/OFF	OFF	
		OSD COLOR	WHITE	WHITE/YELLOW/GREEN/RED/BLUE
		LANGUAGE	ENGLISH	(ENG, FR, KOR, SP, CHIN, JAP, PORT, RUS, DUT, ITAL)
		SET LANGUAGE		
		RETURN<		Return to Main Menu
	VIDEO OUT FORM	COMPONENT ON / OFF	ON	Do not change this parameter
		RETURN<		Do not change resolutions here - Use the Rotary Switch on the back of the camera
RESET				
EXIT				

CCU SCENE SELECTION COMMANDS

Command Set	Command	Command Packet	Comments
QCCU_Scenes	Reset	8x 01 04 3F 00 7p FF	
	Set	8x 01 04 3F 01 7p FF	
	Recall	8x 01 04 3F 02 7p FF	p: Scene Number =1, 2 or 3

Notes:

For use with Quick-Connect Universal CCU (QCCU), which no daisy-chain operation is allowed, the Command packet will be **81 01 043F 00 7p FF** (where the p is scene 1, 2 or 3.)

A Vaddio PTZ camera must be connected to the QCCU for the scene Set, Recall, and Reset to operate correctly. This command set communicates with the QCCU and the camera simultaneously.



Inside Back Cover - Mostly Blank



Toll Free: 800-572-2011 ▪ Phone: 763-971-4400 ▪ FAX: 763-971-4464
www.vaddio.com

©2015 Vaddio - All Rights Reserved. Reproduction in whole or in part without written permission is prohibited. Specifications and pricing are subject to change without notice or obligation. Vaddio, ClearVIEW, ProductionVIEW, EZCamera, Quick-Connect, EZIM, CONCEAL and HSDS are trademarks of Vaddio. All other trademarks are property of their respective owners. Document Number 342-0937 Rev C, SD: 68669.9