

# RoboTRAK

## Presenter Tracking System

---

999-7270-000B North America  
999-7270-001B Europe and UK  
999-7270-009B Australia and New Zealand



### What's in the box



# Normal Use

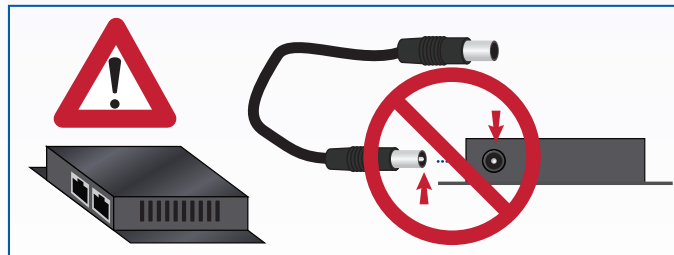
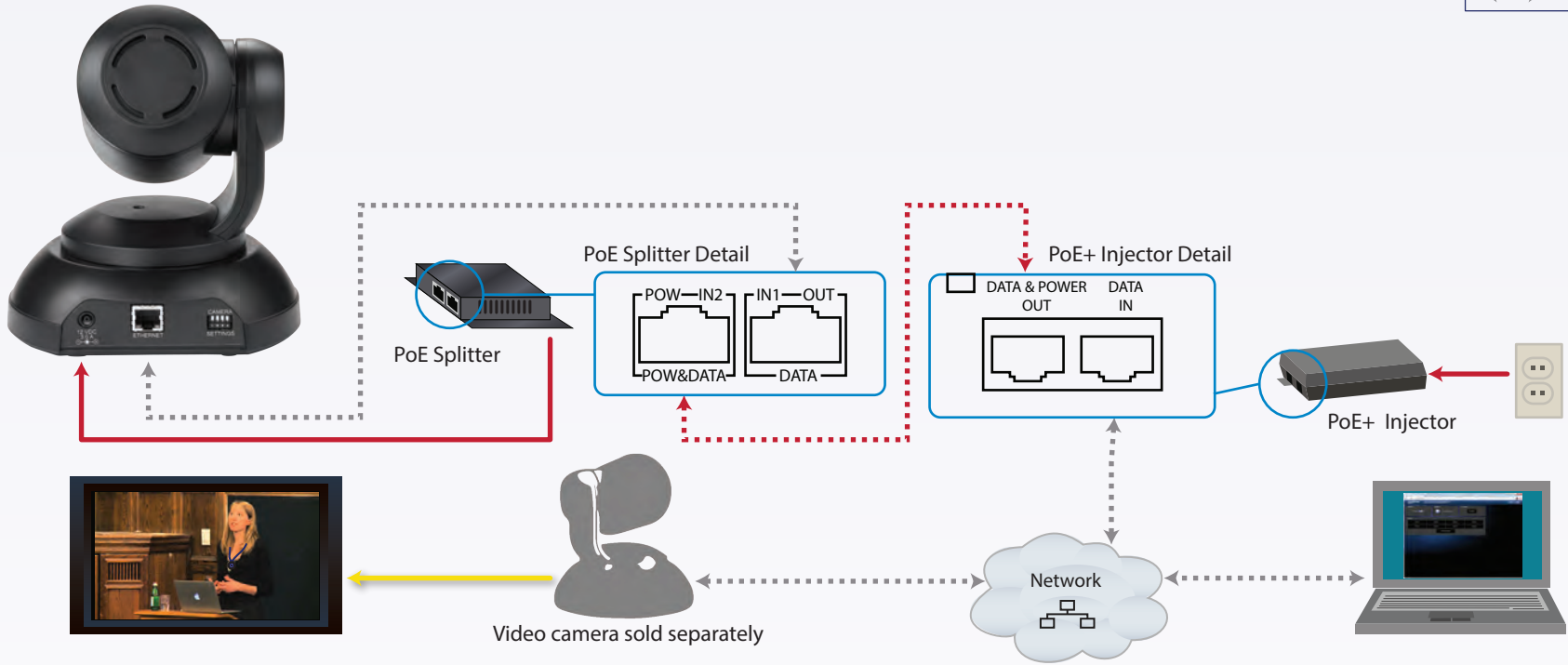
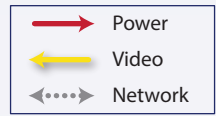

# Configuration and Tuning

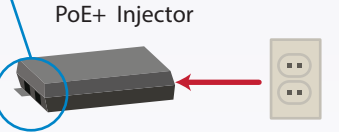
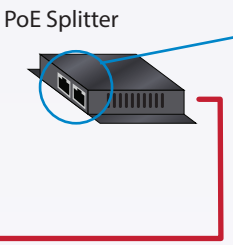
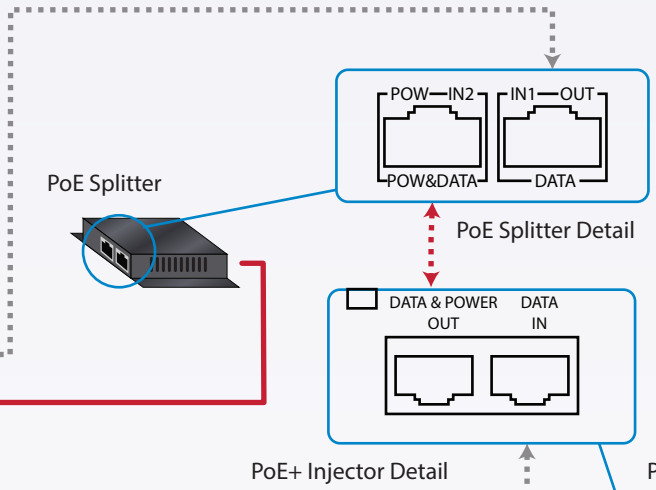
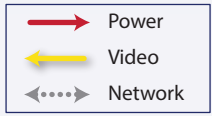

Video camera sold separately

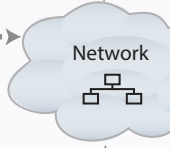

Required for set-up



## Accessing the Web Interface

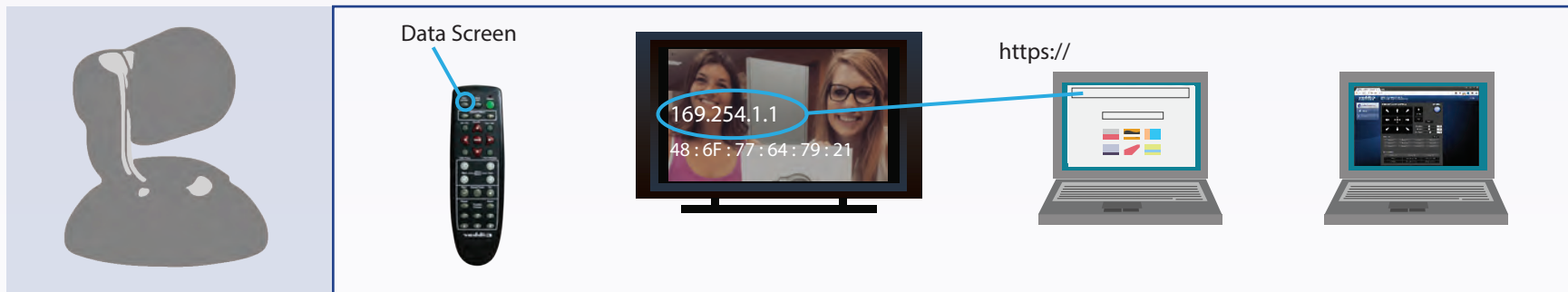
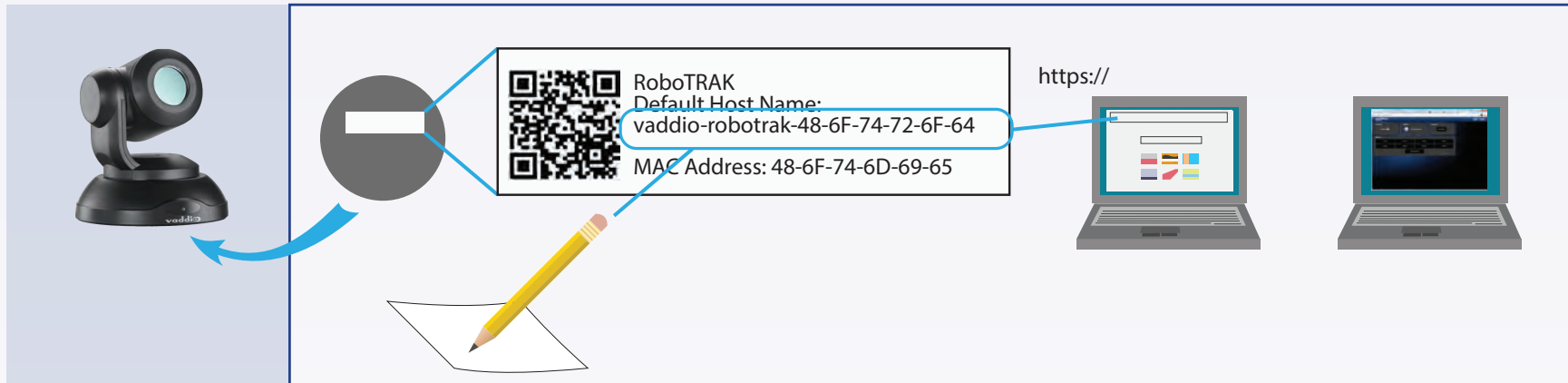

Document 342-1228 Rev B  
July 2020

Vaddio is a brand of Legrand AV · [www.legrandav.com](http://www.legrandav.com) · Phone 800.572.2011 / +1.763.971.4400 · Fax +1.763.971.4464 · Email [av.vaddio.support@legrand.com](mailto:av.vaddio.support@legrand.com)

Visit us at [www.legrandav.com](http://www.legrandav.com) for firmware updates, specifications, drawings, manuals, technical support information, and more.

© 2020 Legrand AV Inc.

Vaddio is a registered trademark of Legrand AV Inc. All other brand names or marks are used for identification purposes and are trademarks of their respective owners. All patents are protected under existing designations. Other patents pending.

AV Brands C2G | Chief | Da-Lite | Middle Atlantic | Projecta | Sanus | Vaddio  
A brand of **legrand**

**vaddio**