

Installing the RoboFLIP 30 HDBT In-Ceiling HD PTZ Camera

This guide contains only the information required to install this product. Refer to the Complete Manual for the RoboFLIP 30 HDBT In-Ceiling HD PTZ Camera for additional product information.



Overview

This guide describes installation and related information for the RoboFLIP 30 HDBT in-ceiling HD PTZ camera:

- Camera with OneLINK HDMI camera extension – 999-99800-100 (North America), 999-99800-101 (Europe/UK), 999-99800-109 (Australia/New Zealand)
- Camera with OneLINK Bridge A/V interface – 999-99800-200 (North America), 999-99800-201 (Europe/UK), 999-99800-209 (Australia/New Zealand)



Unpacking the Camera

Note

This camera is shipped with a tile brace for use in suspended acoustic tile ceilings. Safety wires for suspending and leveling the tile brace are not included, but are strongly recommended. (we recommend the Speed Connect Hardware Kit from Chief, part number CMSHDW)

Make sure you receive all the items you expected.

RoboFLIP 30 HDBT with OneLINK HDMI

999-99800-100 (North America), 999-99800-101 (Europe/UK), 999-99800-109 (Australia/New Zealand)

- RoboFLIP 30 HDBT camera
- Trim ring with mounting screws (shown mounted to the camera)
- Tile support brace
- Cutting template
- IR remote
- OneLINK HDMI Receiver kit – includes:
 - OneLINK HDMI receiver
 - 48 VDC power supply and AC cord set(s)
 - EZCamera RS-232 Control Adapter
- Installation Guide

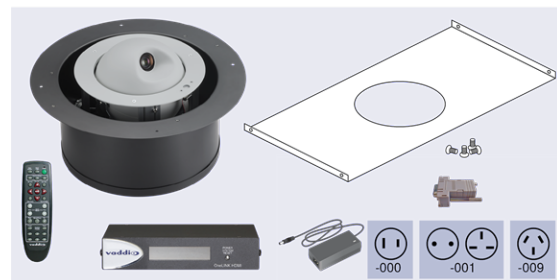

RoboFLIP 30 HDBT with OneLINK Bridge

999-99800-200 (North America), 999-99800-201 (Europe/UK), 999-99800-209 (Australia/New Zealand)

- RoboFLIP 30 HDBT camera
- Trim ring with mounting screws (shown mounted to the camera)
- Tile support brace
- Cutting template
- IR remote
- OneLINK Bridge AV Interface kit – includes:
 - OneLINK Bridge AV interface
 - 48 VDC power supply and AC cord set(s)
 - 3-position Phoenix-type connectors (qty. 4)
 - USB 3.0 cable, type A to type B, 6 ft (1.8 m)
 - EZCamera RS-232 Control Adapter
- Installation Guide

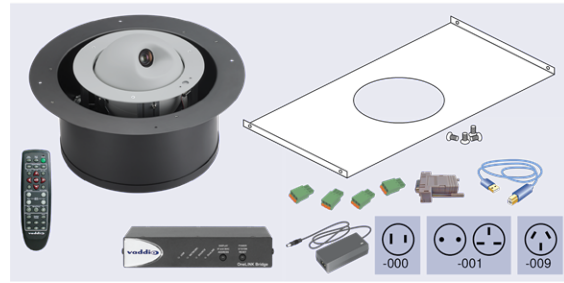

Features of Interest During Installation

- **Camera enclosure** – 12.1 inch diameter with 15.9 inch flange; height 7.02 inches.
- **OneLINK/HDBaseT connector** – For all connectivity and power.
- **Trim ring** – Houses the multifunction button. Extends 0.5 inch from the flange of the camera enclosure for a clean installation in a suspended tile ceiling.



Installing the Camera

This section covers:

- Connections and pre-installation functional check
- Selecting the location for the camera
- Preparing the ceiling
- Installing the camera

Don't Void Your Warranty!

Caution

This product is for indoor use only. Do not install or operate this product if it has been dropped, damaged, or exposed to liquids. If any of these things happen, return it to Vaddio for safety and functional testing.

Safety Notes

Warning

Follow standard safety practices when using ladders or lifts. Failure to do so can result in injury or death.

Notes

All above-ceiling work must conform to local building codes and be performed by qualified personnel. PoE type networks connected to this equipment are for intra-building use only and should not be connected to lines that run outside of the building in which this product is located.

Cabling Notes

Use Cat-5e or better cable. In noisy RF or EMF environments, Cat-6 or Cat-7 is better. Maximum cable distance for Cat-6 or Cat-7 cable is 328 ft. (100 m), 230 ft. (70 m) for Cat-5e cable. We recommend shielded cabling if the cables will be coiled, run tightly with other cables, or routed near sources of electromagnetic interference such as power lines or fluorescent light fixtures. When in doubt, use shielded Cat-6 cable or better.

Caution

When making cables for Vaddio products, do not use pass-through RJ-45 connectors. If they are crimped incorrectly, they can damage the connectors on the product, cause intermittent connections, and degrade signal quality. Physical damage to the connectors will void your warranty.



Intact – Contact fingers will make reliable contact with the cable connector

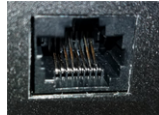

Damaged – Some contact fingers are bent and will NOT make reliable contact with the cable connector

We recommend using high-quality connectors and a high-quality crimping tool.

Caution

Check your cables. Connecting a cable to the wrong port or using the wrong pin-out can result in equipment damage and will void the warranty.



Pro Tip

To prevent tragic mishaps, label both ends of every cable.

Functional Check

Before you install the camera, you may want to verify functionality.

1. Connect the camera in its minimum functional configuration.
If not powered by a OneLINK device, the camera can be connected to an HDBaseT-capable third-party control device through a PoE++ power injector (not provided). Connection details vary depending on the equipment used in your installation.
2. Connect the camera's ribbon cable to the board on the trim ring.
3. Connect power. The camera moves, the indicator light turns blue, and video is available on the connected display.
4. If the camera turns on and sends video, continue with the installation. Otherwise, double-check the connections. Contact Vaddio technical support if the issue persists.



Camera powered by OneLINK HDMI

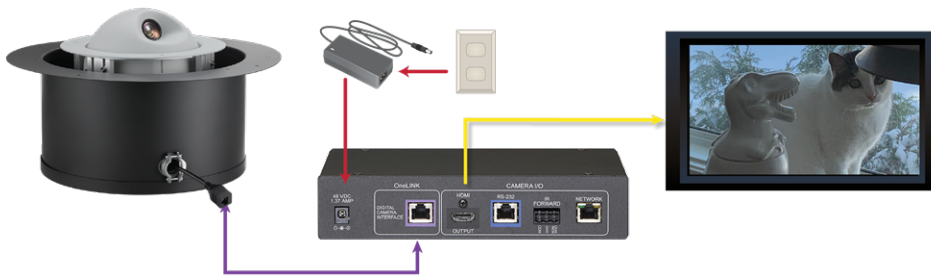

Camera Powered by OneLINK Bridge

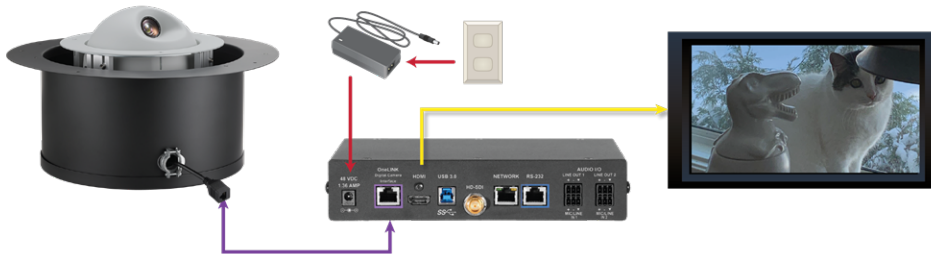

Status Light

The light in the camera's trim ring indicates its current state, unless it has been configured to remain off.

Note

By default, the camera's status light is active during normal operation; however, it can be configured to remain off. When the lens is visible, the camera is on and sending video.

- **Blue:** Ready/normal operation
- **Red:** On-air tally (pro AV color scheme)
- **Purple:** In standby mode or booting
- **Yellow:** Firmware update in progress – overrides status light configuration

The pro AV color scheme is the default for this camera.

Selecting the Installation Area

Note

All above-ceiling work must conform to local building codes and should be performed by qualified personnel.

Verify that the area above the ceiling where the camera is to be installed is clear of obstructions and provides enough room for the camera enclosure.

Suggested ceiling thickness is 0.5" to .625", can be used from .437" to .875"

- The camera is designed to be installed in a suspended acoustic tile ceiling.
- Recommended for installation in ceiling tile 0.5 in. (12.7 mm) to .625 in. (15.9 mm) thick; can be installed in ceiling tile as thin as 0.438 in. (11.1 mm) or as thick as 0.875 in. (22.2 mm)
- The installed weight is roughly 14 lbs (6.4 kg).
- Tile brace footprint 23.31 x 16.44 in. (59.2 x 41.8 cm)
- Minimum 7.75 in. (18.3 cm) of clear space above the opening to maneuver the camera into place

What You Will Need for the Installation

Before you start, be sure you have what you need:

- Access to the area above the ceiling
- Pencil
- Appropriate tool for cutting a hole in the ceiling
- #2 Phillips screwdriver
- Safety wire kit to suspend the assembly (we recommend the Speed Connect Hardware Kit from Chief, part number CMSHDW)
- If required: weathertight cable clamp

Basic Connections

The camera is typically powered by a OneLINK device. This allows the camera to be installed up to 328 ft (100 m) from the rest of the equipment in the installation.

Camera powered by OneLINK HDMI

The OneLINK HDMI camera extension provides camera power and control, and passes video from the camera to an optional HDMI display. USB and IP streams are available from OneLINK devices.

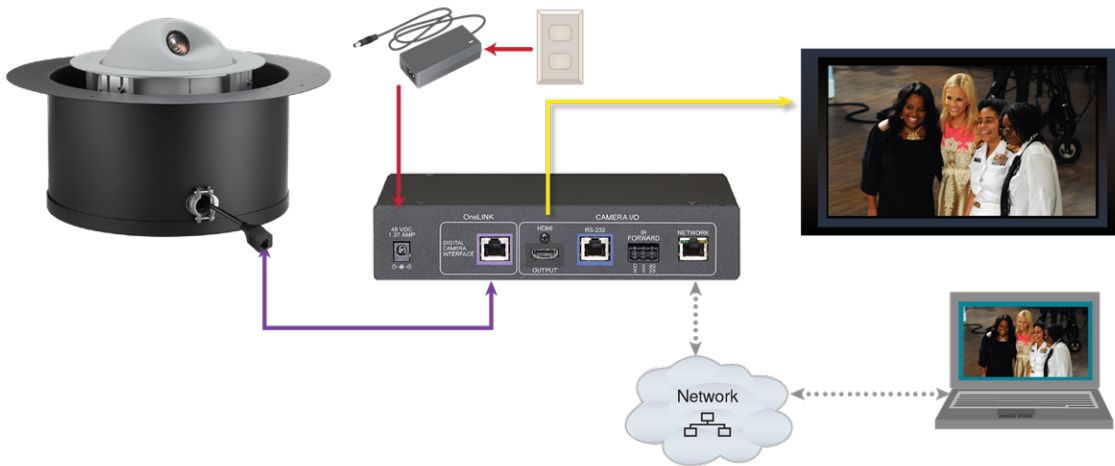

Camera powered by OneLINK Bridge

The OneLINK Bridge AV interface provides audio connections and SDI video output as well as standard OneLINK capabilities.

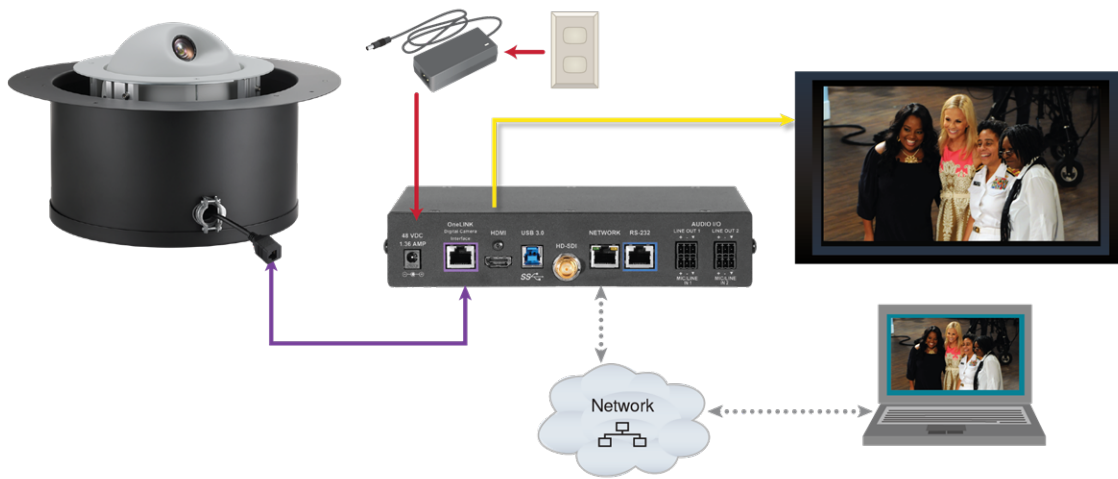

Installing the Camera in a Suspended Tile Ceiling

The camera is mounted above the ceiling, with only the trim ring and the camera shell accessible from below. The camera rests on a support plate above the ceiling tile; the support plate is suspended and leveled by safety wires.

Preparing the Camera

- If an airtight installation is required, replace the cable clamp with a weathertight one.
- Be sure the cable clamp holds the connector cable snugly. Do not overtighten the screws.

Preparing the Tile Ceiling

Note

All above-ceiling work must conform to local building codes and should be performed by qualified personnel.

1. Remove the ceiling tile where the camera will be mounted.
2. Place the tile brace on the back of the ceiling tile and trace a circle to use as a guide in placing the cutting template.
3. Center the template in the circle, and align the tab to the desired centerline for the camera.
4. Trace the opening for the camera on the ceiling tile.
5. Cut the camera opening.
6. Place the tile back in the ceiling grid.
7. Place the tile support brace above the tile, aligning it to the hole in the tile.
8. Secure the tile support brace to the building structure and level it using appropriate hardware. (we recommend the Speed Connect Hardware Kit from Chief, part number CMSHDW)

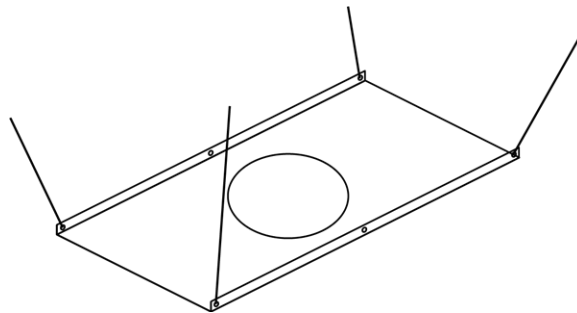

Completing the Installation

1. Place the camera on the tile brace.
2. Fit the trim ring into place. The multifunction button is at the camera's centerline (pan position 0), marked FRONT on the camera frame.
3. Secure the trim ring to the camera frame using the screws provided with it. Do not overtighten the screws.
4. Connect the cable from the OneLINK device to the camera.

Compliance and Conformity Statements

FCC Part 15 Compliance

This equipment has been tested and found to comply with the limits for a Class A digital device, pursuant to Part 15, Subpart B, of the FCC Rules. These limits are designed to provide reasonable protection against harmful interference when the equipment is operated in a commercial environment. This equipment generates, uses, and can radiate radio frequency energy and, if not installed and used in accordance with the instruction manual, may cause harmful interference to radio communications. Operation of this equipment in a residential area is likely to cause harmful interference in which case the user will be required to correct the interference at his/her own expense.



Operation is subject to the following two conditions: (1) This device may not cause interference, and (2) This device must accept any interference including interference that may cause undesired operation of the device.

Changes or modifications not expressly approved by Vaddio can affect emission compliance and could void the user's authority to operate this equipment.

ICES-003 Compliance

This digital apparatus does not exceed the Class A limits for radio noise emissions from digital apparatus set out in the Radio Interference Regulations of the Canadian Department of Communications.



Industry
Canada

Industrie
Canada

Le présent appareil numérique n'émet pas de bruits radioélectriques dépassant les limites applicables aux appareils numériques de la classe A prescrites dans le Règlement sur le brouillage radioélectrique édicté par le ministère des Communications du Canada.

European Compliance

This product has been evaluated for Electromagnetic Compatibility under the EMC Directive for Emissions and Immunity and meets the requirements for a Class A digital device. In a domestic environment this product may cause radio interference in which case the user may be required to take adequate measures.



Testing and Conformity

Compliance testing was performed to the following standards; conformity to each is declared.

Emissions – Class A:

FCC Part 15.107, 15.109 Subpart B	Unintentional Radiators
ICES-003, Issue 6, January 2016	Technical Requirements for Information Technology Equipment
KN22: 2008 (CISPR 22: 2006)	Radio Disturbance Characteristics of Information Technology Equipment
EN 55032: 2015/A11: 2020	Electromagnetic Compatibility of Multimedia Equipment – Emissions Requirements

Immunity:

KN24 2008 (CISPR 24: 1997 + A1: 2000 + A2: 2002)	Information Technology Equipment Immunity
EN 55035: 2017 +A11: 2020	Electromagnetic Compatibility of Multimedia Equipment – Immunity Requirements
EN 61000-4-2	Electrostatic Discharge Requirements
EN 61000-4-3	Radiated Electromagnetic Field Requirements
EN 61000-4-4	Electrical Fast Transient/Burst Requirements
EN 61000-4-5	Surge Requirements
EN 61000-4-6	Conducted Immunity Requirements
EN 61000-4-8	Power Frequency Magnetic Field Requirements
EN 61000-4-11	Voltage Dips, Interrupts and Fluctuations Requirements

Safety:

UL 60950-1, 2nd Edition, 2019-05-09 CAN/CSA C22.2 No. 60950-1-07, 2nd Edition, 2014-10 IEC 60950-1:2005 (Second Edition); Am1:2009 + Am2:2013 EN 60950-1:2006 + A11:2009 + A1:2010 + A12:2011 + A2:2013	Information Technology Equipment - Safety - Part 1: General Requirements
UL 62368-1, 2nd Edition, 2014-12-01 CSA C22.2 No. 62368-1-14, 2nd Edition, 2014-12 IEC 62368-1:2014 (2nd Edition) EN 62368-1:2014 +A11	Audio/video, Information and Communication Technology Equipment - Part 1: Safety Requirements

Vaddio is a brand of Legrand AV Inc. · Phone 800.572.2011 / +1.763.971.4400 · Fax +1.763.971.4464 · Email av.vaddio.support@legrand.com · Visit us at www.legrandav.com for firmware updates, specifications, drawings, manuals, technical support information, and more.

©2020 Legrand AV Inc.

Vaddio is a registered trademark of Legrand AV Inc. All other brand names or marks are used for identification purposes and are trademarks of their respective owners. All patents are protected under existing designations. Other patents pending.

A brand of  legrand®

Commercial AV Brands Chief | Da-Lite | Middle Atlantic | Projecta | Vaddio

vaddio®