



Online UPS

1KVA | 1.5KVA | 2KVA | 3KVA Models

Uninterruptible Power Supply System
User Manual

I-00884 Rev A

Table of Contents

Important Safety Warnings	3
Transportation and Storage.....	3
Preparation.....	3
Installation.....	3
Operation	4
Maintenance, Service and Faults.....	4
Avertissements de sécurité importants	5
Transport et stockage.....	5
Préparation.....	5
Installation.....	6
Fonctionnement	6
Maintenance, Service et Défaits	7
1. Installation and Setup	9
Unpacking and Inspection	9
Rear Panel.....	10
Operating Principle	11
Installing the UPS.....	11
Setting Up the UPS	12
Battery Replacement.....	15
Replacement Battery Assembly.....	15
2. Operations	18
Button Operations.....	18
LCD Panel.....	19
Audible Alarms	20
LCD Panel Index	21
Operating Mode Descriptions	22
UPS Settings.....	23
Fault Reference Codes.....	29
Warning Indicators	30
3. Troubleshooting	31
4. Maintenance and Storage	33
Maintenance	33
Storage	33
5. Specifications	34
Input	34
Output	34
Efficiency	34
Battery	35
Physical.....	35
Environment	35
Management	35
Expandable Battery Box Specification	36

Important Safety Warnings

Comply with all warnings and operating instructions in this manual and save it for future reference. Do not operate this unit before carefully reading through all safety information and operating instructions.

Transportation and Storage



Transport the UPS system only in the original package to protect against shock and impact.



The UPS must be stored in a ventilated and dry room.

Preparation



Condensation may occur if the UPS system is moved directly from cold to warm environments. The UPS system must be absolutely dry before being installed. Please allow at least two hours for the UPS system to adjust to the environment.



Do not install the UPS system near water or in damp environments.



Do not install the UPS system where it would be exposed to direct sunlight or near a heater.



Do not block ventilation holes on the UPS housing.

Installation



Do not connect appliances or devices to the UPS output sockets or terminal that would over load the UPS.



Place cables in such a way that no one can step on or trip over them.



Do not connect domestic appliances such as hair dryers to UPS output sockets.



Connect the UPS system only to a grounded, shockproof outlet, which must be easily accessible and close to the UPS system.



Use only a VDE-tested, CE-marked (or UL-marked for 100/110/115/120/127 Vac models) mains cable (e.g. the mains cable of your computer) to connect the UPS system to the building wiring outlet (shockproof outlet).



Use only VDE-tested, CE-marked (or UL-marked for 100/110/115/120/127 Vac models) power cables to connect the loads to the UPS system.



When installing the equipment, ensure that the sum of the leakage current of the UPS and the connected devices does not exceed 3.5mA.



Temperature Rating: Units are considered acceptable for use in a maximum ambient environment of 104°F (40°C).



For Pluggable Equipment: The socket-outlet shall be installed near the equipment and shall be easily accessible.



The unit is heavy. Lifting the unit requires a minimum of two people.

Operation



Do not disconnect the ground conductor cable on the UPS or the building wiring terminals at any time since this would cancel the protective earth of the UPS system and of all connected loads.



The UPS system features its own, internal current source (batteries), therefore, the UPS output sockets or output terminal blocks may be electrically live even if the UPS system is not connected to the building wiring outlet.



In order to fully disconnect the UPS system, first press the "OFF" button, and then disconnect the mains.



Ensure that no liquid or other foreign objects can enter into the UPS system.



The EPO, RS-232 and USB circuits are an IEC 60950-1 safety extra low voltage (SELV) circuit. This circuit must be separated from any hazardous voltage circuits by reinforced insulation.

Maintenance, Service and Faults



The UPS system operates with hazardous voltages. Repairs may be carried out only by qualified maintenance personnel.



Risk of electric shock. Even after the unit is disconnected from the mains (building wiring outlet); components inside the UPS system are still connected to the battery and are electrically live and dangerous.



Before performing any service and/or maintenance, disconnect the batteries and verify that no current is present and no hazardous voltage exists on the terminals of the high capability capacitor, such as BUS-capacitors.



Only persons are adequately familiar with batteries and with the required precautionary measures may replace batteries and supervise operations. Unauthorized persons must be kept well away from the batteries.



Risk of electric shock. The battery circuit is not isolated from the input voltage. Hazardous voltages may occur between the battery terminals and the ground. Before touching, please verify that no voltage is present.



Do not dispose of batteries in a fire. The batteries may explode.



Do not open or mutilate batteries. Released electrolyte is harmful to the skin and eyes. It may be toxic.



Batteries may cause electric shock and have a high short-circuit current. Please take the precautionary measures specified below and any other measures necessary when working with batteries:

- Remove watches, rings, or other metal objects.
- Use tools with insulated handles.
- Wear rubber gloves and boots.
- Do not lay tools or metal parts on top of batteries.
- Disconnect charging source and load prior to installing or maintaining the battery.
- Remove battery grounds during installation and maintenance to reduce likelihood of shock. Remove the connection from ground if any part of the battery is determined to be grounded.



When changing batteries, install the same number and same type of batteries or battery packs.



For UPS with internally mounted battery:

- Instructions shall have sufficient information to enable the replacement of the battery with a suitable manufacturer and catalogue number.
- Safety instructions to allow access by Service Personnel shall be stated in the installation/service handbook.
- If batteries are to be installed by Service Personnel, instructions for interconnections, including terminal torque, shall be provided.



Do not attempt to dispose of batteries by burning them. This could cause an explosion.



Do not open or destroy batteries. Escaping electrolyte can cause injury to the skin and eyes. It may be toxic.



Only replace the fuse with the same type and amperage to avoid fire hazards.



Do not disassemble the UPS system.



This equipment has been tested and found to comply with the limits for a Class A digital device, pursuant to part 15 of the FCC Rules. These limits are designed to provide reasonable protection against harmful interference when the equipment is operated in a commercial environment. This equipment generates, uses, and can radiate radio frequency energy and, if not installed and used in accordance with the instruction manual, may cause harmful interference to radio communications. Operation of this equipment in a residential area is likely to cause harmful interference in which case the user will be required to correct the interference at his own expense.



Changes or modifications not expressly approved by the party responsible for compliance could void the user's authority to operate the equipment.



This is a product for commercial and industrial applications. In second environment installations, restrictions or additional measures may be needed to prevent disturbances.

Avertissements de sécurité importants

Respectez tous les avertissements et consignes d'utilisation de ce manuel et conservez-le pour référence ultérieure. Ne faites pas fonctionner cet appareil avant de lire attentivement toutes les informations de sécurité et les instructions d'utilisation.

Transport et stockage



Transportez le système UPS uniquement dans son emballage d'origine pour le protéger contre les chocs.



L'onduleur doit être stocké dans une pièce ventilée et sèche.

Préparation



De la condensation peut se produire si le système UPS est directement déplacé d'un environnement froid à un environnement chaud. Le système UPS doit être absolument sec avant d'être installé. Veuillez prévoir au moins deux heures pour que le système d'ASI s'adapte à l'environnement.



N'installez pas l'onduleur à proximité d'eau ou dans un environnement humide.



N'installez pas le système UPS à un endroit exposé à la lumière directe du soleil ou à proximité d'un appareil de chauffage.



Ne bloquez pas les trous de ventilation sur le boîtier de l'onduleur.

Installation



Ne connectez pas de périphériques à la sortie de l'onduleur ou à un terminal susceptible de surcharger l'onduleur.



Placez les câbles de manière à ce que personne ne puisse marcher dessus ou trébucher dessus.



Ne connectez pas d'appareils domestiques tels que des sèche-cheveux aux prises de sortie de l'ASI.



Ne connectez le système ASI qu'à une prise de terre protégée contre les chocs, qui doit être facilement accessible et proche du système ASI.



Utilisez uniquement un câble d'alimentation certifié VDE, marqué CE (ou portant la marque UL pour les modèles 100/110/115/120/127 Vac; par exemple, le câble d'alimentation de votre ordinateur) pour connecter le système UPS au câblage du bâtiment sortie (sortie antichoc).



Utilisez uniquement des câbles d'alimentation VDE, marqués CE (ou marqués UL pour les modèles 100/110/115/120/127 Vac) pour connecter les charges au système UPS.



Lors de l'installation de l'équipement, assurez-vous que la somme du courant de fuite de l'onduleur et des périphériques connectés ne dépasse pas 3.5 mA.



Température nominale: Les unités sont considérées acceptables pour une utilisation dans un environnement ambiant maximal de 40°C (104°F).



Pour les équipements enfichables: La prise de courant doit être installée près de l'équipement et doit être facilement accessible.



L'unité est lourde. Le levage de l'unité nécessite un minimum de deux personnes.

Fonctionnement



Ne déconnectez pas le câble du conducteur de mise à la terre de l'onduleur ou des bornes de câblage du bâtiment car cela annulerait la mise à la terre de protection de l'onduleur et de toutes les charges connectées.



Le système ASI dispose de sa propre source de courant interne (batteries). Par conséquent, les prises de sortie ou les borniers de sortie de l'ASI peuvent être sous tension même si le système ASI n'est pas connecté à la sortie du bâtiment.



Pour déconnecter complètement le système UPS, appuyez d'abord sur le bouton "OFF", puis débranchez le secteur.



Assurez-vous qu'aucun liquide ou autre corps étranger ne puisse pénétrer dans le système ASI.



L'UPS peut être utilisé par des personnes sans expérience préalable.

Maintenance, Service et Défaits



Le système UPS fonctionne avec des tensions dangereuses. Les réparations ne peuvent être effectuées que par du personnel de maintenance qualifié.



Risque de choc électrique. Même après que l'appareil est déconnecté du secteur (prise de câblage du bâtiment); les composants à l'intérieur du système UPS sont toujours connectés à la batterie et sont sous tension et dangereux.



Avant d'effectuer toute opération de maintenance, déconnectez les batteries et vérifiez qu'il n'y a pas de courant et qu'aucune tension dangereuse n'existe sur les bornes du condensateur haute capacité, telles que les condensateurs BUS.



Seules des personnes connaissent bien les batteries et, avec les mesures de précaution requises, peuvent les remplacer et superviser les opérations. Les personnes non autorisées doivent être tenues à l'écart des batteries.



Risque de choc électrique. Le circuit de la batterie n'est pas isolé de la tension d'entrée. Des tensions dangereuses peuvent se produire entre les bornes de la batterie et le sol. Avant de toucher, vérifiez s'il n'y a pas de tension.



Ne jetez pas les piles dans un feu. Les piles peuvent exploser.



N'ouvrez pas et ne mutiliez pas les piles. L'électrolyte libéré est nocif pour la peau et les yeux. Cela peut être toxique.



Les batteries peuvent provoquer un choc électrique et un courant de court-circuit élevé. Veuillez prendre les mesures de précaution suivantes et toutes les autres mesures nécessaires lorsque vous travaillez avec des batteries:

- Retirez les montres, bagues ou autres objets métalliques.
- Utilisez des outils avec des poignées isolées.
- Portez des gants et des bottes en caoutchouc.
- Ne posez pas d'outils ou de pièces métalliques sur les batteries.
- Débranchez la source de charge avant d'installer ou de maintenir la batterie.
- Retirez les masses de la batterie pendant l'installation et la maintenance afin de réduire les risques de choc. Retirez la connexion de la masse si une partie de la batterie est déterminée pour être mise à la terre.



Lorsque vous changez les piles, installez le même numéro et le même type de piles ou de batteries.



Pour onduleur avec batterie interne:

- Les instructions doivent contenir suffisamment d'informations pour permettre le remplacement de la batterie par un fabricant et un numéro de catalogue appropriés.
- Les instructions de sécurité pour permettre l'accès au personnel de service doivent être indiquées dans le manuel d'installation/d'entretien.
- Si des batteries doivent être installées par le personnel de service, des instructions pour les interconnexions, y compris le couple aux bornes, doivent être fournies.



N'essayez pas de vous débarrasser des piles en les brûlant. Cela pourrait provoquer une explosion.



Ne pas ouvrir ou détruire les piles. L'électrolyte qui s'échappe peut causer des blessures à la peau et aux yeux. Cela peut être toxique.



Ne remplacez le fusible que par le même type et le même ampérage pour éviter les risques d'incendie.



Ne démontez pas le système UPS.



Cet équipement a été testé et déclaré conforme aux limites d'un appareil numérique de classe A, conformément à la partie 15 des règles de la FCC. Ces limites sont conçues pour fournir une protection raisonnable contre les interférences nuisibles lorsque l'équipement est utilisé dans un environnement commercial. Cet équipement génère, utilise et peut émettre de l'énergie radiofréquence et, s'il n'est pas installé et utilisé conformément au manuel d'instructions, peut causer des interférences nuisibles aux communications radio. L'utilisation de cet équipement dans une zone résidentielle est susceptible de provoquer des interférences nuisibles, auquel cas l'utilisateur devra corriger les interférences à ses propres frais.



Les changements ou modifications non expressément approuvés par la partie responsable de la conformité pourraient annuler l'autorité de l'utilisateur à utiliser l'équipement.



Ceci est un produit pour les applications commerciales et industrielles. Dans les installations du deuxième environnement, des restrictions ou des mesures supplémentaires peuvent être nécessaires pour éviter les perturbations.

1. Installation and Setup

NOTE: Before installation, please inspect the unit. Be sure that nothing inside the package is damaged. Please keep the original package in a safe place for future use.

Unpacking and Inspection

Unpack your products and inspect the contents. The contents should include the following supplied components and hardware.

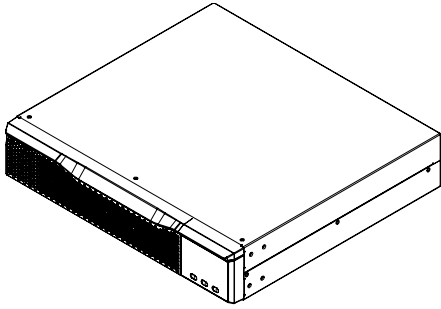

1-3KVA
UPS Unit



User Manual

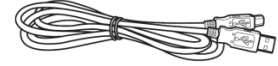

USB Cable

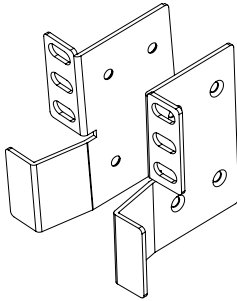

(2x) UPS Mounting Brackets

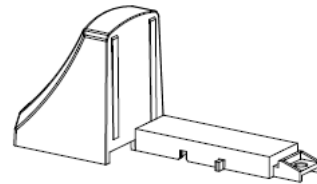

(4x) Foot

NOTE:

- Rail Slider is provided. For more information, refer to the 2U Rackmount Rail Slider instruction sheet (I-00888.pdf).

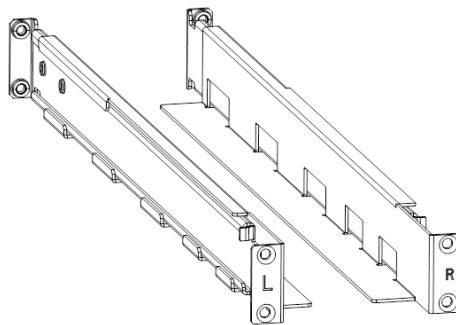

- Before installation, inspect all supplied components and hardware to ensure nothing was damaged during transportation. If you notice any damaged or missing parts, do not turn on the unit and notify the carrier and utilize the support reference number provided on your unit. Please keep the original package in a safe place for future use.

Rear Panel

1K and 1.5K Models

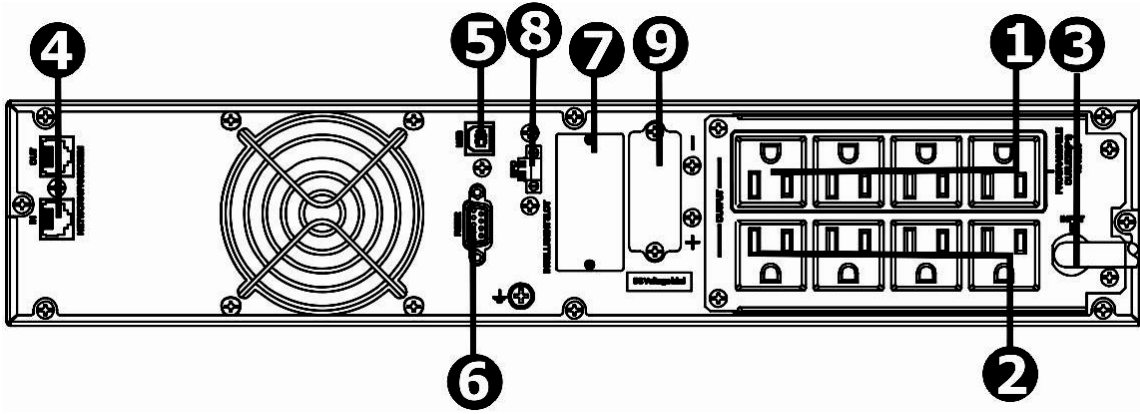

2K Models

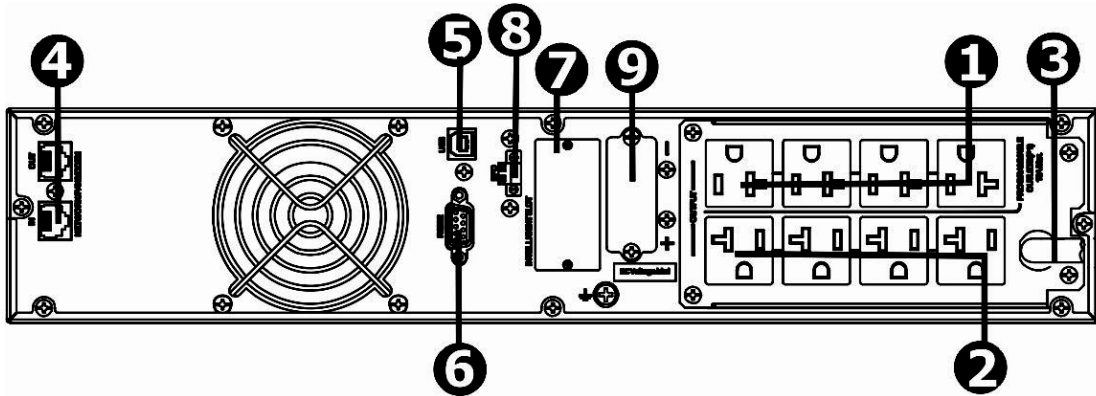

3K Models

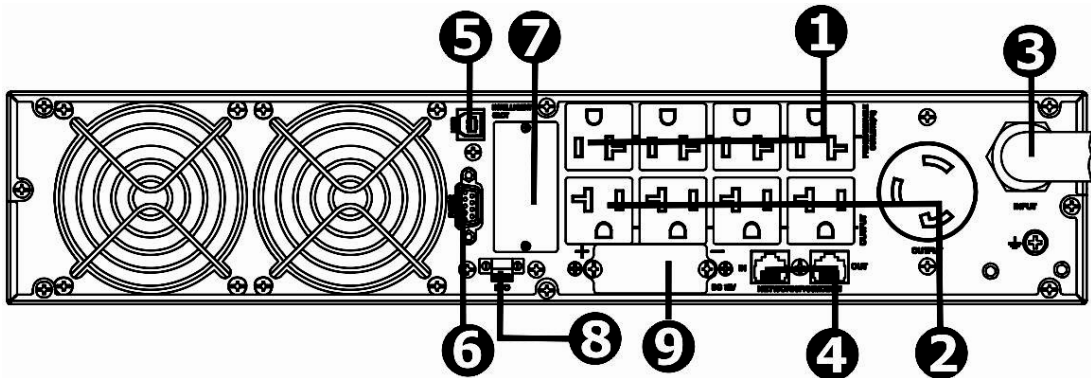

Label Descriptions:

1. Programmable Outlets: Connect to non-critical loads.
2. Output Receptacles: Connect to critical loads.
3. AC Input
4. Network/Fax/Modem Surge Protection
5. USB Communication Port
6. RS-232 Communication Port
7. SNMP Intelligent Slot
8. EPO (Emergency Power Off) Function Connector
9. External Battery Connection

Operating Principle

The operating principle of the UPS is shown as follows:

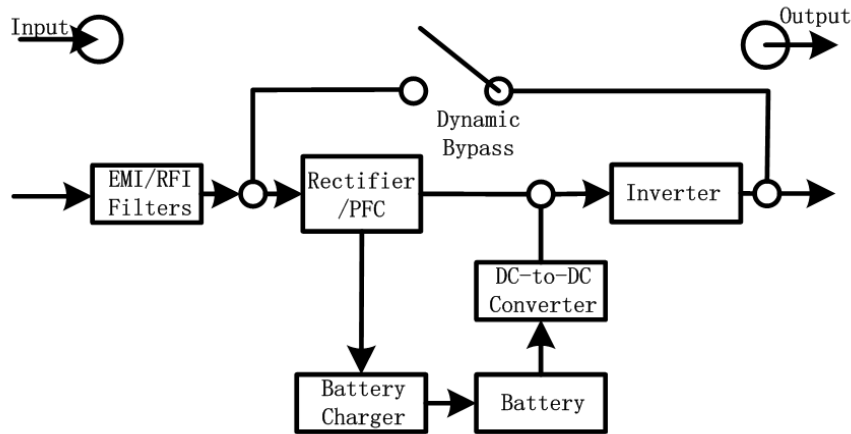

The UPS is composed of a mains input, EMI/RFI filters, rectifier/PFC, inverter, battery charger, DC-to-DC converter, battery, dynamic bypass and UPS output.

Installing the UPS

For safety considerations, the UPS ships from the factory without the battery wires connected. Before installing the UPS, please use the following steps to first re-connect the battery wires.

Step 1: Remove the front panel.

Step 2: Connect the AC input and re-connect the battery wires.

Step 3: Put the front panel back on the unit.

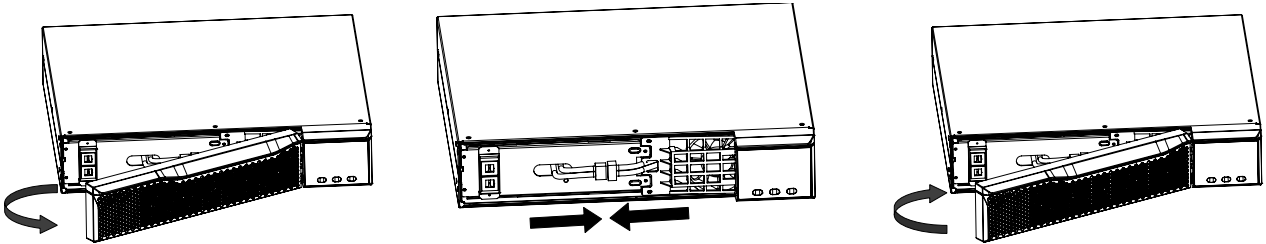

This UPS can be either placed on a surface or mounted in a 19" rack chassis.

Rackmount Installation



CAUTION: Do not use the mounting brackets to lift the unit. Use the mounting brackets only for securing the unit to the rack.



ATTENTION: N'utilisez pas les supports de montage pour soulever l'appareil. Utilisez les supports de montage uniquement pour fixer l'unité au rack.

NOTE: Rail Slider is provided. For more information, refer to the 2U Rackmount Rail Slider instruction sheet (I-00888.pdf).

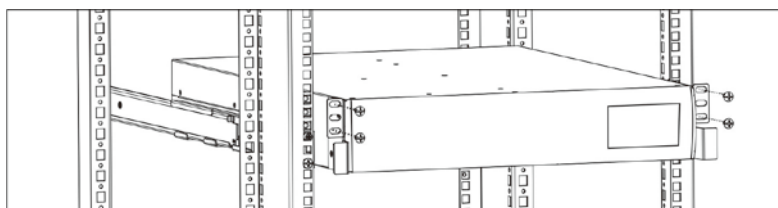

Use the following steps to mount your UPS system into a 19" rack.

Step 1

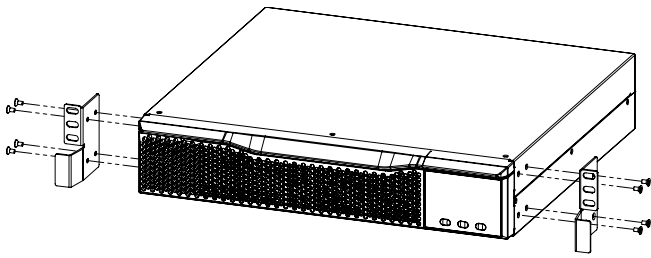

Step 2

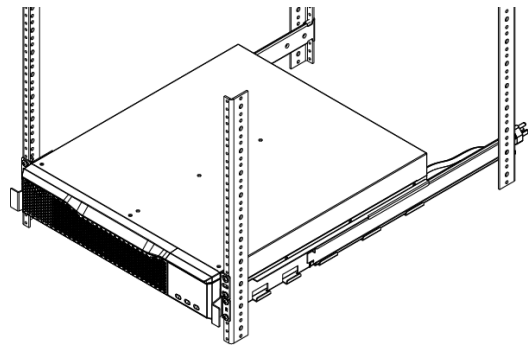

Tower Installation

Step 1

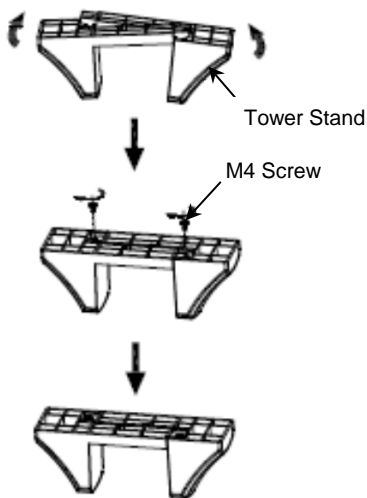

Step 2

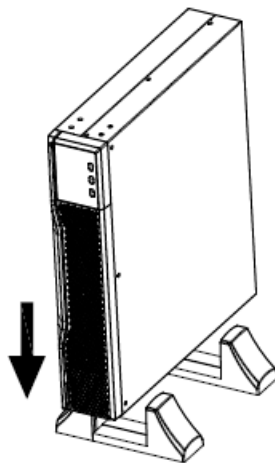

Step 3

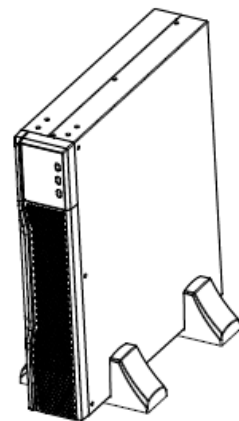

NOTE: When using feet for tower installations of the UPS or battery pack, ensure a 2.76" (70mm) distance from the edge of the unit to the feet as follows.

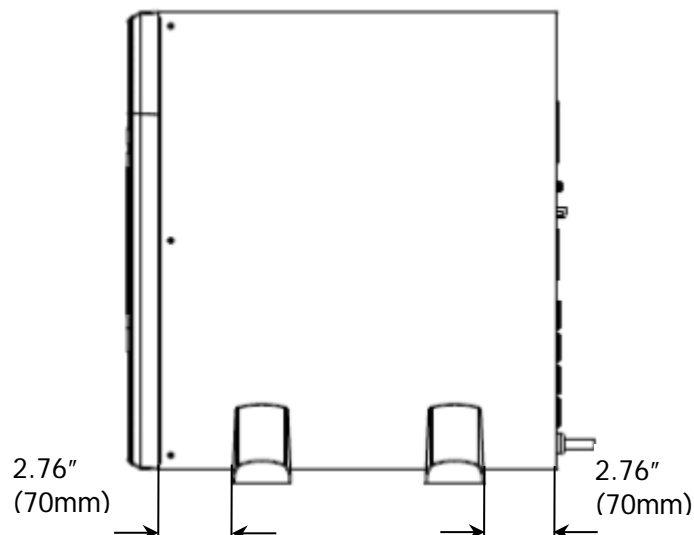

Setting Up the UPS

Before installing the UPS, please read the following to select the proper location.

1. The UPS should be placed on a flat, clean surface. Place it in an area away from vibration, dust, humidity, high temperature, flammable liquids, gases, corrosive, and conductive contaminants. Install

the UPS indoors in a clean environment, where it is away from windows and doors. Maintain a minimum clearance of 3.94 in. (100mm) on the bottom of the UPS to avoid dust and high temperatures.

2. Maintain an ambient temperature range of 32°F (0°C) to 113°F (45°C) for optimal UPS operation. For every 41°F (5°C) above 113°F (45°C), the UPS will derate 12% of nominal capacity at full load. The highest working temperature requirement for operation is 122°F (50°C).
3. It is required to maintain a maximum altitude of 1093.61yd. (1000m) to keep the UPS within normal operation at full load. If used in high altitudes, please reduce the connected load. Altitude derating power with connected loads for UPS normal operation is listed as follows:

Altitude (Feet and Meters)		Derating Factor
3280.84	1000	1.0
4921.26	1500	0.95
6561.68	2000	0.91
8202.1	2500	0.86
9842.52	3000	0.82
11482.94	3500	0.78
13123.36	4000	0.74
14763.78	4500	0.7
16404.2	5000	0.67

NOTE: Based on density of dry air = 1.225 kg/m³ at sea level, + 59°F (15°C).

4. UPS Placement

Your UPS is equipped with a fan for cooling. Therefore, place the UPS in a well-ventilated area. It's required to maintain minimum clearance of 4" (100mm) in the front of the UPS, and 12" (300mm) at the back and two sides of the UPS, for heat dissipation and easy-maintenance.

UPS Input Connection



CAUTION: Plug the UPS into a two-pole, three-wire, grounded receptacle only. Avoid using extension cords.



ATTENTION: Branchez l'onduleur dans une prise bipolaire, trois fils et mise à la terre uniquement. Évitez d'utiliser des rallonges.

- The power cable is attached to the UPS. The input plug is a NEMA 5-15P for 1K and 1.5K models, NEMA 5-20P for 2K model and NEMA 5-30P for 3K model.

NOTE: Check if the site wiring fault indicator lights up on the LCD panel. It will be illuminated when the UPS is plugged into an improperly wired utility power outlet. For more information, see "Troubleshooting" on page 31. Please also check if there is a circuit breaker against overcurrent and short circuit between the mains and AC input of the UPS for safe operation. The recommended protection values are as follows:

- 15A for the 1K and 1.5K models
- 20A for 2K model
- 30A for 3K model

UPS Output Connections

There two kinds of outputs: programmable outlets and general outlets. Please connect non-critical devices to the programmable outlets and critical devices to the general outlets. During a power failure, you may extend the backup time to critical devices by setting a shorter backup time for non-critical devices.

Communication Connection

Communication Ports:

USB Port



RS-232 Port

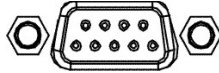

Intelligent Slot



To allow for unattended UPS shut down, start, and status monitoring, connect one end of the communication cable to the USB/RS-232 port and the other end to the communication port on your PC. With the monitoring software installed, you can schedule your UPS to shut down or start, and monitor your UPS status from your PC.

The UPS is equipped with an intelligent slot for attaching either an SNMP card. When installing either card in the UPS, it will provide advanced communication and monitoring options.

Making Network Connections

Network, Phone, or Fax Surge Ports



Connect a single modem, phone, or fax line into the surge-protected "IN" outlet on the back panel of the UPS unit. Connect from the "OUT" outlet to your equipment with another modem, phone, or fax line cable.

Disabling and Enabling the EPO Function

The UPS is equipped with an EPO (emergency power off) function. By default, the UPS is delivered from the factory with a metal plate connecting Pin 1 and Pin2, which disables the EPO function. To activate the EPO function, loosen the two screws and remove metal plate from the EPO port.

NOTE: The EPO function's logic is set up via LCD settings. For more information, see Program 16 in "UPS Settings," on page 23.

Optional Expandable Battery Connection

Connect one end of the external battery cable into your UPS and the other end into the battery box. Use the following illustration to connect your expandable battery.



CAUTION: External battery connections must only be performed by qualified service technicians.



ATTENTION: Les connexions de batterie externes doivent uniquement être effectuées par des techniciens de maintenance qualifiés.

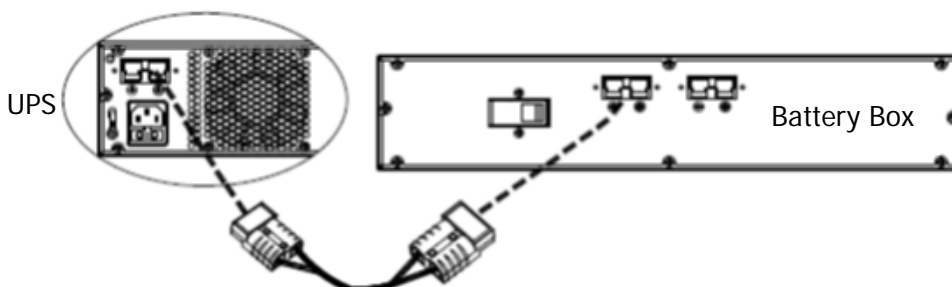

NOTE: For more information, refer to the Expandable Battery Box User Manual (I-00890.pdf).

Turning on the UPS

Press the ON/Mute button on the front panel for two seconds to power on your UPS.

NOTE: The battery charges fully during the first five hours of normal operation. Do not expect full battery operation capability during this initial charge period.

Installing the UPS Monitoring Software

For optimal computer system protection, install the UPS monitoring software to fully configure your UPS shutdown procedure. Then, use the following steps to install the UPS monitoring software.

1. Download the UPS monitoring software from www.legrand.us/upsdownloads and then follow the on-screen instructions.
2. When your computer restarts, the monitoring software will appear as an orange plug icon located in the system tray, near the clock.

Battery Replacement

NOTE: This UPS is equipped with internal batteries and user can replace the batteries without shutting down the UPS or connected loads (a hot-swappable battery design). Replacement is a safe procedure, isolated from electrical hazards.



CAUTION: Consider all warnings, cautions, and notes before replacing batteries.



ATTENTION: Tenez compte de tous les avertissements, mises en garde et remarques avant de remplacer les piles.

NOTE: After disconnecting the battery, your connected equipment is not protected from power outages.

Step 1: Remove the front panel.

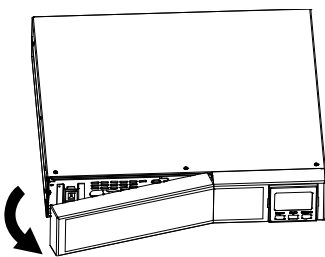

Step 2: Disconnect the battery wires.

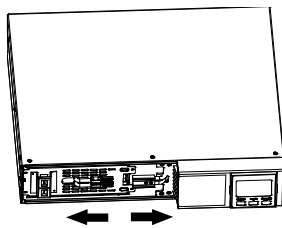

Step 3: Pull out the battery box by removing the two screws on the front panel.

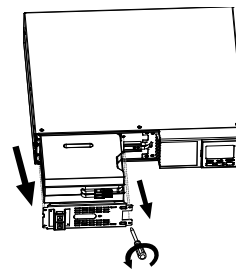

Step 4: Remove the top cover of the battery box and replace the batteries inside.

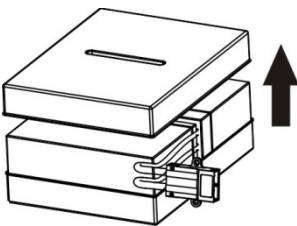

Step 5: After replacing the batteries, put the battery box back in the original location and replace the two screws.

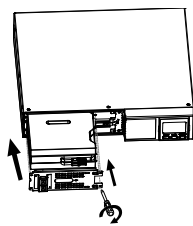

Step 6: Re-connect the battery wires.

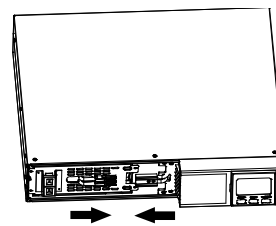

Step 7: Put the front panel back on the unit.

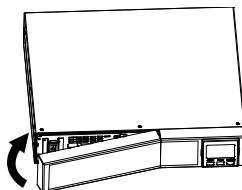

Replacement Battery Assembly

NOTE: Assemble the battery kit first before installing it inside of your UPS. Select from the following battery kit procedures for proper assembly.

2 Cell Battery Kit

Step 1: Thoroughly remove old adhesive tape and install new tape in the following locations.

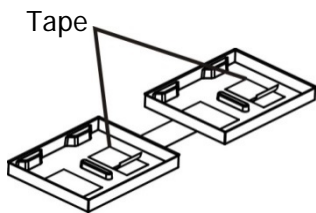

Step 2: Connect all battery terminals as shown.

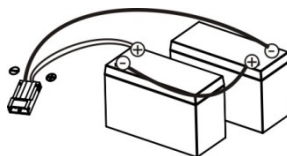

Step 3: Place the connected battery packs on adhesive strips on one side of the plastic shells.

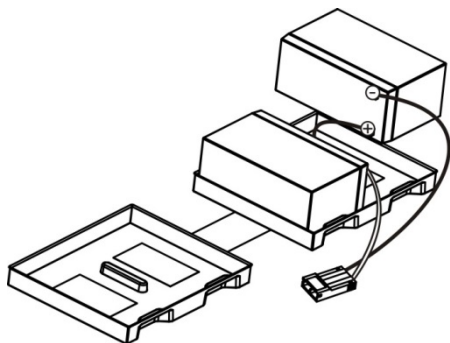

Step 4: Cover the other side of the plastic shell as shown.

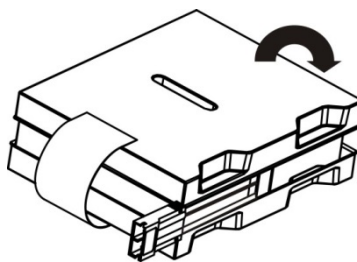

3 Cell Battery Kit

Step 1: Thoroughly remove old adhesive tape and install new tape in the following locations.

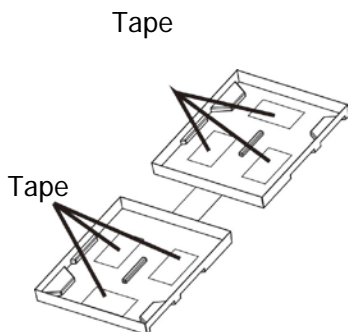

Step 2: Connect all battery terminals as shown.

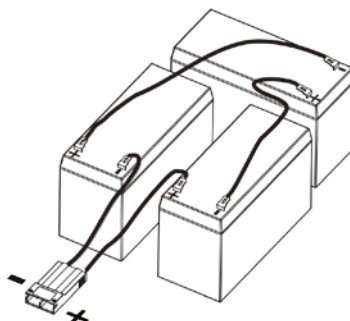

Step 3: Place the assembled battery packs on adhesive strips on one side of the plastic shells.

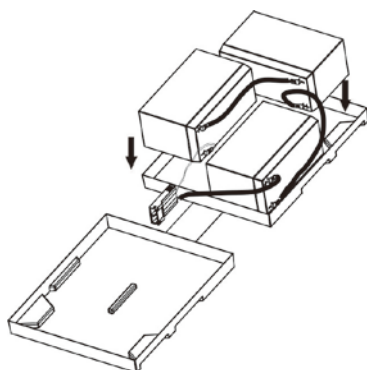

Step 4: Cover the other side of the plastic shell as shown.

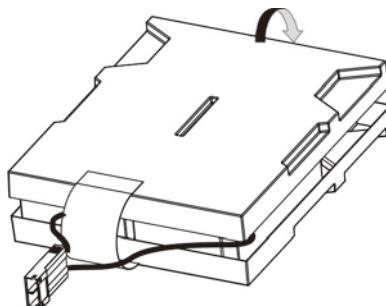

4 Cell Battery Kit

Step 1: Thoroughly remove old adhesive tape and install new tape in the following locations.

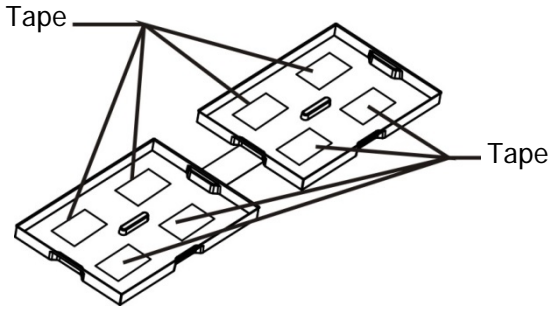

Step 2: Connect all battery terminals as shown.

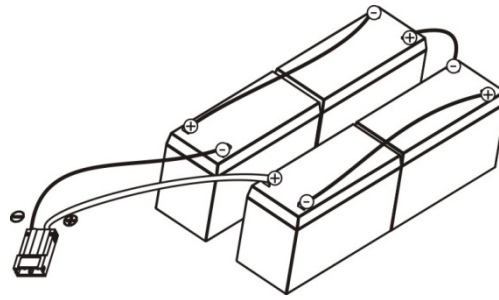

Step 3: Place the assembled battery packs on adhesive strips on one side of the plastic shells.

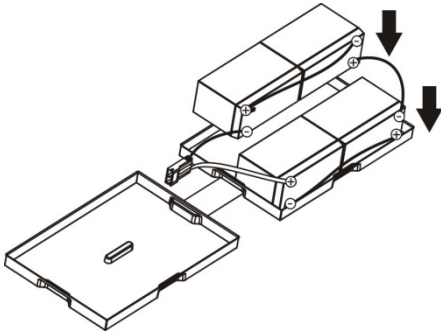

Step 4: Cover the other side of the plastic shell as shown.

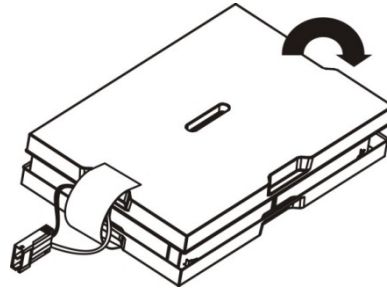

6 Cell Battery Kit

Step 1: Thoroughly remove old adhesive tape and install new tape in the following locations.

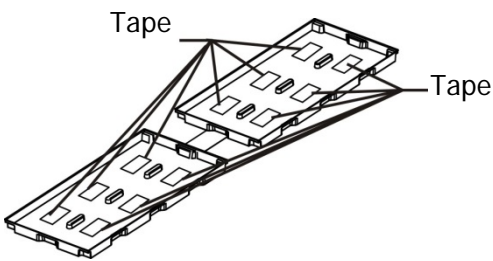

Step 2: Connect all battery terminals as shown.

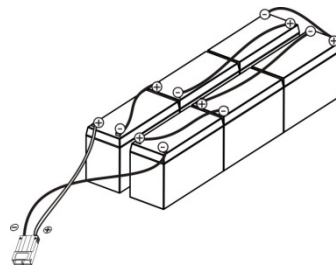

Step 3: Place the assembled battery packs on adhesive strips on one side of the plastic shells.

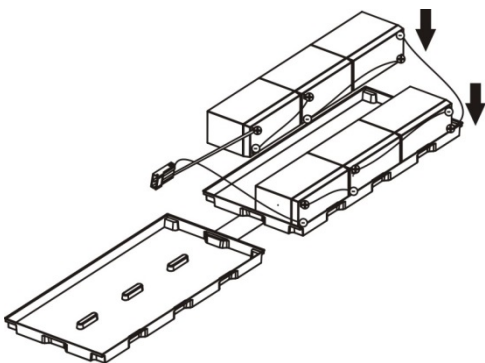



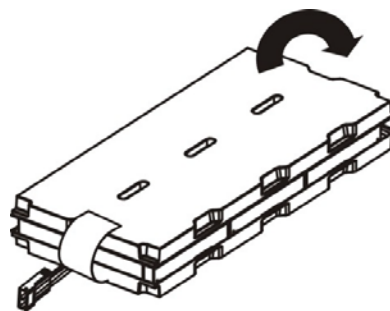



Step 4: Cover the other side of the plastic shell as shown.

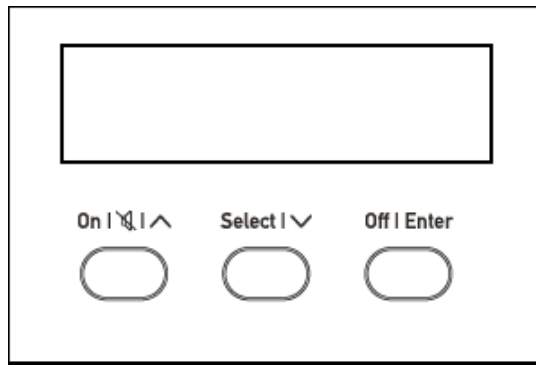

2. Operations

Button Operations



Button	Function
<p data-bbox="197 707 320 741">On Mute ^</p> 	<ul data-bbox="384 566 1461 976" style="list-style-type: none"> • Turn on the UPS: Press and hold this button for at least 2 seconds to turn on the UPS. • Mute the alarm: While the UPS is turned on and in battery mode, press and hold this button for at least 3 seconds to disable or enable the alarm system. This function is overridden by warning or error alerts. • Up key: Press this button to display the previous selection when in the UPS settings mode. • Switch to UPS self-test mode: While in AC mode, ECO (efficiency corrective optimizer) mode, or converter mode, press this button for 3 seconds.
<p data-bbox="197 1043 316 1077">Off Enter</p> 	<ul data-bbox="384 999 1461 1211" style="list-style-type: none"> • Turn off the UPS: Press and hold this button at least 2 seconds to turn off the UPS. This puts the UPS in standby mode under normal power. If bypass is enabled, this function will transfer the unit into bypass mode. • Confirm selection key: Press this button to confirm your selection while in the UPS settings mode.
<p data-bbox="197 1357 320 1391">Select v</p> 	<ul data-bbox="384 1243 1461 1599" style="list-style-type: none"> • Switch LCD Parameter 1 message: Press this button to change the LCD message from input voltage, input frequency, input current, battery voltage, battery current, battery capacity, ambient temperature, output voltage, output frequency, load current, and load percent choices. • Settings mode: When in Standby or Bypass mode, press and hold this button for 3 seconds to enter the UPS settings mode. • Down key: Press this button to display the next selection when in the UPS settings mode.
<p data-bbox="197 1644 320 1677">On Mute ^</p>  <p data-bbox="197 1778 320 1812">+ Select v</p> 	<ul data-bbox="384 1626 1461 1935" style="list-style-type: none"> • Switch to bypass mode: When the main power is normal, press and hold both of these buttons simultaneously for 3 seconds. The UPS then enters bypass mode. This action does not work when the input voltage is out of an acceptable range. • Exit settings mode or return to the upper menu: When working in settings mode, press and hold both of these buttons simultaneously for 0.2 seconds to return to the previous menu. If you are already in the top menu, press these two buttons at the same time to exit the settings mode.

LCD Panel

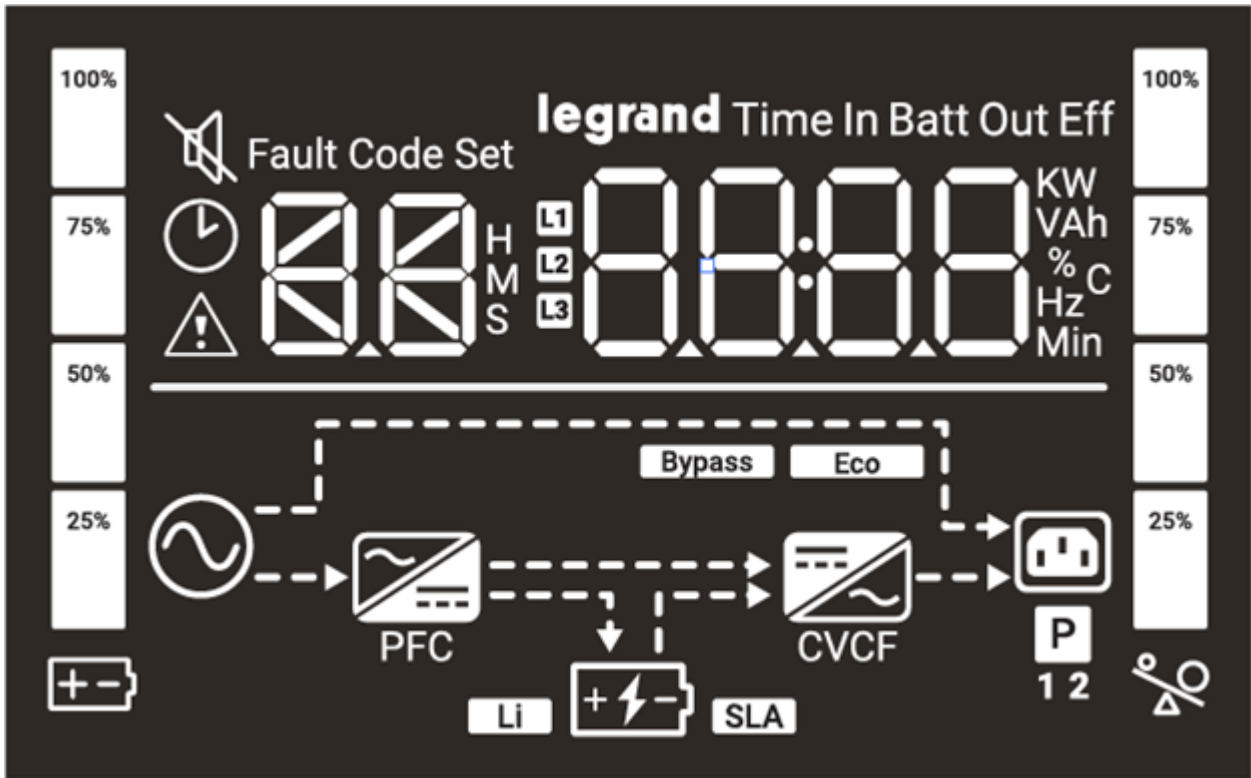

Backup Time Information

Display	Function
	Indicates the backup time.
	Indicates the estimated backup time. H: hours, M: minute

Warning and Fault Information

Display	Function
	Indicates that the a warning and/or fault has occurred.
	Indicates the warning and fault codes. For more information, see "Fault Reference Codes," on page 29 and "Warning Indicators," on page 30.



Setting Operation

Display	Function
	Indicates the selected UPS setting program. For more information, see "UPS Settings" on page 23.







Input, Battery, Temperature, Output, and Load Information

Display	Function
	Indicates the input voltage, input frequency, input current, battery voltage, battery current, battery capacity, ambient temperature, output voltage, output frequency, load current, and load percent. k: kilo, W: watt, V: voltage, A: ampere, %: percent, °C: centigrade degree, Hz: frequency



Load Information

Display	Function
	Indicates the load level by 0-24%, 25-49%, 50-74%, and 75-100%.
	Indicates an overload has occurred.

UPS Status

Display	Function
	Indicates the UPS connects to the mains.
	Indicates the battery is working.
	Indicates the AC to DC circuit is working.
	Indicates the inverter circuit is working.
	Indicates the output is working.
P	Indicates that programmable outlets are working.
BYPASS	Indicates the bypass circuit is working.
ECO	Indicates the ECO (efficiency corrective optimizer) mode is enabled.
PFC	Indicates the PFC circuit is working.
CVCF	Indicates the UPS is working in converter mode.
	Indicates the battery charger is working.
	Indicates the UPS alarm is disabled.

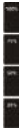
Battery Information

Display	Function
	Indicates the battery level by 0-24%, 25-49%, 50-74%, and 75-100%.
	Indicates the battery life is low.



Audible Alarms

Reason	Sound
Battery Mode	Sounding every 5 seconds
Low Battery	Sounding every 2 seconds
Overload	Sounding every second
Fault	Continuously sounding
Bypass Mode	Sounding every 10 seconds

LCD Panel Index

Abbreviation	Display Content	Meaning
ENA	ENR	Enable
DIS	di S	Disable
ESC	ESC	Escape
HLS	HLS	High loss
LLS	LLS	Low loss
AO	AO	Active open
AC	AC	Active close
EAT	EAt	Estimated autonomy time
RAT	rAt	Running autonomy time
AUT / AON	AUt , AON	Automatic / Always on
SD	Sd	Shutdown
OK	OK	OK
ON	ON	ON
OI	OI	Over input current
EP	EP	EPO
TP	tP	Temperature
CH	CH	Charger
BF	bF	Battery Fault
FU	FU	Bypass frequency unstable
BR	bR	Battery Replace
EE	EE	EEPROM error

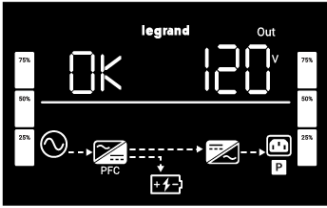
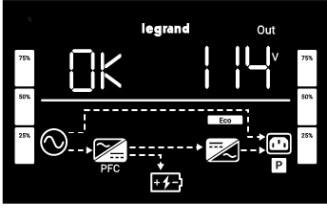
Operating Mode Descriptions

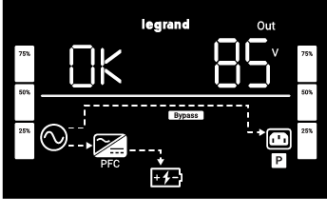
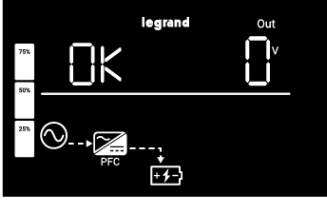
Operating Mode	Description	LCD Panel
Online Mode	<p>When the input voltage is within an acceptable range, the UPS provides pure and stable AC power to the output. The UPS also charges the battery in online mode.</p>	
ECO (Efficiency Corrective Optimizer) Mode	<p>Energy saving mode: When the input voltage is within voltage regulation range, the UPS bypasses voltage to the output to save energy. The UPS also charges the battery in ECO mode.</p>	
Frequency Converter Mode	<p>When the input frequency is within 40 to 70 Hz, the UPS can be set at a constant output frequency of 50 Hz or 60 Hz. The UPS charges the battery when in this mode.</p> <p>NOTE: Frequency converter mode is not functional when the unit is in bypass mode.</p>	
Battery Mode	<p>When the input voltage is beyond the acceptable range or a power failure has occurred, the UPS will backup power from the battery and the alarm sounds every 5 seconds.</p>	
Bypass Mode	<p>When the input voltage is within an acceptable range, but the UPS is overloaded, the UPS enters bypass mode (or bypass mode can be set from the front panel). The alarm sounds every 10 seconds.</p>	
Standby Mode	<p>The UPS is powered off and no outputs are supplied with power. However, the UPS still charges the battery when in this mode.</p>	

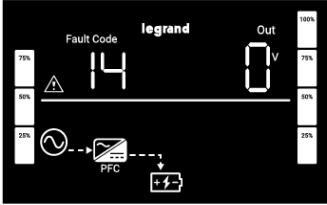
Operating Mode	Description	LCD Panel
Fault Mode	When a fault has occurred, the fault code appears.	

UPS Settings

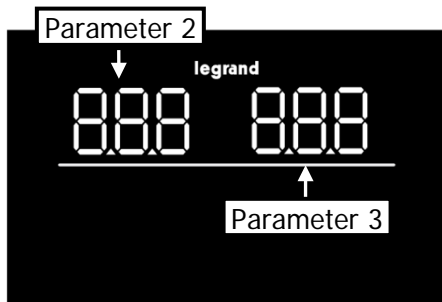
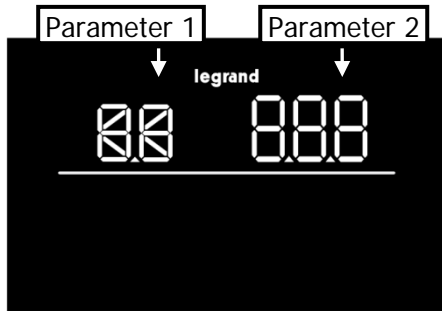

There are three parameters used for setting up your UPS.

Parameter 1 is for selecting available programs for your UPS system. See the remainder of this topic for program details.

Parameter 2 is the setting options or values for each program.

If another level of attenuation is available from Parameter 2, the screen changes to show Parameter 2 and Parameter 3 as shown.

NOTE:

The following tables refer to these parameters as Interface (Parameter 1) and Setting (Parameter 2) or (Parameter 3), respectively.

Enter Settings mode before performing the following configurations. To enter the UPS settings mode, your UPS needs to be in either Standby or Bypass mode while you press and hold the Select button for 3 seconds. For more information, see "Button Operations" on page 18.

01: Output Voltage Setting

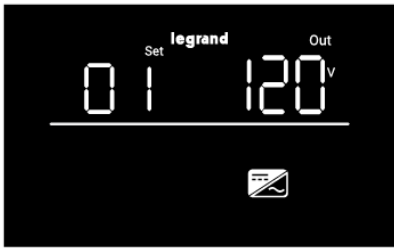
Interface	Setting
	<p>For 100/110/115/120/127 Vac models, you may choose the following output voltage:</p> <p>100: The output voltage is 100Vac</p> <p>110: The output voltage is 110Vac</p> <p>115: The output voltage is 115Vac</p> <p>120: The output voltage is 120Vac (Default)</p> <p>127: The output voltage is 127Vac</p>

02: Frequency Converter (Enable/Disable)

Interface	Setting
	<p>Enable or disable converter mode.</p> <p>CF ENA: The converter mode is enabled</p> <p>CF DIS: The converter mode is disabled (Default)</p> <p>NOTE: Frequency converter mode is not functional when the unit is in bypass mode.</p>

03: Output Frequency Setting

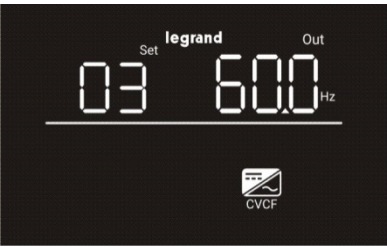
Interface	Setting
	<p>You may set the initial frequency going to the outlets when the UPS is in battery mode:</p> <p>BAT 50: The output frequency is 50Hz</p> <p>BAT 60: The output frequency is 60Hz</p> <p>If converter mode is enabled, you may select the following output frequencies:</p> <p>CF 50: The output frequency is 50Hz</p> <p>CF 60: The output frequency is 60Hz</p>

04: ECO Mode (Enable/Disable)

Interface	Setting
	<p>Enable or disable the ECO (efficiency corrective optimizer) function.</p> <p>ENA: The ECO mode is enabled</p> <p>DIS: The ECO mode is disabled (Default)</p>

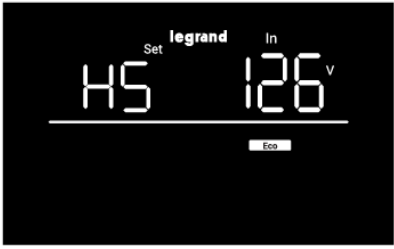

05: ECO Voltage Range Setting

Interface	Setting
 	<p>Set the acceptable high and low voltage points for ECO (efficiency corrective optimizer) mode by pressing the Down or Up key.</p> <p>HLS: High loss voltage in ECO mode in parameter 2. For 100/110/115/120/127 Vac models, the setting range in parameter 3 is from +3V to +12V of the nominal voltage. (Default: +6V)</p> <p>LLS: Low loss voltage in ECO mode in parameter 2. For 100/110/115/120/127 Vac models, the setting voltage in parameter 3 is from -3V to -12V of the nominal voltage. (Default: -6V)</p>

06: Bypass Enable/Disable When UPS is Off

Interface	Setting
	<p>Enable or disable the Bypass function.</p> <p>ENA: The Bypass is enabled DIS: The Bypass is disabled (Default)</p>

07: Bypass Voltage Range Setting

Interface	Setting
 	<p>Set the acceptable high and low voltage points for Bypass mode by pressing the Down or Up key.</p> <p>HLS: Bypass high voltage point For 100/110/115/120/127 Vac models: 120-140: Set the high voltage point in parameter 3 from 120Vac to 140Vac. (Default: 132Vac)</p> <p>LLS: Bypass low voltage point For 100/110/115/120/127 Vac models: 85-115: Set the low voltage point in parameter 3 from 85Vac to 115Vac. (Default: 85Vac)</p>

08: Bypass Frequency Range Setting

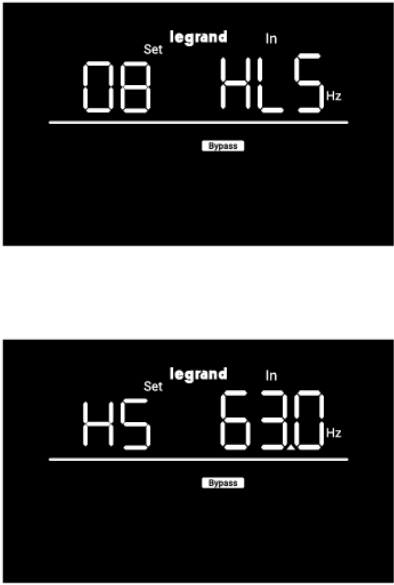
Interface	Setting
	<p>Set the acceptable high and low frequency points for Bypass mode by pressing the Down or Up key.</p> <p>HLS: Bypass high frequency point</p> <p>For 50Hz output frequency models: 51-55Hz: Set the frequency high loss point from 51Hz to 55Hz (Default: 53.0Hz)</p> <p>For 60Hz output frequency models: 61-65Hz: Set the frequency high loss point from 61Hz to 65Hz (Default: 63.0Hz)</p> <p>LLS: Bypass low Frequency point</p> <p>For 50Hz output frequency models: 45-49Hz: Set the frequency low loss point from 45Hz to 49Hz (Default: 47.0Hz)</p> <p>For 60Hz output frequency models: 55-59Hz: Set the frequency low loss point from 55Hz to 59Hz (Default: 57.0Hz)</p>

09: Programmable Outlets (Enable/Disable)

Interface	Setting
	<p>Enable or disable programmable outlets.</p> <p>ENA: Programmable outlets enabled</p> <p>DIS: Programmable outlets disabled (Default)</p>

10: Programmable Outlets Setting

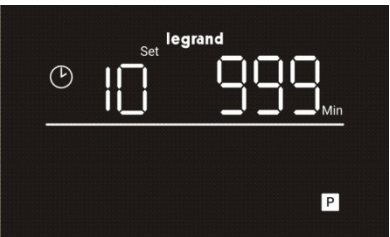
Interface	Setting
	<p>Set up backup time limits for all programmable outlets.</p> <p>0-999: Set the backup time limits in minutes from 0-999 for programmable outlets which connect to non-critical devices in battery mode. (Default: 999)</p>

11: Autonomy Limitation Setting

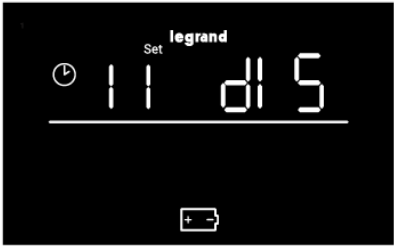
Interface	Setting
	<p>Set the backup time in battery mode for the general outlets.</p> <p>0-999: Set the backup time in minutes from 0-999 for general outlets in battery mode.</p> <p>DIS: Disable the autonomy limitation and the backup time. This depends on the battery capacity. (Default)</p> <p>NOTE:</p> <ul style="list-style-type: none"> • When enabled, if the set time duration is less than the programmable outlet setting, it overrides the latter. • When set as "0", the backup time will be only 10 seconds.

12: Battery Total Ah Setting

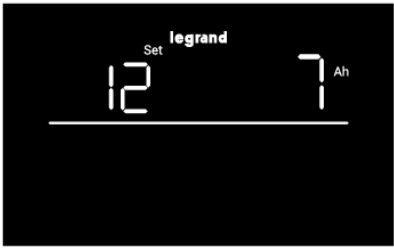
Interface	Setting
	<p>Set up the battery total Ah of the UPS.</p> <p>7-200: Set the battery total capacity from 7-200 in Ah.</p> <p>NOTE: Be sure to set the correct total capacity of the battery, including the external battery bank, if used.</p>

13: Site Fault Detection (Enable/Disable)

Interface	Setting
	<p>Enable or disable Site fault detection.</p> <p>ENA: Site fault detection is enabled (Default)</p> <p>DIS: Site fault detection is disabled</p>

14: Charger Boost Voltage Setting

Interface	Setting
	<p>Set up the chargers boost voltage.</p> <p>2.25-2.40: Set the charger boost voltage from 2.25 V/cell to 2.40V/cell. (Default: 2.36V/cell)</p>

15: Charger Float Voltage Setting

Interface	Setting
	<p>Set the charger float voltage.</p> <p>2.20-2.33: Set the charger float voltage from 2.20 V/cell to 2.33V/cell. (Default: 2.28V/cell)</p>

16: EPO Logic Setting

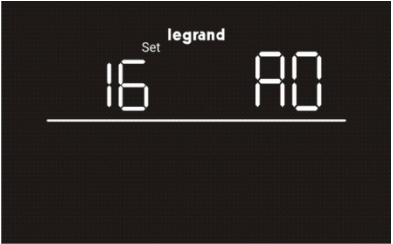
Interface	Setting
	<p>Set up the EPO (Emergency Power Off) function control logic.</p> <p>AO: Active Open (Default). When AO is selected as the EPO logic, it will activate the EPO function with Pin 1 and Pin 2 in the open status.</p> <p>AC: Active Close. When AC is selected as the EPO logic, it will activate the EPO function with Pin 1 and Pin 2 in the closed status.</p>

17: LCD Backlight Setting

Interface	Setting
	<p>Set up the working mode for the LCD display backlight.</p> <p>Aon: LCD display backlight is on all the time. (Default)</p> <p>Aut: LCD display backlight will be off after pressing the buttons 60seconds.</p>

18: Display Setting for Autonomy Time

Interface	Setting
	<p>Set up the display setting for autonomy time.</p> <p>EAT: If EAT is selected, the remaining autonomy time is shown. (Default)</p> <p>RAT: If RAT is selected, the accumulated autonomy time is shown.</p>

19: Acceptable Input Voltage Range Setting

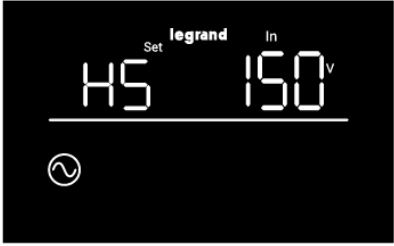
Interface	Setting
 	<p>Set the acceptable high and low voltage point for the input voltage range by pressing the Down or Up key.</p> <p>HLS: Input high voltage point For 100/110/115/120/127 Vac models: 140/145/150: Set the high voltage point in parameter 2. (Default: 150Vac)</p> <p>LLS: Bypass low voltage point For 100/110/115/120/127 Vac models: 55/60/65/70/75/80: Set the low voltage point in parameter 2. (Default: 55Vac)</p>













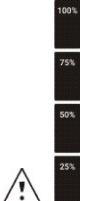

00: Exit Settings

Interface	Setting
	<p>Exit the settings mode.</p>

Fault Reference Codes









Fault Event	Fault Code	Icon	Fault Event	Fault Code	Icon
Bus start fail	01	None	Battery voltage too high	27	None
Bus over	02	None	Battery voltage too low	28	None
Bus under	03	None	Charger output short	2A	None
Inverter soft start fail	11	None	Over temperature	41	None
Inverter voltage high	12	None	Overload	43	
Inverter voltage Low	13	None	Charger failure	45	None
Inverter output short	14	None	Over input current	49	None

Warning Indicators

Warning	Icon (Flashing)	Alarm
Low Battery		Sounding every 2 seconds
Overload		Sounding every second
Over Input Current		Sounding 2 beeps every 10 seconds
Battery Disconnected		Sounding every 2 seconds
Overcharge		Sounding every 2 seconds
Site Wiring Fault		Sounding every 2 seconds
EPO (Emergency Power Off) Enabled		Sounding every 2 seconds
Over Temperature		Sounding every 2 seconds
Charger Failure		Sounding every 2 seconds
Battery Fault		Sounding every 2 seconds (At this time, UPS is off to remind users something wrong with battery)
Out of Bypass Voltage Range		Sounding every 2 seconds
Bypass Frequency Unstable		Sounding every 2 seconds
Battery Replacement		Sounding every 2 seconds
EEPROM error		Sounding every 2 seconds

3. Troubleshooting

If the UPS system does not operate correctly, please solve the problem by using the table below.

Issue	Possible Cause	Solution
No indication showing on LED or alarm sounding that there's power coming into the unit.	The AC input power is not correctly connected.	Check if the input power cable is firmly connected to the mains.
	The AC input is connected to the UPS output.	Plug the AC input power cable to the AC input.
The icon  and the warning code  are flashing on the LCD screen, and the alarm is sounding every 2 seconds.	The EPO function is activated.	Set the circuit in the closed position to disable the EPO function. For more information, see page 12.
The icon  and  are flashing on the LCD screen, and the alarm is sounding every 2 seconds.	The line and neutral conductors are reversed on the UPS input.	Rotate the mains power socket 180°, and then connect it to the UPS system.
The icon  and  are flashing on the LCD screen, and the alarm is sounding every 2 seconds.	The external or internal battery is connected incorrectly.	Check if all batteries are connected properly.
Fault code is shown as 27 and the alarm is continuously sounding.	Battery voltage is too high or the charger is fault.	Contact your dealer.
Fault code is shown as 28 and the alarm is continuously sounding.	Battery voltage is too low or the charger is faulty.	Contact your dealer.
The icon  and  are flashing on the LCD screen, and the alarm is sounding every second.	The UPS is overloaded.	Remove excess loads from the UPS output.
	The UPS is overloaded. Devices connected to the UPS are fed directly by the electrical network via the Bypass.	Remove excess loads from the UPS output.
	After repetitive overloads, the UPS is locked in the Bypass mode. Connected devices are fed directly by the mains.	First, remove excess loads from the UPS output, and then restart the UPS.
Fault code is shown as 49 on the LCD panel and the alarm is continuously sounding.	UPS is overloaded.	Remove excess loads from the UPS output.
Fault code is shown as 43 and the icon  is flashing on the LCD screen. The alarm is continuously sounding.	The UPS automatically shut down because of an overload at the UPS output.	Remove excess loads from the UPS output and restart the UPS.
Fault code is shown as 14 and the alarm is continuously sounding.	The UPS automatically shut down because a short circuit occurred at the UPS output.	Check the output wiring and if any connected devices have short circuited.

Issue	Possible Cause	Solution
Fault code is shown as 01, 02, 03, 11, 12, 13 and 41 on the LCD screen and alarm is continuously sounding.	<p>A UPS internal fault has occurred. There are two possible results:</p> <ol style="list-style-type: none"> 1. The load is still supplied, but directly from AC power via bypass. 2. The load is no longer supplied by power. 	Contact your dealer
The battery backup time is shorter than the nominal value.	The batteries are not fully charged.	Charge the batteries for at least 5 hours, and then check capacity. If the problem still persists, consult your dealer.
	The batteries are defective.	Contact your dealer to replace the battery.
Fault code is shown as 2A on the LCD screen and the alarm is continuously sounding.	A short circuit occurred at the charger output.	Check if external battery pack is connected properly or has short circuited.
Fault code is shown as 45 on the LCD screen and the alarm is continuously sounding.	The charger does not have output and the battery voltage is less than 10V/PC.	Contact your dealer.

4. Maintenance and Storage

Maintenance

The UPS system contains no user-serviceable parts. If the battery service life (3–5 years at 77°F, 25°C ambient temperature) has been exceeded, the batteries must be replaced. Contact technical support.



Be sure to bring discharged batteries to a recycling facility or ship it to your dealer in the replacement battery packing material.

Storage

Before storing your UPS for long periods of time, charge the system for 5 hours. Store the UPS covered and upright in a cool, dry location. While in storage, recharge the battery as follows:

Storage Temperature	Recharge Frequency	Charging Duration
-13°F to 104°F (-25°C to 40°C)	Every 3 months	1-2 hours
104°F to 113°F (40°C to 45°C)	Every 2 months	1-2 hours

5. Specifications

NOTE:

- Derate capacity to 80% of capacity in frequency converter mode and to 80% when the output voltage is adjusted to 100Vac. For 100/110/115/120/127Vac system, the output power ratings are different based on different input voltage. Please check the output power rating for details.
- Product specifications are subject to change without notice.

Input

MODEL/CAPACITY		1000VA/1000W	1500VA/1500W	2000VA/2000W	3000VA / 3000W
Voltage Range	Low Line Transfer	80Vac/70Vac/60Vac/55Vac \pm 5 % (based on load percentage 100% - 80 % / 80 % - 70 % / 70 - 60 % / 60 % - 0)			
	Low Line Comeback	87Vac/77Vac/67Vac/62Vac \pm 5 %			
	High Line Transfer	150 Vac \pm 5 %			
	High Line Comeback	145 Vac \pm 5 %			
Frequency Range		40Hz ~ 70 Hz			
Phase		Single phase with ground			
Power Factor		\geq 0.99 @ full load			
THDi		\leq 5% @ 100~130Vac THDU < 1.6% @ input and full linear load condition			

Output

MODEL/CAPACITY		1000VA/1000W	1500VA/1500W	2000VA/2000W	3000VA / 3000W
Output voltage		100/110/115/120/127 Vac			
AC Voltage Regulation		\pm 1% (Battery Mode)			
Frequency Range (Synchronized Range)		47 ~ 53 Hz or 57 ~ 63 Hz			
Frequency Range		50 Hz \pm 0.1 Hz or 60Hz \pm 0.1 Hz (Battery Mode)			
Current Crest Ratio		3:1			
Harmonic Distortion		\leq 2 % THD (Linear Load) ; 4 % THD (Non-linear Load)			
Transfer Time	AC Mode to Battery Mode	Zero			
	Inverter to Bypass	< 4 ms			
Waveform (Battery Mode)		Pure Sinewave			

Efficiency

MODEL/CAPACITY		1000VA/1000W	1500VA/1500W	2000VA/2000W	3000VA / 3000W
AC Mode		\geq 89% @ full charged battery		\geq 91% @ full charged battery	
ECO (Efficiency Corrective Optimizer)		\geq 96% @ full charged battery			

MODEL/CAPACITY	1000VA/1000W	1500VA/1500W	2000VA/2000W	3000VA / 3000W
Mode				
Battery Mode	≥ 88%		≥ 90%	

Battery

MODEL/CAPACITY	1000VA/1000W	1500VA/1500W	2000VA/2000W	3000VA / 3000W
Battery Type	12V/9Ah	12V/9Ah	12V/9Ah	12V/9Ah
Numbers	2	3	4	6
Recharge Time	3 hours recover to 95% capacity for internal battery@ 2A charging current			
Charging Current	Default: 2A, Max: 8A auto-adjustable via battery AH setting			
Charging Voltage	27.4 Vdc ± 1%	41.0 Vdc ± 1%	54.7 Vdc ± 1%	82.1 Vdc ± 1%

Physical

MODEL/CAPACITY	1000VA/1000W	1500VA/1500W	2000VA/2000W	3000VA / 3000W
Dimension, D x W x H (inches)	16.1 x 17.2 x 3.5		20.1 x 17.2 x 3.5	24.8 x 17.2 x 3.5
Dimension, D x W x H (mm)	410 x 438 x 88		510 x 438 x 88	630 x 438 x 88
Net Weight (lbs)	With battery	25.7	34.2	43.0
	Without battery	14.5	17.9	20.7
Net Weight (kgs)	With battery	11.7	15.5	19.5
	Without battery	6.6	8.1	9.4

Environment

MODEL/CAPACITY	1000VA/1000W	1500VA/1500W	2000VA/2000W	3000VA / 3000W
Operation Humidity	20-95 % RH @ 32 – 104°F or 0 – 40°C (non-condensing)			
Acoustic Noise Level	Less than 50dBA @ 3.28 ft. or 1 Meter (With fan speed control)			

Management

MODEL/CAPACITY	1000VA/1000W	1500VA/1500W	2000VA/2000W	3000VA / 3000W
Smart RS-232 or USB	Supports Windows® 2000/2003/XP/Vista/2008/7/8/10, Linux, Unix and MAC			
Optional SNMP	Power management from SNMP manager and web browser			

Expandable Battery Box Specification

MODEL/CAPACITY	18Ah24V	18Ah36V	18Ah48V	18Ah72V
Used with UPS Models	1K 2B	1.5K 3B	2K 4B	3K 6B
Battery Type	12V 9Ah	12V 9Ah	12V 9Ah	12V 9Ah
Battery Numbers	4	6	8	12
Dimensions, D x W x H (inches)	16.1 x 17.2 x 3.5		20.1 x 17.2 x 3.5	24.8 x 17.2 x 3.5
Dimensions, D x W x H (mm)	410 x 438 x 88		510 x 438 x 88	630 x 438 x 88
Net Weight (lbs)	37.7	47.4	63.9	90.8
Net Weight (kgs)	17.1	21.5	29.0	41.2

NOTE: Battery pack should be used with corresponding UPS.