



zintrac[®]

CLOUDS
Technical Specifications

PM 8 31

PM 8 31

Zintrac Clouds Long Dome Convex in Fossil



The combination of straight edges and rounded curves in a 3 dimensional design, ensure Clouds are an attention grabbing addition to a space. Each one easily pressure fits together and hangs quickly to deliver an instant impact.

Zintra Clouds Turbine in Olive

zintra® .2

INSTALLATION IDEAS





Top image: Zintra Clouds Blanchard in Pewter, Tar and Sunshine
Bottom image: Zintra Clouds Giffard in Lime and Ecrú

TECHNICAL DRAWINGS

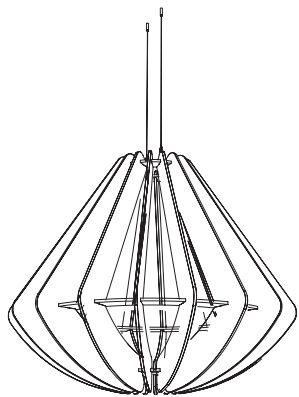

BLANCHARD

27.3" (694mm) dia x 23.5" (595mm) h
56.4" (1432mm) dia x 47" (1195mm) h

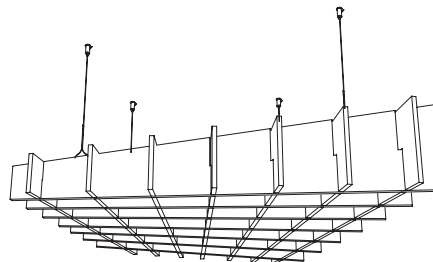

CLOCHETTE

39" (992mm) w x 44.1" (1121mm) l x 9.2" (232mm) h

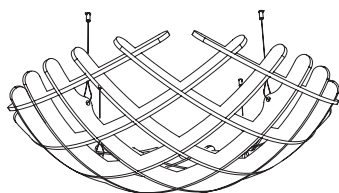

DOME CONVEX

44.6" (1133mm) w x 44.6" (1133mm) d x 11.8" (300mm) h

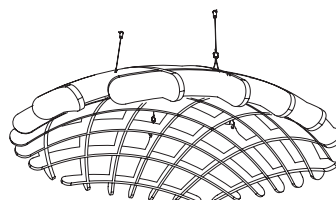

DOME CONCAVE

44.6" (1133mm) w x 44.6" (1133mm) d x 11.8" (300mm) h

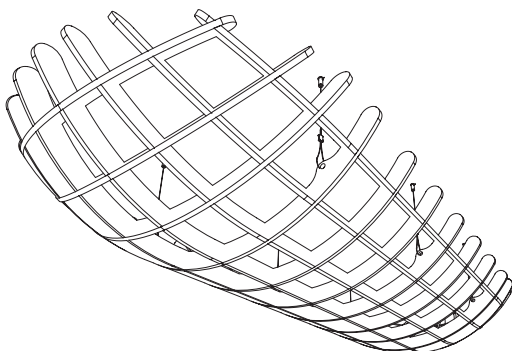

LONG DOME CONVEX

42.4" (1077mm) w x 97.5" (2476mm) d x 11.8" (300mm) h

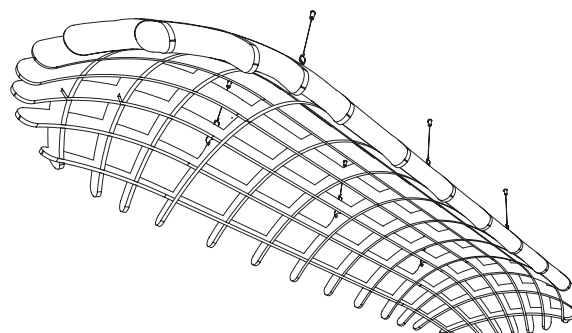

LONG DOME CONCAVE

42.4" (1077mm) w x 97.5" (2476mm) d x 11.8" (300mm) h

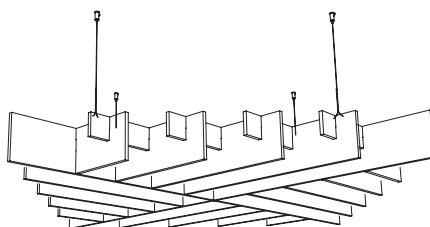

DRANTE

48" (1220mm) w x 48" (1220mm) l x 5.5" (140mm) h
72.1" (1832mm) w x 72.1" (1832mm) l x 9" (229mm) h

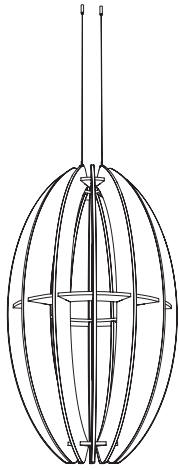

GIFFARD

14.4" (364mm) dia x 23.5" (595mm) h
27.3" (692mm) dia x 47" (1195mm) h
45.6" (1160mm) dia x 71" (1802mm) h

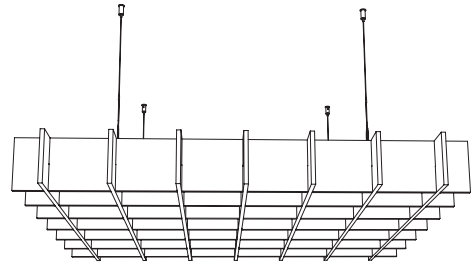

SQUARE

48" (1220mm) w x 48" (1220mm) l x 5.9" (150mm) h
48" (1220mm) w x 108" (2745mm) l x 5.9" (150mm) h
108" (2745mm) w x 108" (2745mm) l x 5.9" (150mm) h
108" (2745mm) w x 108" (2745mm) l x 8.9" (225mm) h

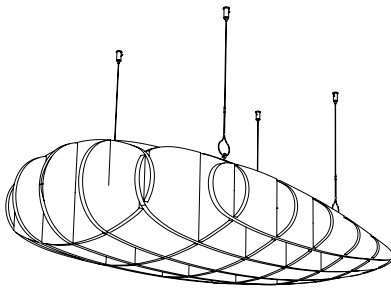

STRATUS

28" (711mm) w x 55" (1398mm) l x 11.5" (290mm) h

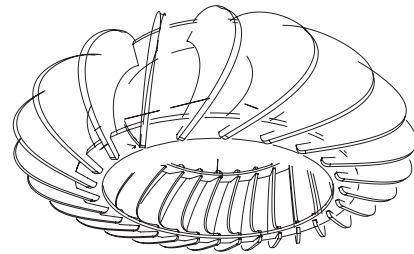

TURBINE

42.6" (1083mm) w x 42.6" (1083mm) d x 15.5" (393mm) h

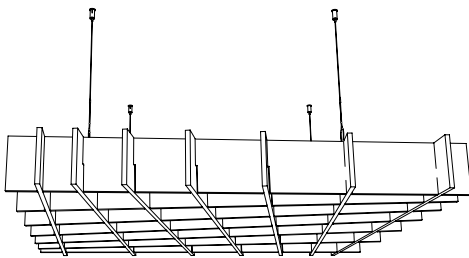

WARP

48" (1220mm) w x 48" (1220mm) l x 5.5" (140mm) h

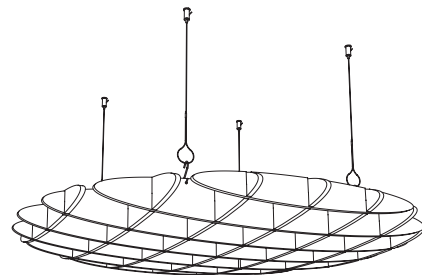

YOOFIE

48" (1220mm) dia x 6.2" (156mm) h
72" (1829mm) dia x 8" (204mm) h
96" (2438mm) dia x 10" (254mm) h
108" dia" (2745mm dia) x 10.1" (257mm) h

TECHNICAL DETAILS

MATERIAL

100% solution-dyed polyester.

ACOUSTIC RATING

ASTM C423-09a test results: 0.90.

Frequency/Hz		100	125	160	200	250	315	400	500	630	800	1000	1250	1600	2000	2500	3150	4000	ā	NRC
DISTANCE FROM WALL	0mm	0.03	0.01	0.09	0.04	0.05	0.09	0.12	0.25	0.32	0.49	0.61	0.72	0.82	0.85	0.91	0.94	0.95	0.44	0.45
	50mm	0.20	0.16	0.22	0.32	0.46	0.56	0.63	0.80	0.89	1.03	1.04	0.99	1.07	1.00	0.93	0.87	0.92	0.81	0.80
	150mm	0.29	0.46	0.44	0.57	0.69	0.81	0.97	0.96	0.91	1.04	0.92	0.80	0.94	0.94	0.91	0.90	0.91	0.87	0.90

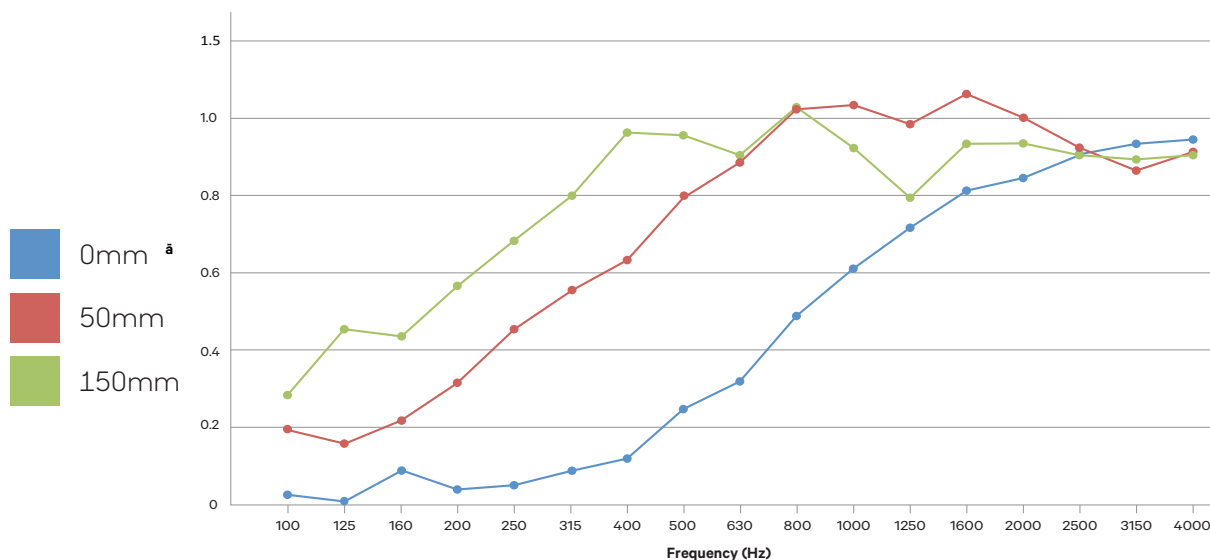

SIZE

See pages 5-6.

SURFACE FINISH

Both sides "A" or "B" have a matt surface and are suitable to use as the face. To ensure consistency of look, it is recommended that the face surfaces are either all "A" or all "B" when installing side-by-side.

WEIGHT

0.5 lb / ft² / 2.4 kg / m²

APPLICATION

Indoor areas only.

FABRICATION

Utility knife and CNC with oscillating knife.

INSTALLATION

Cloud components are supplied flat pack.

Assembled Clouds are suspended from the ceiling using hanging hardware supplied.

Go to zintraacoustic.com for complete installation instructions.

FIRE RATING

ASTM-E84 - Class A classification

AS ISO 9705 - 2003 - Group 1 classification

EN-13501 - B-s2-d0 classification.

LIGHTFASTNESS

AATCC 16.3, Option 3: Panel color change at 40AFU is 4.5.

TEMPERATURE

Maximum temperature exposure is 240°F (115°C).

MOISTURE ABSORPTION

Polyester fibre when exposed to an atmosphere of 120°F (49°C) at 90% relative humidity for four days showed moisture absorption of less than 0.03% by weight.

VOC TESTING

Standard Method Version 1.2 for CDPH 01350: PASS for all testing scenarios.

CARE INSTRUCTIONS

Vacuum to remove dust.

Remove spills immediately using a clean damp cloth or with soap and water.

Polyester carpet and fabric cleaners can be used - always test an inconspicuous area first.

A stain repellent coating is available for additional protection.

To disinfect, bleach can be used in accordance with CDC cleaning and disinfection instructions. (Solution ratio is 5 tablespoons of bleach to 1 Gallon (3.7 ltr) of water or 4 teaspoons of bleach per quart (0.95 ltr) of water. Spray apply the solution as a mist and wipe off surface moisture.

ENVIRONMENT

Zintra is made from 100% recyclable materials.

COLOR RANGE

24 sheet colors and 4 timber colors.

TIMBER COLORS



Merbau (MB)

Spotted Gum (SP)

Eucalyptus (EU)

Ironbark (IB)

PLAIN COLORS

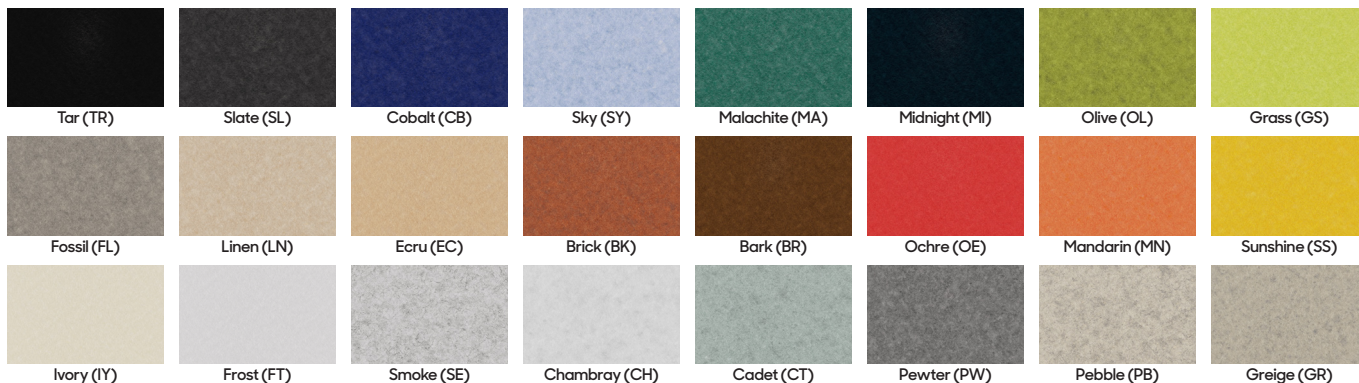

Tar (TR)

Slate (SL)

Cobalt (CB)

Sky (SY)

Malachite (MA)

Midnight (MI)

Olive (OL)

Grass (GS)

Fossil (FL)

Linen (LN)

Ecru (EC)

Brick (BK)

Bark (BR)

Ochre (OE)

Mandarin (MN)

Sunshine (SS)

Ivory (IY)

Frost (FT)

Smoke (SE)

Chambray (CH)

Cadet (CT)

Pewter (PW)

Pebble (PB)

Greige (GR)