

ISOMETRIC

client:

project: ZINTRA BEAMS

date : 2/02/2023

description: OPEN RAFTER 1X5

assembly name: OPEN RAFTER GA

SKU: ZI.BM.OR1X5.48144

sheet size:

A3

sheet scale:

1:14

page no:

1

rev:

2

drawn by:

JV

CLIENTS APPROVAL

SIGNATURE

DATE

PLEASE MAKE SURE THAT ALL DIMENSIONS AND INFORMATION MATCHES THE PROJECT AND SIGN FOR APPROVAL

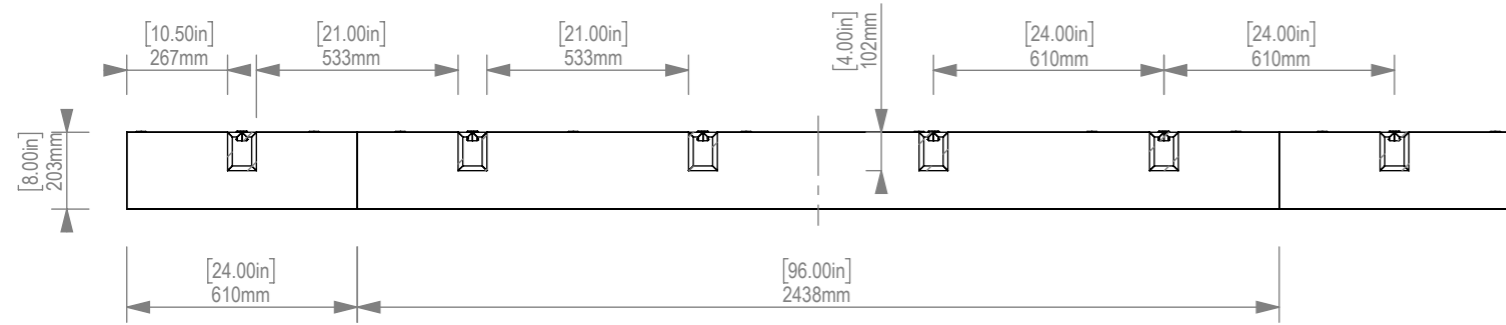

SECTION C-C

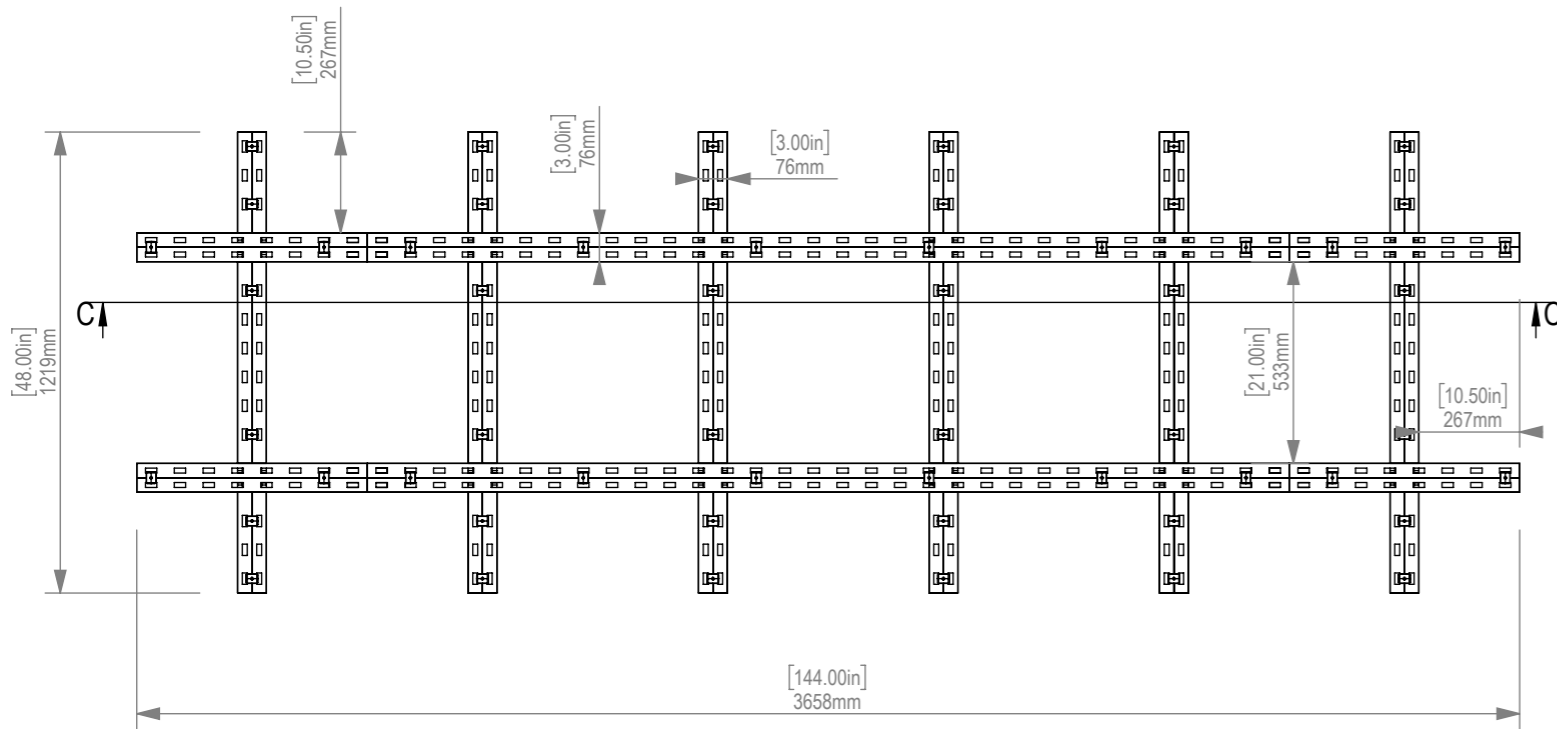

TOP VIEW

ITEM NO.	Description	Material	Finish	QTY.
1	96in x 8in Main Beam	ZINTRA	AS PER ORDER	2
2	21in x 4in Connecting Beam	ZINTRA	AS PER ORDER	6
3	24in x 8in End Beam	ZINTRA	AS PER ORDER	4
4	10.5in x 4in End Beam	ZINTRA	AS PER ORDER	12
5	8in Beam Connector	ZINTRA	AS PER OREDER	4
6	BEAMS CLIP	POLYCARBONATE	CLEAR	56

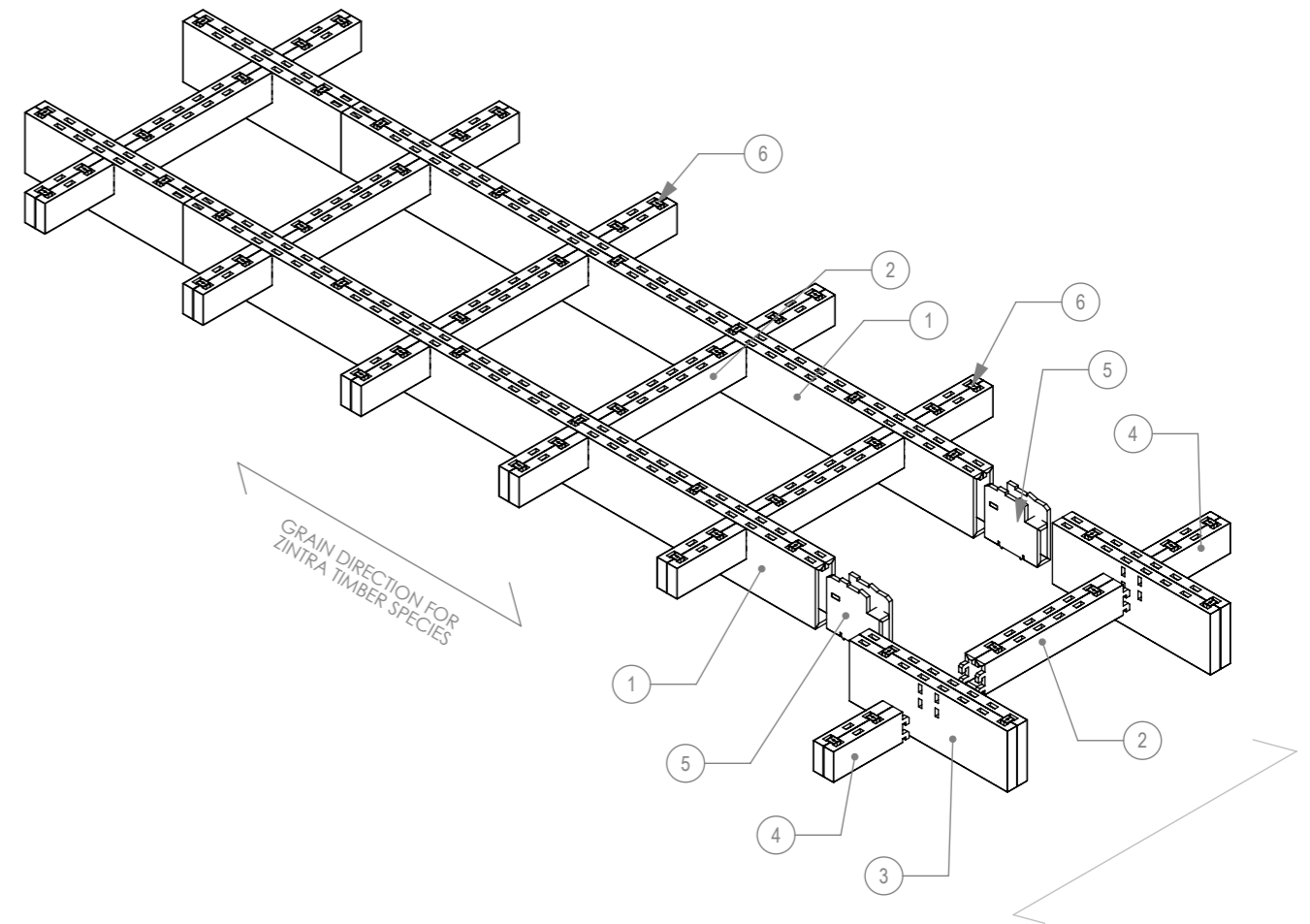

EXPLODED