

PARTS AND HARDWARE

FOR A TYPICAL ASSEMBLY

8in MAIN BEAMS (96in) - x8

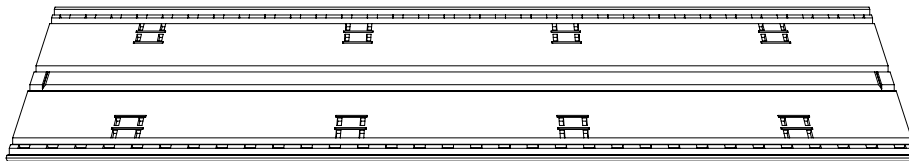

8in END BEAM - x16

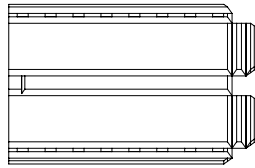

8in BEAM CONNECTOR - x16

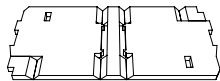

BEAMS CLIP - x80



STEP 1

BEAMS ASSEMBLY

ASSEMBLE INDIVIDUALS PARTS AS PER PURCHASED PACKAGE.

FOLD 8IN MAIN BEAM AND SECURE IT BY INSERTING BEAMS CLIPS INTO PRE-CUT RECTANGULAR HOLES.

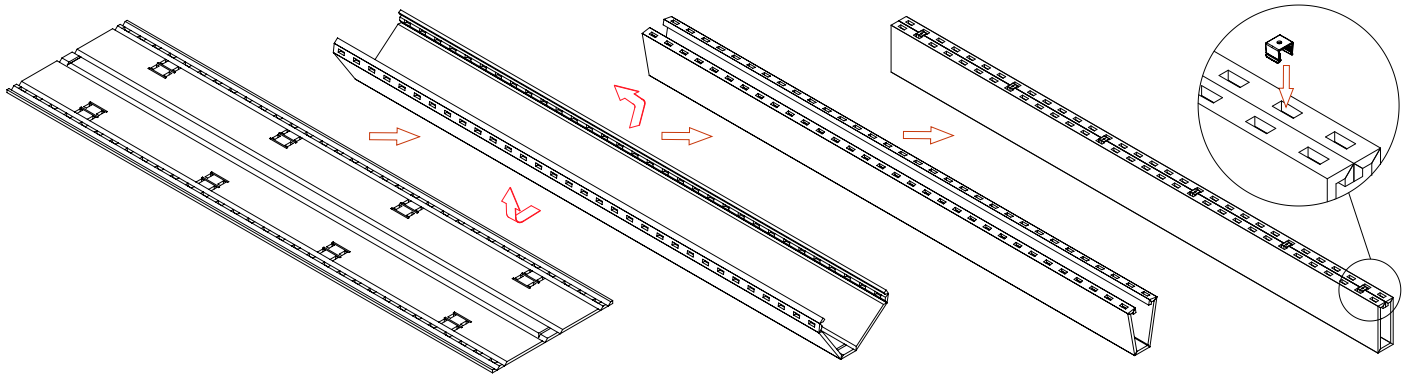

*BEAMS CLIPS QTY FOR 8IN MAIN BEAMS - x6

*IMPORTANT: DO NOT INSERT CLIPS INTO FIRST AND LAST HOLES OF THE MAIN BEAM

FOLD 8IN END BEAM AND SECURE IT BY INSERTING BEAMS CLIPS INTO PRE-CUT RECTANGULAR HOLES.

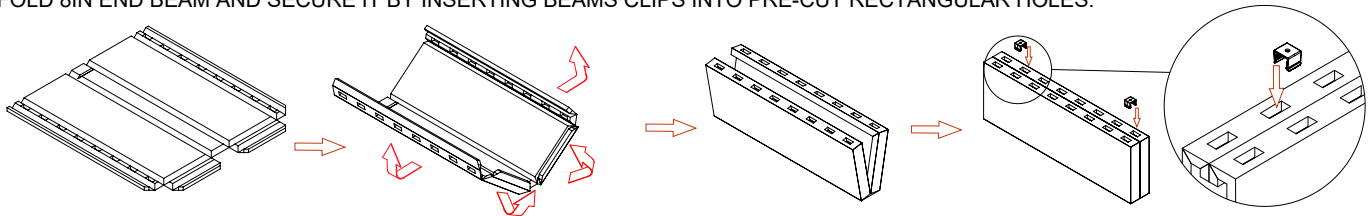

*BEAMS CLIPS QTY FOR 8IN END BEAM - x2

*IMPORTANT: ON OPEN END DO NOT INSERT CLIP INTO FIRST HOLE OF THE BEAM

FOLD 8IN BEAM CONNECTOR AND SECURE IT BY INSERTING INTO PRE-CUT RECTANGULAR HOLES.

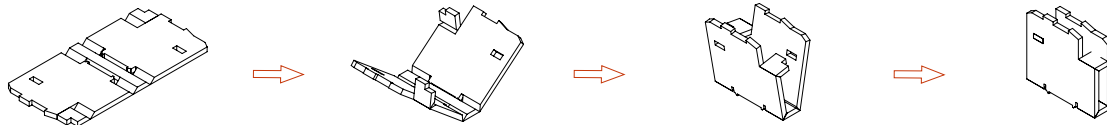

STEP 2

8IN BEAMS CONNECTOR INSTALL

2.1 INSERT 8IN BEAMS CONNECTORS INTO THE ENDS OF 8IN MAIN BEAMS AS SHOWN.

2.2 WITH THE HELP OF FINGER RISE THE TOP OF 8IN MAIN BEAM FOR EASY INSERT.

2.3 INSERT THE 8IN BEAMS CONNECTOR INTO THE CORRESPONDING PRE-CUT RECTANGULAR HOLES IN THE 8IN MAIN BEAM.

2.4 REPEAT STEPS 2.1 - 2.3 FOR EACH 8IN BEAMS CONNECTOR UNTIL THE ASSEMBLY AS SHOWN HAS BEEN COMPLETED.

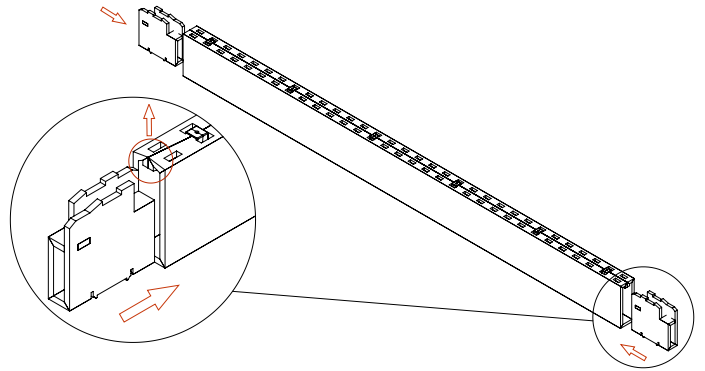

STEP 3

8IN END BEAMS INSTALL - FINISING INSTALL

3.1 INSERT 8IN END BEAM INTO BEAM COONECTOR FROM THE STEP 3 ASSEMBLY AS SHOWN.

3.2 USE 2.2 AND 2.3 STEPS FOR END BEAMS INSTALL.

3.3 REPEAT STEPS 3.1 - 3.2 FOR EACH 8IN END BEAMS UNTIL THE ASSEMBLY AS SHOWN HAS BEEN COMPLETED.

