

Yakka floor screen install guide

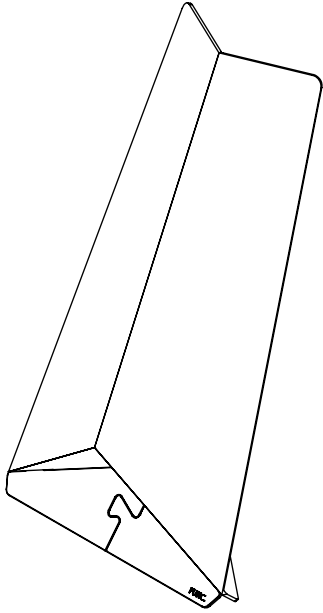

x1 Yakka Floor Screen

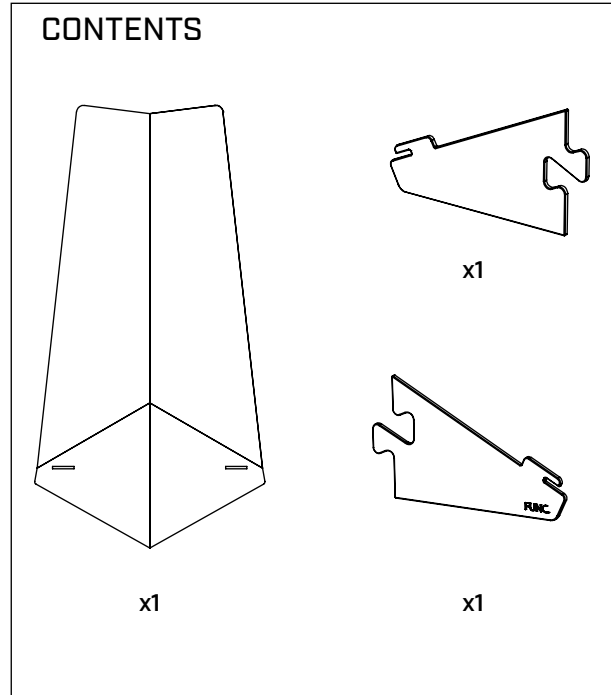

Safety protection you will need:

0

- Safety Glasses

1

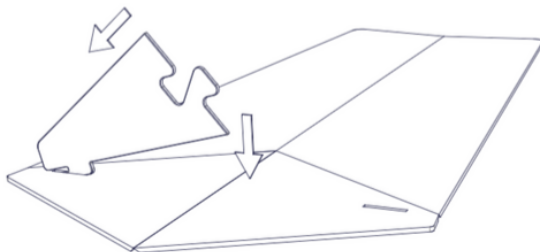

a.
Insert plywood base

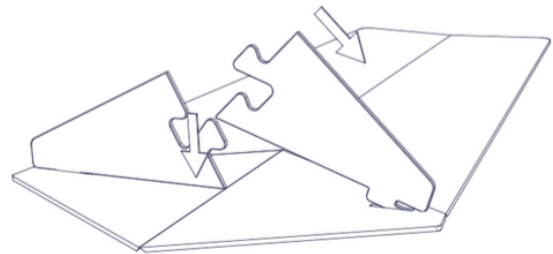

b.
Insert plywood second base

2

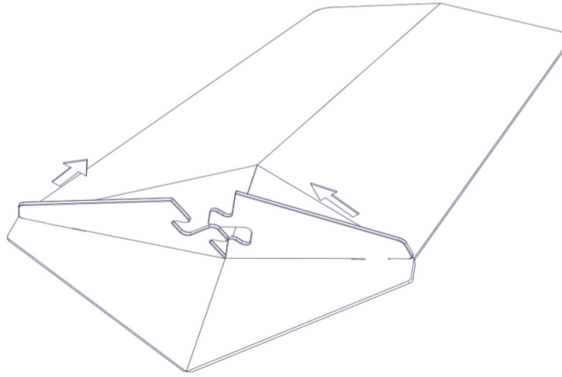

a.
Fold panels

3

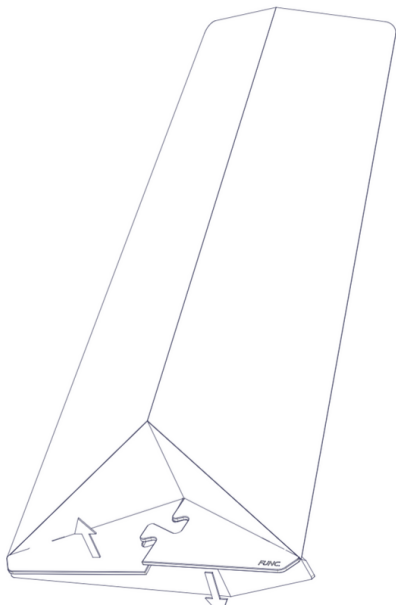

a.
Connect plywood bases

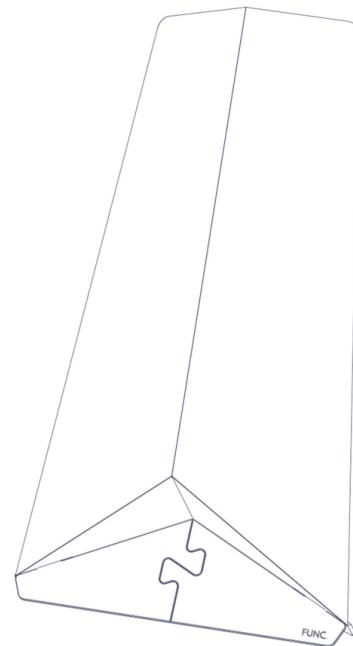

b.
Ensure is locked in location