



PARTS AND HARDWARE

SUITABLE SCREWS

SCREWS ARE NOT INCLUDED - INSTALLER TO SUPPLY BASED ON FIXING SUBSTRATE



PANEL

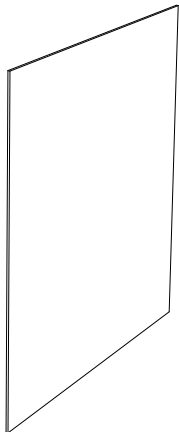

STAND OFFS

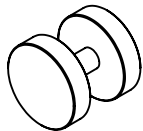

Z CLIPS

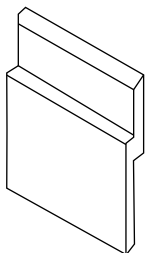

YOU WILL NEED

SPIRIT LEVEL

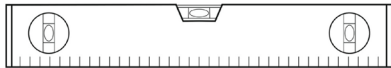

TAPE MEASURE

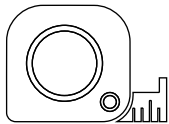

LOCTITE POWER GRAB EXPRESS HEAVY DUTY CONSTRUCTION ADHESIVE



APPROPRIATE APPLICATOR

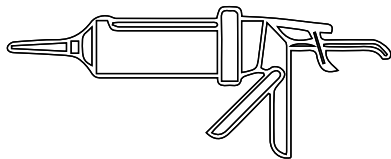

DRILL

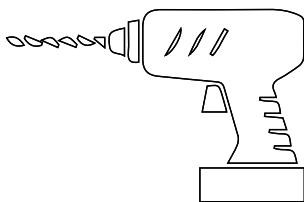

STEP 1

Install Zintra Sheets using one of these four common techniques:

1. Direct adhesion to the substrate
2. Z-Clips
3. Stand Offs
4. Mechanical fastener (screws or nails)

1. Direct adhesion to the substrate

a. Be certain that your substrate will hold an adequate bond to the recommended adhesive(s). If in doubt about a coating or a finish already in place, an adhesion mock up test is recommended before you begin.

b. Cut, scribe and dry pre-fit all Zintra panels as necessary.

c. Once all of the panels have been properly sized and trimmed, begin the application of the adhesive to the **BACK SIDE (ONLY)** of each panel. Use only Loctite Powergrab Heavy Duty Construction Adhesive.

d. Place the cartridge into the caulking gun, cut the nozzle to produce a 1/4" thick bead and puncture the inner seal. A 1/4" (0.64cm) bead will cover approximately 27 lineal feet (8.2 meters) per 9 fl oz tube.

e. First apply a bead around the entire perimeter of the **BACK** of the panel. Place the bead to be no more than 1" in from the perimeter at any point.

f. Next, apply a zig zag or diagonal pattern of additional adhesive across the central sections of the panel, within the perimeter bead. See the images on the right for guidance.

g. Apply the panel to the substrate within 20 minutes and monitor your adhesive to prevent it from skinning over. Set the panels into place and smooth with open palms.

h. Now, remove the panel from the substrate and hold it off the surface for one minute. Then reset the panel into place and smooth with firm pressure to set it. Use mechanical fasteners if you see the need to help this stay positioned while the adhesive remains wet.

i. Never use solvent based contact adhesives or any unauthorized adhesives.

j. Install all panels by maintaining the identical orientation of the sticker (and thus of the panel) for each and every panel installed. Do not reverse or flip panels.

f.

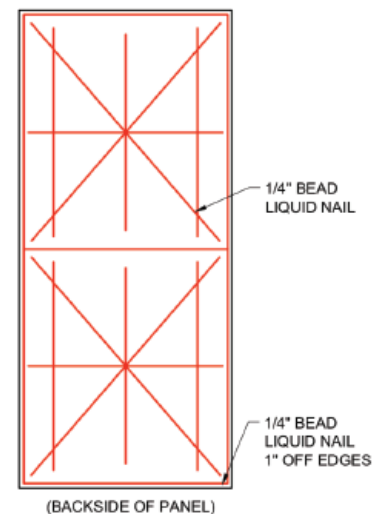
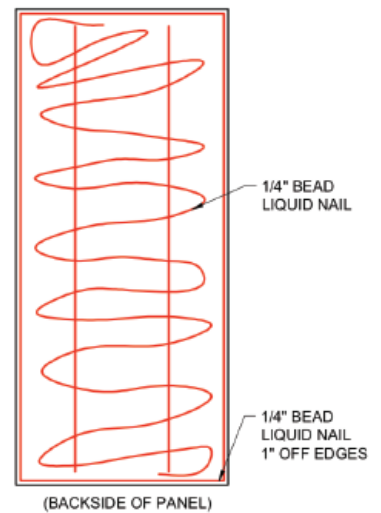

ZINTRA DIRECT STICK INSTALLATION INSTRUCTIONS

STEP 2

2. Using Z Clips (also known as Z-Bars or French Cleats)

a. Before attaching 1/2 of each Z Clip set to the back of the panels, you should verify if you are grouping panels so they will butt each other or installing them independent so they do not butt.

b. You will be supplied a number of Z-Clip sets which are appropriate for the length of your panel. Each set will be 72" long and you will need to trim them based upon which method (grouped or not) you will be using for the installation.

- ba. 75" - 108" long panels will require (4) Z-Clips sets, spaced evenly.
- bb. 41" - 74" long panels will require (3) Z-Clip sets, spaced evenly.
- bc. Panels which are less than 41" long will require (2) Z-Clips sets.

c. Single Panel installation (not a group).

ca. Trim each Z-Clip set to be a total of 6" less than the final width of your panel. You will position each Z-Clip so that both the left and the right sides of the panel extend beyond the final clip length by allowing 3" of panel overhang on each side. To cut the Z-clips, you can use a metal cutting blade, in a chopsaw, a hacksaw or a jig-saw.

cb. Place the upper-most and bottom-most clips first. These will each be positioned to be 3" in from the horizontal edges of the panel at the top and the bottom.

cc. Now place your remaining Z-Clips (two of those if panels are larger than 74" and one of those if shorter than 74") so that the next clips are evenly spaced in the space between the two edge Z-Clips. On full 9' panels, that means you would typically have a gap of 34" in between the two remaining Z-Clips and each would be another

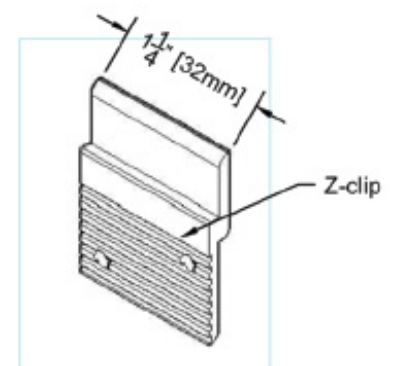
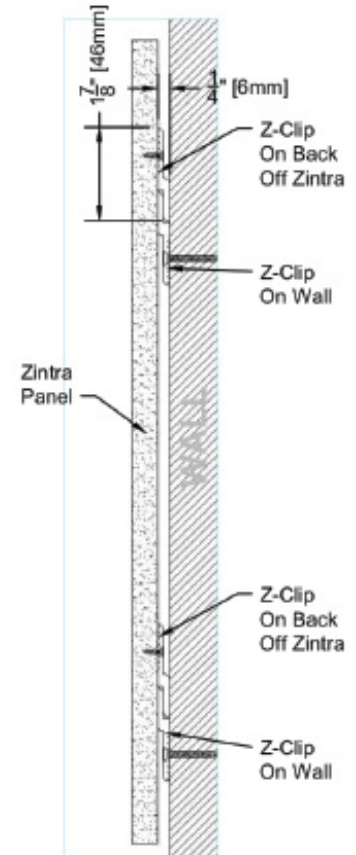

ZINTRA DIRECT STICK INSTALLATION INSTRUCTIONS

2a. Multiple Panels abutting in a group

a. The vertical positioning of your Z-Clips will remain as described above. (Either 4 or 3 or 2 sets, depending upon the height of your panels.)

b. Arrange the uppermost and the bottommost Z-Clips to be 3" in from the top and bottom of the horizontal edge of the panel.

c. You will trim the combined length of the Z-Clips (that will form a combined horizontal line) in order to remove 6" from the total width of the group of panels. Each horizontal "line" of Z-clips will be positioned so they are 3" in from the left most side and 3" in from the right most side of the perimeters of the panel group and to continuously run across the full span of the panel group.

d. Position the Z-Clips so that they bridge all seams between adjacent panels. Plan where the Z-Clips will abut so their seams will be no closer than 8" to any panel seam placement, trimming if necessary.

e. Follow the same guidelines for each placement and spacing between of the horizontal "lines" that will be needed per your height of panel as listed above.

2b. Anchoring the Z clips

a. The goal is to mount the Z-Clips level so the long sides of the panels (usually vertical) are then plumb. Allow a suitable vertical clearance in order to lift the panels up and over the wall side of the clip set half and then lower the panels securely into position for mounting.

b. You will first install all wall side 1/2 Z-Clips to the wall and then transfer those placements onto the back of the panel using a story pole.

c. Begin by mounting 1/2 of the first Z-Clip set to the wall behind the first panel. Orient the clip on the wall to be facing upward (the open gap should be facing up) and the bottom leg of the clip is against the drywall. Install the uppermost Z-Clip so that the top edge of the clip is no closer than 3" in from the top edge of the panel.

d. The clips should each be:

da. Parallel to the horizontal edges of the panel and thus level.

db. Inset and centered left to right so as to allow a 3" gap at each left and right side of the panel.

dc. Predrilled at the correct placements to accept #8 screws (pan or hex headed and of a length to attach to studs or blocking in your wall.) 4 screws per 42" section of each Z-clip is recommended.

e. With the wall side of the clip sets established, transfer those placements to a story pole which is the now height (rather than length) of the panel.

f. Note: outlets or cut outs in the panel may require specific adjacent additional supports and or Z-clips to support the panel at that cut out placement.

g. You will now use the story pole to determine the suitable placement of the panel side half set of each Z-clip onto the back of the panels.

h. Be sure your panels are in the correct orientation (verify the positioning of the sticker on the face side.)

i. These half Z-clip sets need to be positioned with the 1/2" adjustment in mind (so the panel can be raised up and over, then inserted into the wall side half clips.) Adjust your story pole accordingly for this. And mark the placement for each wall side clip on that pole.

j. Mark the horizontal placements on the back of the panel with a pencil.

k. Pre-drill the clip-half with 4 holes which are suggested for anchoring each half clip. Size the holes for a #8 screw.

l. Attach the half clips to the panels with their open edges facing downward, (see illustration) using 1/2" long #8 pan or hex headed screws. Do not over tighten. Pre-drill a 1/16" pilot hole of 3/8" depth if necessary.

m. Raise the panel with the proper number of Z-clips now attached (should be 4 of them in a full sized panel at 9 feet) and bring the panel side clips up and over the wall side clips until they firmly engage and then securely drop/mate into place. This will result in you seeing the 1/2" allowance gap at the top of the panel along the ceiling line.

3. Using Standoffs

Stand-off placement guide (below)

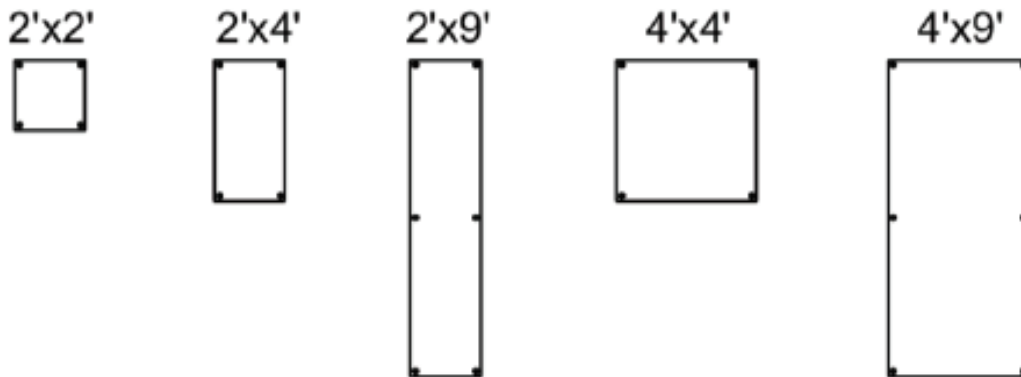

Stand-offs should be no closer than 3" from the edge of panel.

- Standoffs are available in 3 lengths (distance off the wall): 1", 1.75" and 2.5".
- The total number of standoff that will be necessary will be determined by the final dimensions of your panel, per the sizing illustration above. The illustration will define the minimum number of standoffs which are necessary.
- Note--- suitable blocking (chosen in accordance with your length of standoff) is also recommended as a hidden support and method to prevent caving or curvature of the panels over time.
- Begin by marking the panel back with the placement of each hole for every standoff which is required. No hole should be within 3" of any perimeter edge of the panel.
- Using a tungsten carbide bit, drill 1/2" diameter holes through the panels for each standoff placement.
- With all of the panel holes now drilled, determine the precise placement of where the panel is to be installed. With one person holding the panel in place (level and plumb), a second person will mark the substrate with the precise placement of each panel hole.

ZINTRA DIRECT STICK INSTALLATION INSTRUCTIONS

- g. Predrill the substrate to allow the anchoring of the stud-fixing pin of the standoffs to be attached to the blocking under your substrate. We do not recommend that you anchor into only gyp board to suspend the panels. Blocking under the gyp board is always recommended if attachment to studs is not possible for each standoff.
- h. Secure each standoff to its appropriate stud-fixing pin which is attached to the wall.
- i. Set the panel in place over the standoff bases and attach the standoff head cap trims to secure the panel. Tighten only by hand and do not over tighten.

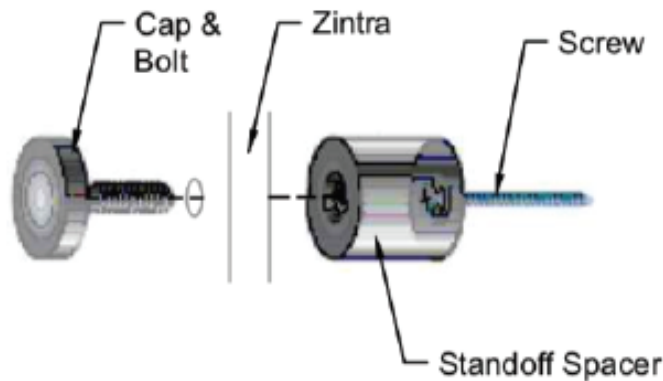

If you are unsure about the system which has been specified for your project, please stop and verify the details with both the specifier and Baresque. Remember that while Baresque may be able to assist you with common methods of attachment, others may be unique to your project and need to be discussed directly with your specifier.