



**botton + gardiner**

PUBLIC SPACE FURNITURE



## contents

<b>+ about us</b> .....	<b>4</b>
<b>+ sustainability</b> .....	<b>6</b>
<b>+ nexus collection</b> .....	<b>8</b>
<b>+ products</b> .....	<b>14</b>
- straight ottoman   O1 .....	14
- straight seat   S1 .....	15
- angled ottoman   O2 .....	16
- concave seat   S2 .....	17
- convex seat   S3 .....	18
- chaise ottoman   O3 .....	19
- 60° ottoman   O60 .....	20
- 120° ottoman   O120 .....	21
- 60° table   T60 .....	22
- 120° table   T120 .....	23
- 60° planter   P60 .....	24
- 120° planter   P120 .....	25
- 60° bin general waste   BG60 .....	26
- 60° bin recycling   BR60 .....	27
- 120° bin   B120 .....	28
- optional accessories   armrest .....	30
- optional accessories   power .....	31
<b>+ configuration ideas</b> .....	<b>32</b>
<b>+ configuration parameters</b> .....	<b>34</b>
<b>+ materials + finishes</b> .....	<b>36</b>
<b>+ assembly</b> .....	<b>38</b>



botton + gardiner

PUBLIC SPACE FURNITURE

## about us

### + elevating public spaces

For over 27 years, Botton + Gardiner has been producing exceptional commercial furniture that connects people and takes public spaces to the next level.

### + 100% local

Australian and proud, every Botton + Gardiner collection is designed, engineered, and sustainably manufactured right here on home soil.

### + beyond aesthetics

Balancing the perfect blend of form and function, we use quality materials that not only create beautiful public spaces but are durable enough to withstand the harshest conditions - indoors and out.



## sustainability

### + planet-conscious production

From design to disposal, we hold ourselves to the highest international standards of sustainability.

We use cutting-edge technology throughout the production process, ensuring all physical and airborne waste material is minimised, sorted and disposed of responsibly.

### + material differences

We choose eco-friendly materials and finishes that reduce our environmental impact.

Steel and aluminium featured in our products contain recycled content and are 100% recyclable.

We only use hardwoods that are sourced from sustainably managed forests and locally certified, and compact laminates and non-porous solid surfaces that carry internationally recognised Environmental Product Declarations.

### + a positive impact

Our products help create public spaces that foster wellness and bring more moments of connection and ease to urban environments.



## + nexus collection

### + total connection

With curved contours and dynamic combinations, Nexus brings people together in public spaces, providing opportunities for connection, collaboration, rest, or relaxation.

Rounded forms subtly invite the outdoors inside, bringing an organic, grounded sense of nature to commercial, retail and educational environments.

### + organic forms, infinite possibilities

Like the natural elements that inspired the range, Nexus is not static.

Modular elements can be configured to create nodes of interaction or zones for quiet enjoyment, while a large selection of fabrics, finishes and integrated elements mean you can create a bespoke look and functionality that makes each configuration unique.



## + nexus collection

### + soft, yet durable

While featuring gentle contours and uncompromising comfort, the Nexus range is designed to meet the demands of public spaces.

The range offers hardwearing, easy-to-clean fabrics, multipurpose compact laminate finishes, durable non-porous solid surfaces and powder-coated finishes that will stand the test of time - and maintenance.

### + next level detail

At every turn Nexus displays an emphasis on craftsmanship and attention to detail.

From double stitching that creates smooth upholstered forms along the curves of the modular seating elements, to armrests, tables, planters, and bins that all feature gently rounded edges, every element has been thoughtfully considered and beautifully resolved.



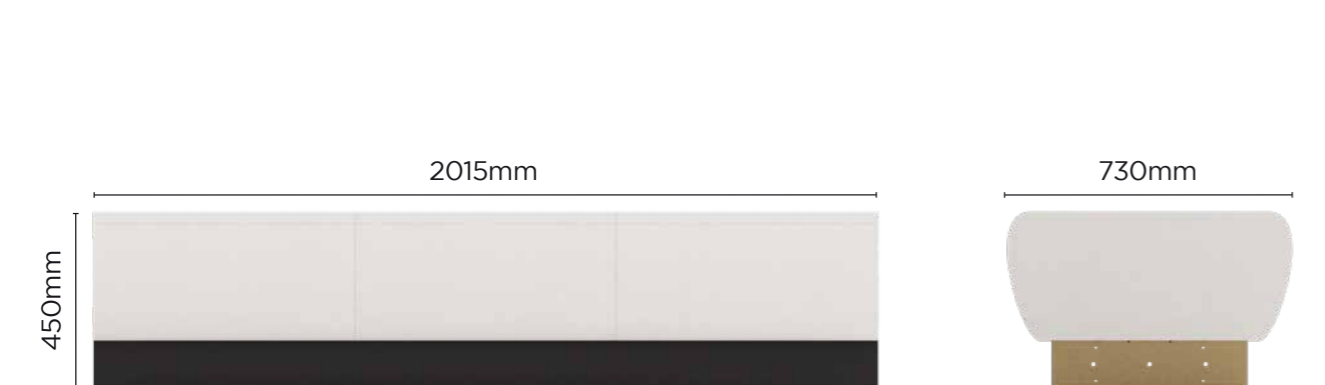



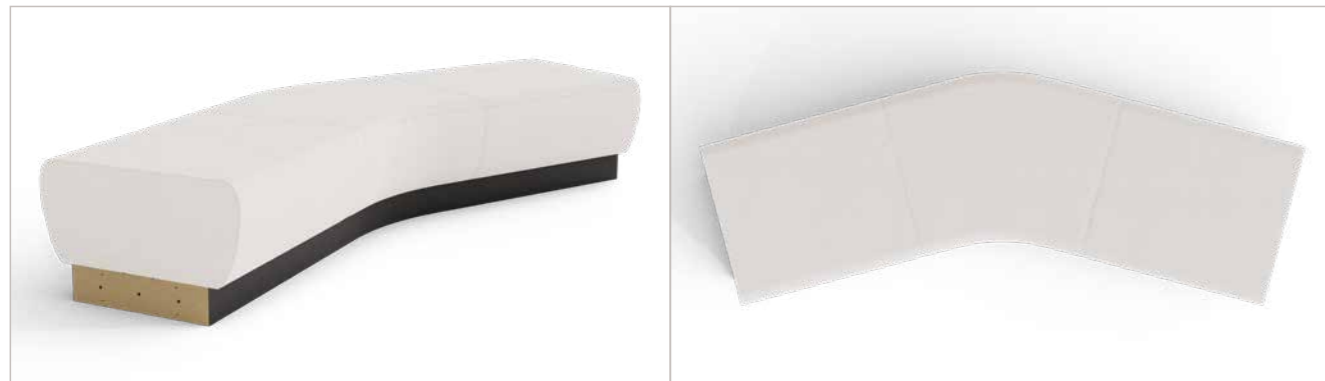

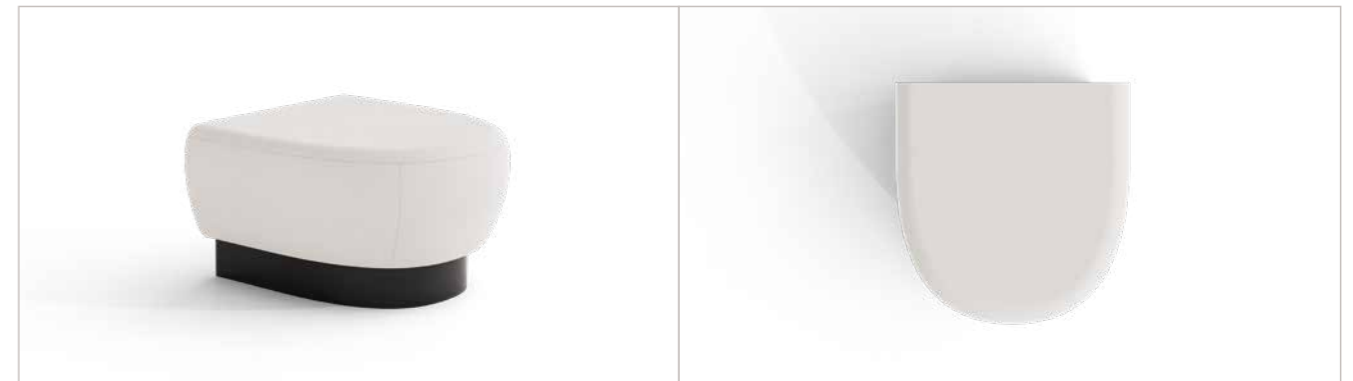

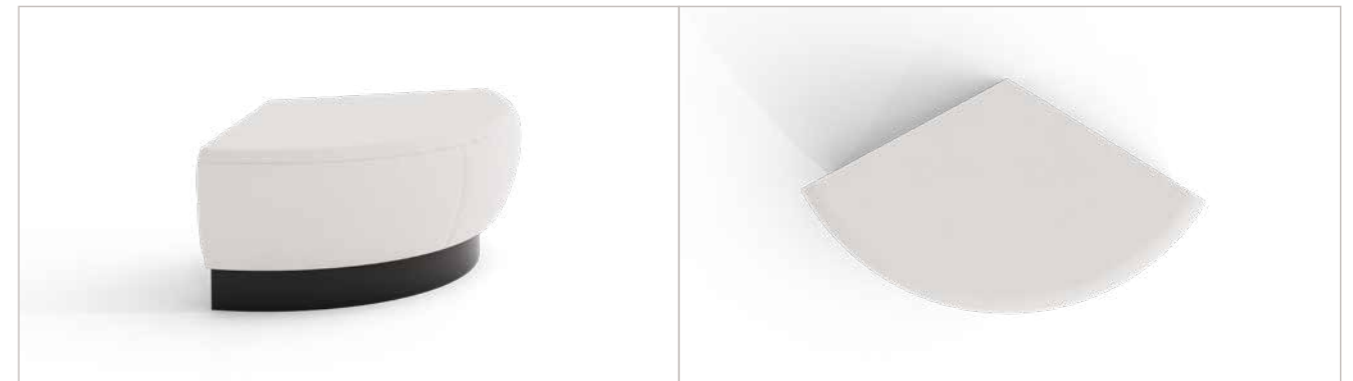
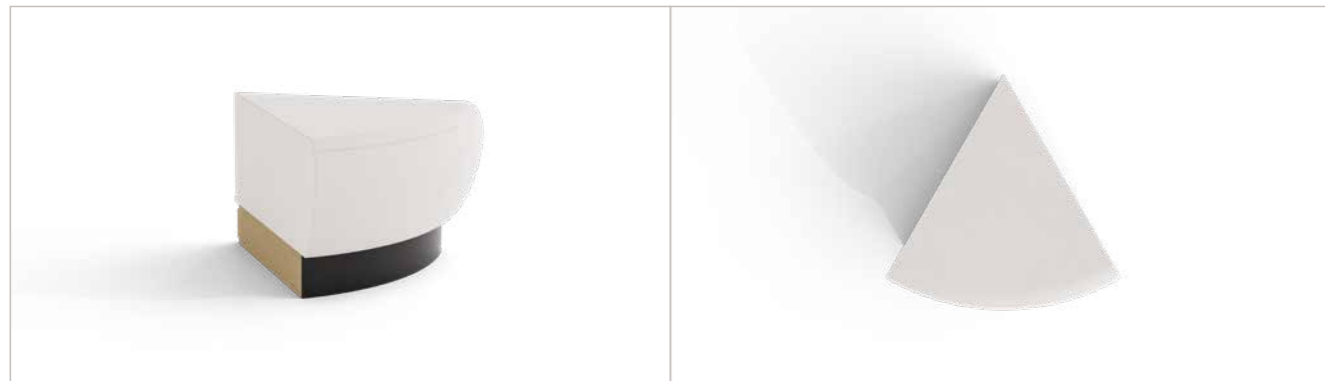

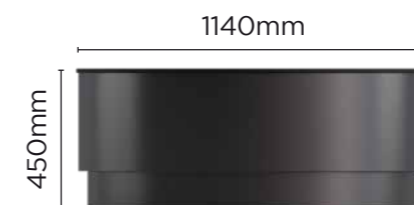
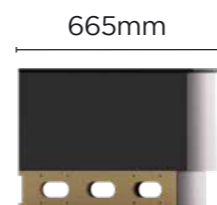
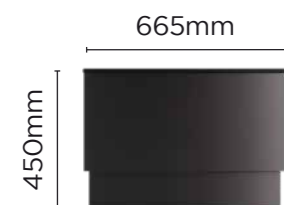

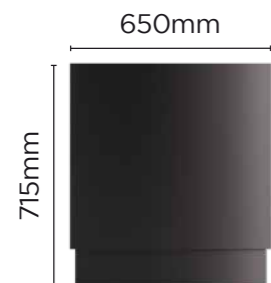

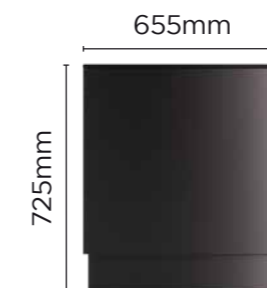
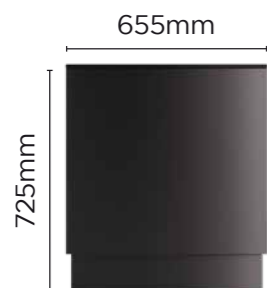
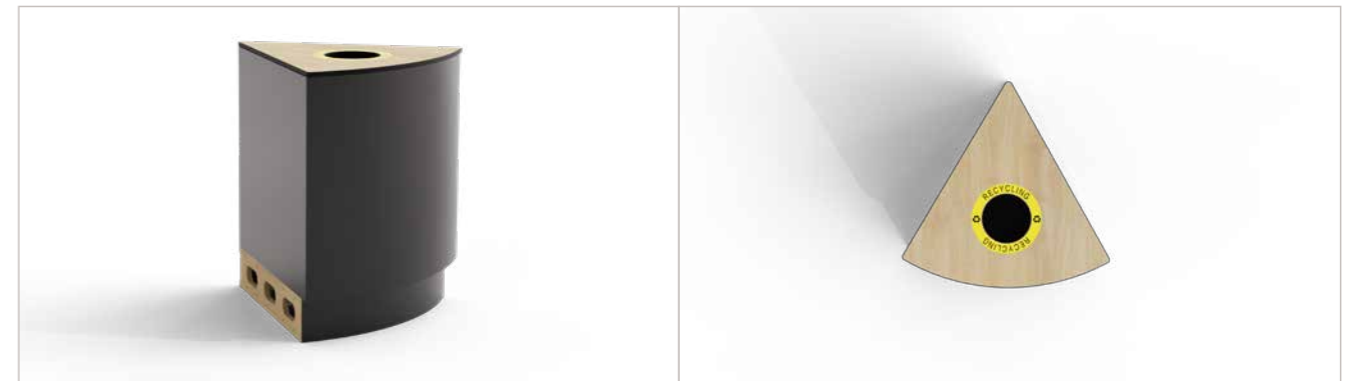
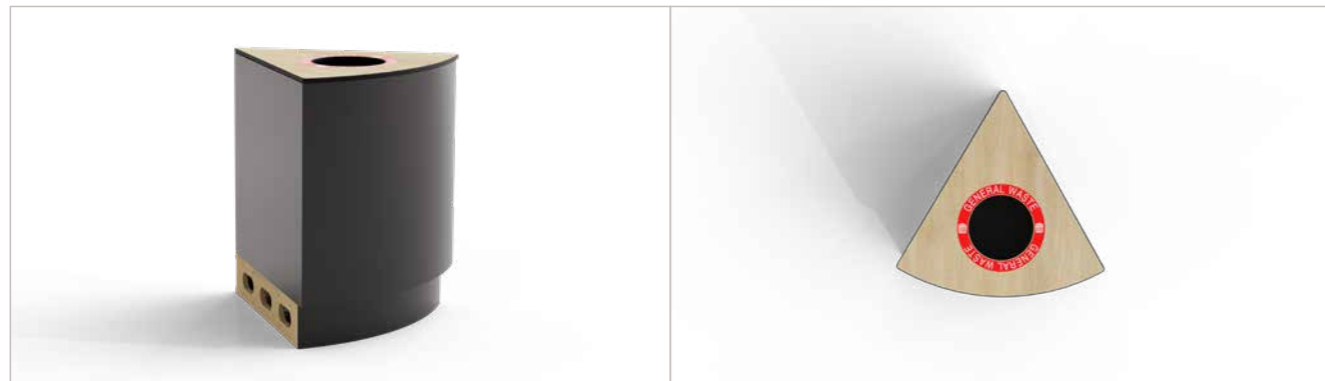





Offering on-the-go customers the ability to charge their mobile devices quickly, the Pixel GPO sits almost flush to the vertical surface for a seamless look, while its organic curved shape ensures protection against liquid ingress.

The Pixel GPO is fitted to your Nexus seating by Botton + Gardiner with a recommendation to use 2 x GPOs per seating module. The fascia and perimeter ring colour is white or black. The GPO configuration includes:

- 1 x Australian socket outlet
- 1 x USB-C port
- 1 x USB-A port





**circular**

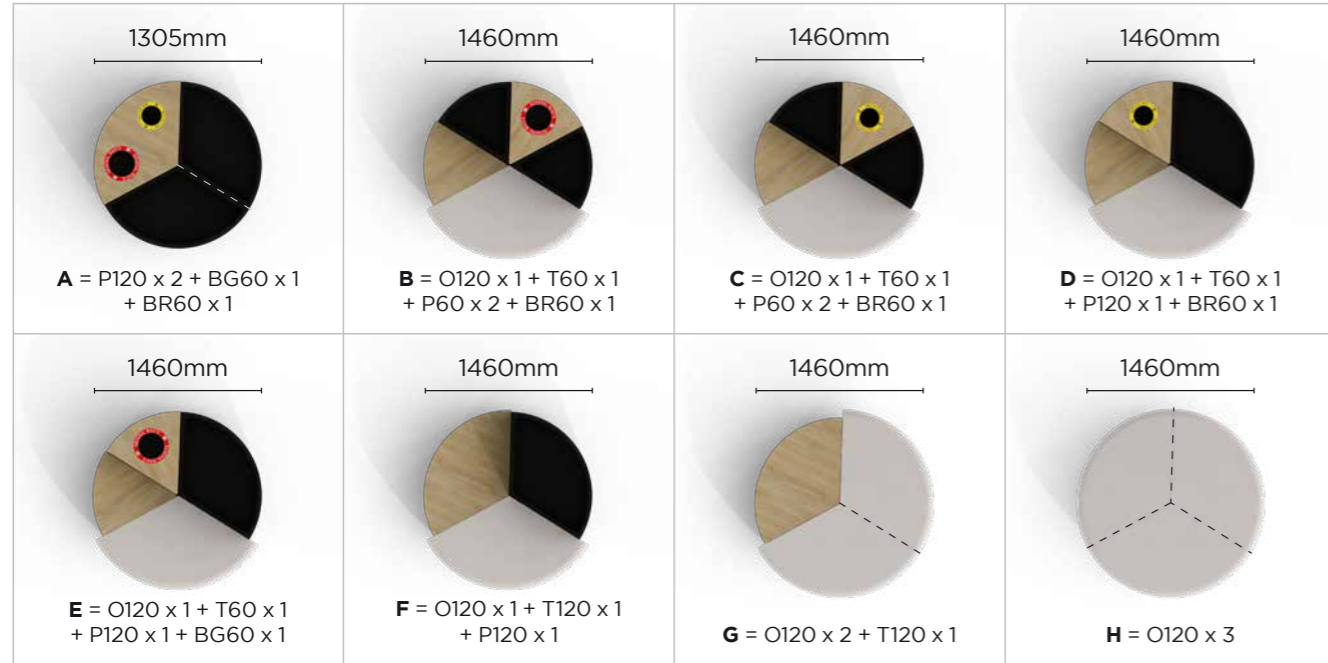

**island**

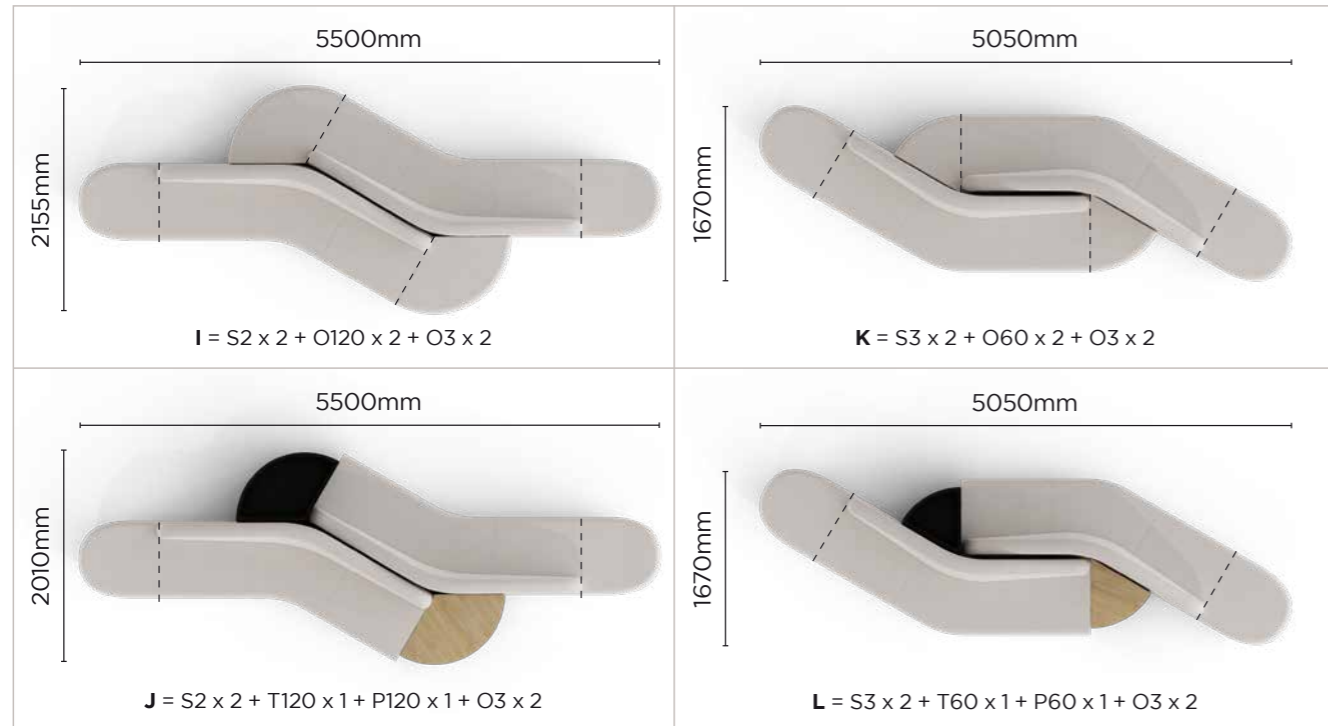

**straight**

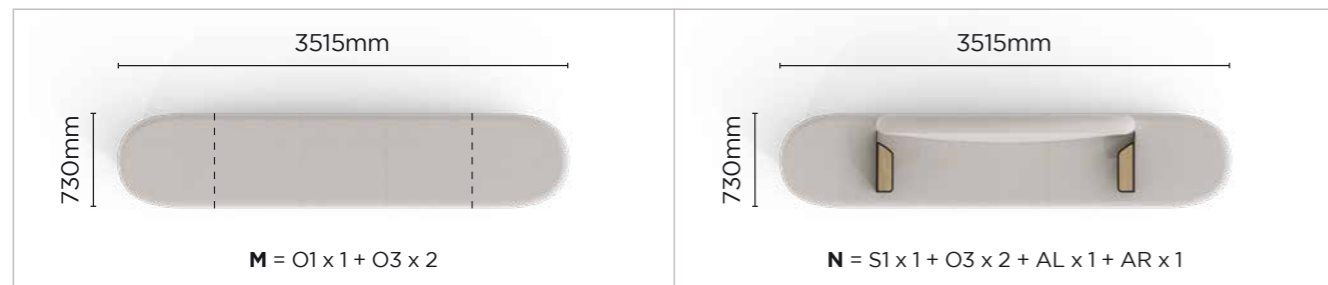

**angled**

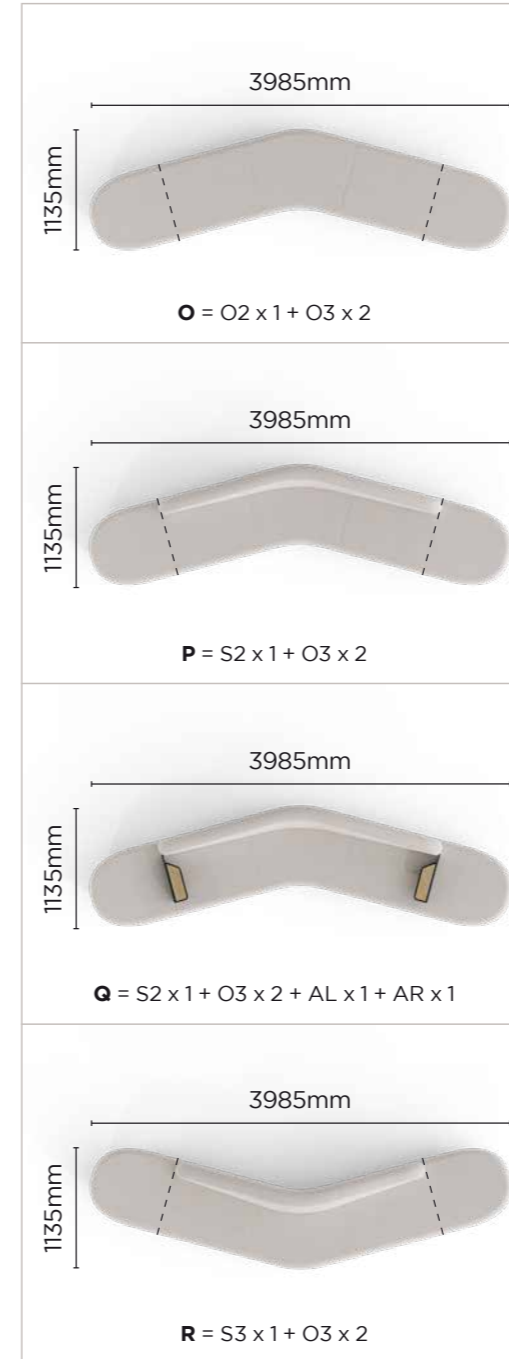

**branching**

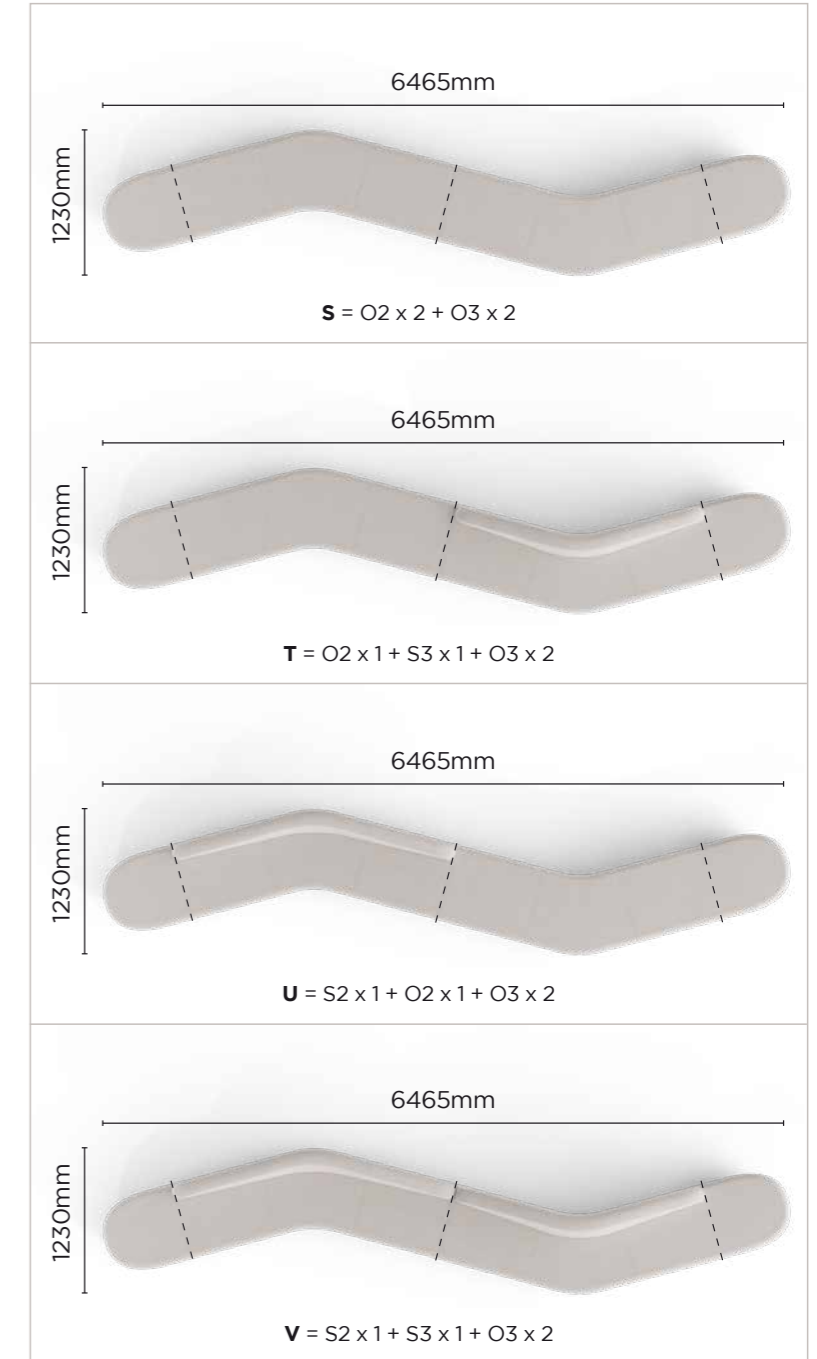

**modules key**

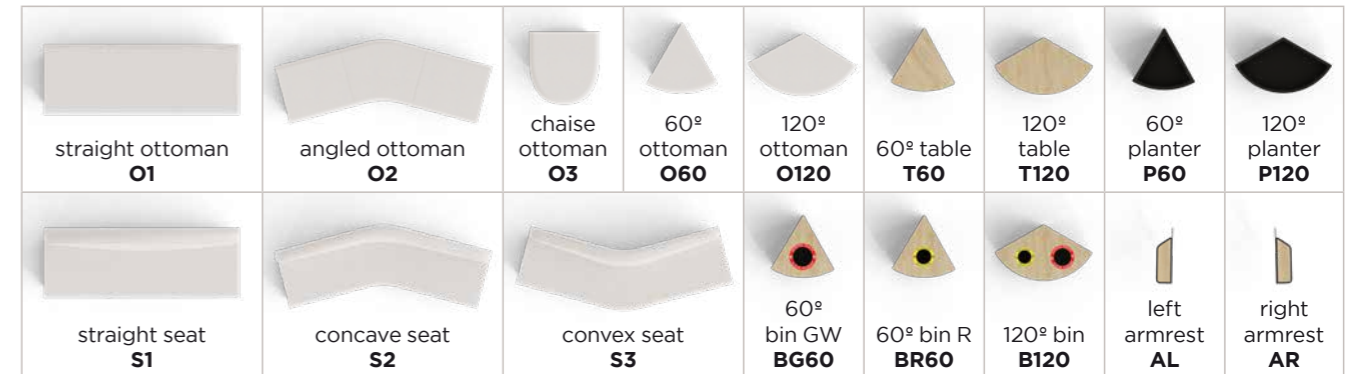

**main modular seating elements**

The Nexus seating is omni-directional and comes in both a concave and convex form. The backrest can be used on either side of the seat.

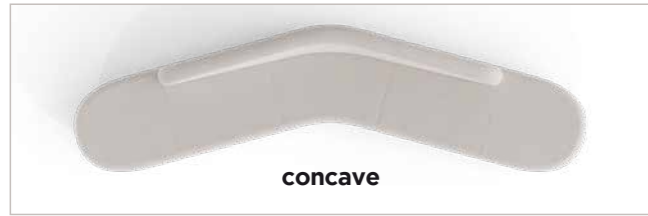

**concave back-to-back seating**

The concave seat is only able to nest with a back-to-back configuration.

END A is best capped with a chaise ottoman.  
END B is best capped with:

- 120° modular elements: ottoman, table or planter
- 2 x 60° modular elements: ottoman, table or planter

**convex back-to-back seating**

The convex seat is only able to nest with a back-to-back configuration.

END A is best capped with a chaise ottoman.  
END B is best capped with:

- 60° modular elements: ottoman, table or planter

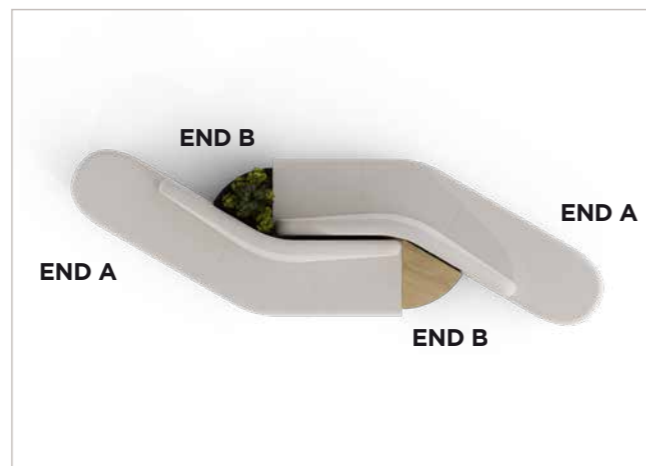
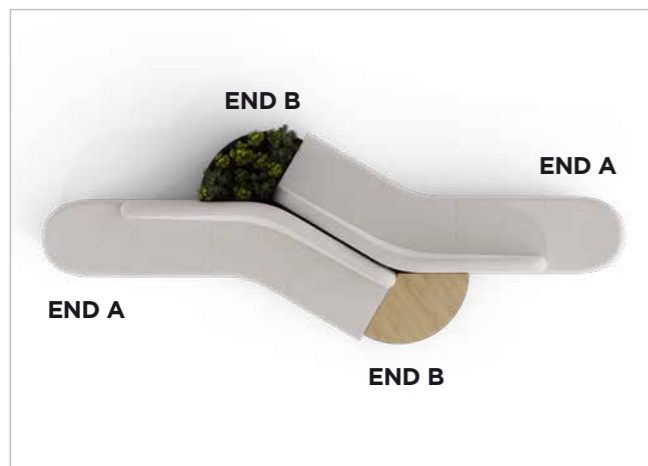

**single seating**

The ends of the modular elements are best capped with a chaise ottoman.



**branching long runs**

Branching long runs can be made with the:

- straight ottoman or straight seat
- angled ottoman
- concave seat
- convex seat

Ends are best capped with a chaise ottoman.

Branching long runs are not able to be nested back-to-back.

The optional integrated armrest is only able to be installed on the ends of the modular segments and not in the middle.



**circular pie configurations**

Circular pie configurations can be made with 60° and 120° modular elements: ottoman, table, planter or bin.

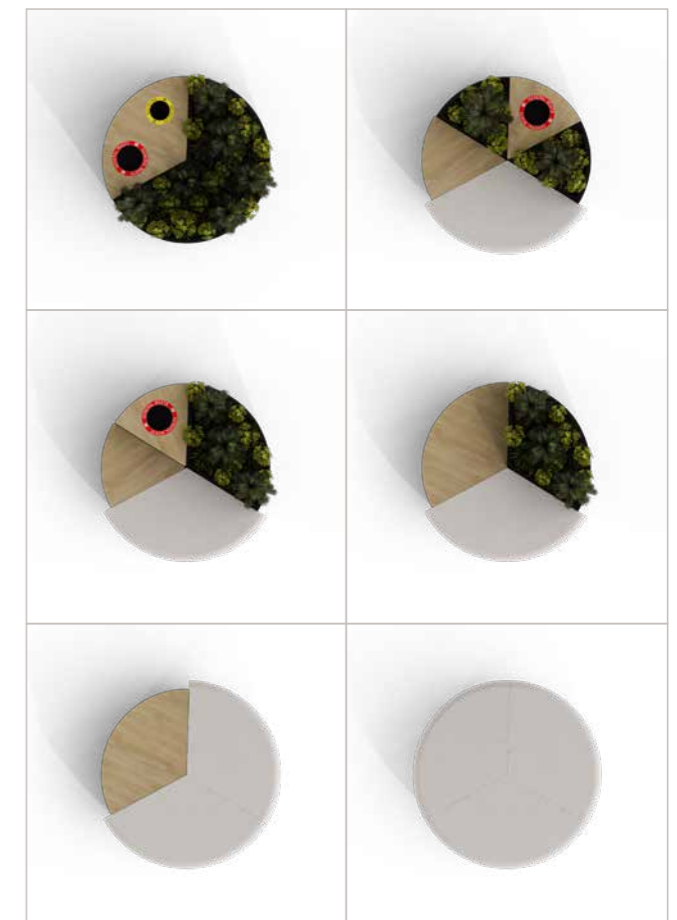

**UPHOLSTERY FABRICS | BARESQUE**



**MULTIPURPOSE COMPACT LAMINATES | LAMINEX®**



**SOLID SURFACES | CORIAN®**



**POWDER-COAT COLOURS**



### NEXUS INSTALL GUIDE

#### Step 1

Place both modules on the floor.

#### Step 2

Align the connector arms with the pin by moving the modules close together.

#### Step 3

Push the modules together (audible clicks) until modules are tight up against each other.

#### Step 4

Repeat with other modules.

### CONNECTOR DETAIL

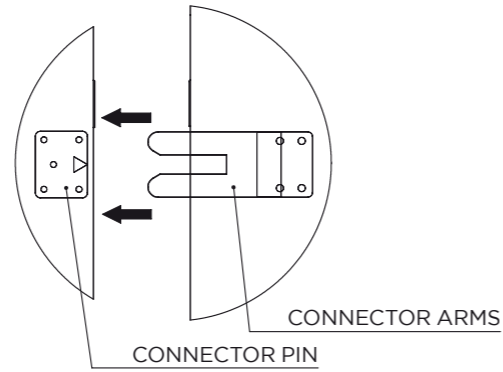

### PIE MODULE CONNECTOR DETAIL

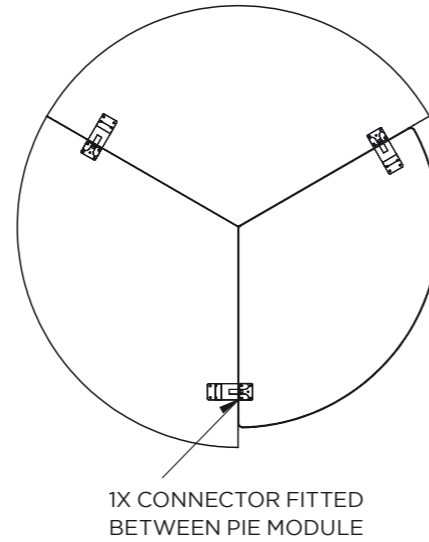

### BACK-TO-BACK CONNECTOR DETAIL

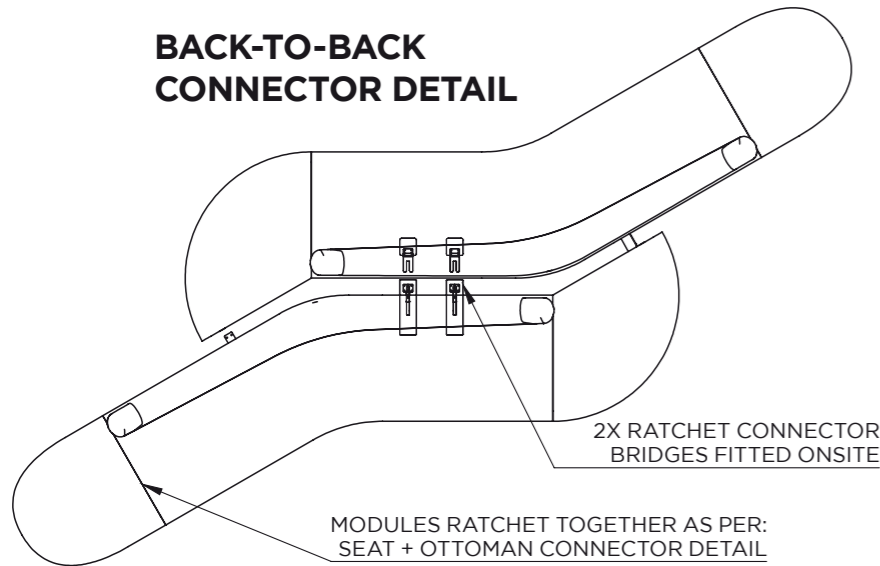

### SEAT + OTTOMAN CONNECTOR DETAIL

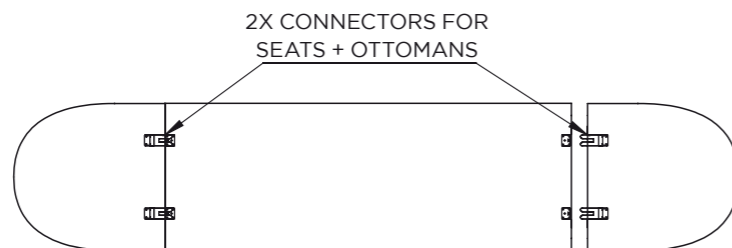



**botton + gardiner**

PUBLIC SPACE FURNITURE

1300 762 701

[bottongardiner.com.au](http://bottongardiner.com.au)

