

**zintra**  
zintraacoustic.com

# SMALL BLANCHARD CLOUD

## INSTALL GUIDE

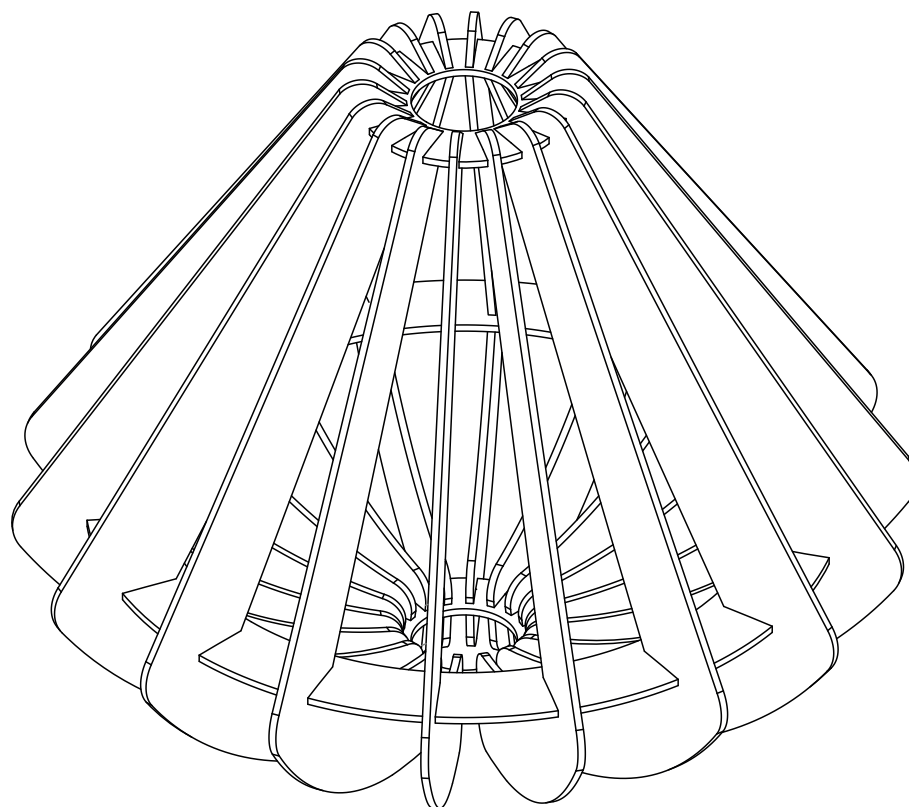

# SMALL BLANCHARD CLOUD ASSEMBLY

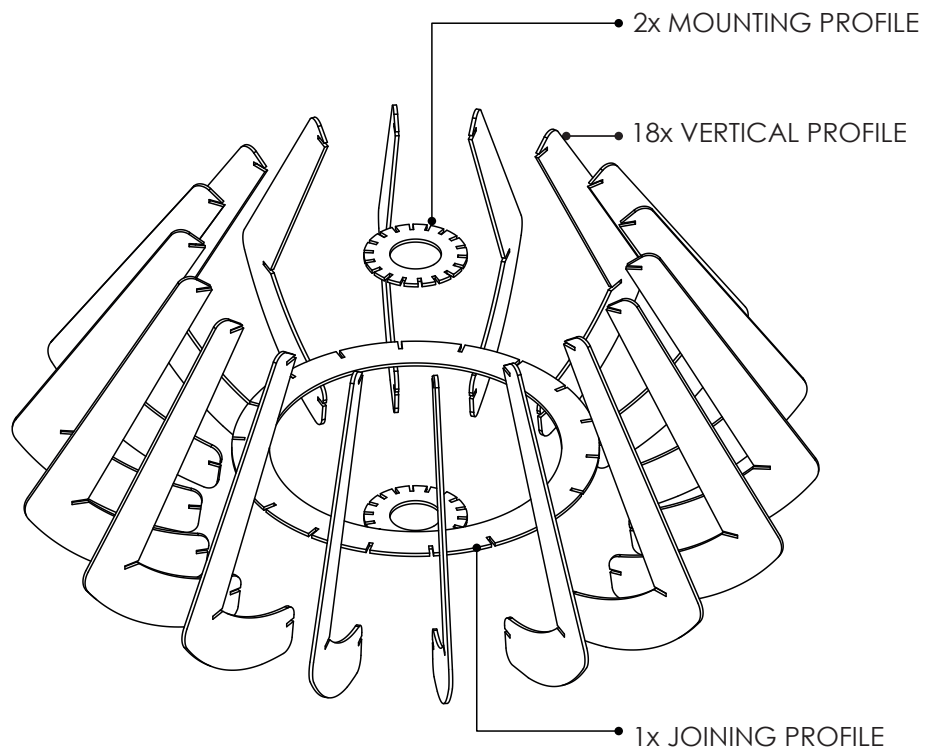

1) Assemble cloud profiles as shown.

**STEP 1**

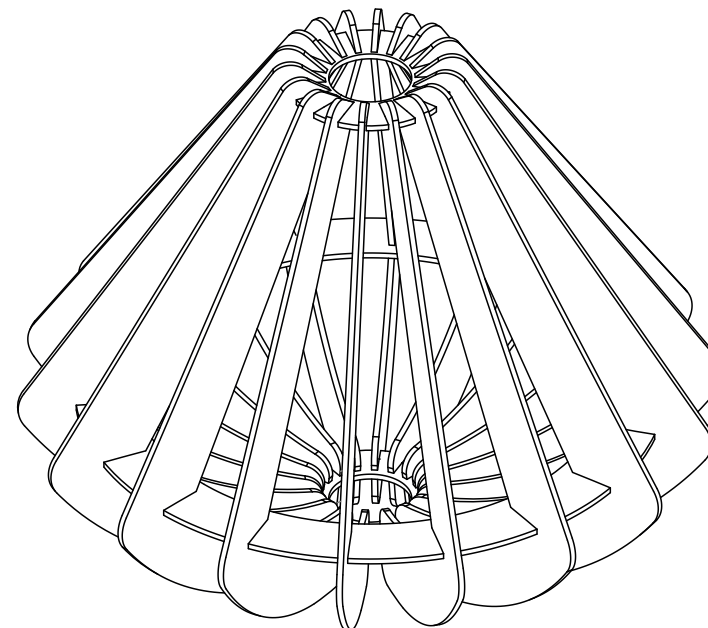

**STEP 2**

**BLANCHARD CLOUD**  
INSTALL GUIDE

# SMALL BLANCHARD CLOUD SUSPENSION METHOD

3) Place cloud assembly up to ceiling in desired location. Mark position of through holes which correspond to the centre of each "set" of mounting slits on the mounting profile. Test that hole position is correct by temporarily suspending cloud on wires as shown in STEP 7 & 8.

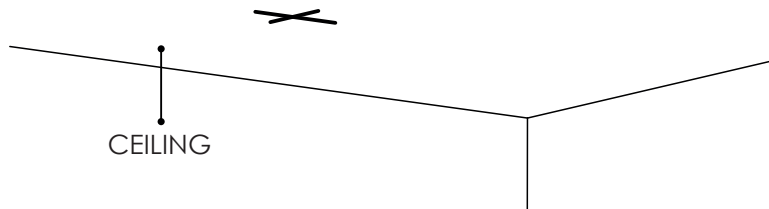

3) Install the 1/4"-20 hanger bolts to the substrate. The supplied hanger bolts are intended for use in wood only. For other substrates the installer will need to source the vappropriate hardware.

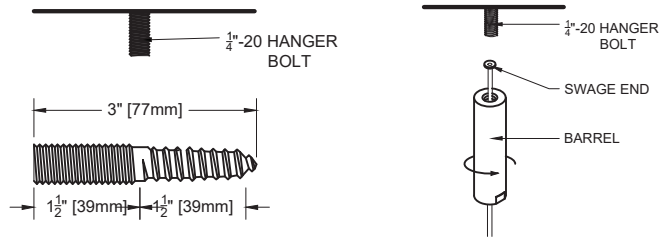

**STEP 3 & 4**

5) Feed swaged wire through tip of 'wire adjuster' (as shown). Push button (shown in grey) to adjust wire length. Release the button to lock in place.

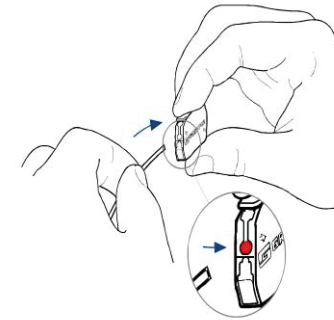

6) Insert the plain end of the cable through one side of the adjustable fastener. Loop the wire through the hole in the mounting profile and around the edge of the mounting profile at the predetermined locations. Re-insert the plain end of the cable through the remaining side of the adjustable fastener.

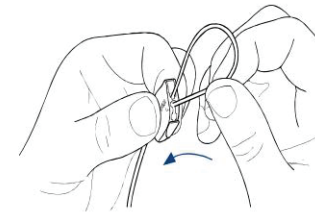

**STEP 5 & 6**

## BLANCHARD CLOUD INSTALL GUIDE

## SMALL BLANCHARD CLOUD SUSPENSION METHOD

7) Re-adjust wire length as explained in STEP 5 until cloud hangs level.  
Note, there are 2 orientation options as shown below.

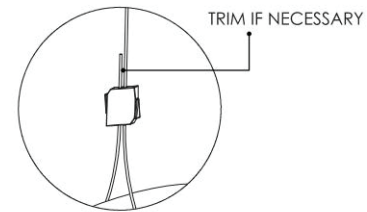
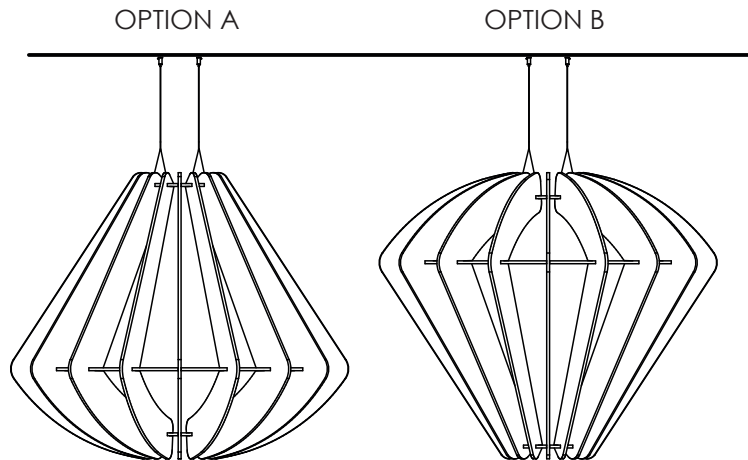

### STEP 7

\*Please note, above linework is representative only.  
Your cloud may not be depicted.

# SMALL BLANCHARD CLOUD PARTS

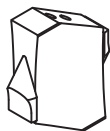

ADJUSTABLE FASTENER

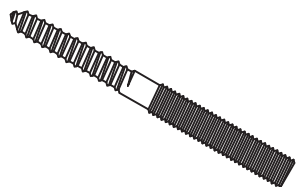

HANGER BOLT

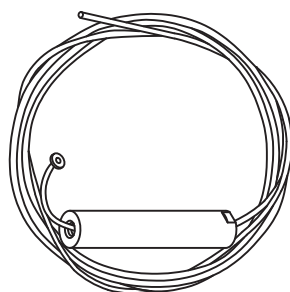

CABLE WITH  
BARREL FIXING

**BLANCHARD CLOUD**  
INSTALL GUIDE

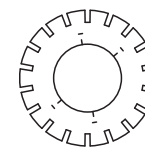

**MOUNTING PROFILE**  
2 OFF

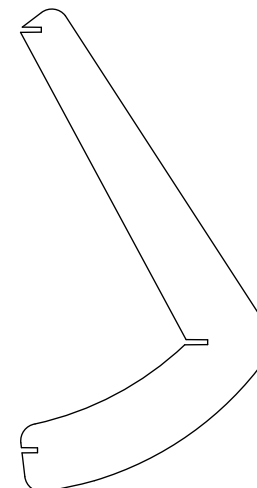

**VERTICAL PROFILE**  
18 OFF

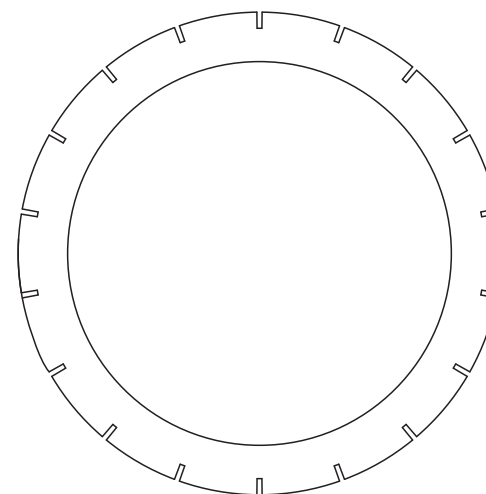

**JOINING PROFILE**  
1 OFF