

**zintra**  
zintraacoustic.com

# CLOUDS DRANTE INSTALL GUIDE

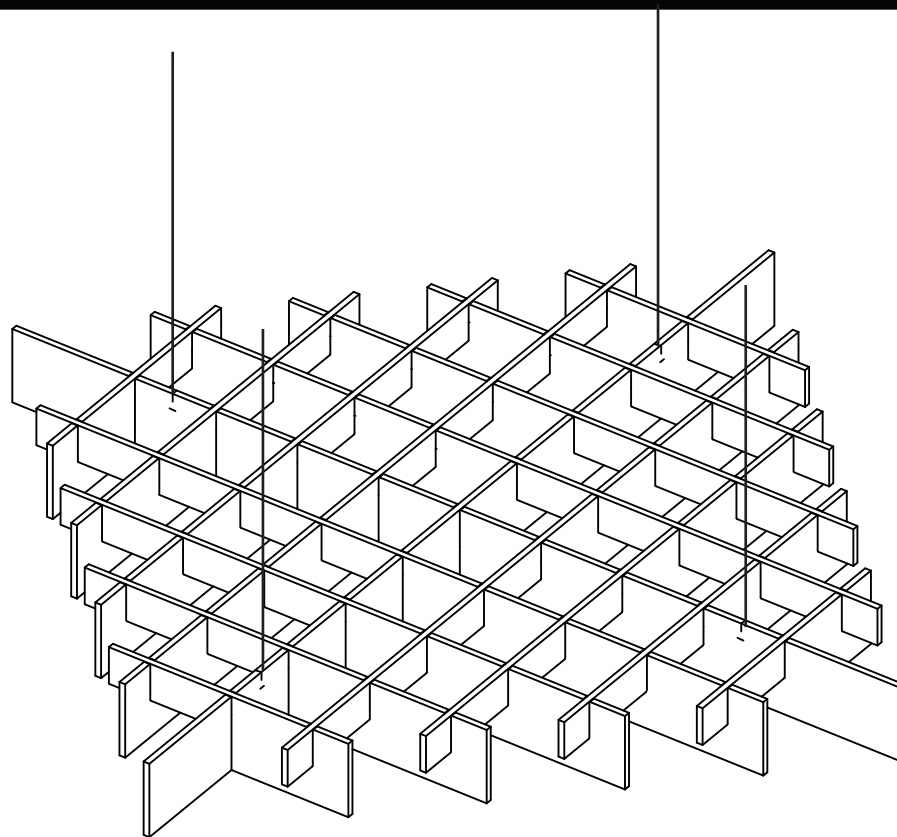

# DRANTE CLOUD ASSEMBLY

## PARTIAL ASSEMBLY X

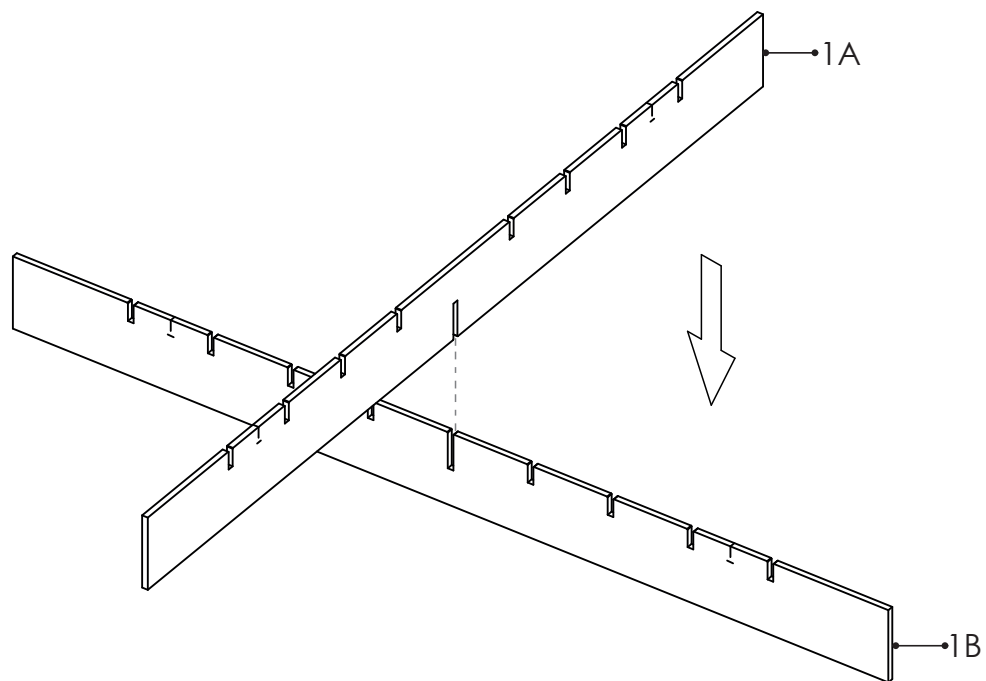

1) Assemble cloud profiles 1A & 1B as shown.  
Note position of mounting slits.

### STEP 1

## PARTIAL ASSEMBLY X

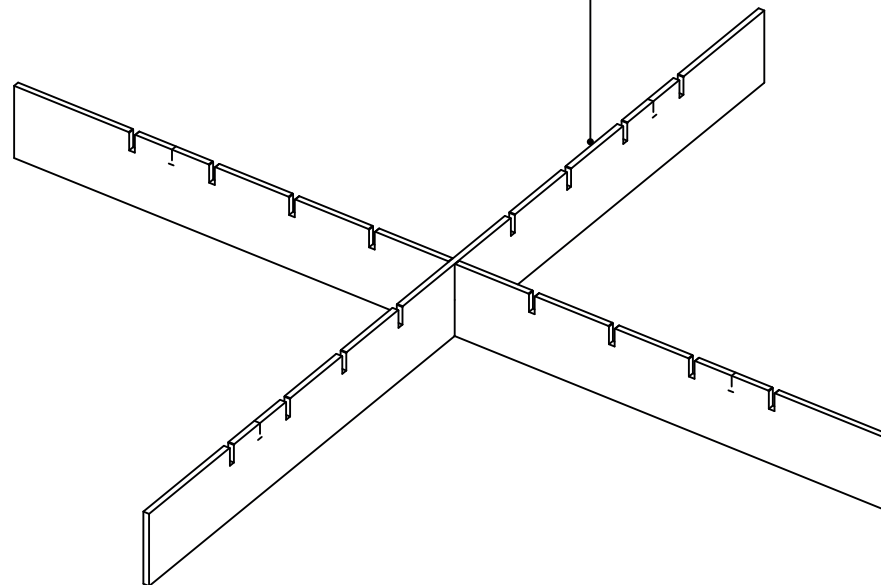

2) "Partial Assembly X" is complete. Put this aside for later.

### STEP 2

# DRANTE CLOUD ASSEMBLY

## PARTIAL ASSEMBLY Y

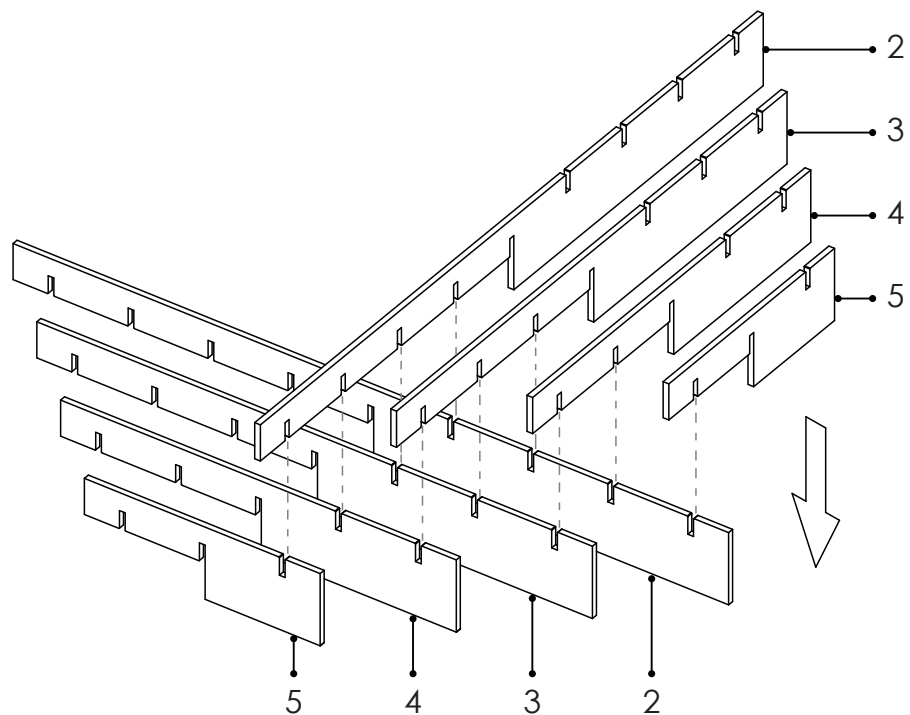

3) Assemble cloud profiles 5,4,3 & 2 as shown.

### STEP 3

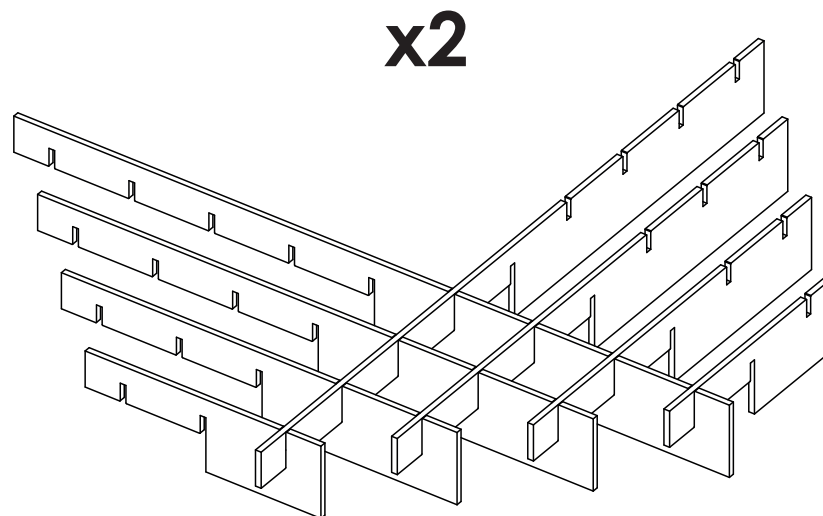

4) Create 2 of the above assemblies.

### STEP 4

# DRANTE CLOUD ASSEMBLY

## PARTIAL ASSEMBLY Y

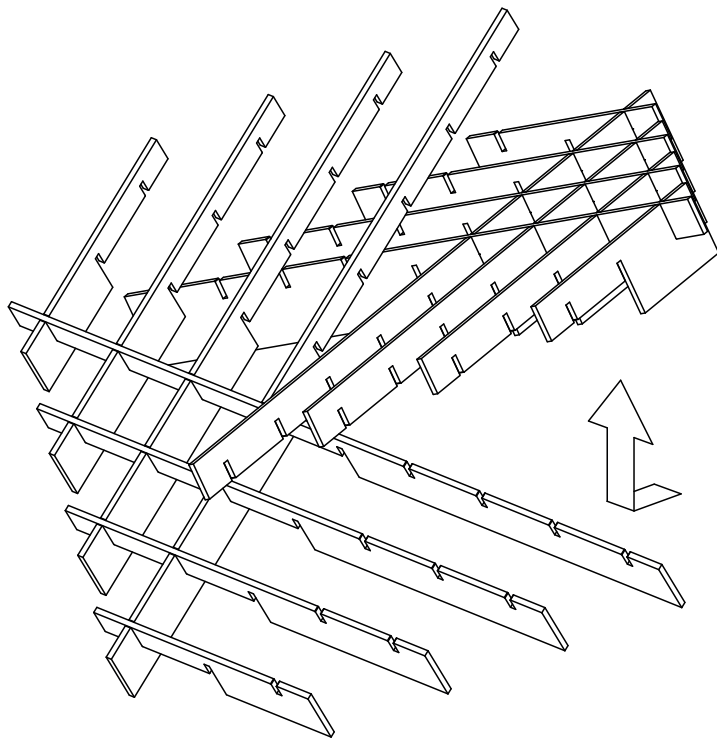

5) Interlock the two assemblies created in the previous step.

### STEP 5

## PARTIAL ASSEMBLY Y

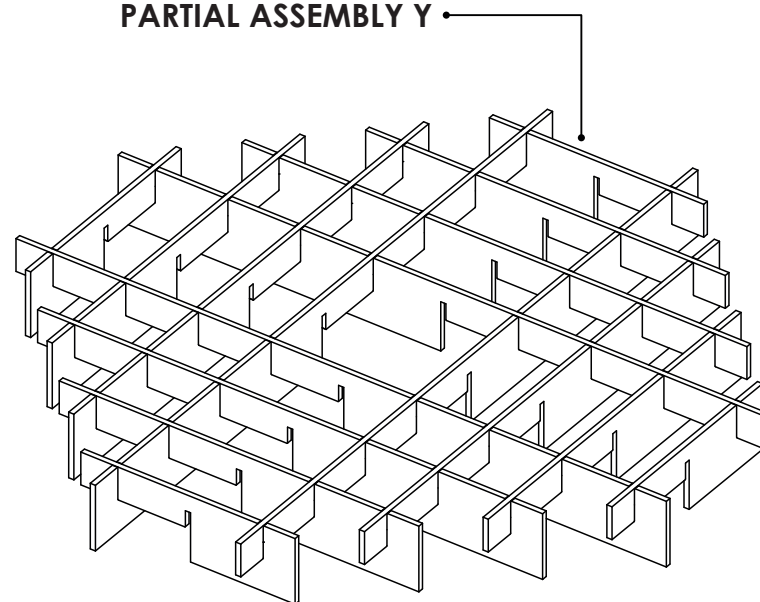

6) "Partial Assembly Y" is complete.

### STEP 6

# DRANTE CLOUD ASSEMBLY

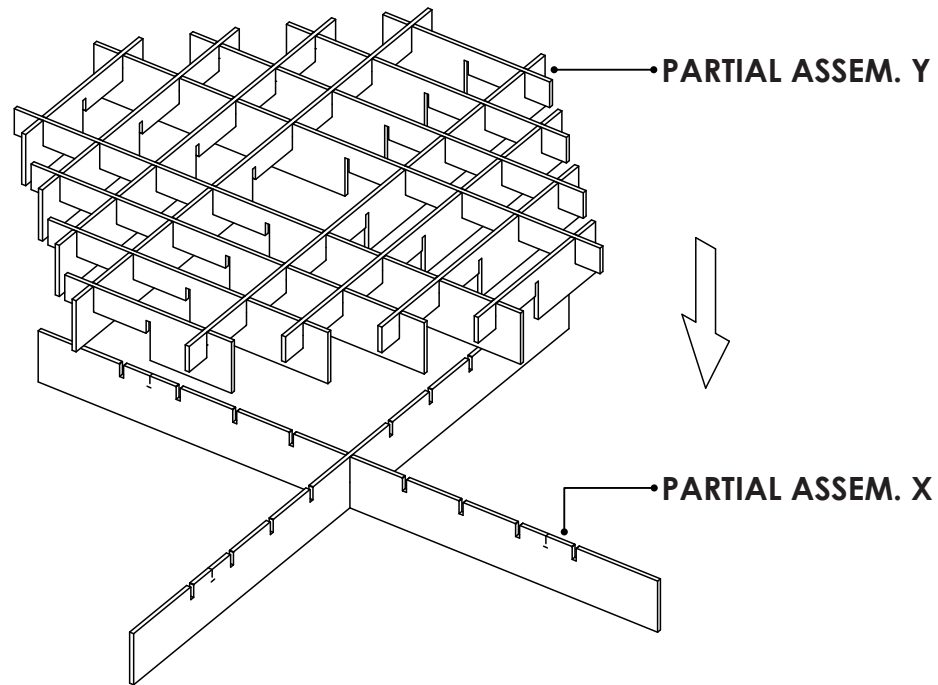

7) Join "Partial Assembly X" with "Partial Assembly Y" as shown.

**STEP 7**

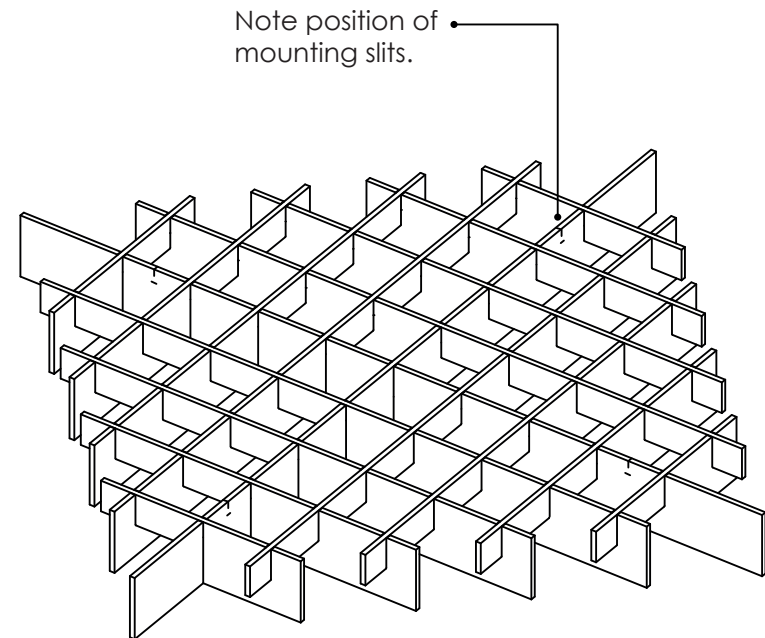

8) Assembled "Drante Cloud".

**STEP 8**

# DRANTE CLOUD SUSPENSION METHOD

9) Place cloud assembly up to ceiling in desired location. Mark position of through holes which correspond to the centre of each "set" of mounting slits on the mounting profile. Test that hole position is correct by temporarily suspending cloud on wires as shown in STEP 7 & 8.

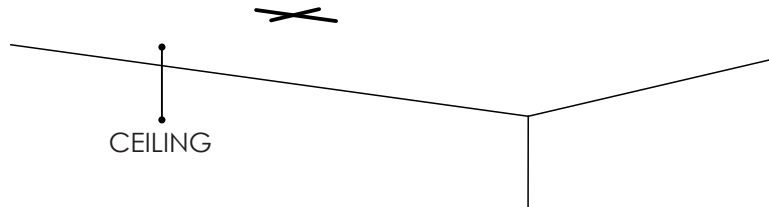

10) Install the 1/4"-20 hanger bolts to the substrate. The supplied hanger bolts are intended for use in wood only. For other substrates the installer will need to source the appropriate hardware.

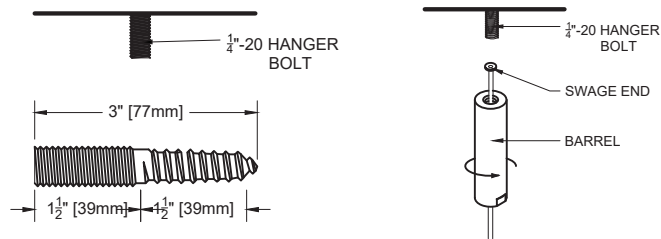

**STEP 9 & 10**

11) Feed swaged wire through tip of 'wire adjuster' (as shown). Push button (shown in grey) to adjust wire length. Release the button to lock in place.

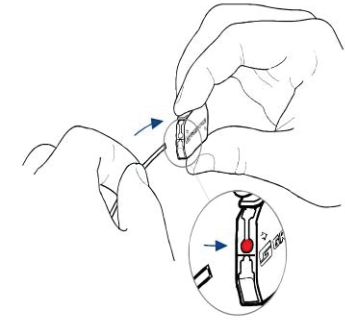

12) Insert the plain end of the cable through one side of the adjustable fastener. Loop the wire through the hole in the mounting profile and around the edge of the mounting profile at the predetermined locations. Re-insert the plain end of the cable through the remaining side of the adjustable fastener.

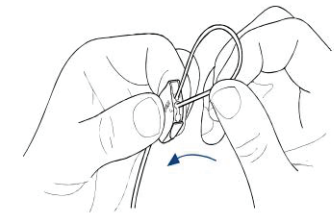

**STEP 11 & 12**

## DRANTE CLOUD SUSPENSION METHOD

7) Re-adjust wire length as explained in STEP 5 until cloud hangs level.  
Note, there are 2 orientation options as shown below.

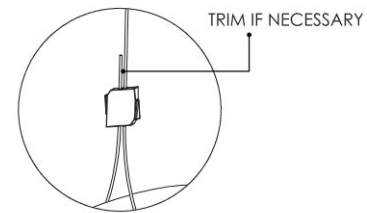
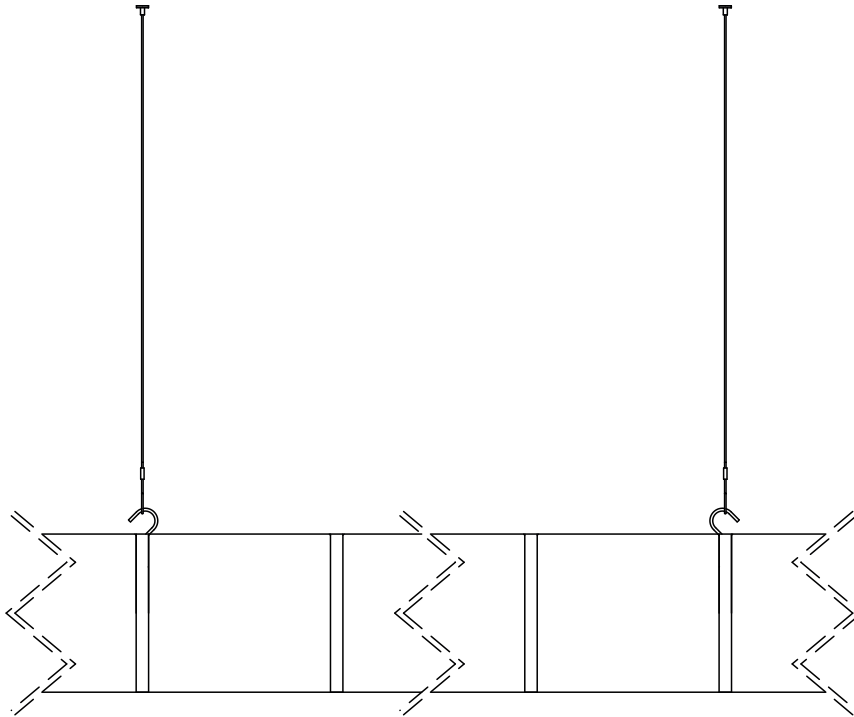

\*Please note, above linework is representative only.  
Your cloud may not be depicted.

# DRANTE CLOUD PARTS

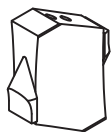

**ADJUSTABLE FASTENER**

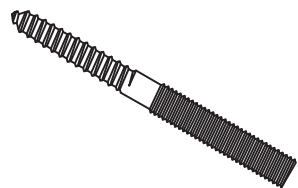

**HANGER BOLT**

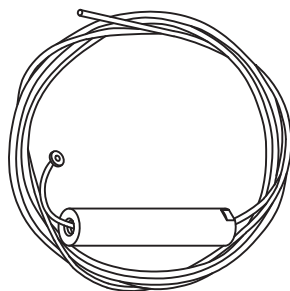

**CABLE WITH  
BARREL FIXING**

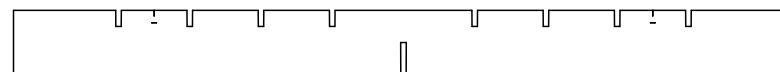

**PROFILE 1A  
1 OFF**

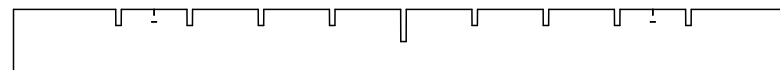

**PROFILE 1B  
1 OFF**



**PROFILE 2  
4 OFF**



**PROFILE 3  
4 OFF**



**PROFILE 4  
4 OFF**

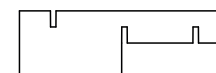

**PROFILE 5  
4 OFF**